

# **Tutorials for Origin**

---

Copyright © 2019 by OriginLab Corporation

All rights reserved. No part of the contents of this book may be reproduced or transmitted in any form or by any means without the written permission of OriginLab Corporation.

OriginLab, Origin, and LabTalk are either registered trademarks or trademarks of OriginLab Corporation. Other product and company names mentioned herein may be the trademarks of their respective owners.

OriginLab Corporation  
One Roundhouse Plaza  
Northampton, MA 01060  
USA  
(413) 586-2013  
(800) 969-7720  
Fax (413) 585-0126



# Table of Contents

Tutorials for Origin .....	1
Table of Contents .....	iii
1 Getting Started.....	1
1.1 Getting Started.....	1
1.2 My First Graph.....	1
1.3 Graph Templates and Batch Plotting.....	4
1.4 Data Selection .....	7
1.5 Merge and Arrange Graphs .....	11
1.6 Publishing Graphs .....	15
1.7 3D and Contour .....	18
1.8 Gadgets.....	20
1.9 Curve Fitting .....	22
1.10 Peak Analysis .....	25
1.11 Statistics.....	28
1.12 Analysis Template .....	31
1.13 Apps in Origin.....	33
2 Video Tutorials .....	37
3 User Interface .....	39
3.1 User Interface .....	39
3.2 Origin GUI .....	39
4 Data Analysis .....	55
4.1 Data Analysis .....	55
4.2 Gadgets.....	58
4.3 Curve Fitting .....	137
4.4 Signal Processing.....	348
4.5 Peak Analysis .....	438
4.6 Data Manipulation.....	489
4.7 Analysis Templates .....	550
4.8 Analysis Themes.....	562
4.9 Batch Processing .....	566
5 Statistics .....	585
5.1 Statistics .....	585
5.2 Descriptive Statistics.....	586
5.3 Hypothesis Tests .....	620
5.4 ANOVA .....	631

5.5	Nonparametric Tests .....	666
5.6	Survival Analysis .....	677
5.7	Multivariate Analysis .....	693
5.8	Power and Sample Size .....	729
5.9	ROC curve .....	734
6	Graphing .....	739
6.1	Graphing .....	739
6.2	Plotting .....	743
6.3	Axis .....	844
6.4	Compare Graphs Dynamically by Changing Data Filters .....	871
6.5	Layers .....	886
6.6	Graph Template and Theme .....	920
6.7	Line and Symbol .....	921
6.8	Column, Bar and Pie.....	1024
6.9	Multi-Axis and Multi-Panel.....	1106
6.10	Contour .....	1175
6.11	Statistics.....	1254
6.12	Polar .....	1473
6.13	3D Graphs .....	1565
6.14	Plot Functions with Parameters Defined in a Worksheet .....	1761
6.15	Windrose Graph.....	1767
6.16	2D Vector Graph.....	1778
6.17	Piper Diagram .....	1780
6.18	Waterfall.....	1785
6.19	Open-High-Low-Close-Volume Stock Chart.....	1800
7	Data Management .....	1809
7.1	Data Management .....	1809
7.2	Working with Multi-Sheet Workbooks .....	1809
7.3	Adding Objects to Worksheet .....	1815
8	Data Exploration.....	1823
8.1	Data Exploration.....	1823
8.2	Data Reader Tool.....	1823
8.3	Use Data Cursor to Show the Difference between the Data .....	1831
9	Importing Data.....	1837
9.1	Importing Data.....	1837
9.2	ASCII .....	1837
9.3	Database.....	1863

9.4	Digitizer.....	1932
10	Exporting and Presentation .....	1959
10.1	Exporting and Presentation .....	1959
10.2	Exporting .....	1959
10.3	Presentation .....	1965
11	Collaboration and Connectivity .....	1975
11.1	Collaboration and Connectivity.....	1975
11.2	Connectivity .....	1975
12	Programming .....	1993
12.1	Programming .....	1993
12.2	LabTalk .....	1994
12.3	Origin C.....	1998
12.4	X-Functions.....	2043
	Index.....	2095



# 1 Getting Started

## 1.1 Getting Started

If you are new to Origin, or have used a much older version in the past, it is highly recommended that you start with these tutorials. Once you have familiarized yourself with the interface and key concepts of graphing and analysis introduced in these lessons, you can then move on to other chapters that cover Origin features in more detail.

At the end of each lesson, we ask you to save the project. Please work through the tutorials sequentially as some build on previous lessons.

- [My First Graph](#)
- [Graph Templates and Batch Plotting](#)
- [Data Selection](#)
- [Merge and Arrange Graphs](#)
- [Publishing Graphs](#)
- [3D and Contour](#)
- [Gadgets](#)
- [Curve Fitting](#)
- [Peak Analysis](#)
- [Statistics](#)
- [Analysis Template](#)
- [Apps in Origin](#)

## 1.2 My First Graph

In this first lesson, we will generate some data, create a graph, do some simple customization of the graph, and save the data and graph as an Origin project.

### 1.2.1.1 [Generate data and graph](#)

1. Launch Origin. You will see an empty workbook with one worksheet containing two columns.
2. Right-click on column A, expand the context menu if needed, and select **Fill Column with: A set of Numbers....**



You can turn off collapsible menus by unchecking the **Enable Collapsible Menus** check box on the **Miscellaneous** tab of the **Preference: Options** dialog.

3. In the dialog, set **From** as -10, keep **To** as 10, set **Increment** as 0.1. Click **OK** to close the dialog. Column A will be filled with numbers in the specified range.
4. We will now set column B as a function of column A. Double-click in **F(x)** label row of column B. This will place you in edit mode for that cell. Type the formula:

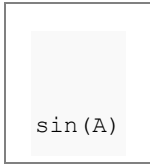

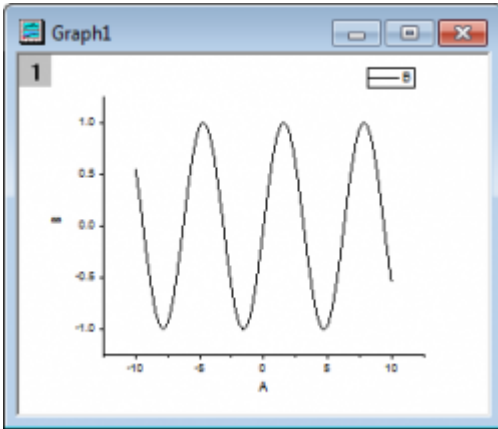

	A(X)	B(Y)
Long Name		
Units		
Comments		
F(x)=		sin(col(1))

- Now let us create a graph. Click on the header of column B to select the entire column. Then click the **Line** button  in the **2D Graphs** toolbar docked at the bottom left of the interface. A graph window will open, with the data plotted as a line.



### 1.2.1.2 Customize the graph

- We will now do some simple customization of the graph. Right-click on the X axis, and from the context menu, select **Hide Grids**. This will add grid lines for the X axis. Do the same for Y axis.
- Click on the line plot to select it. Then from the **Style** toolbar docked at top middle of the interface, change the color to **Blue** by using the **Line/Border Color**  button.
- Change the width to **3** by using the the **Line/Border Width** drop-down list .
- Single-click inside the layer, but not on the grid lines or plot. You may need to click once to deselect your plot and then again to select the layer. The graph layer will be selected, and this will be indicated by selection handles. Change the layer background color to **LT Yellow** by using the **Fill Color** button  in the **Style** toolbar.
- In column A, double-click the cell for **Long Name** and type **my x**.
- For column B, type **my y** into **Long Name**, **mV** into **Units**, and **Sine Wave** into **Comments**.
- Click and select the graph window. The X and Y axis title and legend on graph will be updated accordingly. Your graph should look like below:

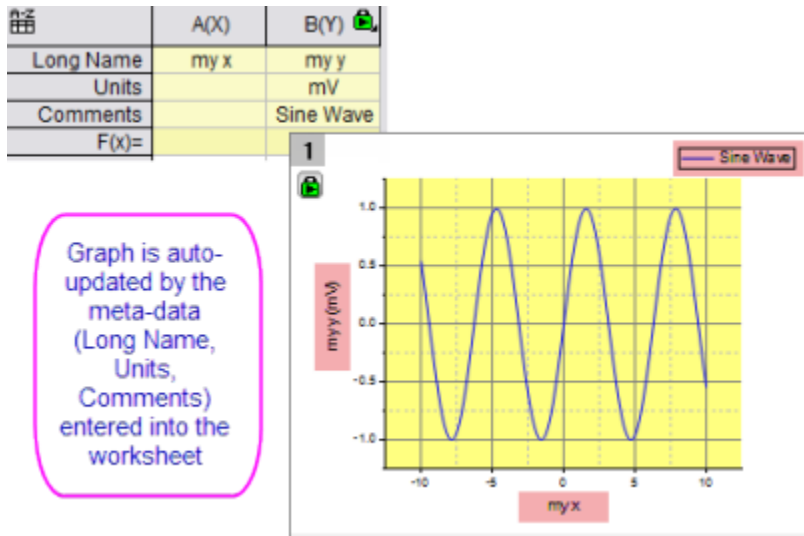

### 1.2.1.3 Explore data graphically

- Let us now explore the data graphically. Make sure the graph window is active by clicking on the title bar.
  - Hold the **Z** key down and use the mouse wheel to zoom in and out on the X axis.
  - Hold the **X** key down, and use mouse wheel to pan across the x axis.





Hold the **Shift** key down along with Z/X keys to zoom/pan in Y direction.

- Bring the plot back to full scale by clicking the **Rescale** button  in the **Graph** toolbar docked to the right side of the interface.

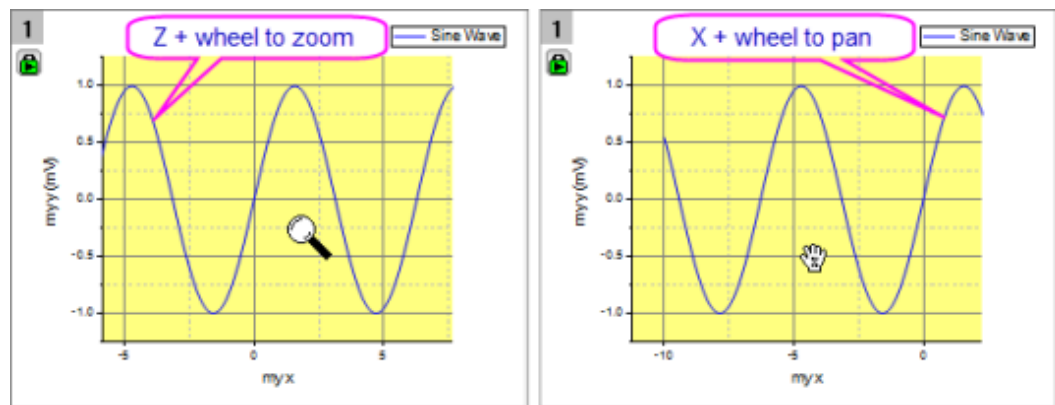

Use shortcut **CTRL+R** to rescale plots in the graph layer.



- Click the **Data Reader**  button from the **Tools** toolbar docked to the left side of the interface.
- Place the cursor on the curve. You can now use arrow keys to move the cursor along the data plot and read coordinate values. Or, you can click anywhere on the curve to read the coordinate values at that

location.

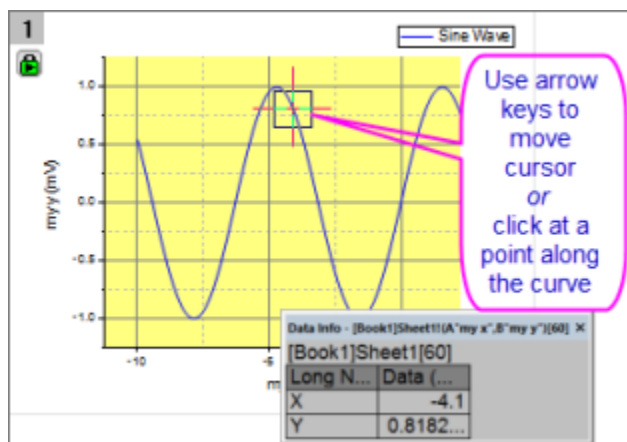

#### 1.2.1.4 Save the Project

We will now save this Origin project for later use.

1. Move mouse over to the Project Explorer bar on the left side of the work space to expand it.
2. Right click on the **Folder1** in the upper **folders panel** and choose **Rename** from the context menu. Type **My First Graph** to rename the folder.
3. Choose menu **File: Save Project** to save the project. Give the project a name such as **Getting Started Tutorials**.

 Files created by the user such as projects, graph templates, fitting functions etc are by default saved in the **User Files Folder (UFF)**. You can access the **UFF** and other useful folder locations with the main menu **Help: Open Folder**.

## 1.3 Graph Templates and Batch Plotting

In this lesson we will learn about graph templates, and also how to perform batch plotting.

### 1.3.1 Graph Templates

Let's start with the project file we saved in [lesson one: My First Graph](#). Click to select the graph window.

 You can quickly open recently-saved project files from the **File: Recent Projects** list.

1. Double-click on the axis tick label to open the **Axis Dialog**.



- Press the **Ctrl** key and select the **Top** and **Right** icons in the left list box. Choose the **Line and Ticks** tab and select the **Show Line and Ticks** check box then press **OK**.

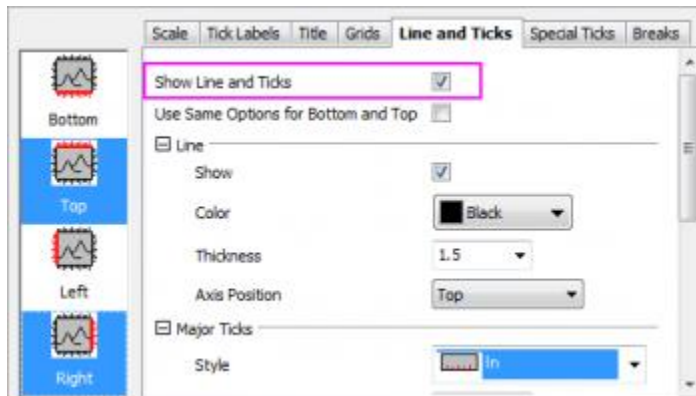

- Now let's save the graph as a template. Right-click on the graph title bar, and choose **Save Template As...** from the context menu.
- In the dialog, set the **Template Name** as **My Line** and click **OK** to save the template.
- We will now generate a new column of data. Activate the worksheet, right-click on the gray area to the right of the columns, and select **Add New Column** from the context menu.
- Click inside the **F(x)** cell of this column, then right-click and select **Open Dialog...** from the context menu. You can use the shortcut **Ctrl+Q** instead of the context menu.
- In the dialog, enter the following expression into the top panel:

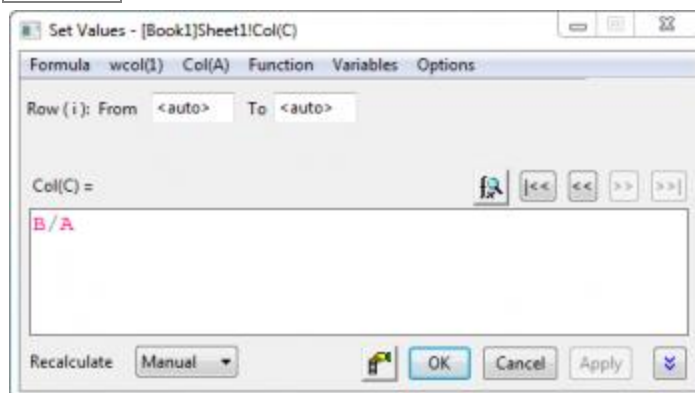
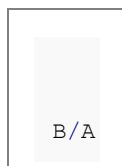

 Use the **Formula: Load Samples** menu in this dialog to view various examples on setting column values. The **Function** menu offers a large selection of functions. You can also search for suitable functions using the search button located in the top right side of the formula edit box.

- Click **OK** to close the dialog and see the values in column C. Type **sin(x)/x** into the **Comments** cell of the column.

- Click on the header of column C to select the entire column. From the menu, choose **Plot: Templates > User** and from the drop-down menu select the **My Line** template we created before. A new graph will be created using data from column C.

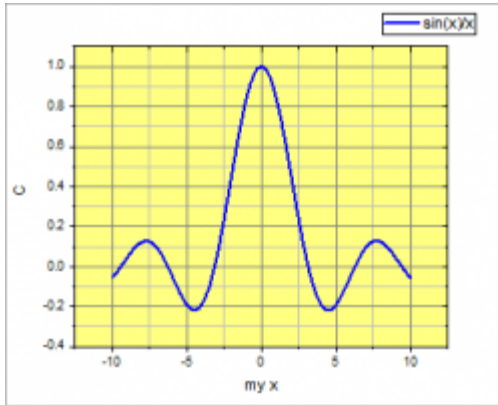

### 1.3.2 Batch Plotting

In this section, we will perform batch plotting by first creating one graph and then cloning that graph using other data.

- Go to **Project Explorer**. In the upper panel, right-click on the root level and choose **New Folder**.
- Right-click on newly created folder, select **Rename**, and assign the name **Batch Plotting**. Click on the empty folder to open it.
- Using **Windows Explorer** outside of Origin, navigate to the folder *<Origin EXE Path>\Samples\Import and Export\*. Press the **Shift** key and choose the following three files:

- S15-125-03.dat
- S21-235-07.dat
- S32-014-04.dat

- Drag and drop the selected files onto the Origin workspace. The selected files are imported into three new workbooks.

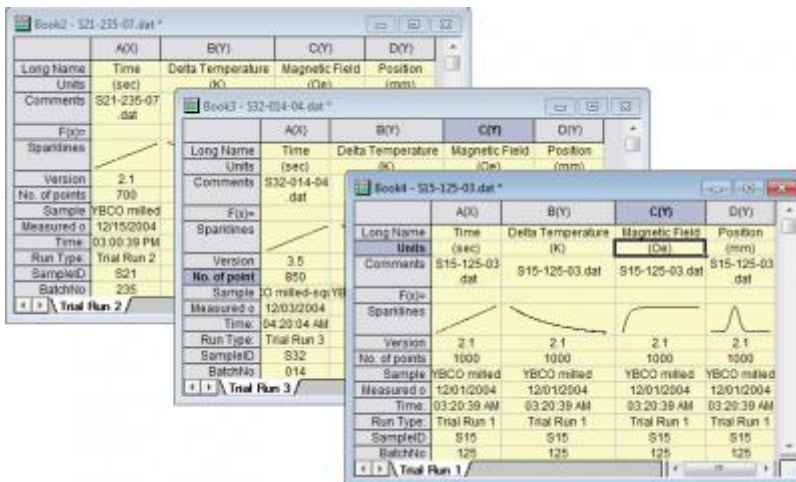

**Note:** To import data files by drag-and-drop, [you must not be running Origin as an administrator](#).

- Select one of the workbooks, then click on the header of column B and drag the mouse to column D, selecting all three columns. Then select the menu: **Plot > 2D: Multi-Y: 3Ys Y-YY**.



Origin will look to the left of the selection to find the X column and plot the selected data against the the 1st column in the worksheet.

- Double-click inside the layer to open the **Plot Details** dialog. In the left panel, we can see there are three layers. Expand **Layer1** and choose the plot under it. Then in the right panel, change the line width by choosing the **Line** tab and setting **Line Width** as **3**. Repeat the line width setting for the plots in the other two layers by selecting them from the left panel. Click **OK** to close the dialog and apply the settings.
- Now we will clone this graph using data in the other workbooks. Right-click on the title bar of the graph and select **Duplicate(Batch Plotting)**, and then the **Select Workbook** dialog will be opened.
- In the dialog, press the **Shift** key and select the two workbooks in the top box.



You can set the **Match Plot Columns by** drop-down appropriately to find worksheets in the project that match the data configuration of the current graph.

- Click **OK**. If prompted to rescale the axes to show all data, answer Yes and click OK. Two similar graphs will be created with data from the other two books.

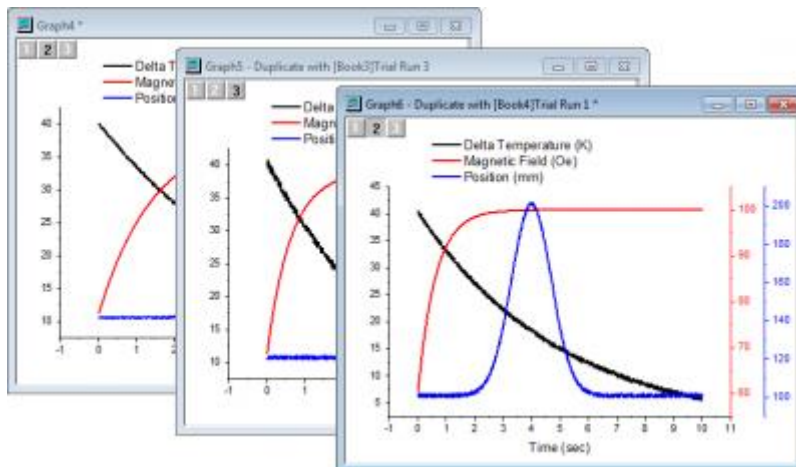



- From the menu, choose **File: Save Project** and save your modified project.

## 1.4 Data Selection

In this lesson we will learn about flexible ways of selecting data for plotting.

### 1.4.1.1 Plotting Data from Multiple Worksheets

- Let's start with the project we saved in [lesson two: Graph Templates and Batch Plotting](#). Select any workbook, and make sure no data columns are selected. You can click in the gray area outside of columns to remove selection.
- Select menu **Plot > 2D: Line: Line**. The **Plot Setup** dialog will open.
- Click the  button on the right side to expand the upper panel if it is not already open.
- Set the **Available Data:** drop-down list in the left panel to **Worksheets in Folder**.

 To pick up worksheets from anywhere in your project, set the drop down to **Worksheets in Project**.

- Hold down shift key and select all three data sheets named **Trial Run 1**, **Trial Run 2** and **Trial Run 3**.
- Using the check boxes in the middle panel, assign *Time* as **X** and *Position* as **Y**. Click **OK** button to create the graph.

 This dialog has a third bottom panel which can be used to assign data to different layers in a multi-layer graph. If that panel is open, you can simply collapse it and then click **OK** to create the graph.

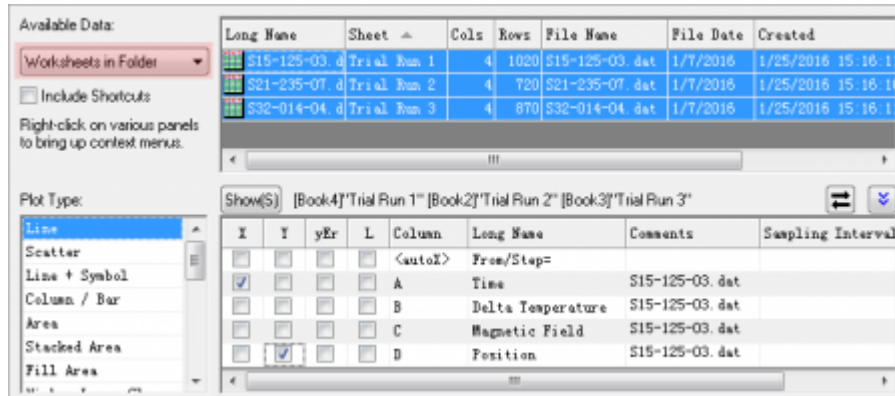

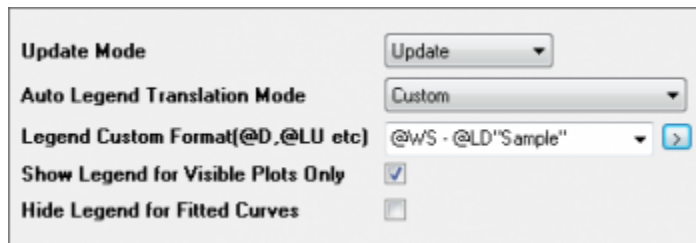

7. We will now customize the legend for this graph. Right click on the legend and select **Legend: Update Legend...**
9. In the dialog that opens, set **Auto Legend Transition Mode** as **Custom**. Then click the  button on the right of **Legend Custom Format (@D, @LU etc)** edit box, and in the fly-out menu select **@WS: Sheet Display Name**.
10. In the edit box, type a hyphen - after the string @WS, and again click the right arrow button. This time select **@LD"Sample": Sample**, which corresponds to column header row *Sample* in the worksheet. Click the **OK** button. The legend will now display the sheet name and the sample name.



- 11.

1.4.1.2 Using another Column to Set Color of a Plot

1. Go to **Project Explorer**. In the upper panel, right-click on the root level and choose **New Folder**.
2. Right-click on newly created folder, select **Rename**, and assign the name **Data Selection**. Click on the empty folder and open it.
3. Click **Import Single ASCII** button  and browse to <Origin EXE Path>\Samples\Graphing folder and select the file *US Mean Temperature.dat* and import it.
4. We want to plot the positions of US major cities (columns *Longitude* and *Latitude*) as a scatter plot and then colormap the data points with the annual mean temperature (column *Annual*). Click on the header of column named **January** and drag and expand the selection all the way to the column named **December**. Then right click to choose **Hide/Unhide Columns: Hide**.
5. Select the *Longitude* columns, then right-click and select **Set As: X**.
6. Select the *Latitude* and click **Scatter** button  on the bottom left toolbar to create the plot of longitude vs. latitude.
7. Double-click on any of the data points to bring up **Plot Details - Plot Properties** dialog.
8. With the data plot node [*US Mean Temperature.dat*]... under *Layer1* selected in the left panel, activate the **Symbol** tab on the right panel. Click the **Symbol Color** drop-down and in the fly-out, switch to the **By Points** tab.
9. Click the **Color Mapping** drop-down and select **Color Mapping: Col(P): "Annual"**. Click **Apply** to see the effect, still keeping the dialog open.

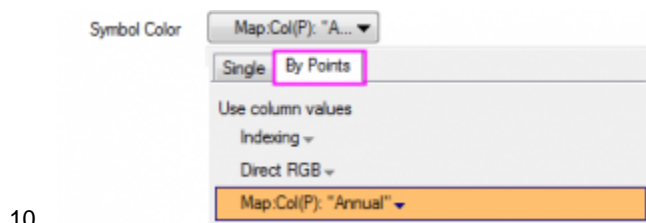

11. Let us now set the axes lengths to scale with the range of X and Y values represented in the graph. Click to select *Layer1* node on the left panel. Then go to the **Size/Speed** tab on the right side. Check the **Link Axis Length to Scale with X:Y Ratio** box and keep the ratio as *1*. Click **OK** to exit the dialog and see the effect.
12. The colormap by default is set to *Rainbow*. Click on any data point in the graph, and then click on the **Palette** toolbar button  in the **Style** toolbar. Select the *Temperature* palette to better reflect the data. Click anywhere on the graph to deselect the plot.
- 13.



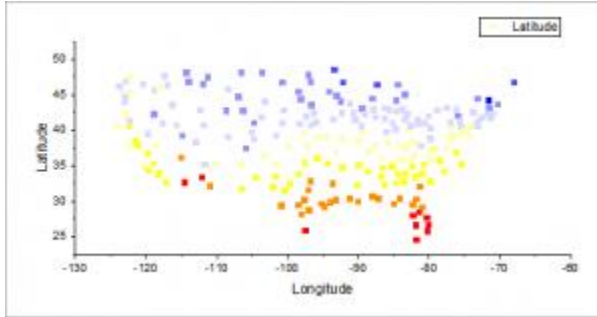

You can add a map to a graph using the [Maps Online](#) App. [This blog post](#) is a good place to start.



14.

15. From the menu, choose **File: Save Project** and save your modified project.

#### 1.4.1.3 Selecting Multiple Non-adjacent Columns for Plotting

1. Open a new workbook window by clicking on the **New Workbook** button  in the **Standard** toolbar.
2. Click the **Import Excel** button  on **Standard** toolbar. In the file dialog that opens, browse to <Origin EXE Path>\Samples\Import and Export folder and select the file *United States Energy (1980-2013).xls*. Make sure that the **Show Options Dialog** check box is checked, and press **OK**.
3. In the import options dialog that opens, expand the **Import Options > Header Lines** node. Set the **Number of Subheader Lines** to <auto>, set the **Long Names** drop-down to 3 and the **Units** drop-down to 4. Then set the drop-downs for **Comments From** to 1 and **Comments To** to 2.
4. Check **Apply Header to All Sheets** so that these settings are used for every sheet in the Excel file.

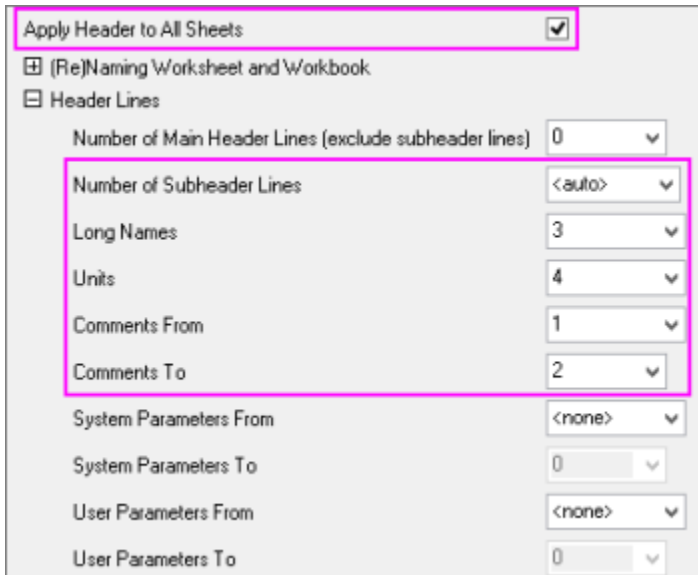

- Press **OK** to import the file. Then go to the first sheet named *Oil*. Hold the **Ctrl** key to select *Crude Oil Production, Oil Consumption* and *Total Oil Production* columns.

	A(X)	B(Y)	C(Y)	D(Y)	E(Y)	F(Y)	G(Y)
Long Name	Year	Crude Oil Prod 1K Barrels/Day	Estimated Petr 1K Barrels/Day	Oil Consumpt 1K Barrels/Day	Refinery Capac 1K Barrels/Day	Total Oil Produ 1K Barrels/Day	Proved Reserv 1B Barrels
Units							
Comments	Source: U.S. Energy Information Administration						
F(x)=							
1	2013	7441.4904	-6618.3613	18961.1285		12342.7671	30.529
2	2012	6496.6967	-7371.5197	18490.2136	17736.37	11118.6939	26.544
3	2011	5644.7918	-8753.6067	18882.0725	17736.37	10128.4657	23.267
4	2010	5481.8712	-9484.537	19180.126	17583.79	9695.589	20.682
5	2009	5349.8329	-9641.315	18771.4	17671.55	9130.0849	19.121
6	2008	5000.0628	-10934.0379	19497.9641	17593.847	8563.9262	21.317
7	2007	5076.9808	-12210.9752	20680.378	17443.492	8469.4027	20.972
8	2006	5087.8685	-12371.0947	20687.418	17338.814	8316.3233	21.757
9	2005	5181.5178	-12477.219	20802.1615	17124.87	8324.9425	21.371



- Then go to menu **Plot > 2D: Multi-Panel: Stack...** and accept default settings in the dialog, to create a stacked plot.

Save your project file.

## 1.5 Merge and Arrange Graphs

In this lesson we will create some graphs, merge them, and then arrange layers in the merged graph. We will also save the graph as a cloneable template to quickly re-create the graph from similar data.

### 1.5.1.1 Import data and create graphs

- Open the project file we saved in [lesson three:Data Selection](#). In **Project Explorer**, create a new folder under the root folder and rename it as **Merging Graphs**. Click on the empty folder to open it.
- Click the **New Workbook**  button on the Standard toolbar.
- With the blank workbook active, click the **Import Single ASCII** button  on the **Standard** toolbar. In the file dialog, navigate to the folder `<Origin EXE Path>\Samples\Statistics` and select *automobile.dat*. Click **Open** to import the file.



You can uncheck the **Show Options Dialog** check box in the file dialog to prevent the ASCII options dialog from popping up. The default settings will be used next time you import a file into a new book.

- Click on the header of column C to select the entire column. Click the **Scatter** button  on the **2D Graphs** toolbar to create a scatter graph.
- Click on the scatter plot to select it, then right-click on the plot and select **Change X:** **[automobile]automobile!G(Y):EngineDisplacement** from the context menu to change the X data. A reminder message pops up asking if you would like to rescale the graph. Select **Yes** and press **OK**.





Reminder messages have multiple options. If you select **Yes, and do the same in the future, no need to ask again**, the dialog will not show again. You can reactivate all reminder messages from the menu **Help: Reactivate Reminder Messages**.

6.



7. Select the legend and press the **Delete** key to delete it.
8. We will now make copies of this graph and change the data in the copies. First go back to the worksheet, and press the **X** button on the top right of the title bar, and in the dialog that pops up, select **Hide**. This simply hides the window from the interface.



Hidden windows are displayed with a dimmed icon in the lower panel of Project Explorer. You can double-click on the entry to re-open the window.

9. Right-click on the graph window title bar and select **Duplicate** to create a copy. Do this two more times, so you end up with four graph windows.
10. Select the menu **Window: Tile Vertically** to arrange the 4 graphs without overlap.
11. Use the **Change X/Change Y** menu described before, to change X/Y designations for the copy graphs as below, and rescale when promoted:
  - o Copy 1: Change Y to `[automobile]automobile!D(Y):0^60 mph`
  - o Copy 2: Change X to `[automobile]automobile!E(Y):Weight`
  - o Copy 3: Change X to `[automobile]automobile!F(Y):Gas Mileage`
12. Activate the graph of Power vs. Weight. Let's do some customization. Double-click on the data plot to open the **Plot Details** dialog. Change the plot properties as follows:
  - o Change Symbol Shape to circle and **Symbol Color** to olive.
  - o Set **Transparency** to 55%.

Press **OK** to close the dialog.

13. Double-click on the Y axis to open the **Axis** dialog. Change the axis properties as follows:
  - o Activate the **Tick Labels** tab. Press the **Ctrl** key on the keyboard and click **Bottom** and **Left** in the left table to select both axes.
  - o In the **Display** sub-tab, select **Engineering:1k** for **Display**.



- Check the **Set Decimal Places** check box and set **Decimal Number** to 0. Press **OK** to close the dialog.

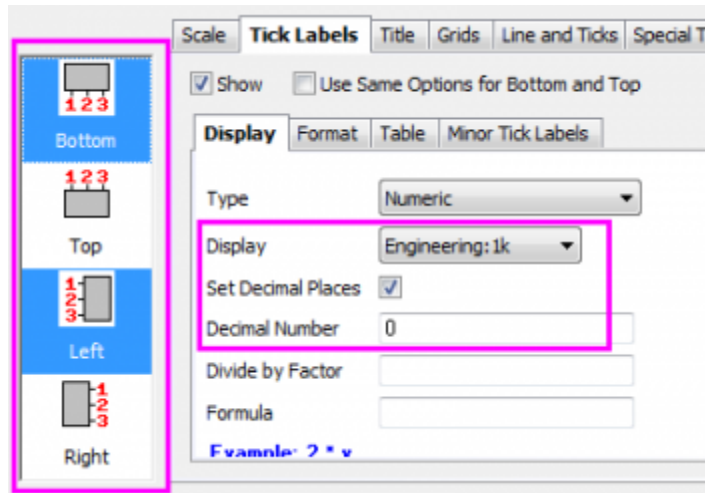

14. Now we can copy the customized formats from this graph to the other three graphs. Right-click on a blank area of the graph such as outside the axes, and select **Copy Format: All Style Formats** from the context menu.
15. Select **Edit: Paste Format (Advanced)...** from the main menu. In the **Apply Formats** dialog that opens, change **Apply Scope** drop-down at the bottom to **All Graphs in this Folder**. Click the **Apply** button to paste the format to the other graph, and then click **Close**.

#### 1.5.1.2 Merge and arrange graphs

1. We will now merge these 4 graphs windows. Select **Graph: Merge Graph Windows** from the main menu.
2. The **Merge Graph Windows** dialog opens. Accept the default settings and click **OK**. A new graph window with 4 layers is generated.
3. Now we will re-arrange the 4 layers in the merged graph. Select **Graph: Layer Management** from the main menu. The **Layer Management** dialog will open.
4. Activate the **Arrange** tab, then expand the **Spacing (in % of Page Dimensions)** branch. Set as follows:
  - Horizontal Gap = 15
  - Vertical Gap = 15
  - Left Margin = 10
  - Right Margin = 5
  - Top Margin = 5
  - Bottom Margin = 15
 Click the **Apply** button.
5. Activate the **Display** tab. Press the **Ctrl** key on the keyboard and select all 4 layers in the **Layer Selection** table on the left. Then select the **Scale Elements** checkbox under the **Option** branch. Set **Scale Mode** to **Fixed Factor** and set the **Fixed Factor** to 1.
- 6.



If you drag and resize a graph layer, or the layer gets resized when merging, text fonts and other graph objects get rescaled. You can control this behavior at the layer level of the Plot Details dialog by clicking on the **Display** tab and modifying the settings in the **Scale Elements** group.

- Click the **Apply** button. Click OK to close the dialog.

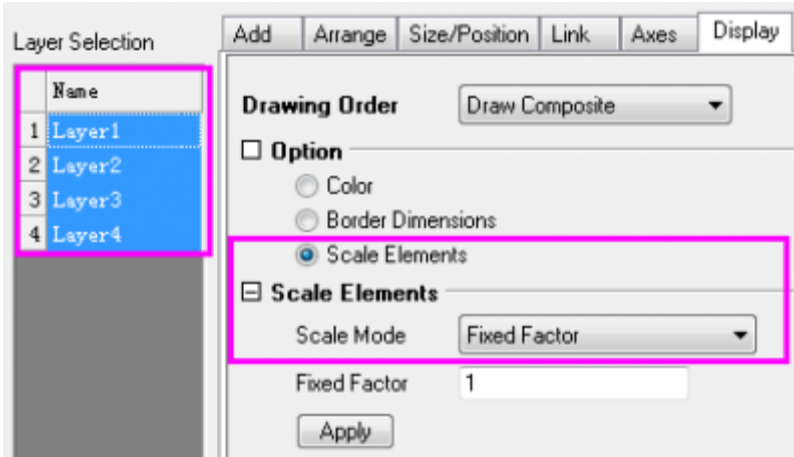

The merged graph should now appear as below:

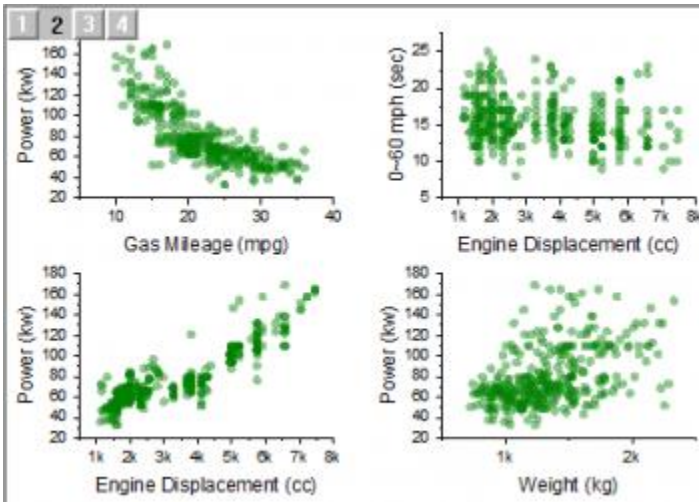

- Activate the *automobile* workbook by double-clicking on the icon in the lower panel of Project Explorer. Select column B, then right click and select **Filter: Add or Remove Filter** to add a filter.
- Click on the filter icon at the top-left corner of the column header. In the context menu that appears, click **Select All** once to de-select all items, and then select the **Honda** checkbox and click OK, to only show rows where Make is *Honda*. All other rows will be hidden, and all graphs will update to reflect the change

in the data.

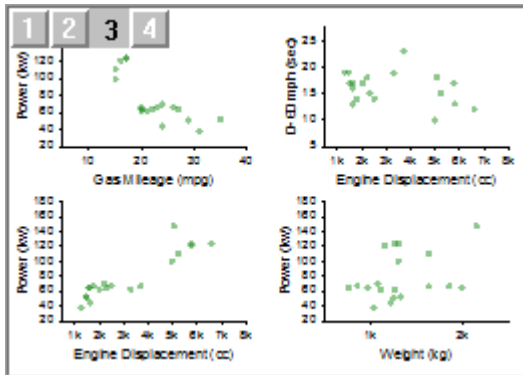

### 1.5.1.3 Cloneable Template and Smart Plotting

1. Let us now save the final merged graph as a template. Right click on its window title bar and select **Save Template As**. This will open the **template\_saves** dialog.
2. Make sure **Mark as Cloneable Template** is selected and **Match Plot Columns by** is set to **Long Name**. Enter *MyMergeGraph* for **Template Name** and click **OK**. A message is dumped to the Message Log telling you the template is saved.



Cloneable Templates save the column positions or column names along with all other graph properties. This allows for duplication of complex graph arrangements from other data with same arrangement of column positions or names.

3. Activate the *automobile* workbook. Select the filter on column B and select both *Honda* and *Lexus* and click OK to show both makes.
4. With the book still active, select **Plot > Templates User: MyMergeGraph** from the main menu. A new graph is created, with the same data assignments and formats as present in the previous merged graph.
5. Save your project file.

## 1.6 Publishing Graphs

In this lesson we will learn about some of the options available for publishing graphs.

### 1.6.1.1 Pasting Graphs in Other Applications

1. Open the project file saved from [lesson four: Merge and Arrange Graphs](#). Click to select the last graph window that you created.
2. Use the menu **Edit:Copy Page**, or the shortcut **CTRL+J**, to copy the graph page.
3. Launch Microsoft® WORD, then press **Ctrl+V**. The graph will be pasted as an embedded object in Word.
4. Double-click on the graph in Word. A new instance of Origin will be launched. Note that in this instance, only the graph and data related to the graph are available in the project.
5. Use menu **Format: Page** to open the **Plot Details** dialog in the page level. Then in the right panel, change the background color by choosing the **Display** tab and setting **Color** as **LT Gray**. Click OK.

6. From the menu, choose **File: Exit & Return to Document1**. This will close the instance of Origin, and the graph image in the document will be updated.
7. Repeat step 1~2 to copy the graph page. then go back to the Word document, de-select the graph and press **Enter** to move to a new line in the document. Under the **Home** tab click the **Paste** icon, then select **Paste Special** from the drop-down.
8. In the dialog that opens, select **Picture (Enhanced Metafile)** and click OK. This will paste the Origin graph as a picture object. Double-clicking on the image will open the **Format Pictures** dialog.

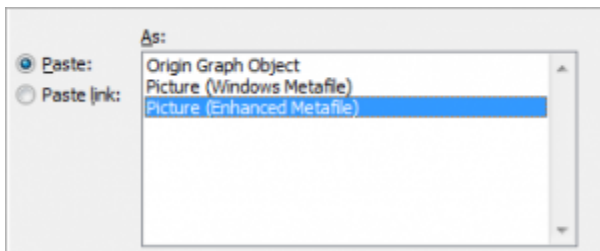

9.

 When the Origin graph is placed as an embedded object in applications such as Word or PowerPoint, all the data associated with the graph are also saved with the Word document. This provides the flexibility of double-clicking and editing the graph in a new instance of Origin. However, if many graphs are placed as objects in a document, the document file size will become large if there is a lot of data associated with the graphs.

#### 1.6.1.2 Sending Graphs to PowerPoint

1. With the graph window active in Origin, press the **Send Graphs to PowerPoint** button .
2. Accept all default settings in the opened dialog and click **OK**. The graph will be pasted as a new slide in the PowerPoint file.
3. Right-click on the graph title bar (in Origin) and select **Add Shortcut to Favorites**. This will add a **Favorites** folder to the project, visible in **Project Explorer**.

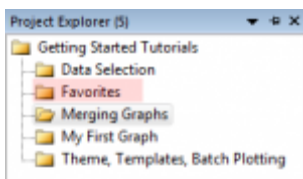

4. In **Project Explorer**, select the **My First Graph** folder. Then select the graph window, right-click on the title, and **Add Shortcut to Favorites** folder. Add shortcuts from other graph windows in the project as desired.
5. Go to **Project Explorer** and activate the **Favorites** folder. In the bottom panel, without selecting any item, right-click on the white area and choose **View:Extra Large Icons** from the context menu. This will show the graphs as extra large icons.

 Double-click on the icons in **Favorites** folder to open the graph for viewing or editing. Right-click on the icon or the graph window title bar for a context menu command to go to the original folder for that graph.

- Right-click on the **Favorites** folder in the upper panel of **Project Explorer** and choose **Send Graphs to PowerPoint**. Accept defaults in the dialog that opens. All graphs in the folder will be sent to PowerPoint. Note that you can do this operation in any folder, and not just the Favorites folder.

 The dialog for sending graphs to PowerPoint has options for selecting all graphs in the project, specifying graphs by name, and placing the graphs on duplicate copies of a specific slide PowerPoint file slide that you can prepare prior to the operation.

#### 1.6.1.3 Slide Show in Origin

- Right-click on the **Favorites** folder in the upper panel of **Project Explorer** and choose **Slide Show of Graphs** from the context menu.
- Accept defaults in the dialog. The slide show will start. Use arrow keys to view the next or previous graph in the sequence.

 In the bottom panel of Project Explorer, switch to **Details** view (right-click in a empty location and choose **View: Details**). Right-click on the lower panel title bar and enable **Slide**. Note that you can drag to reorder the columns. Use the added **Slide** column to arrange the order of the graphs. Click on the slide column header once, and then you can drag and rearrange the graph entries to set the order. This order will be followed for operations such as slide show, pushing graphs to PowerPoint, and exporting.

#### 1.6.1.4 Exporting Graphs

- Go back to Project Explorer and select the **Merging Graph** folder in the upper panel.
- Activate the graph and choose **File: Export Graphs** and change the following dialog box settings.
  - Select **Portable Document Format (\*.pdf)** from the **Image Type** drop-down list.
  - Change the **Select Graph(s)** drop-down to **All in Active Folder**.
  - Expand the **Image Size** branch and enter **5** in the **Fit Width** text box.

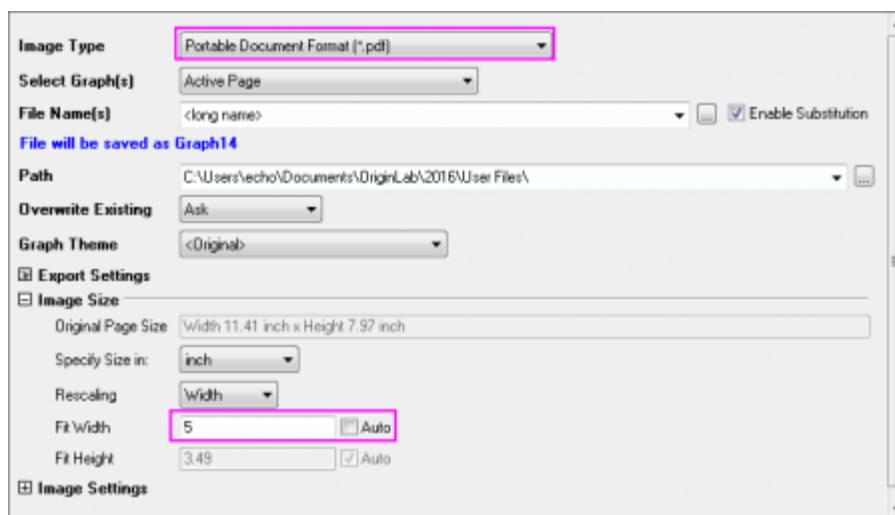

- Click the **OK** button to close the dialog.

- Click on the **Messages Log** tab on the left side of the interface. The export path will be displayed there. By default, this will be your User Files Folder (UFF) path. Copy the path, then go to **Windows Explorer** and paste the path to open the folder. You can then view the PDF files that were exported from Origin.
- Save your project file.

## 1.7 3D and Contour

In this lesson we will learn how to plot 3D, contour, and profile plots. Data for such plots can be organized as XYZ columns or an array of cells in a worksheet, or in a matrix window.

### 1.7.1.1 3D Surface

- Start with the project saved from the previous lesson and add a new folder named **3D and Contour**. Click to open the empty folder.
- Click the **New Workbook**  button on the Standard toolbar.
- Import the file `<Origin EXE Path>\Samples\Matrix Conversion and Gridding\XYZ Random Gaussian.dat`.
- Right-click on the header of column C and select **Set as: Z** from the context menu.
- Keep column C highlighted. Then select the menu **Plot > 3D: Surface: 3D Color Map Surface** to create a surface plot.
- Double-click on the layer icon on the upper left corner of the graph page, indicated by **1**, to open the **Layer Contents** dialog box.
- In the left-hand panel, select **C(Z)**. In the middle section, click the drop-down arrow next to the **A** button.

From the drop-down, select **3D Scatter/Trajectory/Vector**. Click the **Add Plot** button  to add the plot to the right-hand panel.

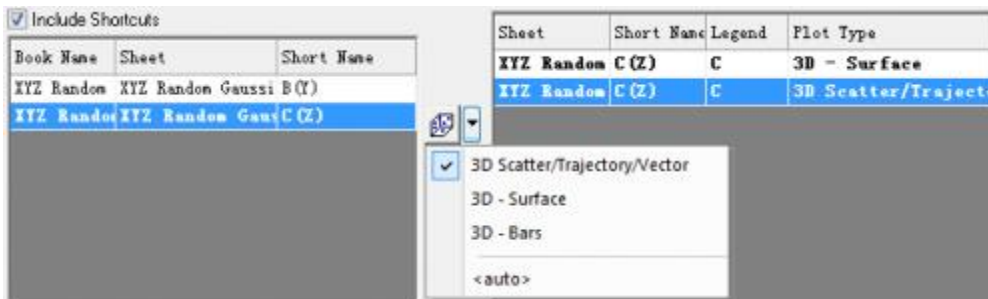

- Click **OK** to close the dialog. The graph will now display the individual data points on the surface.
- Hold the **R** key and use the mouse to freely rotate the surface plot.



### 1.7.1.2 Image Profile

- Click on the **New Matrix** button  in the **Standard** toolbar to open a new matrix window.
- Select the menu **Data: Import from File: Image to Matrix**, then browse to `<Origin EXE Path>\Samples\Image Processing and Analysis` folder and select `cell.jpg` file and import it into the matrix.
- With the matrix active, select the menu **Plot > 2D: Profile: Image Profiles**. An image profile graph will be created, and the **Image/Contour Profile** dialog will open.

- In the dialog, select the **HLine** tab then make the horizontal line thicker by expanding the **Width** branch and changing **Pixels** to **50**.
- 

 You can add multiple horizontal, vertical, or arbitrary lines using the buttons in the dialog. The graph layers will display overlaid curves for the profiles in the appropriate layers. Profile plots can also be made from data in a matrix or worksheet.

### 1.7.1.3 Contour and Surface Plots from Virtual Matrix

- Click on the **New Workbook** button  to create a new workbook.
- Click on the **Import Wizard** button . In the dialog that opens, choose the ... button  next to **File** box, browse to <Origin EXE Path>\Samples\Graphing folder, choose *waterfall.dat* file. Click **Finish** to import the file.

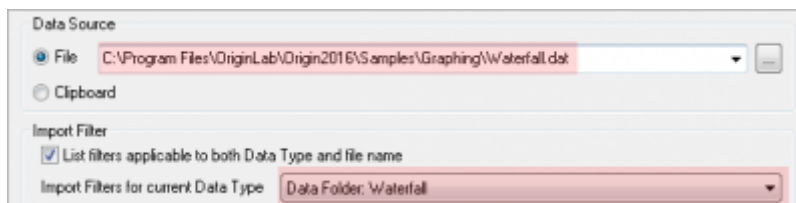

- 

 The **Import Wizard** can be used to parse an ASCII file to extract variables from header lines. The file you chose already has a predefined filter which is applied when you click the Finish button.

- Move the cursor to the upper left corner of the workbook until the shape of the pointer changes as in the following image, and click to select all columns of the worksheet.

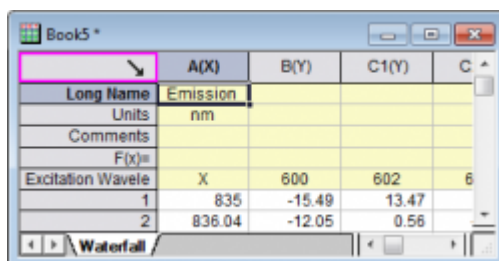

	A(X)	B(Y)	C1(Y)	C
Long Name	Emission			
Units	nm			
Comments				
F(x)				
Excitation Wavelength	X	600	602	6
1	835	-15.49	13.47	
2	836.04	-12.05	0.56	

- Select menu **Plot > 2D: Contour: Contour - Color Fill**. This will open the **plotvm** dialog box, where you need to specify the data organization for your **Virtual Matrix**, as the data is contained in a worksheet instead of a matrix window.
- Change **Y Values in** to **Column Label**, and then set **Column Label** to **Excitation Wavelength(nm)**.
- Click the **OK** button to apply the settings and create the contour graph.
- Click the **Enable/Disable Speed Mode** button  one time from the right-hand toolbar, to turn off the speed mode setting for the graph.

9. Go back to the workbook with waterfall data. Keep the whole worksheet highlighted and this time select the menu **Plot > 3D: Surface: 3D Color Map Surface with Projection**.
10. The **plotvm** dialog opens. Note that the **Theme** box on the top of dialog is set as **<sheet>**. This is because the settings used last time were saved in the worksheet. Click **OK** to accept the same settings. A surface graph with contour projection will be created.
11. Double-click on the contour projection to open the **Plot Details** dialog. Note that on the **Surface** tab, the **Flat** check box is checked, and an offset of 100% has been applied. This setting makes the data plot appear as a flat contour on top of the cube. Click OK to close Plot Details.

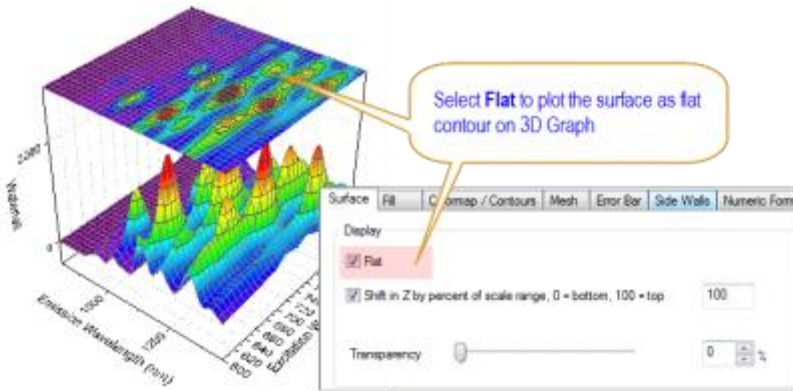



12.

 Data from different matrices or virtual matrices can be plotted in the same 3D graph layer by specifying an appropriate offset value for each, and further specifying which datasets to flatten. This allows to examine related data together in the same graph.

13. Double click on the **Z** axis to open the **Axis** dialog. Switch to the **Scale** tab and set the **To** value to 4000 and click OK. This allows better viewing of the 3D surface. The contour project will stay on the top plane of the cube.

#### 1.7.1.4 3D Function Plot

1. Select the menu **File: New: Function Plot: 3D Function Plot**.
2. In the dialog box, click the triangle button  next to the **Theme** box on the top. Then select **Mexican Hat(System)** in the context menu to load the settings for this example.
3. Press **OK** to create the plot.
- 4.

 A parametric function can be added to an existing graph, thus allowing you to combine such plots with real data. Visit [3D Function Gallery](#) to view and download more examples.

Save your project file.

## 1.8 Gadgets

In this lesson, we will use gadgets to perform exploratory analysis of data in a graph.



### 1.8.1.1 Integrate Gadget

1. Start with the project saved from the previous lesson and add a new folder named **Gadgets** at the root level in Project Explorer, then go to that folder.
2. With the new workbook active, click the **Import Single ASCII** button  on the **Standard** toolbar and import the file <Origin EXE Path>\Samples\Curve Fitting\Multiple Gaussians.dat.
3. We will add long names for the datasets. Enter "Peak 1" in the **Long Name** label row of column B. Click and select the long name cell. Then move the mouse to the lower-right corner of the cell so that the cursor changes to "+". Click the left mouse button and drag from column C to E. Origin will auto-fill the names as *Peak 2*, *Peak 3* and *Peak 4*.
4. Click and drag on the column headers to highlight columns B to E. From the main menu, select **Plot > 2D: Multi-Y: Stacked Lines by Y Offsets** to create a stacked lines graph.
5. With the graph active, select **Gadgets: Integrate...** from the main menu.
6. Accept the default settings and press the **OK** button. A region-of-interest (ROI) box will be placed on the graph. Move and/or resize the ROI to cover a desired range of the data.
7. Click on the triangle button at the top-right corner of the ROI box and select **Preferences** to re-open the dialog.
8. In the **Output** tab, expand the **Output Quantities to** branch and select the **Append to Worksheet** check box . Click **OK** to close the dialog box.
9. When there are multiple plots in a layer, the gadget acts on the active data plot by default. In this case, the active plot is *Peak 1*. To change the data to Peak 3 for example, click on the triangle button at the top-right corner of the ROI box and select **Change Data: Plot(3): Peak 3** from the context menu.

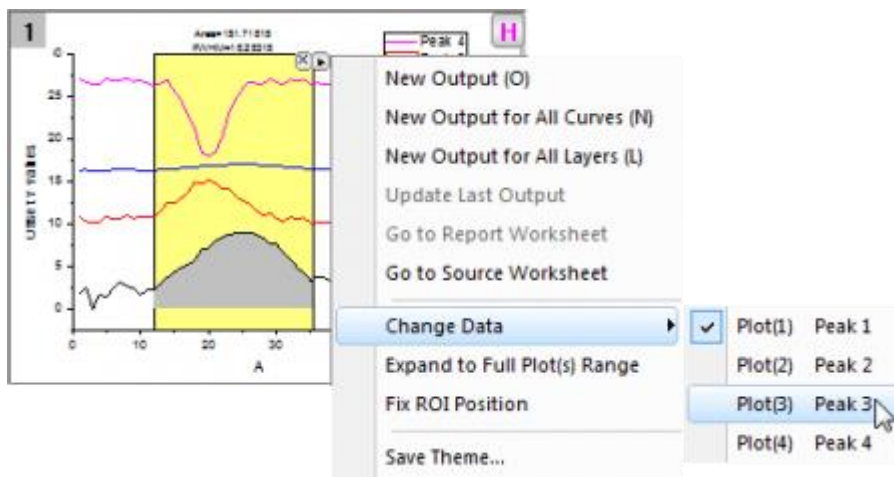

10. Click on the triangle button again and select **New Output for All Curves**. A workbook with integration results for all curves will be generated. Click the triangle button and select **Go to Report Worksheet** to switch to the output workbook.
11. Click the **X** button at the top-right corner of the ROI box in the graph to remove the gadget.

### 1.8.1.2 FFT Gadget

1. Start with a new workbook, and import the file <Origin EXE Path>\Samples\Signal Processing\Chirp Signal.dat.

- Highlight column B, then select **Plot > 2D: Line: Line** from the main menu to create a line graph.
- With the graph active, select **Gadgets: FFT** from the main menu. Accept defaults in the dialog that opens, and click **OK**. An ROI box will be placed on the graph, and another graph named FFTPREVIEW will be created, displaying the FFT result.
- In the top right corner of the FFTPREVIEW graph, uncheck **Log Scale**. Then reposition the source line graph and FFTPREVIEW window side by side. Move and resize the ROI to cover a small range of the beginning of the data curve.
- Now you can use the arrow keys to move the ROI to the right, while watching the FFT result update in the other graph.

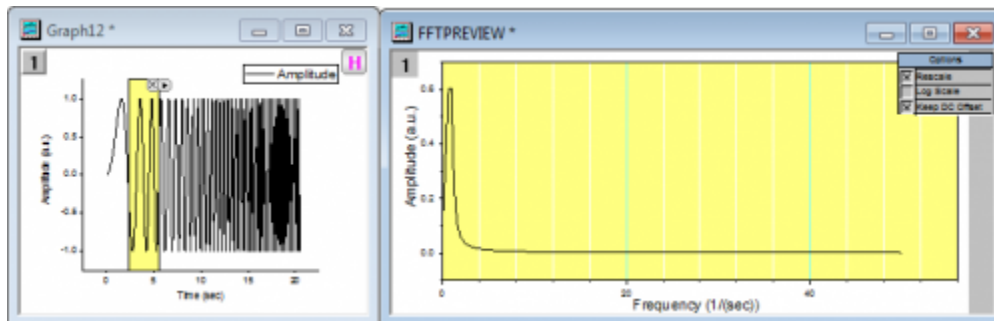



- Save the project file.

## 1.9 Curve Fitting

In this lesson we will learn how to perform linear and nonlinear regression.

### 1.9.1.1 Linear Fit with Outliers

- Start with the project saved from the previous lesson, and add a new folder at the root level in Project Explorer named **Curve Fitting**.
- Import the file `<Origin EXE Path>\Samples\Curve Fitting\Outlier.dat`.
- Select the 2nd column and create a scatter plot.
- Select the menu item **Analysis: Fitting: Linear Fit**. In the dialog that opens, accept default settings and click **OK** to perform the linear fit.
- In the graph, right-click on the fitting results table and select **Quantities in Table**. Remove all entries except **Intercept**, **Slope** and **Pearson's r** (use CTRL + select for multiple selections). Click **OK** and resize the results table as needed.
- Now click the **Mask Points on Active Plot** button  on the left side toolbar and mask the point at the right bottom, which is distinctly separated from the rest of data points.
- The lock on the top left of the graph page turns yellow  indicating that the data has changed, but the fit results are in need of an update.
- Hit the ESC key to switch the cursor back to pointer mode. Then click on the yellow lock, and from the fly-out menu select **Recalculate Mode: Auto**. The fit results will be updated.
-



You can update all pending operations in a project by clicking on the **Recalculate** button



located in the Standard toolbar.

10. Go back to the graph and use the masking tool to mask the outlier point towards the top. You will notice that the results automatically update. Your graph should now look similar to this image:

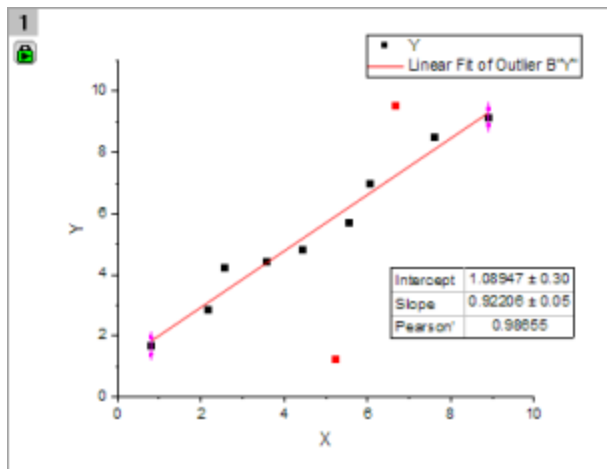

#### 1.9.1.2 Nonlinear Curve Fit

1. Start with a new workbook, and import the file  $\langle \text{Origin EXE Path} \rangle \backslash \text{Samples} \backslash \text{Curve Fitting} \backslash \text{Gaussian.dat}$ .
2. Highlight the column named *Amplitude* and make a scatter plot.
3. Go back to workbook, highlight column named *Error*, then right click and select **Set As: Y Error** from the context menu.
4. Place the mouse cursor close to the right edge of the highlighted column. The cursor will change to . At this point, drag and drop the column onto the graph. The data will be added as error bars on the scatter plot.
5. Now let's fit this data. Select the menu **Analysis: Fitting: Nonlinear Curve Fit** to open then **NLFit** dialog.
6. In **Function Selection** page, set **Category** drop down to **Peak Functions**, and set the **Function** drop down to **Gauss**.
7. Click **Fit** button to perform fitting and choose **No** in the prompt dialog, to keep the graph window active.
8. Now we want to fix  $y_0$  as 0 and update the results. Click on the green lock on the top left of the graph page, and select **Change Parameters**.

- The dialog re-opens with the settings that were used last time the operation was performed. Go to the **Parameters** tab, check the **Fixed** box for  $y_0$  and enter **Value** as 0.

NO.	Param	Meaning	Fixed	Value
1	$y_0$	offset	<input checked="" type="checkbox"/>	0
1	xc	center	<input type="checkbox"/>	26



- Click the **Fit** button to update the file and close the dialog. From the updated table on the graph, we can see that  $y_0 = 0 \pm 0$ .

### 1.9.1.3 Global Fit with Parameter Sharing

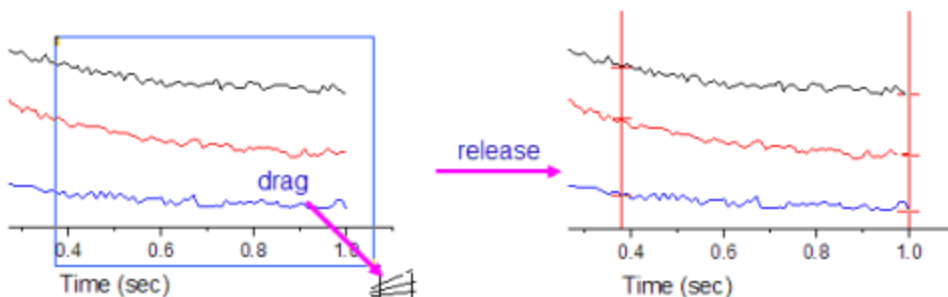
- Start a new workbook and import the file `<Origin EXE Path>\Samples\Curve Fitting\Exponential Decay.dat`.
- Drag and select the three Y columns and create a line plot.
- We want to fit all three data plots simultaneously over the x range of 0.4 s to 1.0 s. In the **Tools** toolbar docked to the left side of the interface, click the down arrow button on the right of **Selection on Active Plot** button . From the fly-out, choose **Selection on All Plots**. Go to the graph and drag and draw a rectangle to roughly cover the x range of 0.4 to 1.0, including all the three curves in the process.



- Press **CTRL+Y** to quickly launch the **NLFit** dialog. Then set **Category** as **Exponential** and **Function** as **ExpDec1**.
- Click on **Data Selection** under the **Settings** tab, expand the **Input Data** node and you will find all three curves are added. You can expand the **Range#** node to further adjust data ranges either by row index or by x value.
- 

 If no range selection has been made on the multiple plots, Origin will only pick up the active data plot from the graph layer containing multiple plots. In that case you can click the  button on the right side of **Input Data** and select **Add all plots in active page**.

- Change **Multi-Data Fit Mode** to **Global Fit**, switch to the **Parameters** tab and click the **Fit until converged** button  to fit all three curves simultaneously, keeping the dialog open.

- You can share parameters during a global fit. Check the **Share** box for the time constant **t1**. You will notice that the time parameter for the other curves has been removed from the parameters list.
- Click the **Fit** button and select **Yes** in the prompt that appears, to switch to report sheet. If the prompt does not come up, you can click on the green lock in the graph and select **Go to Results**.
- Scroll down to the *Summary* table in the report. You will find that all time constants **t1** share the same values.

y0		A1		t1		k	tau
	Value	Standard Error	Value	Standard Error	Value	Standard Error	Value
Decay 1	97.76426	1.04512	75.32799	11.78854	0.28532	0.03567	3.5049
Decay 2	50.44112	1.39417	107.39208	16.22812	0.28532	0.03567	3.5049
Decay 3	14.46759	0.73292	43.06541	7.60772	0.28532	0.03567	3.5049

- Now click on the down arrow button beside the **Summary** node and choose **Create Copy as New Sheet**. A new worksheet with the fit results will be added to the book.
- Select column D, E and create a column plot to display how the amplitude parameter (A1) changed across the three datasets.

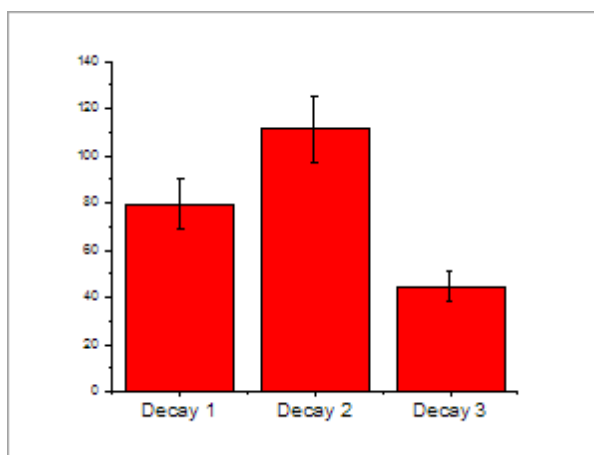

## 1.10 Peak Analysis

In this lesson we will perform fitting, including deconvolution of overlapping peaks and baseline correction.

### 1.10.1.1 Multiple Peak Fit with Deconvolution

- Let's continue with the project file we saved in the previous lesson. Create a new folder in Project Explorer, rename it as **Peak Analysis**, then go to the empty folder.
- In a new workbook, import the file `<Origin EXE Path>\Samples\Spectroscopy\HiddenPeaks.dat`.
- Highlight column B and create a line plot.
- With the graph window active, click **Analysis: Peaks and Baseline: Multiple Peak Fit**. This will open the **Multiple Peak Fit** dialog. Set the **Peak Function** drop-down as *Gauss* and click **OK**.
- A **Get Points** dialog will open within the graph window. Note that you can re-position this dialog within the window. Double-click on a peak center to select it. Select a total of 7 peaks as in the following image,

including two hidden peaks:

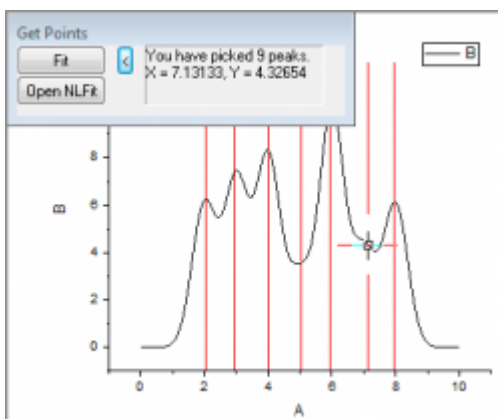

6.



If you click the **Open NLFit** button in the **Get Points** dialog, the NLFit dialog will open with the peak centers initialized with your selection. You can further control the fitting process as desired.

7. After selecting all seven peaks, click the **Fit** button. A fit report will be added to the workbook.

#### 1.10.1.2 Fit Peaks with Baseline

1. This part of the lesson assumes you have OriginPro. Start with a new workbook and import the file *<Origin EXE Path>\Samples\Spectroscopy\Peaks\_on\_Exponential\_Baseline.dat*.
2. Highlight column B and then click **Analysis: Peaks and Baseline: Peak Analyzer**. This will open the **Peak Analyzer** dialog, and a preview window displaying the selected data.
3. In the bottom panel, select the **Fit Peaks (Pro)** choice under **Goal**. The top panel will update, displaying a map of the steps involved in the peak fitting process.
4. Click **Next**. On the **Baseline Mode** page, select **User Defined** for **Baseline Mode**. Click **Next** to go to the **Create Baseline** page. You can then see in the preview window that 8 anchor points connected by a red line, are added to the spectrum. This is the baseline created using the current settings.

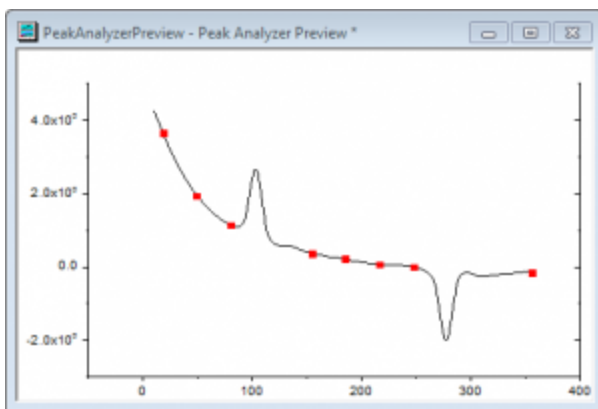

5.

Now click the **Prev** button to go back to the **Baseline Mode** page to adjust the baseline mode settings.

6. Click the **Find** button below **Number of Points to Find**, to find the baseline anchor points in the spectrum. Eight (8) anchor points are added.
7. Clear the **Enable Auto Find** checkbox and then click the **Add** button to add one or more anchor points on the spectrum. Double-click on the tail of the spectrum like the following image to add 1 anchor point.

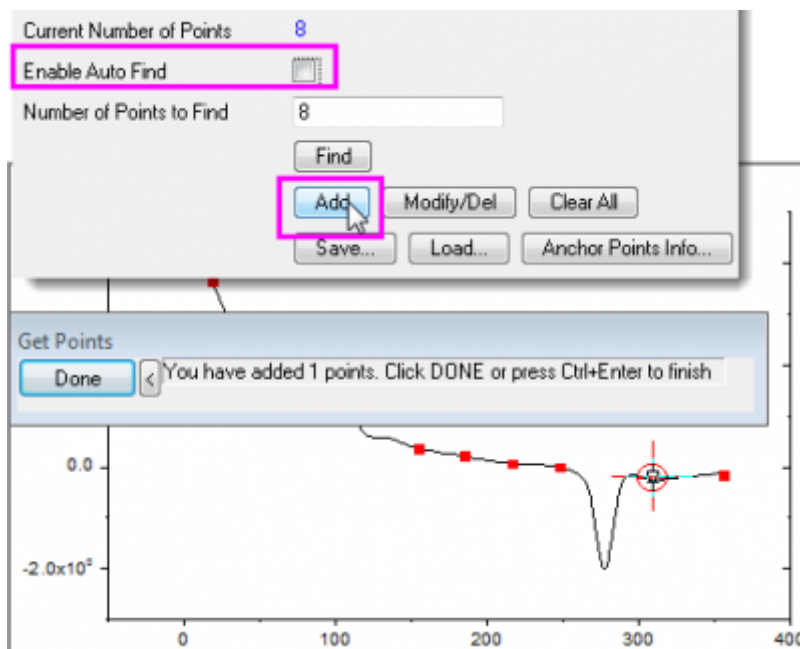

8. Note that you can also select and delete anchor points. Click **Done** to return to the **Peak Analyzer**.
9. Select the **Snap to Spectrum** checkbox to force anchor points to snap to the closest data point in the spectrum. Click **Next**.
10. On the **Create Baseline** page, select **Fitting** for **Connect by**. Select **ExpDec2** for **Function** under the **Fitting** branch. Click **Next** twice to go to the **Find Peaks** page.
11. Click the **Find** button. Two (2) peaks are found in the preview.
- 12.



There are several options available for peak finding including a 2nd derivative method to find overlapping peaks. You can also view the 2nd derivative curve, and turn on smoothing to help find peaks in noisy data.

13. Click **Next** to go to the **Fit Peaks** page. Accept defaults and click **Finish** to perform peak fitting. A graph containing fitting results is generated.
- 14.



You can click the **Fit Control** button to control the fitting process including fixing and sharing parameters, and specifying bounds and constraints.

15. Now, let's customize the **Fitting Results** table to hide some peak properties we don't want to display. Right-click on the table and select **Peak Report Field...** from the context menu. The **Peak Report Field** dialog will open, listing all properties that can be included in the table. You can remove or change the order properties in this dialog. Select **Peak Gravity Center** and click the **Remove** button to hide it. Do

the same for **Peak Area by Integrating Data(%)**. Press **OK** to update the table in the graph.

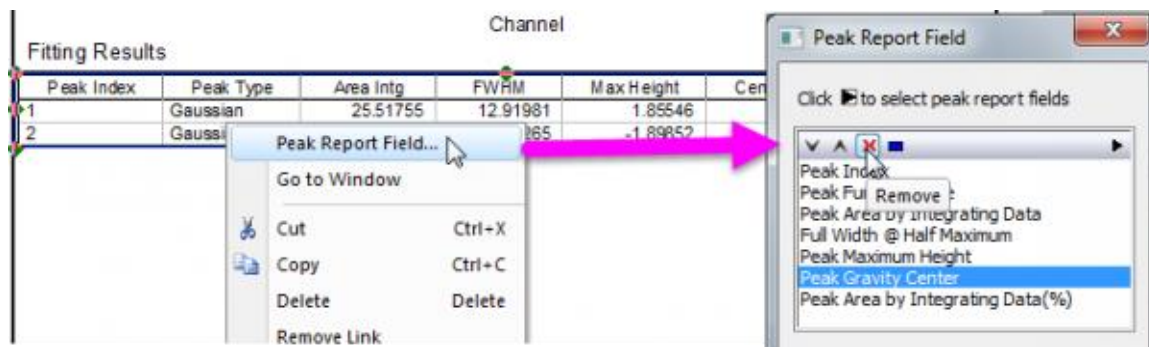

Save your project file.

## 1.11 Statistics

Origin provides many tools for statistical analysis. Advanced statistical tools are available in OriginPro. In this lesson, we will work with tools available in standard Origin.

### 1.11.1.1 Descriptive Statistics

1. Start with the project saved from the previous lesson, create a new folder in Project Explorer and rename it as **Statistics**. Open the empty folder.
2. Create a new workbook and import the file `<Origin EXE Path>\Samples\Statistics\body.dat`.
3. Drag and select the first **5** rows of column **D(Height)**. Basic statistics (average, sum, count) for your selected data will be displayed in the status bar at the bottom right side of the interface.

💡 You can right-click on the statistics listed in the status bar to customize what quantities to display there.



- 4.
5. From the menu, select **Statistics: Descriptive Statistics: Statistics on Columns**. In the dialog, select the **Input** tab, then expand **Range 1**. Click on the interactive button  to the right of **Data Range**.



Return to the worksheet, then drag and select columns **D** and **E**. Click the interactive button again to restore the dialog.

- In the **Group** control, click the triangle button  and select **B(Y): age**. Click the button again and select **C(Y): gender**. In the list, select **..."gender"** in the **Group** box, then use the **Move Up** button  to move it to the top.
- Click **OK** to generate the report.

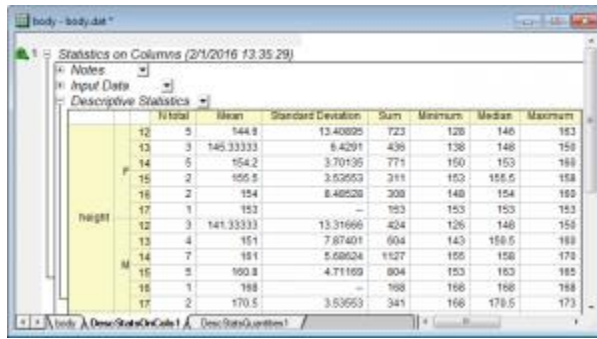

	N total	Mean	Standard Deviation	Sum	Minimum	Median	Maximum	
age	12	5	144.8	13.40825	723	128	146	163
	13	3	145.33333	6.4201	436	138	148	150
	14	5	154.2	3.70135	771	150	153	166
	15	2	155.5	3.52553	311	152	155.5	158
	16	2	154	8.46528	308	148	154	160
	17	1	153	...	153	153	153	153
height	12	3	141.33333	13.31666	424	126	146	155
	13	4	151	7.87401	604	143	159.5	168
	14	7	151	5.68624	1057	155	158	170
	15	5	160.8	4.71169	804	153	163	165
	16	1	168	...	168	168	168	168
	17	2	170.5	3.53553	341	166	179.5	173

- Click the downward-pointing triangle button  on the right of the **Descriptive Statistics** node in the report sheet and select **Digits...** from the context menu.
- In the opened dialog, change **Digits** to **Set Decimal Places=** and set **Decimal Number** as **1**. Click **OK** to update the display format in all tables of the report.
- 



The numeric display in all report sheets can be globally set using the **Digits in Report** control on the **Numeric Format** tab of the **Options** dialog accessible from the **Preference: Options** main menu.

### 1.11.1.2 Normality Test

- Create a new workbook by clicking the **New Workbook** button .
- Double-click in the **F(x)** label row of column A. This will put you into edit mode for that cell. Type the formula:

```
nint(100+20*normal(100))
```



The column will be filled with random integer numbers centered around 100.

- Highlight column A and click **Statistics: Descriptive Statistics: Normality Test** to open the dialog. The selected column is set as **Input Data** automatically. Accept default settings and click **OK**. This will generate the report sheet for **Normality Test**. The footnote under the **Shapiro-Wilk** table indicates that

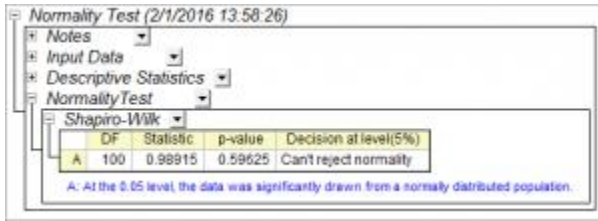
this data is normally distributed, as expected.



### 1.11.1.3 Frequency Counts

1. Activate **Sheet1** of the workbook from the previous section. Keep column A highlighted, then click **Statistics: Descriptive Statistics: Frequency Counts**.
2. Accept all default settings in the dialog and press **OK**.
3. In the result sheet, highlight the column **C(Y)**. On the **2D Graphs** toolbar, click the triangle button next to the **Column** button , then choose **Column + Label**  to create a column graph with labels. This will create a histogram plot with counts as labels.

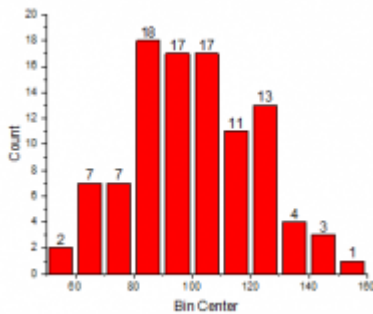

4.



The **Plot: Statistics** menu provides multiple histogram plot options when a worksheet is active. This **Frequency Counts** tool provides an alternate way to first perform counting, and then plot a histogram from the results. This allows for more flexibility and customization such as adding labels to the columns.

### 1.11.1.4 One Way ANOVA

1. Create a new workbook and then click on the **Import Single ASCII** button . Browse to <Origin EXE Path>\Samples\Statistics folder. Change the drop-down list next to the **File Name** to **Text File (\*.txt)**.

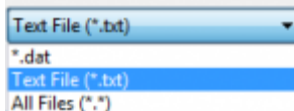

2. Select the file **nitrogen.txt**
3. Select the menu **Statistics: ANOVA: One Way ANOVA** to open the **One Way ANOVA** dialog. In the **Input** tab, set **Input Data** to **Indexed**. Press the triangle button to the right of **Factor** and select **A(X): plant**. Press the triangle button to the right of **Data** and select **B(Y): nitrogen**.
- 4.



The **ANOVA** dialog box provides two options for input mode: **Indexed** or **Raw**. You can refer to the [FAQ-333: What is indexed versus raw data and how to I transform from one to another?](#) to learn more about how data can be arranged for either mode.

5. In the **Means Comparison** tab of the dialog, select the **Tukey** check box. Then switch to the **Plots** tab and select **Means Comparison Plot**. Click **OK** to close the dialog and generate the report.
6. Go to the report sheet **ANOVA1Way1**. From the result, we can draw following conclusions:
  - The ANOVA table (**Overall ANOVA**) reports a p-value that is smaller than 0.05, hence at least two of the four groups have significantly different means.

Overall ANOVA					
	DF	Sum of Squares	Mean Square	F Value	Prob>F
Model	3	1996.36652	665.45551	12.86214	6.99338E-7
Error	76	3932.05317	51.73754		
Total	79	5928.41969			

Null Hypothesis: The means of all levels are equal.  
 Alternative Hypothesis: The means of one or more levels are different.  
 At the 0.05 level, the population means are significantly different.

- Double-click on the **Means Comparison Plot** to open it. The red plots indicate significantly different mean values. **PLANT4** has the smallest mean and is significantly different from the other three groups.

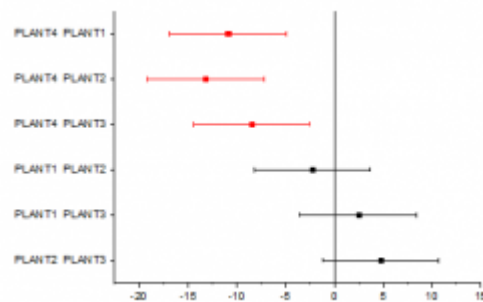

- Save your project file.

## 1.12 Analysis Template

In this lesson we will learn how create an **Analysis Template** and re-use it for new data.

1. Continue with the project file saved from the previous lesson. Create a new folder in Project Explorer and rename it as **Analysis Template**. Open the empty folder.
2. Create a new workbook and import the file `<Origin EXE Path>\Samples\Curve Fitting\Sensor01.dat`.
3. Highlight column B and select **Plot > Templates: User Templates: My Line** to create a line graph from the graph template `My_Line.otp` that we saved in [lesson 1](#).
4. With the graph window active, select **Analysis: Fitting: Linear Fit** from menu. This will bring up the **Linear Fit** dialog.
5. In the **Fit Control** tab, select the **Fix Intercept** check box to force the fitted curve go through (0,0). Select **Auto** for **Recalculate**. Click **OK** to perform the linear fit. The fitted curve and a result table will be added to the graph.

6. Right-click on the result table and select **Quantities in Table** from the context menu. In the dialog, remove all entries other than **Slope** and **Adj. R-Square**, then click **OK** to update the table.
7. Double-click on the X axis to open the **Axis** dialog. With the **Scale** tab active, hold down the **Ctrl** key and select both **Horizontal** and **Vertical** in the list box on the left. Change **Rescale** to **Auto** and click OK. This is to make sure the axis range will update when data changes.

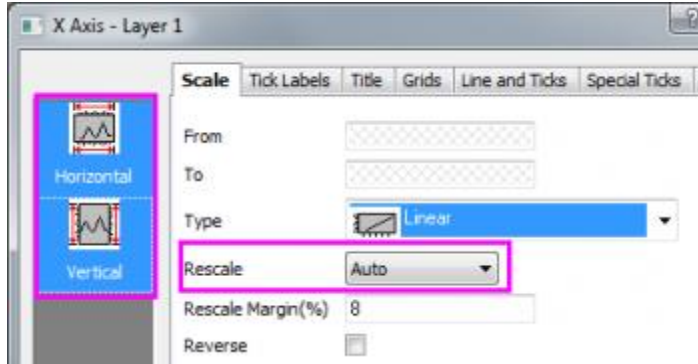

8. Select the legend on the graph and delete it.
9. Go back to the source workbook. Right-click on any one of the sheet tabs and select **Add Graph as Sheet** from the context menu.

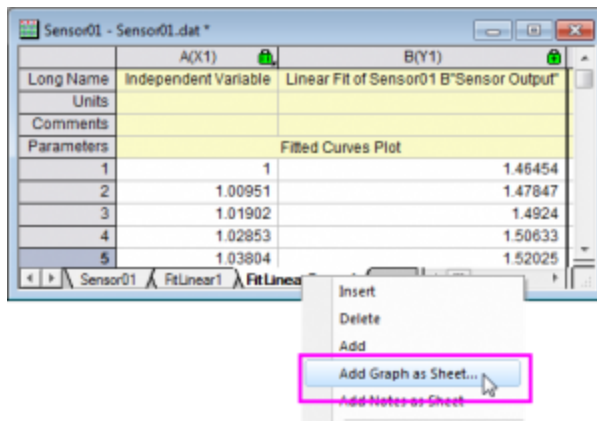

- 10.
11. In the **Graph Browser** dialog that opens, select **Active Folder** from the location drop-down list. Only the line graph in the current folder will be displayed. Select the graph and click **OK** to insert it as an embedded graph inside a new worksheet.

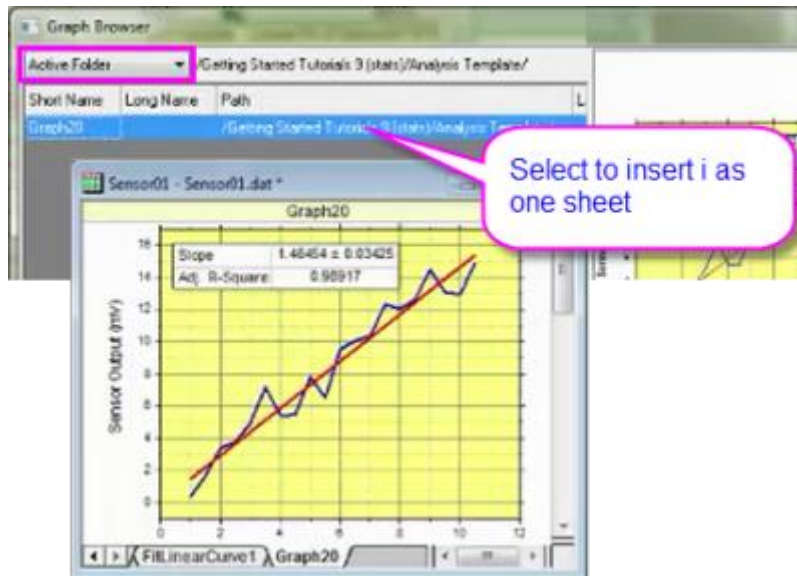

12.

13. Now we have source data and all analysis results in one book. Let's save it as an Analysis Template. Select **File: Save Workbook as Analysis Template...** from menu. Save the workbook as *My Sensor Analysis.ogw*.

14.



Any work book which has an operation linking input and output, indicated by a lock on output sheets or columns, can be saved as an analysis template. The simplest example would be a sheet where column value calculations have been performed.

15. Now use the **File: Recent Books** menu command to open **My Sensor Analysis.ogw**. The analysis template will open. Note that the data sheet, results and graphs are empty.

16. With the first data worksheet active, import another data file `<Origin EXE Path>\Samples\Curve Fitting\Sensor02.dat`.

17. The linear regression results and the embedded graph will update automatically, because we had set the **Recalculate** mode in the linear fit tool to **Auto**.



Analysis templates can be used manually to process one file at a time, or can be used to perform batch analysis of multiple data files or datasets. Please view the [Batch Processing tutorial](#) to learn more.

Save your project file.

## 1.13 Apps in Origin

In this lesson we will install and use an App from the **File Exchange** area of OriginLab's website.

1. Start with the project saved from last lesson, and add a new folder named **3D Ellipsoid** at the root level of Project Explorer.

2. Select the **F10** key to open the App Center dialog. Select the Search tab and input **3D Confidential Ellipsoid** into the search engine and select the Search icon in order to search for the app.  
**Note:** You can as well open the App Center dialog by selecting Add Apps in the Apps Gallery Window.
3. Click the **download and install** icon. Once the App is installed, the download and install icon will change to a green check-mark (**Up-to-date Version** icon). As well, an icon named **3D Confidential Ellipsoid** will appear in the **Apps Gallery** window docked to the right end of the workspace.

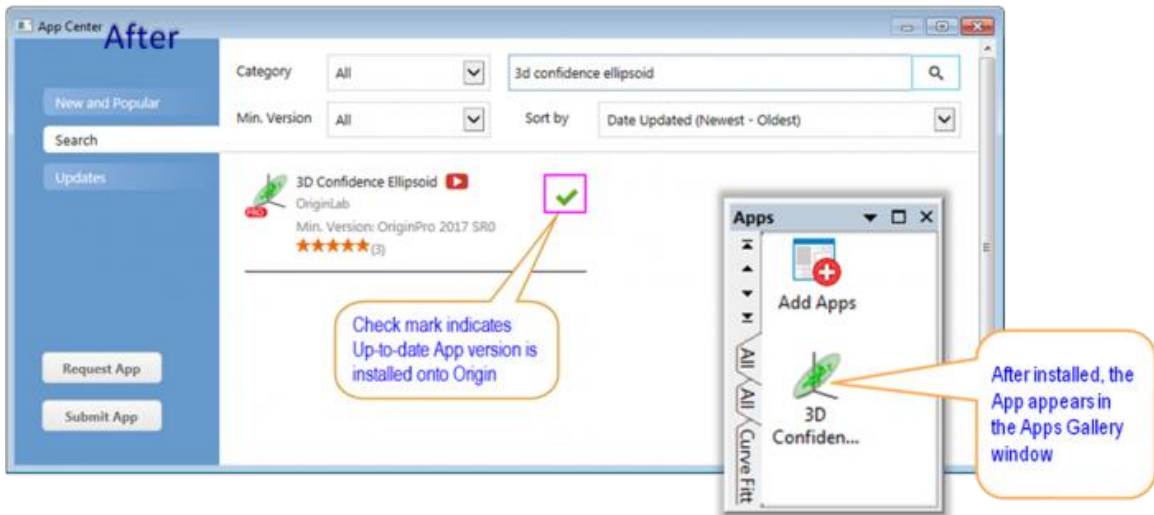
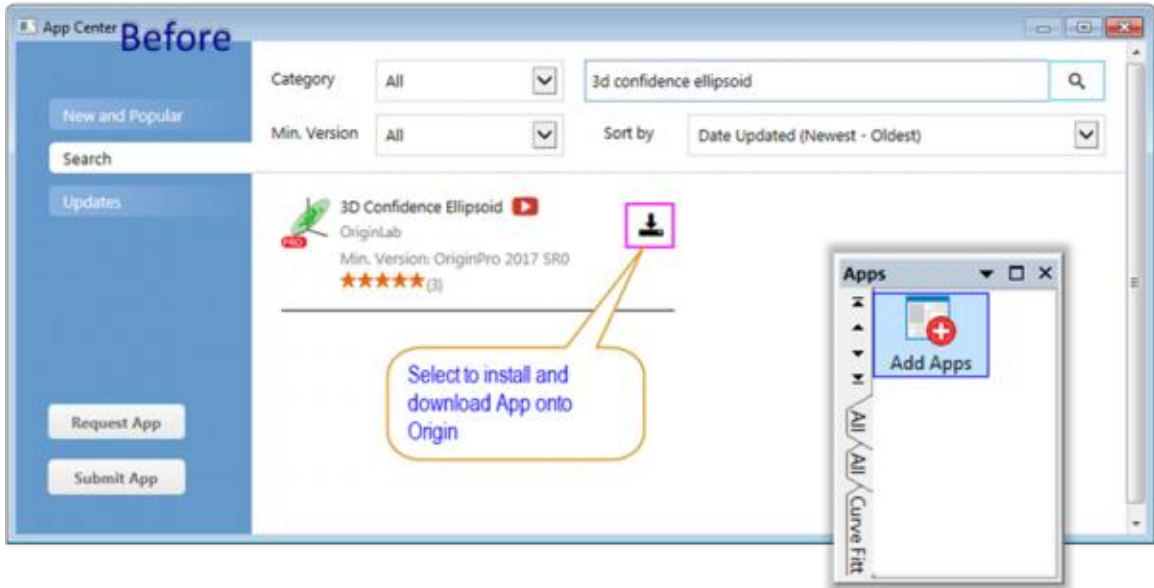

4. Now import the file `<Origin EXE Path>\Samples\Statistics\Fisher's Iris Data.dat` into a new workbook.
5. Select **Plot > Templates: System Template Library** from the main menu. In the **System Templates** dialog, expand the **Graph Template -> 3D Symbols & Bars & Vectors** node, then select **gl3d**. Click the **Plot Setup...** button at the bottom left corner of the dialog.
6. In the **Plot Setup** dialog that opens, set column C, D, and A as the X, Y, and Z columns, respectively.  
Click the **Show Plot List** button  to expand the dialog (if it is not already expanded) , click the **Add**

button, then click **OK** to create a 3D scatter plot.

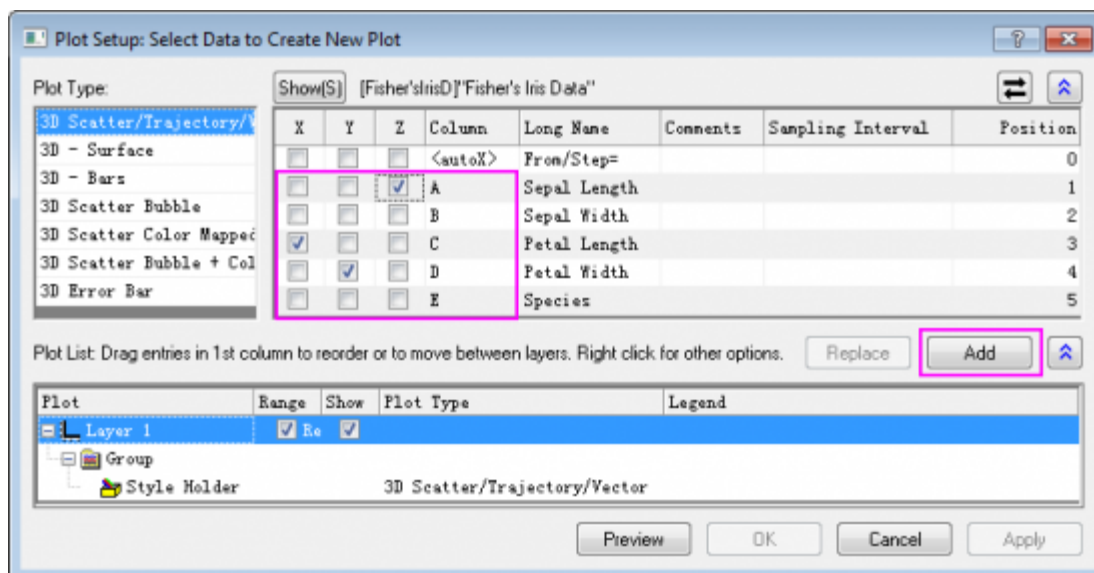

- Double-click on the scatter to open the **Plot Details** dialog. On the **Symbol** tab, click on the **Color** drop-down list, and then select the **By Points** tab. Then click on **Indexing**, and from the drop-down, select **Col(E) "Species"**. Click **OK** to close the dialog.
- Click the **3D Confidential Ellipsoid** button in the Apps Gallery. This will open the **Plot 3D Confidence Ellipsoid** dialog. Accept the default settings and click **OK**. Three ellipsoid are added to the graph, each envelops the group of data with the same color. You can hold the **R** key and then use the mouse to rotate the plot.

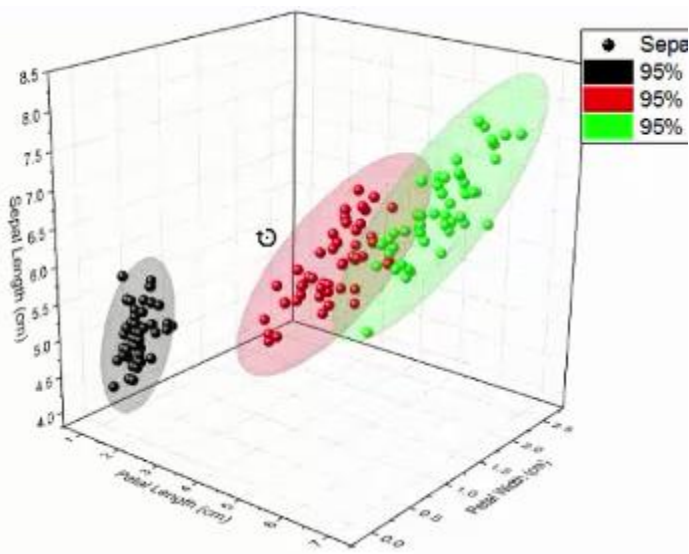

Save your project file.

We hope this set of **Getting Started** tutorials has been helpful in providing you with a broad overview and introduction to key features in Origin. We recommend that you continue with [more advanced tutorials](#) in the categories that are most relevant to your work.





## 2 Video Tutorials

To get started quickly with Origin, you could watch the videos in the following table:

Title	Description
<a href="#"><u>Introduction to Origin</u></a>	Learn how to quickly start using Origin from importing data, customizing column label rows, creating a multi-panel graph, selecting part of the data, performing integration, finding and fitting peaks, and using Recalculate to perform fitting with altered parameters.
<a href="#"><u>Importing Data</u></a>	Learn how to import ASCII file, customize your Import ASCII dialog settings and save them for future reuse, and use the Import Wizard to import data file and customize the import settings.
<a href="#"><u>Creating a Graph</u></a>	Learn how to create a graph using the graph toolbars or the Plot Details dialog, add data to an existing graph, and plot groups of plots by label.
<a href="#"><u>Customizing a Graph</u></a>	Learn how to add a layer title, resize a layer, change the axes properties, save a graph as a template and reuse it, customize a graph by using theme, change the plotting order, customize a single data point or a grouped data plot.
<a href="#"><u>Interpolation</u></a>	Learn how to change line connection to interpolate data and use Interpolate Gadget to perform data interpolation. Also, interpolate new Y data from given X data based on specified XY range.
<a href="#"><u>Linear Fitting*</u></a>	Learn how to perform a linear fit with outlier removal.
<a href="#"><u>Nonlinear Curve Fit Tool</u></a>	Learn how to fit with a built-in fitting function and change the NLFit settings using Change Parameters. Also, learn how to define and fit with a user-defined function.
<a href="#"><u>Creating an Analysis Template</u></a>	Learn how to set up a workbook for repetitive analysis using a linear regression example.
<a href="#"><u>Batch Processing</u></a>	Learn how to create an analysis template, and use this template to batch process multiple data files.
<a href="#"><u>Introduction to OriginPro</u></a>	Learn about all of the extended analysis tools in the areas of peak fitting, surface fitting, statistics, signal processing and image processing offered in OriginPro.
<p><b>Note:</b> Please visit the <a href="#"><u>video tutorial page</u></a> on our website for a complete and most up-to-date list of video tutorials.</p>	



## 3 User Interface

### 3.1 User Interface

- [Tutorial:Origin GUI](#)

### 3.2 Origin GUI

#### 3.2.1 Summary

This tutorial will introduce you to the Origin workspace. You will learn about the different kinds of Origin windows that make up a Project, how to manipulate these windows with Project Explorer, how to manipulate layers and plots with Object Manager and how to manage Apps with Apps Gallery.

Minimum Origin Version Required: Origin 2016 SR0

#### 3.2.2 What you will learn

This tutorial will show you how to:

- Manipulate Workbooks
- Create Graph Windows
- Manage workspace with Project Explorer
- Manipulate Layers and Plots with Object Manager
- Manage Apps with Apps Gallery

#### 3.2.3 Origin Application: Title Bar and Status Bar

The **Origin Title Bar** displays the Origin(Pro) version, any open project name and the current folder within that project (if any) along with the standard Window controls for moving, sizing and closing the window.

The **Status Bar** appears at the bottom of Origin's Window and displays messages, the state of Auto Update, overview of the statistics on selected worksheet cells, Child Window Theme (if any), Last active Workbook, Current Window and Angular Units indicator.

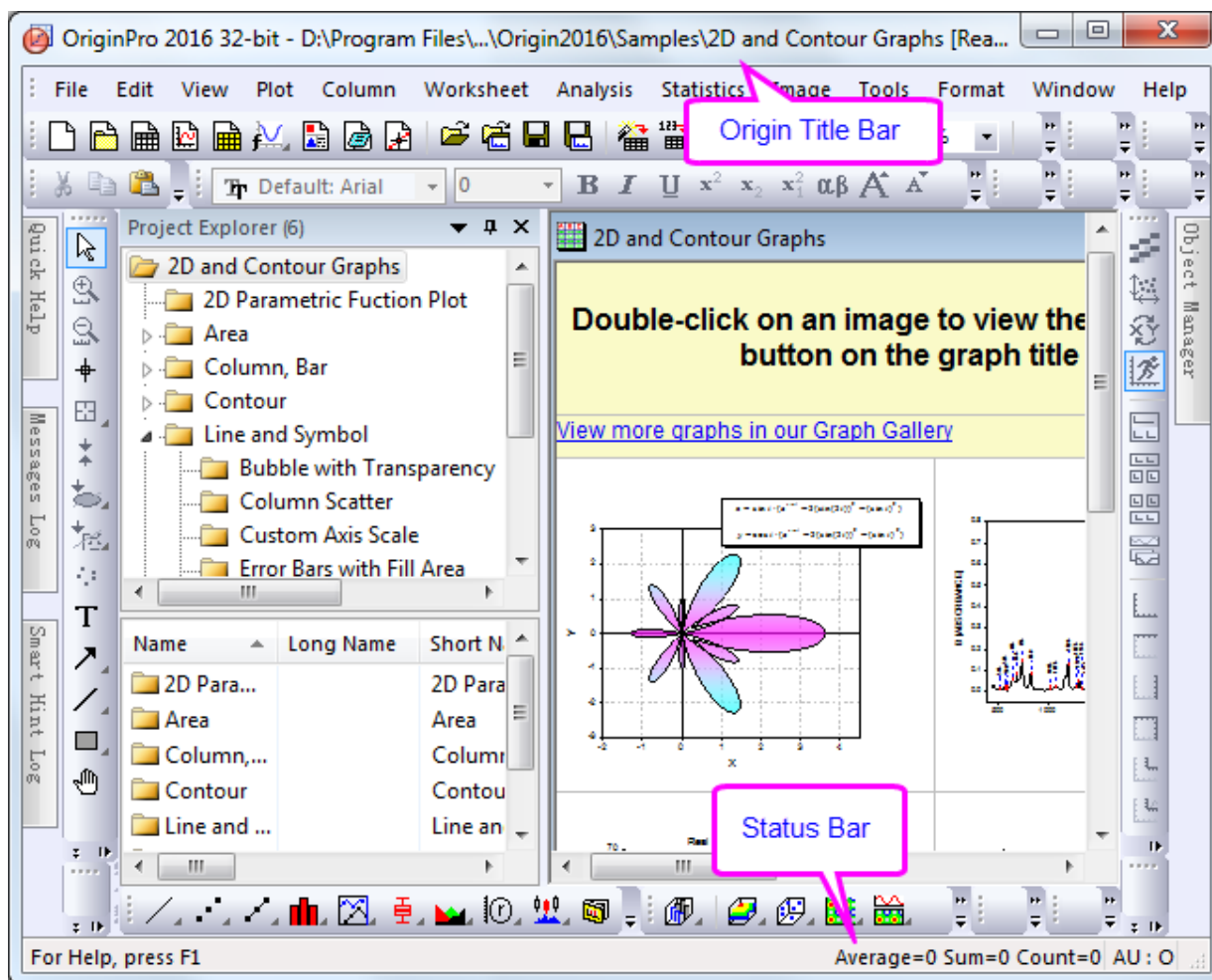



You can select what shows in the Status Bar by right-clicking on the Bar and selecting (or clearing) items from the context menu. You can copy the displayed basic statistics by selecting Copy Statistics from the context menu. The copied data are TAB separated between quantity and values, with each key value pair separated by a CRLF delimiter.

### 3.2.4 Windows

#### 3.2.4.1 Dynamic menus according to the active child window

The Origin menu dynamically changes according to the active Child Window. Some menus (Help, File, Edit, etc.) appear on all Child Window menus, although their content may change.

1. Click on the **New Project** button  on the **Standard Toolbar**.
2. The workbook window is the active window. Note that there are *13* menu items.
3. Click on the **New Graph** button  on the **Standard Toolbar**. A new window called **Graph1** is created. Note that there are *11* menu items displayed.

Thus, we say that the menus are "context sensitive." They will change depending on which type of Child Window is active.

**Note:** New Child Windows may be added by selecting the **File: New** menu option or clicking the appropriate button on the **Standard Toolbar**. All Child Windows have standard controls for moving and sizing and windows can be placed anywhere within the Origin workspace. The **Window** menu has options (cascade, tile) for arranging child windows within the workspace. In the central Origin Workspace is where you will find all Origin Child Windows which can include:

**Workbooks** - The Origin workbook is the primary structure for organizing your data. Each workbook is composed of one or more, up to 255 worksheets.

**Graphs** - With Origin, you can create over 60 graph types, each from a built-in graph template. Graph windows can be embedded in a worksheet cell.

**Matrices** - The Origin matrix holds data and images and is required for many 3D graph types.

**Notes** - Notes windows are a text-only Origin child window useful for recording analysis procedures, making notes to students and colleagues, etc. You can embed notes windows in a worksheet cell.

**Layouts and Excel** (If you have Excel installed)

### 3.2.4.2 Workbook

The Origin workbook is the primary structure for organizing your data. Each workbook is composed of one or more Origin worksheets. Each worksheet, in turn, is composed (usually) of one or more worksheet columns or datasets. Columns in Origin have different column types, such as X, Y, Z, yError, etc. These plotting designations determine how the data are treated when creating a graph.

Starting with version 2017, **Spreadsheet Cell Notation** icon  will show in the upper-left corner of the workbook by default, that means [the new simplified worksheet cell notation](#) (similar to that used in MS Excel) is turned on. You can learn more details about how this mode works in [the tutorial Setting Column Values](#).

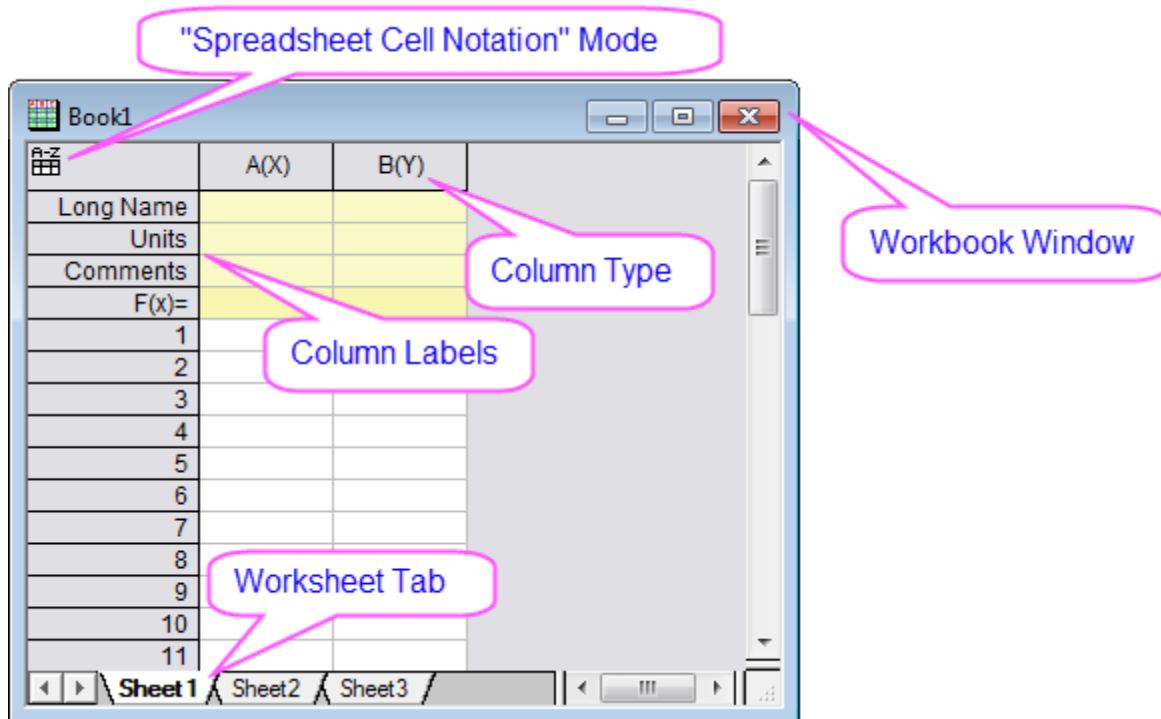

To get familiar with manipulating Origin workbooks, try the following:

1. Select **File: New** from the menu and choose *Worksheet* to create a new worksheet.
2. Select **Data: Import from File: Single ASCII** to bring up the **Open** dialog. Browse to the `\Samples\Curve Fitting` subfolder of the Origin program folder. Highlight the file *Gaussian.dat* and click the **Open** button to import the data into the Origin worksheet.
3. On import, sparklines were automatically turned on, allowing you to quickly view the shape of the data; the sheet name became the name of the file; and as needed an additional column was added to the worksheet. You can see from the **Long Name** that the 3rd column represents data error. To set this column as an Error Column, click the column title to highlight the column, right-click to bring up a fly-out menu, and then select **Set As: Y Error**.
4. Plotting data in Origin is now easy; highlight column B and C (Y and Y error), then select **Plot: Symbol: Scatter** from the menu to create a scatter plot with error bar.

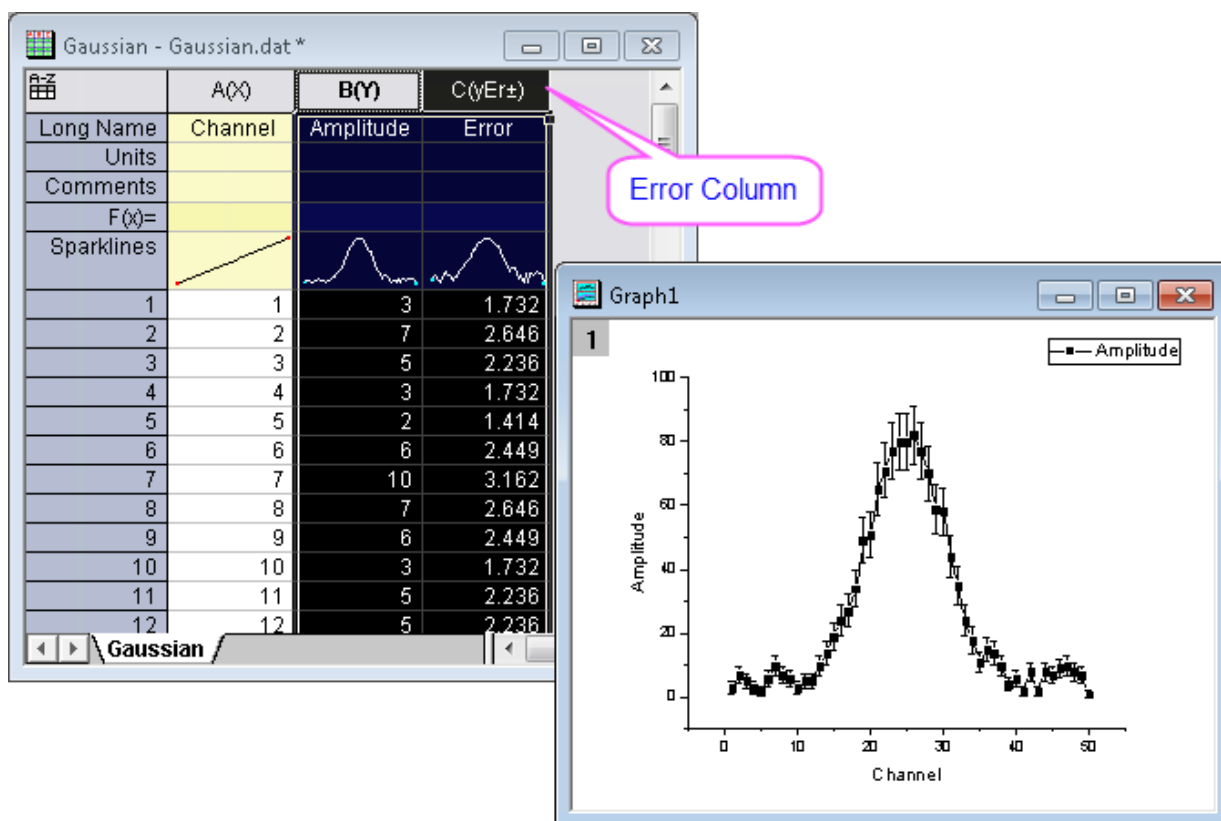

### 3.2.4.3 Graph

The Graph window is a container for graphical depictions of your experimental data and your analysis results. Graph windows may contain a single plot in a single graph layer or they may contain multiple plots in multiple graph layers.

The graph layer is the fundamental unit of the Origin graph. The layer is comprised of a set of axis scale values, one or more data plots, and any included text labels, drawing objects, graph legends/color scales, button objects, etc. Graph layers can be created, sized, and moved independently of one another, allowing you a great deal of latitude in charting your data.

To learn how to organize layers in a graph window, try the following:

1. Create a new workbook, and import the file *Linear Fit.dat* from the *\Sample\Curve Fitting* folder. You can see that there are three Y columns and one X column after import; each Y column will use the left-most X column as its X coordinates.
2. Highlight columns B and C, and select **Plot: 2D: Multi-Panel: Vertical 2 Panel** to plot the curves. This is a two layer graph. While a graph can have multiple layers, only one layer is active at any given time. You can perform operations on the active layer, such as resizing, changing the plot color, etc. When working on a layer, the active layer is denoted by a depressed layer *n* icon in upper left corner of the graph window.

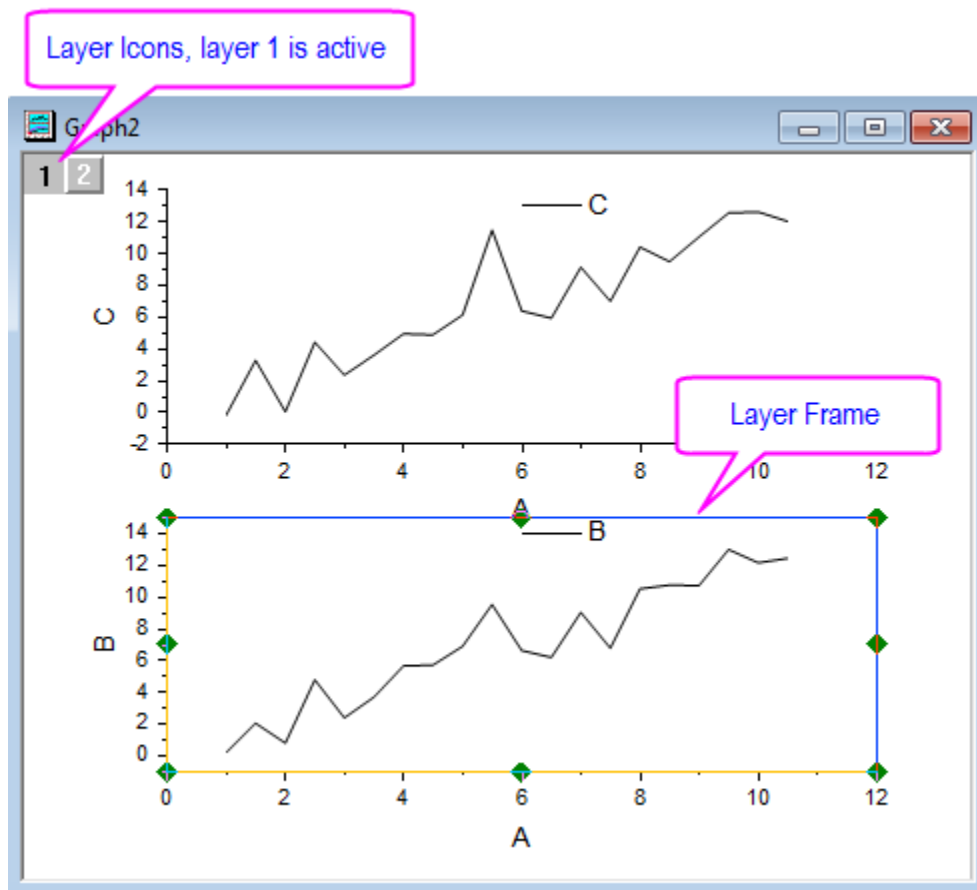

3. To rearrange these two layers, with the graph window active, select the menu item **Graph: Layer Management** to bring up the dialog. Activate the **Arrange** tab, on the middle panel. Enter 2 in the *Column* edit box. Enter 1 in the *Row* edit box and click the **Apply** button. After you click the **OK** button,

the graph layers are arranged horizontally.

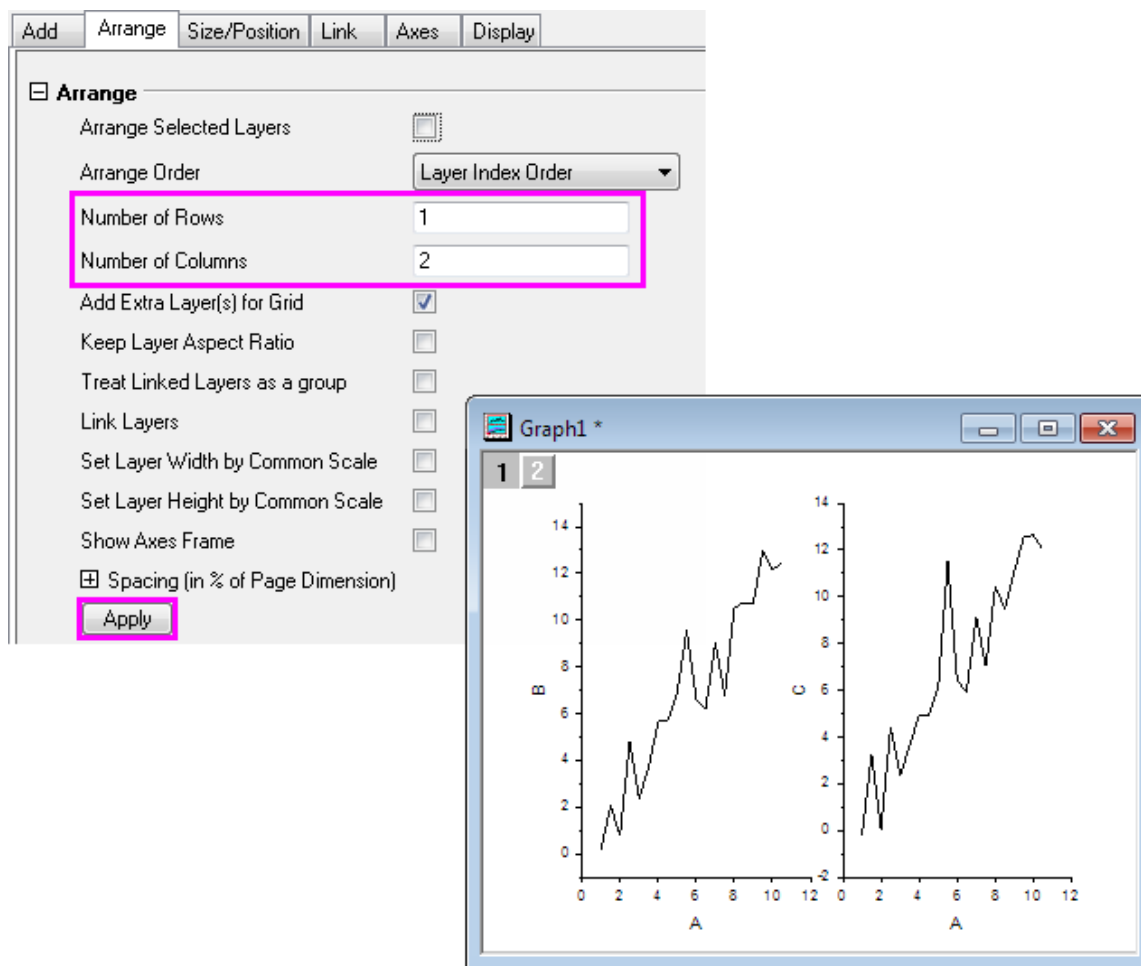

Most often you will use the worksheet for tabulating and manipulating your data, while you will use the graph window for plotting your data.

#### 3.2.4.4 Matrix

The Origin matrix window is a container for one or more Origin matrices. Each matrix window contains one or more matrix sheets, and each matrix sheet can contain one or more matrix objects. The matrix object itself, is a vector of Z values. These Z values are related to one another in the X and Y dimensions by their relative row and column positions in the matrix. Matrices are a precursor to constructing Origin's 3D graph types such as contour graphs and color-mapped surfaces, and since they are used in depiction and manipulation of 3D data, they are used by Origin in image processing and analysis. We will show you how to use the Origin Matrix to create a 3D plot in a [later tutorial](#).

### 3.2.5 Toolbars

The Customize Toolbar dialog box handles displaying or hiding toolbars and toolbar buttons.

1. Select **View: Toolbars** from the Origin menu. The **Customize Toolbar** dialog opens.
2. Check the box next to **Column**. This toolbar now appears in the workspace.
3. Make the **Button Groups** tab active.
4. Scroll to select **AutoUpdate** in the Groups list.



5. Click and drag the one button which appears in this group and drop the button next to the green version of this button without the red line, on the **Standard Toolbar**. You can drag buttons back and forth.
6. Click **Close**.

All these toolbars may be dragged away from their docked positions to become floating windows. Floating windows have additional controls besides the X to hide a window. A **push-pin** control can allow or prevent docking and a minimize button can roll-up a window to save space and restore the window when it is needed.

### 3.2.5.1 Toolbar Reference

Below are the most commonly used toolbars.

#### Standard Toolbar



#### Worksheet Data Toolbar



#### Graph Toolbar



#### Format Toolbar

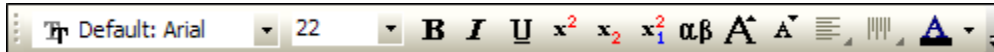

#### Style Toolbar



#### Tools Toolbar (vertical on the left side of the Origin workspace)



#### 2D Graphs Toolbar

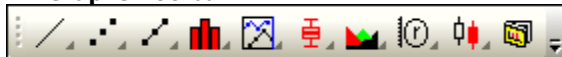

#### 3D and Contour Graphs Toolbar

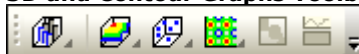

#### Mask Toolbar



## 3.2.6 Project Explorer

**Project Explorer** is a tool to help you organize your Origin data. It is particularly useful if you are working with a project that contains numerous child windows. Use Project Explorer to develop a folder structure to organize the child windows in your project.

### 3.2.6.1 Open/Close Project Explorer

When you first start Origin, Project Explorer displays docked to the edge of the workspace. You can dock it to any other edge or float it in the workspace. Because Project Explorer uses some of your workspace, you may want to close Project Explorer, even if you have already created a folder structure. To close/open Project Explorer, click the **Auto Hide** button to pin the **Project Explorer**, then press **Alt + 1** or select menu item **View: Project Explorer**.

### 3.2.6.2 Change the Display Properties of Project Explorer

The project explorer can be auto-hidden, hidden, floating or docking. In another aspect, it has vertical and horizontal alignment.

1. Select **Customizing Graphs.opj** in <Origin EXE Folder>\Samples\Graphing folder.
2. By default the **Project Explorer** is auto hidden, move mouse over to the **Project Explorer** bar in the left of work space to expand it.
3. Click the **Auto Hide** button to pin the **Project Explorer**, so it will be always displayed.

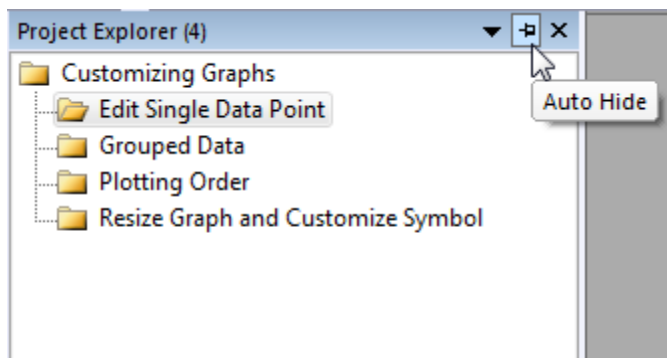

4. Select the **Window Position** drop-down and select **Floating** to make the Project Explorer float over the work space, and you can freely move its position:

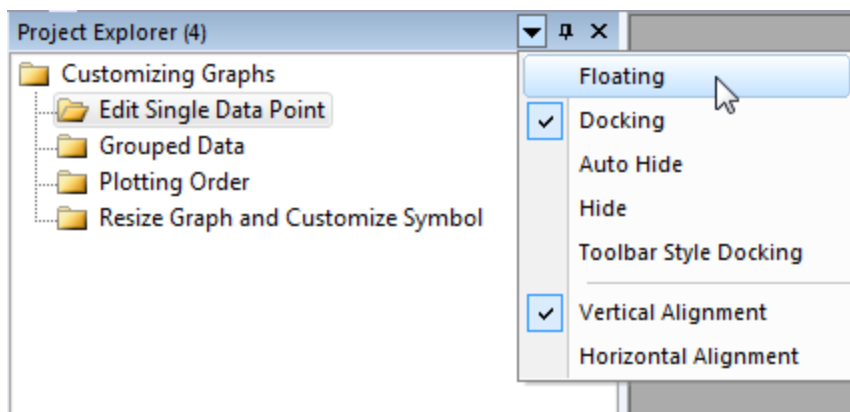

5. Right click on the title bar of the floating Project Explorer and select **Horizontal Alignment:**

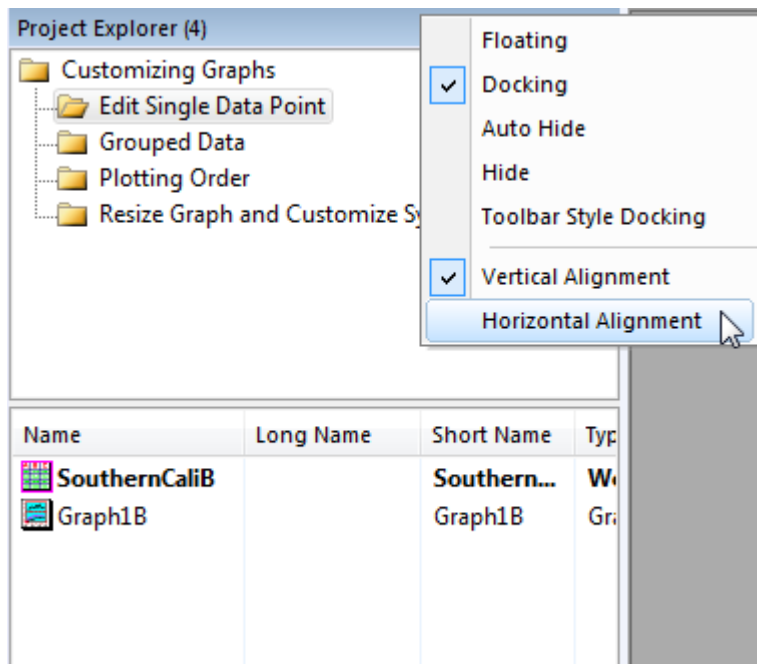

Note: Other dockable windows (Object Manager, Apps, Message Log, Smart Hint Log, etc.) have the similar controls to change the display properties.

### 3.2.6.3 Browse Origin windows in Project Explorer

There are two panels in Project Explorer: the folders panel and the contents panel, which displays all objects in the active folder. When you start a new Origin session, you can click the new workbook , new graph or new matrix button to create some blank windows, and then you can see these window's icons in the contents panel. Double-click the icon to hide/view the window.

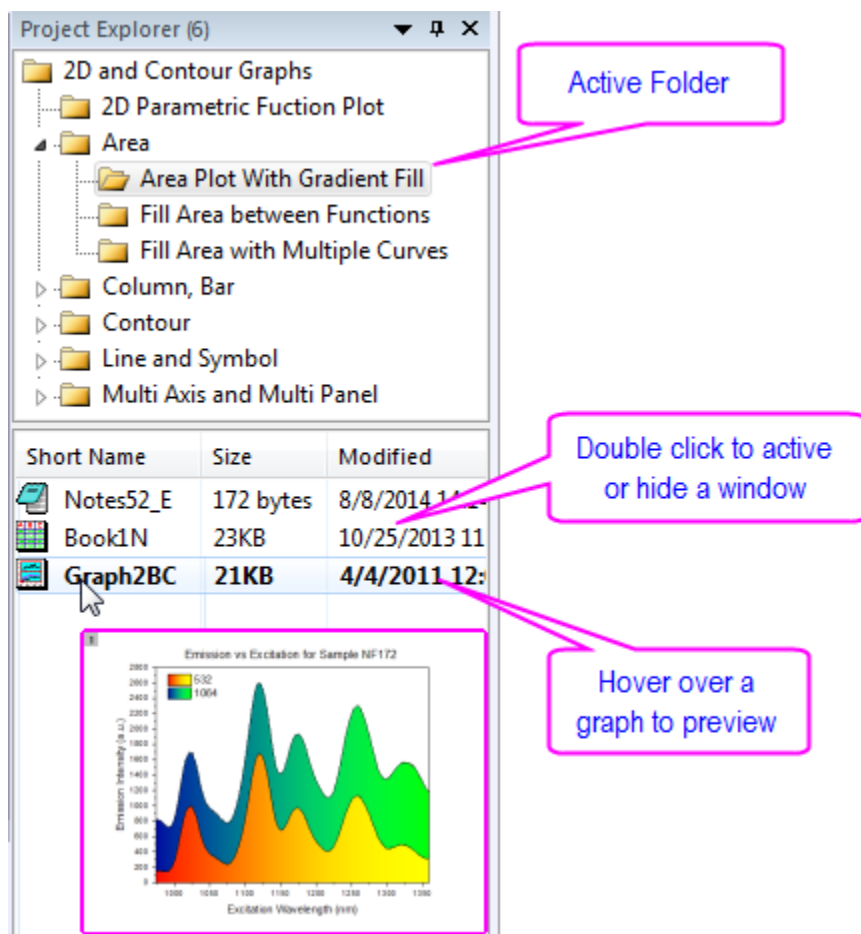

### 3.2.6.4 Add a Sub Folder in Project Explorer

To create a new folder, right-click on the project folder (or a subfolder) in the folder panel, and select **New Folder** from the shortcut menu.

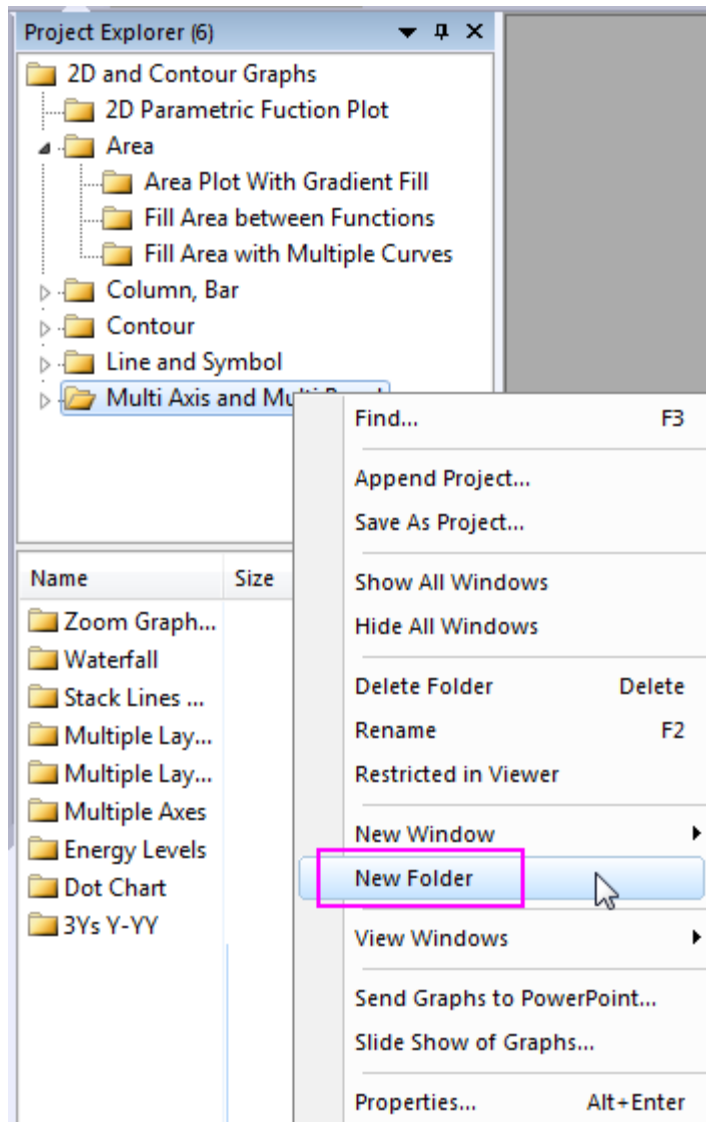

Once you have created one or more subfolders, you can move child windows between folders by dragging & dropping them within the Project Explorer workspace.

### 3.2.7 Object Manager

Object Manager provides a hierarchy structure to help you view and manipulate layers and plots in the active graph window. It is particularly useful if the graph contains multi-layers and each layer contains multi-plots.

#### 3.2.7.1 Open/Close Object Manager

When you first start Origin, Object Manager is docked to the right edge of the workspace. Like Project Explorer, you can dock it to any other edge or float it in the workspace. To close/open Object Manager, select menu item **View: Object Manager**.

#### 3.2.7.2 Manipulate layers and plots in Object Manager

Object Manager works interactively with active graph window. Selecting layer or plot in graph window will highlight the corresponding item in Object Manager and vice versa. This makes it very easy to select an item and then show or hide it.

For example, try the following:

1. Select **Help: Learning Center** menu or press **F11** key to open **Learning Center**. Select **Graph Sample** in the left side of dialog, choose **Multiple Panel** for **Samples in** drop-down list. Double-click on *Multiple Panel by Column Label* thumbnail to open the sample graphing project.
2. Select any plot object (such as a layer, a plot group or a curve) in graph window, the corresponding items will be highlighted in Object Manager. Select items in Object Manager, the corresponding object will be highlighted in the graph window.
3. In Object Manager, Uncheck the checkbox before the plot *Trail Run 1* of Layer1 to hide this plot.
4. Right click on the plot *Trail Run 2* of Layer1 and select **Hide Plots with Same Name** to hide all plots named *Trail Run 2*.
5. Right click on the plot *Trail Run 2* of Layer1 again and select **Show All Plots**. All *Trail Run 2* plots are back.

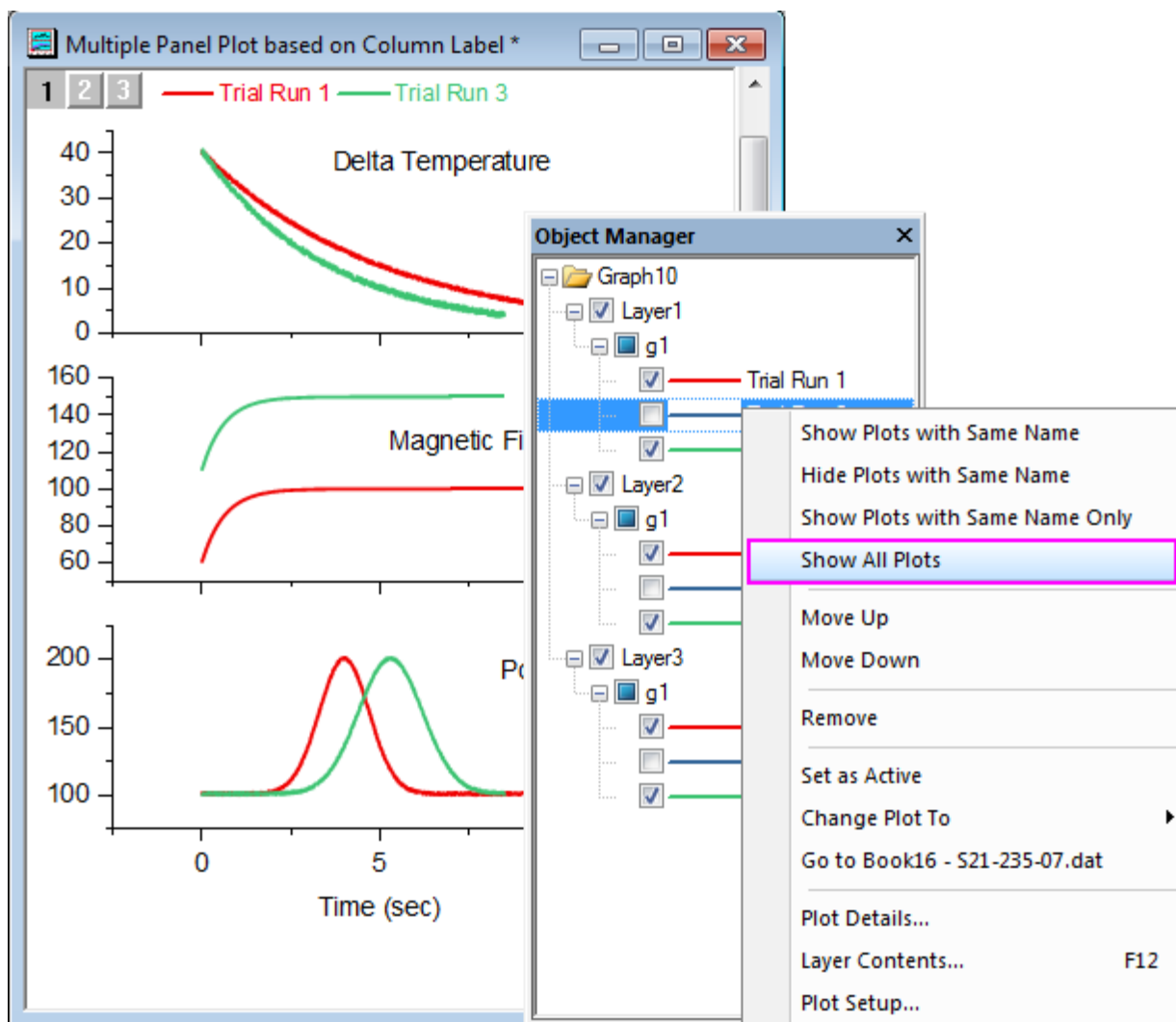



The plot names in Object Manager is the Auto Legend Translation mode set in the graph. Therefore same name or not depends on what the legend translation mode is used.

Besides using Object Manager to turning on or off layers or plots, it can also be used to:

- Change plot orders by right clicking on a plot and selecting **Move Up/Move Down**
- Change plot type by right clicking on a plot and selecting **Change Plot To**
- Go to source workbook/matrix book by right clicking on a plot and selecting **Go to xxx**
- Double click on an item to open corresponding node in Plot Details dialog for further customization or use context menu to open Useful dialogs.

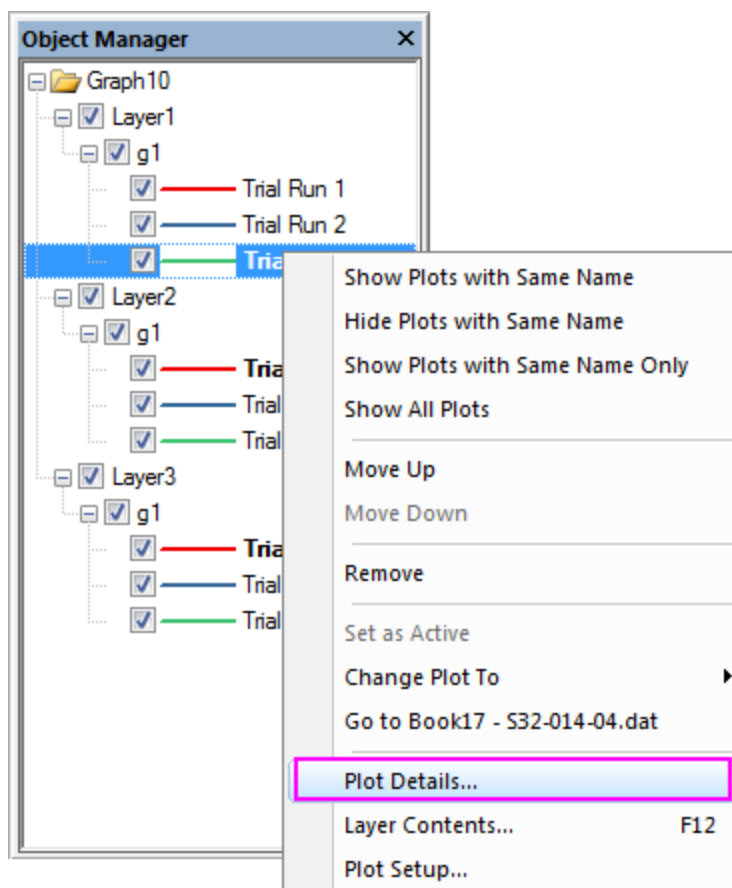

### 3.2.8 Apps

**Apps** are custom applications for Origin that perform specific graphing and/or analysis tasks. Apps are not pre-installed with Origin. If you want to get an App, you can

- Browse to our [File Exchange](#) page of the OriginLab website, search and download the app you desired to install.

- Open **App Center**(by selecting **Help:App Center**, or pressing **F10** key, or clicking the **Add Apps** button that appears on all tabs of the Apps Gallery), browse available Apps, search for Apps using keywords and phrases, and install or update Apps with a single click.

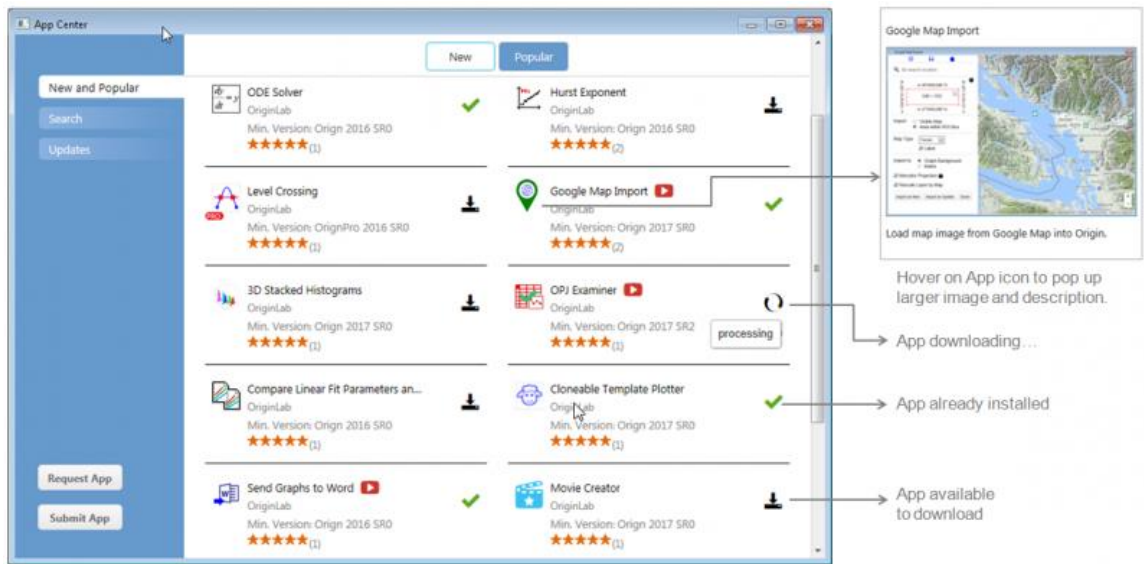

Browse for Apps, search using keywords or phrases, and install or update Apps with a single click.

When Apps get installed, they will be visible in the **Apps Gallery** window of the Origin interface.

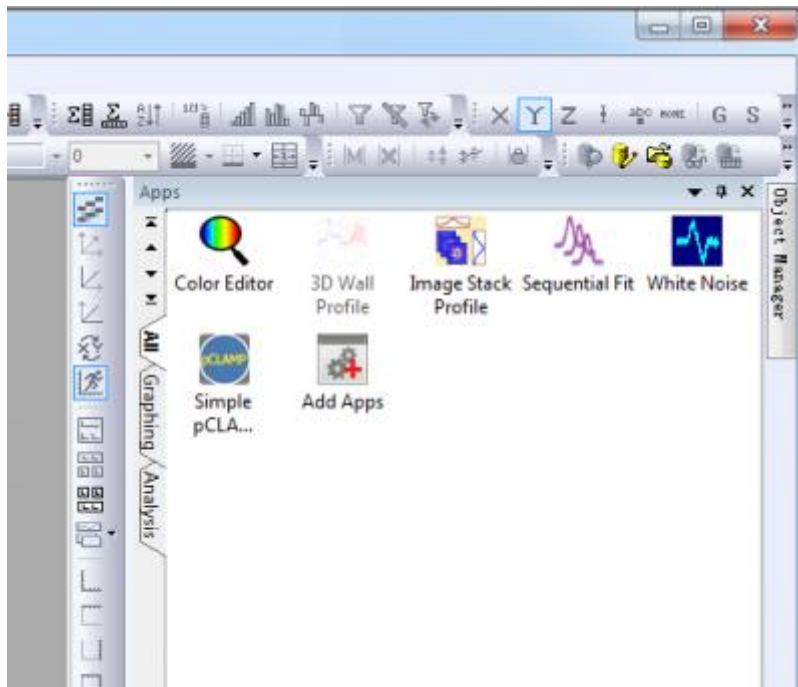

In the **Apps** panel, you can add new tabs from the context menu and then classify these installed APPs by putting them to different tabs, see "Graphing", "Analysis" tab in the above APP Gallery. All Apps will be presented in the **All** tab in the order of their installation times.



Each installed App will be displayed as an icon in the gallery window. You can simply click on the icon to launch the App and right-click on the icons for other options such as hiding, uninstalling the App or movement between the tabs.

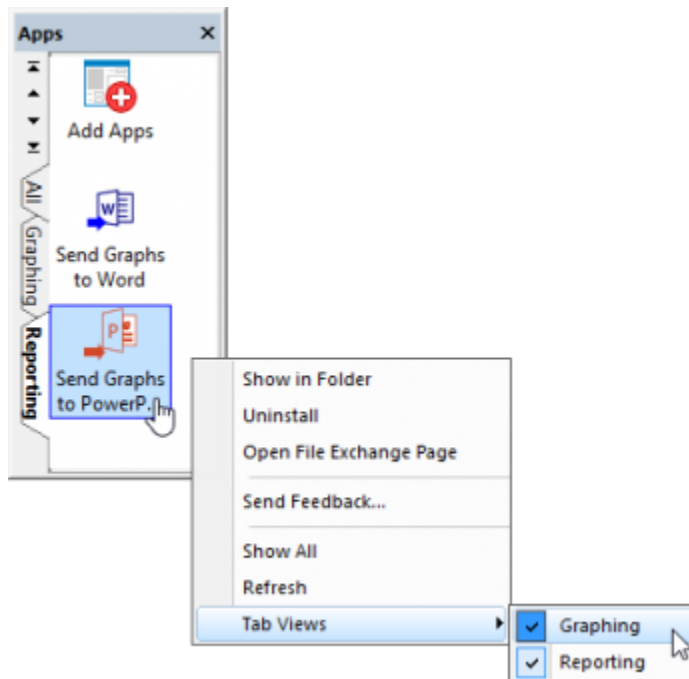

### 3.2.9 Learning Center

[Learning Center](#) dialog helps you get started with Origin easily. You can select **Help: Learning Center** from Origin menu or press F11 key to open it.

With this dialog, you can

- Open Graph and Analysis Samples
- With the Learning Sources, get started with Origin
- Transfer User Files

### 3.2.10 Messages Log

The **Messages Log** window shows messages about operations including Output Information, Results and Errors. It displays messages that are not sent to the Script Window or the Command Window. To close/open **Messages Log**, press **Alt + 6** or select menu item **View: Messages Log**.

1. Open a new workbook, highlight the A(X) and B(Y) columns, right-click and choose **Fill Columns With: Row Numbers** from the shortcut menu.
2. Highlight the columns and from the Main Menu, choose **Plot: 2D: Line: Line**. A simple line plot is drawn.
3. Select **File: Export Graphs...** from the main menu to open the **ExpGraph** dialog. In this dialog, keep the default settings and click **OK** to export the graph.
4. The Output Information is reported to the **Messages Log** window.



## 4 Data Analysis

### 4.1 Data Analysis

#### 4.1.1 Gadgets

- [Global Vertical Cursor](#)
- [Integrate Gadget](#)
- [Curve Intersection Gadget](#)
- [Rise Time Gadget](#)
- [Interpolate Gadget](#)
- [Cluster Gadget](#)
- [Quick Fit Gadget](#)
- [Quick Peaks Gadget](#)
- [Quick Sigmoidal Fit Gadget](#)
- [Using Multiple Gadgets](#)

#### 4.1.2 Curve Fitting

##### 4.1.2.1 [Linear and Polynomial Fitting](#)

- [Linear Fitting and Outlier Removal](#)
- [Linear Fit for Kinetic Models](#)

##### 4.1.2.2 [Nonlinear Fitting](#)

- [Nonlinear Curve Fit Tool](#)
- [Nonlinear Fitting with System Function](#)
- [Global Fitting with Parameter Sharing](#)
- [Global Fit for Different Functions with Shared Parameters](#)
- [Parameters Initialization using LabTalk in NLFit](#)
- [User Defined Fitting Function](#)
- [Fit Surface with User Defined Function](#)
- [Fitting One Dataset as a Function of Other Datasets](#)
- [Fitting With Multiple Independent Variables](#)
- [User Defined Fitting Function using GNU Scientific Library](#)
- [Fitting with NAG Special Function](#)
- [Fitting Integral Function with parametric limit using NAG Library](#)

- [Fitting with Integral using NAG Library](#)
- [Fitting with Integral using LabTalk Function](#)
- [Fitting with Two Integrals using LabTalk Function](#)
- [Fitting with Summation](#)
- [Fitting Complex Function](#)
- [Fitting with Convolution](#)
- [Quoting Built-in Functions in Your New Function](#)
- [Fit Function with Non-constant Background](#)
- [Fitting with Piecewise Functions](#)
- [Fit Curve Through Certain Points](#)
- [Distribution Fit with the Probability Density Function and Cumulative Distribution Function](#)
- [Fitting Integral Function with a Sharp Peak](#)
- [Fitting with a Piecewise Linear Function](#)
- [Fitting with an Ordinary Differential Equation](#)
- [Fitting with Convolution of Two Functions](#)
- [Parameter Initialization for Rational Functions](#)
- [Surface Fitting with Multiple Peaks](#)
- [Nonlinear Multiple Variables Fitting](#)
- [Modifying Derived Parameters in Build-in Functions](#)
- [Fit Multiple Datasets by Fitting One and then Using Those Fit Parameters for Other Datasets](#)
- [Implicit Fitting with Three Variables](#)
- [Nonlinear fitting using Orthogonal Distance Regression](#)

### 4.1.3 Signal Processing

- [FFT and IFFT](#)
- [FFT Filter](#)
- [Smoothing](#)
- [STFT \(Short-Time Fourier Transform\)](#)
- [IIR Filter](#)
- [2D FFT and Filter](#)
- [Convolution](#)
- [Wavelet](#)
- [Coherence and Correlation](#)
- [Decimation and Signal Envelope](#)
- [Rise Time](#)
- [Sound Processing](#)

#### **4.1.4 Peak Analysis**

4.1.4.1 [Create and Subtract Baseline with Peak Analyzer](#)

4.1.4.2 [Batch Peak Analysis Using Theme with Script Before Each Process](#)

4.1.4.3 [Combine Quick Peaks Gadget with Peak Analyzer](#)

4.1.4.4 [Peak Finding](#)

- [Picking and Marking Peaks](#)

4.1.4.5 [Peak Integration](#)

- [Integrating Peaks](#)

4.1.4.6 [Peak Fitting](#)

- [Peak Fitting with Baseline](#)
- [Peak Fitting with Preset Peak Parameters](#)
- [Setting the Fix, Share Status or Bounds for Multiple Peak Parameters Simultaneously](#)

#### **4.1.5 Data Manipulation**

4.1.5.1 [Setting Column Values](#)

- [Set Column/Cell Values](#)

4.1.5.2 [Worksheet Data Operations](#)

- [Worksheet Query](#)
- [Data Reduction](#)
- [Data Filter](#)
- [Lock Filter with Analysis](#)

4.1.5.3 [Pivot Table](#)

4.1.5.4 [Categorical Values Ordering and Sharing](#)

#### 4.1.6 Analysis Templates

- [Creating and Using Analysis Templates](#)
- [Creating Analysis Templates using Set Column Value](#)
- [Creating a Custom Report Sheet](#)

#### 4.1.7 [Analysis Themes](#)

#### 4.1.8 Batch Processing

- [Batch Processing Multiple Datasets](#)
- [Batch Processing Multiple Files using Analysis Template](#)
- [Batch Processing with Summary Report in External Excel File](#)
- [Batch Processing with Word Template for Reporting](#)
- [Batch Processing Grouped Datasets Using Analysis Template with Multi-Data Sheets](#)

## 4.2 Gadgets

### 4.2.1 Gadgets

- [Global Vertical Cursor](#)
- [Integrate Gadget](#)
- [Curve Intersection Gadget](#)
- [Rise Time Gadget](#)
- [Interpolate Gadget](#)
- [Cluster Gadget](#)
- [Quick Fit Gadget](#)
- [Quick Peaks Gadget](#)
- [Quick Sigmoidal Fit Gadget](#)
- [Using Multiple Gadgets](#)

### 4.2.2 Global Vertical Cursor

#### 4.2.2.1 [Summary](#)



The Vertical Cursor gadget can be used to read X and Y coordinate values for data points in stacked panel plots or contained in multiple graphs simultaneously.

#### 4.2.2.2 [What You Will Learn](#)

This tutorial will show you how to:

- Use the vertical cursor gadget to read XY coordinates for multiple graphs and output the results.
- Link/Unlink graphs when using the vertical cursor gadget.
- Move or relocate the cursor line among the linked graph windows.

#### 4.2.2.3 Steps

1. Open Origin and choose **Data: Import from File: Import Wizard**. For the **Data Source**, browse to *<Origin Folder>/Samples/Curve Fitting* and add the **Step01.dat** and **Step02.dat** files. The import filter **Data Folder:Step** is automatically selected. Set **Import Mode** to **Start New Books**.
2. Click the **Next** button, navigate to the **File Name Options** page, clear the check box before **Rename Long Name for Book Only**, then click the **Finish** button to import both files into two workbooks, and the columns will be designated XY XY by the import filter.
3. Click the **New Folder** button  on the **Standard** toolbar to create a new file folder in this project, this folder should be open and named as Folder 2.
4. While Folder 2 is open, click the **Import Wizard** button  on the **Standard** toolbar to import **Step03.dat** file also under the path *<Origin Folder>/Samples/Curve Fitting* similar to steps 1 and 2.
5. Go to Folder 1 in **Project Explorer**, activate the workbook with long name **Step01.dat** and highlight the whole worksheet. Select **Plot:Multi-Panel:Stack** from the menu item to open the **Plotstack** dialog.
6. Under the **Plot Assignment** branch, enter **3** for **Number of Plots in Each Layer**, accept other settings as default and click **OK** to create a stacked graph.
7. Similarly create two other stacked graphs for the other two workbooks. So now we have Graph1, Graph2, and Graph3 for workbooks Step01.dat, Step02.dat and Step03.dat respectively.
8. Activate Graph1 and choose **Gadgets:Vertical Cursor** to open the **Vertical Cursor** dialog.

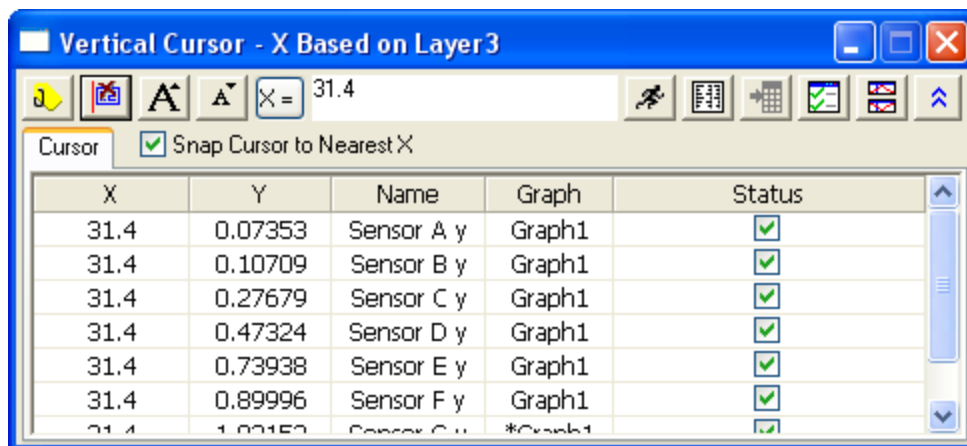

9. Click the **Link/Unlink Graphs** button  in this dialog and open the **Graph Browser**, you can choose whether to link or unlink a graph to the current active graph.

10. Select Graph2 and Graph3 in the left panel and click the  button to add the two graphs as linked graphs to Graph1. Click **OK**.

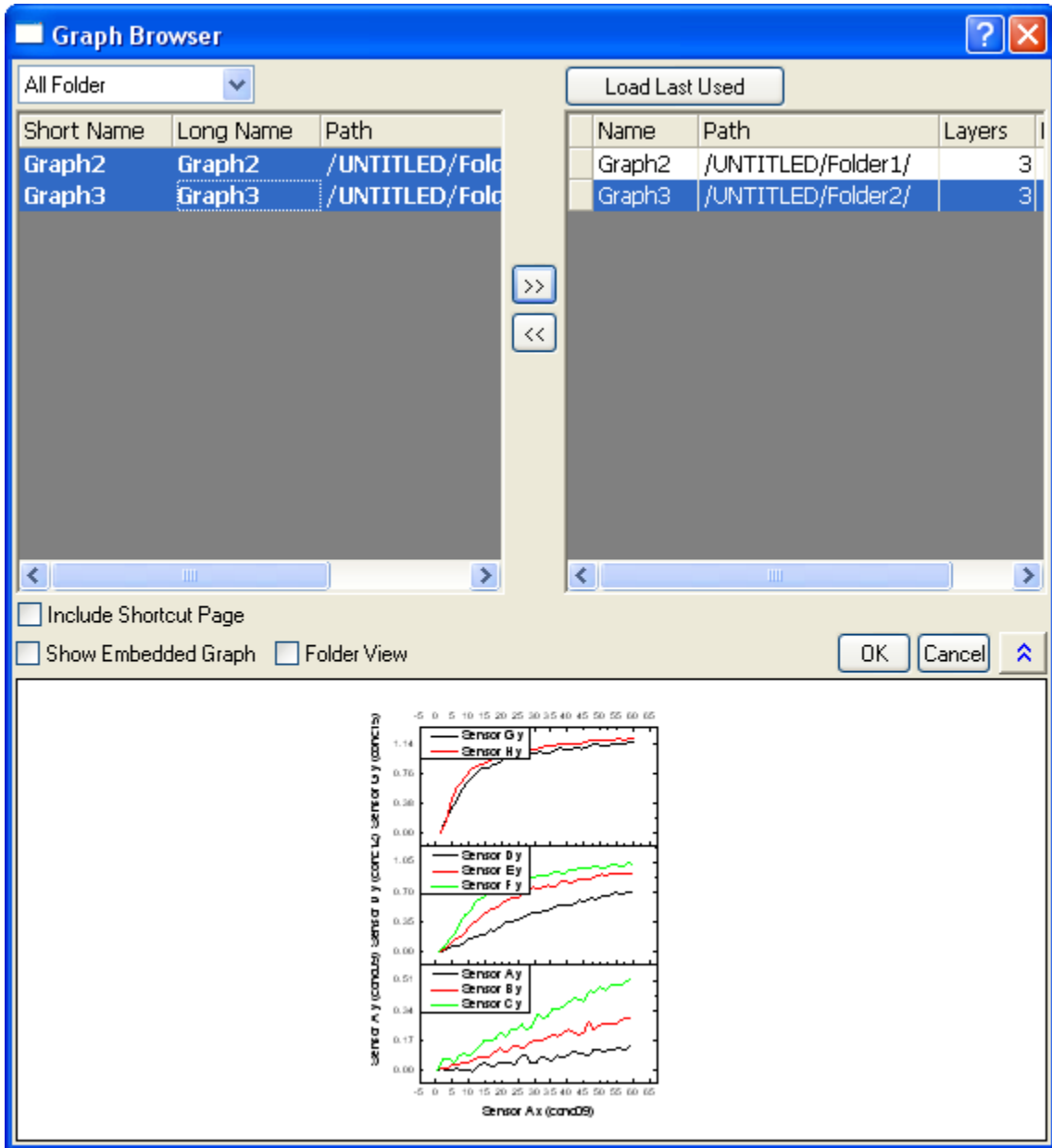

**Note:** You can also unlink graphs in this dialog by using the  button to remove a graph from the right panel.

On the upper right-hand corner of each linked graph, a  icon appears to indicate that it belongs to a group of linked graphs.

11. Make sure Graph1 is active and the **Vertical Cursor** dialog is open, the asterisk before the graph name marks the current active plot on which the cursor is on. Enter **25** as the X value, uncheck the







box before **Snap Cursor to Nearest X** and click the **Move Cursor to X** button  to read the data points in each plot when X=25.

Vertical Cursor - X Based on Layer 3 - 2 linked graphs

Cursor  Snap Cursor to Nearest X

X	Y	Name	Graph	Status
25	0.05595	Sensor A y	Graph1	✓
25	0.10394	Sensor B y	Graph1	✓
25	0.21568	Sensor C y	Graph1	✓
25	0.39314	Sensor D y	Graph1	✓
25	0.67007	Sensor E y	Graph1	✓
25	0.81397	Sensor F y	Graph1	✓
25	0.99419	Sensor G y	*Graph1	✓
25	1.04738	Sensor H y	Graph1	✓
25	0.06279	Sensor A y	Graph2	✓
25	0.13419	Sensor B y	Graph2	✓
25	0.24344	Sensor C y	Graph2	✓
25	0.37798	Sensor D y	Graph2	✓
25	0.63732	Sensor E y	Graph2	✓
25	0.8559	Sensor F y	Graph2	✓
25	0.97876	Sensor G y	Graph2	✓
25	1.02927	Sensor H y	Graph2	✓
25	0.04517	Sensor A y	Graph3	✓
25	0.08923	Sensor B y	Graph3	✓
25	0.20779	Sensor C y	Graph3	✓
25	0.38576	Sensor D y	Graph3	✓
25	0.63895	Sensor E y	Graph3	✓
25	0.83746	Sensor F y	Graph3	✓
25	0.96896	Sensor G y	Graph3	✓
25	1.03511	Sensor H y	Graph3	✓

12. Click the **Add Tag and Label** button  to add tags at X=25 for all linked graphs.
13. Click the **Output Report** button ; or press "O" on your keyboard. Then click the **Go to Report Worksheet** button  to generate and open the results worksheet. The XY coordinates of all plots in linked graphs are listed in the report sheet. Each time you click the button or hotkey, a new row of data will be output to the result sheet.
14. Activate Graph2, click on the  icon and select **Move Cursor Line here**, the cursor line will be moved to Graph2.
15. In the **Vertical Cursor** dialog, double click any row of **Graph3** to activate its graph window. Select the previously added tag, press the **Delete** key to delete the tag, click on the  icon and select **Go to**

**Cursor Line Window** to go back to Graph2 where the cursor is currently on. You can see that the tags in linked graphs are deleted.

### 4.2.3 Integrate Gadget

#### 4.2.3.1 Summary

The Integrate Gadget performs numerical integration on a data plot to calculate the area under the curve. You can select an arbitrary range of the data plot using the region of interest (ROI) object overlaid on the plot.

#### 4.2.3.2 What you will learn

- How to easily integrate a segment of data plot under the rectangular region.
- How to specify the integration limits and baseline.
- How to display the integral curve inside the ROI and calculate quantities including: peak area, peak height, peak center, and FWHM.

#### 4.2.3.3 Integrate and output the quantities

1. Start with a new workbook and import the Origin sample data *Multiple Peaks.DAT* which is located in *<Origin Program Folder> \Samples\Curve fitting*.
2. Highlight the Col(C) and select **Plot>2D: Line: Line** from the Origin menu to draw a graph.

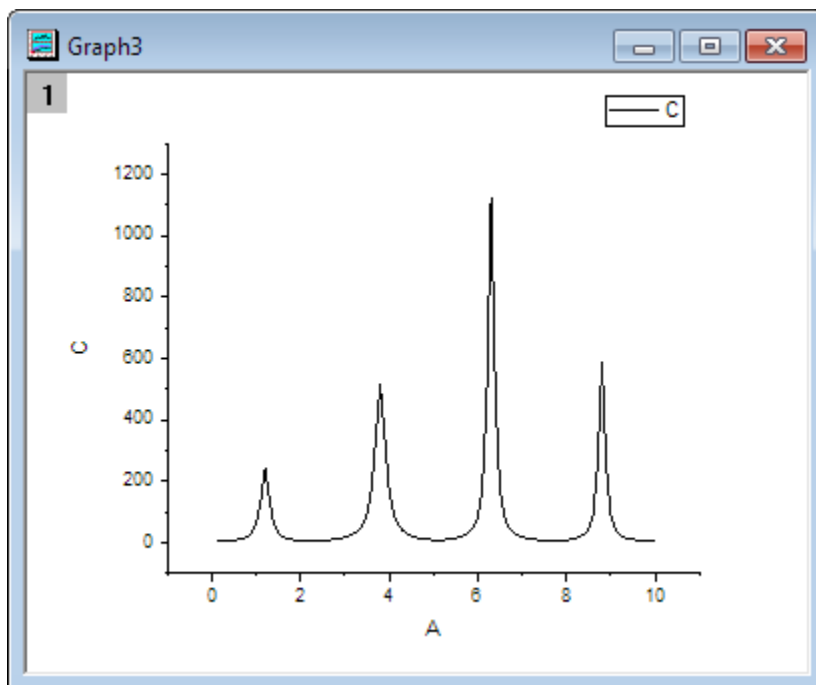

3. Select **Gadgets: Integrate** from the Origin menu when a graph is active, to bring up the **Integrate: addtool\_curve\_integ** dialog box.  
In **Integration** tab, choose **Restrict to Rectangle** in the **Integral Curve** drop-down list to plot the

integral curve within the rectangle.

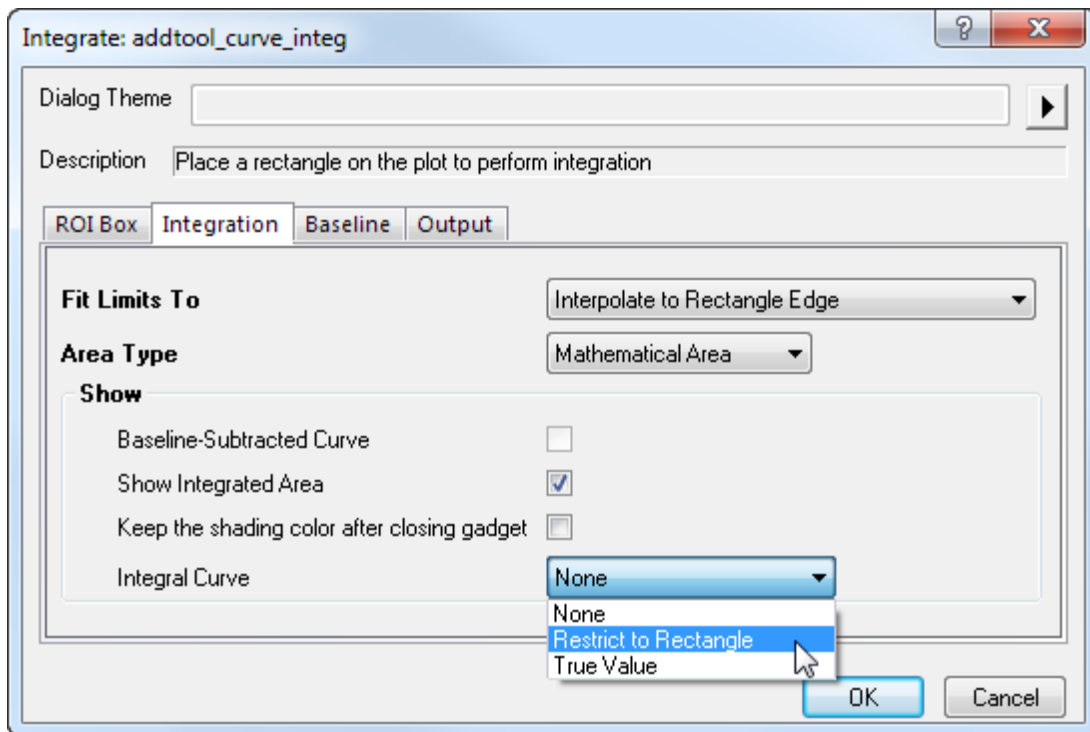

4. Click **OK** button. You will see that a yellow rectangle and a blue integral curve are added to the plot. The integral area is filled with gray, and the value is shown at the top of the rectangle.

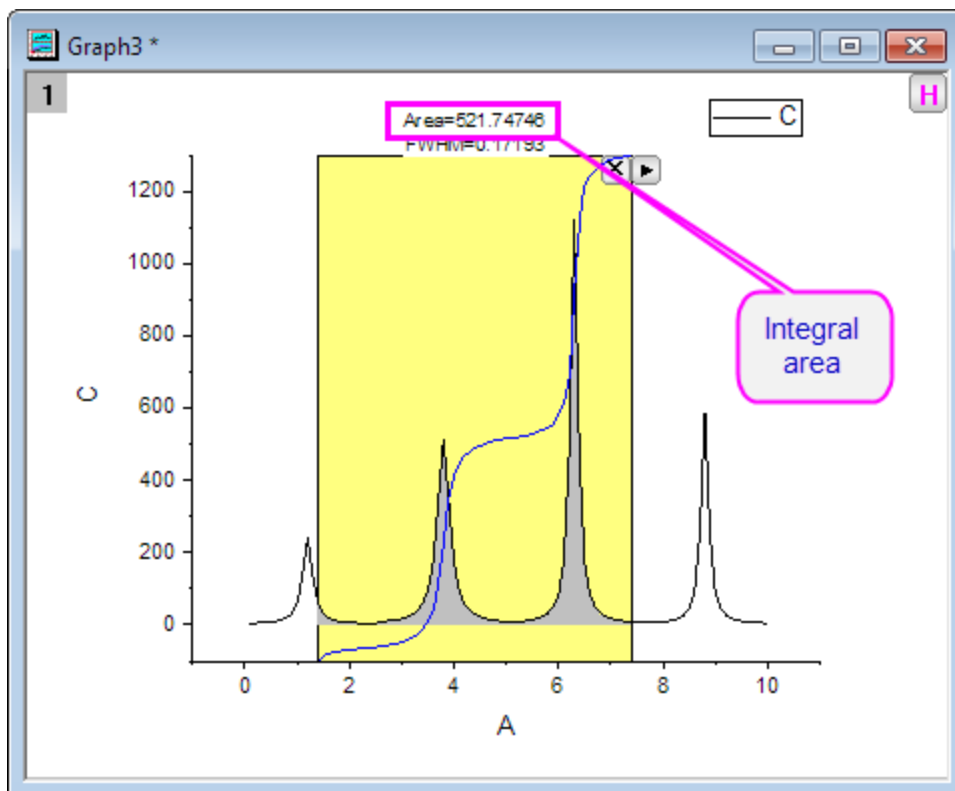

5. Move the yellow region of interest rectangle to set the region for the single peak you want to integrate.

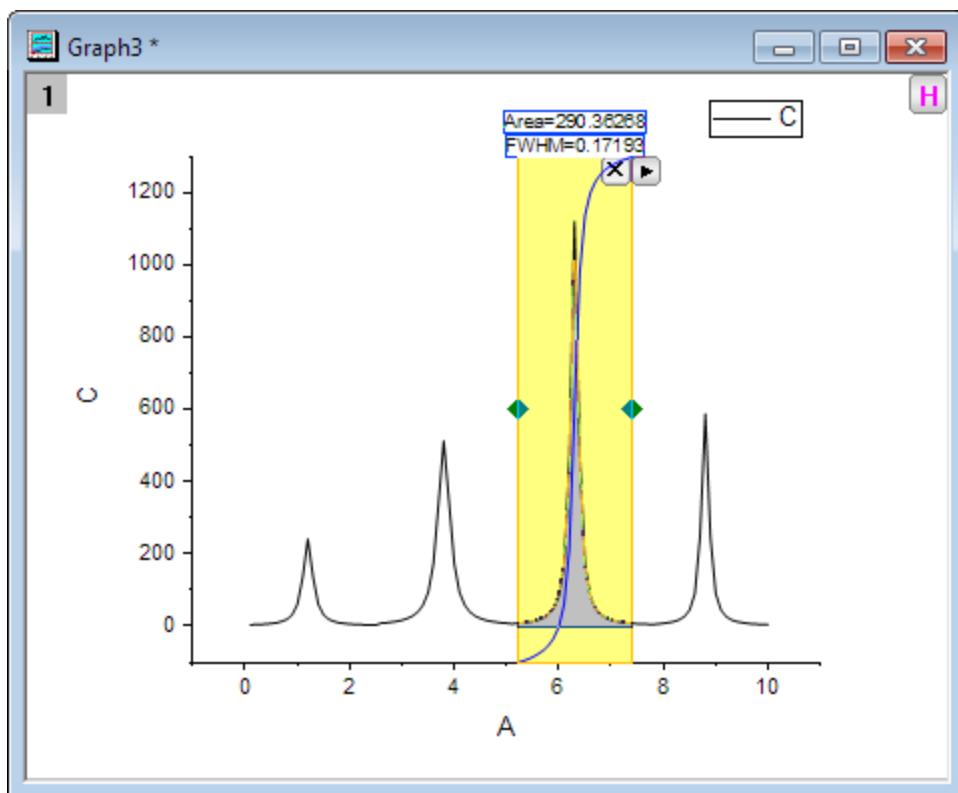

- Click the triangle button  at the top right corner of the ROI tool to open the fly-out menu and choose **New Output**. Then the **Gadget Integration Results** will display in the **Script Window**.

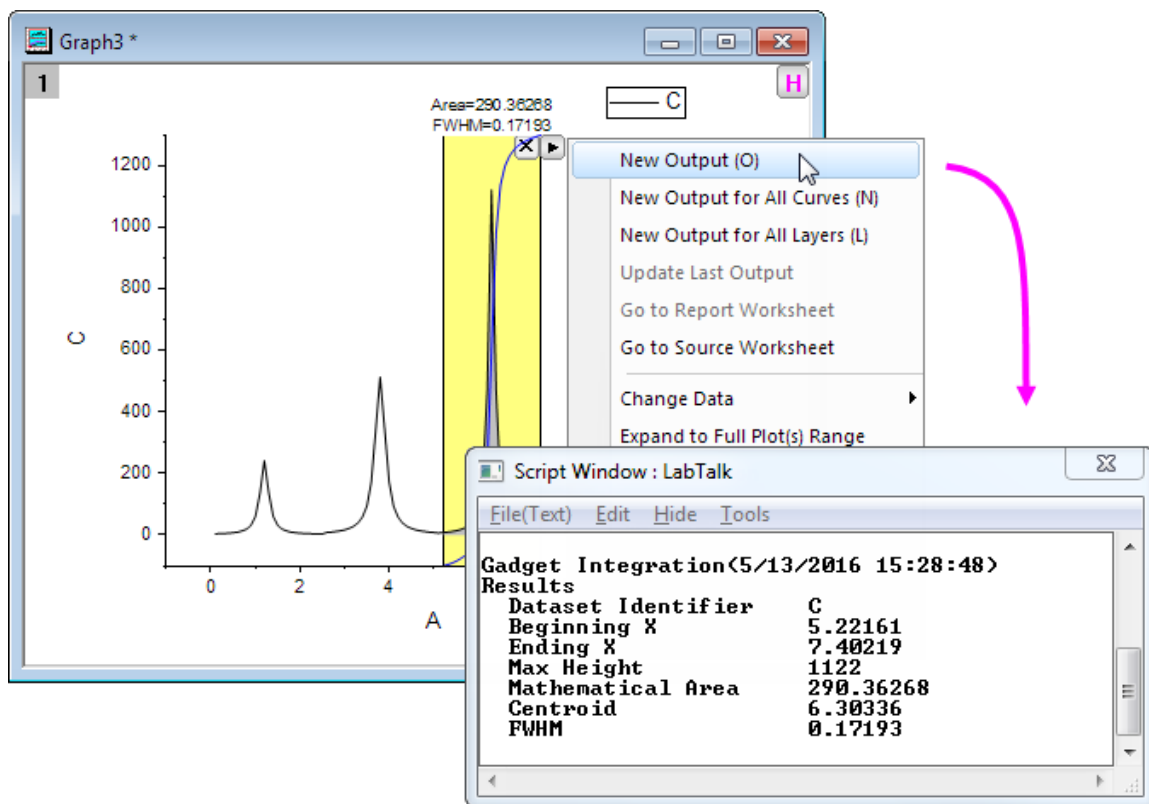

#### 4.2.3.4 Integrate with a data plot baseline

- Start with a new workbook and import the file *<Origin Program Folder>\Samples\Spectroscopy\ Peaks with Base.DAT*

- Highlight Col(B) and Col(C) and select **Plot>2D: Line: Line** from the Origin menu to draw a graph.

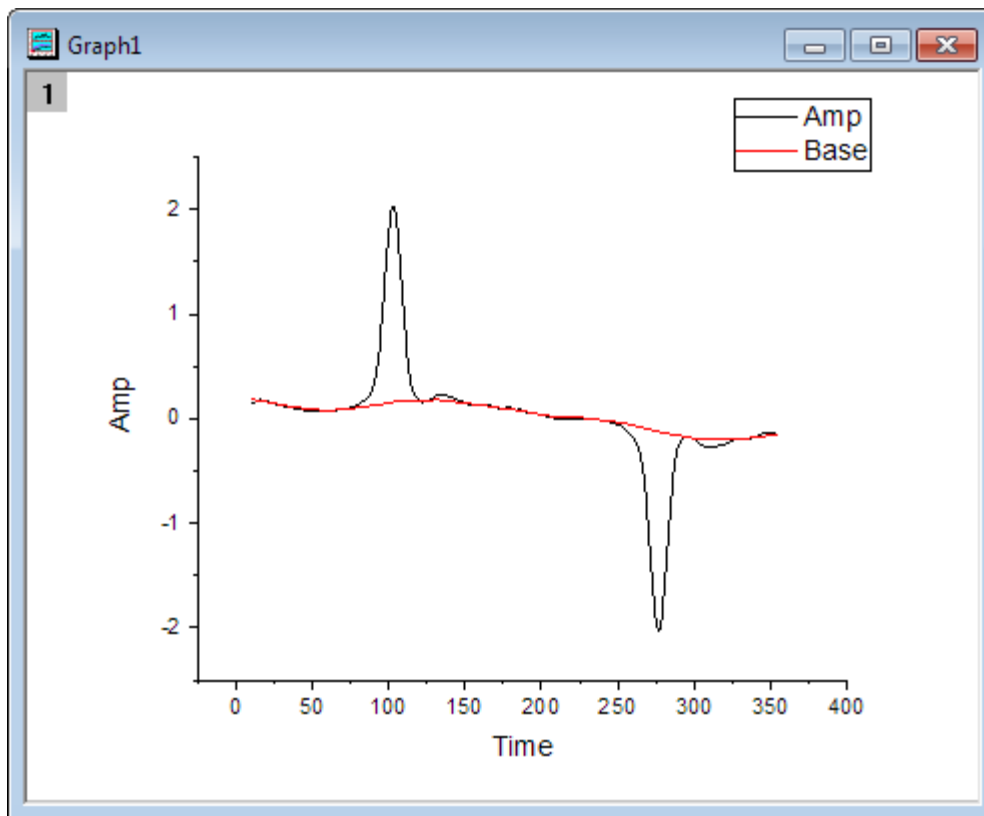

- Select **Gadgets: Integrate** from the Origin menu when a graph is active, to bring up the **Integrate: addtool\_curve\_integ** dialog box.
- In **Baseline** tab, choose **Use Existing Dataset** for the **Mode**. Then select *Plot(2): Base* as **Dataset** and click **OK** button.

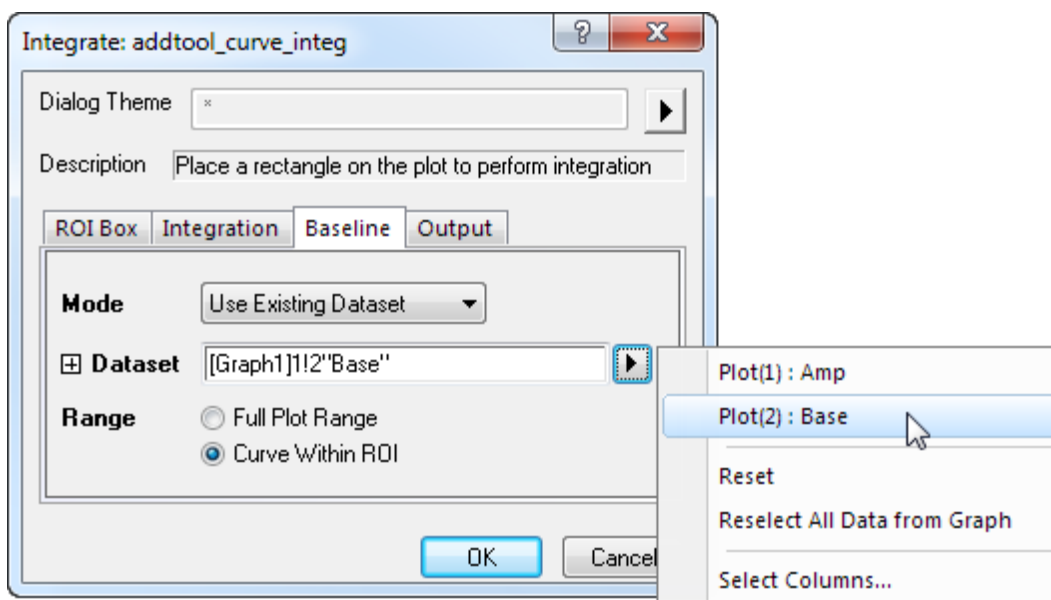

- Click the triangle button  and select **Expand to Full Plot(s) Range** in the fly-out menu to integrate the whole range of the curve starting from the baseline.

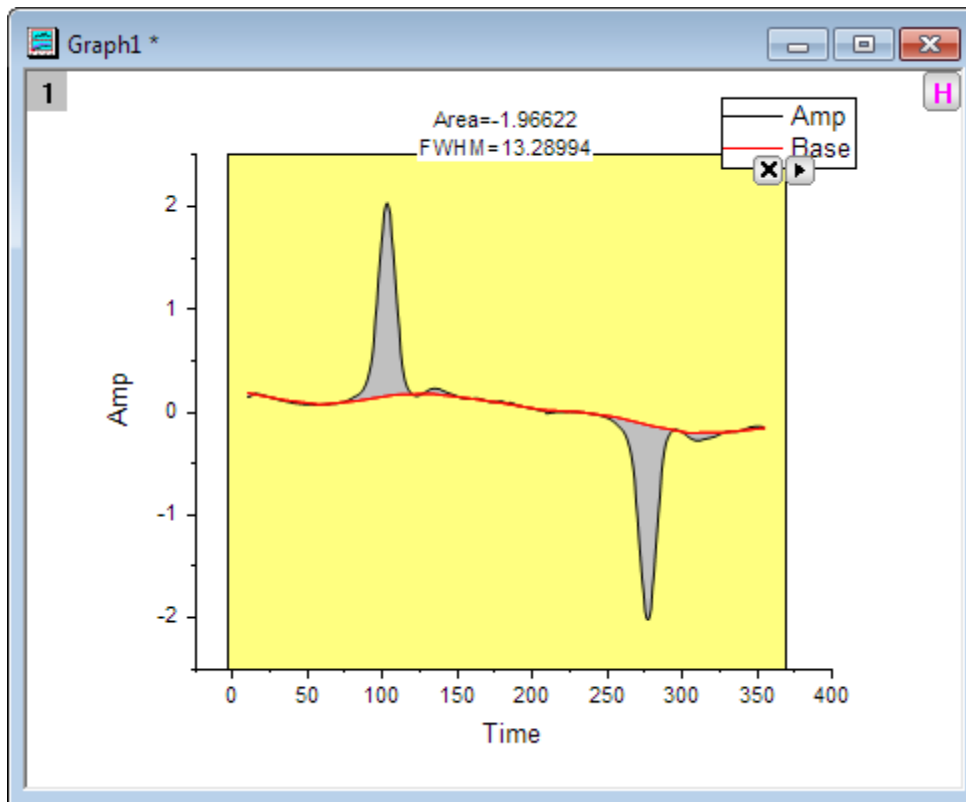

- Select **New Output** from the fly-out menu to output the results to the script window.



Some gadgets operate on a single curve at a time, but you can repeat your analysis for other curves by clicking on the fly-out menu and choosing **New Output for All Curves** or **New Output for All Layers**.

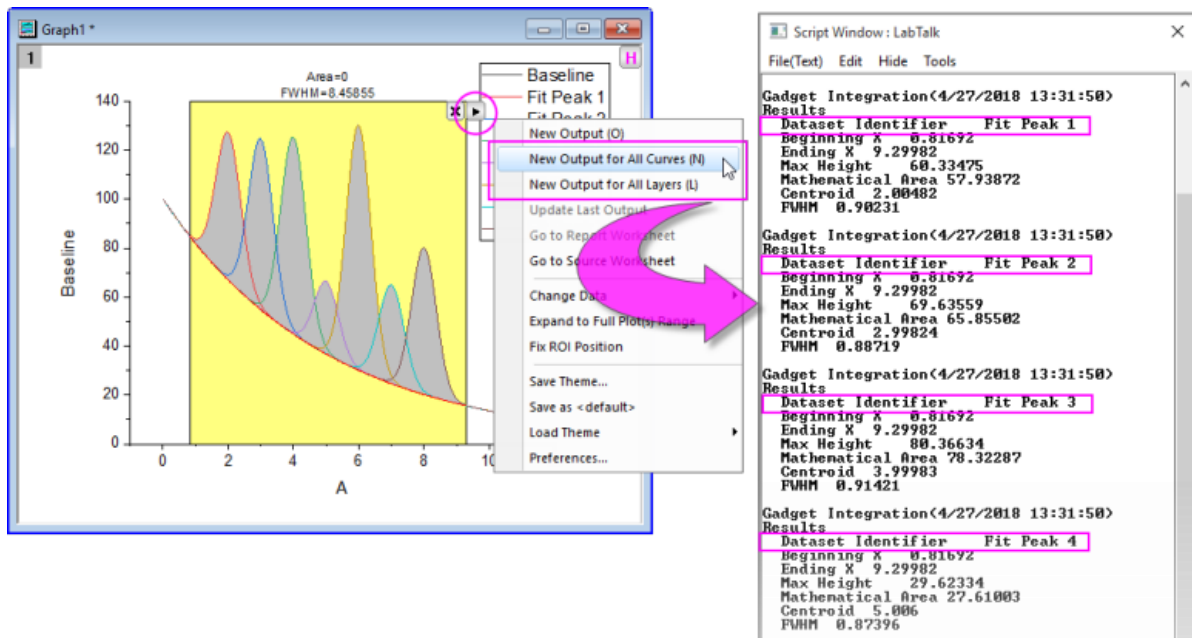

## 4.2.4 Curve Intersection Gadget

### 4.2.4.1 Summary

When there is more than one curve in a graph layer, you might want to calculate the intersection data points of these curves. Since Origin 8.6, a new gadget **Intersect** is available to calculate the intersection points of the input curves on the graph.

Minimum Origin Version Required: Origin 8.6 SR0

### 4.2.4.2 What you will learn

This tutorial will show you how to:

- Use the Intersect gadget on a graph.
- Tag the intersection points.
- Output the intersection points to worksheet.

### 4.2.4.3 Steps

This tutorial is associated with <Origin EXE Folder>\Samples\Tutorial Data.opj.

1. Open **Tutorial Data.opj** and browse to the **Curve Intersection Gadget** folder in **Project Explorer** (PE).
2. Highlight the Col(A)~col(D) in workbook **Book6**, and then click **Plot:Line:Line** to plot a line graph.



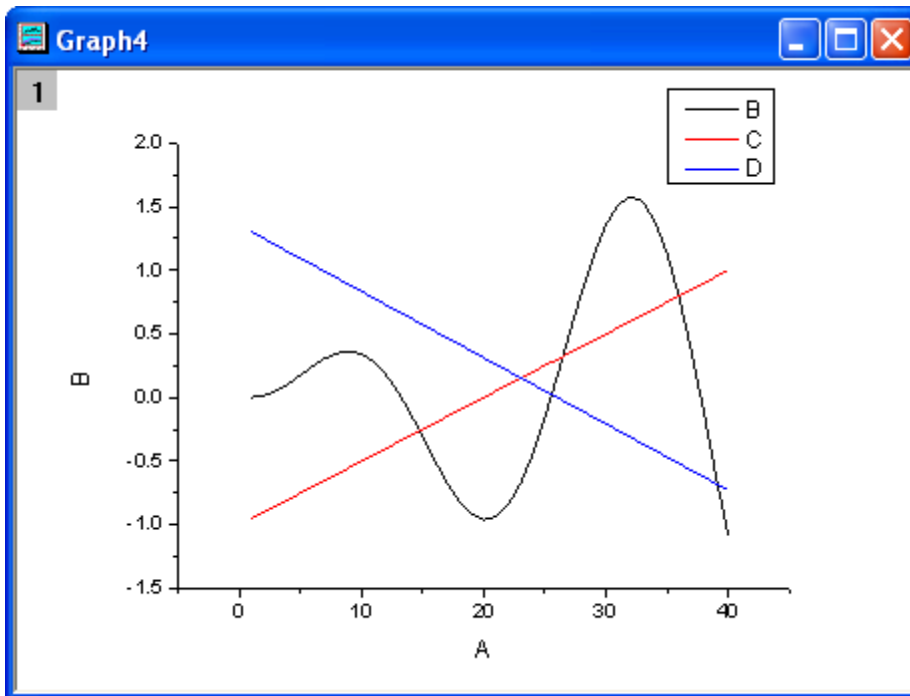

3. Select **Gadgets: Intersect...** from the main menu to open the dialog. Go to the **Options** tab.

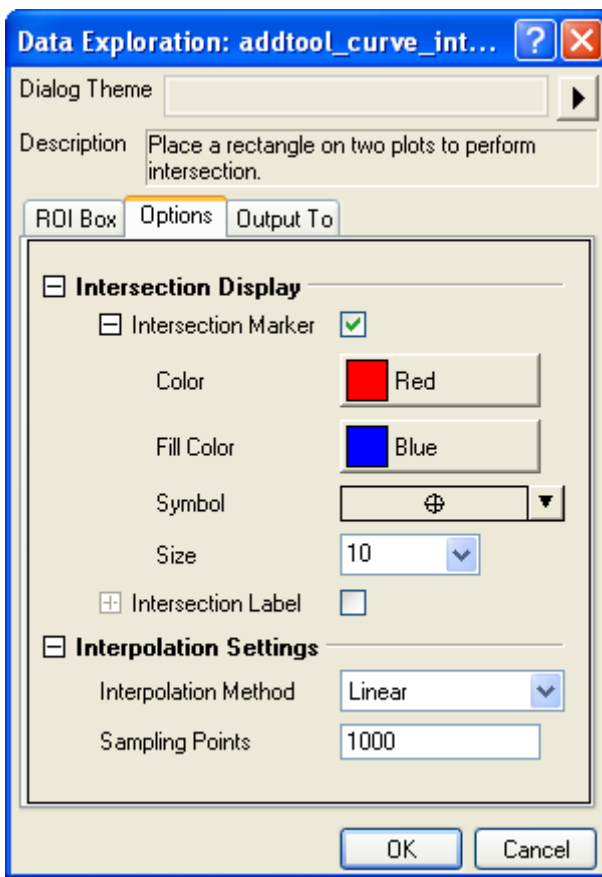

4. Check the **Intersection Label** check box in the **Options** tab, set **Size** as 15, set **Type** as Y and set **Rotate(deg.)** as 0.

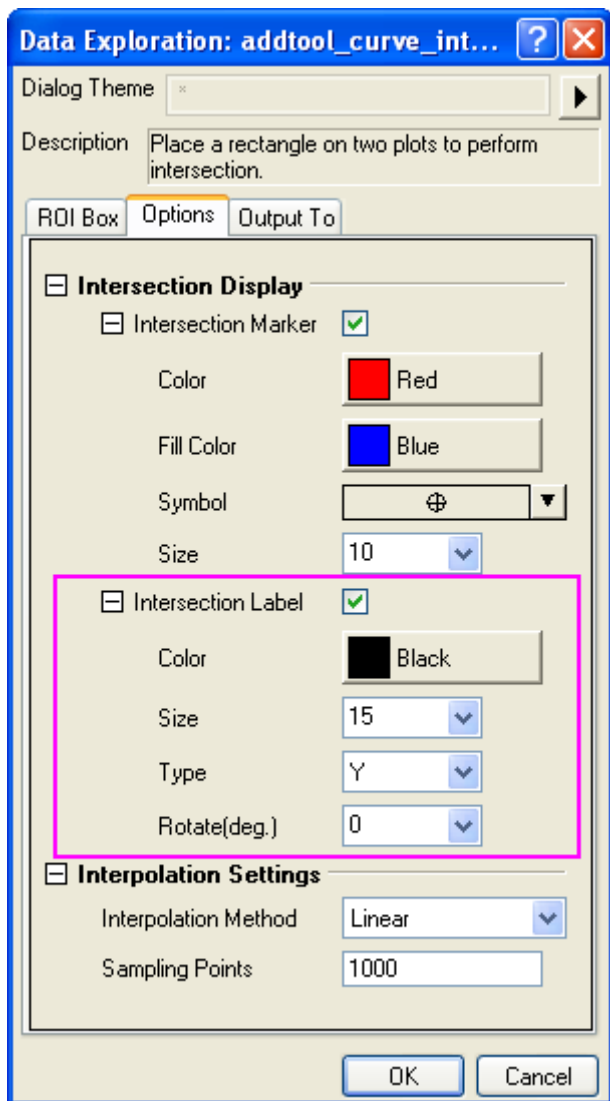

5. Click **OK** button to go back to the graph window. The yellow ROI box will be added onto the graph.

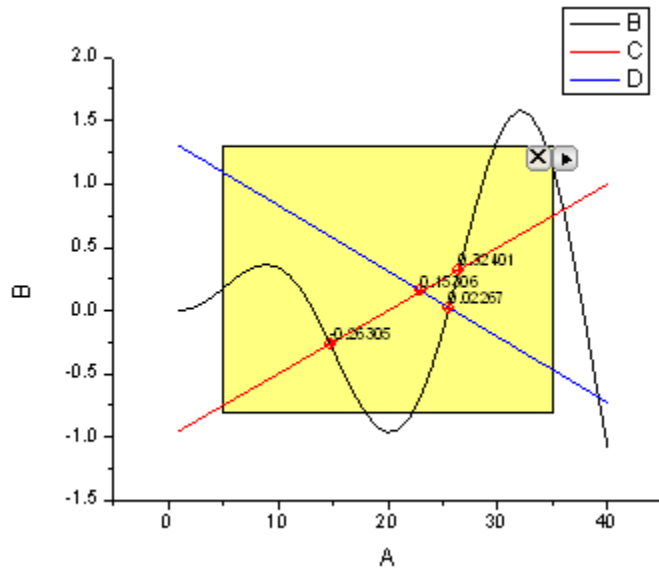

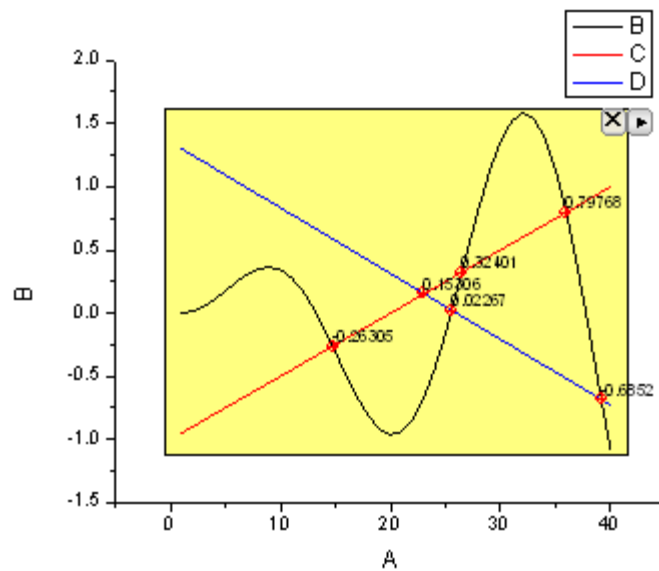

6. Click the Arrow button  at the top right of the ROI box, select **Expand to Full Plot(s) Range** from the context menu. The ROI box will be expanded to cover full plot range as shown below.

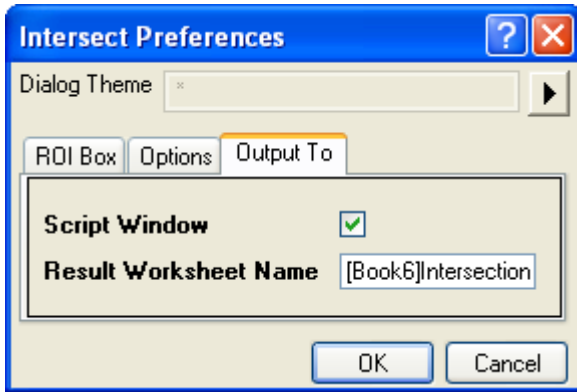

7. Click the Arrow button  at the top right of the ROI box. Select **Preferences...** from the context menu to open the **Intersect Preferences** dialog. Go to the **Output To** tab and input *[Book6]Intersections* in the **Result Worksheet Name** box.



8. Click **OK** button to go back to the graph window. Click the arrow button  at the top right of the ROI box, select **New Output** from the context menu.
9. The results will be output to the **Script Window**. Click the arrow button  again, select **Go To Report Worksheet** from the menu. The X and Y coordinates of the intersection points will be listed in the results worksheet.

	A(X)	B(Y)	C	D
Long Name	Intersection X	Intersection Y	Curves	Intersection Method
1	14.73898	-0.26305	Book6_B vs. Book6_C	Linear
2	26.4802	0.32401		
3	35.95356	0.79768		
4	25.56476	0.02267	Book6_B vs. Book6_D	
5	39.1559	-0.6852		
6	23.06123	0.15306	Book6_C vs. Book6_D	
7				
8				

## 4.2.5 Rise Time Gadget

### 4.2.5.1 Summary

The Rise Time Gadget can be used to analyze the rising and falling stages of a step-like signal in a graph. With this gadget, you can intuitively select an area on the graph with a rectangle, and then calculate the rise time or fall time within that area.

Minimum Origin Version Required: OriginPro 2015 SR0

### 4.2.5.2 What you will learn

- How to select a specific region of the signal by moving and resizing a region of interest (ROI).

- How to mark **Rise Time (Fall Time)** and **Rise Range (Fall Range)** in the graph.
- How to switch the tool between **Rise Time** and **Fall Time**.
- How to output analysis results of **Rise Time (Fall Time)**.

#### 4.2.5.3 Analyze Rise Time

1. Start with a new workbook and click the  button to import the **Step Signal with Random Noise.dat** file under the <Origin EXE Folder>\Samples\Signal Processing path.
2. Highlight Column B and select **Plot: Line: Line** in the menu to create a graph.

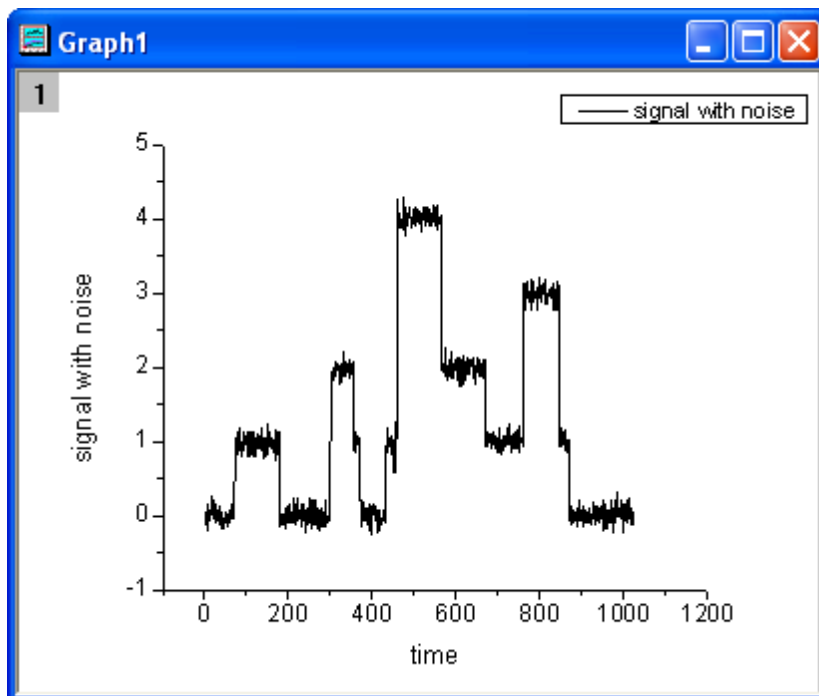

3. Double-click the X axis to open the **Axis** dialog box. Go to the **Scale** tab and set the axis range and major ticks as shown in the image below.

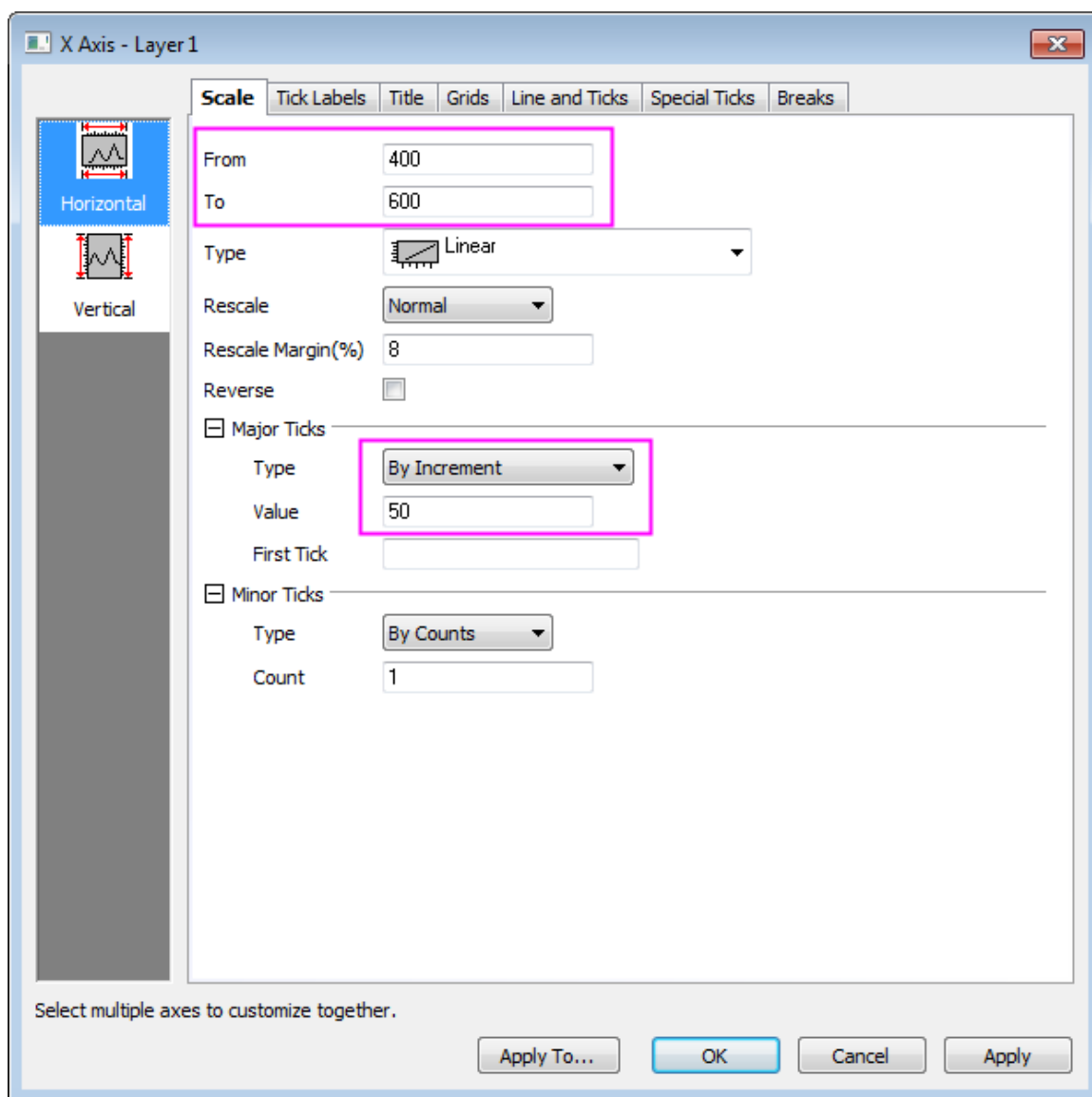

- Click the **OK** button and the graph will be updated as shown below:

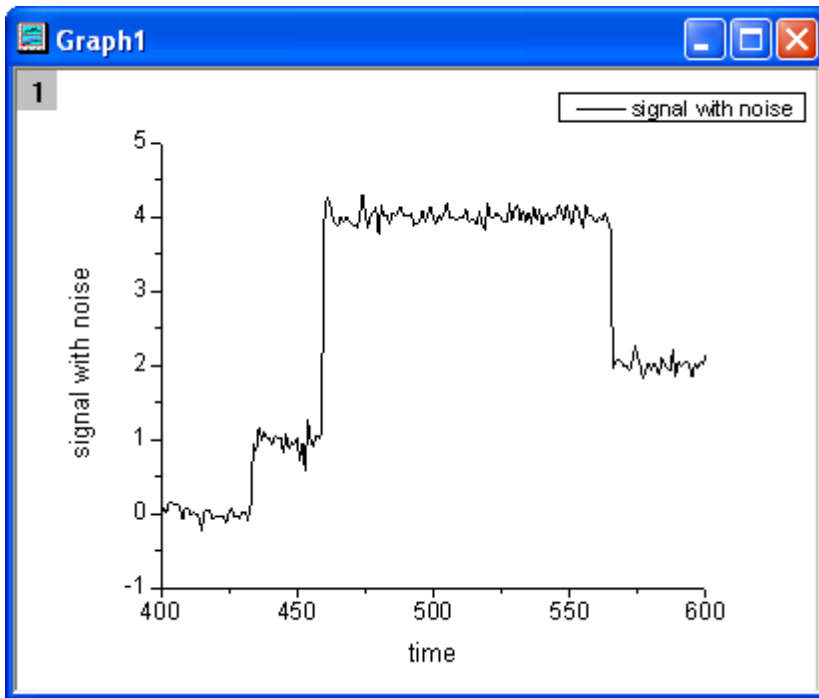

- Select **Gadgets: Rise Time** from the Origin menu to open the **Rise Time: addtool\_rise\_time** dialog box. Go to the **Display on Graph** tab, and click the **Rise Time** and **Rise Range** check boxes.

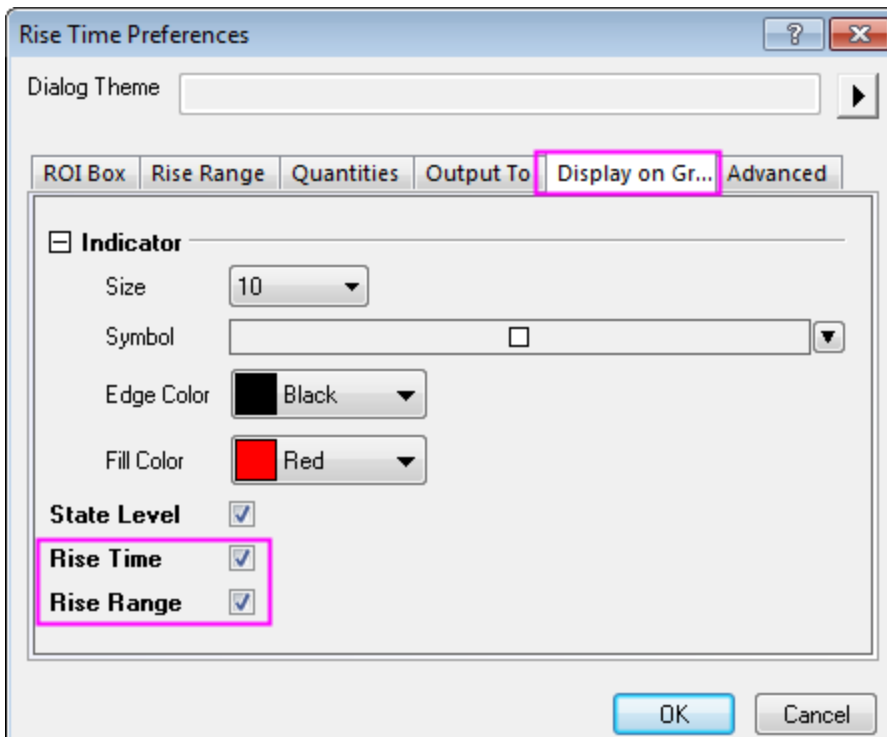

6. Click **OK** button, and you will see that a yellow rectangle is added to the plot. Move the rectangle horizontally on the rise signal step.

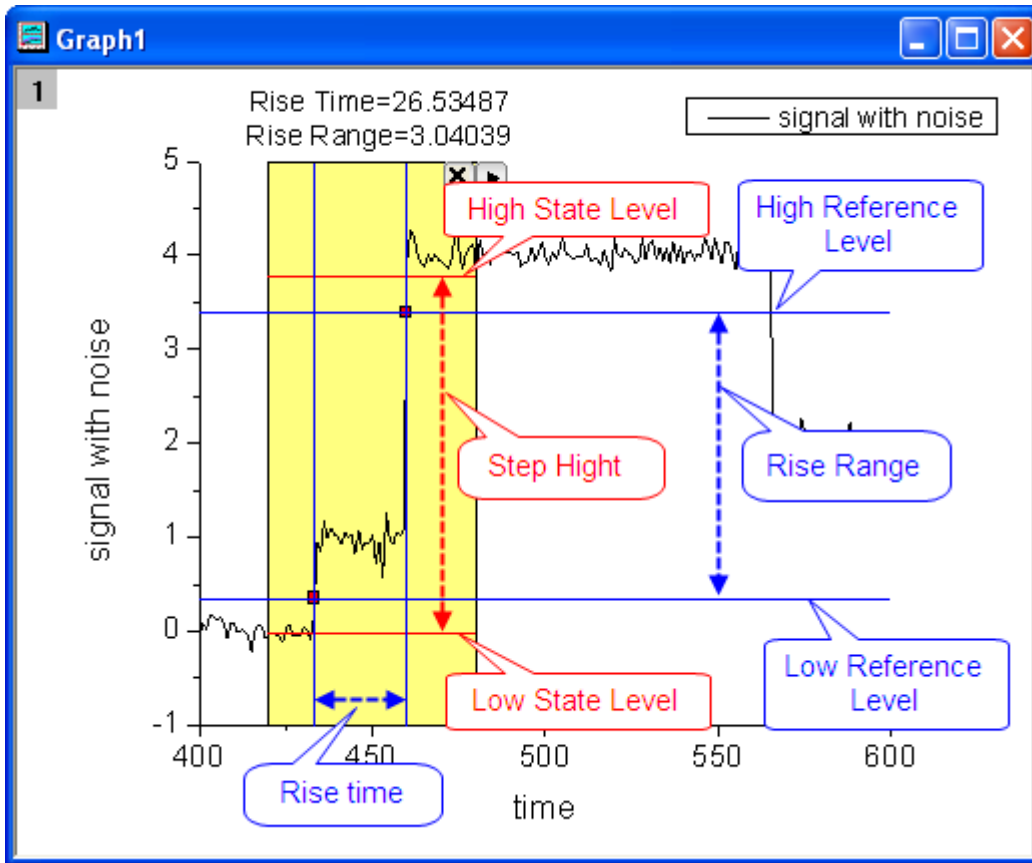

In the graph, you can see the **Rise Time** and **Rise Range** values are shown at the top of the rectangle. The two blue vertical lines go through the two indicators marking the **Rise Time**. The two blue horizontal lines that display the **Low Reference Level** and **High Reference Level** go through the two indicators marking the **Rise Range**. The two red horizontal lines display **Low State Level** and **High State Level**.

7. Click the triangle button  at the top right corner of the rectangle. Then select **New Output**. The results will be output to the **Script Window**.



```

Script Window : LabTalk
File(Text) Edit Hide Tools

Gadget Rise Time(9/3/2014 09:29:51)
Results of Rise Time
Dataset Identifier    signal with noise
Low State Level(UMin) -0.22525
High State Level(UMax) 3.9647
Low Reference Level(UrefMin) 0.19375
High Reference Level(UrefMax) 3.54571
Time at Low Reference Level(T1) 433.08395
Time at High Reference Level(T2) 459.85931
Rise Time(dT) 26.77536

```

#### 4.2.5.4 Analyze Fall Time

1. This gadget also allows you to get the fall time and fall range in a graph. Move the rectangle horizontally on the fall signal step.

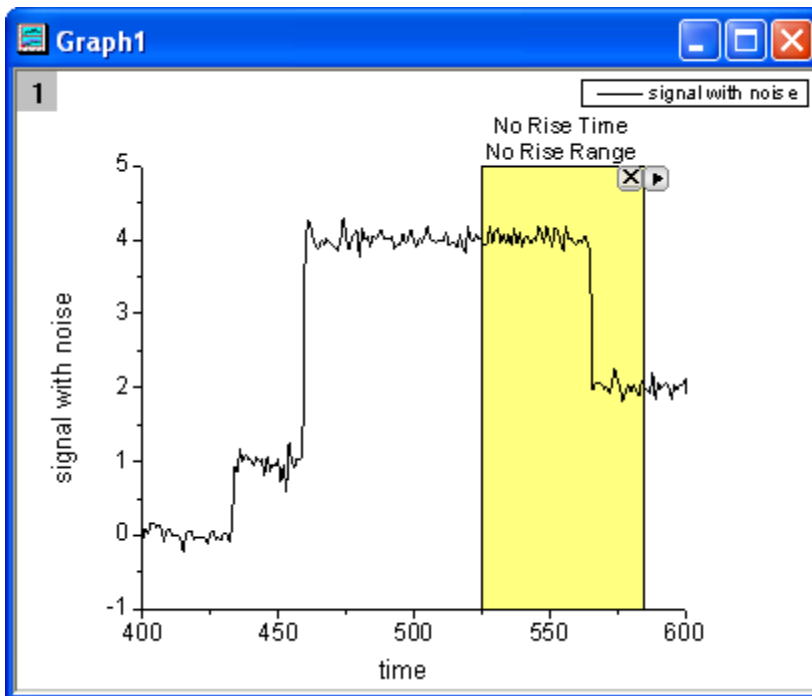

2. Click the triangle button  and select **Preferences** in the fly-out menu to open the **Rise Time Preferences** dialog. Go to the **ROI Box** tab and select **Fall Time** in the **Tool** drop-down list.

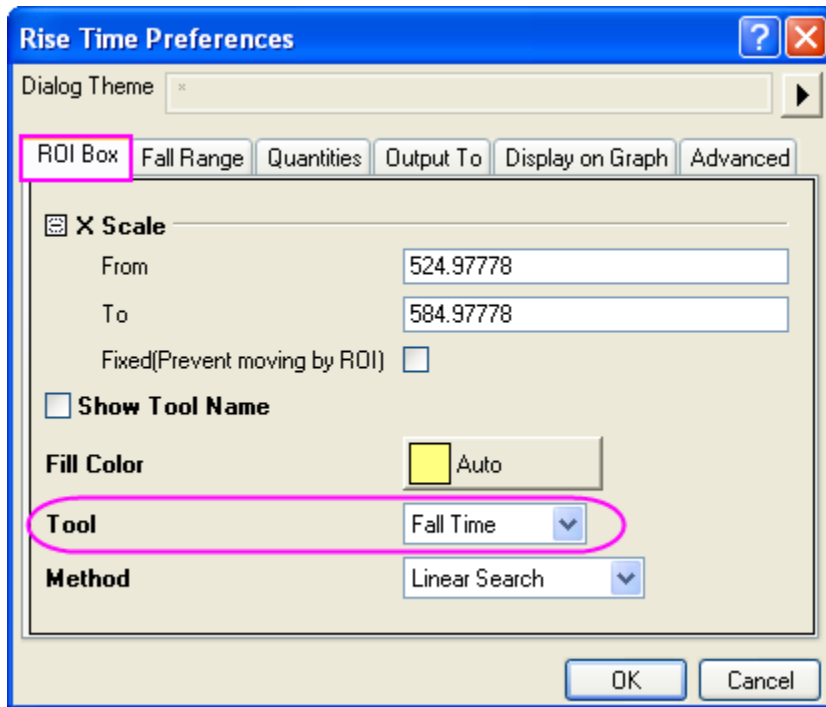

3. Click the **OK** button, the **Fall Time** and **Fall Range** values are shown at the top of the rectangle.

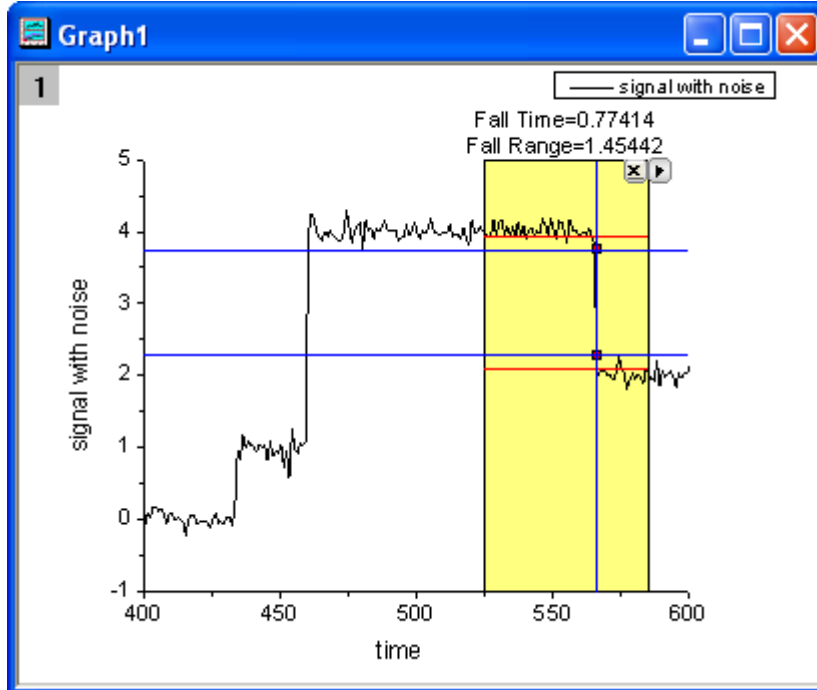

4. Click the triangle button  and select **New Output**. The results will be output to the **Script Window**.

## 4.2.6 Interpolate Gadget

### 4.2.6.1 Summary

Origin supports the interpolate gadget to perform quick interpolation on a ROI (Region of Interest) range when a graph is active. And you can easily to change the interpolate region by moving the ROI.

### 4.2.6.2 What you will learn

- How to easily interpolate data points on a rectangular region.
- How to quickly find out an interpolated Y value from any given X value.
- How to output the interpolated values to **Script Window**, **Result Log**, or a specified worksheet.

### 4.2.6.3 Steps

This tutorial is associated with <Origin EXE Folder>\Samples\Tutorial Data.opj.

1. Open **Tutorial Data.opj** and browse to the **Interpolate Gadget** folder in **Project Explorer** (PE).
2. Highlight the Col(A) and col(B) in workbook Book1R and plot a **Line +Symbol** graph.

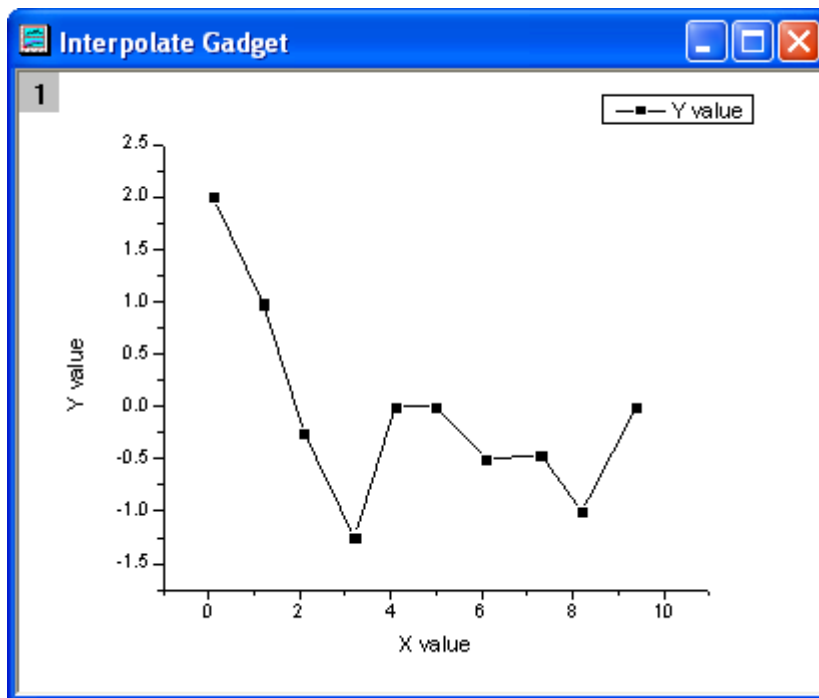

3. Select **Gadgets: Interpolate** from the Origin menu when a graph is active, to bring up the **Interpolate: addtool\_curve\_intep** dialog box.
4. Go to the **Interpolate/Exterpolate Options** tab. Choose **Cubic Spline** for the **Method**, and then select **Interpolate/Extrapolate to Rectangle Edge** for **Fit Limits To**.

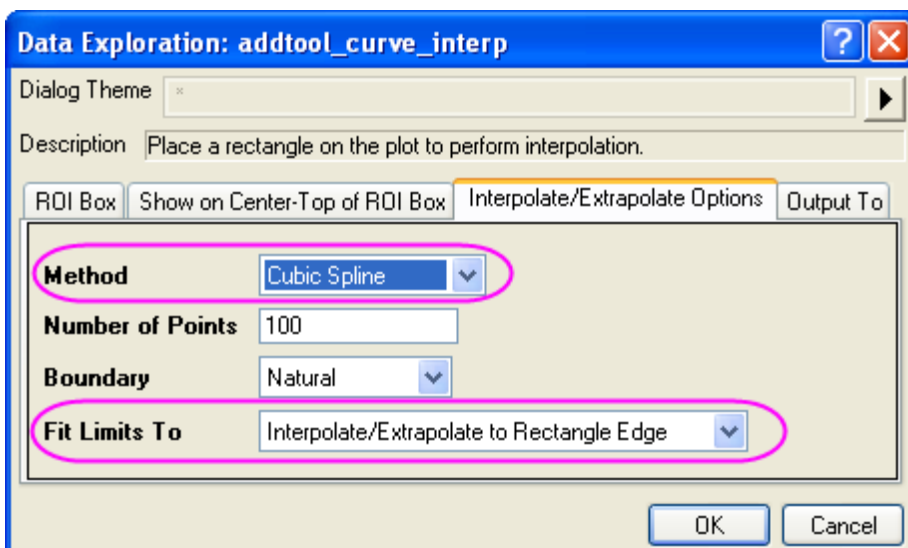

- Click **OK** button. It will add an interpolation line onto the plot. And the Y values of interpolation line at right and left are shown at the top of the rectangle region.

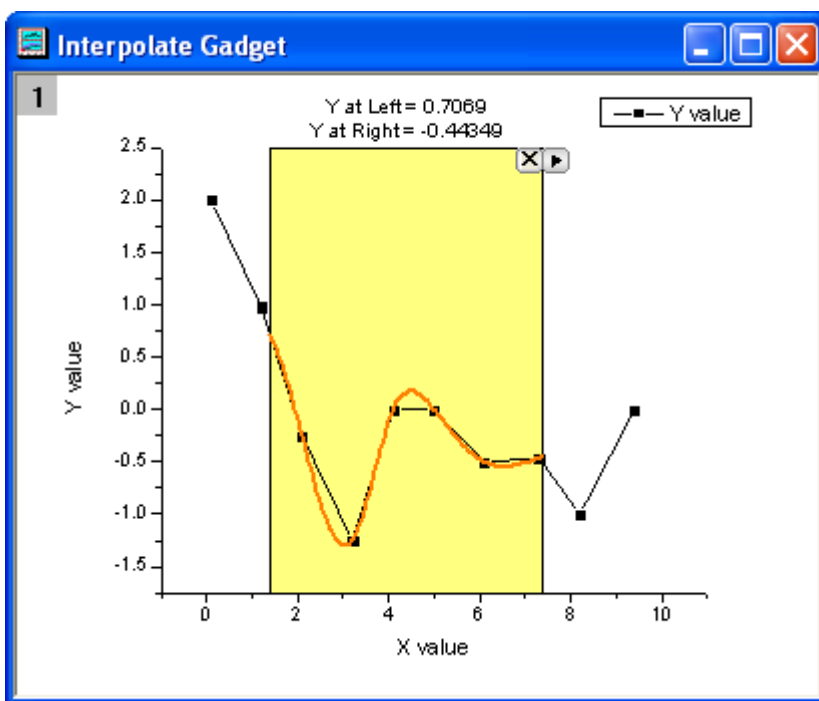

- You can change the data range by moving or resizing the yellow region of interest rectangle, the interpolated curve displayed will update as the ROI is being moved.  
Click the triangle button  and select **Expand to Full Plot(s) Range** in the fly-out menu to interpolate the total area for the curve.

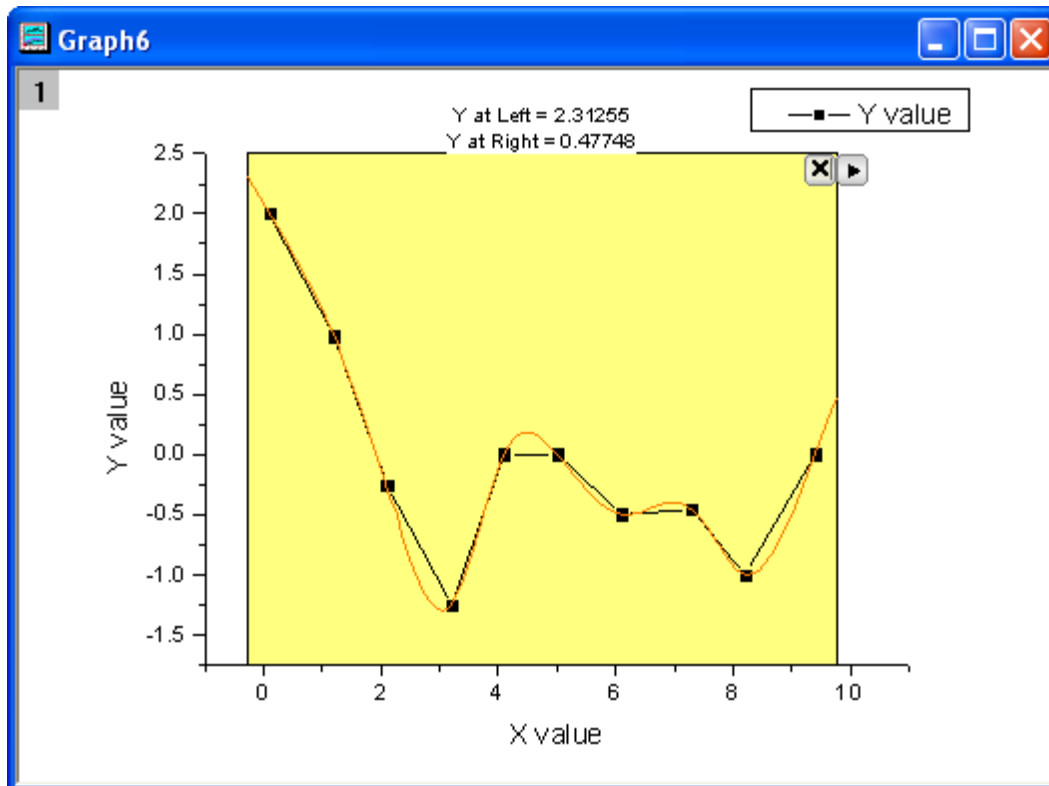

7. This gadget also allows you to find Y values from a given X value. Select **Interpolate X/Y** in fly-out menu to open the **Interpolate Y from X** dialog. You can enter multiple X values and click the **interpolate** button. This tool will output the interpolated Y values for each of the X values.

8. The interpolated Y values can be output to **Script Window**, **Result Log**, or a specified worksheet.

## 4.2.7 Cluster Gadget

### 4.2.7.1 Summary

Origin supports the Cluster Gadget to perform simple statistics on a region of interest (ROI) in a graph. The gadget can also be used to edit, clear, mask, or categorize data points. The statistics results are dynamically updated as the ROI object is moved or resized.

Minimum Origin Version Required: Origin 2016 SR0 (Pro only)

### 4.2.7.2 What you will learn

- How to perform simple statistics on a region of interest (ROI) in a graph.
- How to edit the data points such as clear, or mask points in graph using menu options or buttons.
- How to view or output the statistic for points inside and outside of the ROI.
- How to categorize data points and color map points with the categorical data

### 4.2.7.3 Perform basic statistics

1. Start with a new workbook and import the Origin sample data *Categorical Data.dat* which is located in `<Origin Program Folder> \Samples\Graphing`.  
Right-click on Col(D) and select **Sort Worksheet: Ascending**. Then you will see the worksheet is sorted by the category of *Drug*.
2. Pressing **Ctrl** key, highlight three parts of the Col(B) separately.

	A(Y)	B(Y)	C(Y)	D(Y)
Long Name	Age	Recovery	Gender	Drug
Units				
Comments				
1	20	11	Male	Drug A
2	23	12	Female	Drug A
3	45	29	Male	Drug A
4	60	39	Female	Drug A
5	57	38	Male	Drug A
6	32	19	Female	Drug A
7	36	20	Male	Drug A
8	44	30	Female	Drug A
9	59	41	Male	Drug B
10	34	21	Male	Drug B
11	43	31	Male	Drug B
12	23	11	Male	Drug B
13	22	13	Female	Drug B
14	60	42	Female	Drug B
15	44	32	Female	Drug B
16	34	18	Female	Drug B
17	21	12	Male	Placebo
18	45	36	Female	Placebo
19	44	35	Male	Placebo
20	35	23	Female	Placebo
21	36	22	Male	Placebo
22	23	14	Female	Placebo
23	60	46	Male	Placebo
24	58	45	Female	Placebo
25				

3. Select **Plot: Symbol: Scatter** from the main menu to create a graph. The graph with three plots display the recovery for each drug.

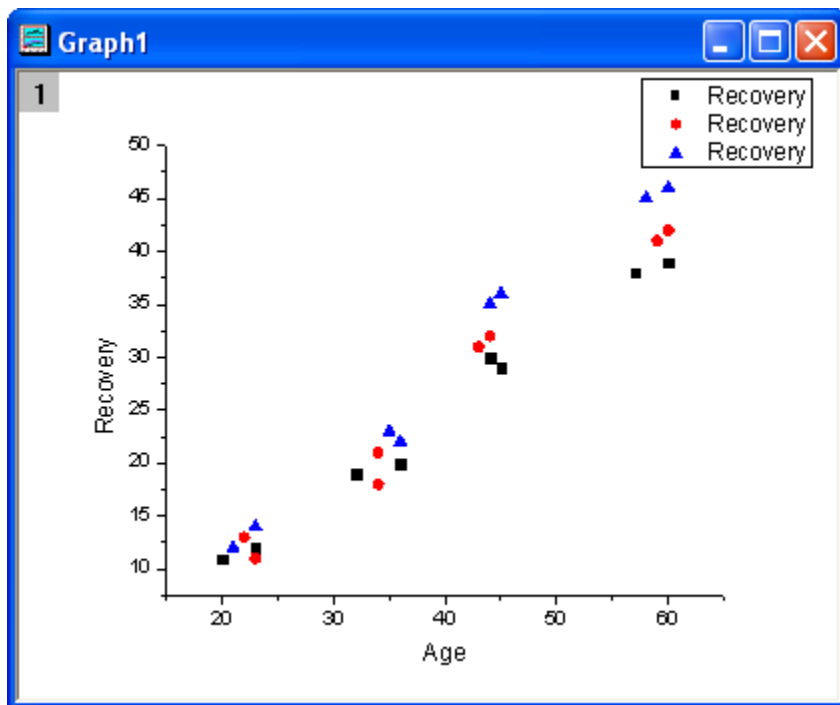

- Right-click on the graph legend and select **Properties** to open **Object Properties** dialog. Then edit the legend as shown below. Click **OK** button.

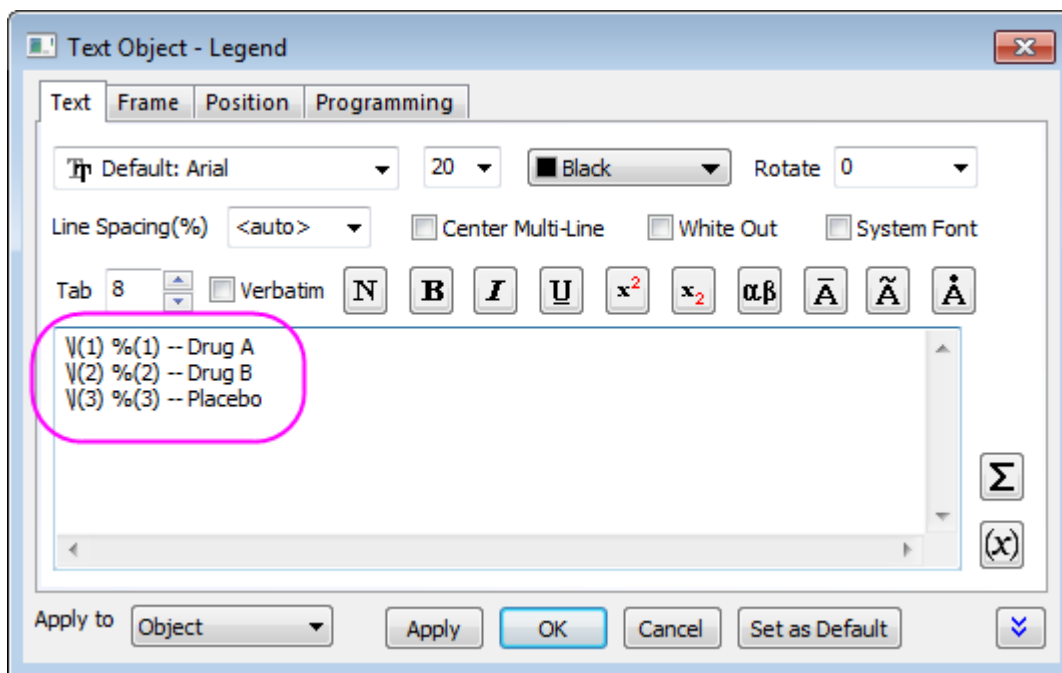

- Select **Gadgets: Cluster** from the Origin menu to bring up the **Cluster: addtool\_cluster** dialog box. Choose **Circle** in the **Shape** drop-down list of the **ROI Box** tab.



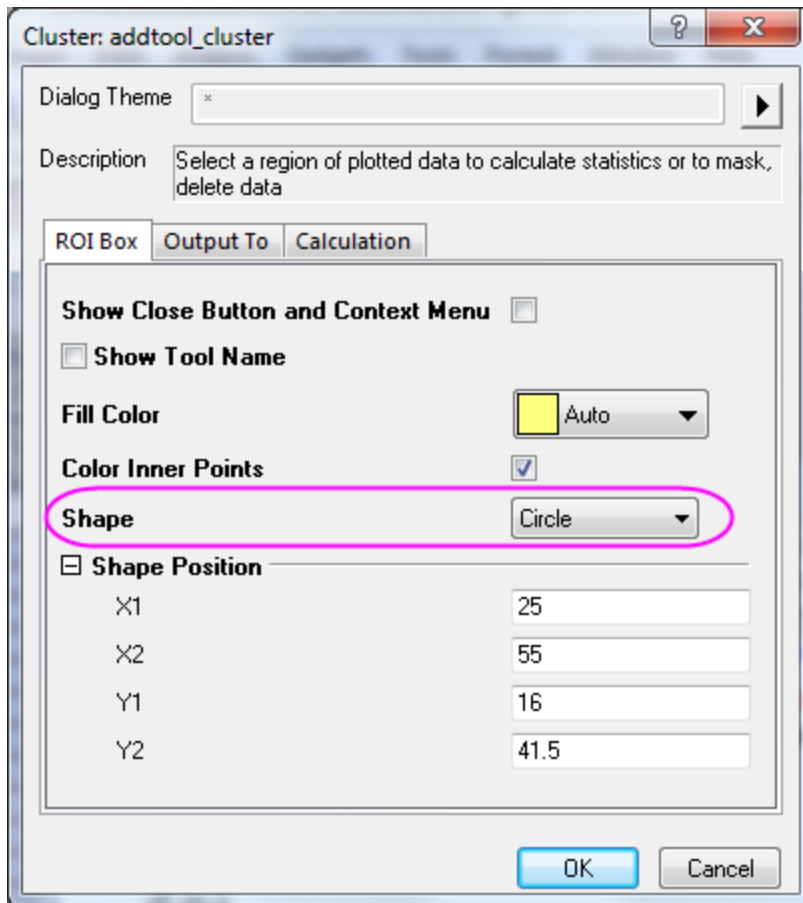

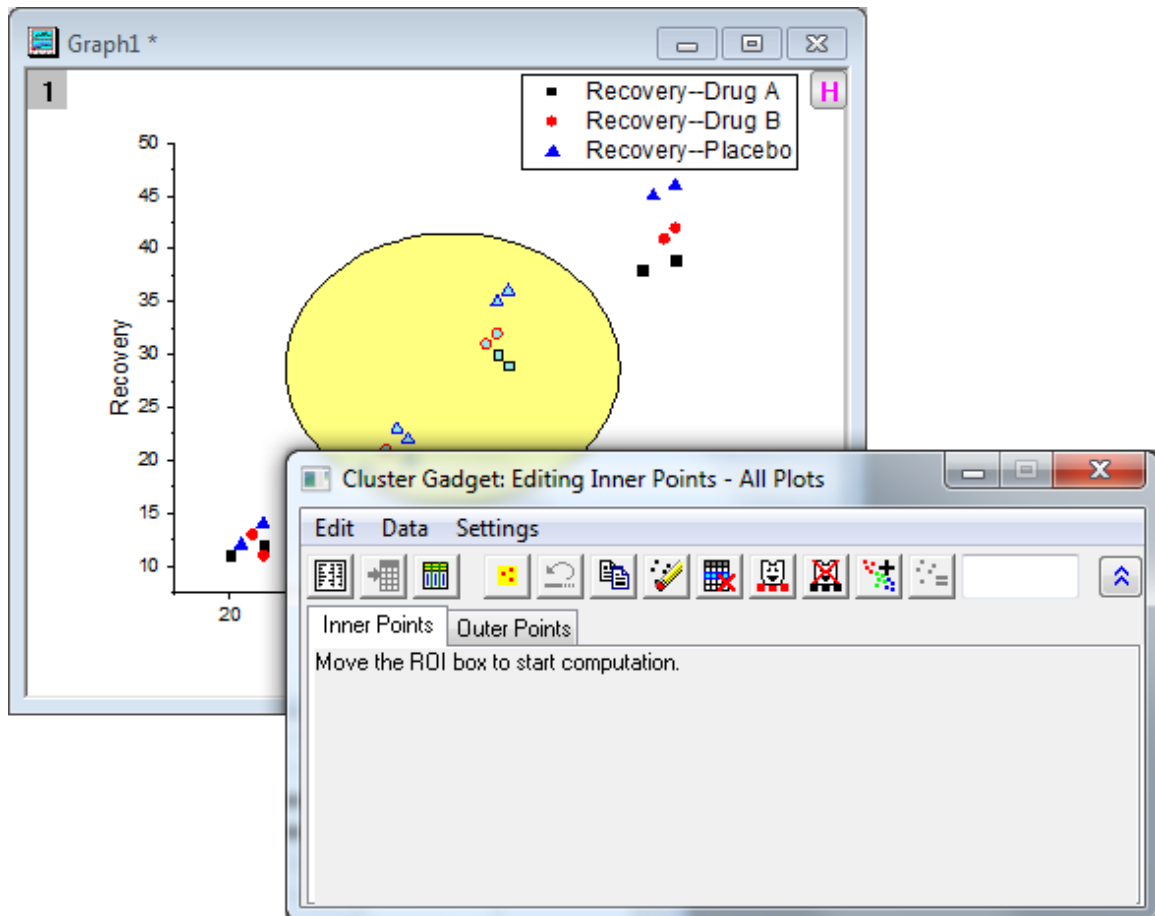

6. Click **OK** button. It will add a yellow circle for **ROI** on the plot and bring up the **Cluster Gadget** dialog.

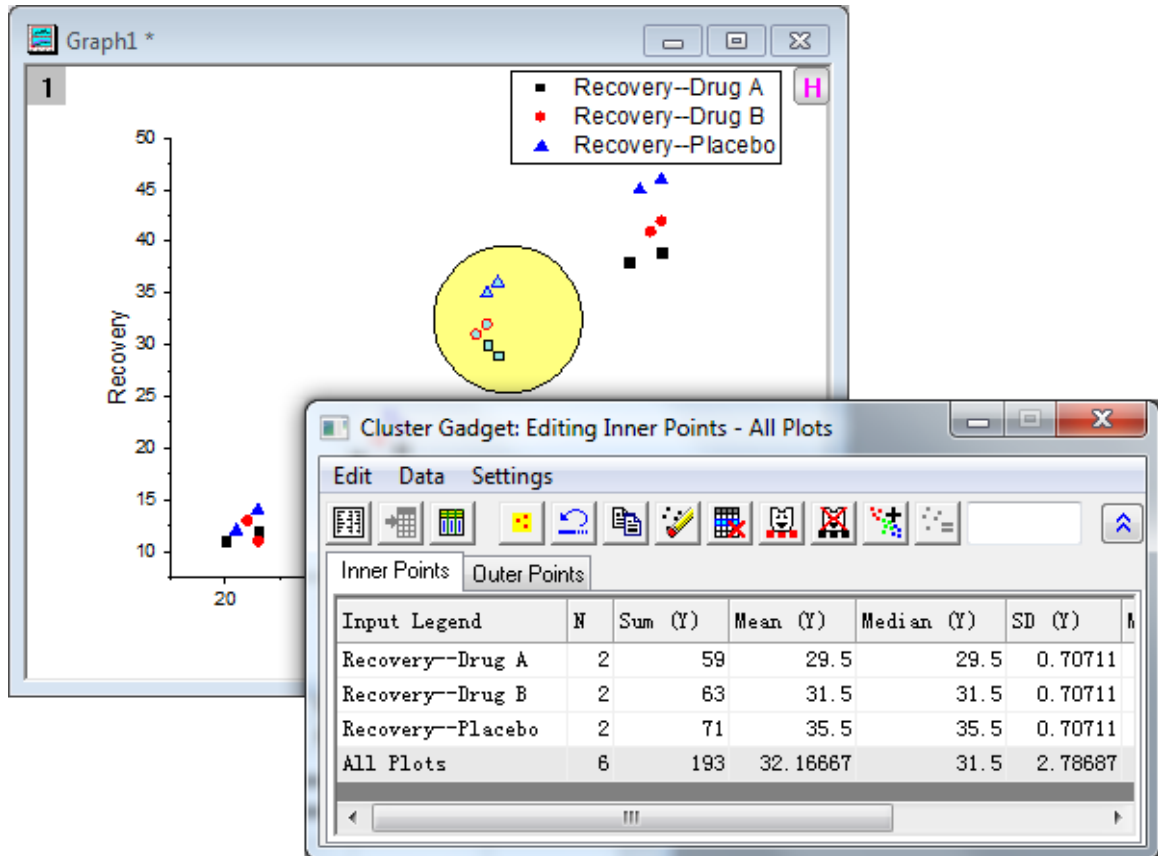

7. Move the yellow circle to the region for which you want to get statistics and see the results shown on the **Inner Points** tab of the dialog.



8. Click the **Output Statistics Report** button . The results are output to the Result Log, Script Window, and the Cluster workbook.

9. Click the **Go to Report Worksheet** button , then the **Cluster** workbook will be shown.

	A	B	C(Y)	D(Y)	E(Y)	F(Y)
Long Name	Region	Data	N	Sum (Y)	Mean (Y)	Median (Y)
1	Inner Points	Recovery--Drug A	2	59	29.5	29.5
2	Inner Points	Recovery--Drug B	2	63	31.5	31.5
3	Inner Points	Recovery--Placebo	2	71	35.5	35.5
4	Inner Points	All Plots	6	193	32.16667	31.5
5						

#### 4.2.7.4 Exclude the data points in a cluster

In this section, we will show you how to exclude a specific plot from the cluster. Based on the example above, we will do simple statistics on *Recovery of Drug A* and *Recovery of Drug B*, excluding *Recovery of Placebo*.

1. Click the **Data** menu in the **Cluster Gadget** dialog and uncheck **Plot(1)** and **Plot(2)**. The first and second rows become gray in the lower panel, and they can no longer be manipulated by the buttons in the dialog.
2. Click **Mask Data Points** button . The *Recovery of Placebo* data points in the ROI are masked and the color becomes red. At the same time the statistics results for *Recovery of Placebo* become missing values.

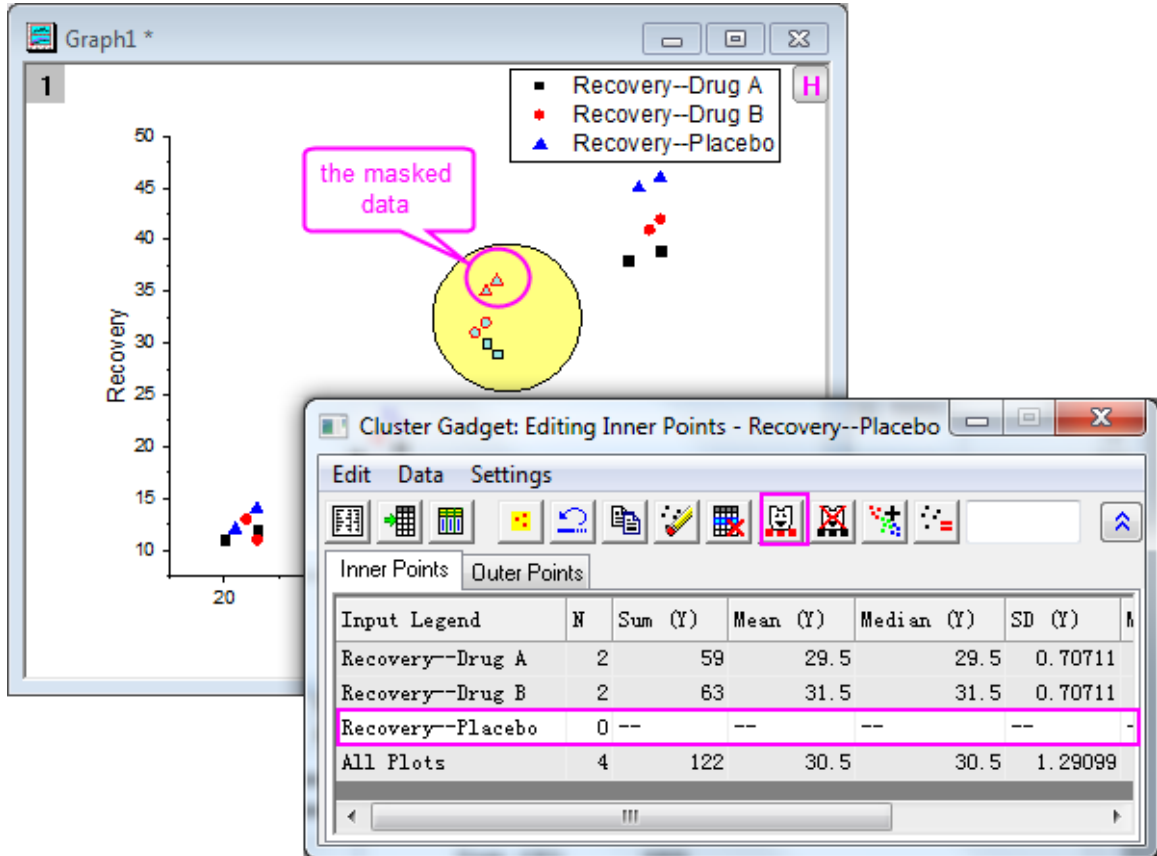

3. Click the **Output Statistics Report** button . The results are output to the Result Log, Script Window, and the Cluster workbook.

#### 4.2.7.5 Get statistics results for points outside of the ROI

1. Click **Settings: Preferences** from the **Cluster Gadget** dialog's menu to open the **Cluster Manipulation Preferences** dialog.
2. Go to the **Calculation** tab. Click the **Calculate Outer Points** check box.

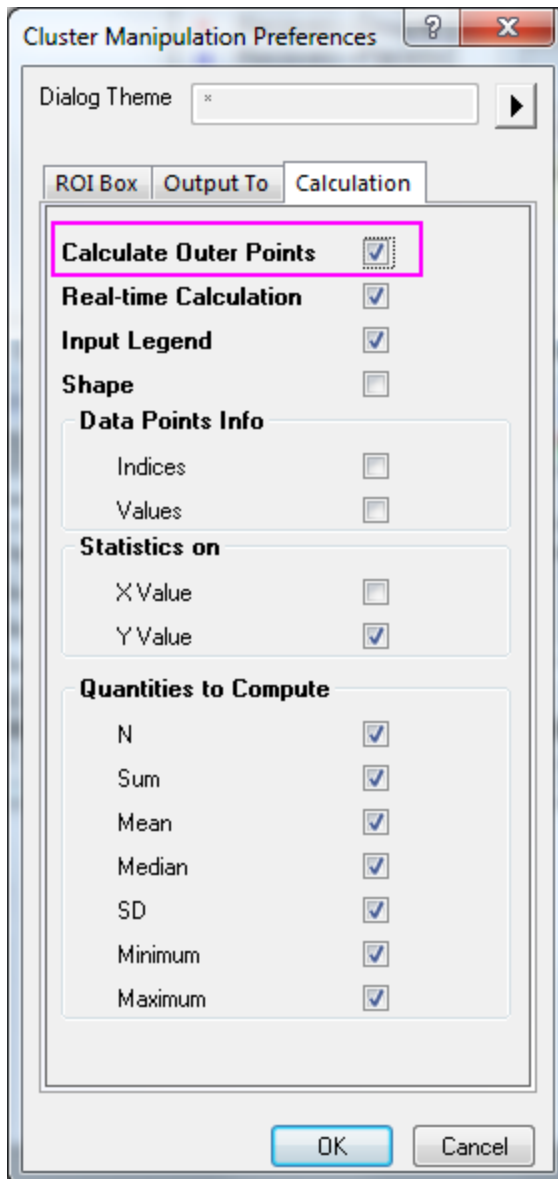

3. Click the **OK** button, the statistics results for points out of the ROI are shown on the **Outer Points** tab of the dialog.

Input Legend	N	Sum (Y)	Mean (Y)	Median (Y)	SD (Y)
Recovery--Drug A	6	139	23.16667	19.5	12.41636
Recovery--Drug B	6	146	24.33333	19.5	13.76461
Recovery--Placebo	6	162	27	22.5	14.96667
All Plots	18	447	24.83333	20.5	13.02599

- Click the **Output Statistics Report** button . The results for inner and outer points are shown in the Result Log, Script Window, and the Cluster workbook.

#### 4.2.7.6 Color data points in different regions

You can categorize data points from graph directly and output the Categorical group column to the source worksheet, and further map symbol characters to the categorical group column.

Create a new workbook and re-import the sample data <Origin Program Folder>\Samples\Graphing\Categorical Data.dat. Highlight Column(B) and plot a Scatter graph.

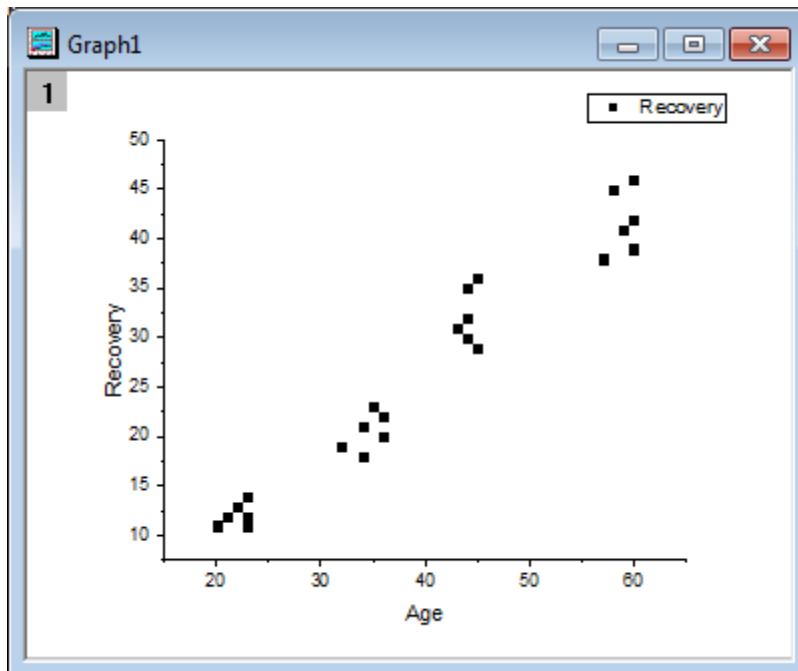

Data points cluster into 4 groups. We will use the **Create Categories** feature of **Cluster Gadget** to create a categorical column according to the cluster groups and map symbol color to this column.

1. Select **Gadgets: Cluster** to bring up the **Cluster: addtool\_cluster** dialog. Choose **Circle** in the **Shape** drop-down list of the **ROI Box** tab.  
Click **OK** button to add a yellow circle for ROI on the plot and bring up the **Cluster Gadget** dialog.
2. Move and adjust the size of the ROI box to circle only the first cluster of data points at the low-left corner.

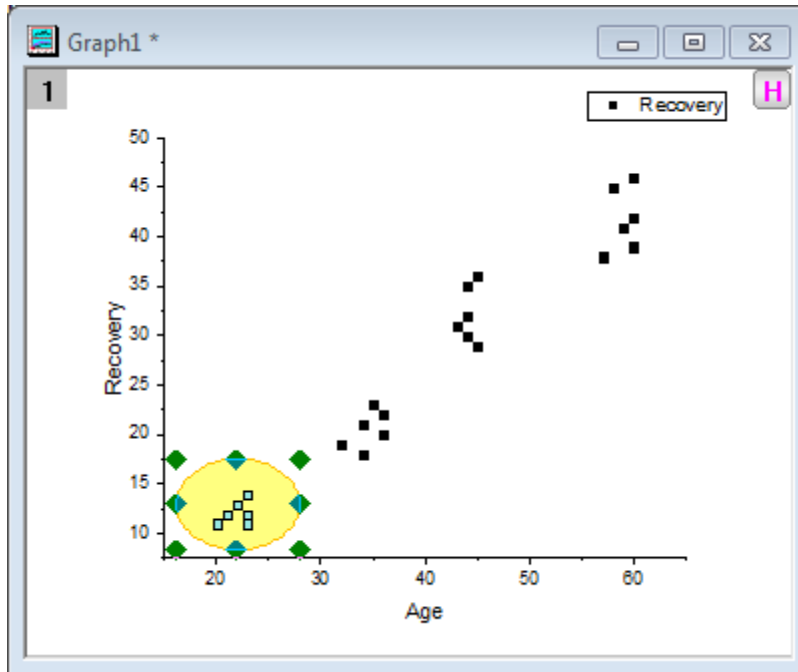

Click the **Create Categories** button  on the **Cluster Gadget** dialog to open the **Create Categorical Value** dialog. Enter **Group** for **Category Group Name** and **1** for **Category**. And select the **Color Data by Category** check box.

Click the **OK** button. A new categorical column named "Group" is added to the source data sheet and data points inside ROI are tagged as "1" in this **column(Group)**. Also, scatter plot use this categorical column as the color index.

CategoricalDa - Categorical Data.dat \*

	A(X)	B(Y)	C(Y)	D(Y)	E(Y)
Long Name	Age	Recovery	Group	Gender	Drug
Units					
Comments			Categories		
F(x)=					
Sparklines					
Categories			undefined 1		
1	20	11	1	Male	Drug A
2	23	12	1	Female	Drug A
3	22	13	1	Female	Drug B
4	23	11	1	Male	Drug B
5	21	12	1	Male	Placebo
6	23	14	1	Female	Placebo
7	36	20	undefined	Male	Drug A
8	32	19	undefined	Female	Drug A
9	34	18	undefined	Female	Drug B
10	34	21	undefined	Male	Drug B
11	36	22	undefined	Male	Placebo

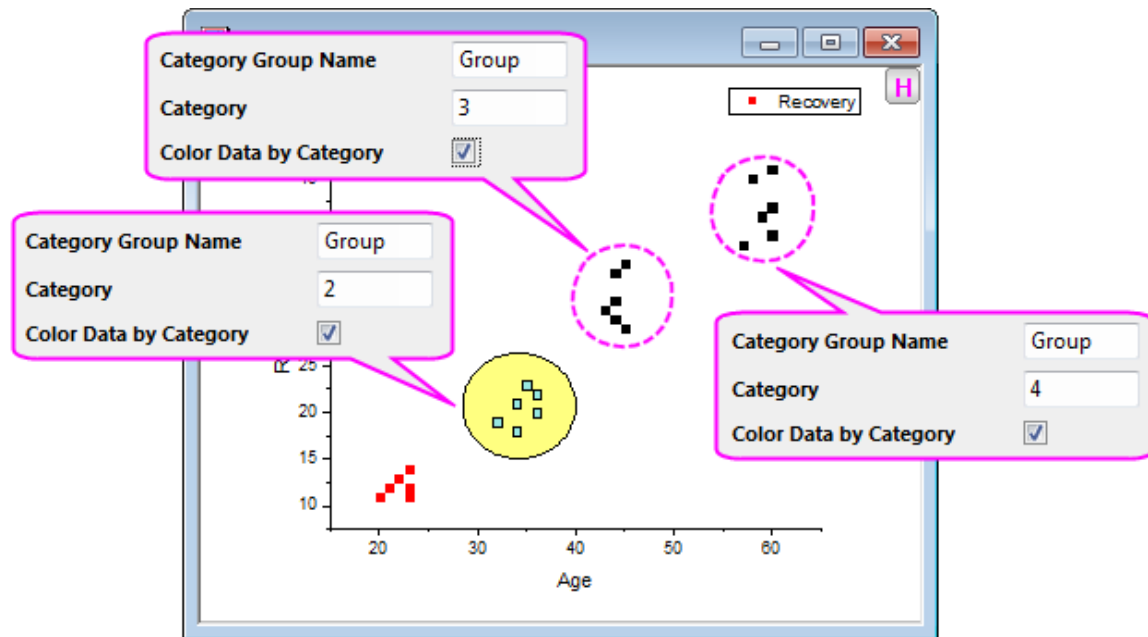

- Repeat step 2 for the rest of 3 clusters and tag them as 2, 3, 4 in sequence.



The source worksheet should look like the following.



CategoricalDa - Categorical Data.dat \*

	A(X)	B(Y)	C(Y)	D(Y)	E(Y)
Long Name	Age	Recovery	Group	Gender	Drug
Units					
Comments			Categories		
F(x)=					
Sparklines					
Categories			undefined 1		
5	21	12	1	Male	Placebo
6	23	14	1	Female	Placebo
7	36	20	2	Male	Drug A
8	32	19	2	Female	Drug A
9	34	18	2	Female	Drug B
10	34	21	2	Male	Drug B
11	36	22	2	Male	Placebo
12	35	23	2	Female	Placebo
13	45	29	3	Male	Drug A
14	44	30	3	Female	Drug A
15	44	32	3	Female	Drug B
16	43	31	3	Male	Drug B
17	44	35	3	Male	Placebo
18	45	36	3	Female	Placebo
19	57	38	4	Male	Drug A
20	60	39	4	Female	Drug A

Categorical Data

Close **Cluster Gadget**.

4. Now you will find the graph shows as below:

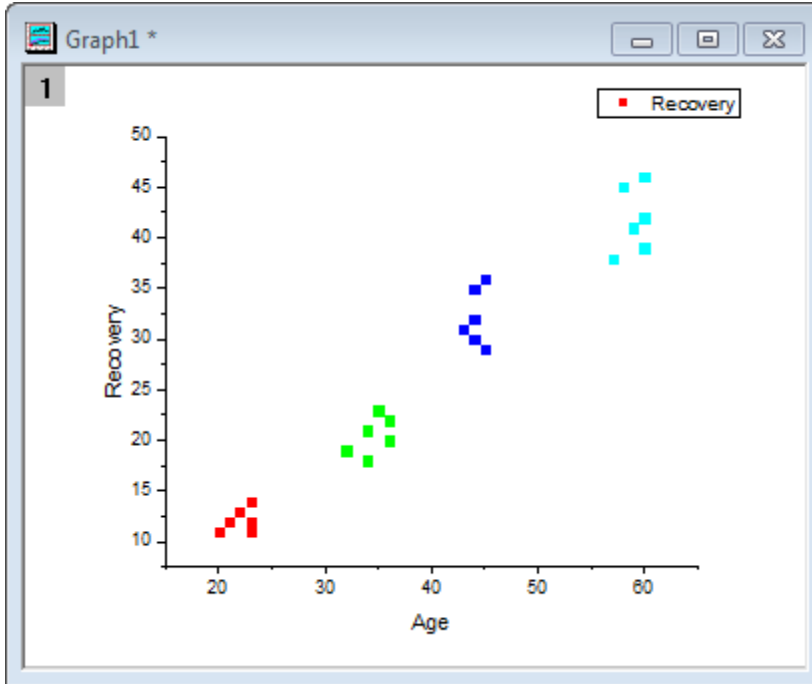

5. Delete the original legend. Select **Graph: Legend: Categorical Values** to bring up the **legendcat** dialog. Uncheck the **Show All Categories** checkbox. Click **OK**. The scatter plot with new legend should look like following.

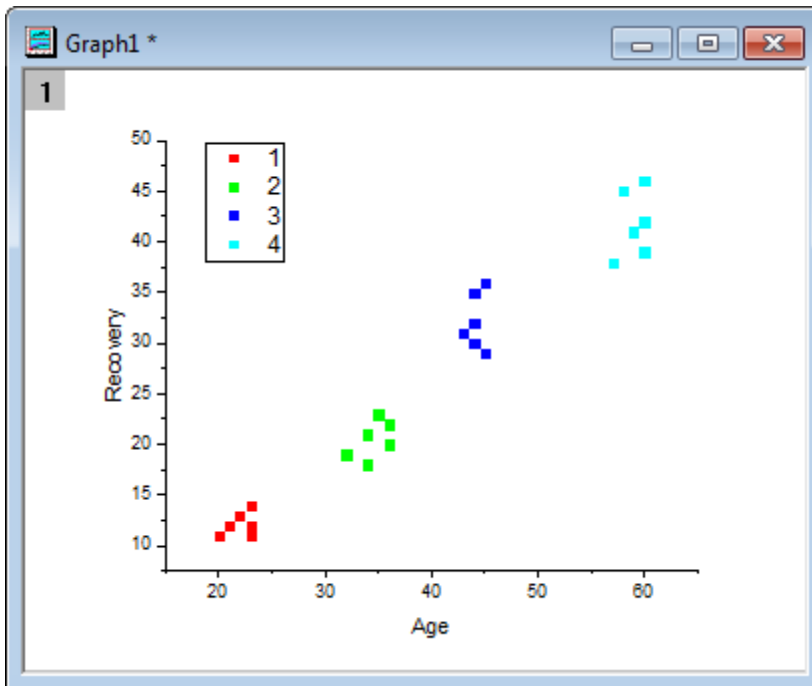

## 4.2.8 Quick Fit Gadget

### 4.2.8.1 Summary

The Quick Fit gadget can be used to quickly perform curve fitting within the ROI (Region of Interest) range.

Minimum Origin Version Required: Origin 8.6 SR0

#### 4.2.8.2 What you will learn

This tutorial will show you how to:

- carry out linear fit with the Quick Fit gadget.
- carry out nonlinear curve fit using Quick Fit gadget.
- save and reuse a dialog theme.

#### 4.2.8.3 Steps

##### 4.2.8.3.1 Linear Fit

1. Open Origin and choose **Data: Import from File: Import Wizard**. For the **Data Source**, browse to *<Origin Folder>/Samples/Curve Fitting* and add the **Step01.dat**. Note that when this file is selected, the import filter **Data Folder: step** is automatically chosen (this is shown in in the **Import Filters for Current Data Type** box). Click **Finish** to import the file.

2. Highlight through column A to F and click the  button to generate a scatter plot.

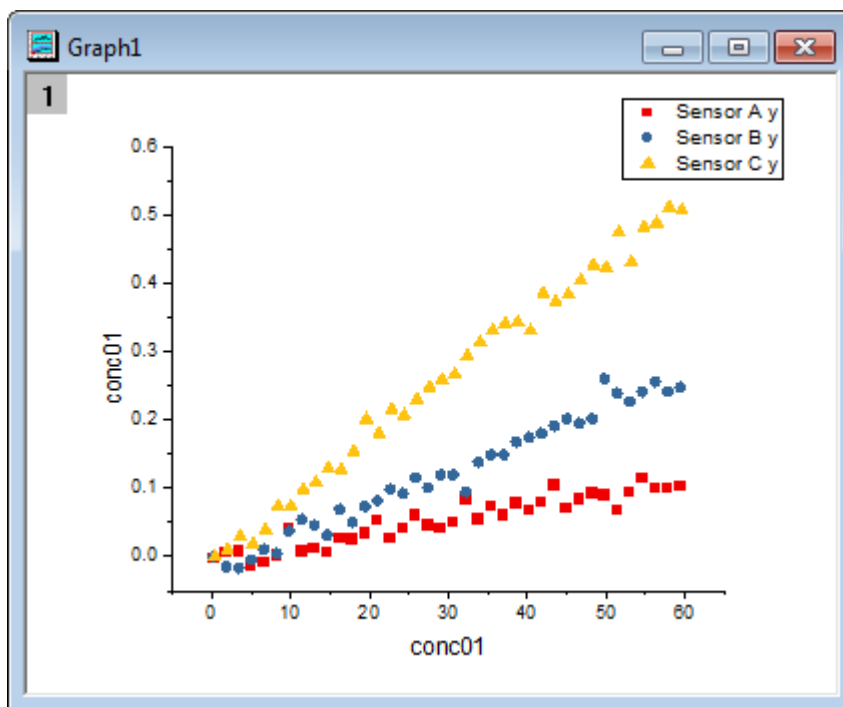

3. Select **Gadgets: Quick Fit: 1 Linear(System)** from the main menu to add a region-of-interest (ROI) box on the graph. Click the arrow button  and select **Expand to Full Plot(s) Range** from the fly-out menu to expand the ROI box to the full plot range.

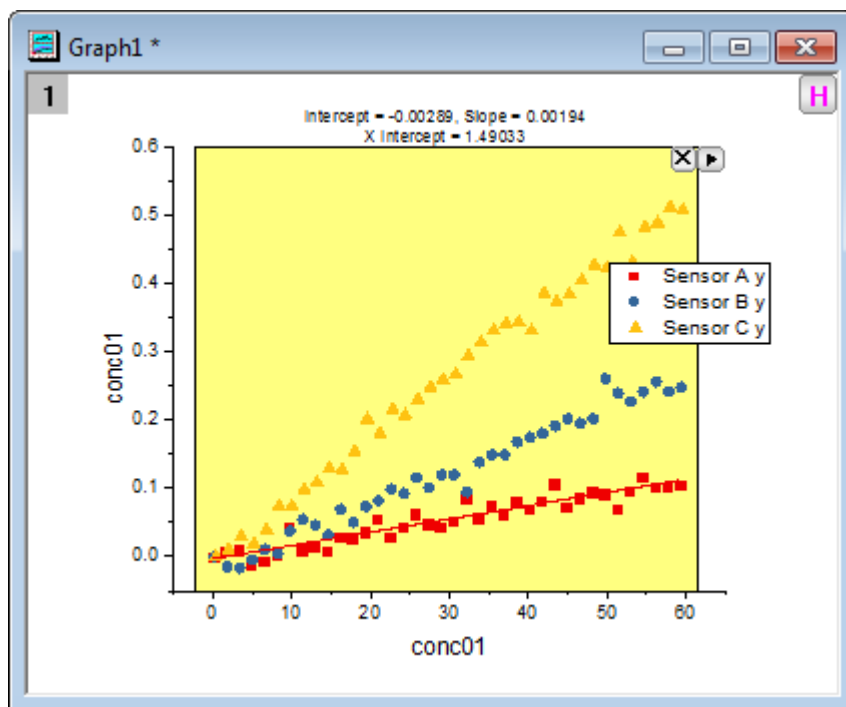

4. Click the arrow button  and select **Preferences...** from the fly-out menu. This opens the **Quick Fit Preferences** dialog. In this dialog, go to the **Label Box** tab, select **Equation with Values** for the **Equation** drop-down list.

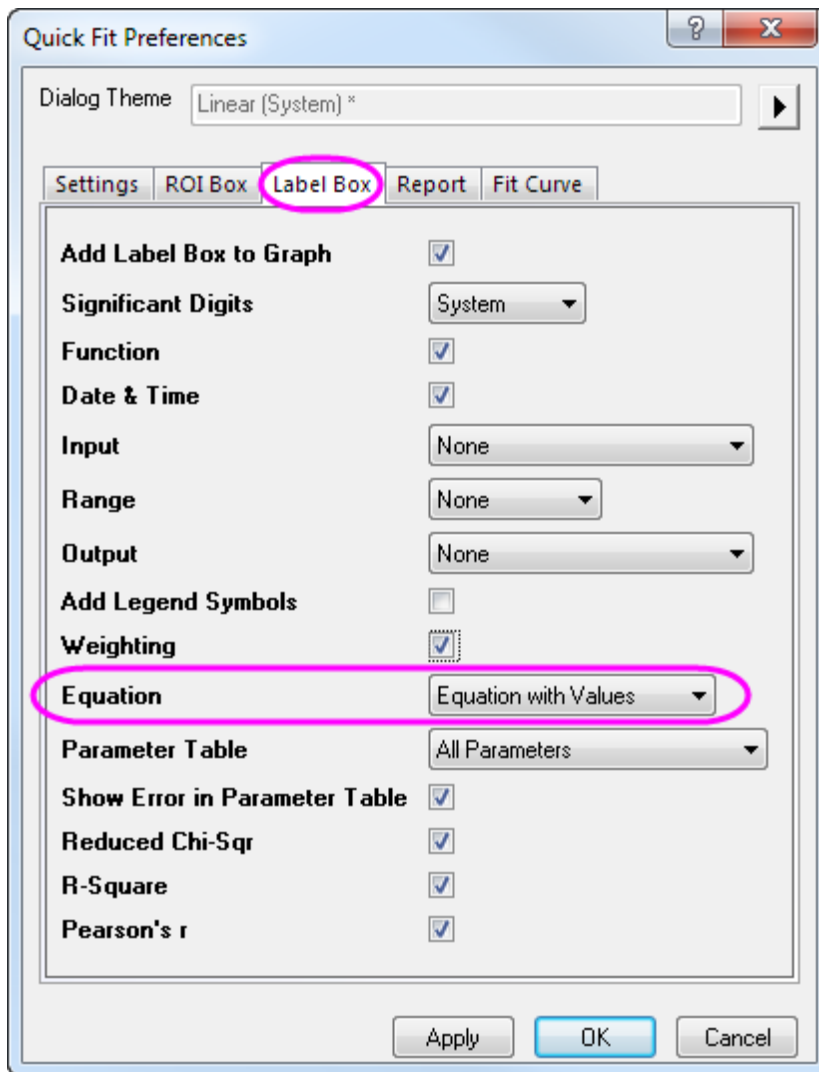

5. Go to the **Report** tab, select **Worksheet** for the **Output To** drop-down list.

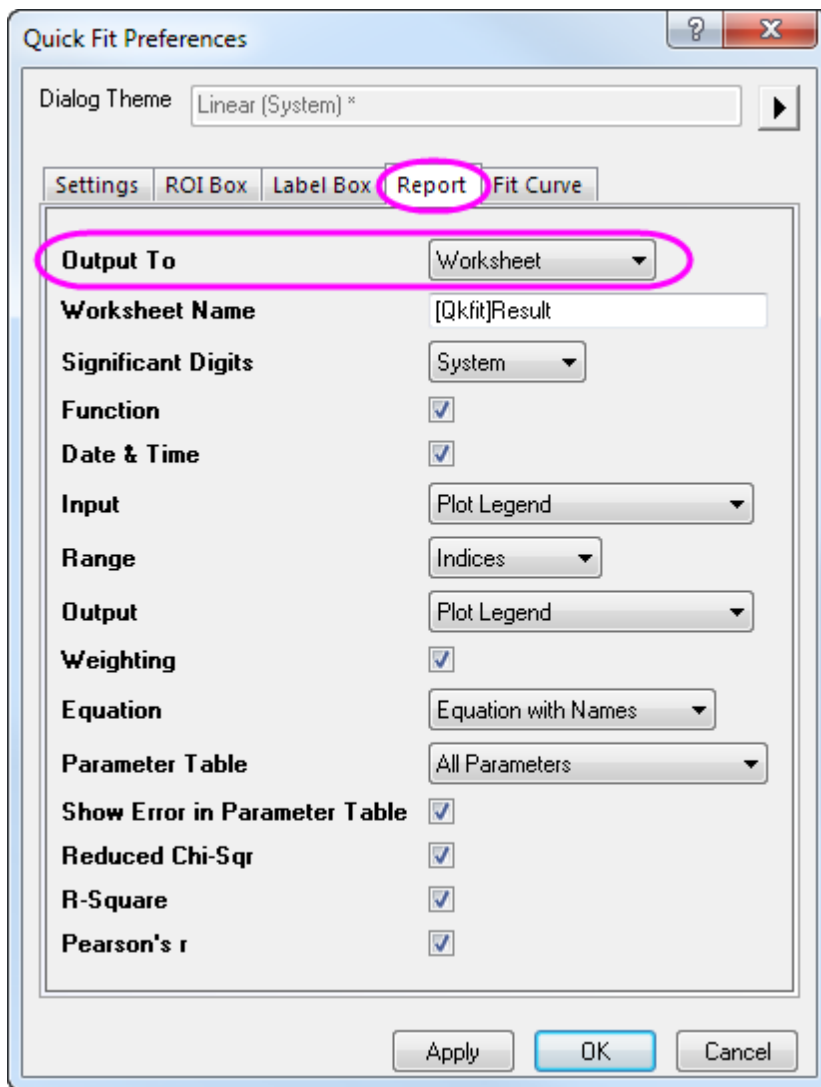

6. Click **OK** to close this dialog. Click the arrow button  to select **New Output** from the fly-out menu. This outputs the plot fitting results "Sensor 01" to the report worksheet and adds a label box to the graph window. The label box reports your analysis results.

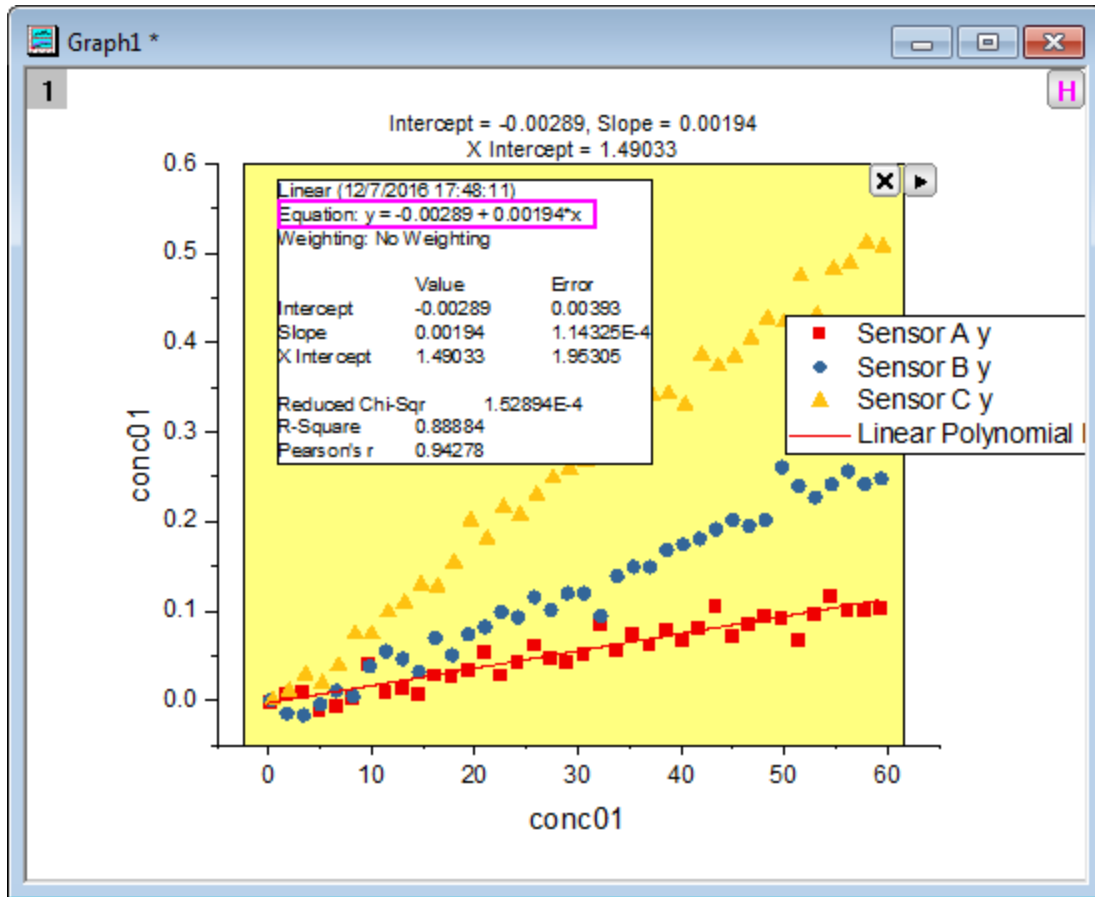

7. Select the label box on the graph and delete it. Click the arrow button and select **Preferences...** from the fly-out menu. This opens the **Quick Fit Preferences** dialog. In this dialog, go to **Label Box** tab, uncheck the **Add Label Box to Graph** check box and click **OK**.
8. Click the arrow button again to select **New Output for All Curves(N)** from the fly-out menu, so that the customized linear fit process will be performed on all data plots.
9. Click the arrow button one more time to select **Go to Report Worksheet**. You will see the fitting results of all three plots in the report worksheet. Note, the first result row has been created at step 6 above and the last three rows are our current results.

Long Name	Function	Input	Range	Output	Equation	Weighting	Intercept	H(yEr?)	I(Y)	J(yEr?)
F(x)=										
1	Linear	Sensor A y	[1*.38*]	#####	y = Intercept + Slope*x	No Weighting	-0.00289	0.00393	0.00194	1.14325E-4
2	Linear	Sensor A y	[1*.38*]	#####	y = Intercept + Slope*x	No Weighting	-0.00289	0.00393	0.00194	1.14325E-4
3	Linear	Sensor B y	[1*.38*]	#####	y = Intercept + Slope*x	No Weighting	-0.02068	0.00442	0.00478	1.27723E-4
4	Linear	Sensor C y	[1*.38*]	#####	y = Intercept + Slope*x	No Weighting	-0.00389	0.00451	0.00882	1.29786E-4

Note: With the ROI box shown on graph, you can click the arrow button to select **Switch to Linear**

**Fit...** from the fly-out menu to transfer your current settings to the **Linear Fit** dialog. Then, you can do further operations in this more powerful dialog to do linear fitting.

#### 4.2.8.3.2 Nonlinear Curve Fit

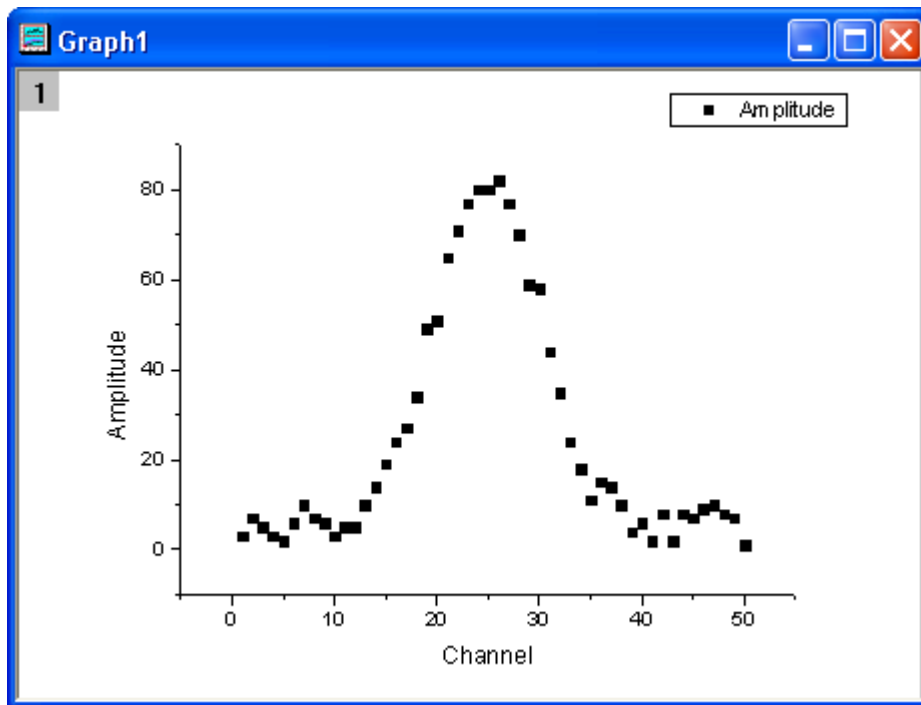

1. Start with a new workbook and import the Origin sample data **Gaussian.DAT** which is located in *<Origin Program Folder>\Samples\Curve fitting* path.
2. Highlight the Col(B) and select **Plot>2D: Scatter: Scatter** from the Origin menu to draw a graph.



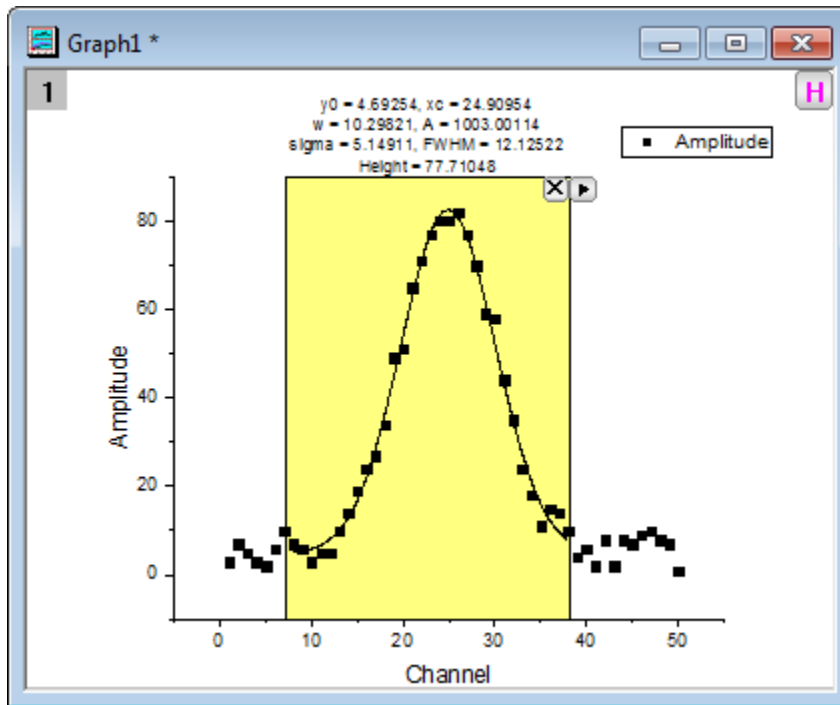

3. Select **Gadgets: Quick Fit: 4 Peak - Gauss (System)** from the Origin menu to add a ROI box to the graph.





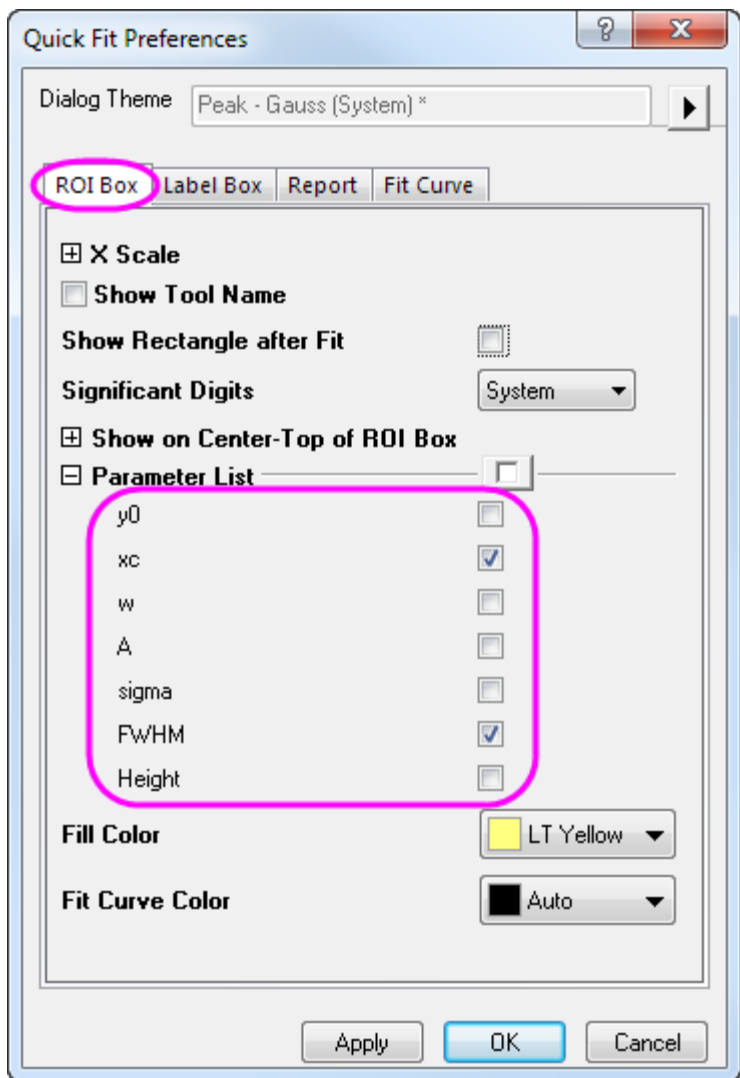

4. Click the arrow button  to select **Expand to Full Plot(s) Range** from the fly-out menu to expand the ROI box to the full plot range.
5. Click the arrow button  and select **Preferences...** from the fly-out menu. This opens the **Quick Fit Preferences** dialog. In this dialog, go to the **ROI Box** tab, and set the **Parameter List** as below.

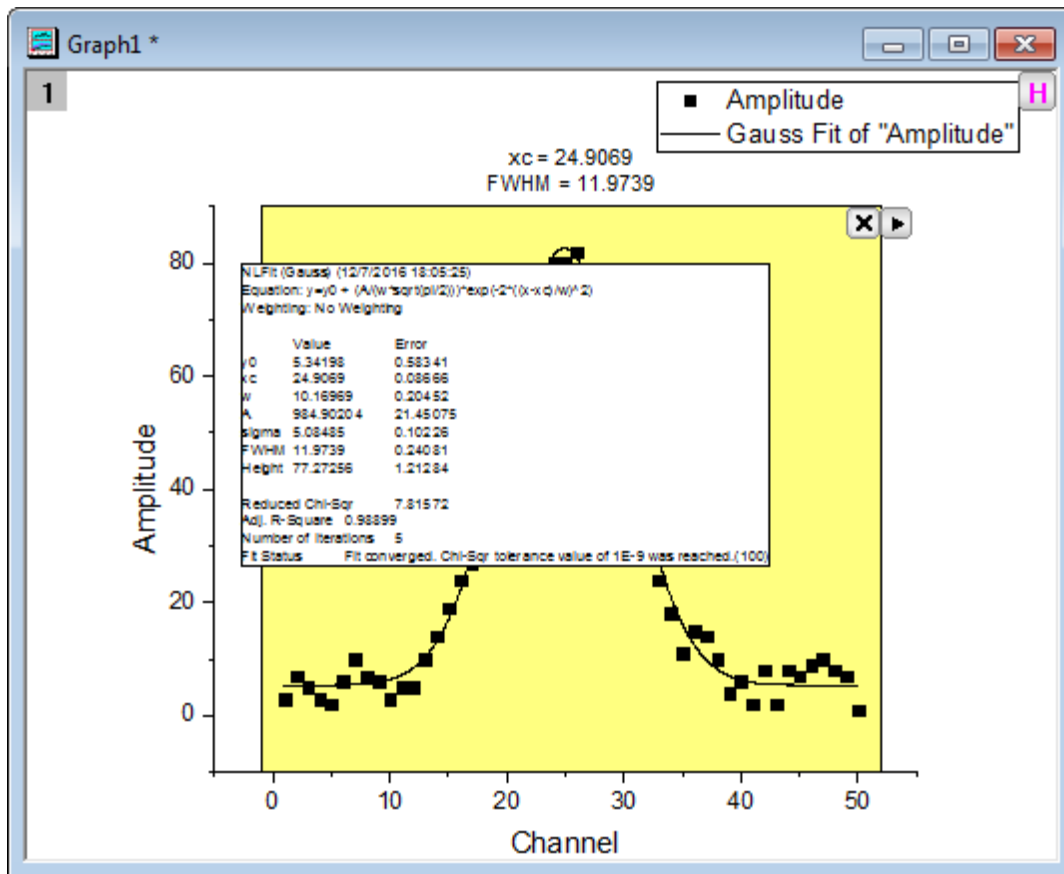

6. Click **OK** to close this dialog. Click the arrow button  and select **New Output** from the fly-out menu. A label box will be added to the graph as shown below.



- Click the arrow button  and select **Preferences...** from the fly-out menu. This opens the **Quick Fit Preferences** dialog again. In this dialog, go to the **Label Box** tab, choose **Use ROI Box Tab Settings** for **Parameter Table**. Click **OK** to close this dialog.

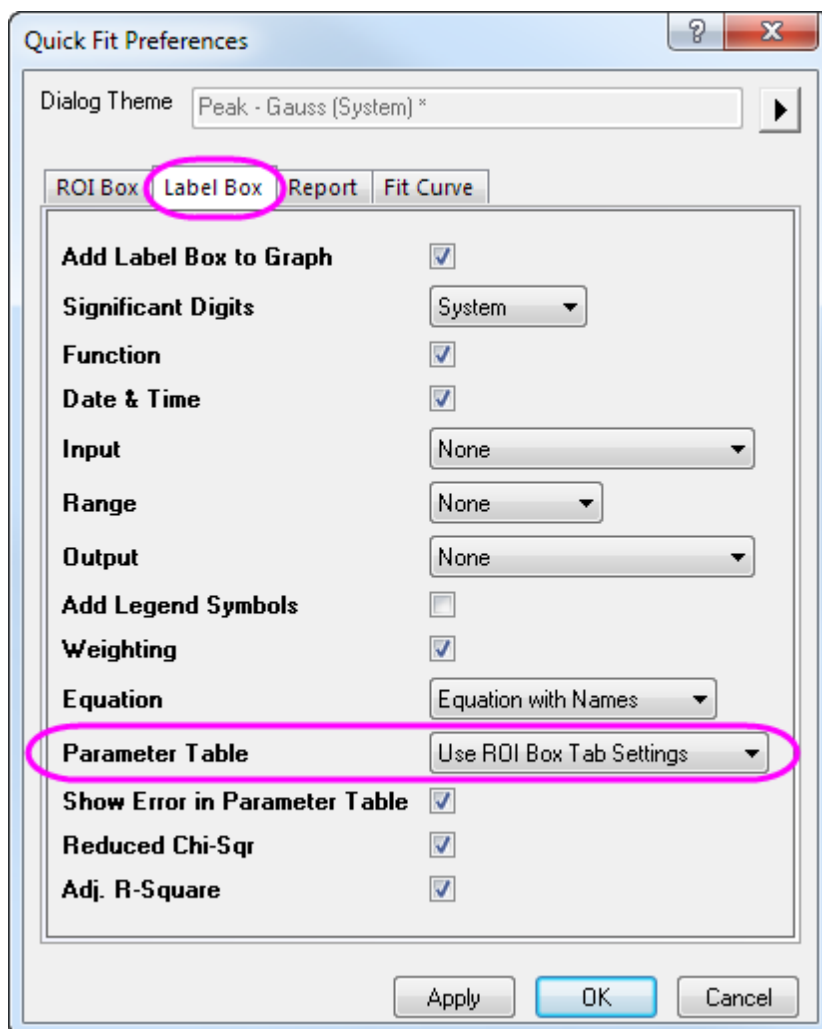

- Click the arrow button  and select **Update Last Output** from the fly-out menu. The Label box will be updated and only the parameters "xc" and "FWHM" will be displayed.

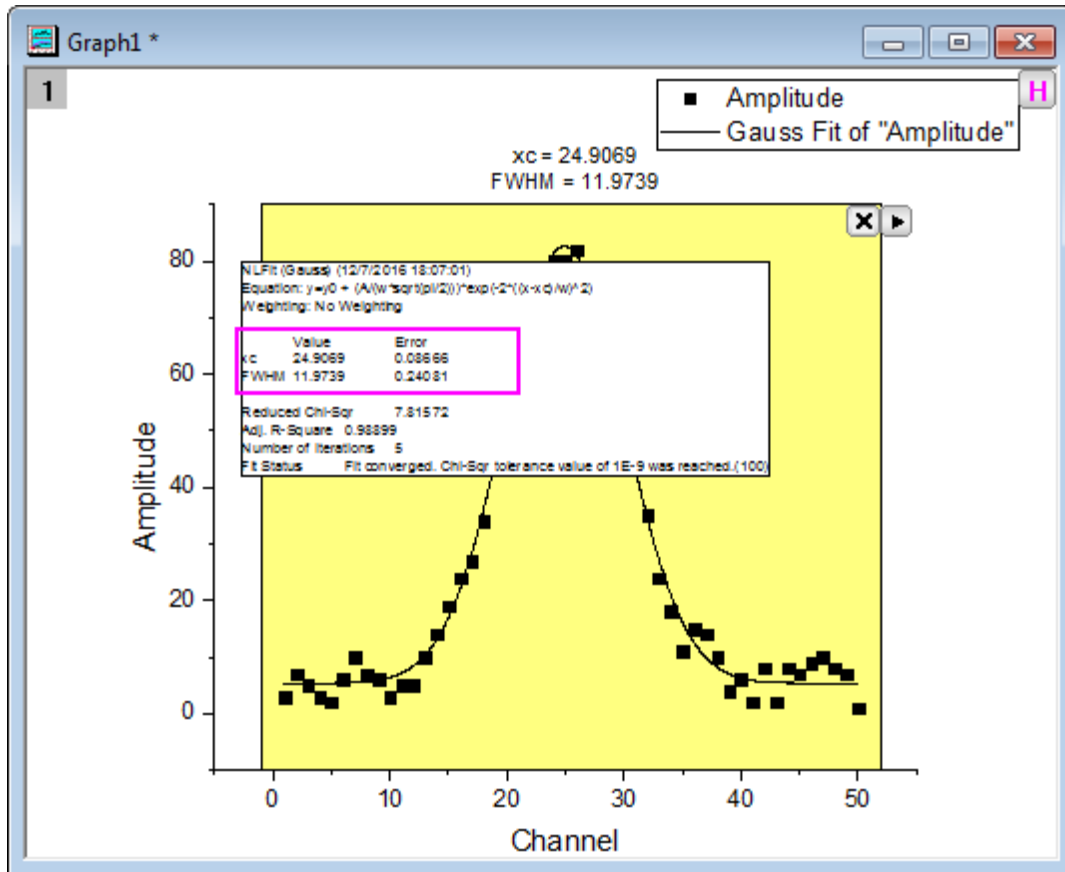

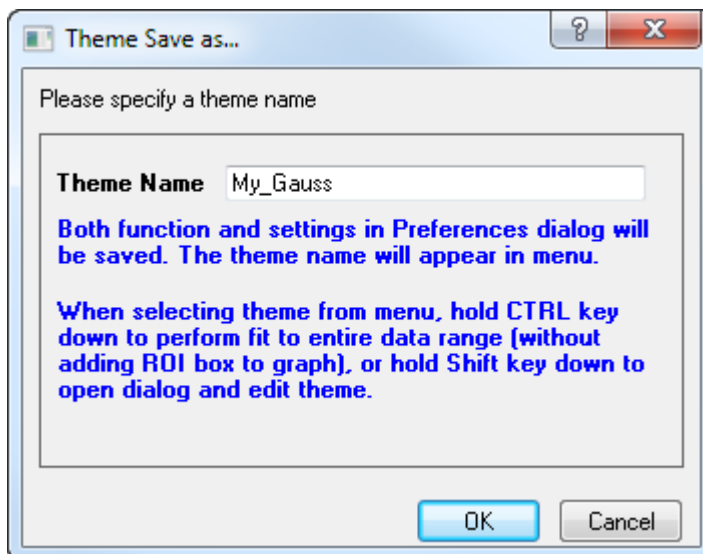

9. Click the arrow button  and select **Save Theme** from the fly-out menu. In the **Theme Save as...** dialog, set the **Theme Name** as *My\_Gauss* and click **OK**.

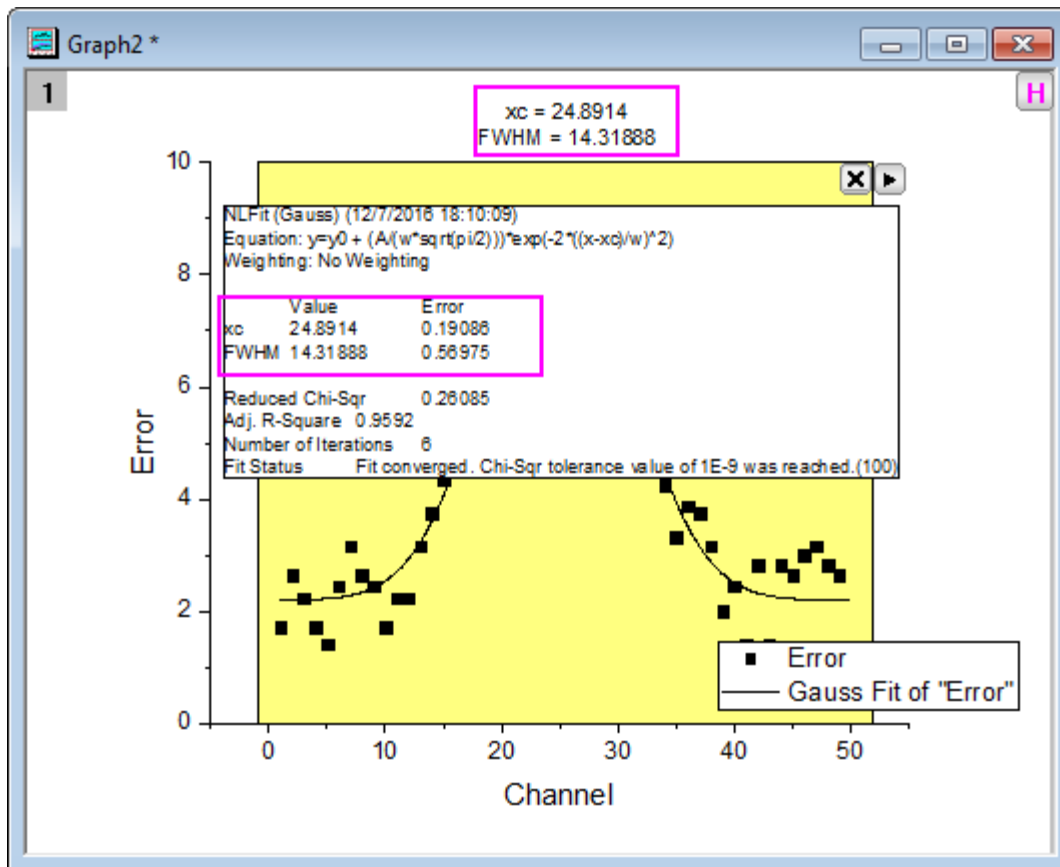

10. Go back to the worksheet, highlight col(C) and select **Plot>2D: Scatter: Scatter** from the top menu. This draws a scatter graph.

11. Click on the new plot to activate it and select **Gadgets: Quick Fit: 9 My\_Gauss** to load the theme. A ROI box will be added to the graph with parameters *xc* and *FWHM* displaying above the ROI.
12. Click the arrow button  to select **Expand to Full Plot(s) Range** from the fly-out menu to expand the ROI box to the full plot range, and then select **New Output** from the fly-out menu to output the result. You can see that our theme is applied as the label box on the graph only reports the values of parameter "xc" and "FWHM".



Note: With the ROI box shown on graph, you can click the arrow button  to select **Switch to NLFit...** from the fly-out menu to transfer your current settings to the **NLFit** dialog. Then, you can do further operations in this more powerful dialog to do nonlinear fitting.

### 4.2.9 Quick Peaks Gadget

#### 4.2.9.1 Summary

The Quick Peaks gadget can be used to pick peaks, subtract baseline, integrate the peaks and/or fit peaks in a ROI (Region of Interest). It is also possible to use this tool in combination with the **Peak Analyzer**. Please refer to [this tutorial](#) for details.



Minimum Origin Version Required: Origin 2015 SR1

4.2.9.2 What you will learn

This tutorial will show you how to:

- Find and subtract baseline for spectrum with the Quick Peaks gadget.
- Find peaks on the graph with the Quick Peaks gadget.
- Customize preference settings.

4.2.9.3 Steps

1. Create a new workbook by clicking the **New Workbook** button . Click the **Import Single ASCII** button  and import the **Zircon.dat** file in the `<Origin Folder>\Samples\Spectroscopy\` path. Both buttons are located on the **Standard** toolbar.
2. Highlight Col(B) and plot a line graph with the **Line**  button on the **2D Graphs Toolbar**.
3. Select **Gadgets: Quick Peaks** from the main menu and open the **Data Exploration: addtool\_quickpeaks** dialog.
4. On the **Baseline** tab, set **Mode** to **2D Derivative**, and then set **Range** to **Full Plot Range**. Click **OK** to apply.

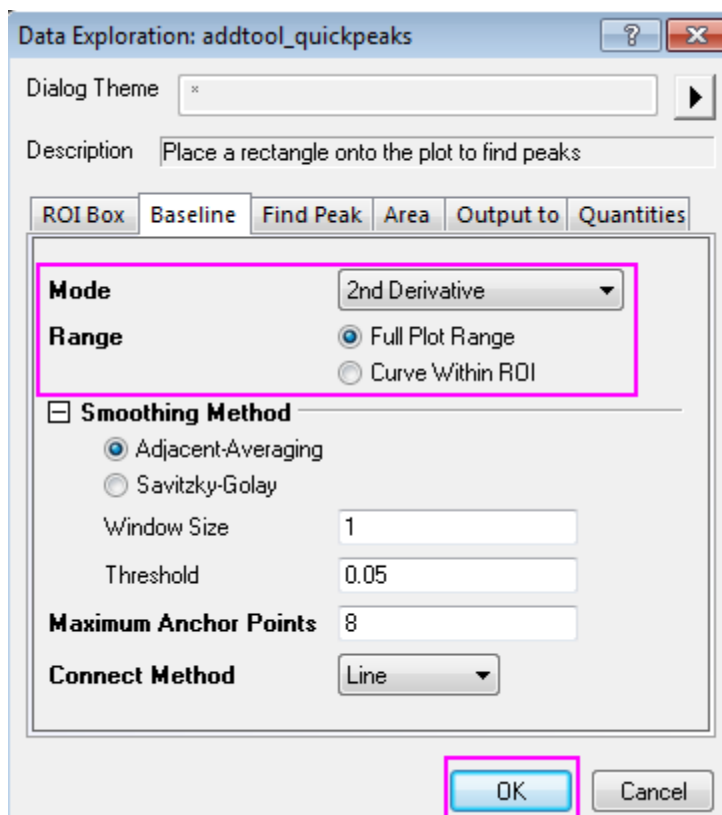

- The peaks within the yellow ROI box will be found and marked. Resize the ROI box so that it covers X range[0,7000] as shown in graph below, the baseline and peak finding need a further refinement.

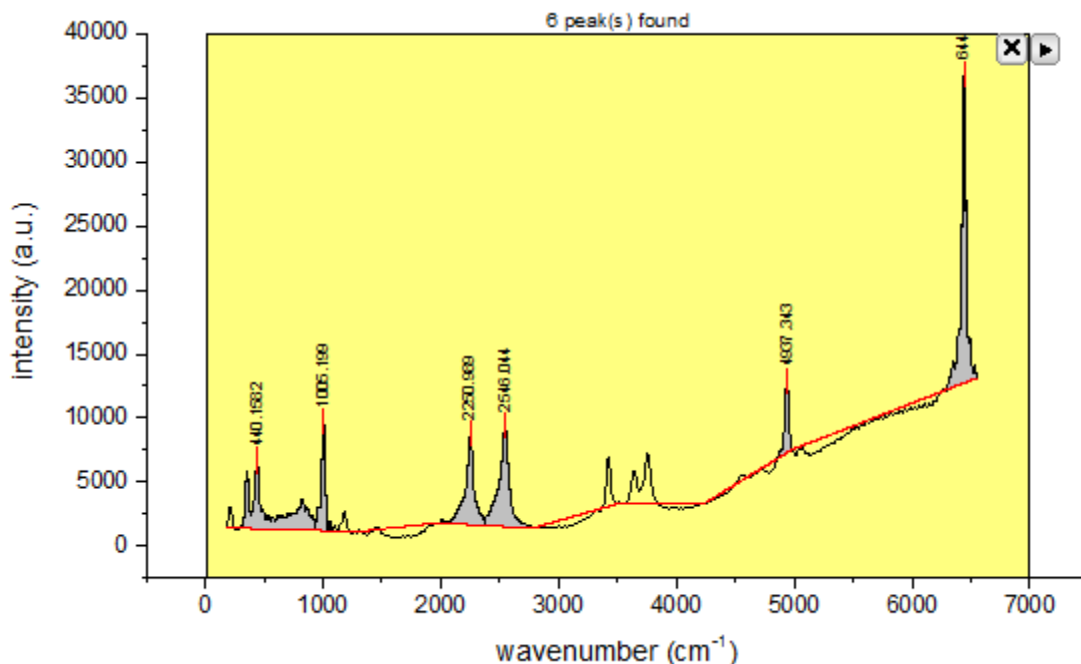

- Click the triangle button  and select **Preference** from the fly-out menu, so you can further adjust the **Smoothing Method** in **Baseline** tab follows the graph:

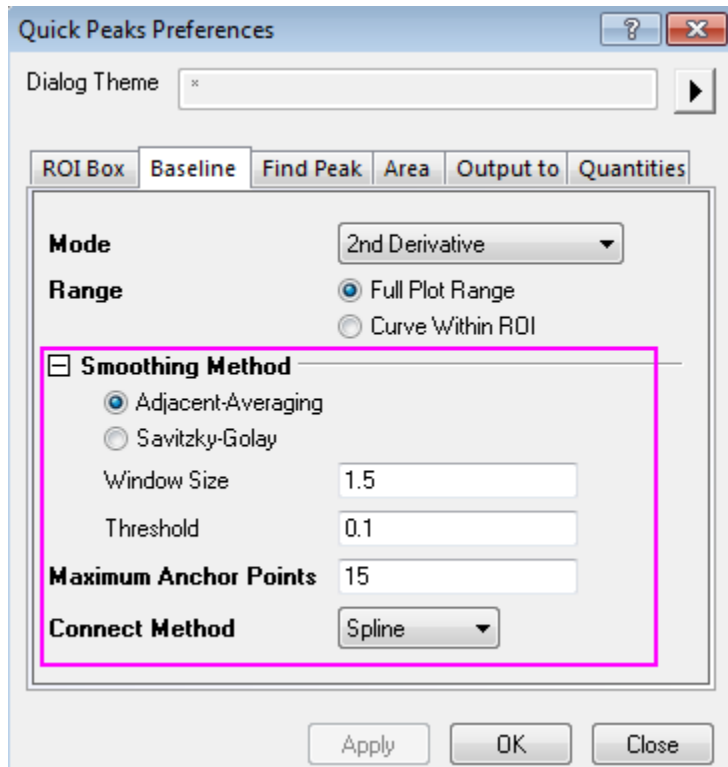



click Apply to apply, and further adjust the values in **Find Peak** tab:

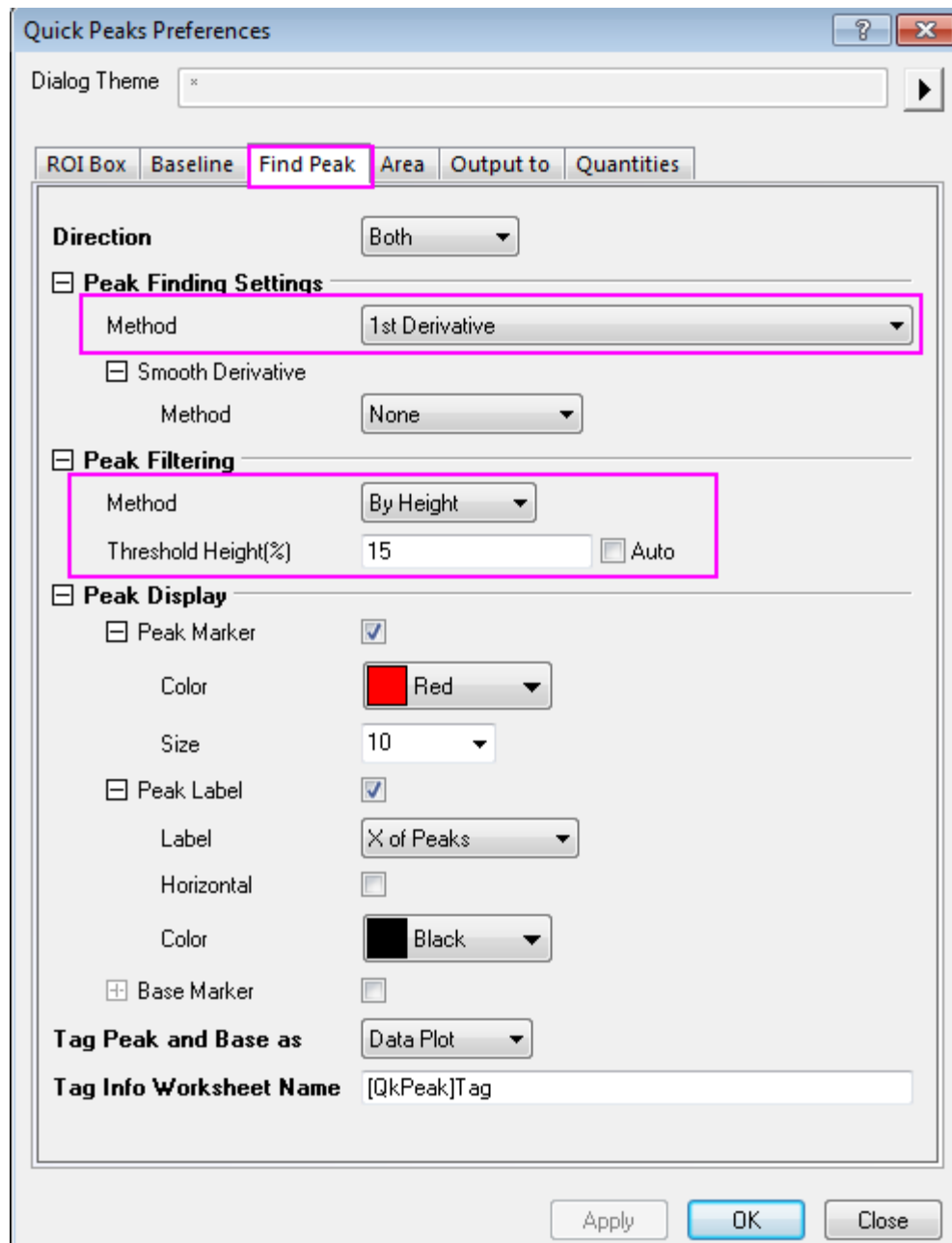

7. Click **OK** to apply the settings and close the dialog, the baseline and peaks finding are better than before which can be attribute to the optimizing **Threshold** and **Maximum Anchor Points** for Baseline and

**Threshold Height%** for Find peak:

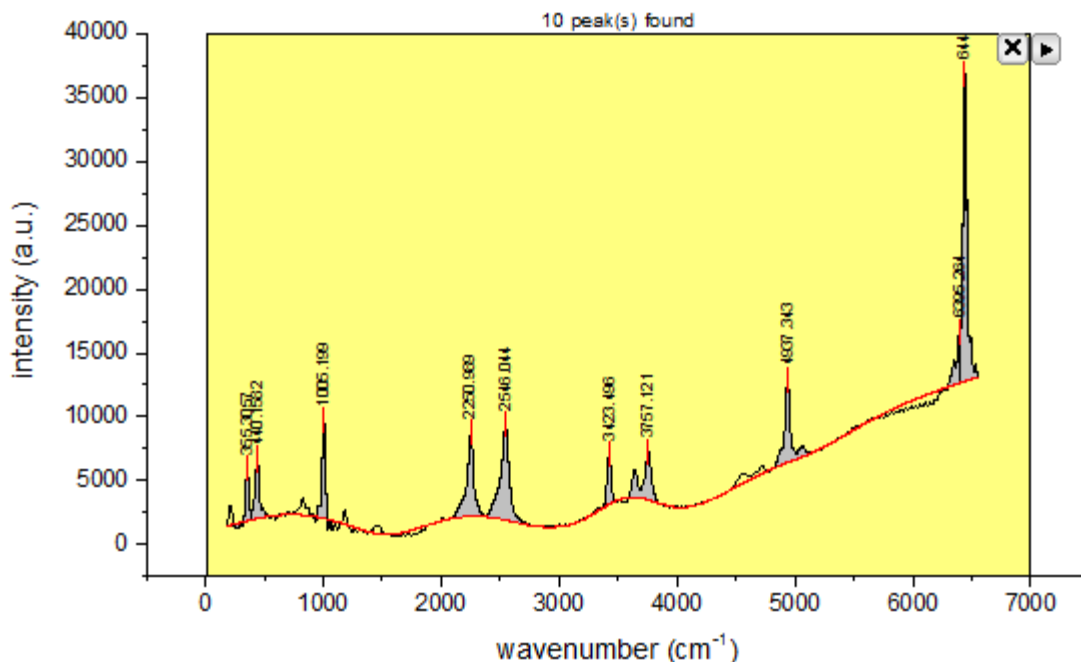

- Click the triangle button  and select **New Output** from the fly-out menu to output the peak finding results to a report worksheet.

Return to the gadget fly-out menu and select **Go to Report Worksheet** to view the quantities output :

Peak ID	Peak Row	Peak X	Peak Y	Height	Peak Area	FWHM
				Peak Height from Baseline		
Peak 1	94	355.3057	5883.32381	4019.38518	105810.63852	31.85037
Peak 2	138	440.1582	6622.58143	4579.30486	212770.49866	38.0693
Peak 3	431	1005.199	9687.95699	7641.00995	262292.12444	31.93732
Peak 4	1077	2250.989	8735.86589	6521.97313	477231.3539	49.19588
Peak 5	1230	2546.044	9375.11743	7460.46176	686897.33207	67.08458
Peak 6	1685	3423.496	7014.48113	3883.05102	160646.49519	37.93742
Peak 7	1858	3757.121	7245.12389	3742.14765	359968.10298	153.43826
Peak 8	2470	4937.343	12846.63008	6434.46253	432380.73801	42.80683
Peak 9	3226	6395.264	16607.24058	3959.88794	180348.37354	27.24009
Peak 10	3250	6441.547	36844.54608	24051.37853	1.07438E6	37.18174

- Activate the graph window to which the gadget was applied, click the triangle button  and select **Subtract Baseline**, click **OK** for pop-up window, the baseline was subtract from the data:  
Click cross button on the top left corner to close the gadget. The finished graph is shown like this:

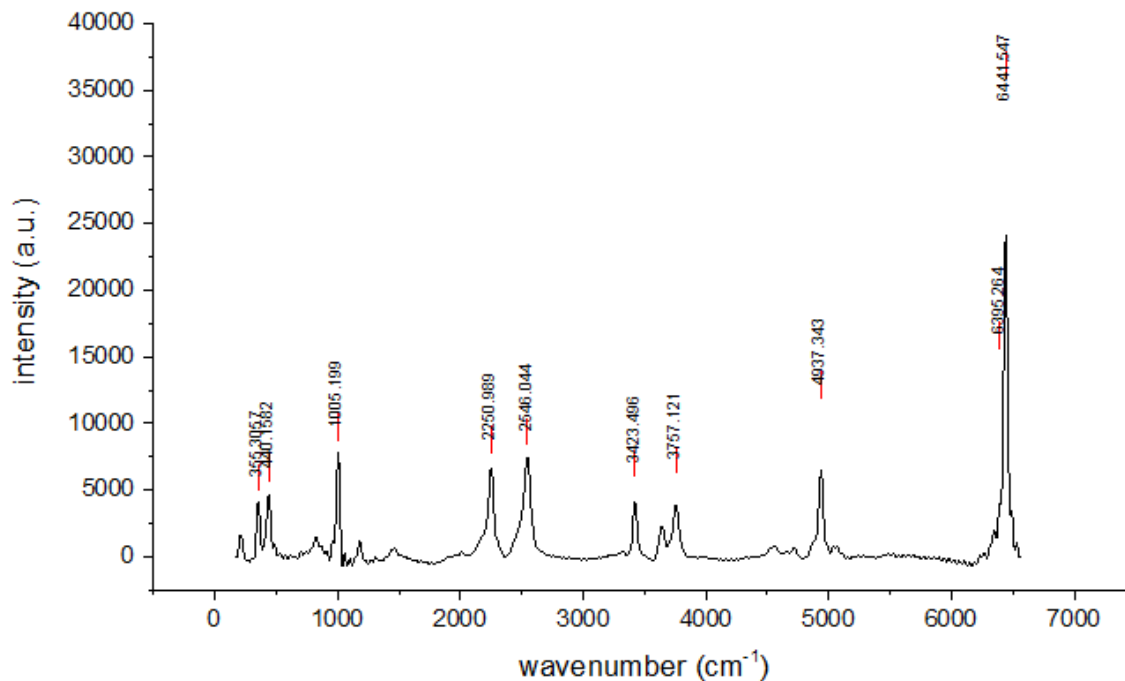

**Note:** For advanced fitting options, you can [combine Quick Peaks gadget with Peak Analyzer](#).

## 4.2.10 Quick Sigmoidal Fit Gadget

### 4.2.10.1 Summary

The Quick Sigmoidal Fit gadget can be used to quickly perform a sigmoidal fit on a portion of your graph that you define interactively as your region of interest (ROI).

Minimum Origin Version Required: Origin 2015 SR0

### 4.2.10.2 What you will learn

- How to use the Quick Sigmoidal Fit gadget on a graph.
- How to select your fitting options.
- How to switch to the NLFit dialog.
- How to output the fitting result.
- How to find X/Y values on the fit curve.

### 4.2.10.3 Steps

This tutorial is associated with <Origin EXE Folder>\Samples\Tutorial Data.opj.

#### 4.2.10.3.1 Quick Fit

1. Open **Tutorial Data.opj** and browse to the **Quick Sigmoidal Fit Gadget** folder in **Project Explorer** (PE).
2. Highlight Col(A) through Col(D) in the workbook **DoseResponseN** and from the menu choose **Plot:Symbol:Scatter** to plot a scatter graph.

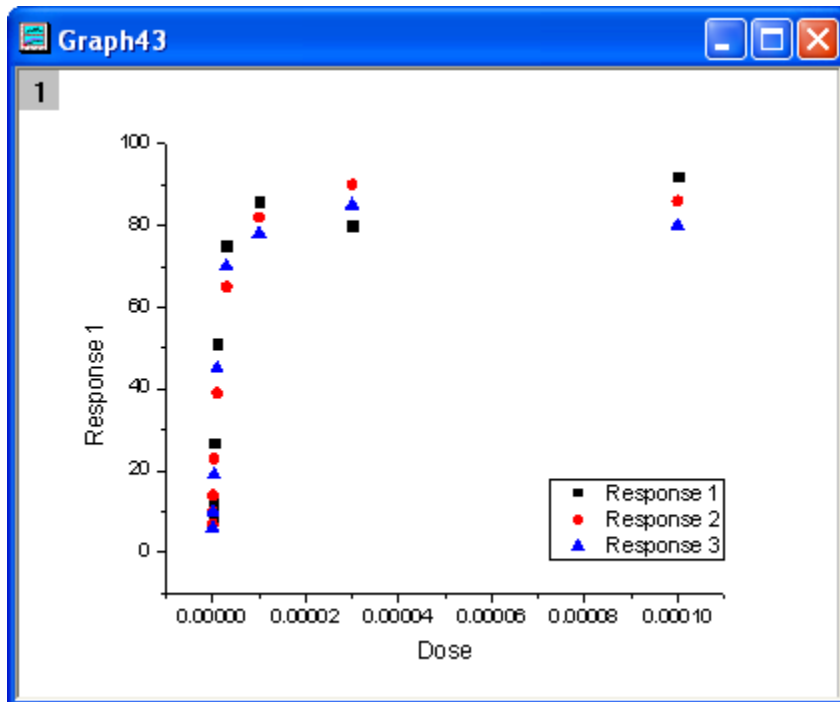

3. Double-click the X axis to open **Axis** dialog. In the **Scale** tab, set the **Type** as *Log10* and click **OK** button to close the dialog.

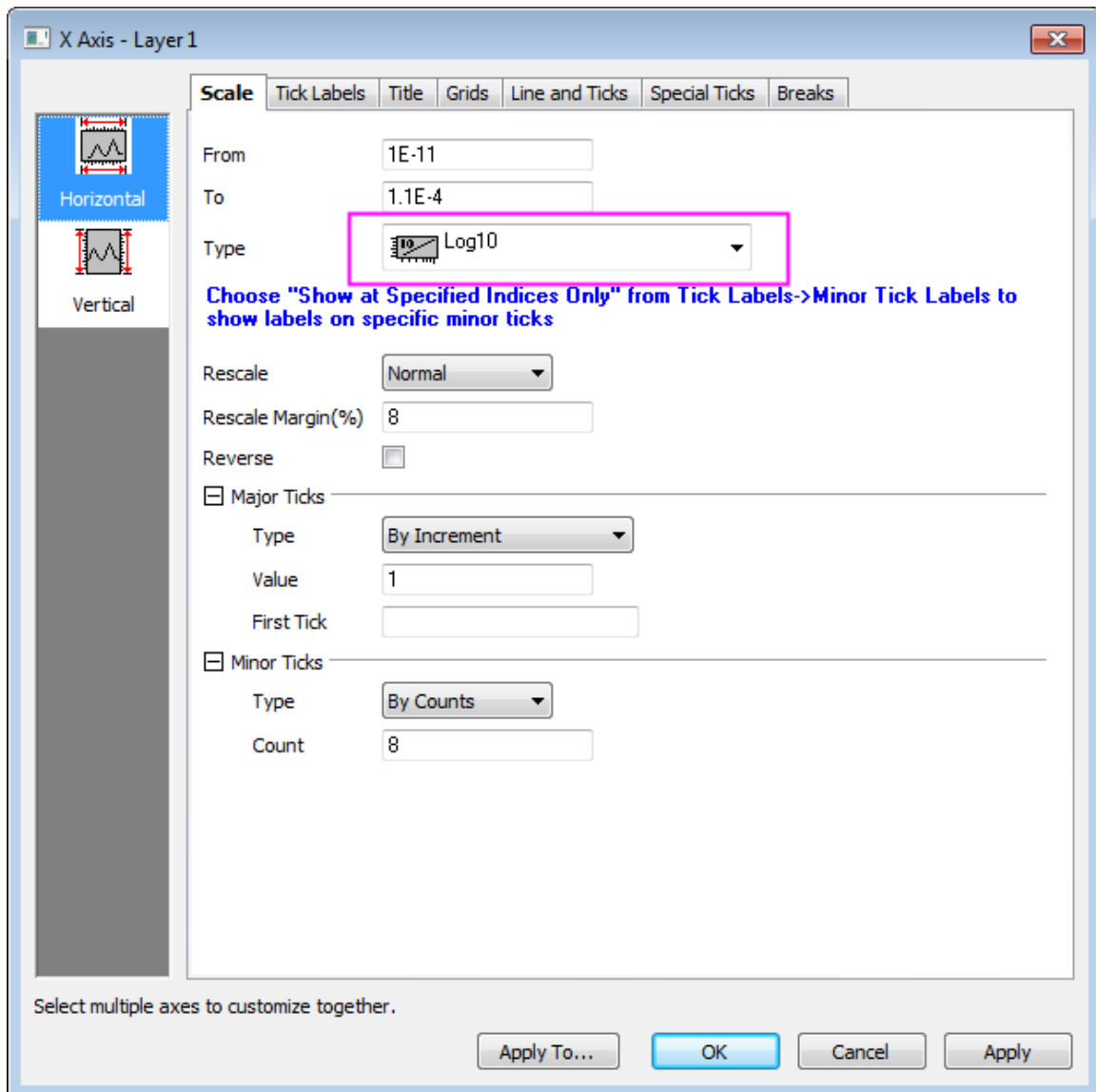

4. Click the **Rescale** button  to show the plot with the proper scale.

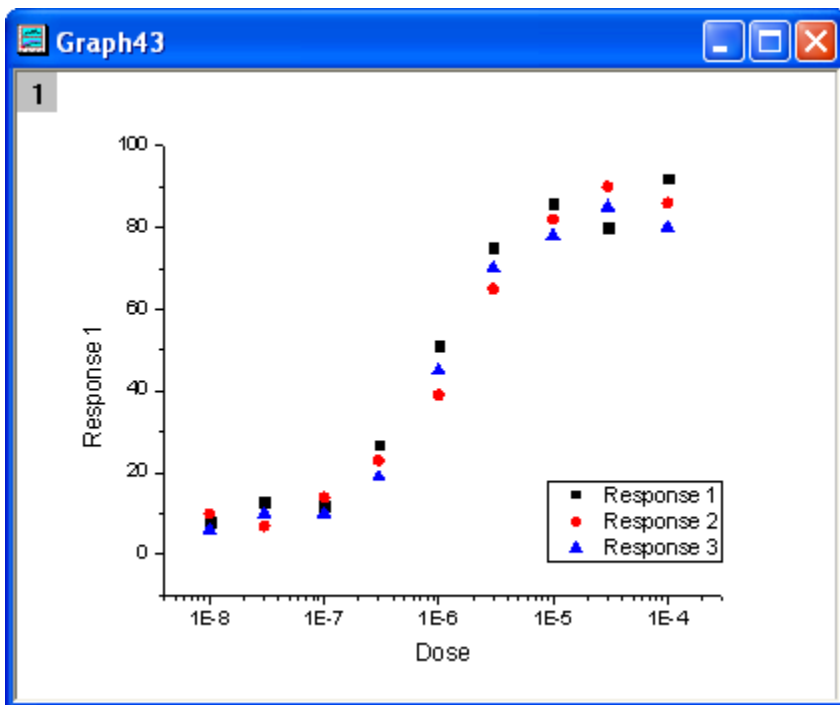

5. Select **Gadgets: Quick Sigmoidal Fit...** from the main menu to open the **addtool\_sigmoidal\_fit** dialog box. Select the function *Logistic5* from the **Function** drop-down list on the **Settings** tab.

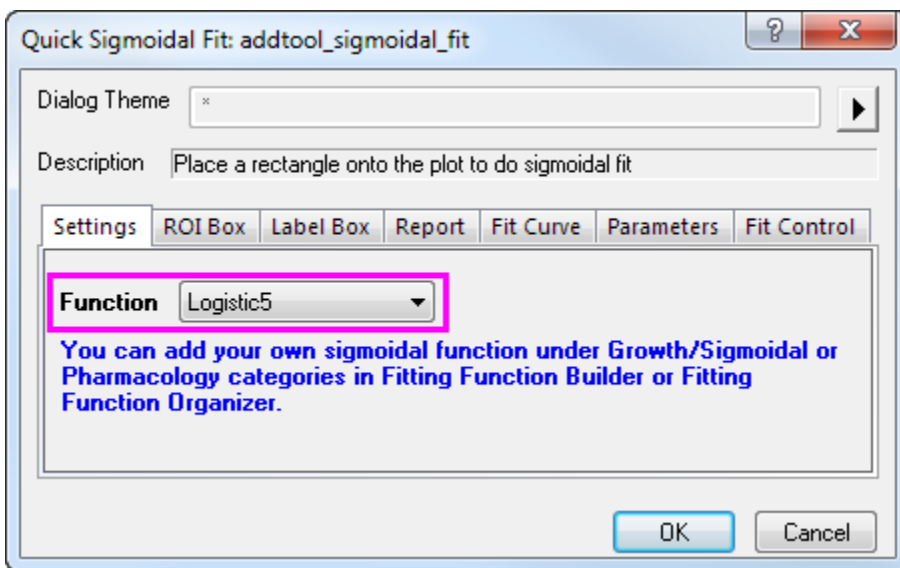

6. Click the **ROI Box** tab and uncheck the parameters  $x_0$ ,  $h$ , and  $s$  under the **Parameter List** branch.

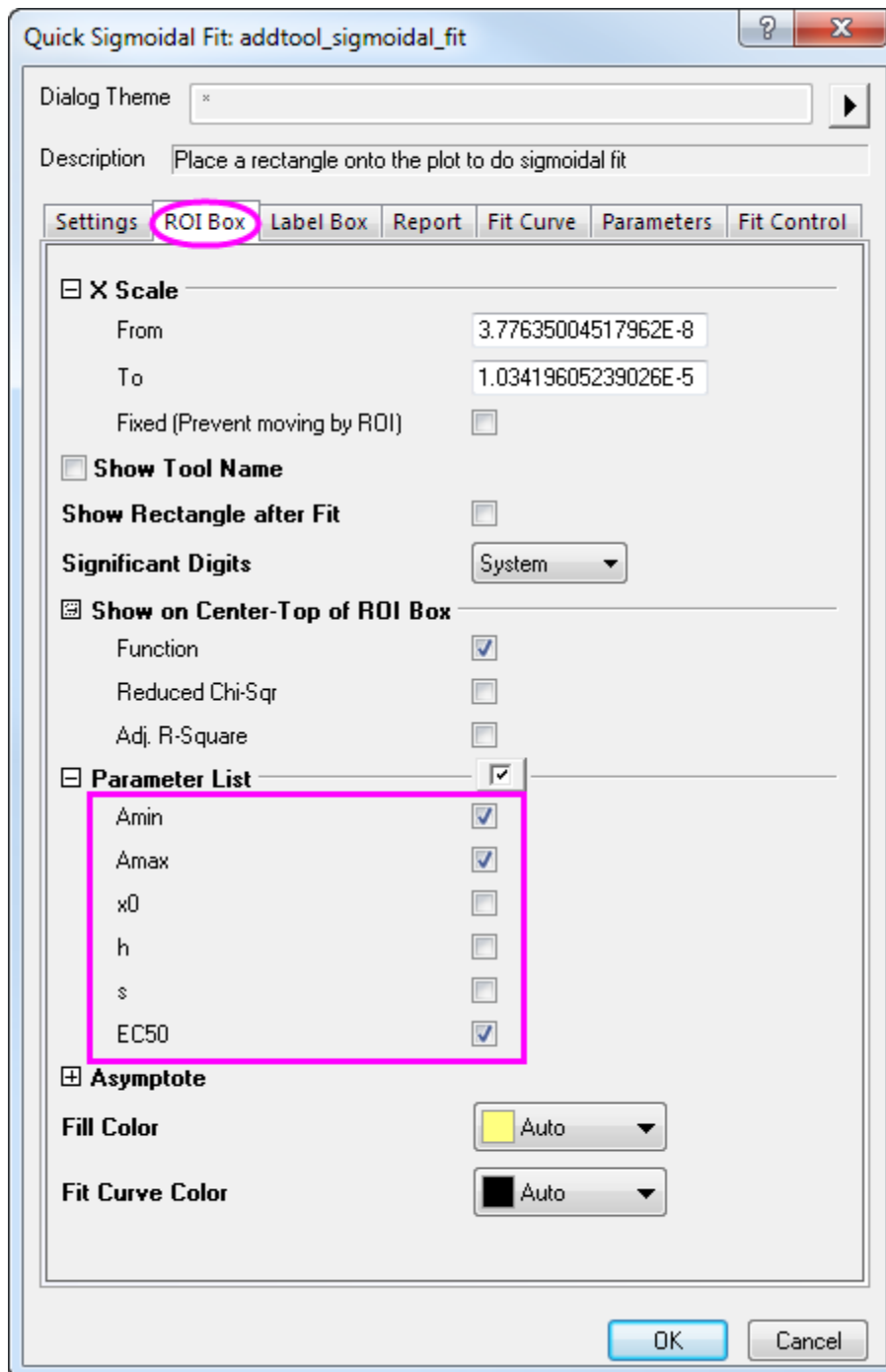

- Click the **Fit Curve** tab, select **Mean, SD** from the **Plot Type** drop-down list and **Source Book, New Sheet** from the **Output Fit Curve To** drop-down list.

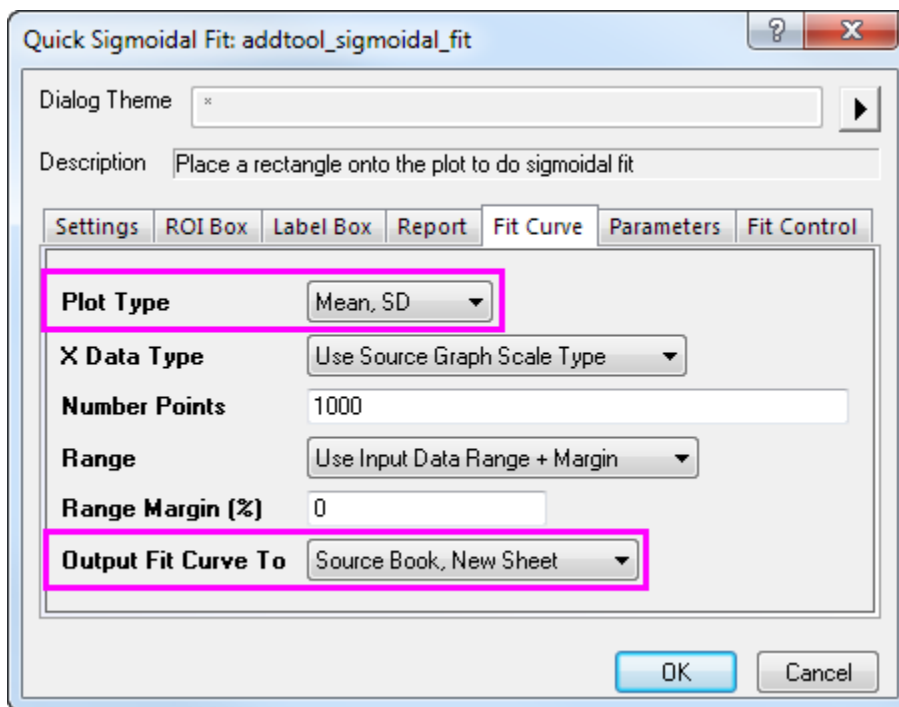

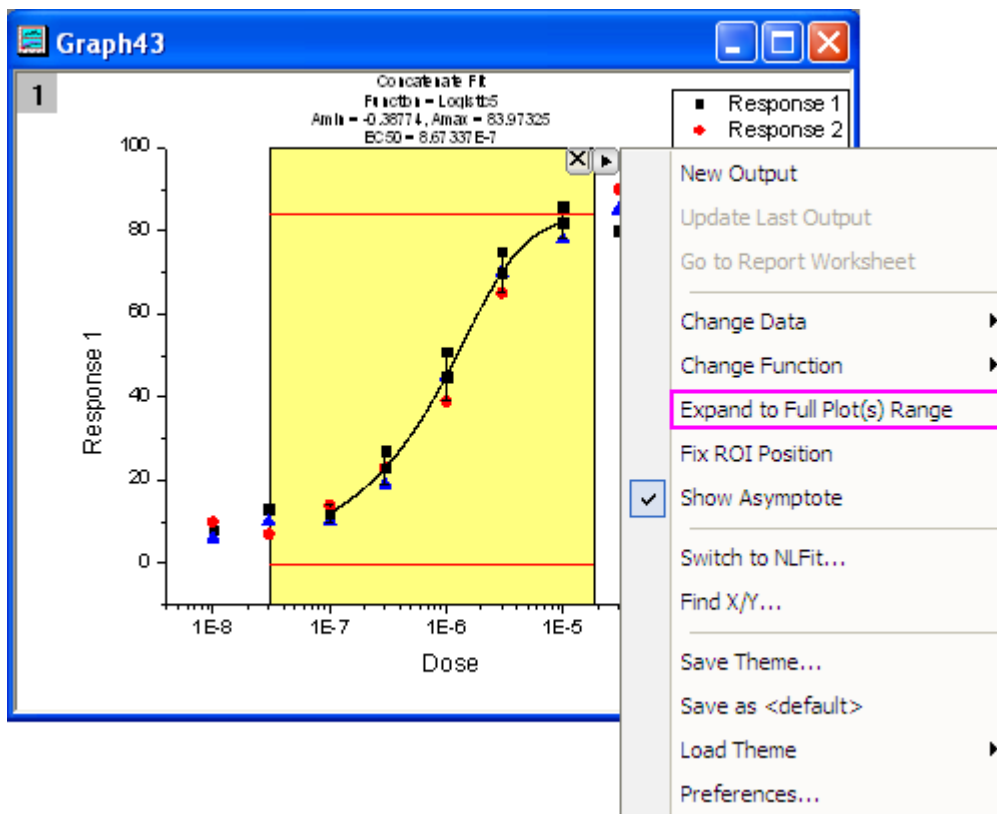

- Click **OK** to add the ROI box to the graph. At the top right corner of the ROI box, click the Arrow button  to select **Expand to the Full Plots Range** from the menu. The ROI box will cover the full data range on the graph.





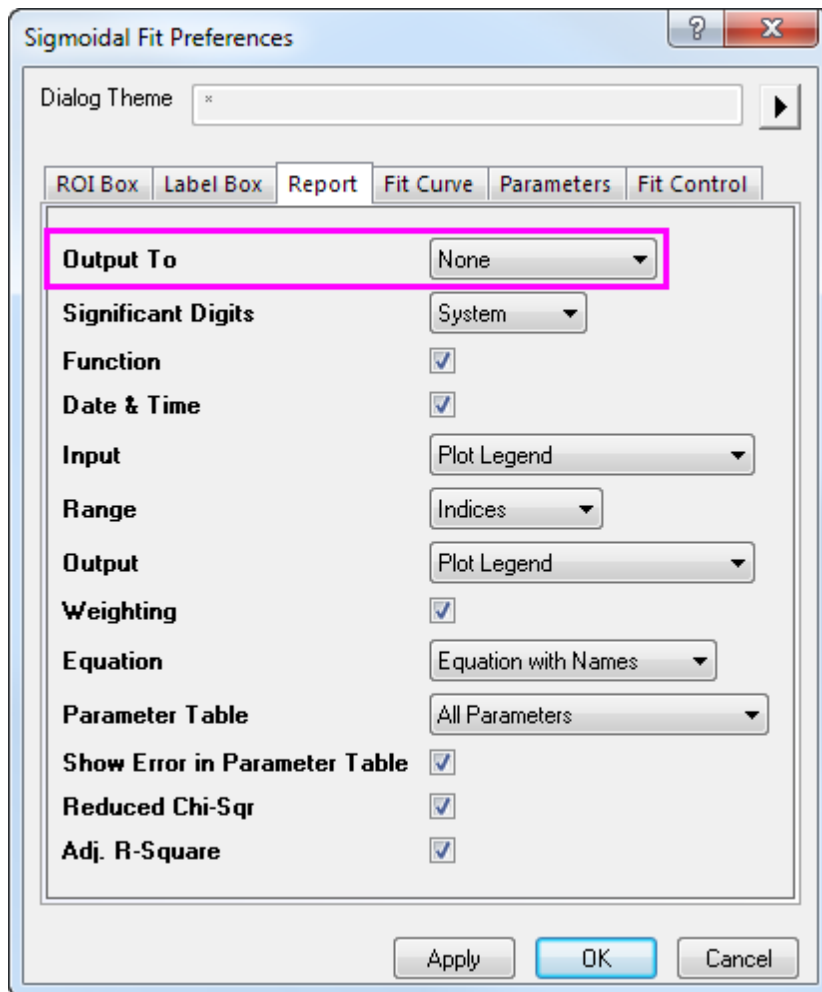

- Click the arrow button  again to select **Preferences...** from the menu. This opens the **Sigmoidal Fit Preferences** dialog box. In this dialog, click the **Report** tab and set **Output To** as *None*.

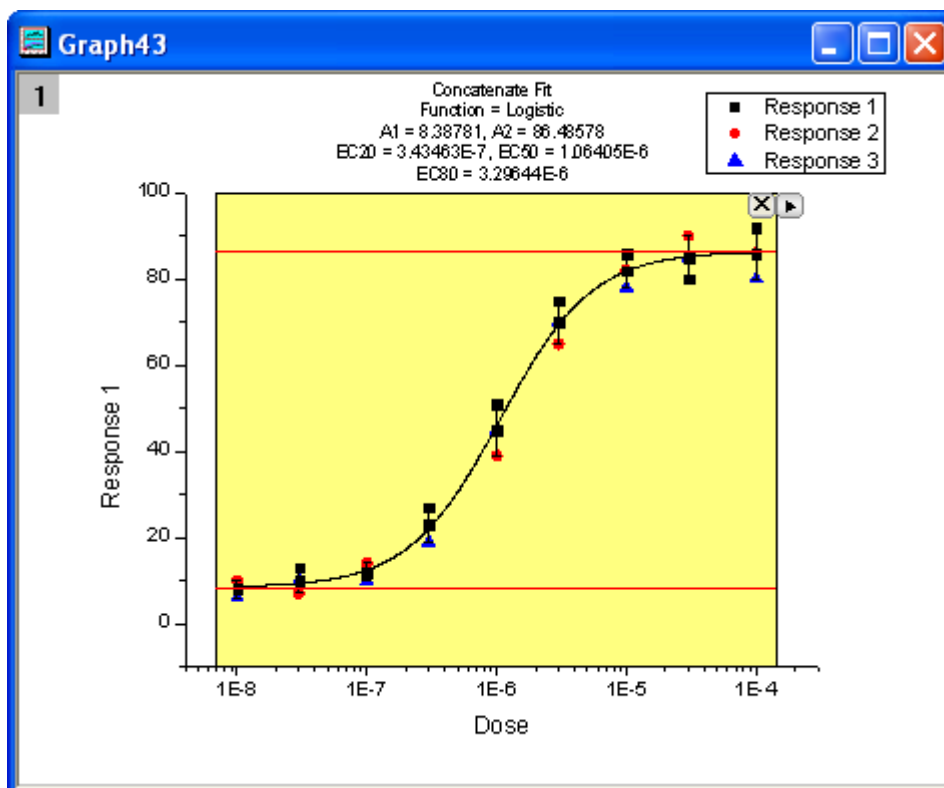

- Click **OK** to close the dialog box. Click the arrow button  to select **Change Function: Logistic** and change the fitting function to *Logistic*. The label text on top of the ROI box will update automatically.



- Click the arrow button  to select **New Output** and output the fitting result to the worksheet and graph.

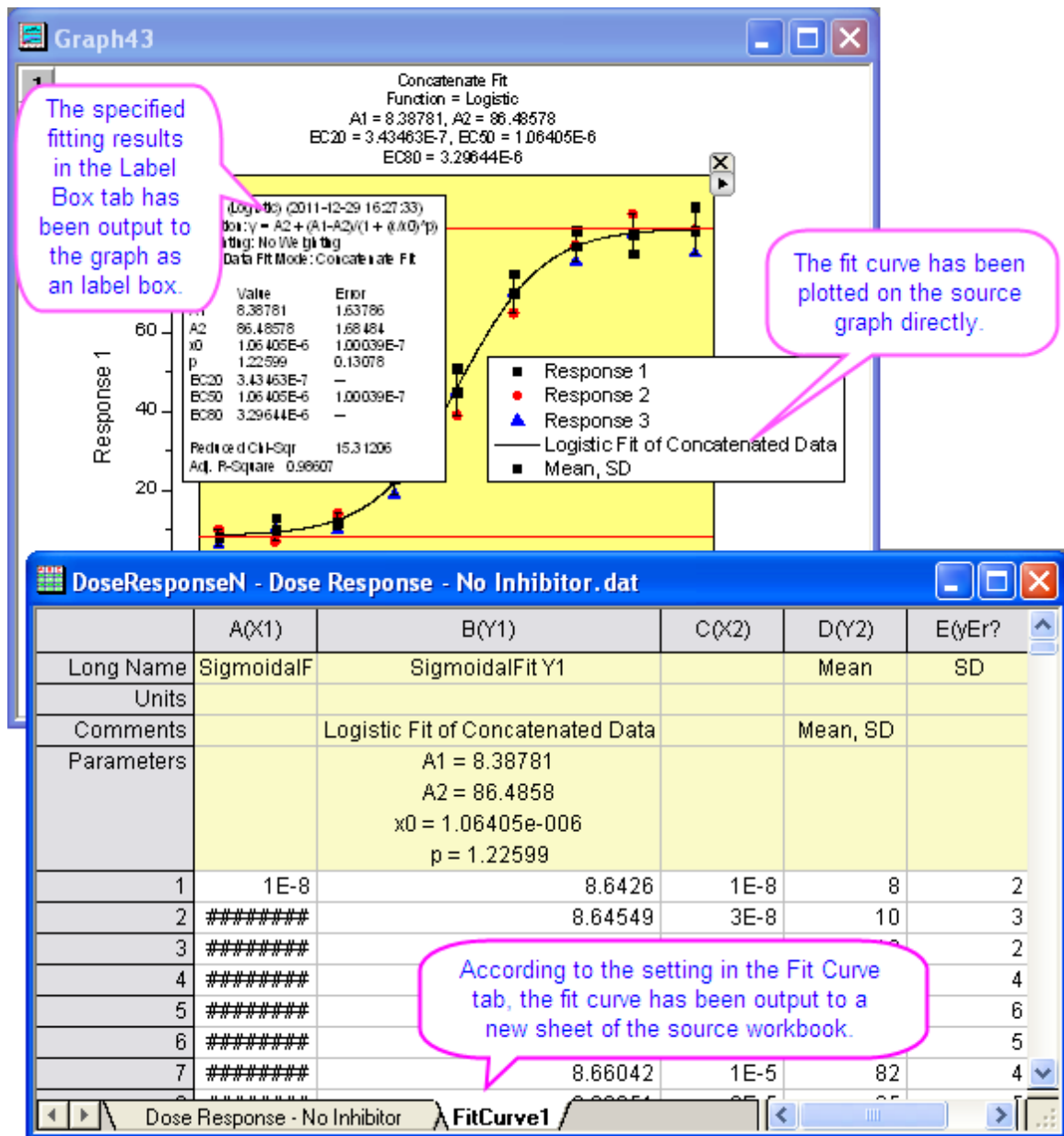

#### 4.2.10.3.2 Connect to NLFit

When using the Quick Sigmoidal Fit gadget you can easily switch to the NLFit tool. This makes it easy to get a detailed fit report using the current fitting settings in the gadget.

1. Redo step 1 through step 8 as shown above.
2. Click the arrow button  to select **Switch to NLFit...** to open the **NLFit** dialog with the inherited settings.

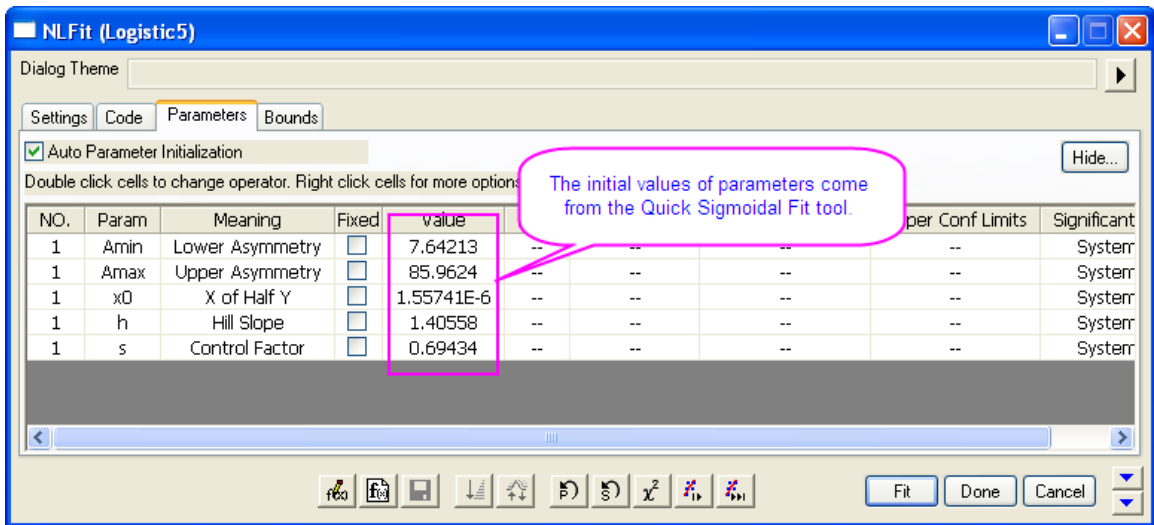
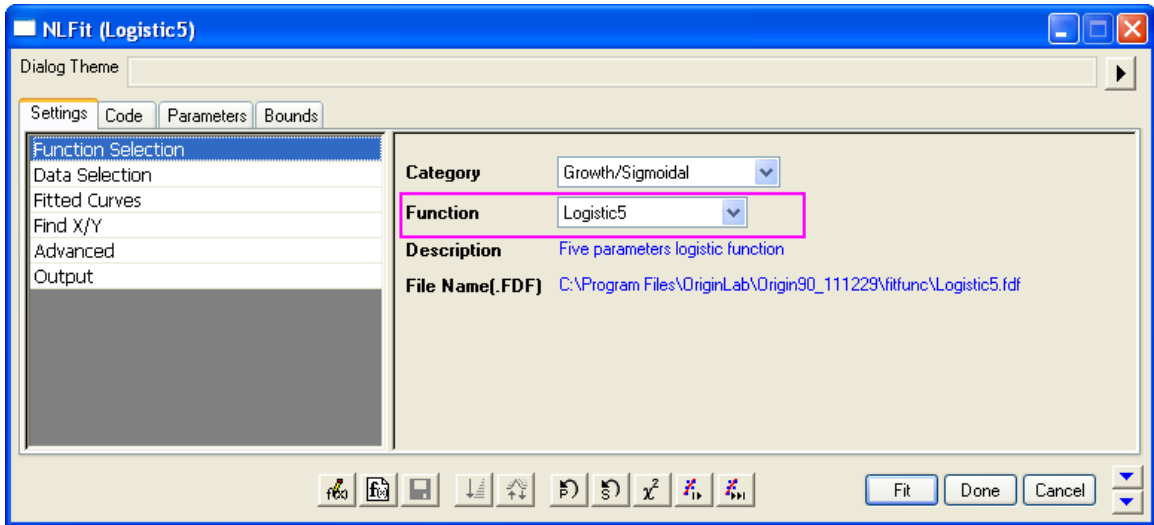

3. Click the **Fit** button to perform curve fitting. The results are output to the result sheets and the source graph.

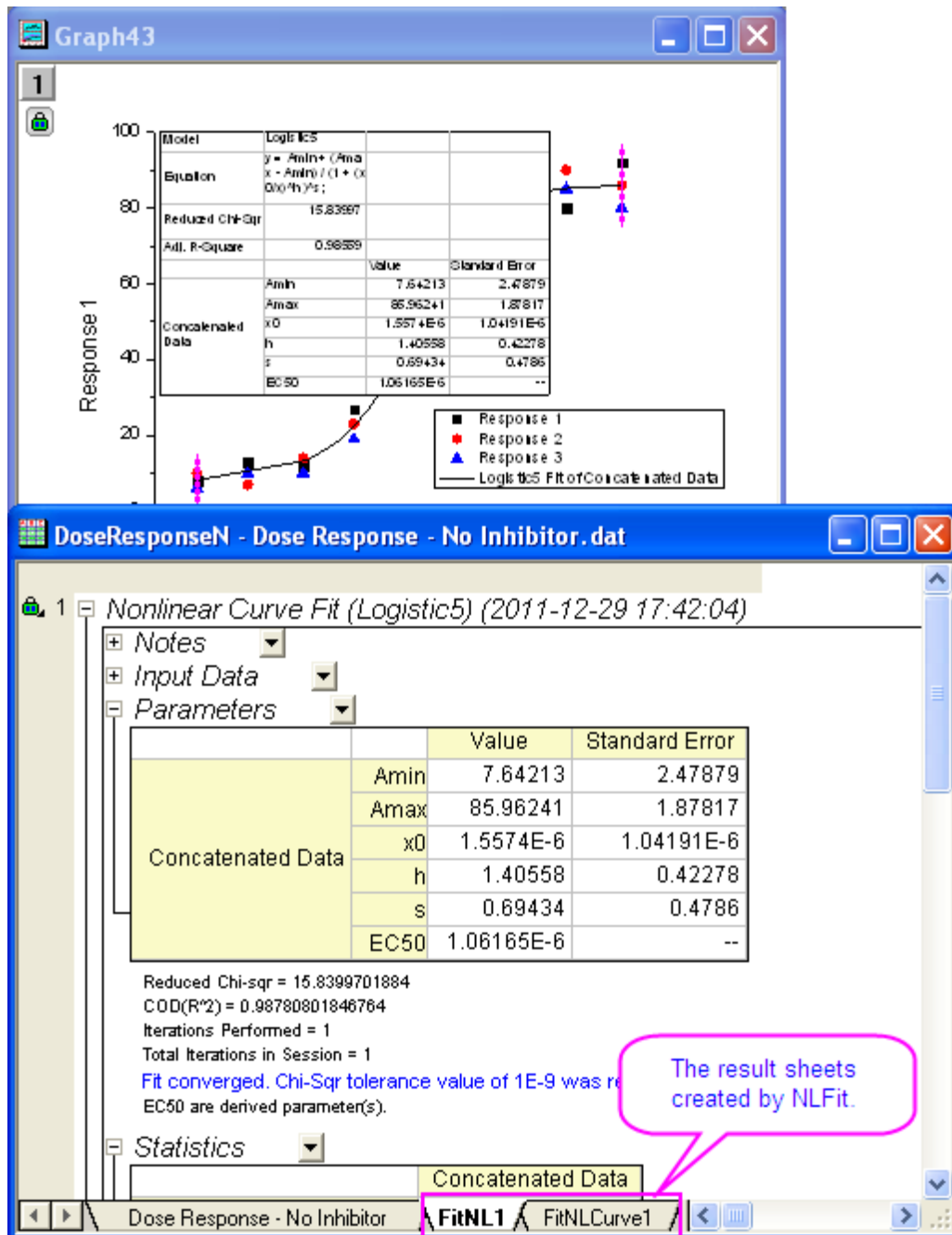

#### 4.2.10.3.3 Find X/Y

With his gadget you can also quickly find X/Y values on the fitted curve.

1. Redo step 1 through step 8 as shown in the first section.
2. Click the arrow button  to select **Find X/Y...** from the menu to open the **Find X/Y** dialog.

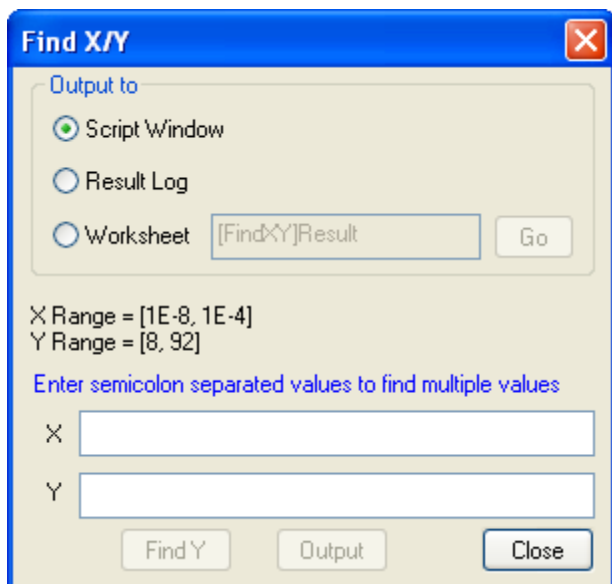

3. Select the **Worksheet** radio box and enter 40;45;50 for **Y**, then click **Find X** to show the corresponding X values in the empty **X** box. Then, click the **Output** button and the X and Y values are output to the specified worksheet.

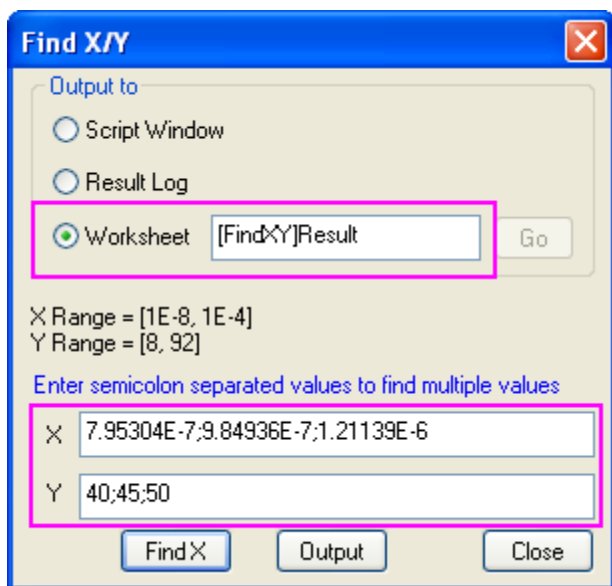

4. Click the **Go** button beside the **Worksheet** radio box to open the **Find X/Y** workbook. Click the **Close** button to close the **Find X/Y** dialog.

	A(X)	B(Y)
Long Name	Found X	Specified Y
Units		
Comments	FindX of Logistic5 Fit on "Response 1"	
1	7.95304E-7	40
2	9.84936E-7	45
3	1.21139E-6	50
4		
5		
6		

## 4.2.11 Using Multiple Gadgets

### 4.2.11.1 Summary

Multiple gadgets can be used in combination to achieve certain goals. To avoid overlapping of several gadget windows over same plot, we can arrange them into different layers to layout them onto different panels. The results from all other gadgets can be eventually added to the last gadget window and kept updated at each new output. In this tutorial, we will illustrate an example to show how we can combine the use of **Quick Peaks**, **Quick Fit** and **Intersect** gadgets to find the intersection point between the baseline and slope of a curve.

Minimum Origin Version Required: Origin 2016 SR0

### 4.2.11.2 What you will learn

This tutorial will show you:

- how to simultaneously use multiple gadgets to analyze same data.
- how to output Gadget analyzed results onto a specific graph and keep them updated.
- how to find the intersection point of baseline with the linear fitting of a curve.

### 4.2.11.3 Create a layout for multiple gadget windows

1. Start with a new workbook and import the file `\Samples\Curve Fitting\Gaussian.dat`.
2. To avoid overlapping the gadgets in one graph, we are going to prepare a multi-layer graph as shown below with same data in each layer.
3. Click and select the second column and use the menu item **Plot:Multi-Curve:4 Panel** to create a 4 panel plot.

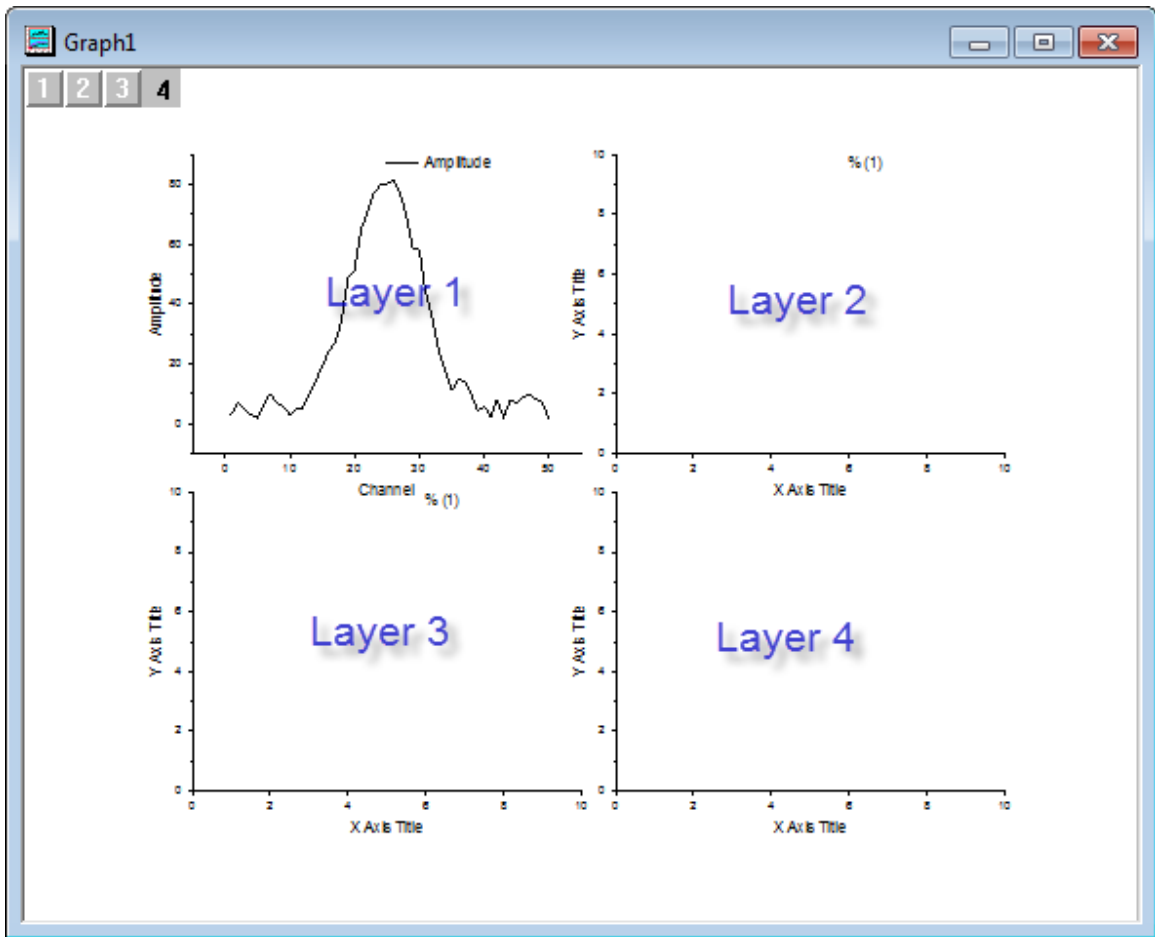

**Note:** To make the explanation of following steps more clear, we marked above figure with blue font to help you distinguish the layers in the graph.

- Go back to the workbook, select the **Amplitude** column, and position the cursor at the edge of the

column, until you see the cursor turn into . Then you can drag-and-drop the column into layer 2 on the graph page and click **OK** to close the appeared dialog box. Do it again to add the plot to layer 3 in the panel, and then click the bottom right area to select the unwanted layer 4 and use the **Delete** key on the keyboard to delete it.



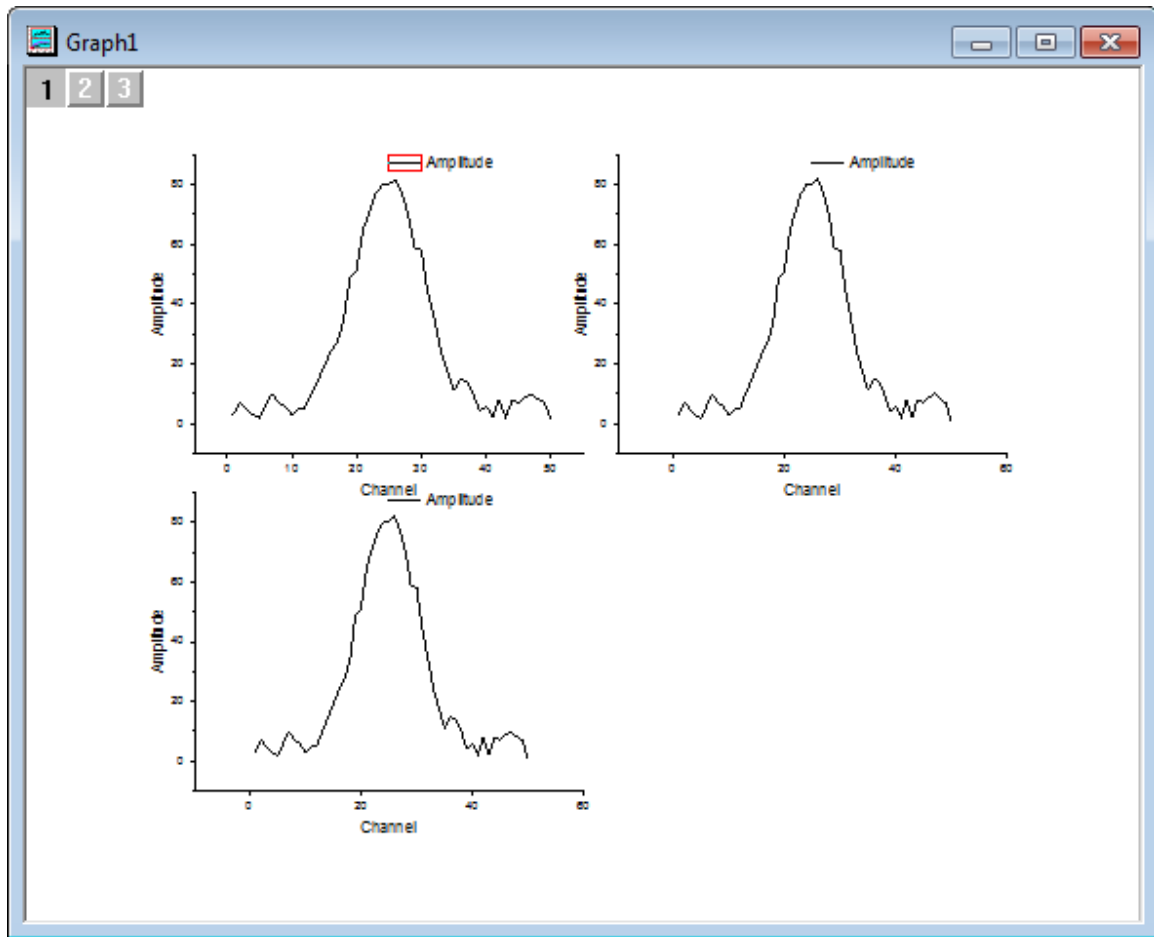

#### 4.2.11.4 Using Quick Peaks gadget to find baseline

1. Select **Gadgets:Quick Peaks** from the Origin menu when layer 1 is active to bring up the **Data Exploration:addtool\_quickpeaks** dialog box. According to the lineshape of this curve, spline connection would be a better choice for fitting the baseline. To do so, go to the **Baseline** tab, choose **Spline** in the **Connect Method** drop-down list to connect anchor points with spline method.

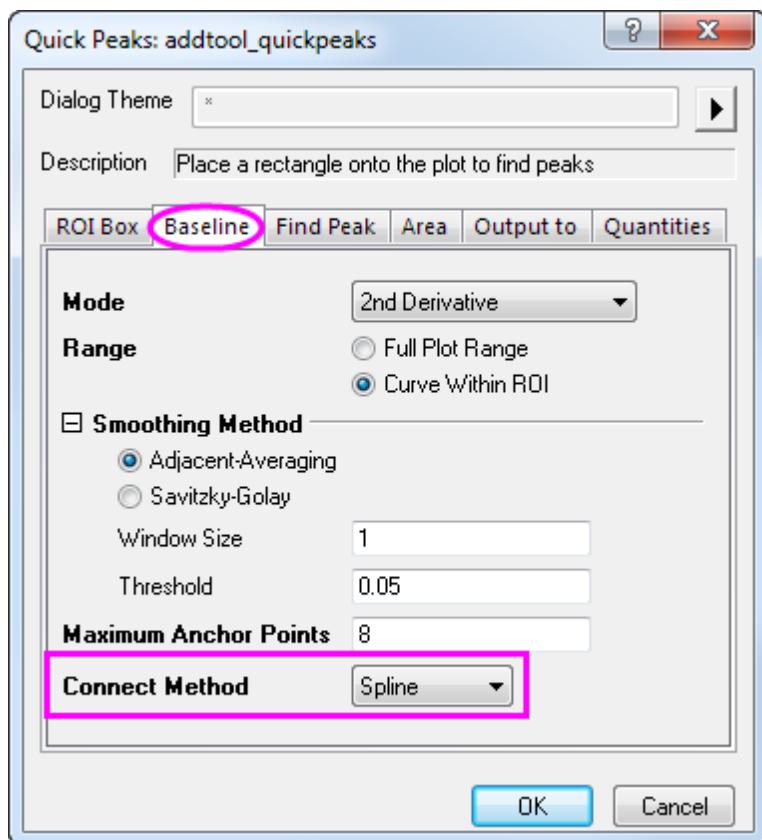

2. Since we do not want to create new columns in the source sheet to save baseline data at every new output, we can save the result to a new workbook and the newly created baseline data will replace existing data instead. To do so, go to **Output to** tab, uncheck the **Append to Worksheet** box and check the **Output Baseline to Worksheet** to output baseline data into a new book QkPeak with sheet name as Baseline.

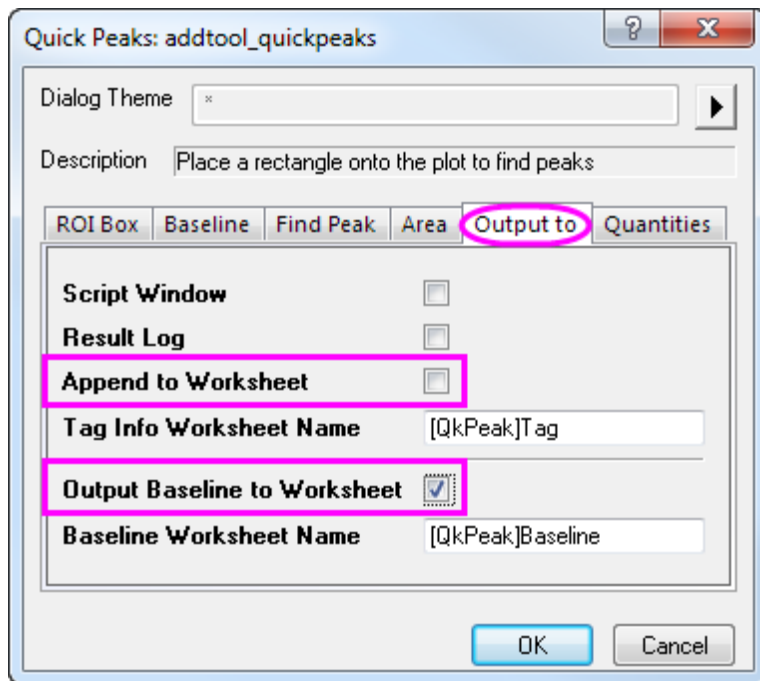

3. Click **OK** to close the dialog box. Place the mouse cursor over the edge of the Region of Interest (ROI), when the cursor turns into a double arrow icon, you can resize the box as needed.

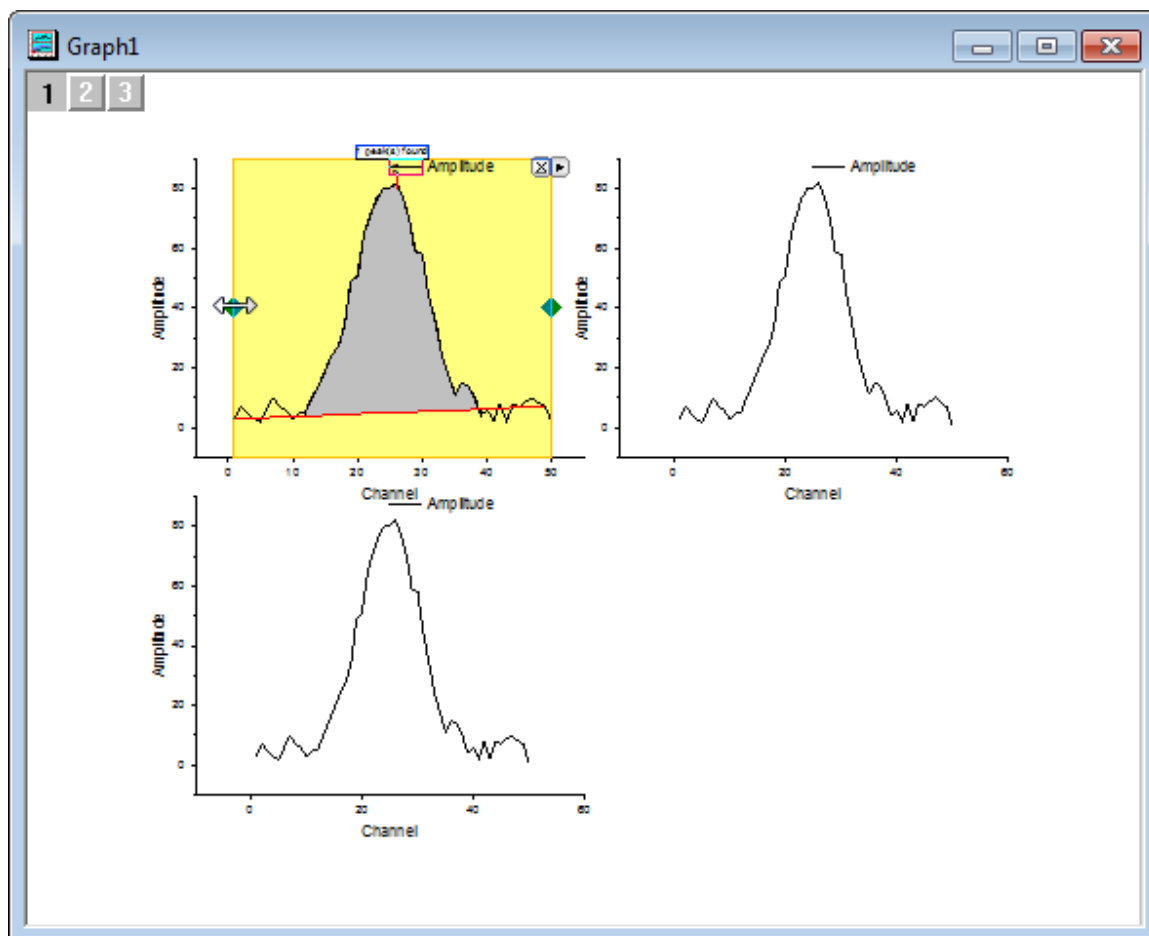

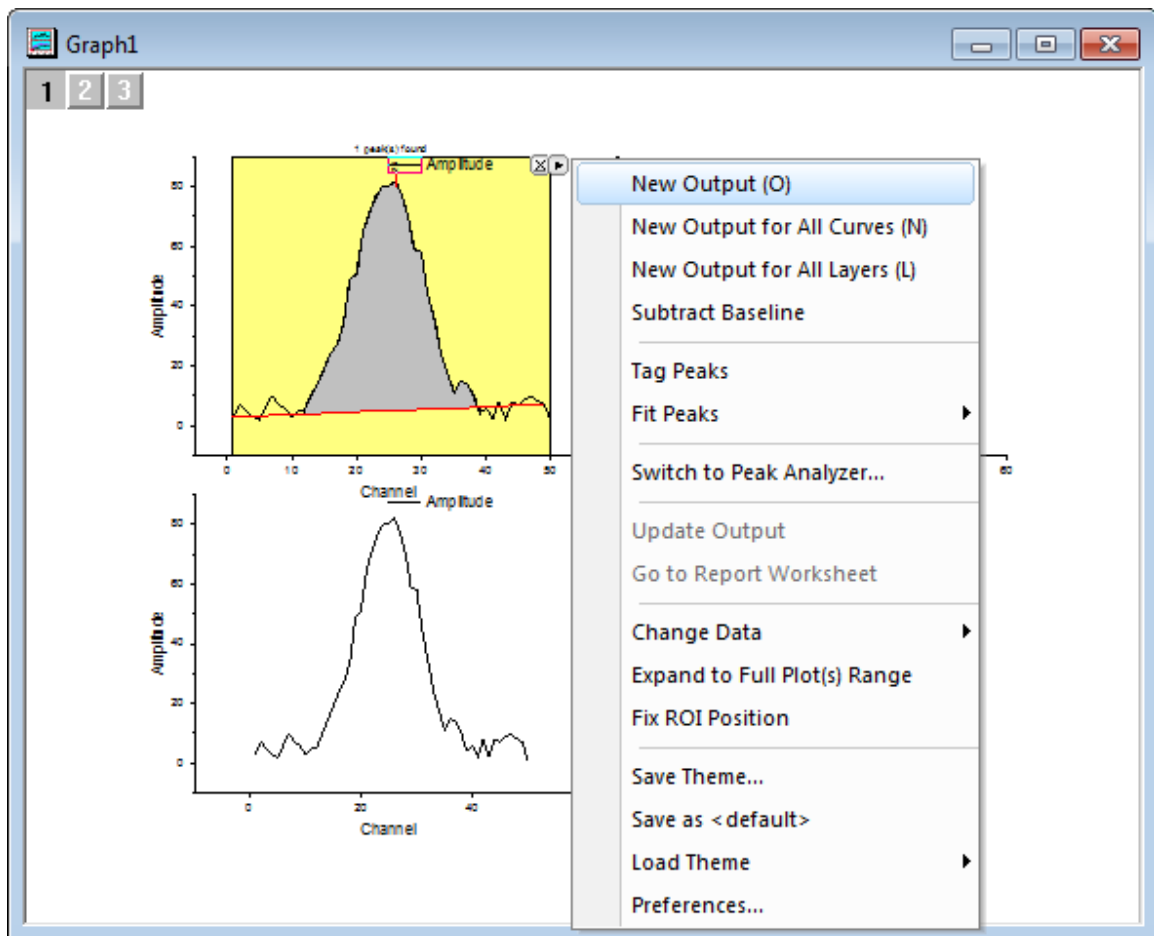

4. Click the triangle button  at the top right corner of the ROI to open the fly-out menu and choose **New Output(O)** to output baseline data.

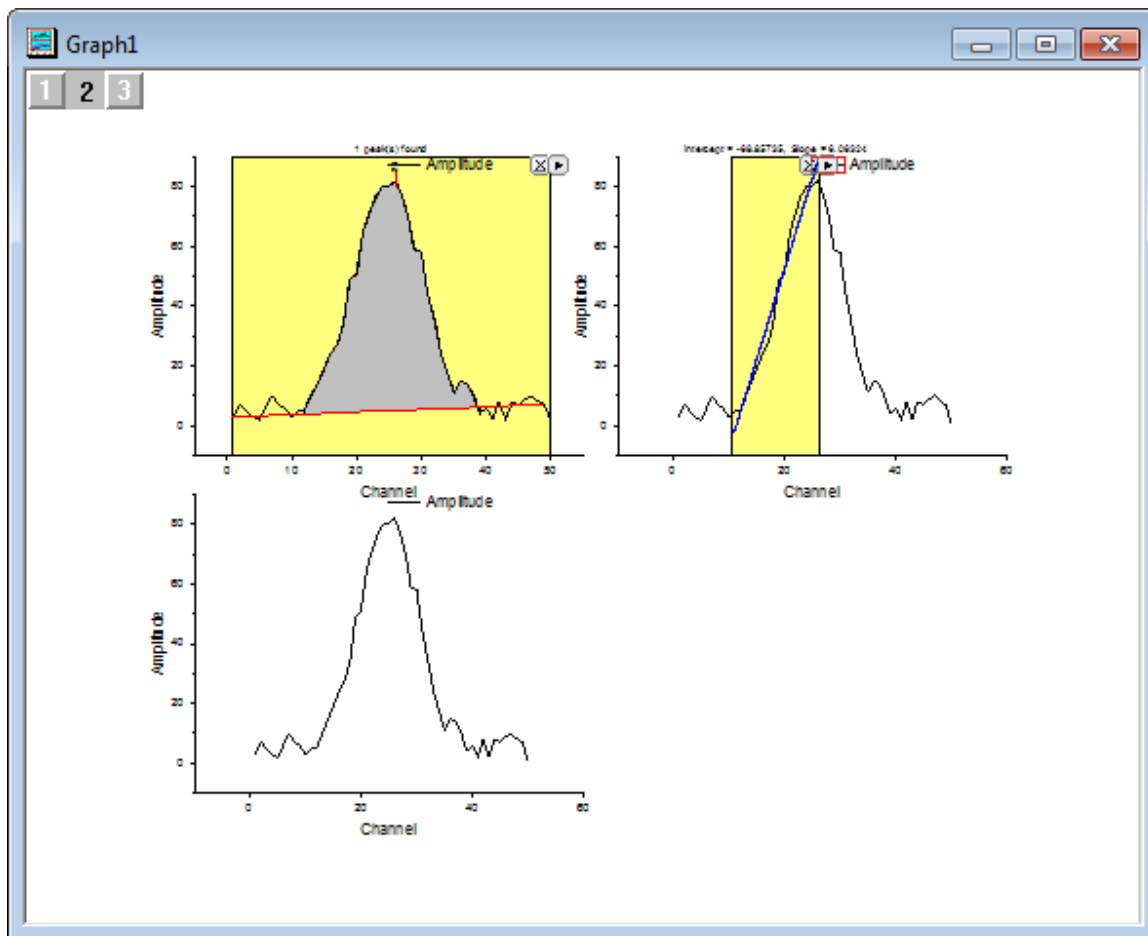

#### 4.2.11.5 Using Quick Fit to find the linear fit of the curve

1. Activate the second layer by clicking on the layer icon **2** on the top left corner of the graph or directly click on the plotting area of top right panel.
2. Select **Gadgets:Quick Fit:Linear(System)** from the Origin menu to bring up the **Quick Fit** ROI, and adjust the position and range of appeared ROI properly to perform linear fitting over the left half of the peak envelope.



3. Click the triangle button  at the top right corner of the ROI to open the fly-out menu and choose **Preferences** to customize **Quick Fit Preferences** dialog box.
4. Since we do not need other unnecessary output about this linear fitting, we can go to the **Label Box** tab, uncheck **Add Label Box to Graph**.

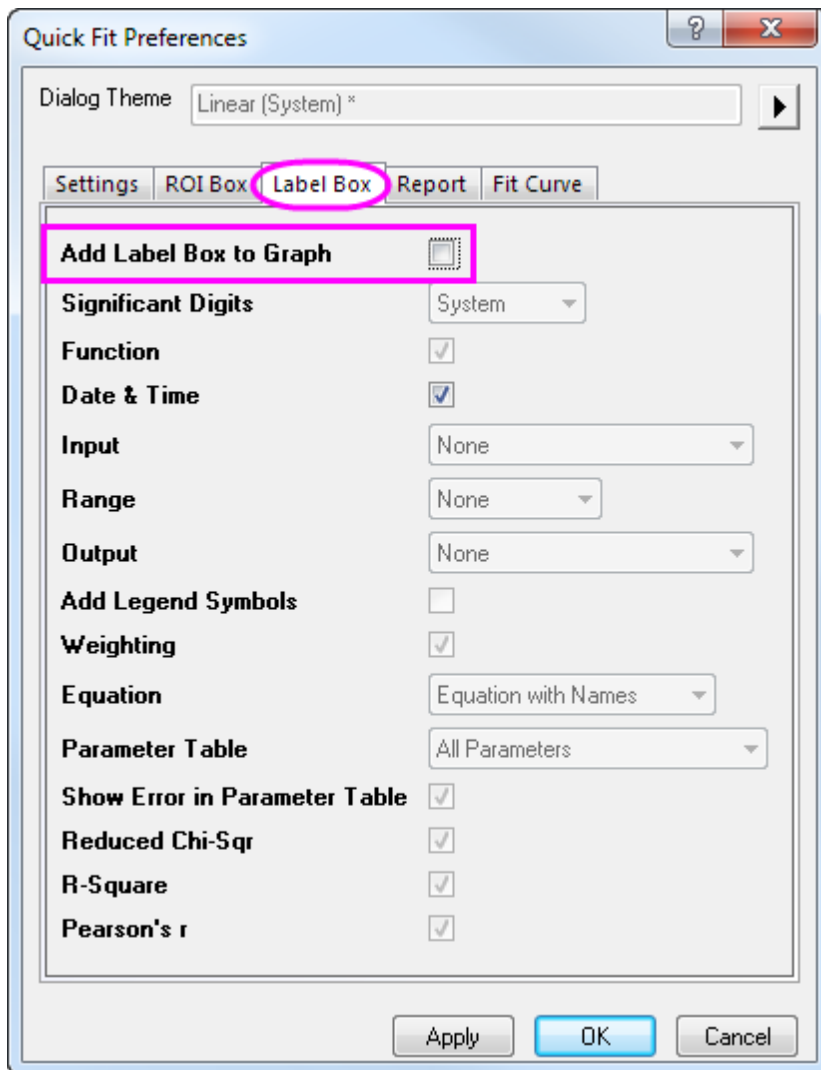

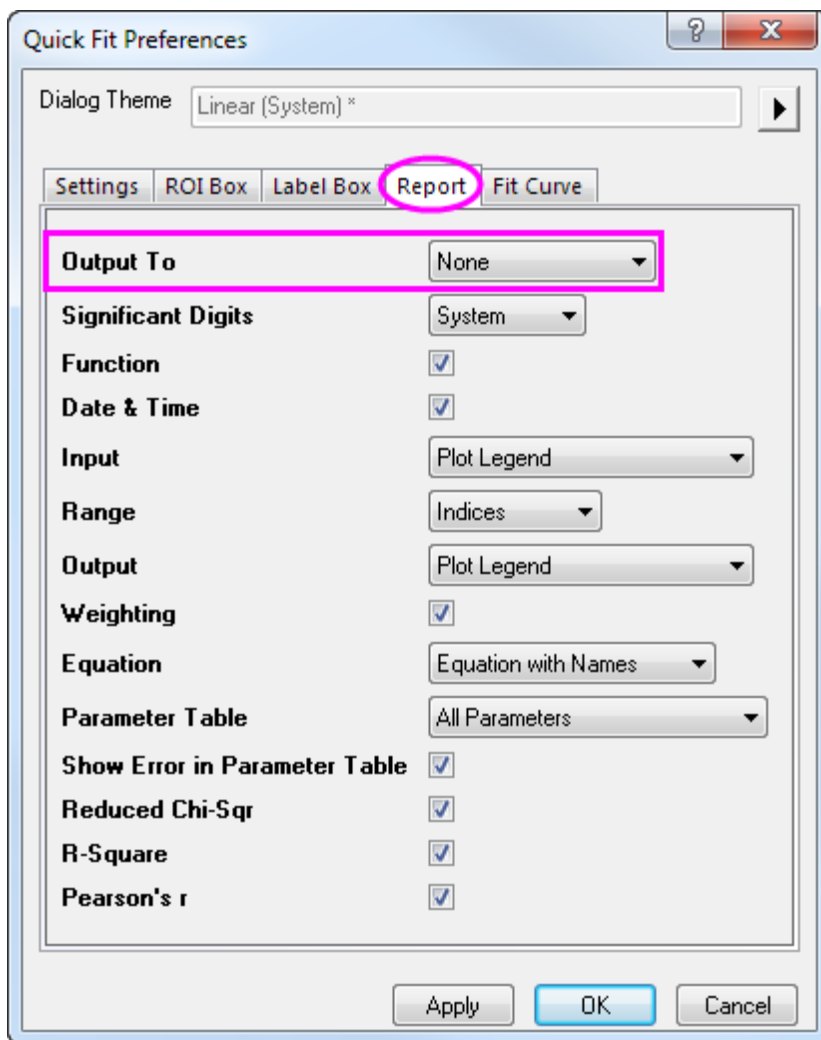

5. For the same purpose, to avoid outputting summary report we can go to the **Report** tab, choose **None** in the **Output To** drop down list and click **OK** to close the dialog box.



- Return to the triangle button  at the top right corner of the ROI, choose **New Output(O)** to output linearly fitted results to worksheet.

#### 4.2.11.6 Using Intersect gadget to find intersection point

- Before we apply the **Intersect** gadget, the first step to do is to add the fitted baseline and linearly fitted line from last two gadgets to the third plot. To do so, click on the layer icon  on the top left corner to activate layer 3. Right click on the layer icon  to choose **Layer Contents** to bring up **Layer Contents-Layer 3** window. Select the data with long name **QuickFit Y1** and **Baseline Y of Amplitude** and add them to the right panel through the right arrow icon .



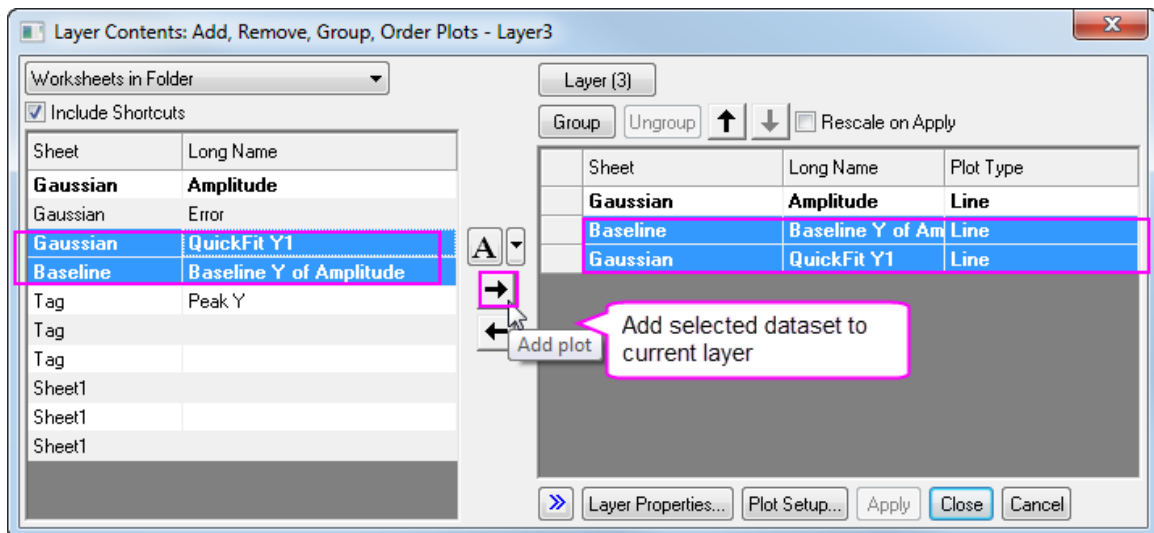

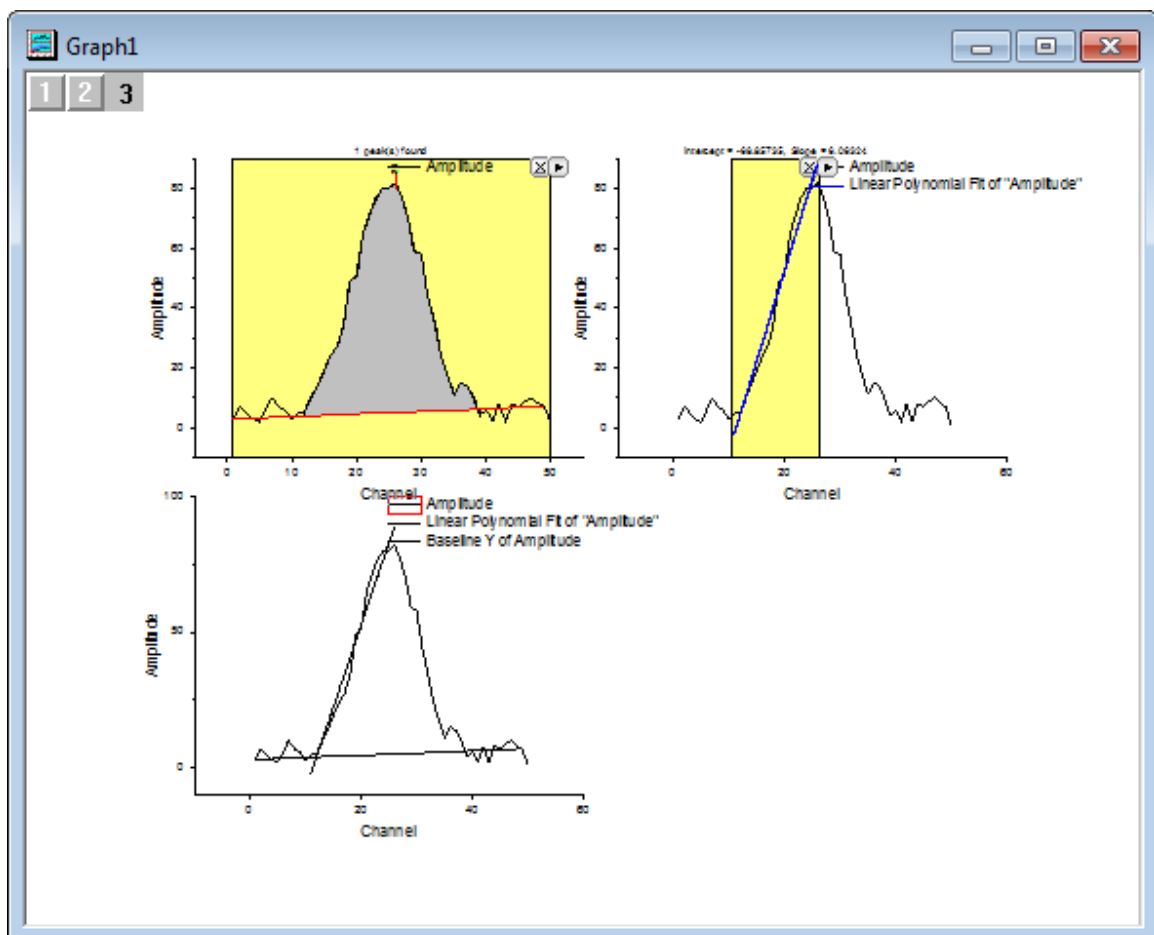

- Click **OK** to close the window and the fitted baseline and linear line will display in the third layer.

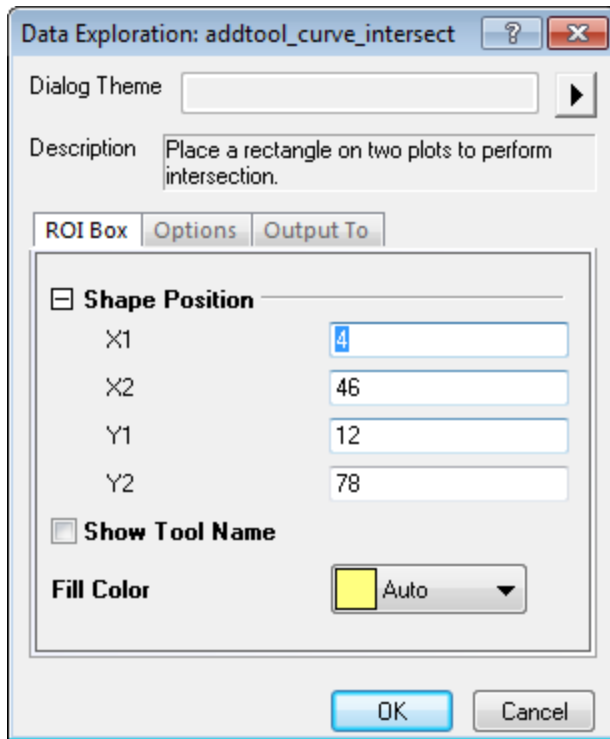

3. Select **Gadgets:Intersect** from the Origin menu when layer 3 is active to bring up the **Data Exploration:addtool\_curve\_intersect** dialog box. Click **OK** to close the dialog box and it will bring up **Intersect** Gadget ROI.



4. Position and resize the ROI properly to have the intersection point between baseline and slope inside the box. To exclude other intersection points with the original curve, go to the triangle button  at the top right corner of the ROI and uncheck **Plot(1) Amplitude** from the context menu of **Change Data**.

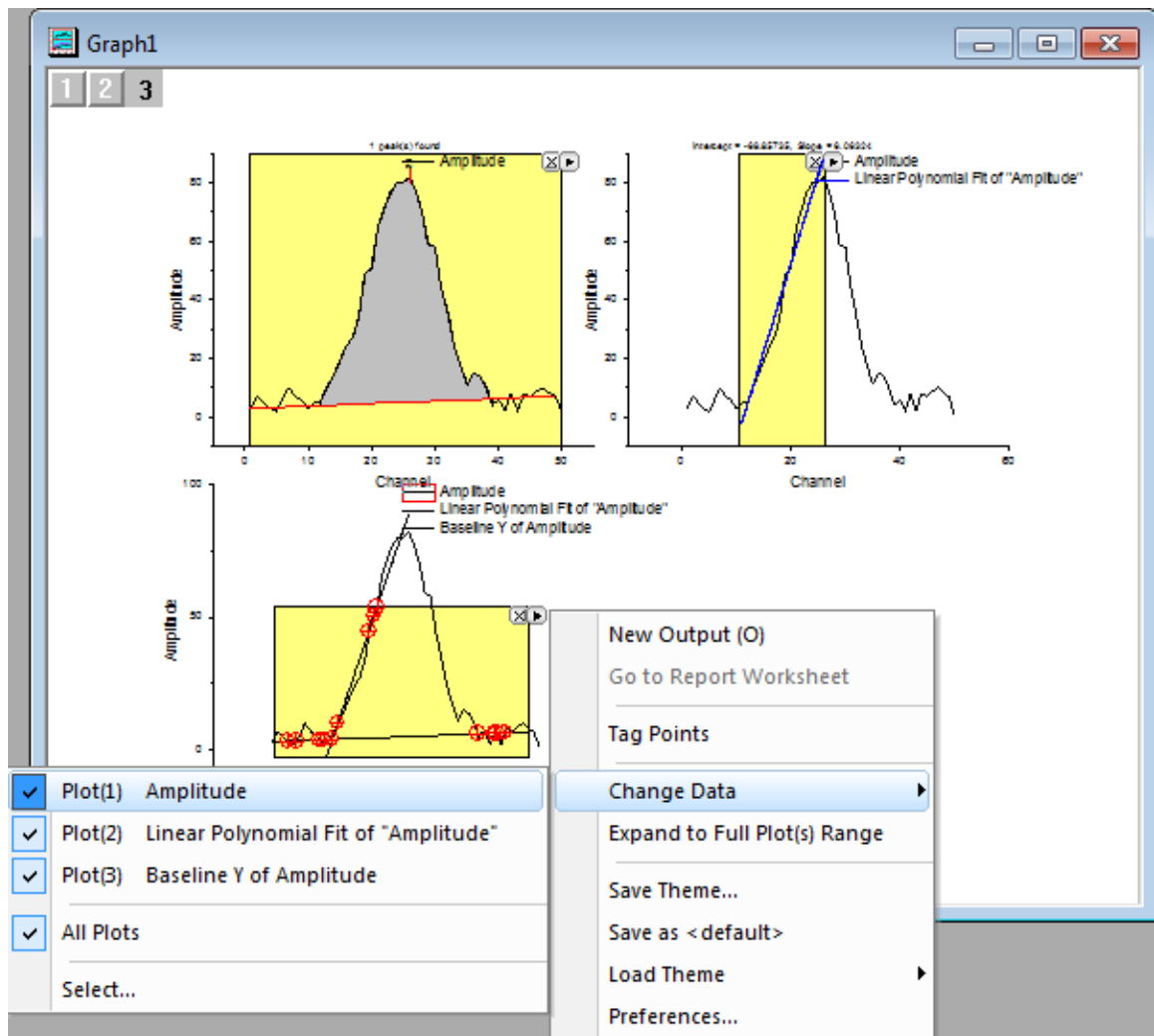

- Return to the triangle button  at the top right corner of the ROI, choose **New Output(O)** to output the result of intersection point between baseline and linearly fitted line.

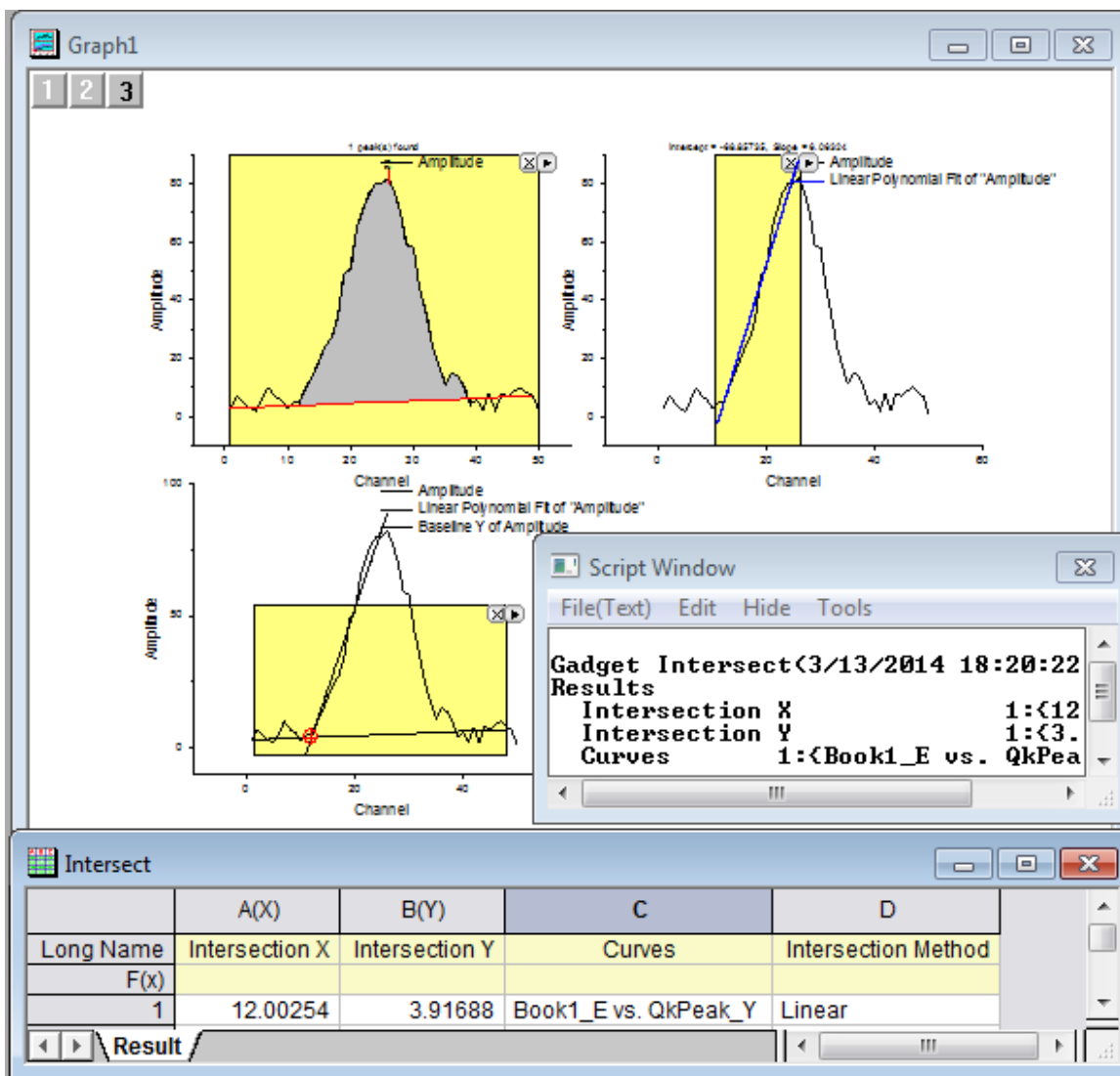

#### 4.2.11.7 Update the output

1. Click on the layer icon **1** to activate layer 1, reposition **Quick Peaks** ROI to create a new baseline. Then go to the triangle button **▶** at the top right corner of the ROI, choose **New Output(O)** to output the newly created baseline.
2. Click on the layer icon **2** to activate layer 2, reposition **Quick Fit** ROI to the other side of the curve so it will create a new linear fit line. Then go to the triangle button **▶** at the top right corner of the ROI, choose **Update Last Output(O)** to output linearly fitted line result.
3. Click on the layer icon **3** to activate layer 3, reposition **Intersect** ROI to have the intersection point between newly created baseline and linearly fitted line inside the box. Then go to the triangle button **▶** at the top right corner of the ROI, choose **New Output(O)** to output the result of new intersection point.

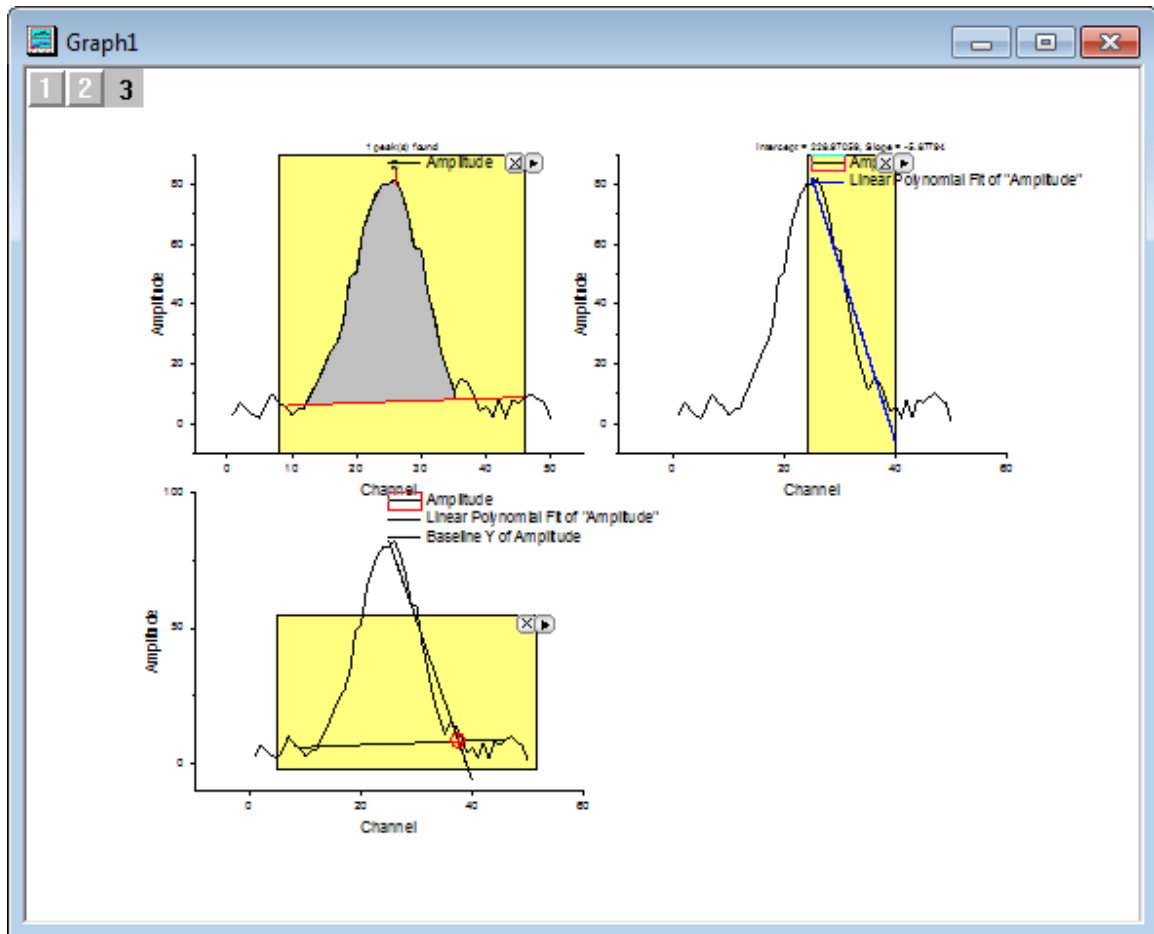

## 4.3 Curve Fitting

### 4.3.1 Curve Fitting

#### 4.3.1.1 Linear and Polynomial Fitting

- [Linear Fitting and Outlier Removal](#)
- [Linear Fit for Kinetic Models](#)

#### 4.3.1.2 Nonlinear Fitting

- [Nonlinear Curve Fit Tool](#)
- [Nonlinear Fitting with System Function](#)
- [Global Fitting with Parameter Sharing](#)
- [Global Fit for Different Functions with Shared Parameters](#)
- [Parameters Initialization using LabTalk in NLFit](#)

- [User Defined Fitting Function](#)
- [Fit Surface with User Defined Function](#)
- [Fitting One Dataset as a Function of Other Datasets](#)
- [Fitting With Multiple Independent Variables](#)
- [User Defined Fitting Function using GNU Scientific Library](#)
- [Fitting with NAG Special Function](#)
- [Fitting Integral Function with parametric limit using NAG Library](#)
- [Fitting with Integral using NAG Library](#)
- [Fitting with Integral using LabTalk Function](#)
- [Fitting with Two Integrals using LabTalk Function](#)
- [Fitting with Summation](#)
- [Fitting Complex Function](#)
- [Fitting with Convolution](#)
- [Quoting Built-in Functions in Your New Function](#)
- [Fit Function with Non-constant Background](#)
- [Fitting with Piecewise Functions](#)
- [Fit Curve Through Certain Points](#)
- [Distribution Fit with the Probability Density Function and Cumulative Distribution Function](#)
- [Fitting Integral Function with a Sharp Peak](#)
- [Fitting with a Piecewise Linear Function](#)
- [Fitting with an Ordinary Differential Equation](#)
- [Fitting with Convolution of Two Functions](#)
- [Parameter Initialization for Rational Functions](#)
- [Surface Fitting with Multiple Peaks](#)
- [Nonlinear Multiple Variables Fitting](#)
- [Modifying Derived Parameters in Build-in Functions](#)
- [Fit Multiple Datasets by Fitting One and then Using Those Fit Parameters for Other Datasets](#)
- [Implicit Fitting with Three Variables](#)
- [Nonlinear fitting using Orthogonal Distance Regression](#)

## 4.3.2 Linear and Polynomial Fitting

### 4.3.2.1 [Linear and Polynomial Fitting](#)

- [Linear Fitting and Outlier Removal](#)
- [Linear Fit for Kinetic Models](#)

### 4.3.2.2 [Linear Fitting and Outlier Removal](#)

#### 4.3.2.2.1 Summary

An outlier is typically described as a data point or observation in a collection of data points that is "very distant" from the other points and thus could be due to, for example, some fault in the measurement procedure. Identification and removal of outliers is often controversial, and is typically "more acceptable" in situations where the model used to describe the data is well known and well accepted.

#### 4.3.2.2.2 What you will learn

This tutorial will show you how to:

- Perform linear regression on a set of data points
- Examine the Residuals Table in the output and "identify" outliers
- Use the Masking Tool to remove the outlier points
- Use the Recalculation mechanism to automatically update the result after outlier removal

The procedure described in this tutorial is also applicable to other fitting tools such as Polynomial and Nonlinear Fitting

#### 4.3.2.2.3 Steps

1. Start with a new workbook and import the file *\Samples\Curve Fitting\Outlier.dat*.
2. Click and select the second column and use the menu item **Plot: Symbol: Scatter** to create a scatter plot.
3. With the graph active, use the menu item **Analysis: Fitting: Linear Fit...** to bring up the Linear Fit dialog. Note that if you have used the Linear Fit dialog before, there will be a fly-out menu and you need to select the **Open Dialog...** sub menu.

- In the **Fit Control** tab, clear the **Apparent Fit** check box.

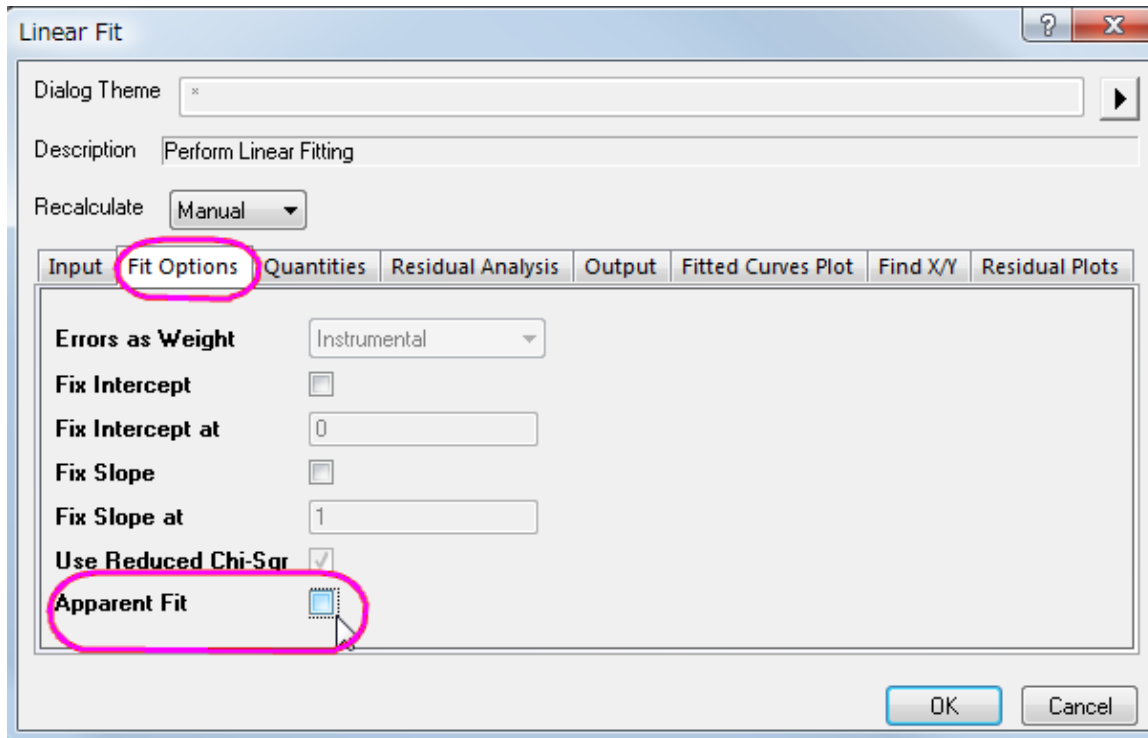

- In the **Residual Analysis** tab in the dialog, and check the **Standardized** check box.

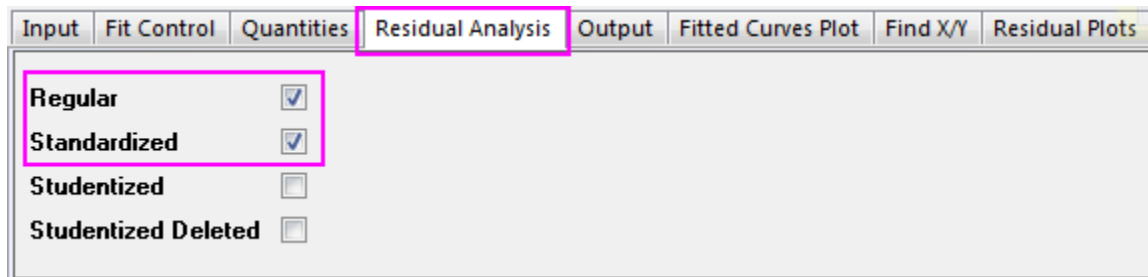

- Change the **Recalculate** drop-down at the top of the dialog to **Auto** and press the **OK** button at the bottom of the dialog. The dialog will close and linear regression will be performed on the data.

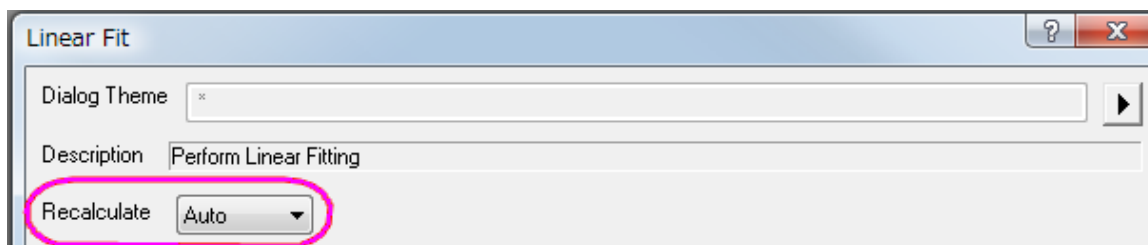

- Select the **FitLinearCurve1** result sheet in the data workbook and scroll to the right side to view the **Standardized Residual** column. You will note that the value in row 6 of this column is  $-2.54889$ :



	A(X1)	B(Y1)	C(X2)	D(Y2)	E(Y2)
Long Name	Independent Var	Linear Fit of Outlier	Independent Var	Regular Residual	Standardized Res
Units					
Comments					
Parameters	Fitted Curves Plot				
1	0.79	1.43673	0.79	0.23327	0.13281
2	0.79813	1.44455	2.16	0.08563	0.04875
3	0.80626	1.45236	2.56	1.08092	0.61539
4	0.81438	1.46018	3.57	0.28951	0.16483
5	0.82251	1.468	4.43	-0.14762	-0.08404
6	0.83064	1.47582	5.23	-4.47705	-2.54889
7	0.83877	1.48363	5.55	-0.31482	-0.17923
8	0.8469	1.49145	6.06	0.44467	0.25316
9	0.85503	1.49927	6.67	2.41798	1.37662
10	0.86315	1.50709	7.61	0.48391	0.2755

- Make the graph active and then click and hold down the mouse left button on the "Regional Mask Tool" button in the Tools toolbar. Select the "Masked Points on Active Plot" submenu which will be the first item in the fly-out menu:

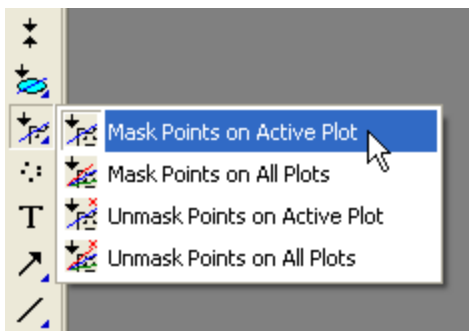

- With the above submenu selected, go to the graph and click on the 6th data point to mask the point (note that you can drag out a rectangle around the point).

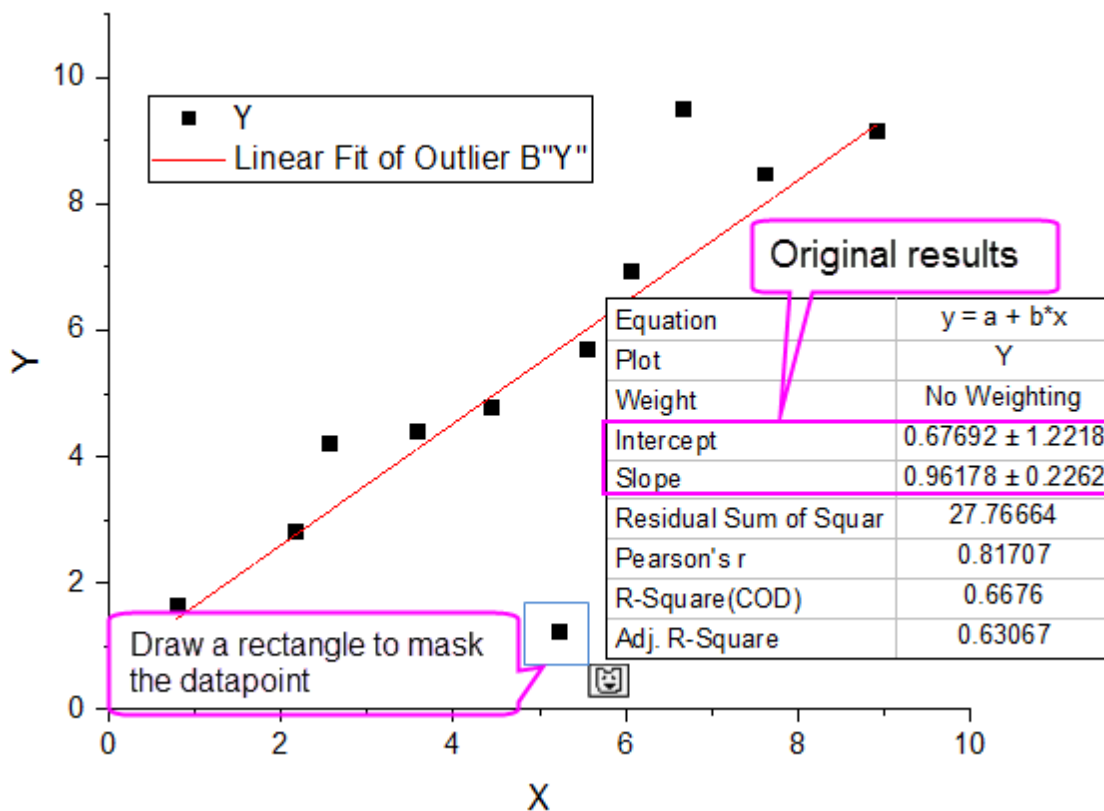

Masking this point changes the input data to the linear fit operation and the auto update mechanism will trigger. The linear fit will be repeated with this particular masked point left out. The fit curve in the graph and the parameters table will automatically update. The resulting graph should look like this:

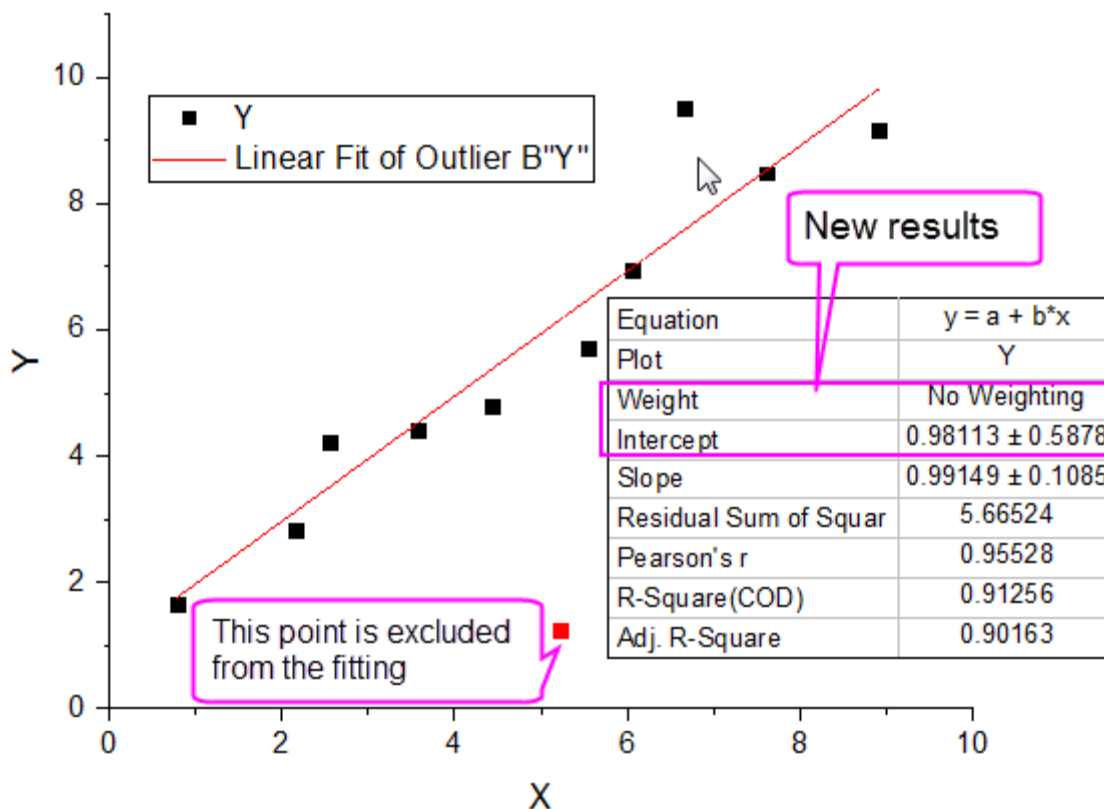

#### 4.3.2.3 Linear Fit for Kinetic Models

##### 4.3.2.3.1 Summary

Non-linear kinetic models are widely used across many disciplines of natural science, such as, physics, chemistry, biology. Experimentally, all the crucial parameters in kinetic models are obtained through fitting the raw data. The intuitive way to fit the raw data is to do a non-linear fit with the expression directly from the kinetic equation. Alternatively, linear fit can be applied if we can transform the equation in the way that the dependent variable related to independent variable linearly.

Minimum Origin Version Required: Origin 2015

##### 4.3.2.3.2 What you will learn

This tutorial will show you how to:

- Perform linear fit on same non-linear kinetic model using different linear transformations.
- Perform apparent linear fit on non-linear kinetic models.

##### 4.3.2.3.3 Linear fit for Langmuir model

Identify transformed independent and dependent variables

Langmuir model is described by the non-linear equation below:

$$y = \frac{ym * K * x}{1 + K * x}$$

where  $ym$ ,  $K$  are the parameters we want to obtain through fitting.

To perform linear fit on Langmuir model, we can transform it into linear equation in two different ways:

1. Transform it into traditional linear Langmuir equation:

$$y = -\frac{1}{K} \frac{y}{x} + ym$$

where the independent variable is  $y/x$ , dependent variable is  $y$ , slope is  $-1/K$  and intercept is  $ym$ .

2. Transform it into double reciprocal linear Langmuir equation:

$$\frac{1}{y} = \frac{1}{ym * K} \frac{1}{x} + \frac{1}{ym}$$

where the independent variable is  $1/x$ , dependent variable is  $1/y$ , slope is  $1/(ym*K)$  and intercept is  $1/ym$ .

#### Create new independent and dependent variable data

1. Open a new workbook.
2. Click the *Import Single ASCII* button  to bring up the **Open** dialog. Browse to `\Samples\Curve Fitting` folder and select the file `LangmuirModel.dat`. Make sure the **Show Options Dialog:** check box is selected and click **OK** to open the **impASC** dialog. Select **No** from **Add Sparklines** drop-down list under **Import Options** node and click **OK** to finish importing.
3. Use **Ctrl+D** to bring up **Add New Columns** dialog, enter 4 and click **OK** to add 4 columns to store transformed XY dataset later.
4. For traditional linear Langmuir model transformation, the independent variable is now  $y/x$  and dependent variable is still  $y$ . Type  $y/x$  and  $y$  as the long name for column C and D respectively so that it will show as X axis title, Y axis title respectively in later plot.
5. Type  $B/A$  in **F(x) =** formula cell in column C to set the value for independent variable  $y/x$ , and press **ENTER**. Highlight column C, right click and select **Set As:X** to make it as the default X dataset for plotting column D.
6. Type  $B$  in **F(x) =** formula cell in column D to set the value for dependent variable  $y$ , and press **ENTER**.
7. For double reciprocal linear Langmuir model transformation, the independent variable is  $1/x$  and dependent variable is  $1/y$ . Similarly, make the long name of column E, F as  $1/x$ ,  $1/y$ , respectively, and set their column values as  $1/A$  and  $1/B$  accordingly. Set column E designation as X.

8. The worksheet is then as following:

	A(X1)	B(Y1)	C(X2)	D(Y2)	E(Y2)	F(Y2)
Long Na	x	y	y/x	y	1/x	1/y
Units						
Comment						
F(x)=			B/A	B	1/A	1/B
1	0.1	0.939	9.392	0.939	10	1.065
2	0.12	1.124	9.364	1.124	8.333	0.89
3	0.14	1.149	8.206	1.149	7.143	0.87
4	0.16	1.406	8.785	1.406	6.25	0.711
5	0.18	1.354	7.524	1.354	5.556	0.738

#### Linear fit on transformed linear data

1. First, we will perform linear fitting on traditional linear Langmuir transformation. Highlight column *D* and select **Plot:Symbol:Scatter** to make a scatter plot.
2. To perform linear fitting, select **Analysis:Fitting:Linear Fit:Open Dialog** to bring up the **Linear Fit** dialog box and click **OK** to close dialog. In the appeared prompt, choose **No** and click **OK**.

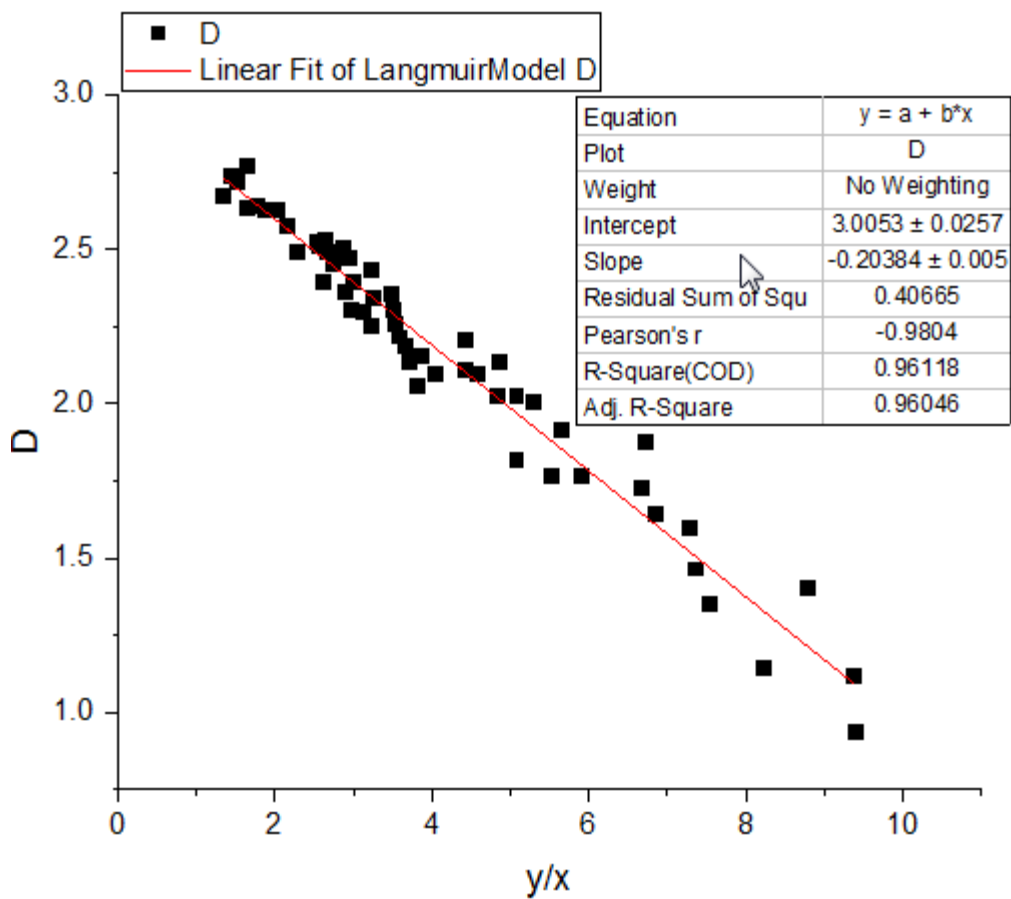

- Similarly, to perform linear fit on double reciprocal linear Langmuir transformation, highlight column F follow the steps above to create a scatter plot and then do a linear fit.

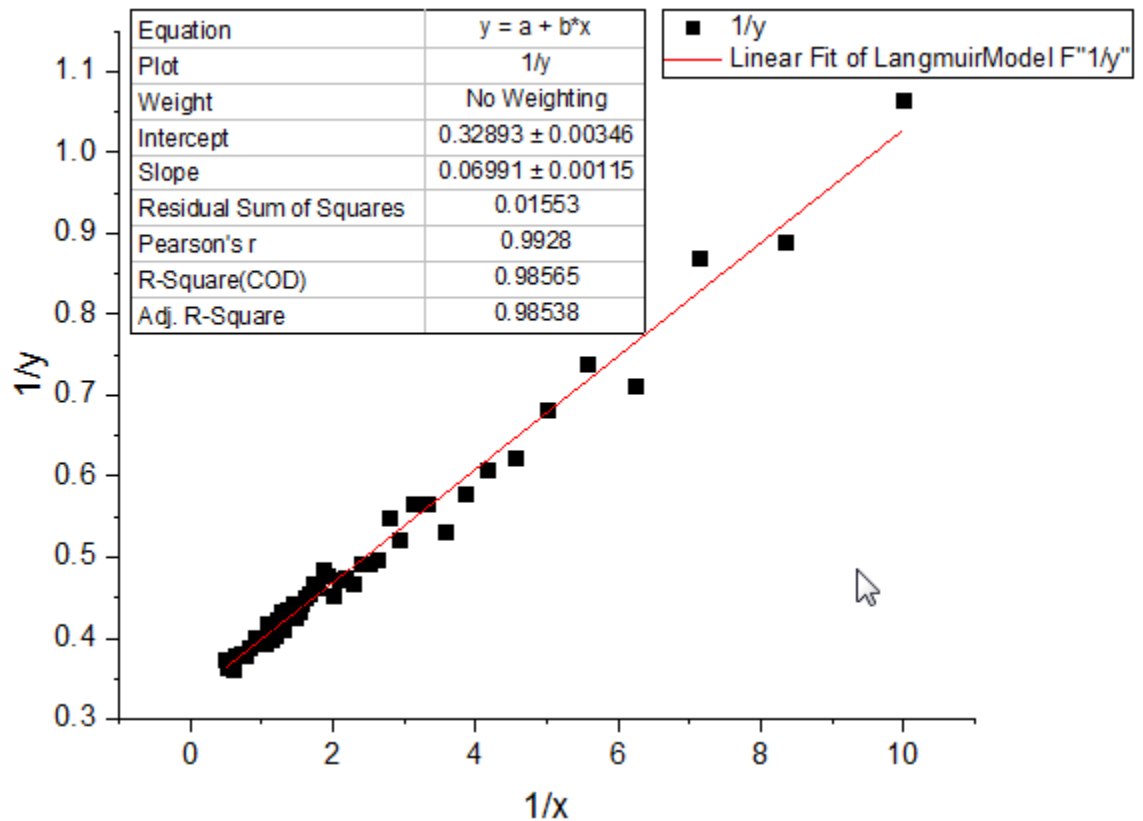

The coefficients in Langmuir model are then can be calculated using corresponding slope and intercept expressions.

#### Apparent linear fit on original non-linear data

Alternatively, we can use apparent linear fit to directly perform linear fit on raw non-linear kinetic data by customizing only the axis scales. Take Langmuir kinetic model for example, based on double reciprocal Langmuir linear transformation we found that the inverse of original dependent variable  $1/y$  is in linear relationship with the inverse of original independent variable  $1/x$ . Therefore, if set the X scale as  $1/x$  and set the Y scale as  $1/y$ , raw Langmuir kinetic data would appear with linearity.

1. To perform apparent linear fit on Langmuir kinetic raw data, highlight column *B* and select **Plot:Symbol:Scatter** to make a non-linear scatter plot.

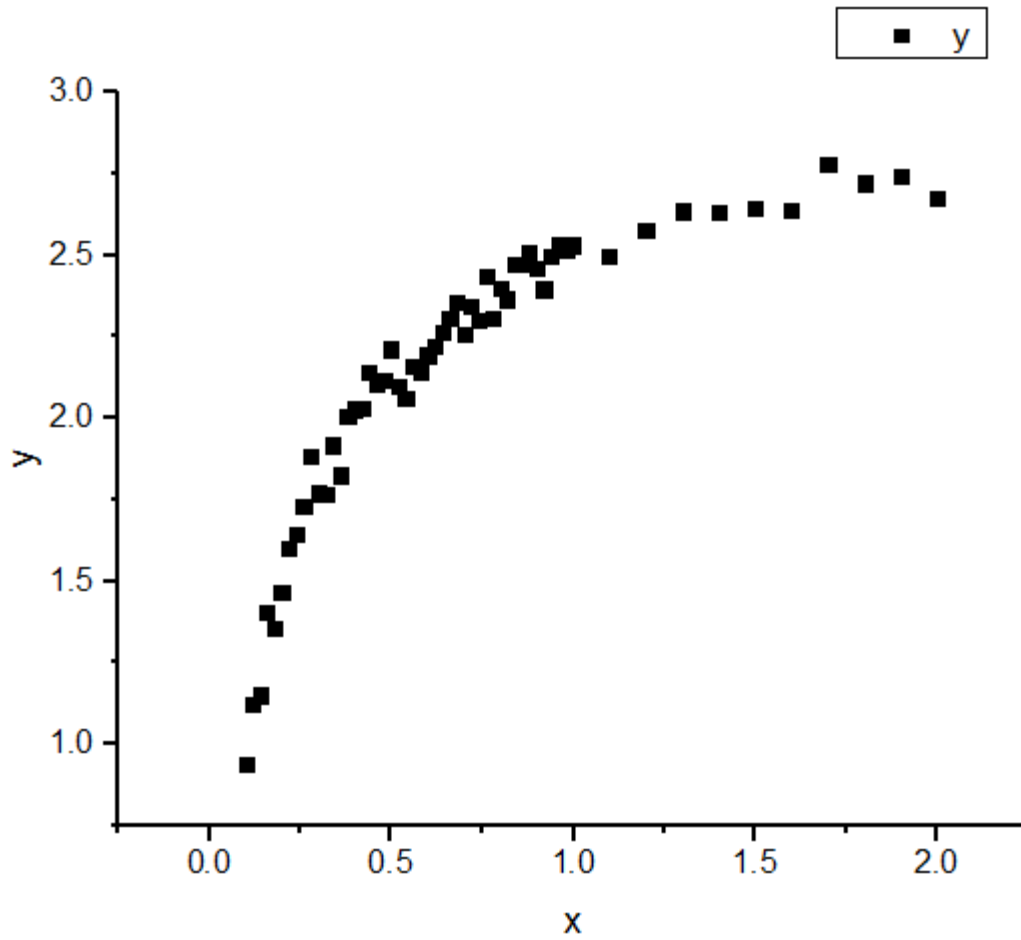

2. Double click on the X axis to bring up **Axis** dialog, set **From** as *0.08* and **To** as *3*. Then select **Custom Formula** from the **Type** drop-down list and input  $1/x$  as the **Direct Formula** and  $1/x$  as the **Inverse Formula**. Choose **Fixed From** in the **Rescale** drop-down list. Click **OK** to close the dialog.



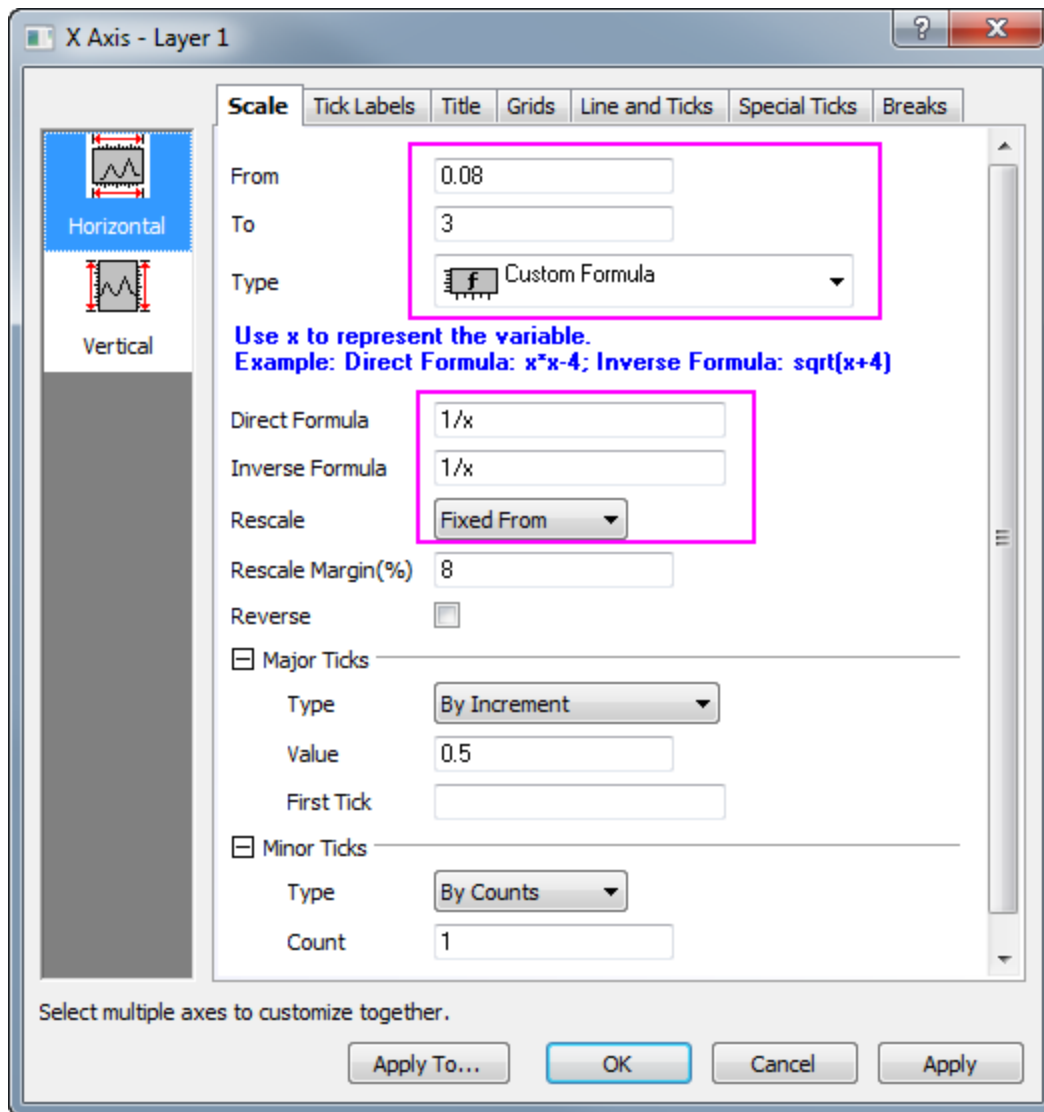

3. As can be seen from the plot, the default X axis ticks are not well separated. To make the ticks of X axis display reasonably, we will create a dataset to set the positions of ticks. To do so, activate *LangmuirModel* worksheet and use Ctrl+D to add one more column. Enter dataset *0.1, 0.15, 0.2, 0.3, 0.4, 0.7, 1, 3* in newly added column G.
4. To use column G as major tick positions for X axis, double click on the X axis to bring up **Axis** dialog. Then go to **Major Ticks** node choose **By Custom Positions** from **Type** drop-down list and choose *[LangmuirModel]LangmuirModel!G* from the **Dataset** drop-down list.

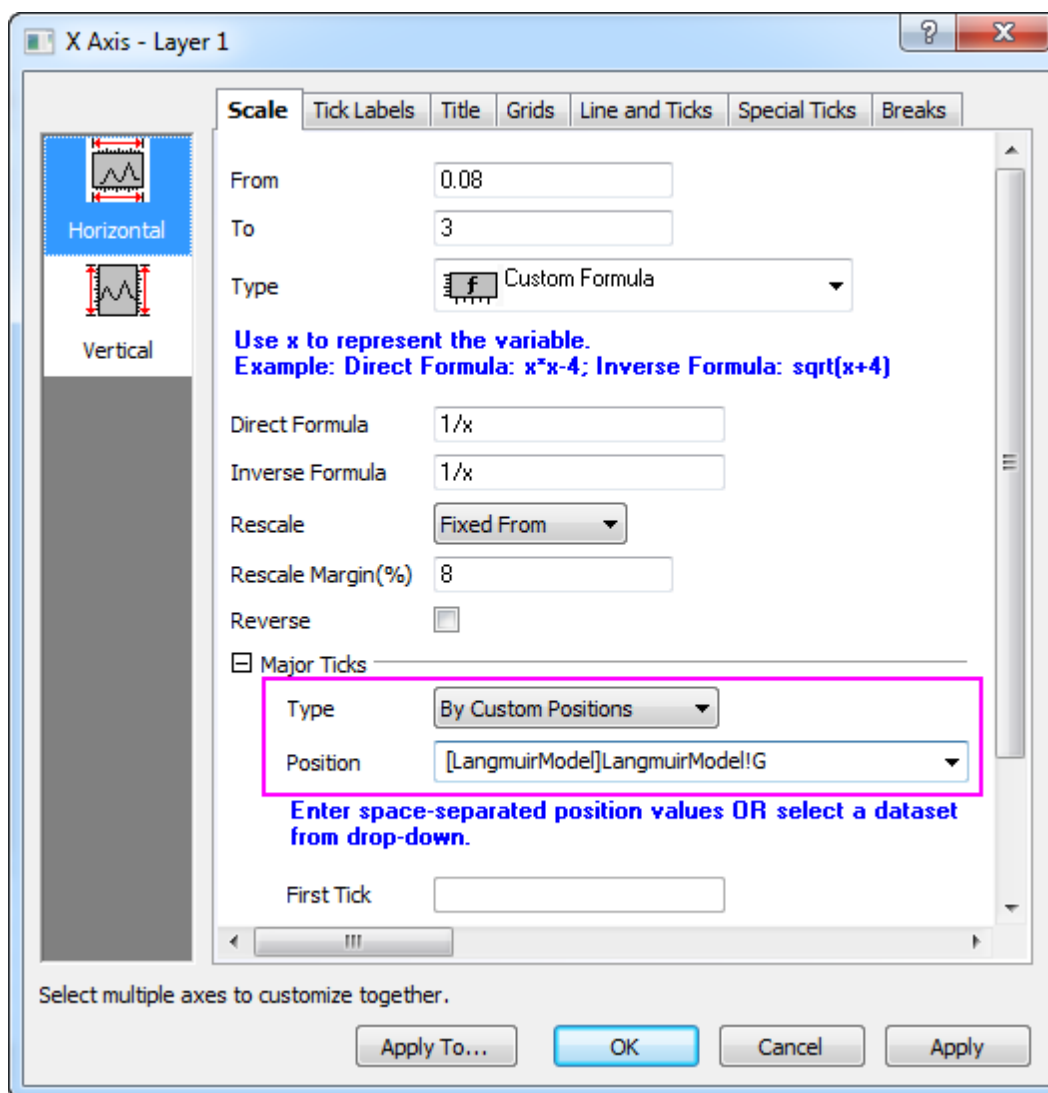

5. Click **Vertical** icon on left panel, similarly, choose **Custom Formula** from **Type** drop-down list and input  $1/x$  in both **Direct Formula** and **Inverse Formula** boxes. Click **OK** to close the dialog box.

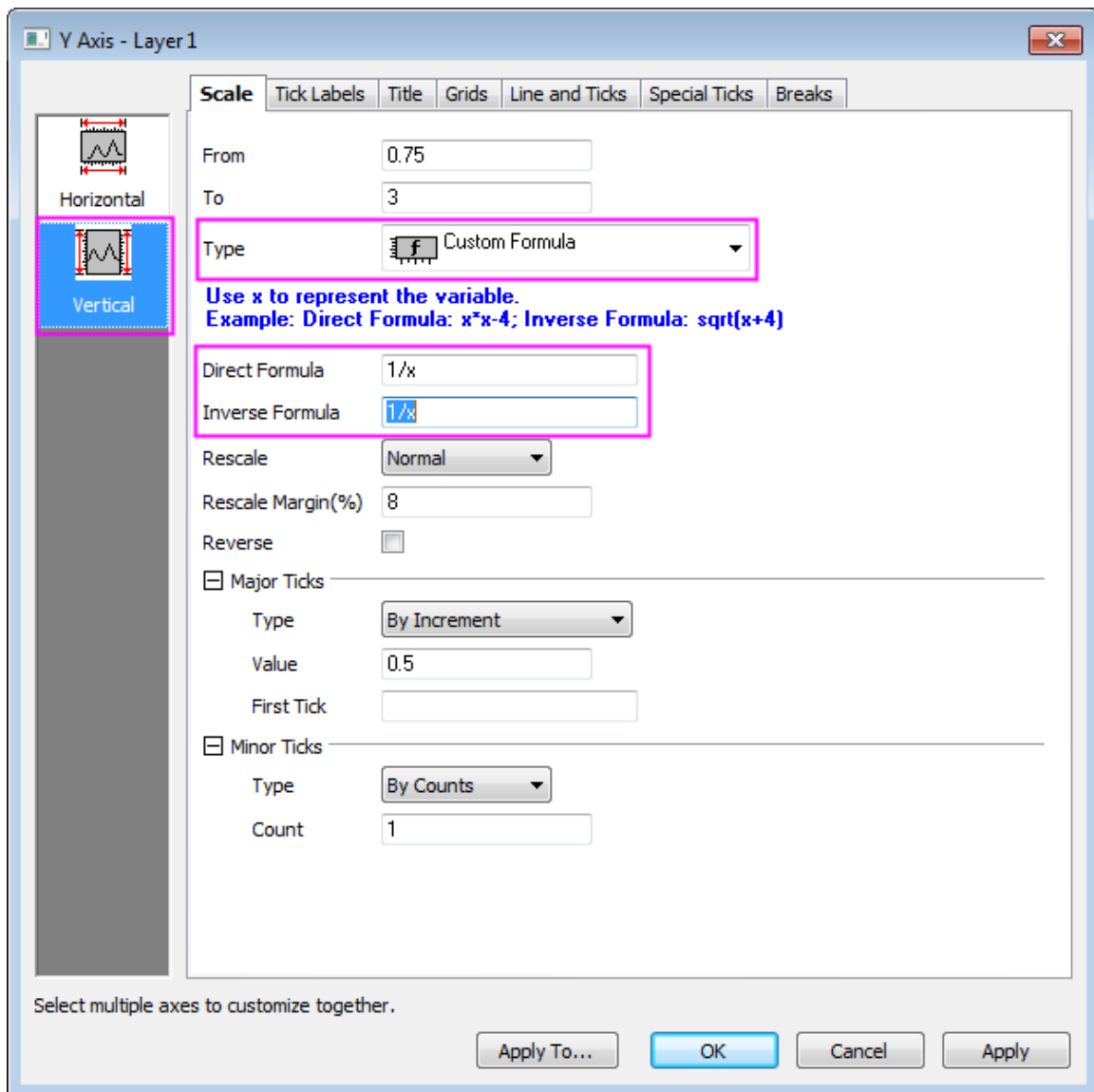

6. To perform apparent linear fit, select **Analysis:Fitting:Linear Fit:Open Dialog** to bring up the **Linear Fit** dialog box. In the **Fit Control** tab, we can see that by default the **Apparent Fit** box is checked.

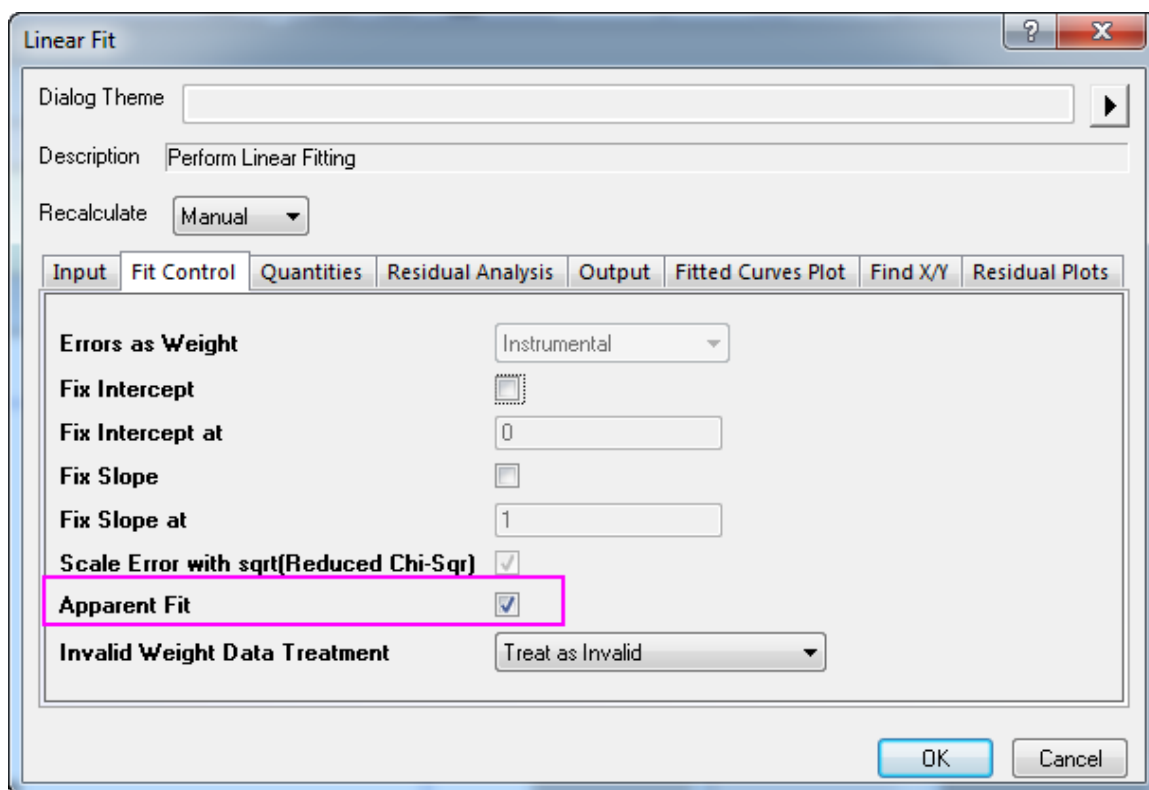

7. Click **OK** to close dialog and choose **No** radio box in the prompt, then click **OK** to close it.

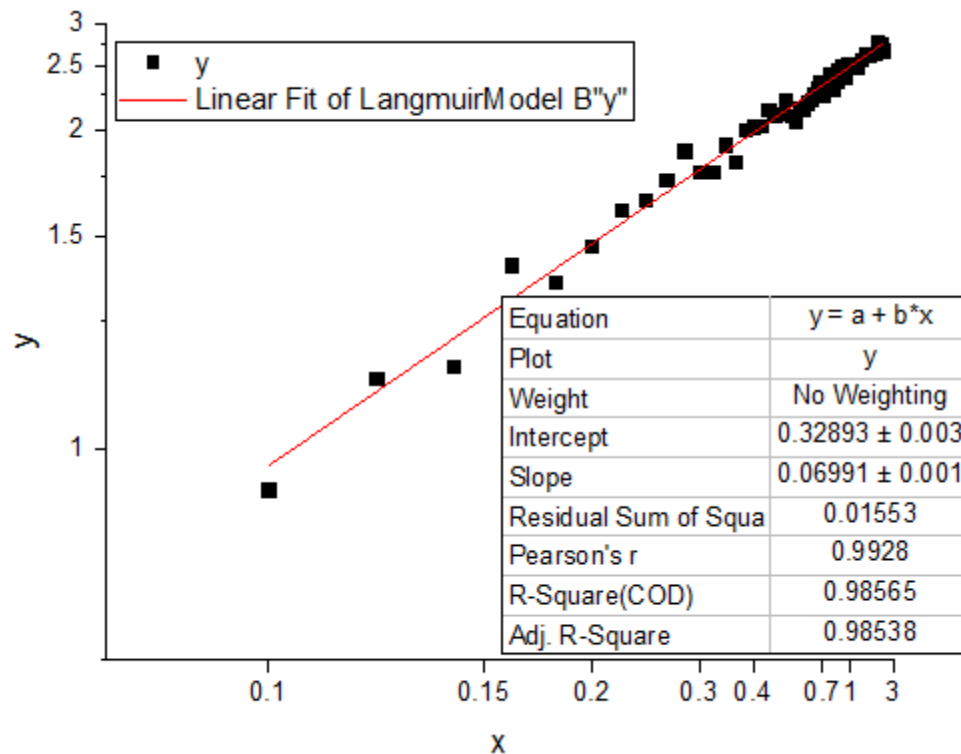

#### 4.3.2.3.4 Solutions for other non-linear kinetic models

##### Freudlich equation

The non-linear kinetic equation for Freundlich model is as below:

$$\ln(y) = \ln(K) + \frac{\ln(x)}{n}$$

where the independent variable is  $\ln(x)$ , dependent variable is  $\ln(y)$ , slope is  $1/n$  and intercept is  $\ln(K)$ ,  $K$  and  $n$  are the coefficients to be determined.

Apparent linear fit is recommended since Ln scale is a build-in scale setting. To fit this non-linear kinetic model, use apparent fit with X and Y axis scales both set to be Ln scales.

Alternatively, you can perform linear fit after you calculate the Ln value of both X and Y dataset. See the example of Langmuir model above for details.

##### Lagergren's pseudo-first order

The non-linear kinetic equation for Lagergren's pseudo-first order model is as below:

$$\log(q_{e,exp} - y) = \frac{\log(q_{e,fit}) - k_1 * x}{2.303}$$

where the independent variable is  $x$ , dependent variable is  $\log(q_{e,exp} - y)$ , slope is  $-k_1/2.303$  and intercept is  $\log(q_{e,fit})/2.303$ ,  $q_{e,exp}$  is known constant,  $-k_1$  and  $q_{e,fit}$  are the coefficients to be determined.

Apparent linear fit is recommended since Log scale is a build-in scale setting. To fit this non-linear kinetic model, first calculate  $q_{e,exp} - y$  and then use apparent fit with only Y axis scale set to be Log scale.

Alternatively, you can firstly calculate  $\text{Log}(q_{e,exp} - y)$  and use this newly created data to do linear fit directly. Refer to the example of Langmuir model above for details.

#### Ho's pseudo-second order

The non-linear kinetic equation for Freundlich model is as below:

$$\frac{x}{y} = \frac{1}{k_2 q_e^2} + \frac{x}{q_e}$$

where the independent variable is x, dependent variable is x/y, slope is  $1/q_e$  and intercept is  $1/(k_2 q_e^2)$ ,  $k_2$  and  $q_e$  are the coefficients to be determined.

To linearly fit this model, you have to firstly calculate x/y and use this newly created data to perform linear fit.

Alternatively, we can transform this equation into the form below:

$$\frac{1}{y} = \frac{1}{k_2 q_e^2} \frac{1}{x} + \frac{1}{q_e}$$

where the independent variable is 1/x, dependent variable is 1/y, slope is  $1/(k_2 q_e^2)$  and intercept is  $1/q_e$ .

For this transformation, we can either perform linear fit once we created new independent variable data as 1/x and new dependent variable data as 1/y. Or we can perform apparent linear fit by set both X and Y axis scales as 1/x scale. Please refer to Langmuir model for more details.

### 4.3.3 Nonlinear Fitting

#### 4.3.3.1 Nonlinear Fitting

- [Nonlinear Curve Fit Tool](#)
- [Nonlinear Fitting with System Function](#)
- [Global Fitting with Parameter Sharing](#)
- [Global Fit for Different Functions with Shared Parameters](#)
- [Parameters Initialization using LabTalk in NLFit](#)
- [User Defined Fitting Function](#)
- [Fit Surface with User Defined Function](#)
- [Fitting One Dataset as a Function of Other Datasets](#)
- [Fitting With Multiple Independent Variables](#)
- [User Defined Fitting Function using GNU Scientific Library](#)
- [Fitting with NAG Special Function](#)
- [Fitting Integral Function with parametric limit using NAG Library](#)
- [Fitting with Integral using NAG Library](#)
- [Fitting with Integral using LabTalk Function](#)
- [Fitting with Two Integrals using LabTalk Function](#)

- [Fitting with Summation](#)
- [Fitting Complex Function](#)
- [Fitting with Convolution](#)
- [Quoting Built-in Functions in Your New Function](#)
- [Fit Function with Non-constant Background](#)
- [Fitting with Piecewise Functions](#)
- [Fit Curve Through Certain Points](#)
- [Distribution Fit with the Probability Density Function and Cumulative Distribution Function](#)
- [Fitting Integral Function with a Sharp Peak](#)
- [Fitting with a Piecewise Linear Function](#)
- [Fitting with an Ordinary Differential Equation](#)
- [Fitting with Convolution of Two Functions](#)
- [Parameter Initialization for Rational Functions](#)
- [Surface Fitting with Multiple Peaks](#)
- [Nonlinear Multiple Variables Fitting](#)
- [Modifying Derived Parameters in Build-in Functions](#)
- [Fit Multiple Datasets by Fitting One and then Using Those Fit Parameters for Other Datasets](#)
- [Implicit Fitting with Three Variables](#)
- [Nonlinear fitting using Orthogonal Distance Regression](#)

#### 4.3.3.2 [Nonlinear Curve Fit Tool](#)

##### 4.3.3.2.1 Summary

Nonlinear fitting in Origin is performed using the NonLinear Fitting (NLFit) dialog box. The NLFit tool contains more than 200 built-in fitting functions used in many different disciplines.



To do a quick and simple fit without opening the NLFit dialog, try the [Quick Fit Gadget](#).

Minimum Origin Version Required: 8.5

##### 4.3.3.2.2 What you will learn

- How to fit with a built-in fitting function.
- How to change NLFit setting using Recalculate.
- How to define and fit with a user-defined function.

##### 4.3.3.2.3 Use a built-in function to fit the data

1. Click **File:Open...** to open the **Intro\_to\_Nonlinear Curve Fit Tool.opj** from the **\Samples\Curve Fitting** folder and select the **Built-In Function** folder from the Project Explorer window.
2. With the **Graph1** active, select the menu item **Analysis: Fitting: Nonlinear Curve Fit** to bring up the **NLFit** dialog, and then select **Gauss** from the **Function** drop-down list:

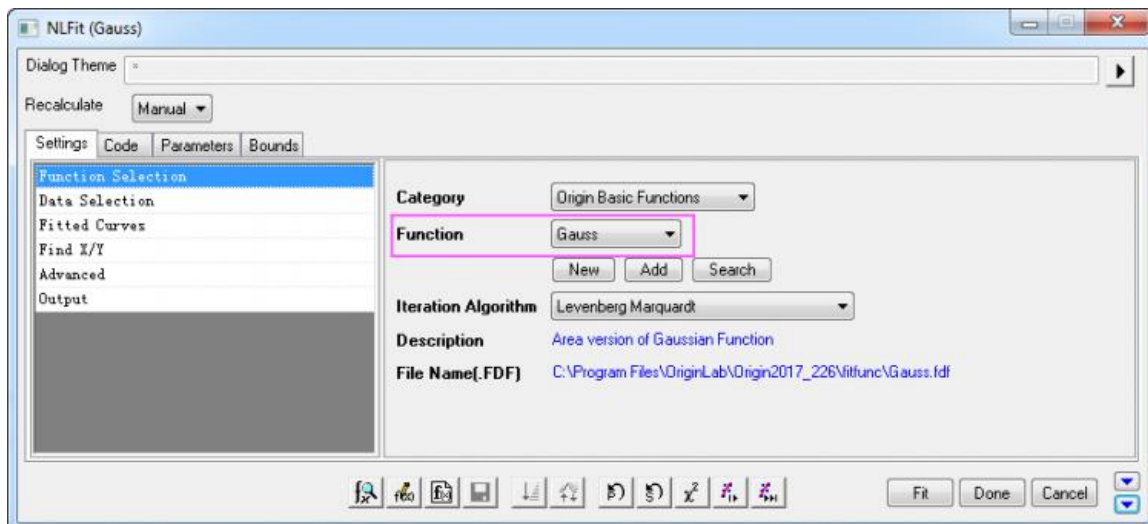

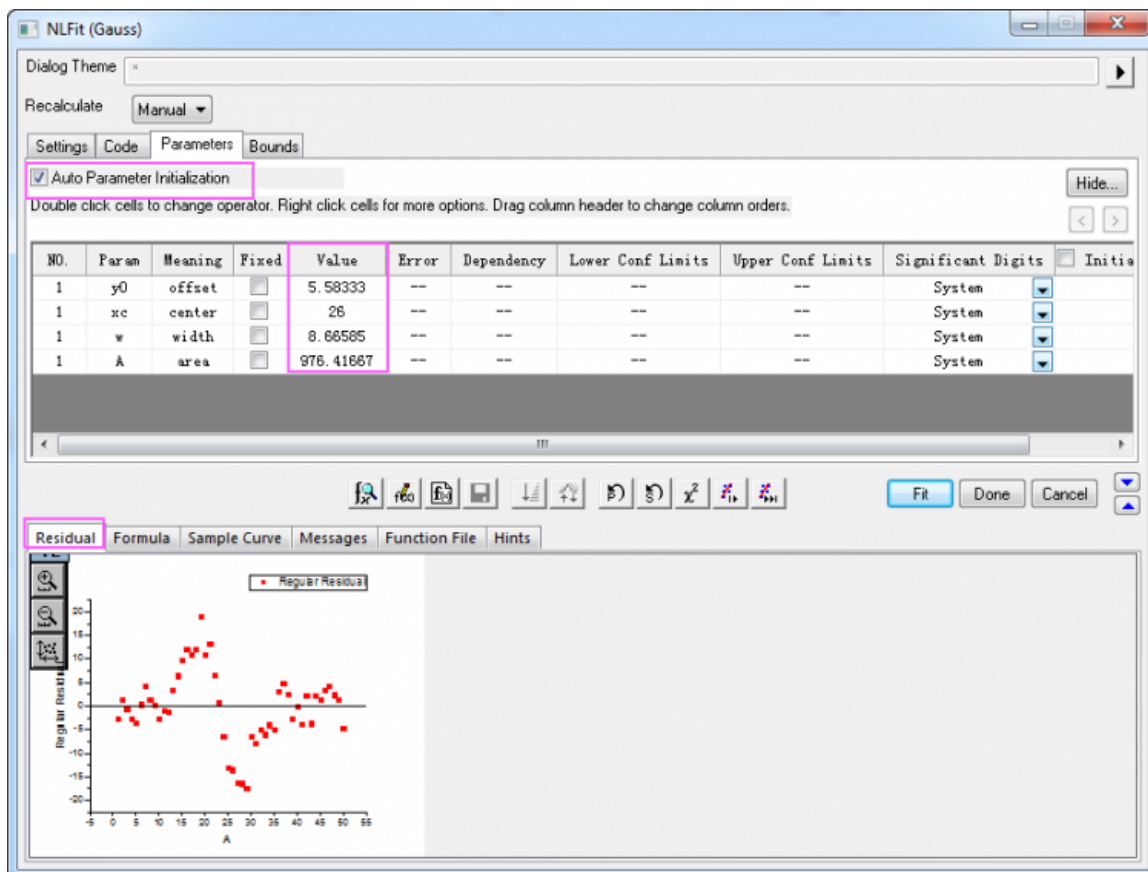

3. In the **Parameter** tab, initial parameter values are automatically assigned, because the built-in functions have parameter initialization code. If you go to the **Residual** tab, you can see the current residuals and decide whether the current fit results are acceptable.



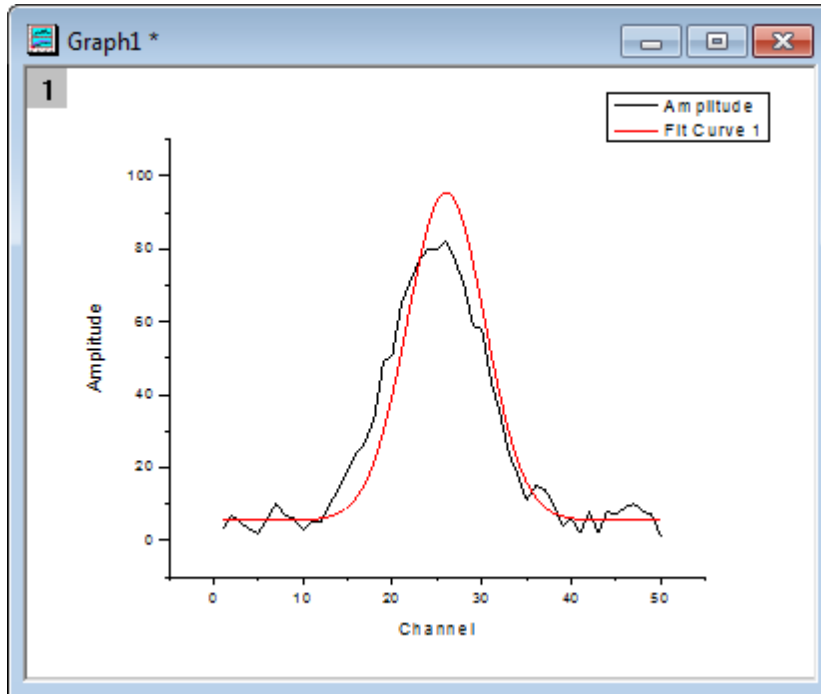

4. Note that a fitted curve drawn using the initial parameter values, is shown in the graph.



5. Click the **Fit until converged** button . To see if the fitting operation was successful, click the **Messages** tab and note the number of iterations, reduced chi-sqr value,  $R^2$  value, etc.

Residual	Formula	Sample Curve	Messages	Function File	Hints
(1) Parameter Initialization was called. (2) -----Levenberg-Marquardt----- Reduced Chi-sqr = 7.81572174469 COD( $R^2$ ) = 0.98966112534176 Iterations Performed = 5 Total Iterations in Session = 5 (3) Fit converged. Chi-Sqr tolerance value of 1E-9 was reached.					

- Click the **OK** button. The **FitNL1** report sheet is created with fit results including parameter values and fit statistics.

**Nonlinear Curve Fit (Gauss) (7/31/2018 09:11:54)**

**Parameters**

		Value	Standard Error	t-Value	Prob> t	Dependency
Amplitude	y0	5.34198	0.58341	9.15655	6.21151E-12	0.54074
	xc	24.9069	0.08666	287.40475	1.60949E-76	1.07265E-11
	w	10.16969	0.20452	49.72362	1.22804E-41	0.52123
	A	984.90204	21.45075	45.91457	4.47306E-40	0.69383
	sigma	5.08485	0.10226			
	FWHM	11.9739	0.24081			
	Height	77.27256	1.21284			

Reduced Chi-sqr = 7.81572174469  
 COD(R<sup>2</sup>) = 0.98966112534176  
 Iterations Performed = 5  
 Total Iterations in Session = 5  
**Fit converged. Chi-Sqr tolerance value of 1E-9 was reached.**  
 Standard Error was scaled with square root of reduced Chi-Sqr.  
 sigma, FWHM, Height are derived parameter(s).

**Statistics**

	Amplitude
Number of Points	50
Degrees of Freedom	46
Reduced Chi-Sqr	7.81572
Residual Sum of Squares	359.5232
R-Square (COD)	0.98966
Adj. R-Square	0.98899
Fit Status	Succeeded(100)

Fit Status Code :  
 100 : Fit converged. Chi-Sqr tolerance value of 1E-9 was reached.

Navigation: Gaussian | **FitNL1** | FitNLCurve1

7. Reopen the Nonlinear Curve Fitting dialog by clicking on the green lock icon on the upper left corner of the graph and selecting **Change Parameters**.

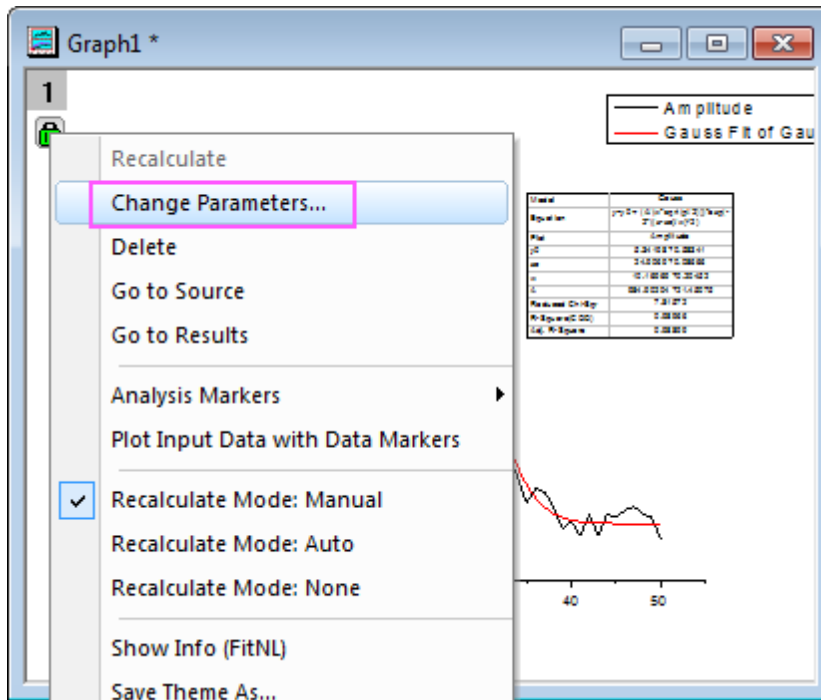

8. Go to the **Parameters** tab, change the value of xc to 25 (note that by double-clicking in the cell, you can edit the value) and select the **Fixed** check box.

NO.	Param	Meaning	Fixed	Value	Error	Dependency	Lower Conf Limits	Upper Conf Limits	Significant Digits	Initia
1	y0	offset	<input type="checkbox"/>	5.34198	--	--	--	--	System	▼
1	xc	center	<input checked="" type="checkbox"/>	25	--	--	--	--	System	▼
1	w	width	<input type="checkbox"/>	10.18969	--	--	--	--	System	▼
1	A	area	<input type="checkbox"/>	984.90204	--	--	--	--	System	▼

9. Once again, click the **Fit until converged** button  and then **OK**.

- In the report sheet, you can see that fixing the value of xc to 25 results in a Standard Error of 0.

**Parameters**

		Value	Standard Error	t-Value	Prob> t	Dependency
Amplitude	y0	5.34629	0.58432	9.14955	5.20235E-12	0.54068
	xc	25	0	--	--	0
	w	10.16855	0.20486	49.6359	2.92631E-42	0.52119
	A	984.68626	21.48327	45.83503	1.14874E-40	0.69379
	sigma	5.08427	0.10243			
	FWHM	11.97255	0.24121			
	Height	77.26433	1.21488			

Reduced Chi-sqr = 7.84134711285  
 COD(R^2) = 0.98940173226649  
 Iterations Performed = 2  
 Total Iterations in Session = 2  
**Fit converged. Chi-Sqr tolerance value of 1E-9 was reached.**  
 Some parameter values were fixed.  
 Standard Error was scaled with square root of reduced Chi-Sqr.  
 sigma, FWHM, Height are derived parameter(s).

#### 4.3.3.2.4 Define and fit with a user-defined function

In this section, we will show you how to define your own fitting function and use it in the Nonlinear Curve Fit tool

Our function is  $y = y_0 + a \cdot \exp(-b \cdot x)$

- With the project file used in the first section opened. Select **Tools: Fitting Function Builder...** menu to bring up the **Fitting Function Builder** dialog box.
- On the Goal page, click **Create a New Function**, then click the **Next** button to go to the **Name and Type** page.

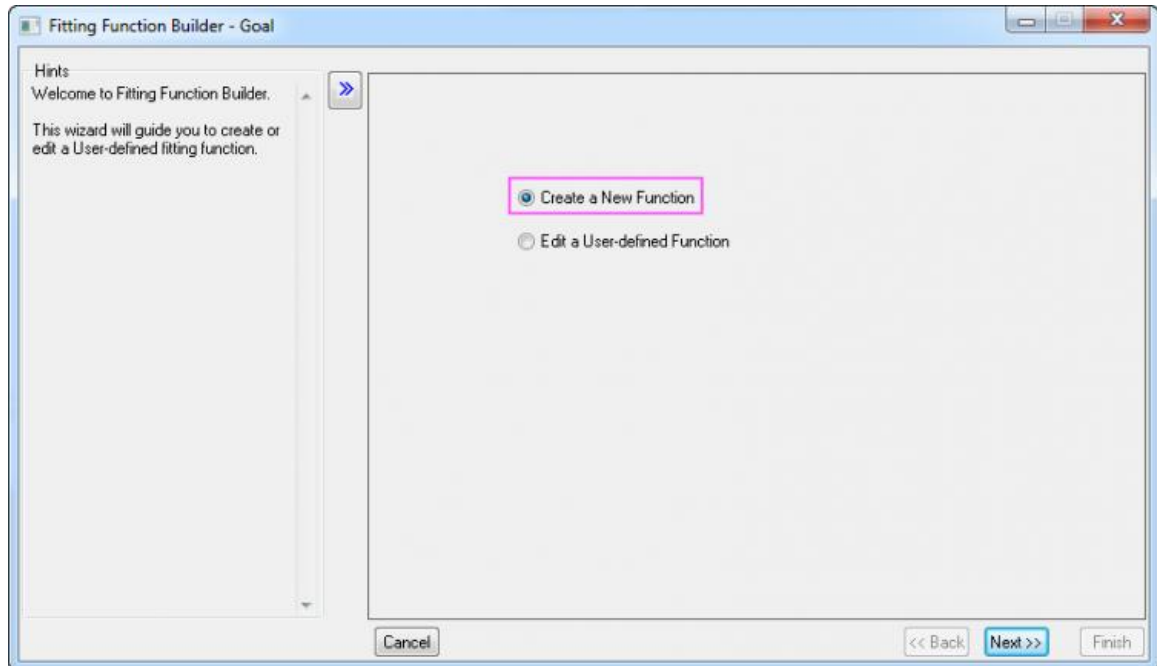

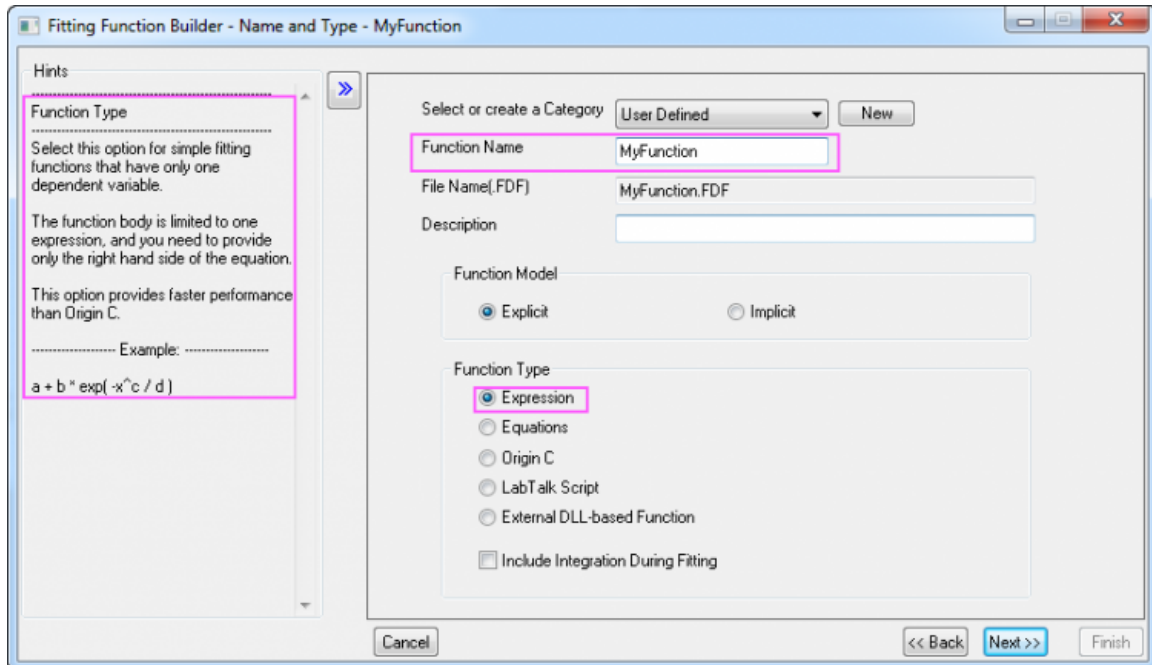

- On the **Name and Type** page, then name the function and select a Function Type. This function will be put to the **User Defined** category by default.

- Set **MyFunction** as the **Function Name**.
- Select **Expression** from the **Function Type list**. Note that the left panel displays Hints regarding the Function Type you selected.
- Click the **Next** button to turn to the **Variables and Parameters** page.

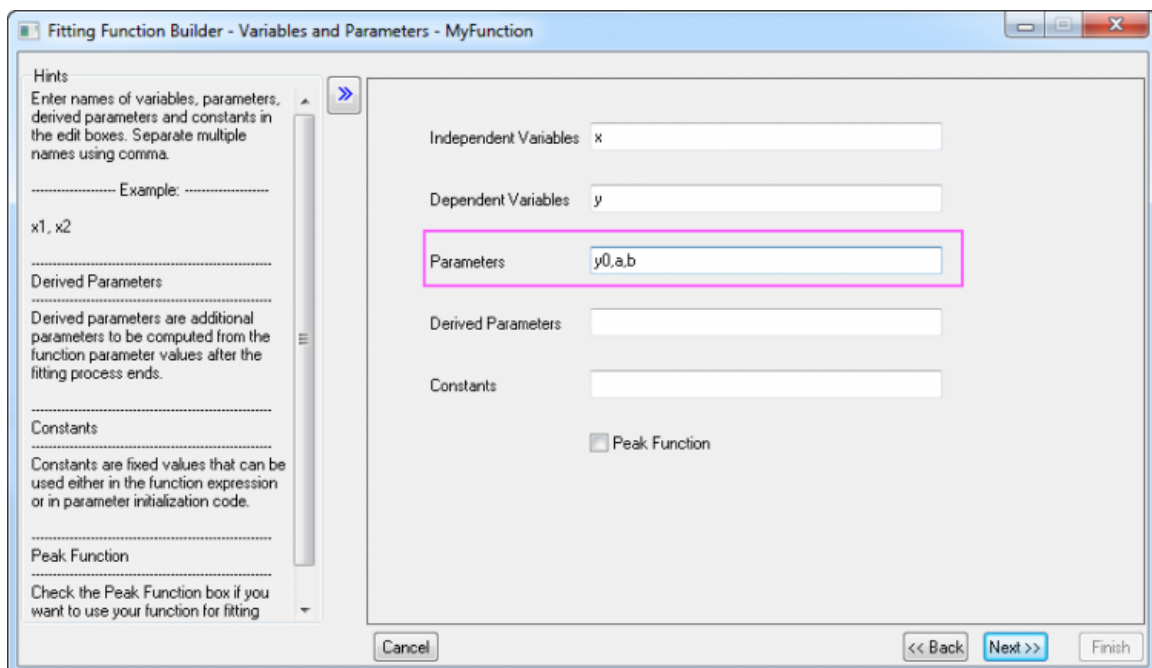

4. On the **Variables and Parameters** page, make sure **Independent Variables** reads **x** and **Dependent Variables** reads **y**. Then input the comma-separated values **y0, a, b** into the **Parameters** text box. Click the **Next** button.



5. On the **Function Body** page, perform the following operations:
  - Set the **Initial Values** for parameters as shown below.
  - In the **Function body** edit box, enter  $y_0+a*\exp(-b*x)$ .
  - Use **Quick Check** to check the validity of current function. After entering a value for the independent variables  $x$ , click the **Evaluate** button , you will get a return value of the dependent variable  $y$  which can be used to check the validity of this function.

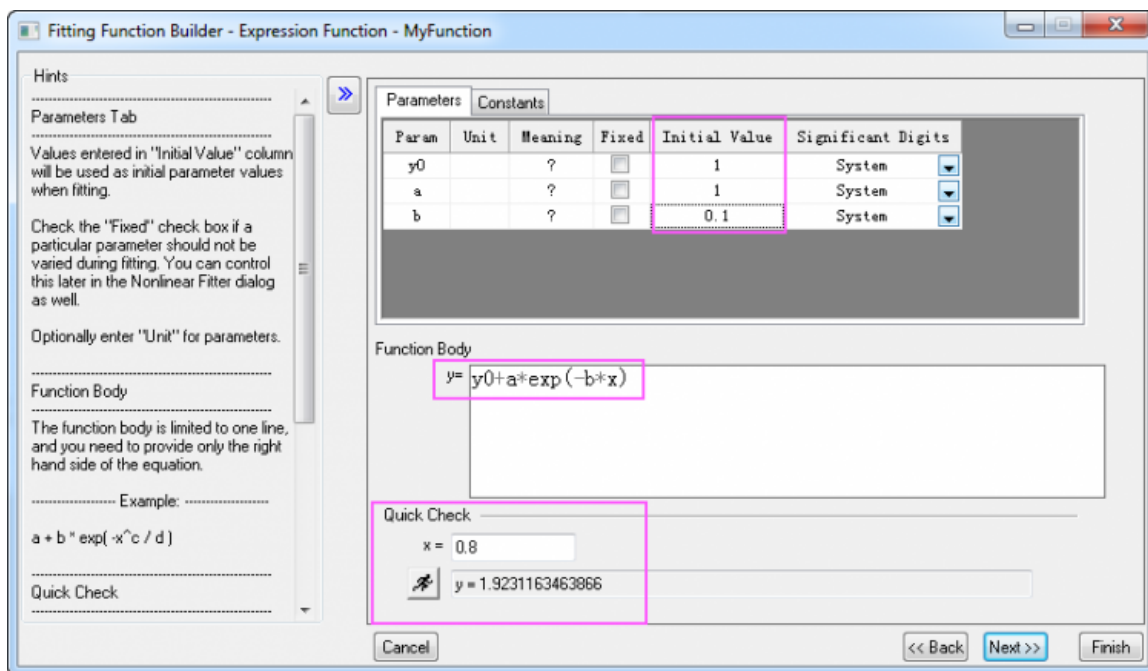

6. Click the **Finish** button to finish defining the function.
7. Open Project Explorer (**View: Project Explorer**), and select the **User-Defined Function** folder.
8. Highlight column A and B in [Book1]Sheet1, select the menu item **Analysis: Fitting: Nonlinear Curve Fit** to bring up the **NLFit** dialog. Select the **User Defined** category and your function **MyFunction** on the

**Function Selection** page, under the **Settings** tab:

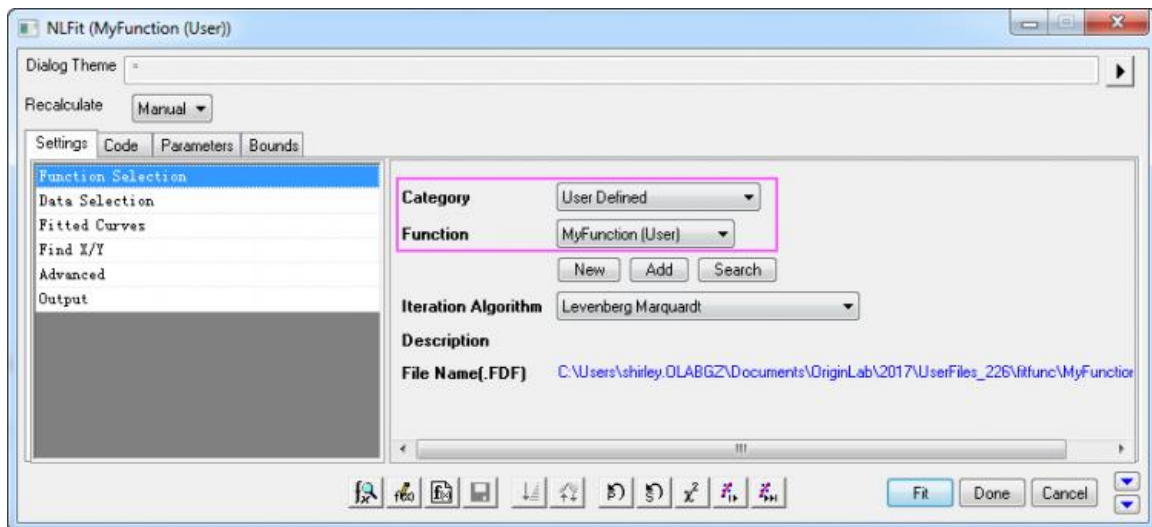

9. By successively clicking the **1 iteration button**, you can see the change in parameter values as well as the increasing conformance of the fitted curve.

- Click the "1 Iteration" button .

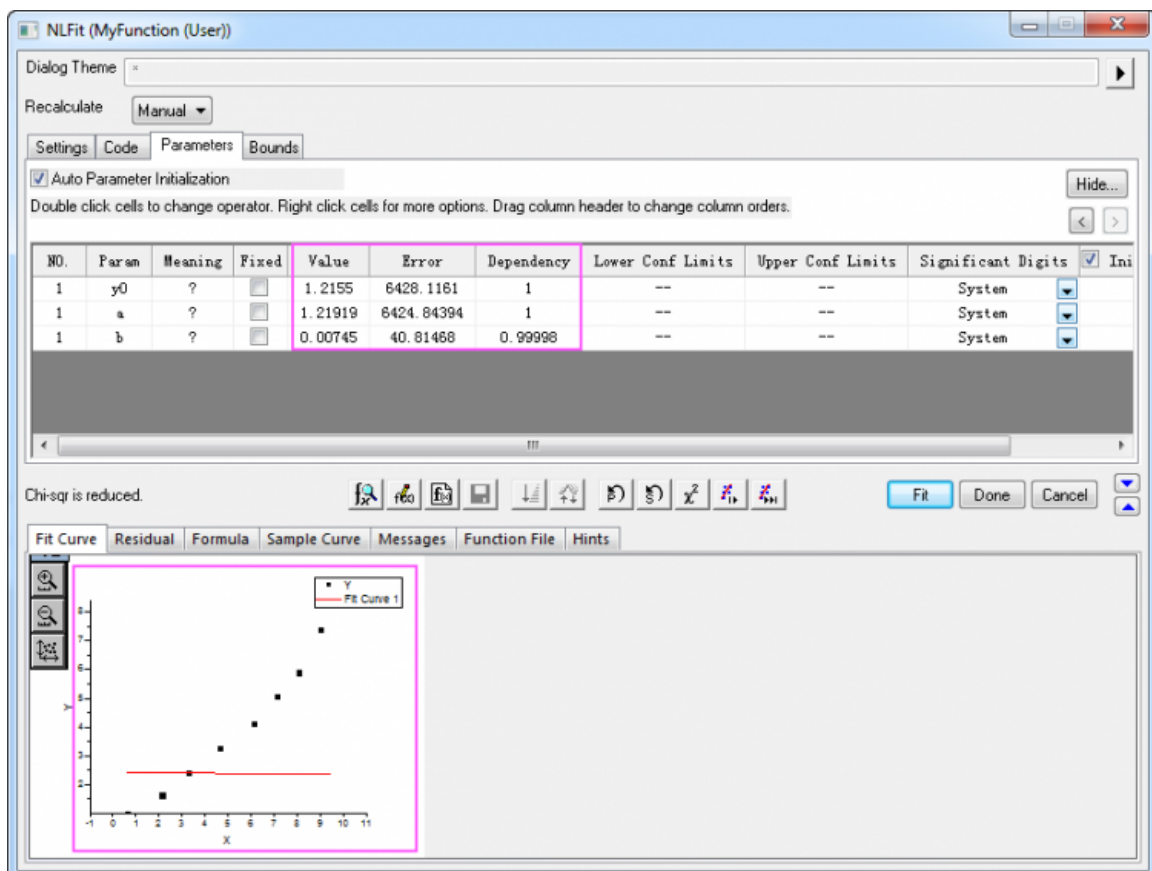

- Click the "1 Iteration" button  again.

NLFit (MyFunction (User))

Dialog Theme

Recalculate

Settings Code Parameters Bounds

Auto Parameter Initialization

Double click cells to change operator. Right click cells for more options. Drag column header to change column orders.

NO.	Param	Meaning	Fixed	Value	Error	Dependency	Lower Conf Limits	Upper Conf Limits	Significant Digits	<input checked="" type="checkbox"/> Initi
1	y0	?	<input type="checkbox"/>	1.54897	7.59462	0.99477	--	--	System	<input type="button" value="v"/>
1	a	?	<input type="checkbox"/>	1.52422	6.29927	0.99897	--	--	System	<input type="button" value="v"/>
1	b	?	<input type="checkbox"/>	-0.14872	0.32228	0.99728	--	--	System	<input type="button" value="v"/>

Chi-sqr is reduced.

Fit Curve Residual Formula Sample Curve Messages Function File Hints

- Click the **Fit until converged** button 



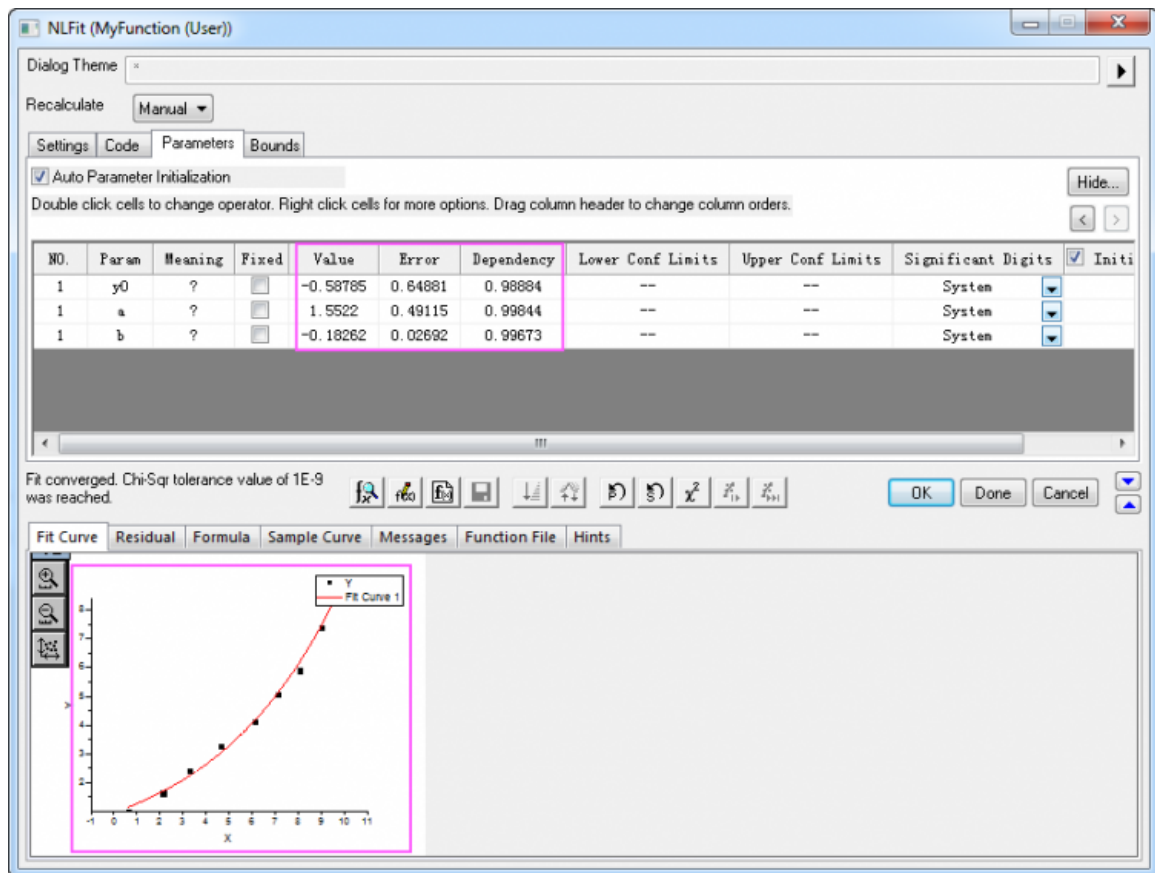

10. Click the **OK** button and the FitNL1 report sheet of fitting results is created. Here, you will find best-fit parameter values and other fit statistics.

#### 4.3.3.3 Nonlinear Fitting with System Function

##### 4.3.3.3.1 Summary

The NLFit dialog is an interactive tool which allows you to monitor the fitting procedure during the non-linear fitting process. This tutorial fits the Michaelis-Menten function, which is a basic model in Enzyme Kinetics, and shows you some basic features of the NLFit dialog. During the fitting, we will illustrate how to perform a Global Fit, which allows you to fit two datasets simultaneously and share some parameter values.

Minimum Origin Version Required: Origin 8.0 SR6

##### 4.3.3.3.2 What you will learn

This tutorial will show you how to:

- Import a single ASCII file.
- Perform a global fit with shared parameters.
- Select a fitting range and fit part of the data.
- Use the Command Window to perform a simple calculation.

### 4.3.3.3 Steps

#### Import the file

- Open a new workbook.
- Click the *Import Single ASCII* button  to bring up the **Open** dialog. Browse to `\Samples\Curve Fitting` folder and select the file *Enzyme.dat*. Make sure to check the **Show Options Dialog** checkbox at the bottom of the dialog, and then click **Open**.
- In the **impASC** dialog, expand **Import Options: Header Lines** nodes, and select **3** from *Comments From* drop down.
- Click OK to import the file.

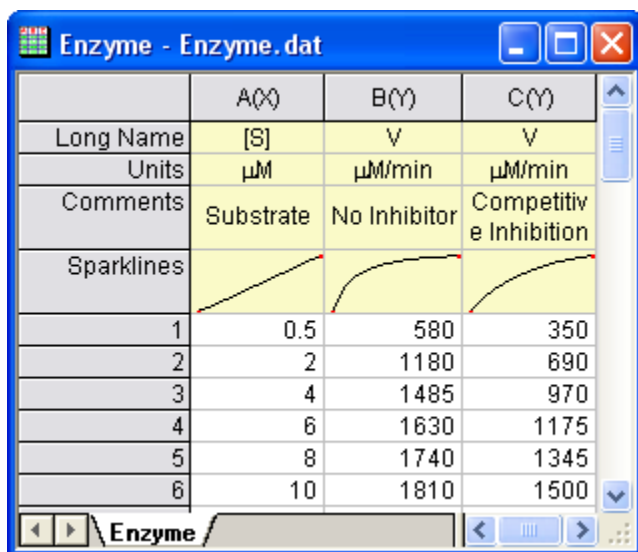

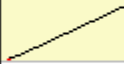
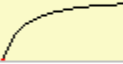
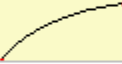
	A(X)	B(Y)	C(Y)
Long Name	[S]	V	V
Units	$\mu\text{M}$	$\mu\text{M}/\text{min}$	$\mu\text{M}/\text{min}$
Comments	Substrate	No Inhibitor	Competitive Inhibition
Sparklines			
1	0.5	580	350
2	2	1180	690
3	4	1485	970
4	6	1630	1175
5	8	1740	1345
6	10	1810	1500

#### Plotting the Data

- Select columns B and C and plot as a scatter plot by clicking the  button.

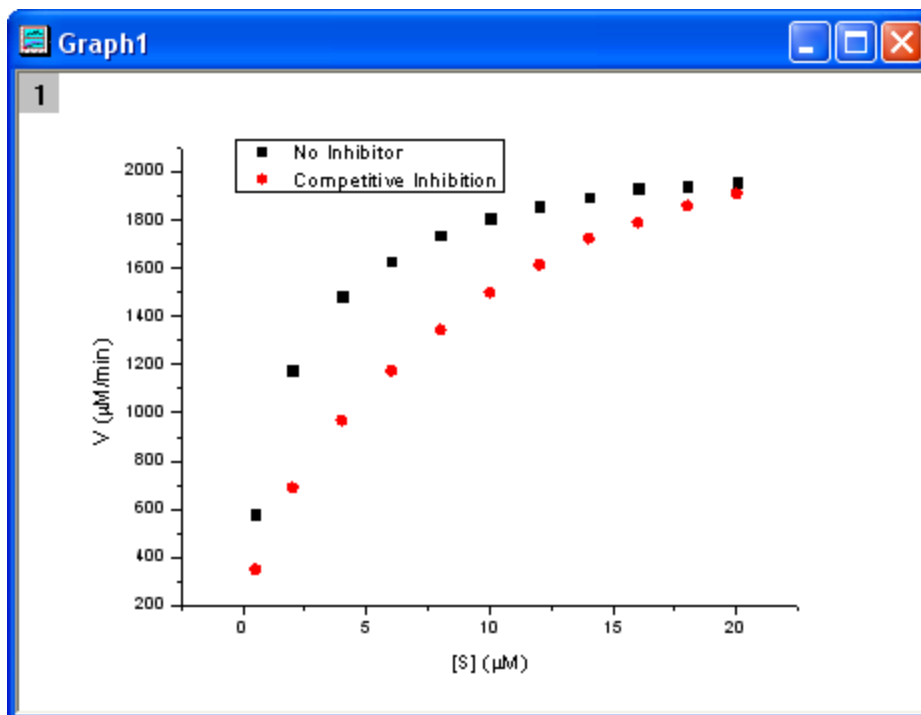

#### Fitting with the Michaelis-Menten Function

The single-substrate Michaelis-Menten function is a basic model used in enzyme kinetics studies.

$$v = \frac{V_{max}[S]}{K_m + [S]}$$

The parameter  $v$  is the reaction velocity,  $[S]$  is the substrate concentration,  $V_{max}$  is the maximal velocity, and  $K_m$  represents the Michaelis constant. Parameters  $V_{max}$  and  $K_m$  are important enzyme properties and their values can be determined by fitting the M-M function to a  $v$  vs.  $[S]$  curve. While there is no M-M fitting function in Origin, we can use a more general model, the built-in *Hill* function to perform the fit:

$$v = V_{max} \frac{x^n}{k^n + x^n}$$

where  $n$  is the cooperative sites. For a single-substrate model, we fix  $n = 1$ , thus simplifying the model so that it behaves like the M-M function.

There are two curves, one is the reaction without an Inhibitor and the other is the reaction with a Competitive Inhibitor. We will use the NLFit tool to fit these two curves simultaneously. Since for competitive inhibition reactions, the maximum velocity is the same as with no inhibition, we can share the  $V_{max}$  value during the fitting procedure and perform a *Global Fit*.

- With the graph active, select the menu item **Analysis: Fitting: Nonlinear Curve Fit** to bring up the NLFit dialog. Select *Hill* function from *Growth/Sigmoidal* category on the **Settings: Function Selection** page.

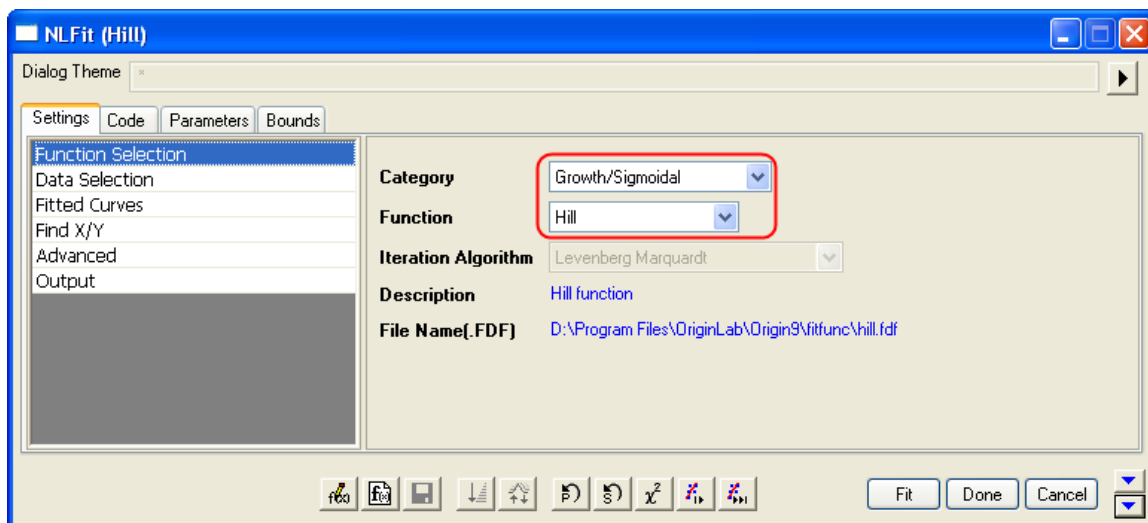

- On the **Settings: Data Selection** page, click the triangular button next to the **Input Data** and choose **Add all plots in active page** to set the data range.

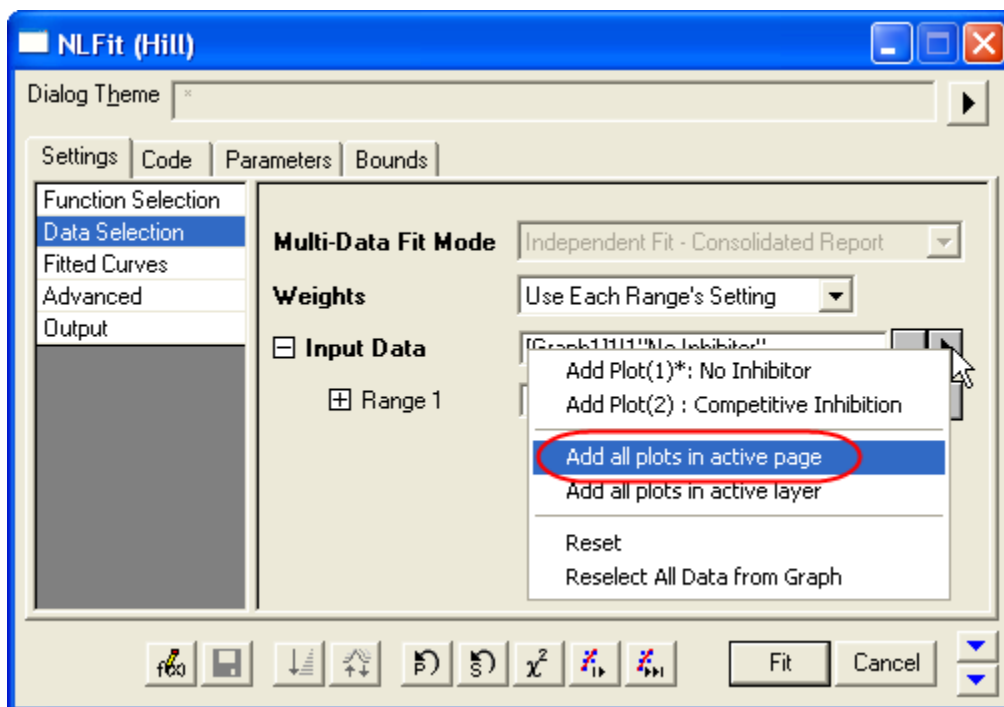

- Select *Global Fit* from **Multi-Data Fit Mode** drop-down list on the **Settings: Data Selection** page.

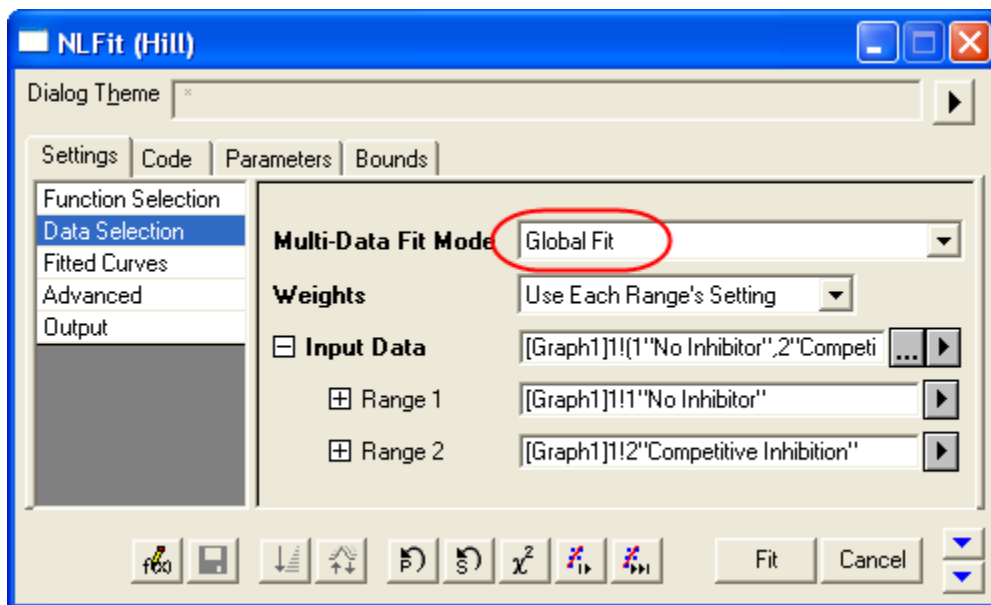

- Switch to the **Parameters** tab, check the **Share** box on the Vmax row. These *Share* check boxes are only available when using *Global Fit* mode. Check the **Fixed** box for n and n<sub>2</sub>, and make sure their values are 1.

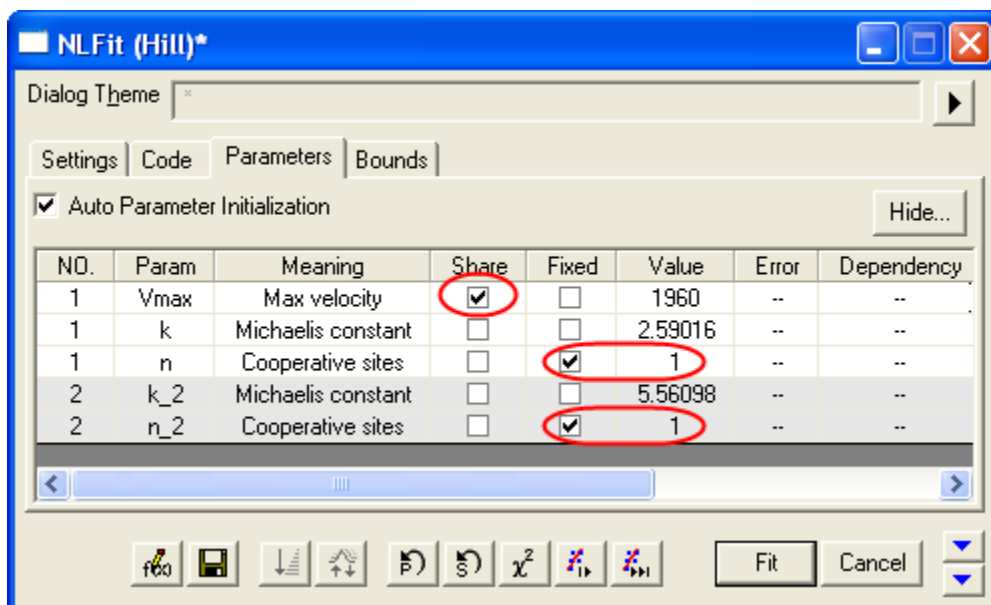

Click the *Fit* button to generate the analysis reports. A table of fit parameters is pasted to the original graph (only the fit parameter values table is shown in the following figure.)

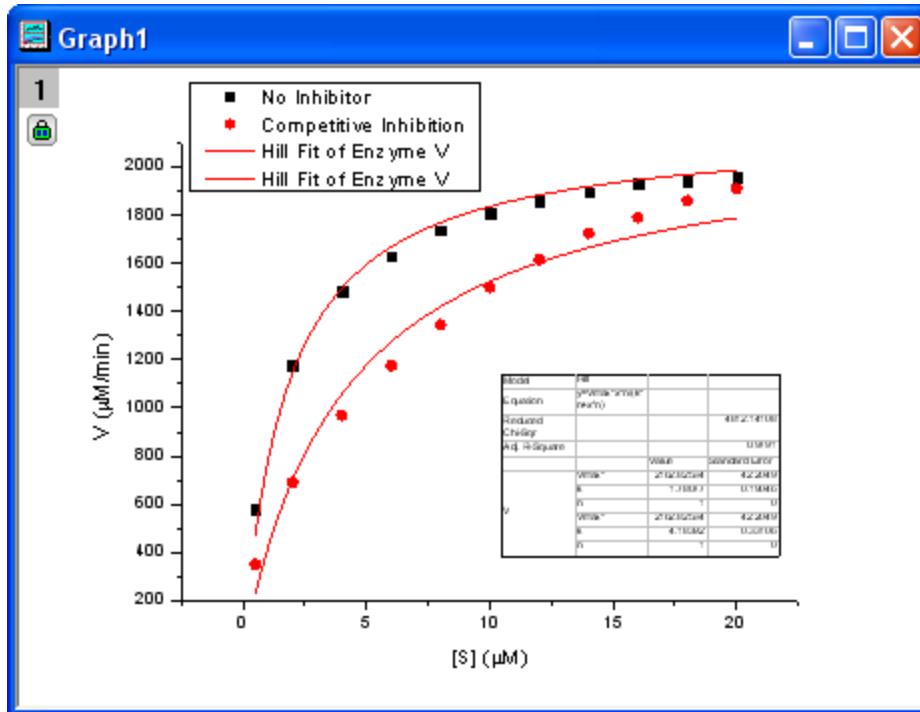

From the fit result, we can conclude that the maximum velocity is  $2162.8 \mu M/min$ . The value of  $K_m$  for the no inhibitor model is  $1.78 \mu M$ . The value  $K_m$  for the competitive inhibitor model is  $4.18 \mu M$ .

**Fitting Lineweaver-Burk Plot**

As we know, the model parameters can also be estimated by the Lineweaver-Burk or double-reciprocal plot. The Lineweaver-Burk plot takes the reciprocal of both sides of the M-M function and plots by  $1/v$  vs.  $1/[S]$ :

$$\frac{1}{v} = \frac{1}{V_{max}} + \frac{K_m}{V_{max}[S]}$$

This is actually a linear function:

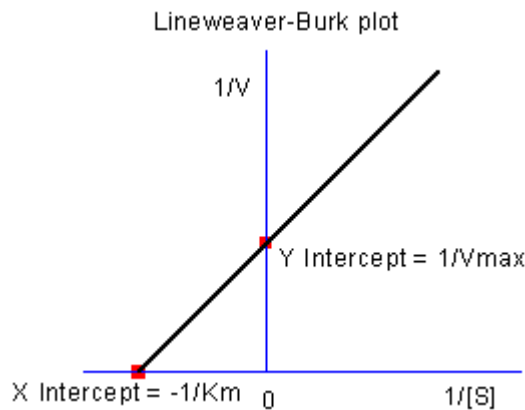



We will use the No Inhibitor data to illustrate how to calculate  $K_m$  and  $V_{max}$  by L-B plot.

- Go back to the raw data worksheet and add two more columns by clicking the  button. Right-click on column D and select **Set As: X** from the context fly-out menu to set it as an X column. Right-click on column E again and select **Set Column Values** to bring up the **Set Values** dialog. In the dialog edit box, enter:  $1/Col(A)$  and set the **Recalculate** mode as *None*, since we don't need to auto update the reciprocal values in this example.

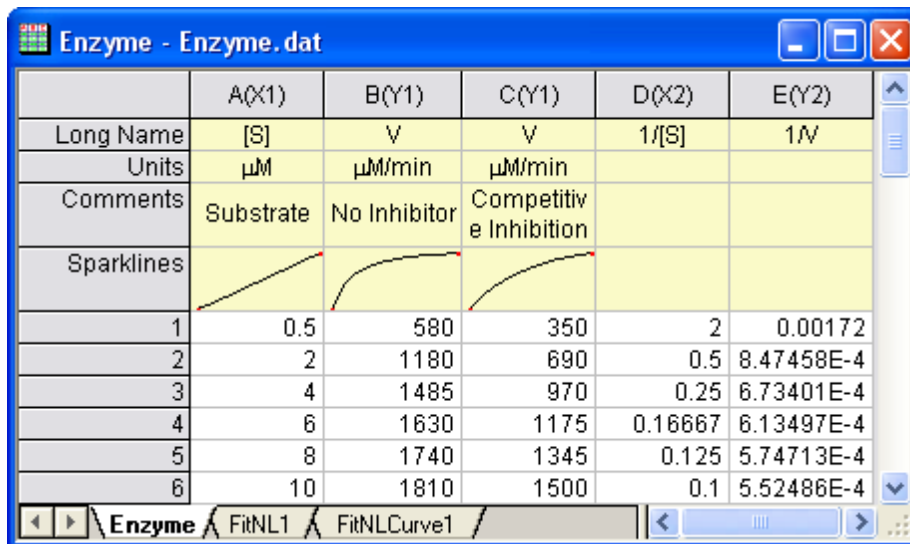
Similarly, set column E's values as  $1/Col(B)$ . Enter the long name for column D & E as  $1/[S]$  &  $1/V$ , respectively. And then we have:



	A(X1)	B(Y1)	C(Y1)	D(X2)	E(Y2)
Long Name	[S]	V	V	1/[S]	1/V
Units	$\mu\text{M}$	$\mu\text{M}/\text{min}$	$\mu\text{M}/\text{min}$		
Comments	Substrate	No Inhibitor	Competitive Inhibition		
Sparklines					
1	0.5	580	350	2	0.00172
2	2	1180	690	0.5	8.47458E-4
3	4	1485	970	0.25	6.73401E-4
4	6	1630	1175	0.16667	6.13497E-4
5	8	1740	1345	0.125	5.74713E-4
6	10	1810	1500	0.1	5.52486E-4

- Highlight columns D & E and click  button to create a scatter plot.

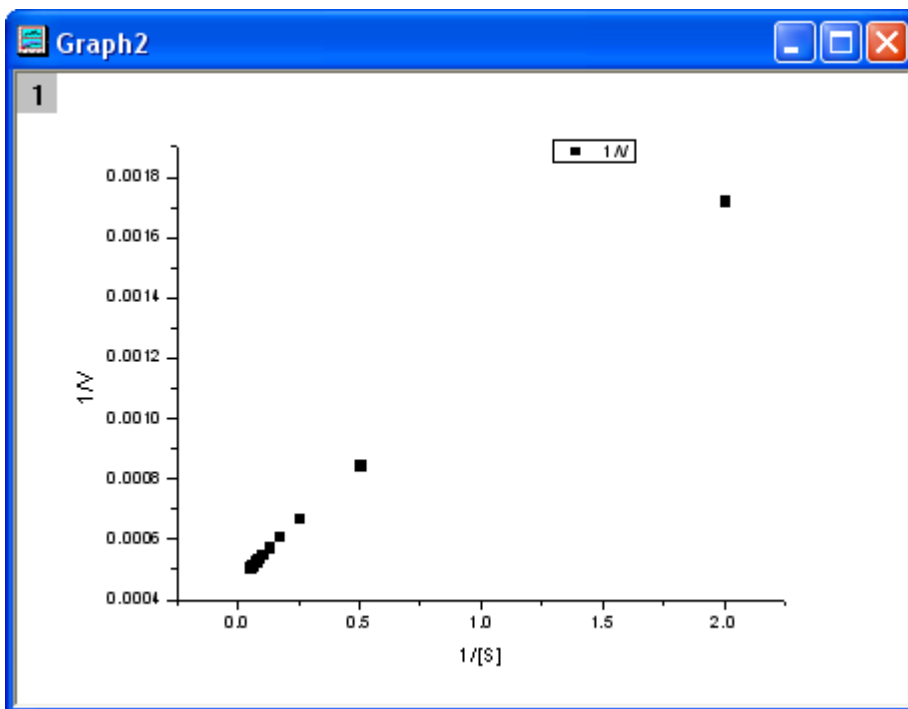

From the above equation, we know there is a linear relationship between  $1/v$  and  $1/[S]$ , so we can use the NLFit tool to fit a straight line on this plot. (You can also use the Fit Linear tool from **Analysis: Fitting: Fit Linear**)

- Bring up the NLFit dialog again, select *Line* function from *Polynomial* category, and then click the *Fit* button  directly to generate results.

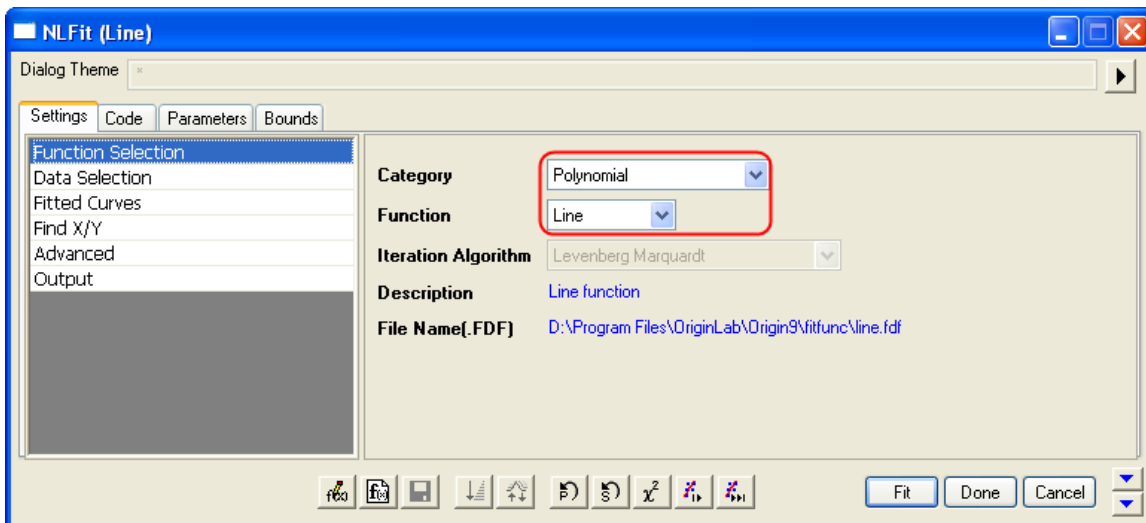



From the plot, one may doubt that this is the best fit curve since there is a point located far away. Actually, the right side of L-B plot is low substrate concentrations area, the measurement error may be large, so we'd better exclude these points during fitting.

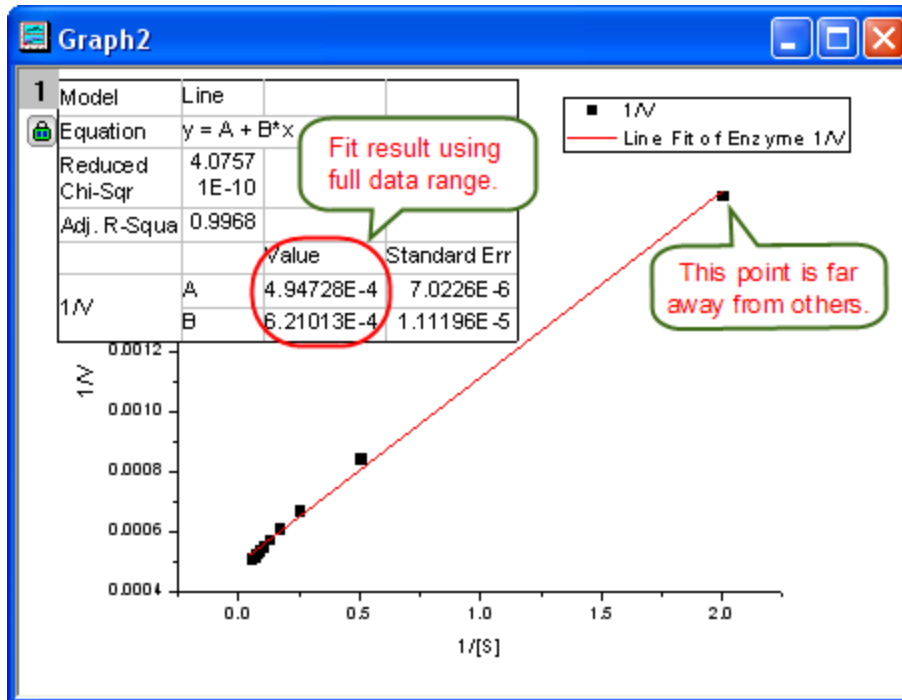

- Click the lock icon on the graph upper-left corner, and select *Change Parameters* to bring back NLFit dialog.

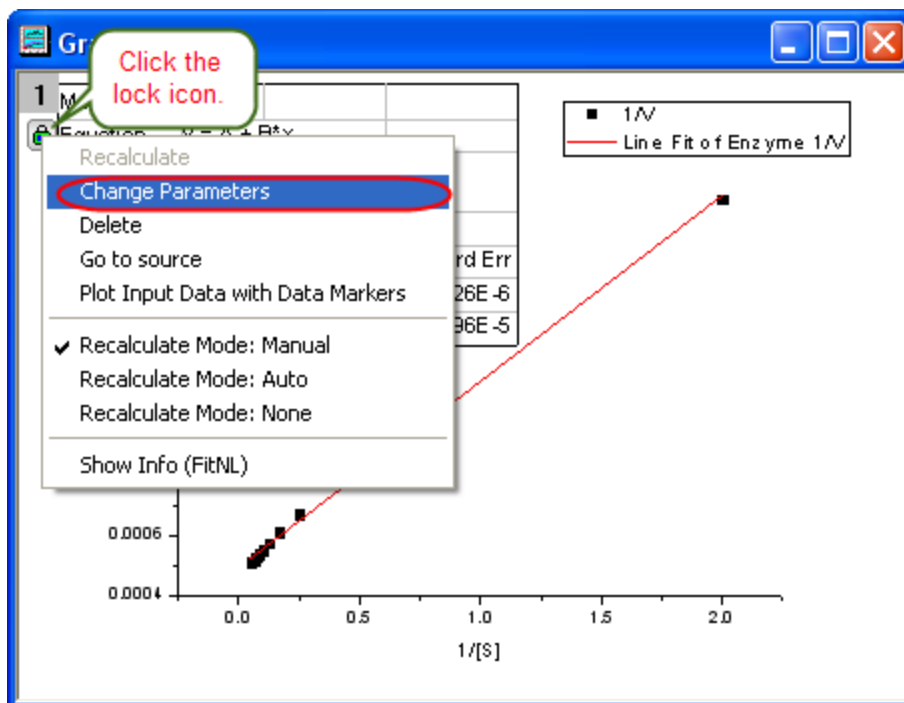

In **Settings: Data Selection** page, click the  button on **Input Data** node, and then choose *Reselect All Data from Graph* from fly-out menu.

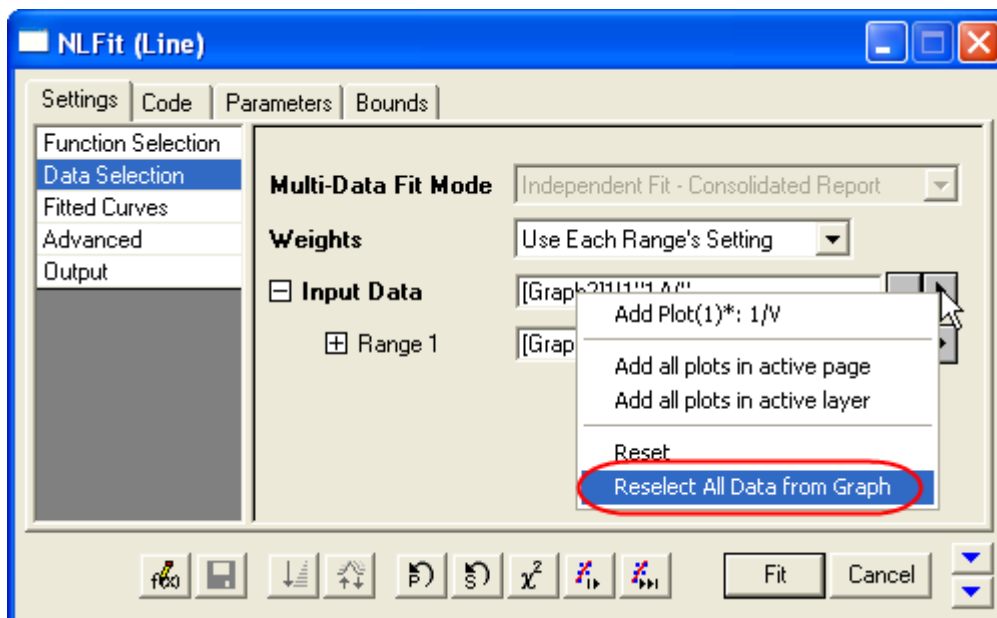

Then the NLFit dialog rolls up and your cursors become  when you move to the graph page. Click and draw a rectangle to select data points you want to fit. The input range is labeled by vertical lines. You can also click-and-move these lines to change the input range.

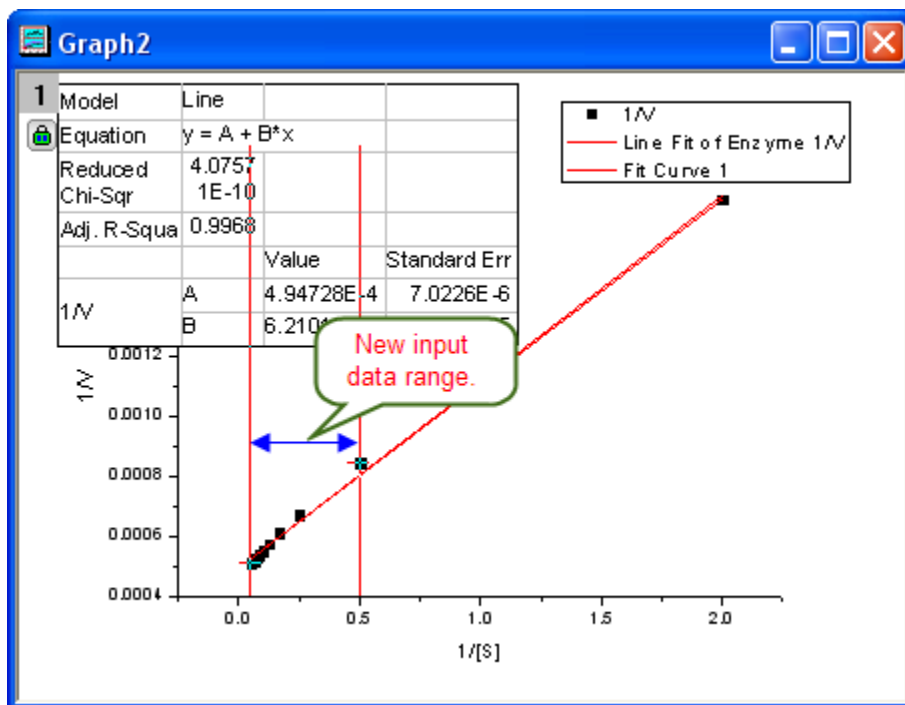

Click the  button on **Select Data in Graph** window to go back to NLFit dialog.



- Click the *Fit* button on the NLFit dialog to recalculate the result. You can see from the graph that the report table was updated.

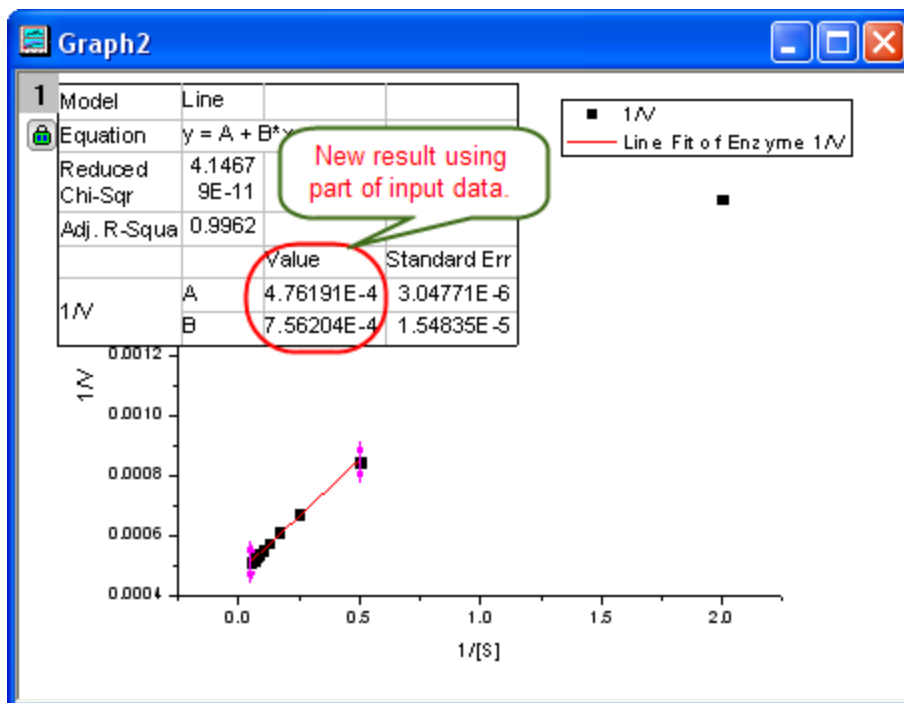

- Since the intercept of the fitted curve is  $1/V_{max}$ , it is equal to 4.76191E-4 in this example. To get the  $V_{max}$  value, select **Window: Command Window** to open the command window, type

1/4.76191E-4 =

and press ENTER:

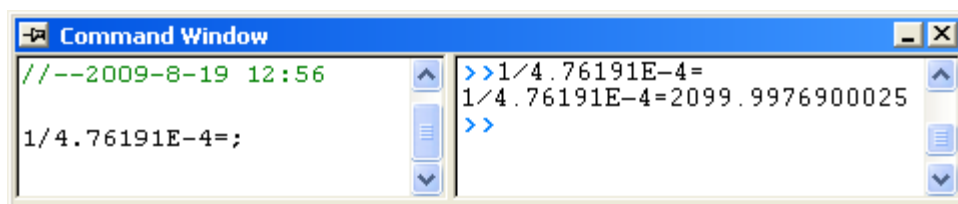

Origin returns the value 2099, which is close to what we got above, 2160. (When fitting the hill function above, we shared  $V_{max}$  when fitting two datasets. If you fit the No Inhibitor data only, this value will be closer.)

#### 4.3.3.4 Global Fitting with Parameter Sharing

##### 4.3.3.4.1 Summary

The term "global fitting" generally refers to simultaneous curve fitting operations performed on multiple datasets. Because datasets remain distinct, they may or may not "share" parameter values during the fit process. When a parameter is shared, a single parameter value is calculated for all datasets; When a parameter is not shared, a separate parameter value is calculated for each dataset.

By contrast, "concatenated fitting" is performed by combining all datasets into a single dataset. Because curve fitting operations are performed on a single dataset, only a single set of parameter values is returned.



Since 2016 SR2, an new app [Sequential Fit](#) has been released to do sequential fitting on multiple datasets. With this app, the fit parameter values obtained from the current dataset will be used to initialize the parameters of the next dataset. This is very applicable for those datasets, the common parameters of which keep changing in turn.

#### 4.3.3.4.2 What you will learn

This tutorial will show you how to:

- Select multiple datasets for fitting.
- Select different fitting modes.
- Perform global fit with parameter sharing.

#### 4.3.3.4.3 Steps

1. Create a new workbook by clicking the  button.
2. Click the  to import the file **Enzyme.dat** in the <Origin EXE Folder>\Samples\Curve Fitting\ folder.
3. Highlight column B and C and click the  button to generate a scatter plot.
4. Keep the graph window activated and select the **Analysis: Fitting: Nonlinear Curve Fit** menu item to open the **NLFit** dialog.
5. Set the **Recalculate** mode to **Auto**.
6. In the **Function Selection** page, choose the **Hill** function from the **Growth/Sigmoidal** category.
7. Go to the **Data Selection** page, click the triangle button next to the **Input Data** selection box and choose **Add All Plots in Active Layer**, to add both plots as input data.
8. Select **Global Fit** mode from the **Multi-Data Fit Mode** drop-down list:

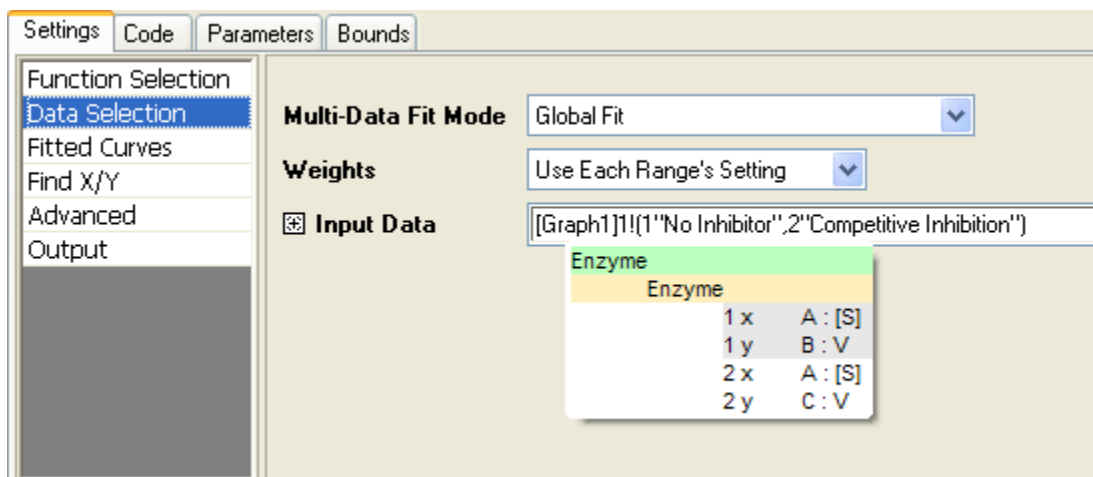

9. Go to the **Parameters** tab. Check the **Fixed** check box for  $n$  and  $n_2$  to fix their values to 1.

Param	Meaning	Share	Fixed	Value	Error
Vmax	Max velocity	<input type="checkbox"/>	<input type="checkbox"/>	1960	--
k	Michaelis constant	<input type="checkbox"/>	<input type="checkbox"/>	2.59016	--
n	Cooperative sites	<input type="checkbox"/>	<input checked="" type="checkbox"/>	1	--
Vmax_2	Max velocity	<input type="checkbox"/>	<input type="checkbox"/>	1910	--
k_2	Michaelis constant	<input type="checkbox"/>	<input type="checkbox"/>	5.56098	--
n_2	Cooperative sites	<input type="checkbox"/>	<input checked="" type="checkbox"/>	1	--

10. Click the **Fit** button to fit curves. You will get these results from the **Parameters** table of the report worksheet:

**Parameters**

		Value	Standard Error	t-Value	Prob> t	Dependency
V	Vmax	2091.96109	33.62032	62.22311	--	0.66992
	k	1.52432	0.13786	11.05711	--	0.66992
	n	1	0	--	--	0
	Vmax	2428.49265	81.97136	29.62611	1.00046E-16	0.89747
	k	5.86377	0.56737	10.33497	5.36612E-9	0.89747
	n	1	0	--	--	0

Reduced Chi-sqr = 2667.34803491  
 COD(R<sup>2</sup>) = 0.99008849138444  
 Iterations Performed = 7  
 Total Iterations in Session = 7  
 Fit converged. Chi-Sqr tolerance value of 1E-9 was reached.  
 Some parameter values were fixed.  
 Standard Error was scaled with square root of reduced Chi-Sqr.

11. The fitted curves will be added to the original data plot.

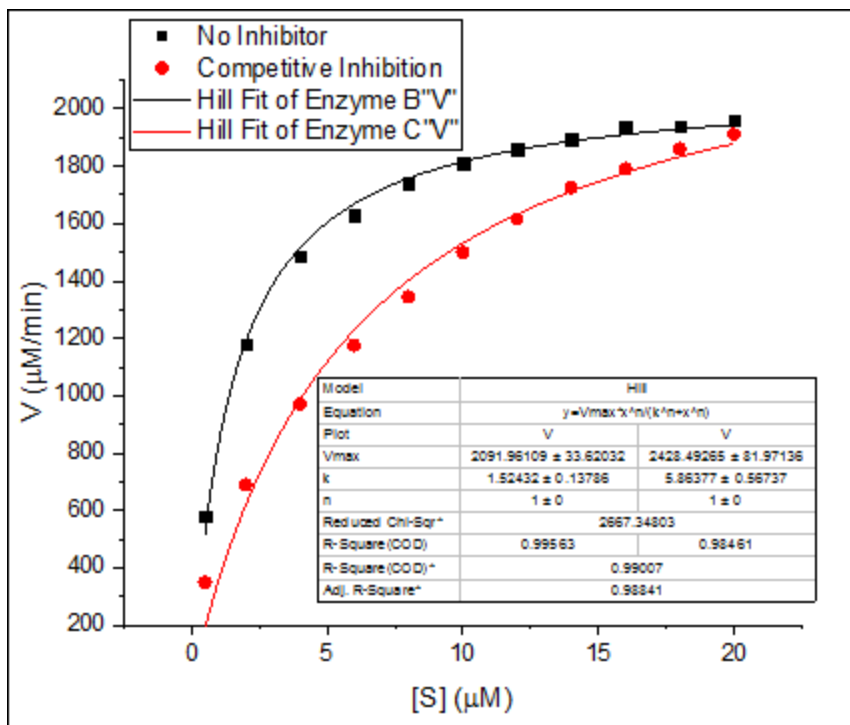

12. In this case, the maximum velocity  $V_{max}$  may be the same, so we could share this parameter value when fitting.
13. Click the green lock icon in the report worksheet and select **Change Parameters** to bring back the **NLFit** dialog.

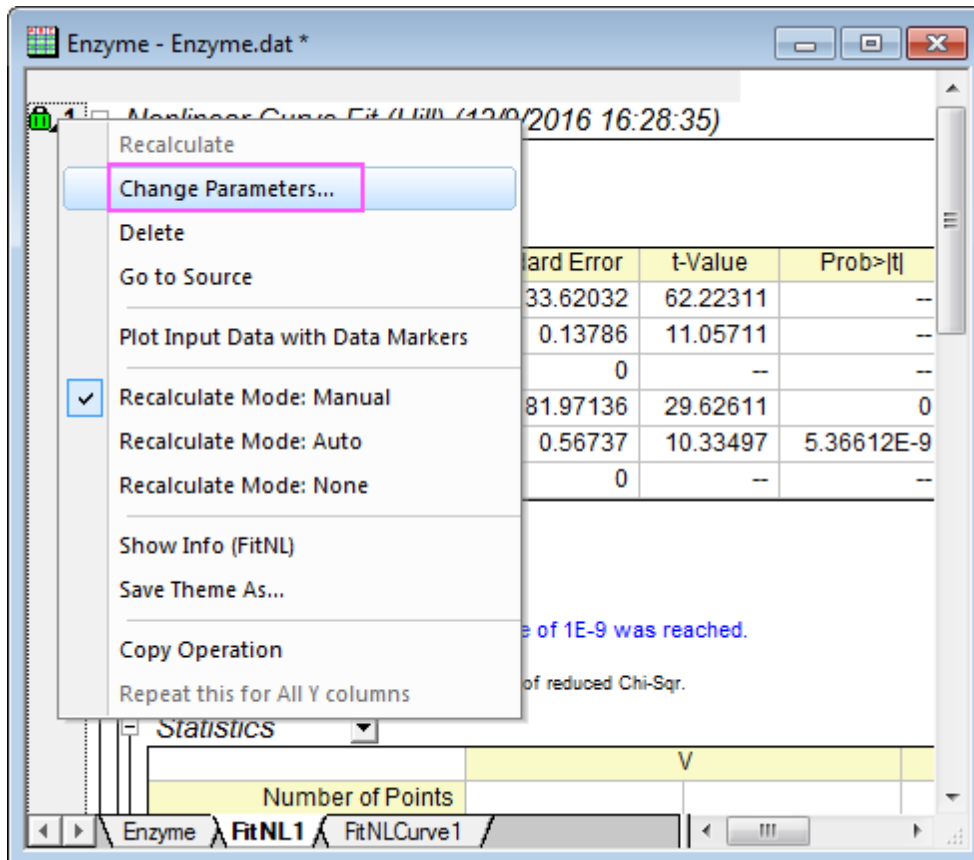

14. In the **Parameters** tab, check the **Share** check box for  $V_{max}$ .

Settings Code Parameters Bounds

Automatic Parameter Initialization is enabled.

Param	Meaning	Share	Fixed	Value	Error
$V_{max}$	Max velocity	<input checked="" type="checkbox"/>	<input type="checkbox"/>	1960	--
k	Michaelis constant	<input type="checkbox"/>	<input type="checkbox"/>	2.59016	--
n	Cooperative sites	<input type="checkbox"/>	<input checked="" type="checkbox"/>	1	--
$k_2$	Michaelis constant	<input type="checkbox"/>	<input type="checkbox"/>	5.56098	--
$n_2$	Cooperative sites	<input type="checkbox"/>	<input checked="" type="checkbox"/>	1	--

15. Click the **Fit** button again to update results. You can see the *Vmax* values for both curves are the same. The asterisk in the parameter name indicates that this parameter is shared:

**Parameters**

		Value	Standard Error	t-Value	Prob> t	Dependency
V	Vmax*	2162.82534	42.2049	51.24584	--	0.76631
	k	1.78077	0.19046	9.35003	--	0.63991
	n	1	0	--	--	0
	Vmax*	2162.82534	42.2049	51.24584	7.81935E-22	0.76631
	k	4.18392	0.33106	12.63784	1.07513E-10	0.60034
	n	1	0	--	--	0

Reduced Chi-sqr = 4812.1410794  
 COD(R<sup>2</sup>) = 0.9810872367708  
 Iterations Performed = 7  
 Total Iterations in Session = 7  
 Fit converged. Chi-Sqr tolerance value of 1E-9 was reached.  
 Some parameter values were fixed.  
 Standard Error was scaled with square root of reduced Chi-Sqr.  
 \*: Shared Parameter

16. The fitted curve will automatically update.

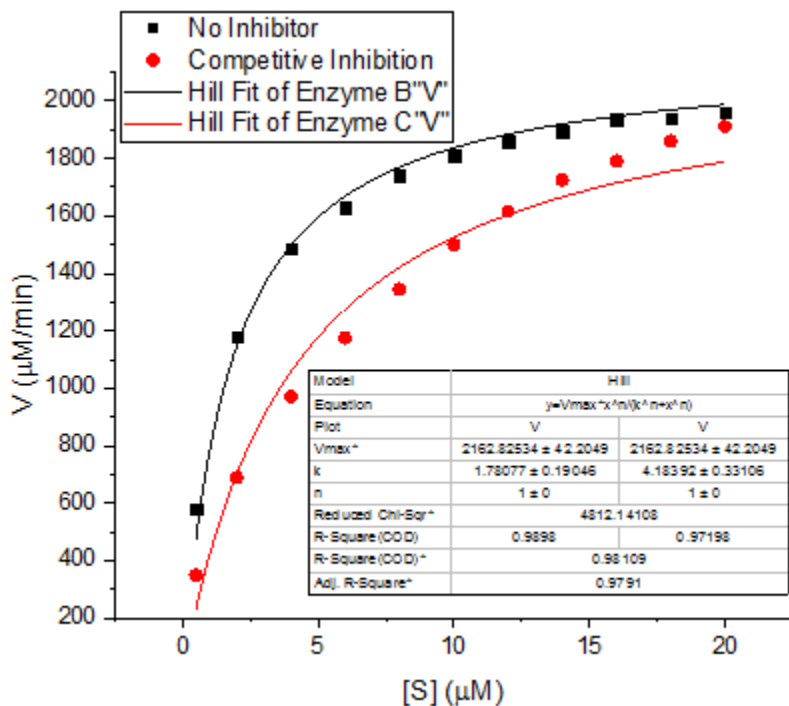

- 17.

#### 4.3.3.5 Global Fit for Different Functions with Shared Parameters

##### 4.3.3.5.1 Summary

This tutorial is aimed at solving the following problem: do global curve fitting on two or more curves using different function for each curve, but sharing some parameters, the shared parameter was common to all the datasets. This problem arises in a wide variety of scientific fields such as fitting for anisotropy spectrum.

Minimum Origin Version Required: Origin 2015 SR1





#### 4.3.3.5.2 What you will learn

This tutorial will show you how to:

- Select multiple datasets for global fitting.
- Set a switch parameter which connect all functions.
- Perform global fit with parameter sharing for multiple fitting functions.

#### 4.3.3.5.3 Steps

1. Create a new workbook by clicking the  button.
2. Click the  to import the file **MultiFunctionsFit.dat** in the <Origin EXE Folder>\Samples\Curve Fitting\ folder.
3. Highlight column A, B and C and select the **Analysis: Fitting: Nonlinear Curve Fit** menu item to open the **NLFit** dialog.

The user defined fitting function will be build in next 3 steps, the functions are built based on the quantitative model below :

$$Col(B) : L_1 = \frac{A_1 e^{-t/t_0} + B_1}{A_2 e^{-t/t_0} + B_2}$$

$$Col(C) : L_2 = A_2 e^{-t/t_0} + B_2$$

4. In the **Function Selection** page, choose the <new...> function from the **User Defined** category.
5. Enter "GlobalFit" as the function name, and set the Function Model and Function Type follows the graph below:

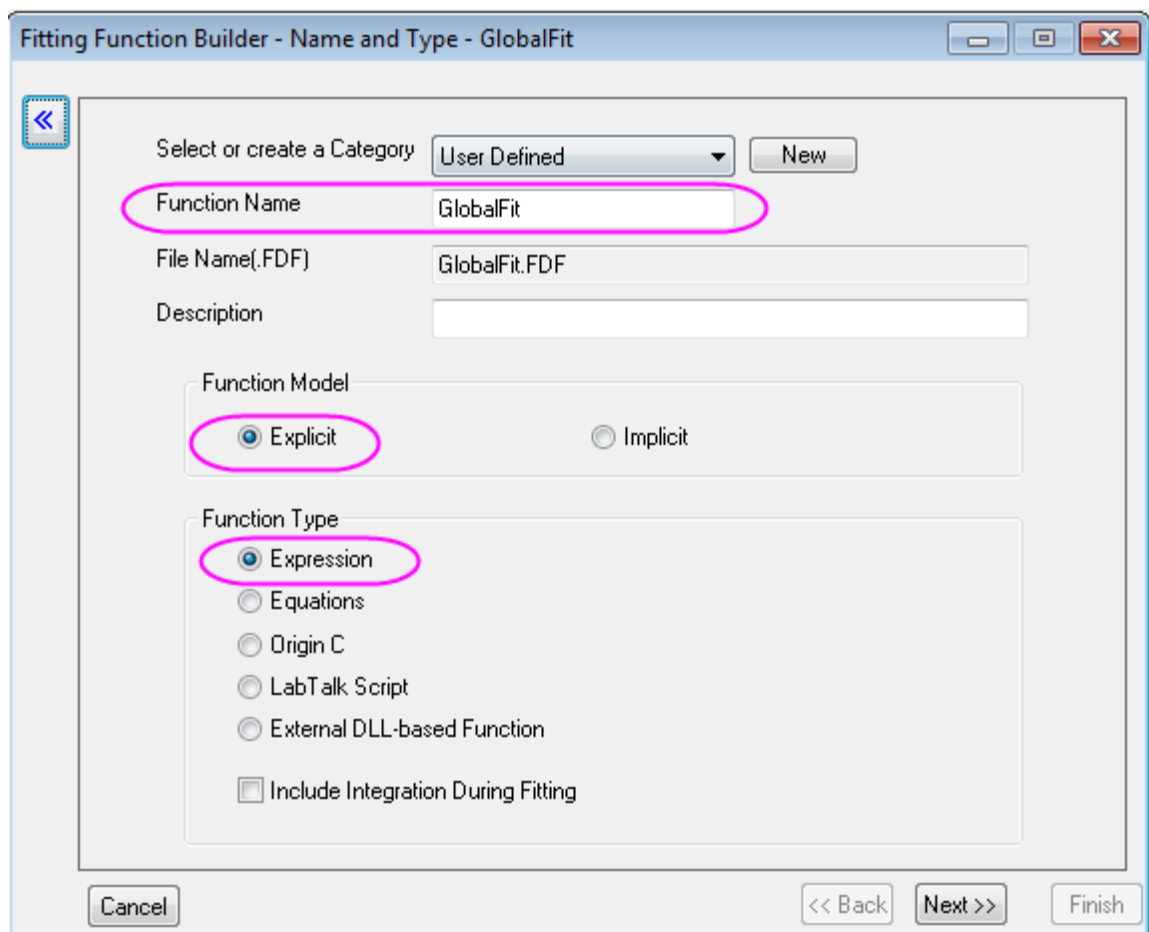

Then, click **Next** to go to the variables and parameters page.

6. Set the variables and parameters follows the graph below:

The screenshot shows a dialog box titled "Fitting Function Builder - Variables and Parameters - GlobalFit". It contains several input fields and a checkbox. The "Independent Variables" field is set to "t", "Dependent Variables" is set to "y", and "Parameters" is set to "A1,B1,A2,B2,t0,s". There are empty fields for "Derived Parameters" and "Constants". A checkbox labeled "Peak Function" is present and is not checked. At the bottom, there are buttons for "Cancel", "<< Back", "Next >>", and "Finish".

Then, click **Next** to go to the Expression Function page.

7. Type the expression which contained formula of  $L_1$  and  $L_2$  in the function body box:

$$s * (A1 * \exp(-t/t0) + B1) / (A2 * \exp(-t/t0) + B2) - (s-1) * (A2 * \exp(-t/t0) + B2)$$

The parameter  $s$  is a switch for global fitting, if  $s=1$ , the  $L_1$  is used for fitting, if  $s=0$ ,  $L_2$  is used for fitting. The value of  $s$  will be controlled in the following fitting procedure. Set the Initial Value of A1 and B1

to 0. Then, click **Finish**.

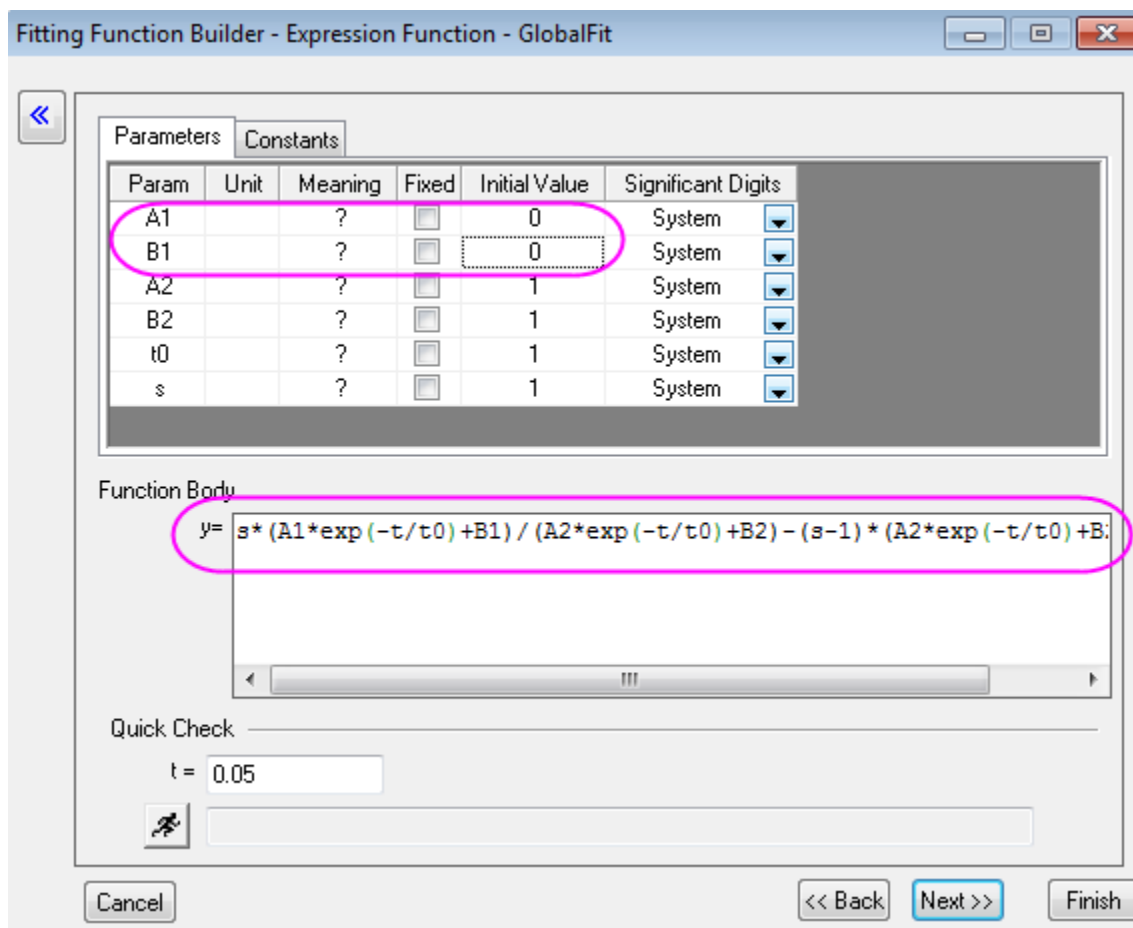

- Back to **NLFit** dialog, select GlobalFit function in User Defined Category. Go to the Data Selection Page, Select Global Fit mode from the Multi-Data Fit Mode drop-down list:

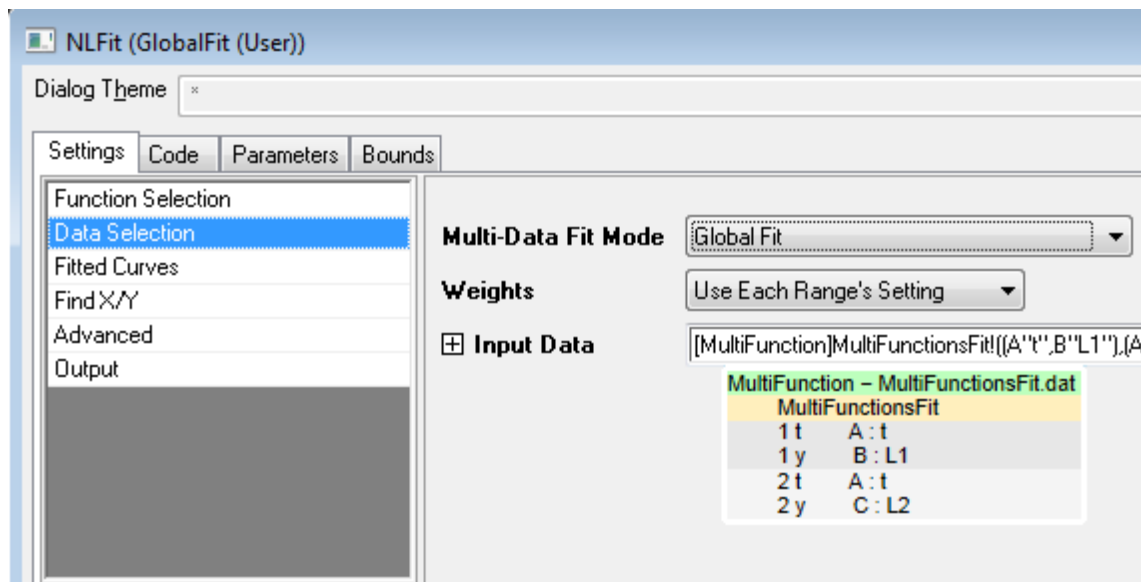

- Go to the **Parameters** tab. Check on the **Share** check box for A2, B2 and t0, then Check on the **Fixed** box for s and s<sub>2</sub> to fix their values to 1 and 0, respectively. The setting of s will control fitting Col(B)

using  $L_1$  while fitting Col(C) using  $L_2$ .

Settings	Code	Parameters	Bounds			
<input checked="" type="checkbox"/> Auto Parameter Initialization						
Double click cells to change operator. Right click cells for more c						
NO.	Param	Meaning	Share	Fixed	Value	Error
1	B1	?	<input type="checkbox"/>	<input type="checkbox"/>	0	--
1	A2	?	<input checked="" type="checkbox"/>	<input type="checkbox"/>	1	--
1	B2	?	<input checked="" type="checkbox"/>	<input type="checkbox"/>	1	--
1	t0	?	<input checked="" type="checkbox"/>	<input type="checkbox"/>	1	--
1	s	?	<input type="checkbox"/>	<input checked="" type="checkbox"/>	1	--
2	A1_2	?	<input type="checkbox"/>	<input type="checkbox"/>	0	--
2	B1_2	?	<input type="checkbox"/>	<input type="checkbox"/>	0	--
2	s_2	?	<input type="checkbox"/>	<input checked="" type="checkbox"/>	0	--

10. Click the **Fit** button to fit curves. You will get these results from the **Parameters** table of the report worksheet:

		Value	Standard Error
L1	A1	2.5887072951	0.1678709978
	B1	0.4959001021	0.0052845018
	A2*	-12.6787277087	0.1035113131
	B2*	8.9810129162	6.5535940841E-4
	t0*	3.3462910396	0.0113070784
	s	1	0
L2	A1	0	0
	B1	0	0
	A2*	-12.6787277087	0.1035113131
	B2*	8.9810129162	6.5535940841E-4
	t0*	3.3462910396	0.0113070784
	s	0	0

share

- The fitted curves will be added to the graph window. You can check the fitted curve for Col(B)/ $L_1$  and Col(C)/ $L_2$  in Sheet **FitNL1** by double clicking the Graphs.

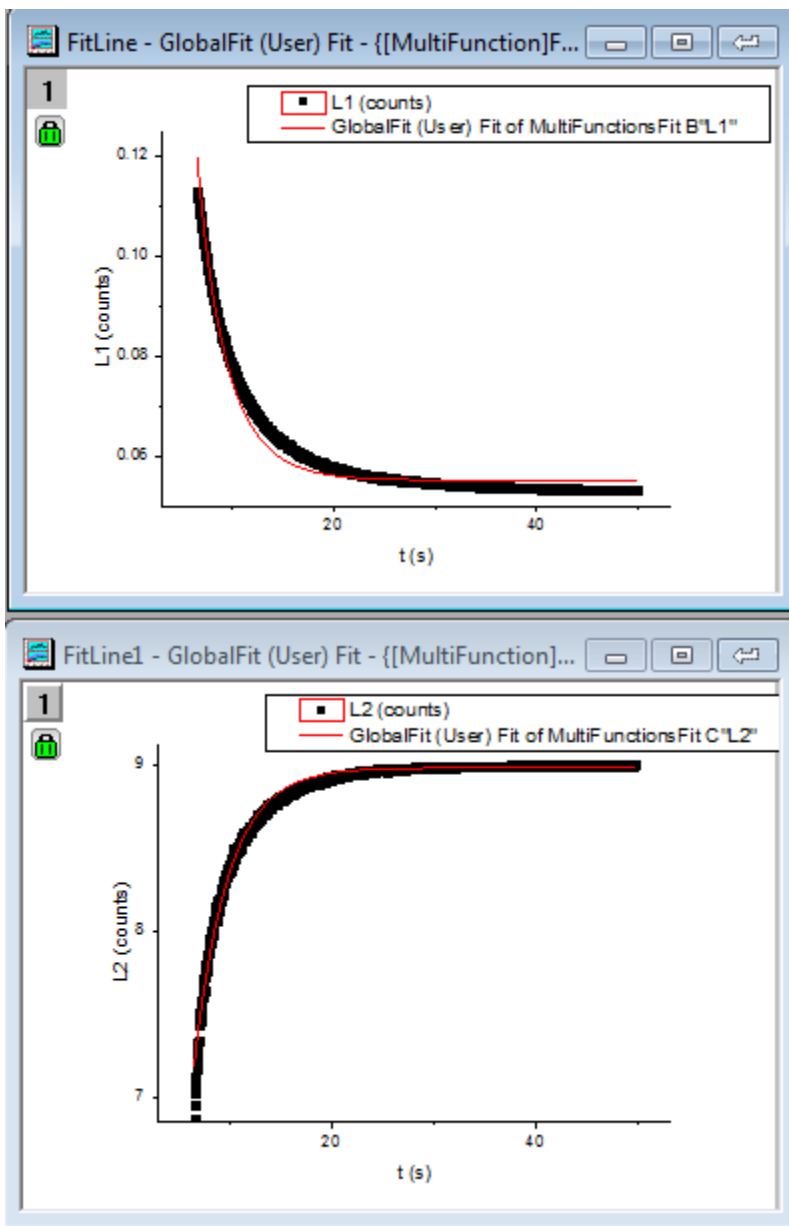

#### 4.3.3.6 Parameters Initialization using LabTalk in NLFit

##### 4.3.3.6.1 Summary

In previous Origin versions, one can only initialize fitting parameters with Origin C code. Since Origin 9.0 SR1, it is also supported to use LabTalk script to initialize parameters. This implement is especially useful when one wants to use worksheet values for the initial parameters.

In this tutorial, three adsorption uptake curves at three different temperatures were measured, and the results are exported in three .txt files. The experimental conditions are stored in the same .txt file as header info. We are going to fit the data to the isothermal-spherical model, according to the following equation:

$$y = 1 - \frac{6}{\pi^2} * \exp\left(-\frac{\pi^2}{T} * x\right)$$

, where y is the normalized mass uptake (mg/g), x is the time span (s), T is the time constant (1/s), and the fitting parameter.

There is an empirical equation describing the relationship between the temperature and time constant, which is:

$$T = 25000 - 58 * Temp$$

For the uptake curve at each temperature, we will calculate T from this equation and use it as the initial value for the curve fitting.

Minimum Origin Version Required: Origin 9.0 SR1

#### 4.3.3.6.2 What you will learn

This tutorial will show you how to:

- Create a user-defined fitting function and use Labtalk script to do parameter initialization.
- Use values in worksheet for initialized parameters.

#### 4.3.3.6.3 Steps

##### Write Parameter Initialization Script for a User-Defined Fitting Function

1. Select **Tools:Fitting Function Builder**(or press **F8**) to open the **Fitting Function Builder**, in the **Goal** page, select **Create a New Function** and click **Next**.
2. In the **Name and Type** page, make sure the function is created under the **User Defined** category, name the function **UptakeCurveFit**, keep the **Function Model** as **Explicit**, and select **Origin C** for **Function Type**. Click the **Next** button.
3. In the **Variables and Parameters** page, keep the **Independent Variables** and **Dependent Variables** as the default **x** and **y**, respectively. Set the **Parameters** to **T** and click **Next**.
4. In the **Origin C Fitting Function** page, type in the following equation in the **Function Body** edit box, and then click **Next**.

```
y = 1 - 6/(pi^2)*exp(-(pi^2/T)*x)
```

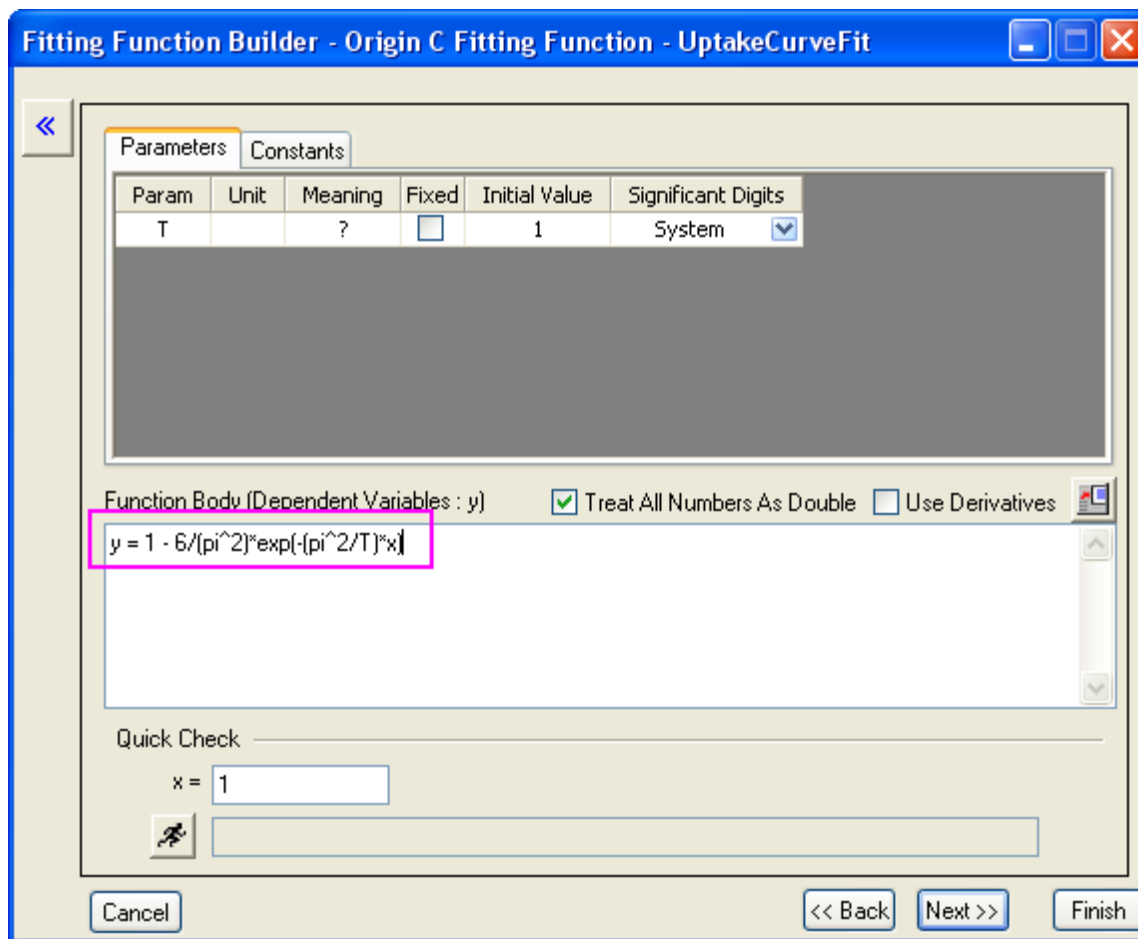

5. In the **Parameter Initialization Code** page, select **Use Custom Code** radio button, and then select the **Use Labtalk** radio button to enable the use of Labtalk script. In the **Initialization Code** edit box, type in the following script:

```
//Code to be executed to initialize parameters

//Get the current worksheet page.

range rpage=ry.getpage();

//Get the data worksheet

range rlayer=ry.getlayer();
```



```

//Get the data worksheet index

int inext=rlayer.index;

//Make sure the data workbook is active

win -a %(ry.getpage()$);

//Make sure the data worksheet is active

page.active=inext;

//Active column 2 in the data worksheet

wks.col=2;

//Get the temperature as a string from column comment

string str1$ = wks.col.comment$;

//Get the string of the temperature number

string str2$ = str1.Left(3)$;

//Substitute the string variable to a double number

double Temp = %(str2$);

//Use the empirical equation to calculate the initial value of T

T=25000 - 58 * Temp;



//Check whether parameter initialization script runs successfully

type -b "Experimental temperature is $(Temp) K, so the initial value of T
is $(T)."
```

**Notes:** The *ry* in the script above is an auto-defined range variable for the input data range of parameter *y*, the syntax for such range variable is *r+parameter name*. For example, if the parameter name is *Temp*, the range variable should be *rTemp*.

- Click **Finish** to create the user defined fitting function **UptakeCurveFit**, you could find its .fdf file in the **User Files Folder**.

**Fit Data with the User Defined Fitting Function**

- Create a new Origin project by clicking the  button on the **Standard** toolbar. Click the  button (or **Data: Import from File: Import Wizard** or press **Ctrl+3**) to open the **Import Wizard**.
- In the **Data Source**, select the **UptakeCurve\_343K.txt** as the **File**, which is located under path `<Origin Folder>\Samples\Curve Fitting\`. Click **Next** button to navigate to the **Header Lines** page. Set the **Long Names**, **Units**, and **Comments** as **3**, **4**, and **1 to 1**, respectively.

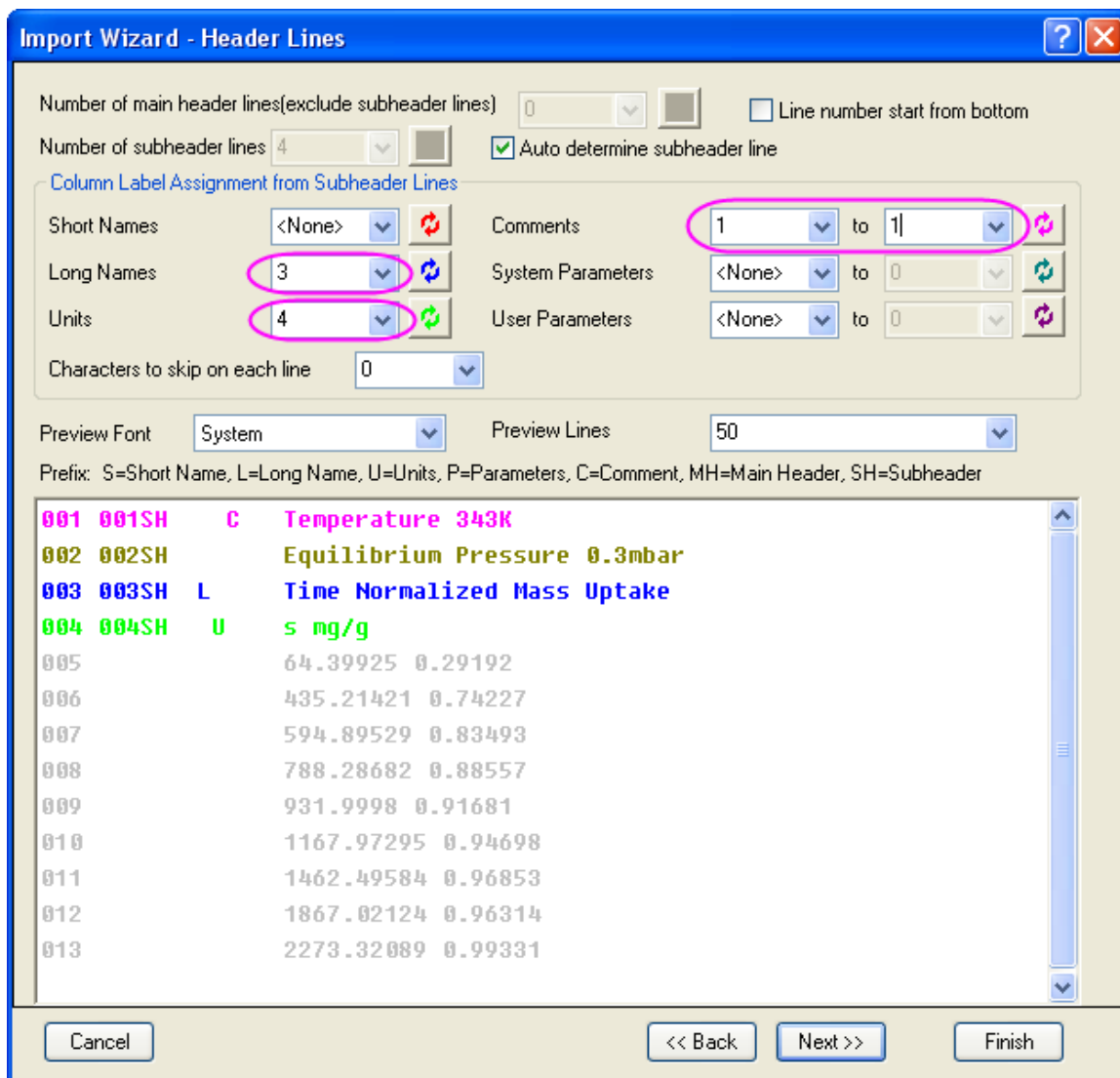

- Click **Finish** to import the data file. Note that the experimental temperature is stored as the comment of column 2, which will be retrieved by the Labtalk script for parameter initialization in the **UptakeCurveFit** fitting function.

	A(X)	B(Y)
Long Name	Time	Normalized Mass Uptake
Units	s	mg/g
Comments	Temperature	343K
Sparklines		
1	64.39925	0.29192
2	435.21421	0.74227
3	594.89529	0.83493
4	788.28682	0.88557
5	931.9998	0.91681
6	1167.97295	0.94698
7	1462.49584	0.96853
8	1867.02124	0.96314
9	2273.32089	0.99331
10		

- Highlight column B and select **Analysis:Fitting:Nonlinear Curve Fit** (or press **Ctrl+Y**) to open the **NLFit** dialog, select **User Defined** for **Category** and **UptakeCurveFit(User)** as **Function**.
- An attention box pops up and shows the experimental temperature and the calculated initial value of time constant.



- Go to the **Parameters** tab, see that the initial parameter for T is 5106, which is calculated from the experimental temperature. This indicates the parameter initialization script is successfully called.
- Go to the **Code** tab and select the **Parameter Init** section, there you could double check the parameter initialization script by clicking the button.
- Click **OK** to close the attention box, and click **Fit** to carry out the fit.

#### Create an Analysis Template and Do Batch Processing

- Go to the report sheet **FitNL1** which is generated from previous steps, click the triangle button right to the **Summary** table and choose **Create Copy as New Sheet**. A new sheet will be created, delete column A in the new sheet and rename it as **Result**.

	B(Y)	C(yEr?)	D(Y)	E(Y)
Long Name	T	T	Statistics	Statistics
Parameters	Value	Standard Error	Reduced Chi-Sqr	Adj. R-Square
1	5034.71487	690.3704	0.00391	0.91875
2				
3				

- Keep the workbook active and select **File:Save Workbook as Analysis Template** to save this workbook as **MyUptakeFit.ogw**.
- Create a new Origin project and select **File:Batch Processing** to open the **batchProcess** dialog.
- Load the analysis template **MyUptakeFit.ogw**, select the files **UptakeCurve\_343K.txt**, **UptakeCurve\_373K.txt**, and **UptakeCurve\_403K.txt** under the *<Origin Folder>\Samples\Curve Fitting\* path, choose **File Name** for **Dataset Identifier** and make sure the other settings are the same according to the image below:

**Batch Processing Mode**

Repeatedly Import into Active Analysis Template Window  
 Load Analysis Template

**Analysis Template**  
 D:\Documents and Settings\originlab\Desktop\MyUptakeFit.ogw

**Data Source**  
 Import From Files

**Use Import Setting in Workbook**

**File List**  
 D:\Program Files\OriginLab\Origin9SR0\Samples\Curve Fitting\UptakeCurve\_403K.txt  
 D:\Program Files\OriginLab\Origin9SR0\Samples\Curve Fitting\UptakeCurve\_343K.txt  
 D:\Program Files\OriginLab\Origin9SR0\Samples\Curve Fitting\UptakeCurve\_373K.txt

**Dataset Identifier**  
 File Name

**Data Sheet**  
 UptakeCurve\_343K

**Result Sheet**  
 Result

Contents from Result Sheet will be appended to the Output Sheet in another book, specified below

**Output Sheet**  
 [Summary]Results!

**Delete Intermediate Workbook**

**Options**

Starting Row of Output Sheet: 1

Clear Output Sheet on Start:

Append Label Rows:

When Output Sheet is Excel, check this box to append labels from Result Sheet

- Click **OK** to carry out the batch processing, for every file being executed, the attention box pops up and indicates the initial value being used, click **OK** every time to close the attention box and continue the batch processing. Finally, a summary report will be created:

	A(Y)	B(Y)	C(yEr?)	D(Y)	E(Y)
Long Name	Dataset	T	T	Statistics	Statistics
Parameters		Value	Standard Error	Reduced Chi-Sqr	Adj. R-Square
1	UptakeCurve_403K.bt	1954.30438	176.04279	3.45543E-4	0.98809
2	UptakeCurve_343K.bt	5034.71487	690.3704	0.00391	0.91875
3	UptakeCurve_373K.bt	2821.73125	210.70923	5.37589E-4	0.98522
4					
5					

#### 4.3.3.7 User Defined Fitting Function

##### 4.3.3.7.1 Summary

Besides the [200+ built-in fitting functions](#), you can also create your own fitting functions in Origin. Origin provides three tools for fitting with user defined function:

- [Simple Fit App](#)

**Simple Fit** App provides a much more convenient way to fit simple functions that can be expressed in the form  $y = f(x)$ , you only need to type your formula, specify the initial values and then generate fitting reports immediately. You can learn how to use this App in the linked File Exchange page.

- [Quick Fit Gadget](#)

Quick Fit gadget is another easy way to do both linear and nonlinear fitting without open the Linear Fit or NLFit dialog which might look a little bit complicated but with many advanced controls. Start a fitting process with this gadget, you need first add your own function into the Function List.

- [NLFit tool](#).

**NLFit** tool is a powerful fitting wizard which allows you to define more complex fitting functions and control the fitting process in every possible way. For fitting user defined function in **NLFit** tool, you will need to create it in [Fitting Function Builder](#) first.

In this tutorial, we will mainly illustrate how to create a user-defined fitting function in **Fitting Function Builder**, carry out nonlinear curve fit with it and also show how to fix a parameter for curve fitting using **NLFit** tool.

Minimum Origin Version Required: Origin 2016 SR0

##### 4.3.3.7.2 What You Will Learn

This tutorial will show you how to:

- Create a user-defined fitting function using the **Fitting Function Builder**.
- Carry out nonlinear curve fit with user-defined fitting function.
- Fix a parameter for nonlinear curve fit.

#### 4.3.3.7.3 Steps

The data we are going to fit is the file **ConcentrationCurve.dat** under the <Origin EXE Folder>\Samples\Curve Fitting\ path.

The fitting function to be created and used is shown below:

$$y = A \exp(2.303kx - k_m) \sqrt{2.303 + \frac{C}{(x - C_0)}}$$

in which

$y$  is the dependent variable

$x$  is the independent variable

and  $A, k_m, k, C, C_0$  are all fitting parameters.

#### Create a Fitting Function

In this section, we will show how to create a user defined fitting function in the **Fitting Function Builder**. But there is an alternative tool **Fitting Function Organizer** which also can be used to create user defined fitting functions (open it by selecting **Tools:Fitting Function Organizer** or pressing **F9**).

1. Launch Origin and choose **Tools:Fitting Function Builder** (or press **F8**) to open the **Fitting Function Builder**.
2. In the **Goal** page, select **Create a New Function** and click **Next**.

3. In the **Name and Type** page, change the setting as the following image and then click **Next**:

The screenshot shows a dialog box titled "Fitting Function Builder - Name and Type - MyFitFunc". It contains the following fields and options:

- Select or create a Category:** A dropdown menu set to "User Defined" and a "New" button.
- Function Name:** A text box containing "MyFitFunc".
- File Name(.FDF):** A text box containing "MyFitFunc.FDF".
- Description:** An empty text box.
- Function Model:** Two radio buttons: "Explicit" (selected) and "Implicit".
- Function Type:** A group of radio buttons: "Expression" (selected), "Equations", "Origin C", "LabTalk Script", and "External DLL-based Function". There is also a checkbox for "Include Integration During Fitting" which is unchecked.

At the bottom of the dialog, there are three buttons: "Cancel", "<< Back", and "Next >>", along with a "Finish" button.

4. In the **Variables and Parameters** page, enter the variable and parameter names as the image below and then click **Next**:

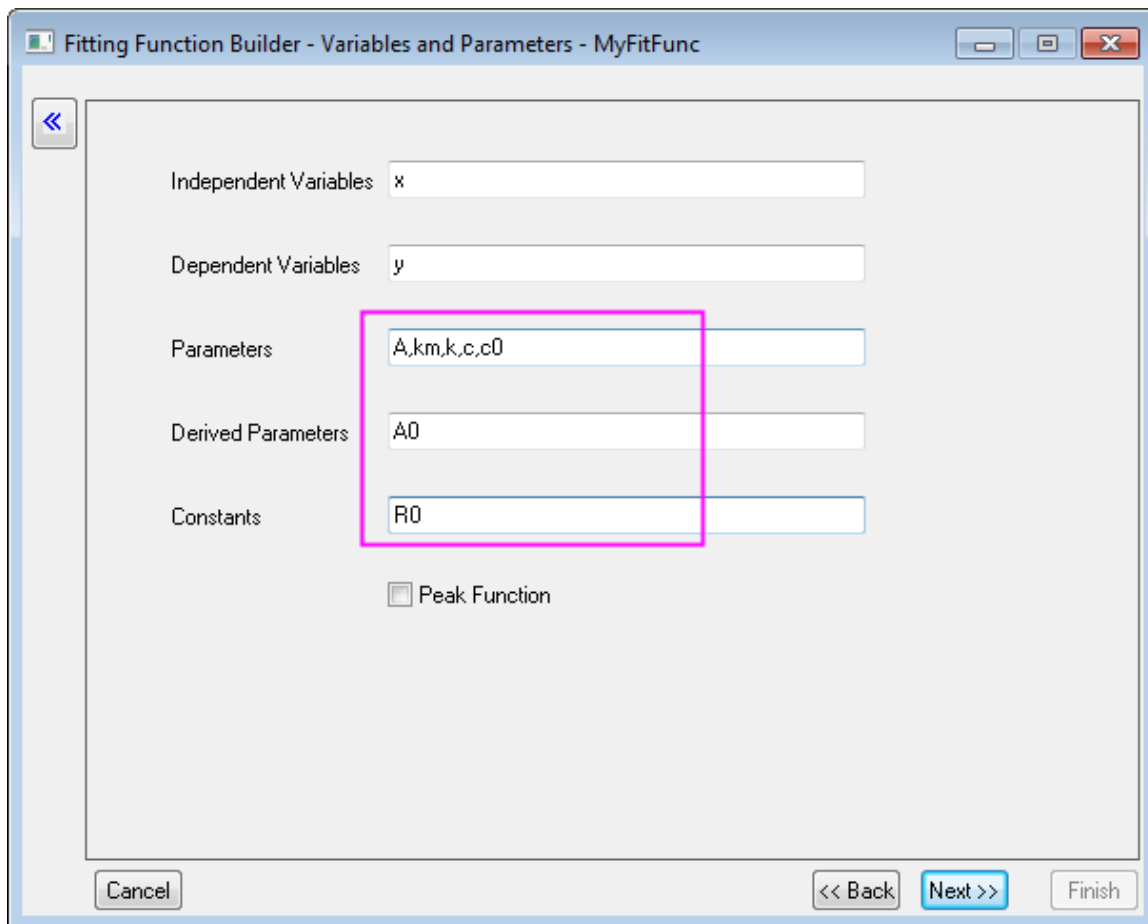

In the **Parameters** box, use comma (",") as delimiter.

- In the **Expression Function** page, enter the equation below in **Function Body**:

$$A * \exp(R0 * k * x - km) * \text{sqrt}(R0 + c / (x - c0))$$

- Go to the **Constant** tab, set the value of **R0** to **2.303**.
- Give estimated initial values to the parameters according to this particular data and function.

Param	Unit	Meaning	Fixed	Initial Value	Significant Digits
A		?	<input type="checkbox"/>	325	System <input type="button" value="v"/>
km		?	<input type="checkbox"/>	10	System <input type="button" value="v"/>
k		?	<input type="checkbox"/>	1	System <input type="button" value="v"/>
c		?	<input type="checkbox"/>	2	System <input type="button" value="v"/>
c0		?	<input type="checkbox"/>	0.1	System <input type="button" value="v"/>

**Note:** You can also give different initial values each time before you actually carry out the fitting.

- Can click the **Evaluate** button  to quick check whether the function is valid (if it is valid, an actual value will be returned for y).



**Note:** If you used **Origin C** as **Function Type** at the beginning, you can also compile the function at this stage to check if there is any error, this is especially useful for brackets matching.

9. Click the **Next** button three times until it goes to **Derived Parameters** page.
10. In this page, we will define the derived parameter **A0**, enter its equation in the **Derived Parameters Equations** box:

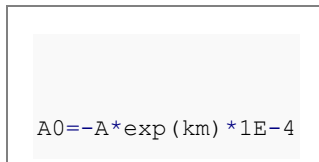



$$A0 = -A * \exp(km) * 1E-4$$

11. Click **Finish** to create this user defined fitting function. The .FDF file for it will be stored in the **User Files Folder**.



You can always modify the user defined fitting function later, either in the **Fitting Function Builder** (choose **Edit a User-defined Function** in **Goal** page), or in the **Fitting Function Organizer**.

#### Carry Out Curve Fitting

1. Create a new workbook. Click the  button to import the **ConcentrationCurve.dat** file under *<Origin EXE Folder>\Samples\Curve Fitting\* path.
2. Highlight column B and click the  button to generate a scatter plot.
3. Keep the graph activated, select **Analysis:Fitting:Nonlinear Curve Fit** to open the **NLFit** dialog.
4. In the **Function Selection** page, set **Category** as **User Defined** and then set **Function** as **MyFitFunc(User)**.
5. Click the  button to fit the data.
6. An error message returns in the **Message** tab of the lower panel, indicates the fit did not converge because of overparameterization.

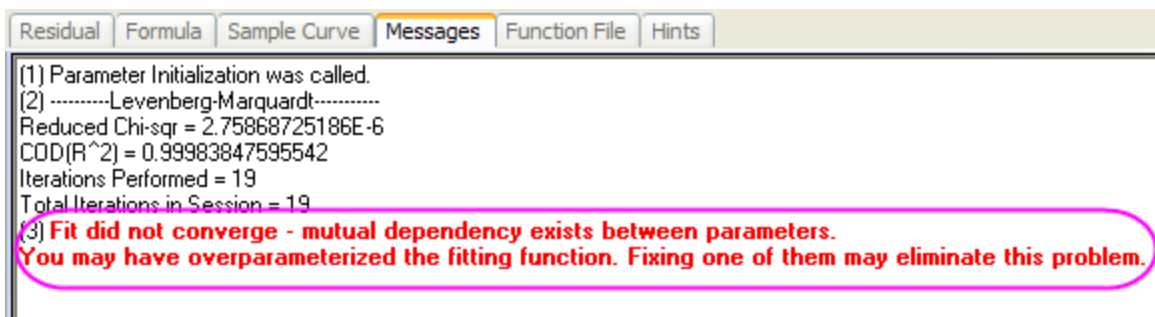

7. The parameters **A** and **km** have mutual dependence, so fixing either one will solve the problem. We will fix **A** this time.

- Go to the **Parameters** tab, click the  to restore the initial value setting, check the **Fixed** box of parameter **A**:

Settings Code **Parameters** Bounds

Auto Parameter Initialization

Double click cells to change operator. Right click cells for more options. Drag column header to change column orders.

NO.	Param	Meaning	Fixed	Value	Error	Dependenc	Lower Conf Limi	Upper Conf Lim	Significant Digits
1	A	?	<input checked="" type="checkbox"/>	325	--	--	--	--	System <input type="button" value="v"/>
1	km	?	<input type="checkbox"/>	10	--	--	--	--	System <input type="button" value="v"/>
1	k	?	<input type="checkbox"/>	1	--	--	--	--	System <input type="button" value="v"/>
1	c	?	<input type="checkbox"/>	2	--	--	--	--	System <input type="button" value="v"/>
1	c0	?	<input type="checkbox"/>	0.1	--	--	--	--	System <input type="button" value="v"/>

- Click the **Fit** button to carry out the fit.
- The fitted curve will be added to the original data plot,

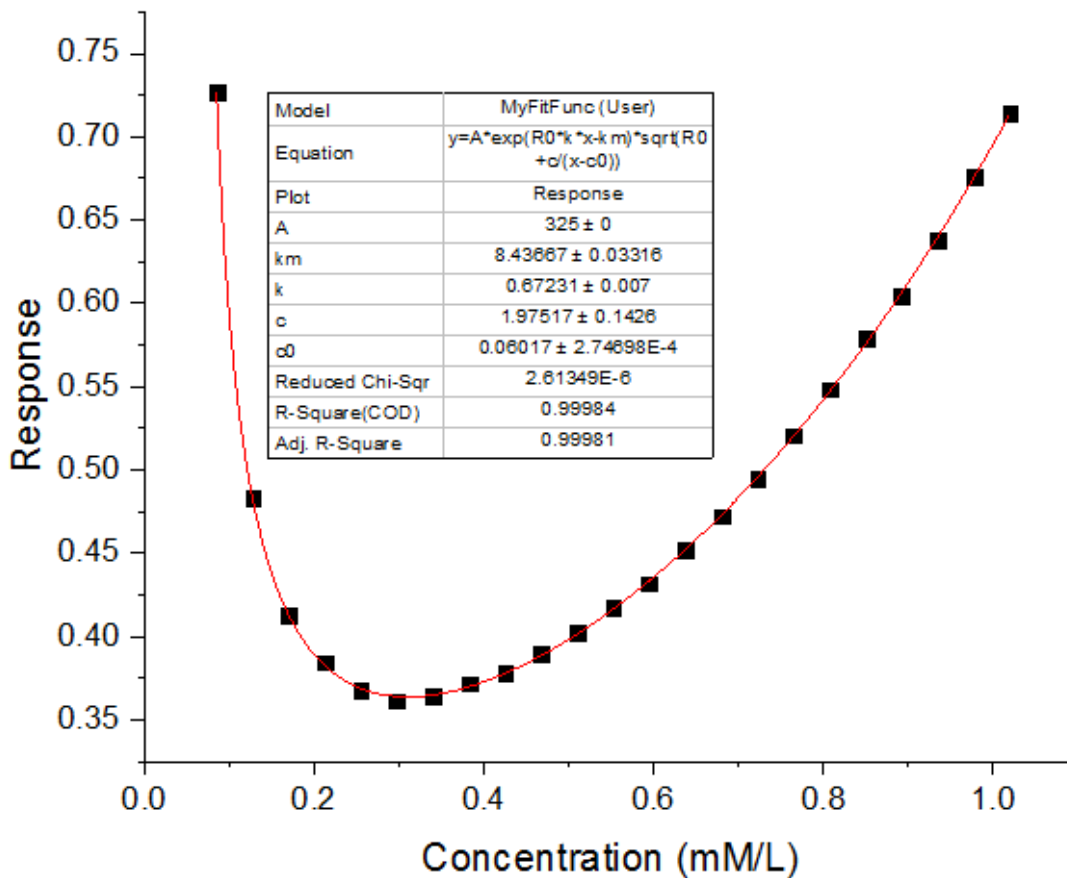

11. A report sheet will be generated as well, in which the fitted value of all parameters(including the derived parameter A0) are reported in the parameters table:

Parameters

		Value	Standard Error	t-Value	Prob> t	Dependency
Response	A	325	0	--	--	0
	km	8.43667	0.03316	254.39421	5.00288E-35	0.99957
	k	0.67231	0.007	96.01794	5.39792E-27	0.99646
	c	1.97517	0.1426	13.85121	2.21628E-11	0.9992
	c0	0.06017	2.74698E-4	219.03971	8.58066E-34	0.84502
	A0	-149.92769	4.97217			

Reduced Chi-sqr = 2.61349318598E-6  
 COD(R<sup>2</sup>) = 0.99983847595542  
 Iterations Performed = 27  
 Total Iterations in Session = 27  
 Fit converged. Chi-Sqr tolerance value of 1E-9 was reached.  
 Some parameter values were fixed.  
 Standard Error was scaled with square root of reduced Chi-Sqr.  
 A0 are derived parameter(s).  
 Constants : R0=2.303



In the case of overparameterization, you can fix different parameters to get multiple fit results and then compare the fit models statistically by **Analysis:Fitting:Compare Models** tool.

#### 4.3.3.8 Fit Surface with User Defined Function

##### 4.3.3.8.1 Summary

Origin provides a [NonLinear Surface Fit tool](#) to fit surface. Besides the [built-in surface fitting functions](#), you can also create your own fitting functions in [Fitting Function Builder](#).

In this tutorial, we will illustrate how to create a user-defined surface fitting function in **Fitting Function Builder**, and carry out nonlinear surface fit with it using **NLFit** tool.

Minimum Origin Version Required: Origin 2016 SR0

##### 4.3.3.8.2 What You Will Learn

This tutorial will show you how to:

- Create a user-defined surface fitting function using the **Fitting Function Builder**.
- Carry out nonlinear surface fit with user-defined fitting function.

##### 4.3.3.8.3 Steps

The data we are going to fit is the file **PolynomialSurface.dat** under the <Origin EXE Folder>\Samples\Curve Fitting\ path.

The fitting function to be created and used is shown below:

$$z = z_0 + A_1x + A_3x^3 + B_1y + B_3y^3 + Cxy + C_2x^2y + C_3xy^2$$

in which

$z$  is the dependent variable

$x$  and  $y$  are the independent variables

and  $z_0, A_1, A_3, B_1, B_3, C, C_2, C_3$  are all fitting parameters.

#### Create a Surface Fitting Function

In this section, we will show how to create a user defined surface fitting function in the **Fitting Function Builder**. But there is an alternative tool **Fitting Function Organizer** which also can be used to create user defined surface fitting functions (open it by selecting **Tools:Fitting Function Organizer** or pressing **F9**).

1. Launch Origin and choose **Tools:Fitting Function Builder** (or press **F8**) to open the **Fitting Function Builder**.
2. In the **Goal** page, select **Create a New Function** and click **Next**.
3. In the **Name and Type** page, select Surface Fitting from **Select or create a Category** drop-down list since **Nonlinear Surface Fit** tool lanches functions in the **Surface Fitting** category only.
4. Enter a name "MyPolynomialSurface" in **Function Name** and select **Expression** for **Function Type**. Click **Next**.

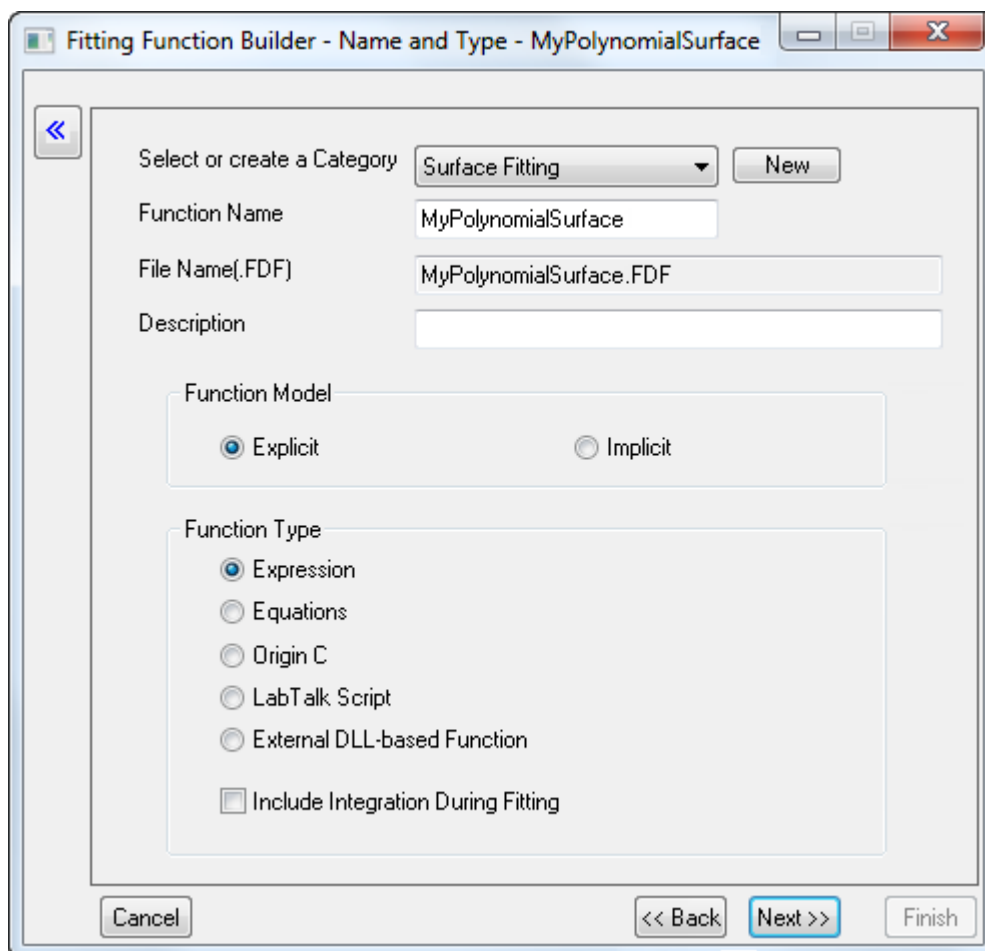

5. In the **Variables and Parameters** page, enter the variable and parameter names as the image below and then click **Next**:

The screenshot shows a dialog box titled "Fitting Function Builder - Variables and Parameters - MypolynomialSurface". It has a back arrow button on the left. The main area contains several input fields: "Independent Variables" with the text "x,y", "Dependent Variables" with "z", and "Parameters" with "z0,A1,A3,B1,B3,C,C2,C3". These three fields are enclosed in a pink rectangular box. Below these are "Derived Parameters" and "Constants" fields, both empty. There is a checkbox labeled "Peak Function" which is currently unchecked. At the bottom of the dialog are four buttons: "Cancel", "<< Back", "Next >>" (highlighted in blue), and "Finish".

In the **Parameters** box, use comma (",") as delimiter.

6. In the **Expression Function** page, enter the equation below in **Function Body**:

$$z0+A1*x+A3*x^3+B1*y+B3*y^3+C*x*y+C2*x^2*y+C3*x*y^2$$

- Give estimated initial values to the parameters according to this particular data and function.

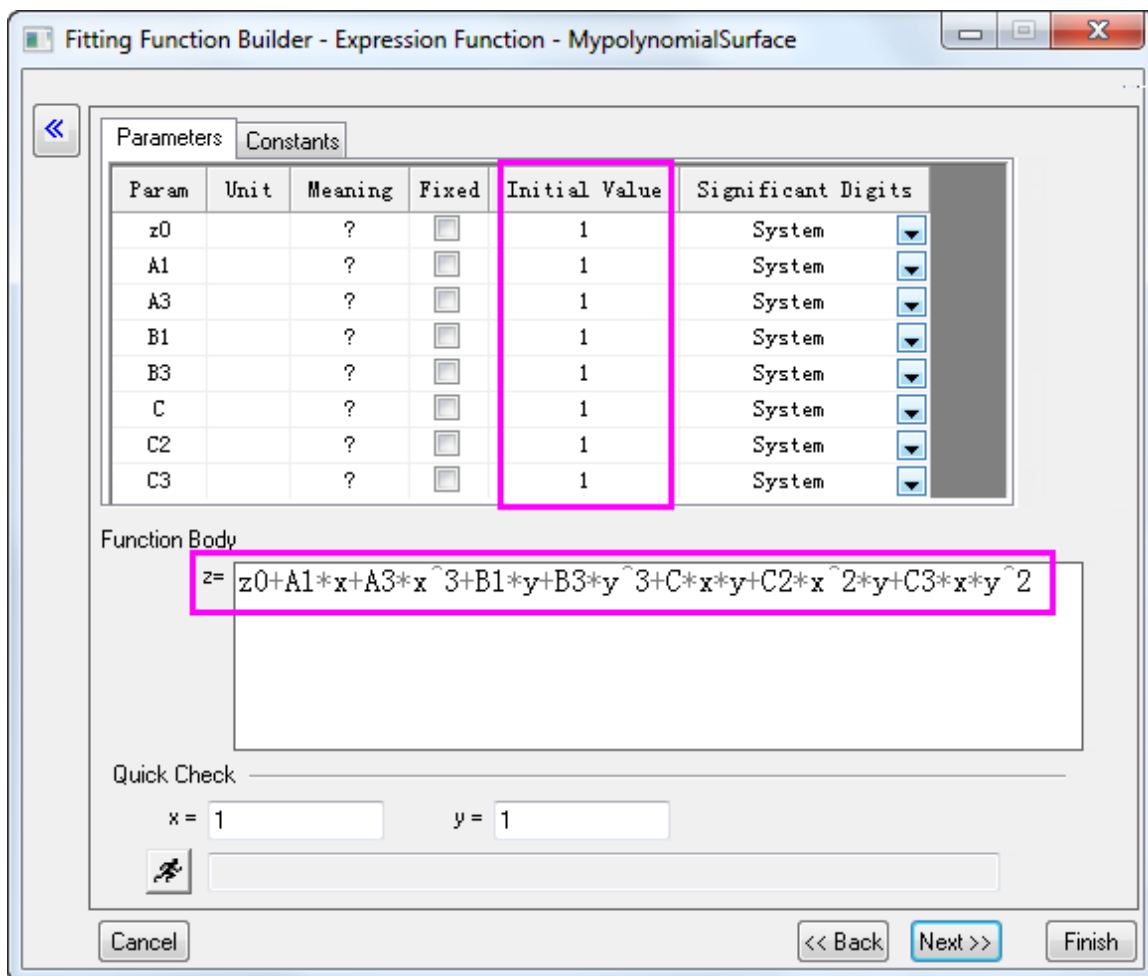

- You can also give different initial values each time before you actually carry out the fitting.
- You Can click the **Evaluate** button  to quick check whether the function is valid(if it is valid, an actual value will be returned for z).

- Click **Finish** to create this user defined fitting function. The .FDF file for it will be stored in the **User Files Folder**.



You can always modify the user defined fitting function later, either in the **Fitting Function Builder**(choose **Edit a User-defined Function** in **Goal** page), or in the **Fitting Function Organizer**.

**Carry Out Surface Fitting**

1. Create a new workbook. Click the  button to import the **PolynomialSurface.dat** file under <Origin EXE Folder>\Samples\Curve Fitting\ path.
2. Right click column C and select **Set As: Z**.
3. Keep the worksheet activated, select **Analysis:Fitting:Nonlinear Surface Fit** to open the **NLFit** dialog.
4. In the **Function Selection** page, you can see that **Category** is read only and set as **Surface**. Set **Function** as **MyPolynomialSurface(User)**.
5. Click the **Fit** button to carry out the fit.
6. A report sheet will be generated, in which the fitted value of all parameters are reported in the parameters table. A FitSurfaceCurve worksheet is added to the source workbook as well, in which the data of fitted surface is stored.

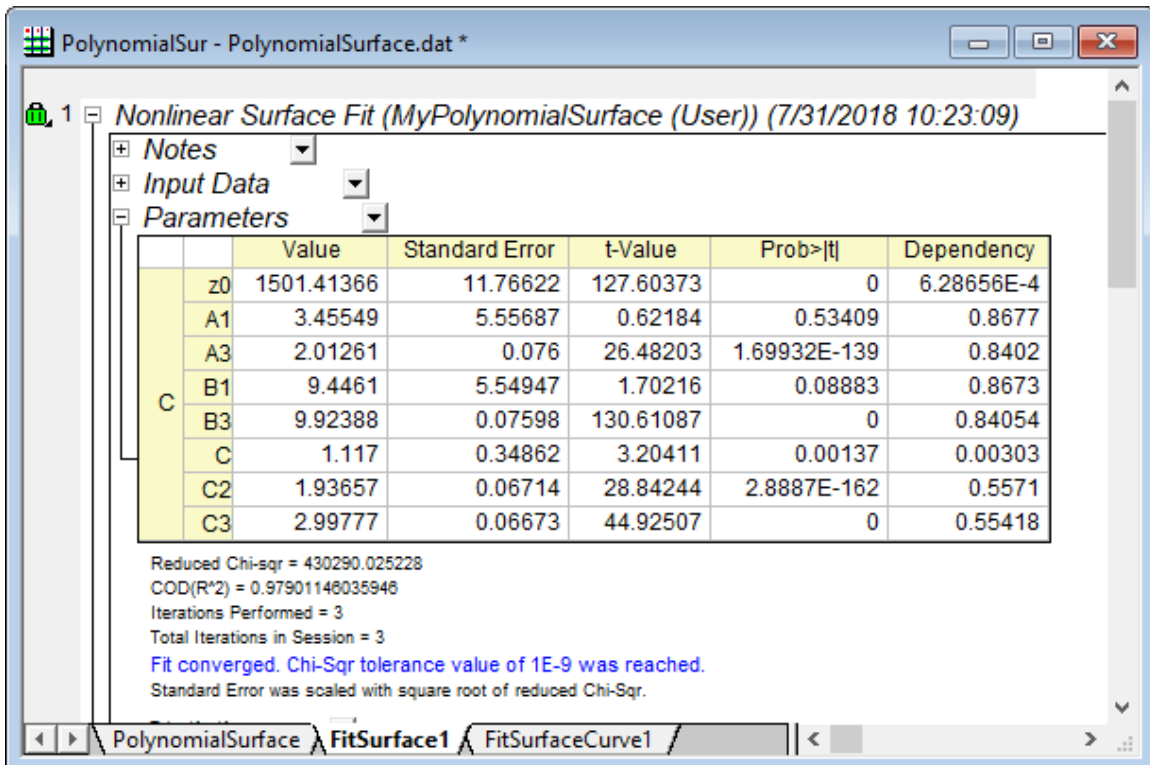

	Value	Standard Error	t-Value	Prob> t	Dependency
z0	1501.41366	11.76622	127.60373	0	6.28656E-4
A1	3.45549	5.55687	0.62184	0.53409	0.8677
A3	2.01261	0.076	26.48203	1.69932E-139	0.8402
B1	9.4461	5.54947	1.70216	0.08883	0.8673
B3	9.92388	0.07598	130.61087	0	0.84054
C	1.117	0.34862	3.20411	0.00137	0.00303
C2	1.93657	0.06714	28.84244	2.8887E-162	0.5571
C3	2.99777	0.06673	44.92507	0	0.55418

Reduced Chi-sqr = 430290.025228  
COD(R<sup>2</sup>) = 0.97901148035946  
Iterations Performed = 3  
Total Iterations in Session = 3  
Fit converged. Chi-Sqr tolerance value of 1E-9 was reached.  
Standard Error was scaled with square root of reduced Chi-Sqr.

7. Activate the source worksheet and highlight col(C). Click the  button to generate a 3D scatter plot. To add the fitted surface to the source data, double click on the Layer 1 icon. In the **Layer Contents** dialog that opens, set the drop-down list in the upper-left corner to **Worksheets in Folder**. Select **FitZ** of FitSurfaceCurve1 worksheet in the panel below the drop-down, then click the downward-pointing arrow in the middle of the dialog and change the plot type to **3D - Surface**. Click on the rightward pointing arrow just below it to add the dataset to the right panel.

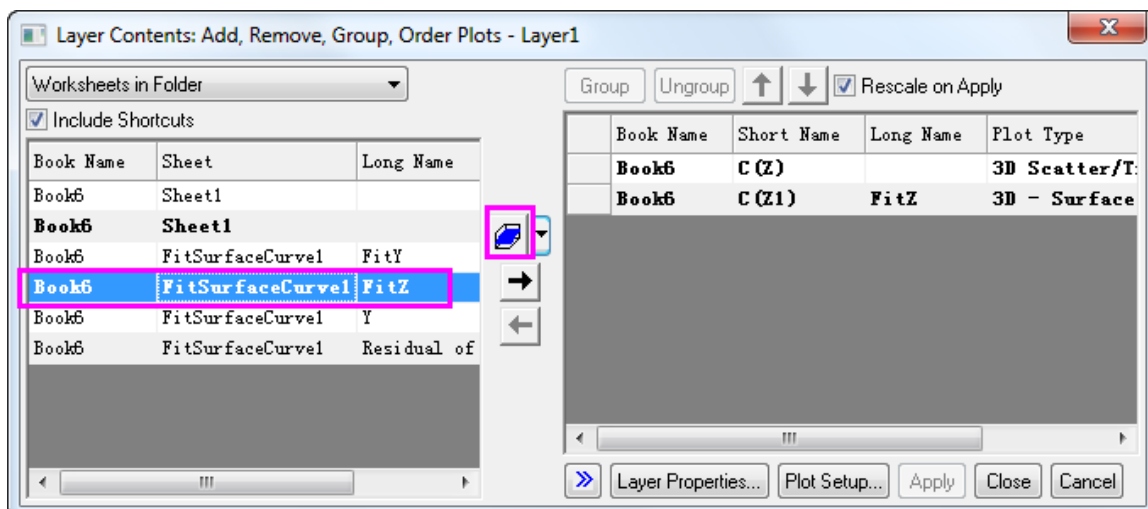

Click **OK** to add the surface to the source data graph.

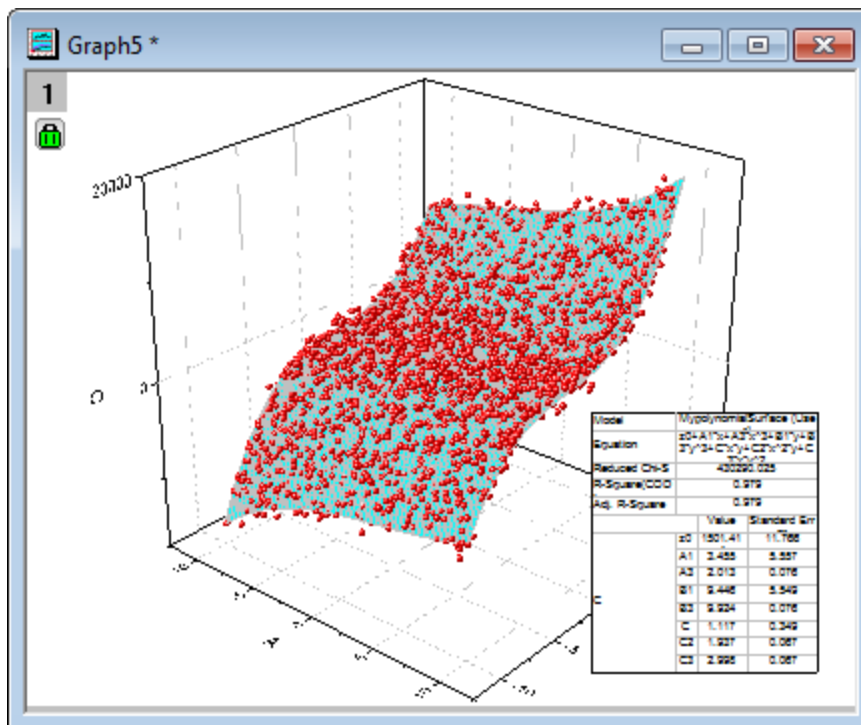

**Note:**

A [Polynomial Surface Fit App](#) is available for Origin 2016 and higher. If you want to fit a polynomial surface, it is recommended to try this App first.

4.3.3.9 Fitting One Dataset as a Function of Other Datasets

4.3.3.9.1 Summary



Sometimes, one may want to perform "Dataset Fitting", that is, the output may be composed of one or several datasets, like:

$$\text{Output} = A_1 * \text{Dataset}_1 + A_2 * \text{Dataset}_2$$

For example, you may want to analyze a composite spectrum to find the contributions/ratio from individual component spectra. This can be accomplished either by defining multiple independent variables or by calculating the "combination" inside the fitting function.

Minimum Origin Version Required: Origin 8.0 SR6

#### 4.3.3.9.2 What you will learn

This tutorial will show you how to:

- Perform "Dataset Fitting"
- Define multiple independent variable fitting function

#### 4.3.3.9.3 Steps

Import the *Composite Spectrum.dat* file from the `\Samples\Curve Fitting\` folder. In this sample data, we can see that column A is the index, columns B and C are the values for the spectrum of components A and B. Column D contains values obtained after reading a composite spectrum of components A and B. By fitting column D to an equation determined by the component spectra of the pure forms of columns B and C, the coefficients for the contributions of B and C (call them c1 and c2 respectively) can be found. (Note: In this case, we supposed the independent and dependent variables have the same size. If not, interpolation is need.)

Bring up the **Fitting Function Organizer** and define a new fitting function as follow:

<b>Function Name:</b>	MultiIndep
<b>Function Type:</b>	User-Defined
<b>Independent Variables:</b>	a, b
<b>Dependent Variables:</b>	ab
<b>Parameter Names:</b>	C1, C2
<b>Function Form:</b>	Origin C
<b>Function:</b>	$ab = C1*a + C2*b;$

Initialize both C1 and C2 to 1 in the **Parameter Initialization** edit box by entering:

C1=1;

C2=1;

Save the fitting function and close **Fitting Function Organizer**. Highlight **ONLY** Column D and bring up the **NLFit** dialog, specify the input datasets in the **Data Selection** page as follow:

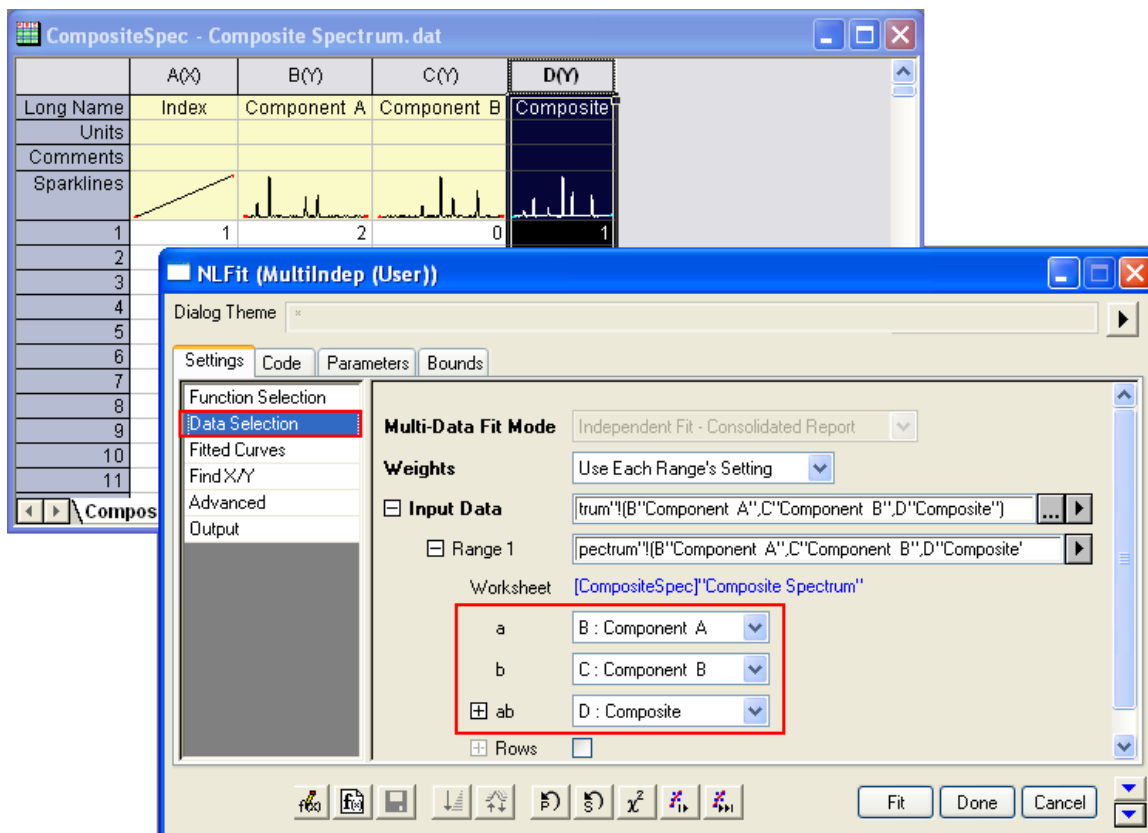

Then you can click the **Fit** button to generate results.

#### 4.3.3.9.4 Results

You are supposed to get these results:

	Value	Standard Error
<b>C1</b>	0.37169	0.00483
<b>C2</b>	0.66469	0.0047

To verify the fitted results, you can add a new column and Copy + Paste the fitted value, which comes from the fitted Y (col(C)) in the worksheet *FitNLCurve1*, into it. Then Highlight the *Composite* and the fitted data and plot a line graph to see how good the fit is:

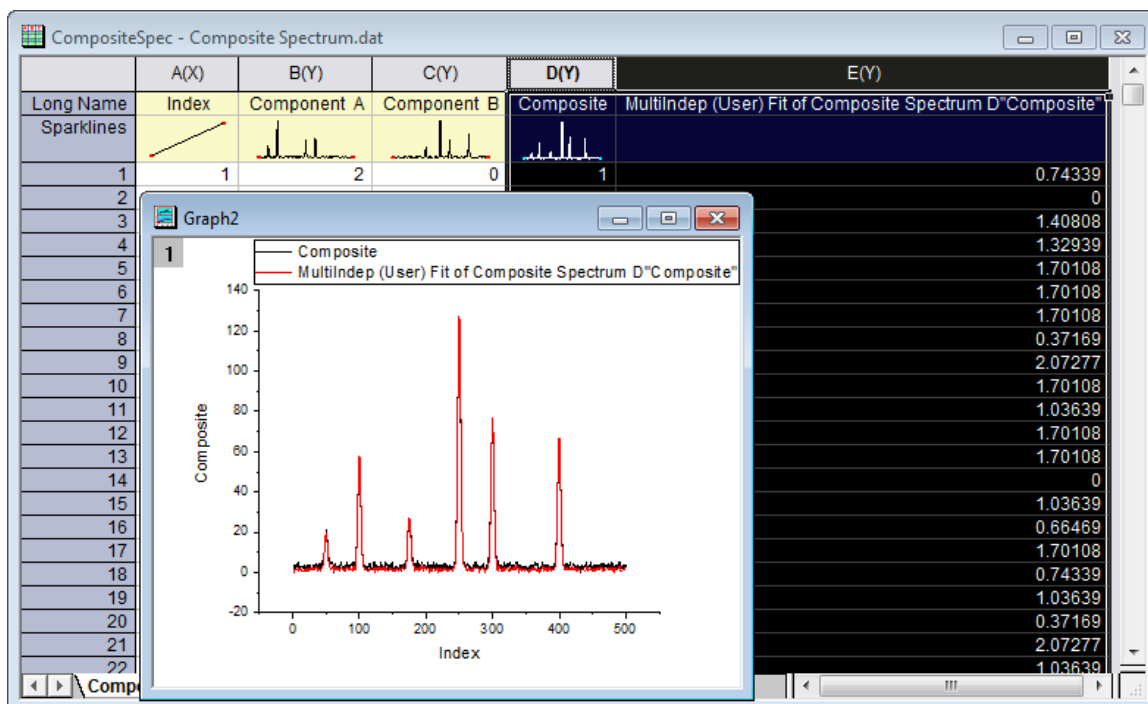

#### 4.3.3.10 Fitting With Multiple Independent Variables

##### 4.3.3.10.1 Summary

The **Function Organizer** tool can be used to create user-defined functions with more than one independent or dependent variable. The **NLFit dialog** can then be used to fit with such functions. The preview window in the NLFit dialog is capable of plotting only one quantity versus another. However, even if the preview does not "make sense", the fitting process will correctly proceed, once proper data and parameter assignments have been made.

Note that if you wish to fit multiple independent variables with an equation of the type  $y = A_0 + A_1 * x_1 + A_2 * x_2 + \dots$  you can make use of the Multiple Regression tool instead of the nonlinear fitter dialog.

Minimum Origin Version Required: Origin 8.0 SR6

##### 4.3.3.10.2 What you will learn

This tutorial will show you how to:

- Create a user-defined fitting function with two independent variables and one dependent variable
- Fit with that function in NLFit

##### 4.3.3.10.3 Steps

1. Start with a new workbook and import the file `\Samples\Curve Fitting\Activity.dat`.
2. Select **Tools: Fitting Function Organizer** from menu (or press **F9**) to bring up the **Fitting Function Organizer** and define a new fitting function named **MultiIndep** in **NewCategory** (create the category if it does not exist) as follow:

<b>Function Name:</b>	MultiIndep
<b>Function Type:</b>	User-Defined
<b>Independent Variables:</b>	substr,inhib
<b>Dependent Variables:</b>	act
<b>Parameter Names:</b>	ki,km,vm
<b>Function Form:</b>	Origin C
<b>Function:</b>	<pre>double mix = inhib / ki; act = vm * substr / (km + (1 + mix) * substr);</pre>

3. **NOTE:** Since we are using OriginC, case must match between defined names and their use in the function definition. e.g. Substr does NOT equal substr.
4. Click Save and then OK to save the function and close the Organizer.
5. For more details about User Defined Fitting Function please refer to [User Defined Fitting Function using Origin C](#).
6. Highlight **ONLY** column C and select **Analysis: Fitting: Non-linear Curve Fit** from menu to bring up the NLFit dialog. Select the function **MultiIndep** from **NewCategory** on the **Settings: Function Selection**

page. Set the input datasets in the **Data Selection** page as follow:

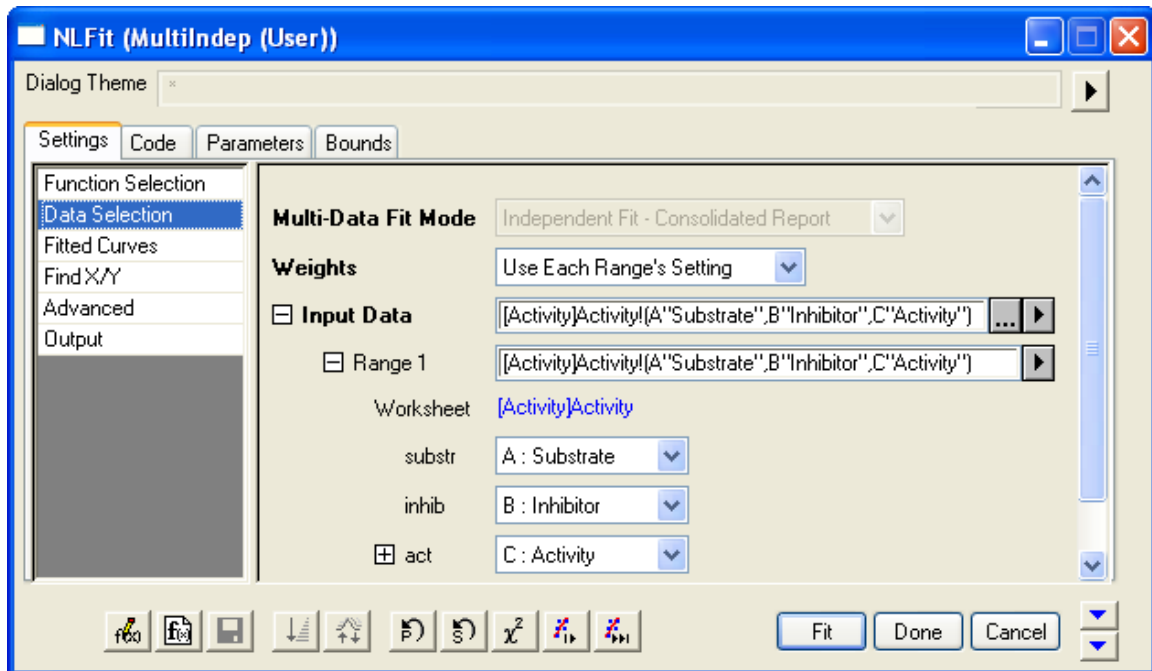

7. Select the **Fitted Curves** page and expand the **Fitted Curves Plot** branch. Then select **Same as Input Data** from the drop-down list next to the **X Data Type** branch.

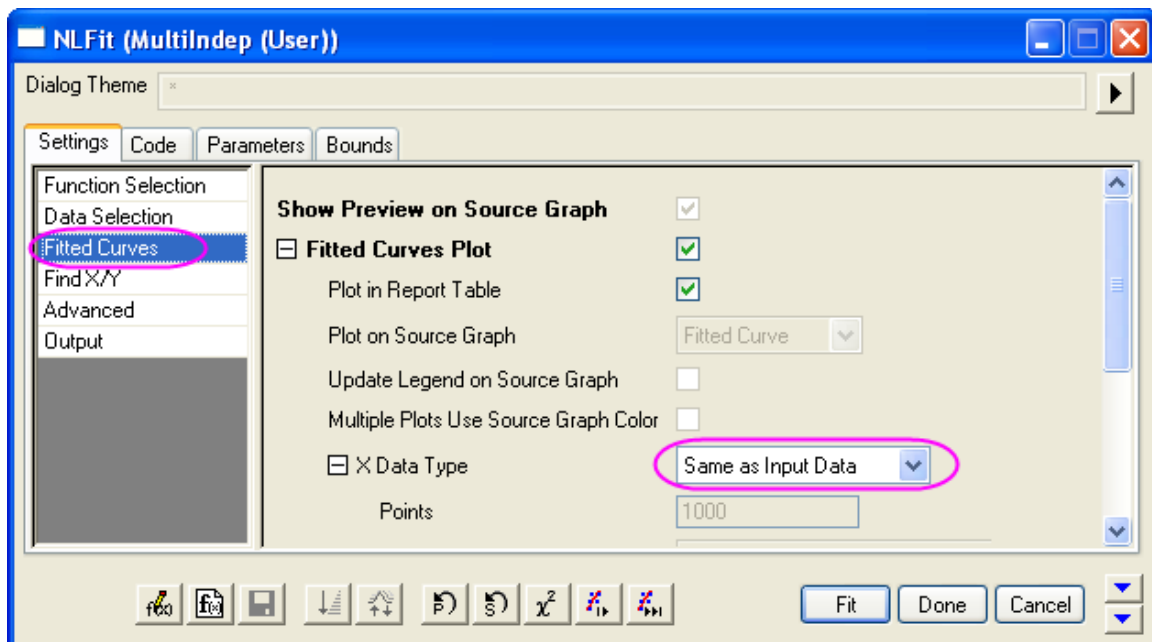

8. Select **Parameters Tab** and set the initial values as follow:

Settings	Code	Parameters	Bounds	
Automatic Parameter Initialization is enabled.				
Param	Meaning	Fixed	Value	Error
ki	?	<input type="checkbox"/>	0.01	--
km	?	<input type="checkbox"/>	1	--
vm	?	<input type="checkbox"/>	100	--

9. Click **Fit** button to generate the fitting reports. You can see these results from the report worksheet as below:

*Parameters*

		Value	Standard Error
Activity	ki	0.0373	0.00233
	km	7.30567	0.71748
	vm	653.1116	22.39698

*Statistics*

	Activity
Number of Points	18
Degrees of Freedom	15
Reduced Chi-Sqr	155.36102
Residual Sum of Squares	2330.41531
Adj. R-Square	0.98357
Fit Status	Succeeded(100)

From the Statistics table we can know that the fitting is fairly successful.

4.3.3.11 User Defined Fitting Function using GNU Scientific Library

This article demonstrates how to use GSL function as fit function.

Minimum Origin Version Required: Origin 8.0 SR6

1. We will fit the sample Data below by the following model:

$$y = y_0 + a \int_0^x e^{\beta \cdot t} dt$$

- 0.1 0.10517
- 0.2 0.2214
- 0.3 0.34986
- 0.4 0.49182
- 0.5 0.64872
- 0.6 0.82212
- 0.7 1.01375
- 0.8 1.22554

0.9	1.4596
1	1.71828
1.1	2.00417
1.2	2.32012
1.3	2.6693
1.4	3.0552
1.5	3.48169
1.6	3.95303
1.7	4.47395
1.8	5.04965
1.9	5.68589
2	6.38906
2.1	7.16617
2.2	8.02501
2.3	8.97418
2.4	10.02318
2.5	11.18249
2.6	12.46374
2.7	13.87973
2.8	15.44465
2.9	17.17415
3	19.08554
3.1	21.19795
3.2	23.53253

2. Add the file `ocgsl.h` in **(User Files folder)**, before next step, make sure the `gsl` dlls are copied to this same location, see [Calling GNU Scientific Library](#).

#### **ocgsl.h**

```
#pragma dll(libgsl, header)

// this is OC special pragma,

// header keyword is to indicate libgsl.dll is in same location as this file
```

```
#define GSL_EXPORT // for OC, this is not needed, so make it empty

// you can directly search and copy gsl function prototypes here

typedef double (* FUNC)(double x, void * params);

struct gsl_function_struct
{
    FUNC function;
    void * params;
};

typedef struct gsl_function_struct gsl_function ;

typedef struct
{
    size_t limit;
    size_t size;
    size_t nrmax;
    size_t i;
    size_t maximum_level;
    double *alist;
}
```



```
double *blist;

double *rlist;

double *elist;

size_t *order;

size_t *level;

}

gsl_integration_workspace;

GSL_EXPORT gsl_integration_workspace *gsl_integration_workspace_alloc (const size_t
n);

GSL_EXPORT void gsl_integration_workspace_free (gsl_integration_workspace * w);

GSL_EXPORT int gsl_integration_qag (const gsl_function * f,

double a, double b,

double epsabs, double epsrel, size_t limit,

int key,

gsl_integration_workspace * workspace,

double *result, double *abserr);
```

3. Press F9 to open the **Fitting Function Organizer** and then add a new function as follows:

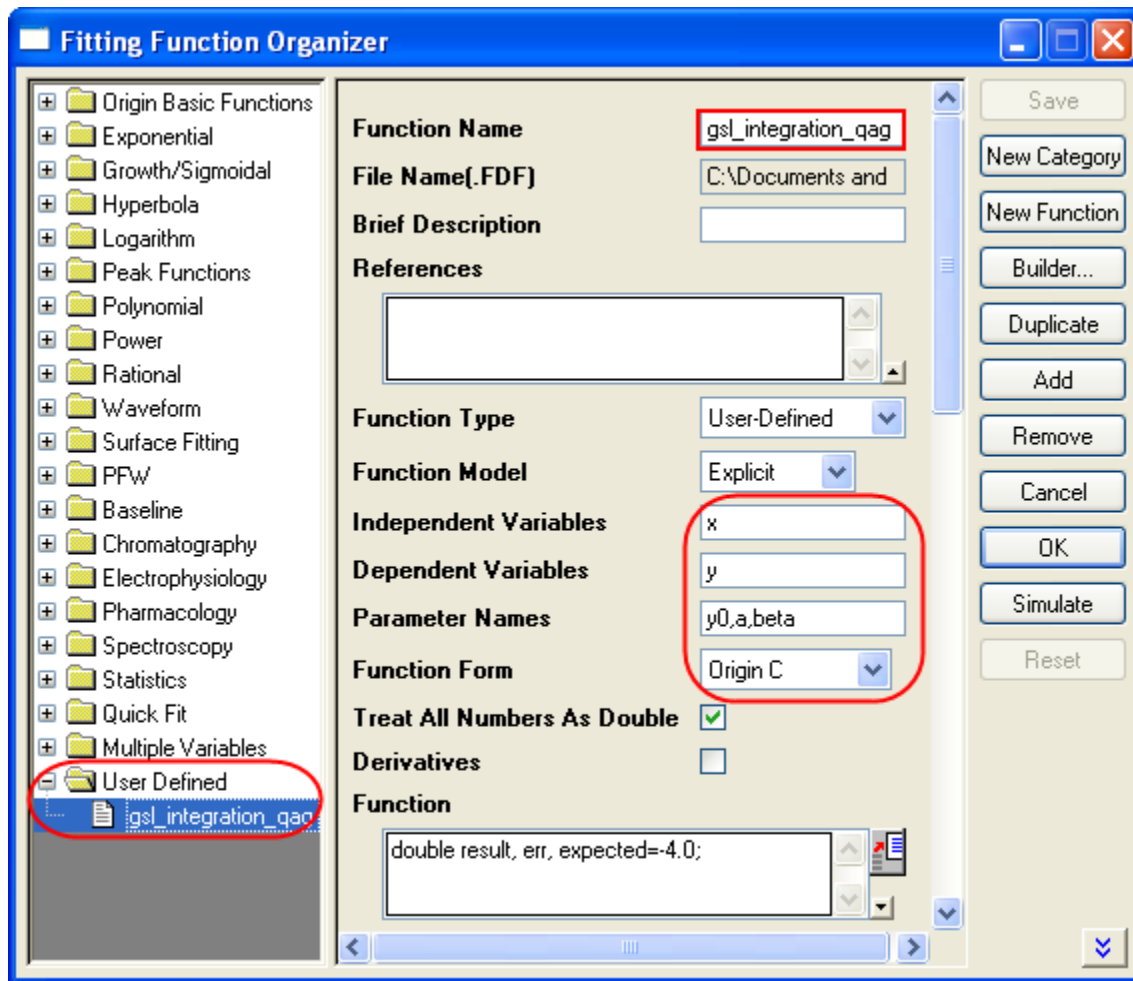

4. Press the button on the right hand side of the **Function** Field to open the code builder and add the following codes and compile: **\_nlfgsl\_integration\_qag.fit**

```
#include "..\ocgsl.h"

static double f_callback(double x, void * params)
{
    double alpha = *(double *)params;

    return exp(alpha*x);
}
```

```
void _nlsfgsl_integration_qag(  
  
// Fit Parameter(s):  
  
double y0, double a, double beta,  
  
// Independent Variable(s):  
  
double x,  
  
// Dependent Variable(s):  
  
double& y)  
{  
  
    // Beginning of editable part  
  
    double result, err, expected = -4.0;  
  
  
    // Allocates a workspace sufficient to hold 1000 double precision intervals  
  
    // their integration results and error estimates  
  
    gsl_integration_workspace *ww = gsl_integration_workspace_alloc(1000);  
  
  
    gsl_function F;  
  
    F.function = f_callback;  
  
    F.params = &beta ;  
  
  
    // integral interval (0, x), within the desired absolute  
  
    // error 0 and relative error 1e-7
```

```
gsl_integration_qag(&F, 0, x, 0, 1e-7, 1000, 0, ww, &result, &err);

// frees the memory associated with the workspace w

gsl_integration_workspace_free (ww);

y = y0 + a*result;

// End of editable part

}
```

Furthermore, a more elaborate but efficient version of the fitting function is given as follows

```
//-----
//
#include <ONLSF.h>
#include "..\ocgsl.h"

static double f_callback(double x, void * params)
{
    double alpha = *(double *)params;

    return exp(alpha*x);
}
```

```

void _nlsfgsl_integration_qag(
// Fit Parameter(s):
double y0, double a, double beta,
// Independent Variable(s):
double x,
// Dependent Variable(s):
double& y)
{
    // Beginning of editable part

    NLFitContext *pCtxt = Project.GetNLFitContext();

    if ( pCtxt )
    {
        static vector vInteg;

        NLSFCURRINFO    stCurrInfo;

        pCtxt->GetFitCurrInfo(&stCurrInfo);

        int nCurrentIndex = stCurrInfo.nCurrDataIndex;

        BOOL bIsNewParamValues = pCtxt->IsNewParamValues();

        if ( bIsNewParamValues )
        {
            vector vx;

```

```

pCtxt->GetIndepData (&vx);

int nSize = vx.GetSize();

vInteg.SetSize(nSize);

// Allocates a workspace sufficient to hold 1000 double
precision intervals,

// their integration results and error estimates

gsl_integration_workspace *ww =
gsl_integration_workspace_alloc(1000);

gsl_function F;

F.function = f_callback;

F.params = &beta ;

double result, err, expected = -4.0;

for(int ii=0; ii<nSize; ++ii)
{

// integral interval (0, vx[ii]), within the
desired absolute

// error 0 and relative error 1e-7

gsl_integration_qag(&F, 0, vx[ii], 0, 1e-7, 1000,
0, ww, &result, &err);

vInteg[ii] = result;

```

```

    }

    // frees the memory associated with the workspace w
    gsl_integration_workspace_free (ww);

}

y = y0 + a*vInteg[nCurrentIndex];

x;

}

// End of editable part
}

```

5. Add the following initialization codes:

**Parameter Init**

```

//Code to be executed to initialize parameters

sort( x_y_curve );

double coeff[2];

fitpoly( x_y_curve, 1, coeff);

a = coeff[0];

y0 = coeff[1];

beta=1.0

```

6. Fit using the user-defined function **gsl\_integration\_qag**, here are the results:

y0 = -1.06363E-6

a = 1

beta =1

#### 4.3.3.12 Fitting with NAG Special Function

##### 4.3.3.12.1 Summary

Origin allows user to define an Origin C fitting function using NAG special functions. You can call NAG routine to evaluate the special function.

Minimum Origin Version Required: Origin 8.0 SR6

##### 4.3.3.12.2 What you will learn

This tutorial will show you how to:

- Create fitting function using Fitting Function Organizer
- Create fitting function using NAG special function

##### 4.3.3.12.3 Example and Steps

We will fit the following model:

$$inorm = A * exp(-td/2.0/(t - t0)) * (I0(td/2.0/(t - t0)) + I1(td/2.0/(t - t0)))$$

Here  $A$ ,  $td$  and  $t0$  are the model parameters we want to obtain from the data fitting.  $I0$  and  $I1$  are the first kind of Modified Bessel function of order 0 and order 1, respectively. For current example, we use the sample data in the end of this tutorial. The fitting procedure can be outlined into the following steps:

Press **F9** to open the **Fitting Function Organizer** and then create a new Category named **FittingWithNAGSpecialFunc**. Define a new fitting function **FittingWithBessel** in the new category as follow:

<b>Function Name:</b>	FittingWithBessel
<b>Function Type:</b>	User-Defined
<b>Independent Variables:</b>	t
<b>Dependent Variables:</b>	inorm
<b>Parameter Names:</b>	A,t0,td



<b>Function Form:</b>	Origin C
<b>Function:</b>	

Click the button (icon) beside the **Function** box to open the code builder and define and compile and save the fitting function as follows:

```
#include <origin.h>

// Add your special include files here.

// For example, if you want to fit with functions from the NAG library,
// add the header file for the NAG functions here.

#include <OC_nag8.h>

// Add code here for other Origin C functions that you want to define in this file,
// and access in your fitting function.

// You can access C functions defined in other files, if those files are loaded and
compiled
// in your workspace, and the functions have been prototyped in a header file that
you have
// included above.

// You can access NLSF object methods and properties directly in your function
code.
```

## Tutorials for Origin

```
// You should follow C-language syntax in defining your function.

// For instance, if your parameter name is P1, you cannot use p1 in your function
code.

// When using fractions, remember that integer division such as 1/2 is equal to 0,
and not 0.5

// Use 0.5 or 1/2.0 to get the correct value.

// For more information and examples, please refer to the "User-Defined Fitting
Function"

// section of the Origin Help file.

//-----

//

void _nlsfFittingWithBessel(

// Fit Parameter(s):

double A, double t0, double td,

// Independent Variable(s):

double t,

// Dependent Variable(s):

double& inorm)

{

    // Beginning of editable part
```

```

        //inorm= A* exp(-td/2.0/(t-t0)) * ( s18aec(td/2.0/(t-
t0),NAGERR_DEFAULT)+s18afc(td/2.0/(t-t0),NAGERR_DEFAULT) );

static NagError fail1;

static NagError fail2;

double dtemp = td/2.0/(t-t0);

inorm= A* exp(-dtemp) * ( s18aec(dtemp,&fail1)+s18afc(dtemp,&fail2) );

if(fail1.code !=NE_NOERROR)

    printf("%s\n", fail1.message);

if(fail2.code !=NE_NOERROR)

    printf("%s\n", fail2.message);

// End of editable part
}

```

#### Simulate the Function

After the function body is defined, you can click the **Compile** button in **Code Builder** to check syntax errors. And then click **Return to Dialog** button to go back **Fitting Function Organizer** dialog box. Now click the **Save** button to generate the .FDF file (Function definition file).

Once you have a .FDF file, you can click the **Simulate** button to simulate a curve, this will be very helpful to evaluate the initial values. In the **simcurve** dialog, enter some proper parameter values and X range, and see what the curve looks like in the **Preview** panel.

#### Set the Initial Values for the Parameters

As it is a user-defined fitting function, you have to supply the initial guess values for the parameters before performing your fitting task for the data. You may do it by set them manually in the **Parameter** tab in **Nonlinear Curve Fit** dialog. For the sample data shown below, you can just set the initial values for the parameters  $A = 1$ ,  $td = 1$ ,  $t0 = 1$ . After the parameters are initialized, you can then do the fitting to obtain the fitting result, as shown to the right of the sample data.

#### 4.3.3.12.4 Sample Data

Copy the below sample data and use **Import Wizard** to import the data from **Clipboard**, then do the fitting using the given initial values for the parameters: A = 1, td = 1, t0 = 1.

Sample Data		Results
X	Y	
2	0.7868954118	
2.080808081	0.8133022141	
2.161616162	0.8178216765	
2.242424242	0.8427866729	
2.323232323	0.8315815363	
2.404040404	0.8484657180	
2.565656566	0.8618233553	
2.646464646	0.8745962570	
2.727272727	0.8921620316	
2.808080808	0.8687399759	

Parameters			
		Value	Standard Error
"Y"	A	0.96431	0.06562
	t0	1.39545	0.40134
	td	0.53711	0.54076

Reduced Chi-sqr = 1.02442755048E-4  
 COD(R<sup>2</sup>) = 0.92247024814828  
 Iterations Performed = 11  
 Total Iterations in Session = 11  
 Fit converged - tolerance criterion satisfied.

#### 4.3.3.13 Fitting Integral Function with parametric limit using NAG Library

##### 4.3.3.13.1 Summary

Before you start delving into this tutorial, you are recommended to read the relevant tutorial in [Fitting with Integral using NAG Library](#). And as far as programming is concerned, the two tutorials are basically the same, except that here you will learn to define Origin C fitting function with fitting parameters in the integral limit, while in the previous tutorial we in fact define a fitting independent variable in the integral limit. Also note that **a different NAG integrator** is used here.

Minimum Origin Version Required: Origin 8.0 SR6

##### 4.3.3.13.2 What you will learn

This tutorial will show you how to:

- Create a fitting function with Definite Integral using the NAG integration routine
- Create a fitting function with a parametric integral limit
- Use a log function to scale a large return value from the fitting function

#### 4.3.3.13.3 Example and Steps

For example, we will fit the [sample data](#) at the bottom of this page with the following model:

$$y = \int_c^d \frac{\cosh((x_i + b^2 \cdot x^2)/(b + x))}{a + (x_i^2 + x^2)} dx_i$$

Note that we use  $x_i$  to indicate the integral independent variable while  $x$  indicates the fitting independent variable. The model parameters  $a$ ,  $b$ ,  $c$ , and  $d$  are fitted parameters we want to obtain from the sample data. To prepare the data, you just need to copy the sample data to an Origin Work sheet. The fitting procedure is similar to the previous tutorial:

#### Define Fitting Function in Fitting Function Organizer

Press **F9** to open the Fitting Function Organizer and add the User-Defined integral fitting function **nag\_integration\_fitting\_cosh** to the Category **FittingWithIntegral**, similar to the first tutorial.

<b>Function Name:</b>	nag_integration_fitting_cosh
<b>Function Type:</b>	User-Defined
<b>Independent Variables:</b>	x
<b>Dependent Variables:</b>	y
<b>Parameter Names:</b>	a, b, c, d
<b>Function Form:</b>	Origin C
<b>Function:</b>	



Click the button  beside the **Function** box to open the code builder and define and compile the fitting function as follows: (**Note**: Remember to save the Function after compiling it and returning to the Function Organizer Dialog):

```
#include <origin.h>
```

```
// Add your special include files here.
```

## Tutorials for Origin

```
// For example, if you want to fit with functions from the NAG library,  
  
// add the header file for the NAG functions here.  
  
#include <OC_nag.h>  
  
  
  
  
// Add code here for other Origin C functions that you want to define in this file,  
  
// and access in your fitting function.  
  
struct user  
{  
  
    double a, b, fitX; // fitX the independent variable of fitting function  
  
};  
  
static double NAG_CALL f_callback(double x, Nag_User *comm) // x is the  
independent variable of the integrand  
{  
  
    struct user *sp = (struct user *) (comm->p);  
  
    double aa, bb, fitX; // temp variable to accept the parameters in the  
Nag_User communication struct  
  
    aa = sp->a;  
  
    bb = sp->b;
```

```
fitX = sp->fitX;

return cosh((x*x+bb*bb*fitX*fitX)/(bb+fitX))/(aa+(x*x+fitX*fitX));
}

// You can access C functions defined in other files, if those files are loaded and
// compiled

// in your workspace, and the functions have been prototyped in a header file that
// you have

// included above.

// You can access NLSF object methods and properties directly in your function
// code.

// You should follow C-language syntax in defining your function.

// For instance, if your parameter name is P1, you cannot use p1 in your function
// code.

// When using fractions, remember that integer division such as 1/2 is equal to 0,
// and not 0.5

// Use 0.5 or 1/2.0 to get the correct value.

// For more information and examples, please refer to the "User-Defined Fitting
// Function"

// section of the Origin Help file.
```

```
//-----  
  
//  
  
void _nlsfnag_integration_fitting_cosh(  
  
// Fit Parameter(s):  
  
double a, double b, double c, double d,  
  
// Independent Variable(s):  
  
double x,  
  
// Dependent Variable(s):  
  
double& y)  
  
{  
  
    // Beginning of editable part  
  
    double epsabs = 0.00001, epsrel = 0.0000001, result, abserr;  
  
    Integer max_num_subint = 500;  
  
    // you may use epsabs and epsrel and this quantity to enhance your desired  
precision  
  
    // when not enough precision encountered  
  
  
    Nag_QuadProgress qp;  
  
    static NagError fail;
```



```
// the parameters parameterize the integrand can be input to the call_back
function

// through the Nag_User communication struct

Nag_User comm;

struct user s;

s.a = a;

s.b = b;

s.fitX = x;

comm.p = (Pointer)&s;

d01sjc(f_callback, c, d, epsabs, epsrel, max_num_subint, &result, &abserr,
&qp, &comm, &fail);

// you may want to exam the error by printing out error message, just
uncomment the following lines

// if (fail.code != NE_NOERROR)

// printf("%s\n", fail.message);

// For the error other than the following three errors which are due to bad
input parameters

// or allocation failure NE_INT_ARG_LT NE_BAD_PARAM NE_ALLOC_FAIL
```

```

        // You will need to free the memory allocation before calling the
integration routine again to

        // avoid memory leakage

        if (fail.code != NE_INT_ARG_LT && fail.code != NE_BAD_PARAM && fail.code !=
NE_ALLOC_FAIL)

        {

                NAG_FREE(qp.sub_int_beg_pts);

                NAG_FREE(qp.sub_int_end_pts);

                NAG_FREE(qp.sub_int_result);

                NAG_FREE(qp.sub_int_error);

        }

        y = log(result);

        // note use log of the integral result as return as the integral result is
large,

        // you are not necessary to do so

        // End of editable part
}

```

In the above code, we define the integrand as a callback function ***f\_callback*** just outside the fitting function body ***\_nlsfnag\_integration\_fitting\_cosh***. Note that we parametrize the integrand function with the variables ***a***, ***b*** and ***fitX***, and pass them into the callback function through the *Nag\_User* struct. After that we perform the integration using NAG integrator ***d01sjc***. Besides, you can also use other [Quadrature Routines](#) as you want. In the current example, we also use a log scale for the fitting function. (The sample data are already scaled by a log function)

Compile the code, return to the dialog and then Save the fitting function in the function Organizer and open the **Nonlinear Curve Fit** dialog in the **Analysis-Fitting** menu. You can then select this user-defined fitting function in the **Function Selection** page under **Setting** Tab.

#### Set the Initial Values for the Parameters

Similarly, as it is a user-defined fitting function, you have to supply the initial guess values for the parameters. You may manually set them in the **Parameter** tab in **Nonlinear Curve Fit** dialog. For current example, you can just set the initial values for the parameters  $a = 1, b = 10, c = 3, d = 4$ . After the parameters are initialized, you can perform the fitting to obtain the fitting result, as shown in the following.

#### 4.3.3.13.4 Sample Data

Sample Data		Results	
X	Y		
-5	498.19046		
-4.33333	329.43196		
-3.66667	210.28005		
-3	126.55799		
-2.33333	69.01544		
-1.66667	31.3555		
-1	9.1393		
-0.33333	-0.84496		
0.33333	-0.99914		
1	6.86736		

	Value	Standard Error
a	0.99303	0.06577
b	10	5.3108E-5
c	3.00083	0.0062
d	4.00022	9.38713E-4

#### 4.3.3.14 Fitting with Integral using NAG Library

##### 4.3.3.14.1 Summary

Origin allows user to define an Origin C fitting function which involves an integral. You can call NAG functions to perform the integration while defining the fitting function. There are built-in functions in Origin C which perform integration. For the current example, the NAG solution is recommended. It has a better performance compared to the built-in integration algorithm. Note that an **infinite NAG integrator** is used here.

Minimum Origin Version Required: Origin 8.0 SR6

#### 4.3.3.14.2 What you will learn

This tutorial will show you how to:

- Create a fitting function using the Fitting Function Organizer
- Create a fitting function with a Definite Integral using a NAG integration routine
- Set up the Initial Code for the fitting function

#### 4.3.3.14.3 Example and Steps

We will fit the following model:

$$y = y_0 + \int_{-\infty}^x \frac{A}{w\sqrt{\frac{\pi}{2}}} e^{-2\frac{(t-x_c)^2}{w^2}} dt$$

Here  $y_0$ ,  $A$ ,  $x_c$  and  $w$  are the model parameters we want to obtain from the data fitting. The fitting procedure can be outlined into the following steps:

##### Define the Function

Press **F9** to open the **Fitting Function Organizer** and then create a new Category named **FittingWithIntegral**. Define a new fitting function **nag\_integration\_fitting** in the new category as follow:

<b>Function Name:</b>	nag_integration_fitting
<b>Function Type:</b>	User-Defined
<b>Independent Variables:</b>	x
<b>Dependent Variables:</b>	y
<b>Parameter Names:</b>	y0, A, xc, w
<b>Function Form:</b>	Origin C
<b>Function:</b>	



Click the  button beside the **Function** box to open the code builder then follow the steps below:

1. Scroll up to go to line

```
//add the header file for the NAG functions here.
```

and paste the following code below this line.

```
#include <OC_nag.h>
```

2. Go to line

```
// and access in your fitting function.
```

and paste the following code below.

```
struct user // parameters in the integrand
{
    double amp, center, width;
};

// Function supplied by user, return the value of the integrand at a given
// x.

static double NAG_CALL f_callback(double x, Nag_User *comm)
{
```

```

    struct user *sp = (struct user *) (comm->p);

    double amp, center, width;    // temp variable to accept the
parameters in the Nag_User communication struct

    amp = sp->amp;

    center = sp->center;

    width = sp->width;

    return amp * exp( -2*(x - center)*(x - center)/width/width ) /
(width*sqrt(PI/2));
}

```

## 3. Go to line

```

// Beginning of editable part.

```

and paste the following code below.

```

// Through the absolute accuracy epsabs, relative accuracy epsrel and
max_num_subint you can

    // control the precision of the integration you need

    // if epsrel is set negative, the absolute accuracy will be used.

    // Similarly, you can control only relative accuracy by set the
epsabs negative

```

```
double epsabs = 0.0, epsrel = 0.0001;

// The max number of sub-intervals needed to evaluate the function
in the integral

// The more difficult the integrand the larger max_num_subint
should be

// For most problems 200 to 500 is adequate and recommended

Integer max_num_subint = 200;

// Result keeps the approximate integral value returned by the
algorithm

// abserr is an estimate of the error which should be an upper
bound for the |I - result|

// where I is the integral value

double result, abserr;

// The structure of type Nag_QuadProgress,

// it contains pointers allocated memory internally with
max_num_subint elements

Nag_QuadProgress qp;

// The NAG error parameter (structure)

static NagError fail;
```

```
// Parameters passed to integrand by Nag_User communication struct

    Nag_User comm;

    struct user s;

    s.amp = A;

    s.center = xc;

    s.width = w;

    comm.p = (Pointer)&s;

// Perform integration

// There are 3 kinds of infinite boundary types you can use in Nag
infinite integrator

// Nag_LowerSemiInfinite, Nag_UpperSemiInfinite, Nag_Infinite

    d01smc(f_callback, Nag_LowerSemiInfinite, x, epsabs, epsrel,
max_num_subint, &result, &abserr, &qp, &comm, &fail);

// you may want to exam the error by printing out error
message, just uncomment the following lines

// if (fail.code != NE_NOERROR)

// printf("%s\n", fail.message);

// For the error other than the following three errors which are
due to bad input parameters

// or allocation failure  NE_INT_ARG_LT  NE_BAD_PARAM
```



```

NE_ALLOC_FAIL

    // You will need to free the memory allocation before calling the
    integration routine again to avoid memory leakage

    if (fail.code != NE_INT_ARG_LT && fail.code != NE_BAD_PARAM &&
fail.code != NE_ALLOC_FAIL)

    {

        NAG_FREE(qp.sub_int_beg_pts);

        NAG_FREE(qp.sub_int_end_pts);

        NAG_FREE(qp.sub_int_result);

        NAG_FREE(qp.sub_int_error);

    }

    // Calculate the fitted value

    y = y0 + result;

```

4. Click **Compile** to compile the file.

In the above code, we firstly define the integrand as a callback function ***f\_callback*** just outside the fitting function body ***\_nlsfnag\_integration\_fitting***. Note that we parametrize the integrand function with the variables ***amp***, ***center*** and ***width***, and pass them into the callback function through the *Nag\_User* struct. Inside the fitting function, we perform the integration using NAG integrator ***d01smc***.

Calling NAG functions should be more efficient than writing your own routines. Using an analogous method, you can perform finite, infinite, one-dimension and multi-dimension quadrature in your fitting function. Please read the [NAG Quadrature](#) page and select a proper routine.

#### Set the Initial Values for the Parameters or Setup the Initial Code

As it is a user-defined fitting function, you have to supply the initial guess values for the parameters. You may do it later by setting them manually in the **Parameter** tab in **Nonlinear Curve Fit** dialog.

#### Simulate the Function

After entering the function body codes, you can click the **Compile** button in **Code Builder** to check syntax errors. And then click **Return to Dialog** button to go back **Fitting Function Organizer** dialog box. Now click the **Save** button to generate the .FDF file (Function definition file).

Once you have a .FDF file, you can click the **Simulate** button to simulate a curve, this will be very helpful to evaluate the initial values. In the **simcurve** dialog, enter some proper parameter values and X range, and see what the curve looks like in the **Preview** panel.

#### Fit the Curve

Before you start to fit the curve, it is very helpful to simulate the function first. Performing integration may take some time, if there is any mistake, you may see Origin "freeze" after you click the **Fit** button. So in the **Fitting Function Organizer** dialog, select the function we defined and click the **Simulate** button. This will bring up the **simcurve** X-Function. Enter some "guess" values and click the **Apply** button. If the simulated curve looks like your source data, you can go further to fit.

To test the fitting function:

1. Import `\Samples\Curve Fitting\Replicate Response Data.dat` to Origin.
2. Next we are going to use log scale of the data in Col(A). To do this, in the **F(x) =** column label row of column A, type in the formula  $Col(A) = \log(Col(A))$  and hit **Enter** once to change the data.
3. Highlight column A and B and create a scatter plot, the shape is a sigmoid curve.
4. Bring up the **NLFit** dialog from **Analysis: Fitting: Nonlinear Curve Fit** menu item.
5. Select the fitting function we defined in the previous sections and go to the **Parameters** tab, initialize all parameters by 1 and fit (click **Fit** button).
6. You are supposed to see these results:

	Value	Standard Error
<b>y0</b>	-0.00806	0.18319
<b>A</b>	3.16479	0.39624
<b>xc</b>	-0.19393	0.10108
<b>w</b>	1.77252	0.33878

#### 4.3.3.15 Fitting with Integral using LabTalk Function

##### 4.3.3.15.1 Summary

Since version **Origin 8.6**, Origin introduces a new LabTalk function, **integral()**, to do one-dimensional integration. This function returns the integral value of:

$$\int_{LowerLimit}^{UpperLimit} f(t, arg1, arg2, \dots), dt$$

And the interface of the **integral()** function is defined as below:

```
integral(integrandName, LowerLimit, UpperLimit [, arg1, arg2, ...])
```

Where *integrandName* here is the function name of the integrand:

$$f(t, \text{arg1}, \text{arg2}, \dots)$$

In other word, the *integral()* function do the following things:

- Accept another function (the first argument) as the integrand.
- Perform integration on specified lower and upper limit and return the integral value.
- If need, pass the subsequent arguments (*Arg1*, *Arg2*, ...) into the integrand function.

Using this feature, we can define a fitting function with *integral()* function, and pass proper fitting parameters to the integrand, to do integration in curve fitting.

In this tutorial, we will modify the other tutorial, [calling NAG functions to do integration during fitting](#), into LabTalk form, and show you how simple and straightforward to fit an integration function.

Minimum Origin Version Required: Origin 8.6



Beginning with Origin 2018b, you can define a an implicit function using integrals

#### 4.3.3.15.2 What you will learn

This tutorial will show you how to:

- Create a fitting function using the Fitting Function Builder
- Create a fitting function with a Definite Integral using Labtalk function
- Set up the Initial Code for the fitting function

#### 4.3.3.15.3 Example and Steps

##### The Fitting Model

The fitting model is described as below:

$$y = y_0 + \int_{-\infty}^x \frac{A}{w \sqrt{\frac{\pi}{2}}} e^{-2 \frac{(t-x_c)^2}{w^2}} dt$$

There are four parameters in the fitting function, and we need to pass three of them into the integrand, and use the independent variable as upper limit, to do integration. So you should define the integrand first, and then use the *integral()* function to perform integration inside your fitting function body.

##### Define the Function

1. Press **F8** to open **Fitting Function Builder** dialog. Make sure choosing **Create a New Function** option, and click **Next** to navigate to the next page.
2. In the **Name and Type** page, enter a function name, say **MyIntegGauss**. Leave the default function type as **Expression**, and then check the **Include Integration During Fitting** checkbox. This will lead you to a new page in the next step.

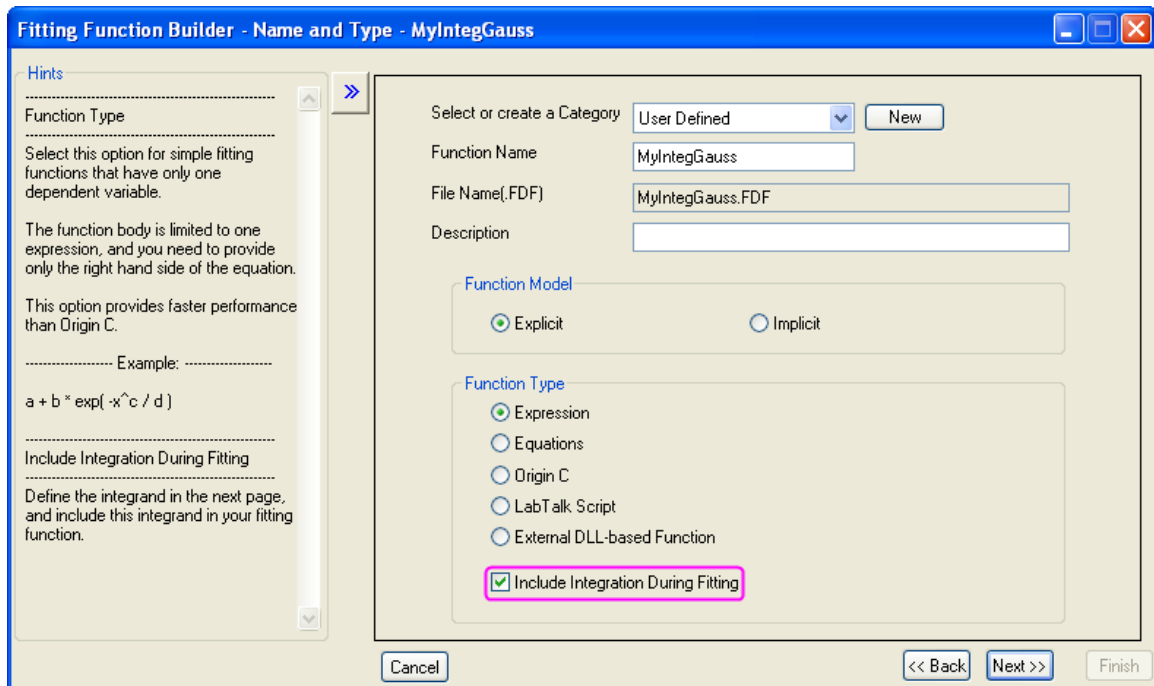

3. In the **Integrand** page, you can define the expression of the integrand. Currently, Origin supports one-dimensional integral only, so the integrand should have ONE integration variable. In this example, the expression of the integrand is:

$$\frac{A}{w\sqrt{\frac{\pi}{2}}} e^{-2\frac{(t-x_c)^2}{w^2}}$$

The other variables, like  $x_c$ ,  $w$ , and  $A$ , are parameters of the integrand. To distinguish from fitting parameters, we named them *Arguments* here, and use the arguments name  $ixc$ ,  $iw$ , and  $iA$  instead. Later, we can pass fitting parameters into these arguments. So, the integrand definition should look like:

Fitting Function Builder - Integrand - MyIntegGauss

<<

Integrand Name: MyIntegrand

Integration Variable: t

Arguments: ixc, iw, iA

function double MyIntegrand(double t, double ixc, double iw, double iA)

return iA \* exp(-2\*(t-ixc)^2/iw^2) / (iw\*sqrt(PI/2));

Cancel << Back Next >> Finish

Note that this is a LabTalk function. To get the integration value, you must have a **RETURN** statement in the function body. And the integrand expression in this example should be:

```
return iA * exp(-2*(t-ixc)^2/iw^2) / (iw*sqrt(PI/2));
```

- When all set, click **Next** to go to the **Variables and Parameters** page to define the variables and parameters for the fitting function as below:

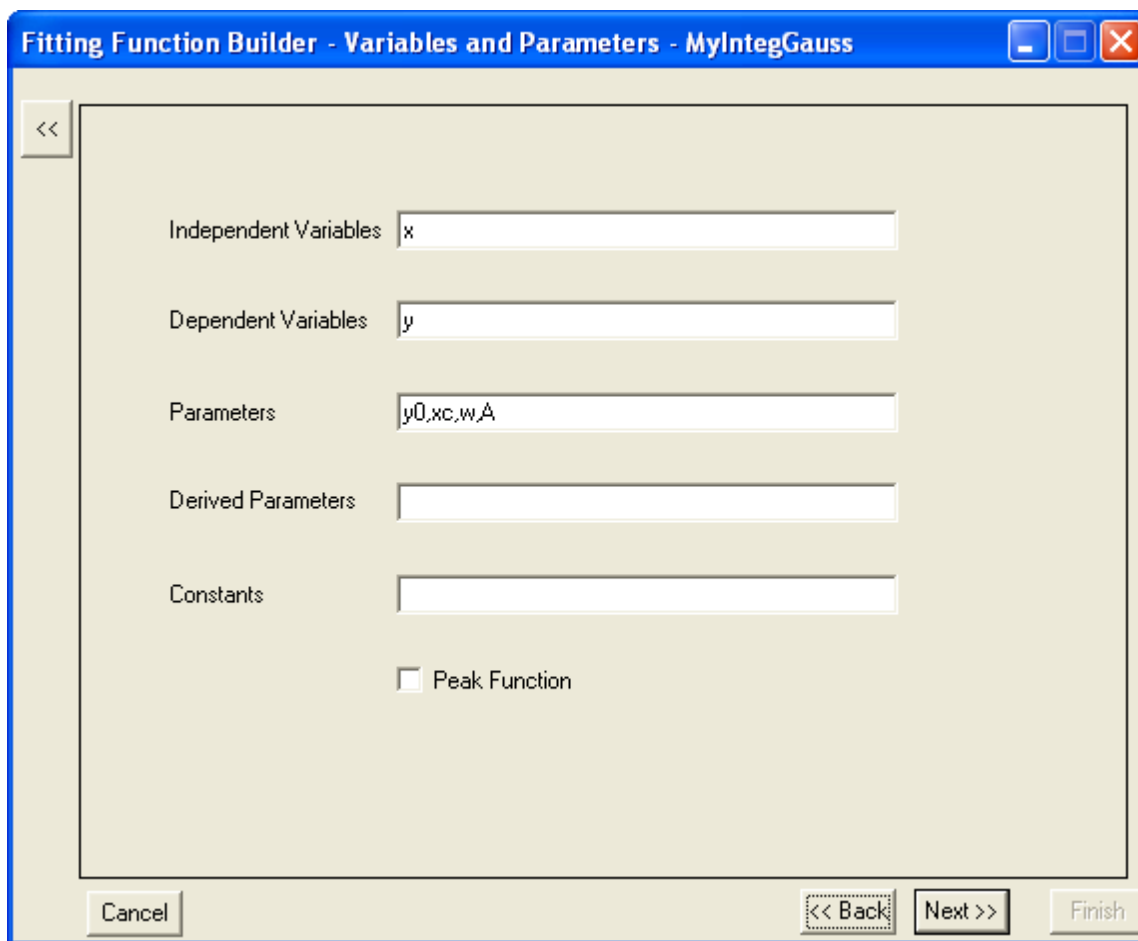

- The next **Function** page is where you define the fitting function body. Once you choose to include integration in your fitting function at the beginning of the fitting function builder wizard, there is an extra tab, **Integrand**, shown on this page. In this tab, you can map the fitting variables and parameters with elements of the integrand, including lower limit, upper limit, and integrand arguments. And in this example, we will map the variables as below:

Integrand elements	Values pass into integrand
Lower Limit	-inf
Upper Limit	x
ixc	xc
iw	w

iA	A
----	---

6. Once set up all the mappings as above table, click the **Insert** button, then well prepared *integral()* function is inserted into the **Function Body** box as:

```
integral(MyIntegrand, -inf ,x ,xc ,w ,A)
```

7. This expression means perform integration on the function, whose name is *MyIntegrand*, from negative infinite to *x*, and pass the three fitting parameters, *xc*, *w*, and *A* to the integrand.
8. By adding the constant parameter, *y0*, into the expression, the whole fitting function body should be:

```
y0 + integral(MyIntegrand, -inf, x, xc ,w ,A);
```

9. And the page may looks as below:

- 10.

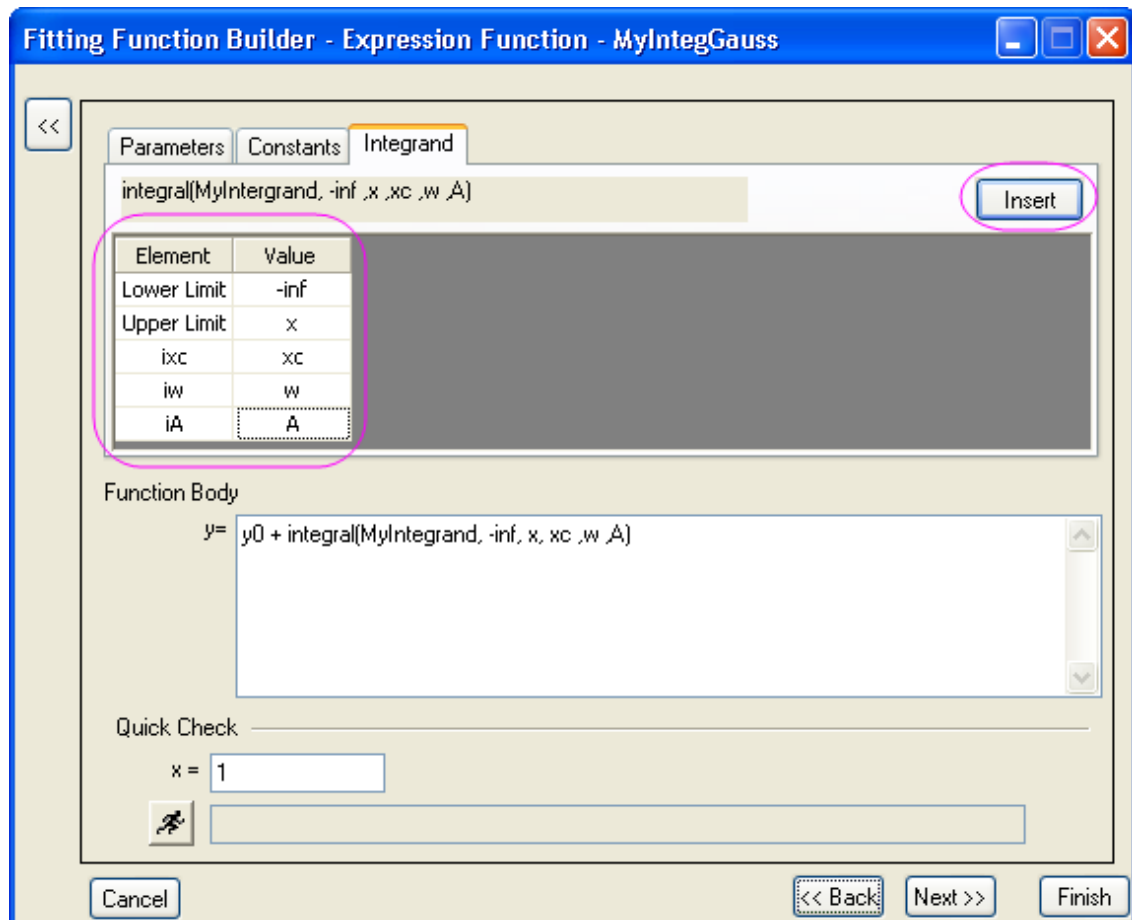

- 11.
12. Then active the **Parameters** tab, and give some proper initial values for each fitting parameters as:

Parameters					
Param	Unit	Meaning	Fixed	Initial Value	Significant Digits
y0			<input type="checkbox"/>	0	System
xc			<input type="checkbox"/>	0	System
w			<input type="checkbox"/>	2	System
A			<input type="checkbox"/>	3	System

Now, you can click **Finish** button to save this fitting function.

**Fit the Curve**

Copy and paste the following data into Origin worksheet:

X	Y
-1.69897	0.13136
-1.22185	0.34384
-0.92082	0.6554
-0.82391	0.73699
-0.69897	1.00157
0	1.70785
0.30103	2.31437
0.69897	2.77326
1	2.79321

Highlight the Y column, and press **Ctrl + Y** to open the **NLFit** dialog. Select the function you just defined, and click **Fit** button to perform fitting. The fitting result should be the same like using NAG function directly:



Parameters			
		Value	Standard Error
B	y0	-0.01749	0.20203
	xc	-0.21058	0.11852
	w	1.76925	0.36484
	A	3.15913	0.42476

Reduced Chi-sqr = 0.0114837622841  
 COD(R^2) = 0.99334903530799  
 Iterations Performed = 6  
 Total Iterations in Session = 6  
 Fit converged. Chi-Sqr tolerance value of 1E-9 was reached.

#### 4.3.3.16 Fitting with Two Integrals using LabTalk Function

##### 4.3.3.16.1 Summary

In some circumstance, one may want to create fitting function with multiple integrals:

$$\int_{LL1}^{UL1} f(t, arg1, arg2, \dots) dt + \int_{LL2}^{UL2} g(x, arg3, arg4, \dots) dx$$

We refer to [Fitting with Integral using LabTalk Function](#) for detailed description of parameters in the expression.

In version Origin 8.6, however, **Fitting Function Builder** just supports one integral in fitting function. Bypassing complex Origin C code, we can use **Fitting Function Organizer** to reach the goal.

In this tutorial, we will show you how to create a fitting function comprised of two integrals using function organizer. Of course, one can include more integrals as desired.

Minimum Origin Version Required: Origin 8.6



Beginning with Origin 2018b, you can define a an implicit function using integrals.

##### 4.3.3.16.2 What you will learn

This tutorial will show you how to:

- Create a fitting function using the Fitting Function Organizer
- Create a fitting function with two integrals using LabTalk function

##### 4.3.3.16.3 Example and Steps

###### The Fitting Model

The fitting model is described as below:

$$y = y_0 + \int_{-5}^x A t dt - \int_{-\infty}^x B t \exp(-t^2/w^2) dt$$

There are four parameters in the fitting function, and we need to pass three of them into the integrand, and use the independent variable as upper limit, to do integration.

**Define the Function**

1. Press F9 to open **Fitting Function Organizer** dialog. Add a new function by pressing **New Function** after you select a category in which you want to put your function. One can also add new category by pressing the **New Category** button.

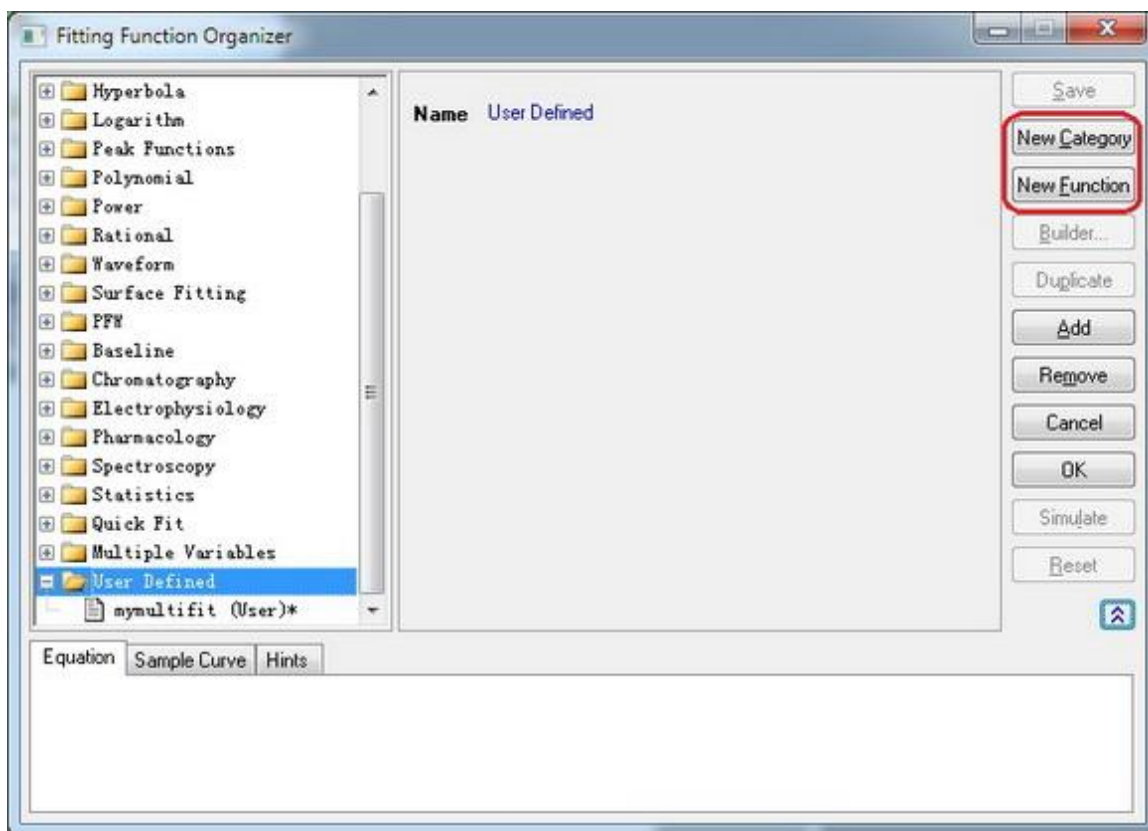

2. Specify the function name in the **Function Name** edit box as you like. Define **Independent Variables**, **Dependent Variables** and **Parameter Names** in corresponding edit box.
3. Select the **Function Form** in the drop box. One can find explanations in the **Hints** tab at the bottom of the dialog.

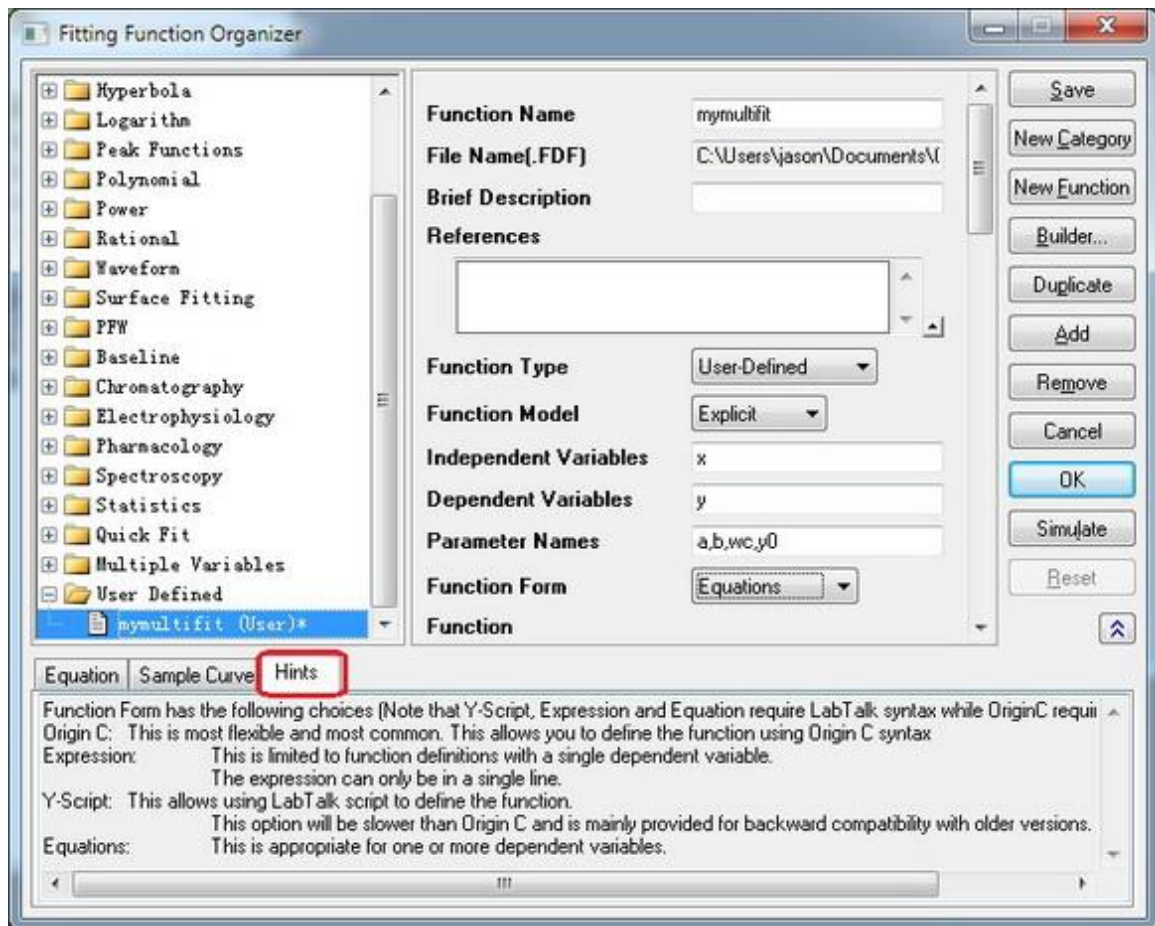

- In the **Function** edit box, define your fitting function. The integrals are written in the form of LabTalk **integral** function.

```
y=integral(polyint, -5, x, a)-integral(gaussint, -inf, x, b, wc)+y0
```

As described in [Fitting with Integral using LabTalk Function](#),  $x$ ,  $a$ ,  $b$  and  $wc$  are parameters passed into the integrand functions.

- Press the button at the right corner of **Parameter Settings** box to active **Parameter Settings** dialog. Set initial values as well as other constraints such as lower bounds, upper bounds for each parameter.

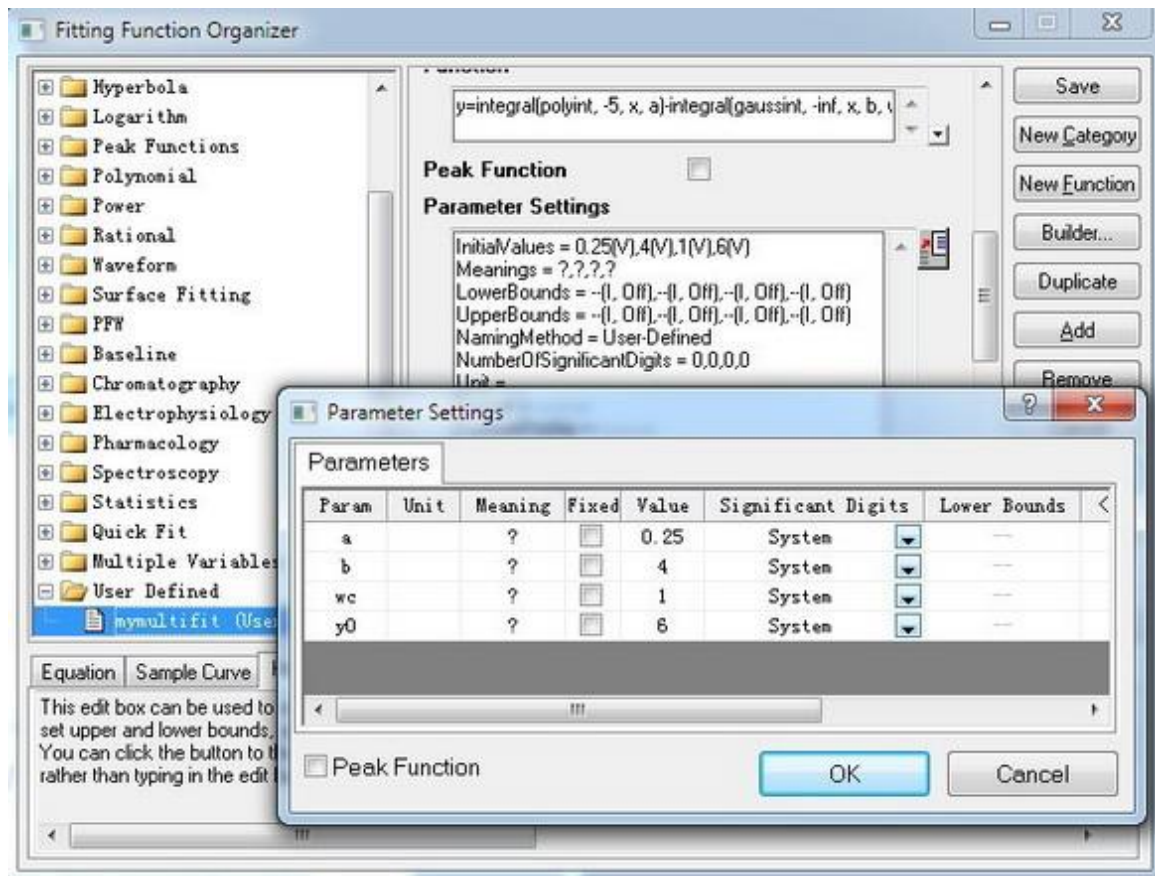

- Define the two integrals in the **LabTalk Functions Definition and Initializations** box. In this case, the functions should be:

```
function double polyint(double t, double ia)
{
    return ia*t ;
}
```

```

function double gaussint(t, ib, iwc)
{
    return ib *t* exp(-(t)^2/iwc^2) ;
}

```

7. We have successfully set our two integrals fitting function. You can set other information in corresponding box. Do not forget to **Save** your fitting function after you finish.

#### Fit the Curve

Copy and paste the following data into Origin worksheet:

X	Y
-3	2.47613
-2.6	2.24016
-2.2	2.01543
-1.8	1.83094
-1.5	1.85038
-1.1	2.17725
-0.9	2.44967
-0.7	2.61423
-0.5	3.02305
-0.3	3.23057

-0.1	3.37822
0.1	3.2827
0.3	3.18775
0.5	2.86194
0.7	2.69104
0.9	2.39315
1.4	2.04046
1.8	1.85287
2.2	1.85325
2.6	2.20569

Highlight the Y column, and press CTRL + Y to open the **NLFit** dialog. Select the function you just defined, and click fit button  to perform fitting.

**Parameters**

		Value	Standard Error
B	a	0.26191	0.03201
	b	3.5282	0.21956
	wc	1.07153	0.04832
	y0	4.57942	0.29938

Reduced Chi-sqr = 0.00376913022891  
 COD(R<sup>2</sup>) = 0.98854435477482  
 Iterations Performed = 7  
 Total Iterations in Session = 7  
 Fit converged. Chi-Sqr tolerance value of 1E-9 was reached.

#### 4.3.3.17 Fitting with Summation

##### 4.3.3.17.1 Summary

We have showed you how to perform [fitting with an integral](#) using the [NAG Library](#), and now you'll learn how to do that without calling NAG functions. In this tutorial, we will show you how to do integration by the trapezoidal rule and include the summation procedure in the fitting function.

Minimum Origin Version Required: Origin 8.0 SR6

#### 4.3.3.17.2 What you will learn

- How to include summation in your fitting function.
- Trapezoidal rule for integration.

#### 4.3.3.17.3 Example and Steps

We will fit the same model as the [integral fit using NAG](#):

$$y = y_0 + \int_{-\infty}^x \frac{A}{w\sqrt{\frac{\pi}{2}}} e^{-2\frac{(x-x_c)^2}{w^2}} dx$$

The difference is that we will perform the integration within the fitting function. Using the trapezoidal rule, we will first divide the curve into pieces and then approximate the integral area by multiple trapezoids. The precision of the result then depends on how many trapezoids will be used. Since this is a semi-infinite integration, we will set an increment (steps) and construct trapezoids from the upper integral limit,  $x$ , to the lower integral limit, negative infinity and then accumulate the area of these trapezoids. When the increment of the area is significantly small, we will stop the summation. Before doing the summation, you should guarantee that the function is **CONVERGENT**, or you should include a convergence check in your code.

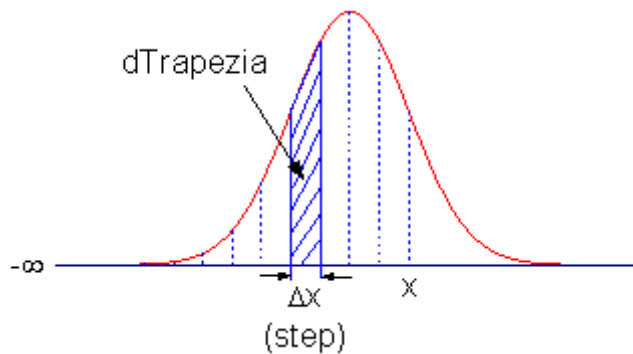

#### Define the Function

Select **Tools:Fitting Function Organizer** or alternatively press the **F9** key to open the **Fitting Function Organizer** and then define the function as follows:

<b>Function Name:</b>	summation
<b>Function Type:</b>	User-Defined
<b>Independent Variables:</b>	x
<b>Dependent Variables:</b>	y

<b>Parameter Names:</b>	y0, A, xc, w
<b>Function Form:</b>	Origin C
<b>Function:</b>	

Click the button (icon) beside the **Function** box to open Code Builder. Define, compile and save the fitting function as follows:

```
#pragma warning(error : 15618)

#include <origin.h>

// Subroutine for integrand

double f(double x, double A, double xc, double w)

{

    return A * exp(-2*(x-xc)*(x-xc)/w/w) / w / sqrt(PI/2);

}

//-----

//

void _nlsfsummation(

// Fit Parameter(s):

double y0, double A, double xc, double w,

// Independent Variable(s):

double x,
```



```

// Dependent Variable(s):

double& y)

{

    // Beginning of editable part

    // Set the tolerance for stop integration.

    double dPrecision = 1e-12;

    // Initialization

    double dIntegral = 0.0;

    double dTrapezia = 0.0;

    // Steps, or Precision.

    double dStep = 0.01;

    // Perform integrate by trapezoidal rule.

    // Note that you should guarantee that the function is CONVERGENT.

    do

    {

        // Trapezia area.

        dTrapezia = 0.5 * ( f(x, A, xc, w) + f((x-dStep), A, xc, w) ) *
dStep;

        // Accumulate area.

        dIntegral += dTrapezia;

        x -= dStep;

    }while( (dTrapezia/dIntegral) > dPrecision );

```

```

// Set y value.

y = y0 + dIntegral;

// End of editable part

}

```

### Fit the Curve

We can use the same data to test the result.

1. Import `\Samples\Curve Fitting\Replicate Response Data.dat`.
2. Highlight the first column, right-click on it, and select Set Column Values from the context menu.
3. Set  $Col(A) = log(Col(A))$  in the **Set Column Values** dialog. This will make a sigmoidal curve.
4. Highlight columns A and B and create a scatter plot.
5. Then bring up the **NLFit** dialog by pressing **Ctrl + Y**. Select the fitting function we just defined and go to the **Parameters** tab, initialize all parameters to 1 and fit. You should see these results:

	Value	Standard Error
<b>y0</b>	-0.00806	0.18319
<b>A</b>	3.16479	0.39624
<b>xc</b>	-0.19393	0.10108
<b>w</b>	1.7725	0.33878

#### 4.3.3.18 Fitting Complex Function

##### 4.3.3.18.1 Summary

When fitting with a complex function, we can easily separate the complex function to two functions: one corresponding to its real part and the other corresponding to its imaginary part. With these two functions, we can define the complex fitting function with two dependent variables by **Fitting Function Organizer** and can access it in **NLFit** dialog. We will illustrate how to fit with complex function below. More details about fitting with multiple dependent or independent variable please refer to [Fitting with Multiple Independent Variables](#).

Minimum Origin Version Required: Origin 8.0 SR6

##### 4.3.3.18.2 What you will learn

This tutorial will show you how to:

- Create a user-defined complex fitting function with two dependent variables and one independent variable

- Fit with such function in NLFit

#### 4.3.3.18.3 Steps

1. Select whole form below (including header line) and right click to choose **Copy** to put the data in clipboard.

Omega	Y1	Y2
0	3	0
0.01	2.88462	-0.28846
0.02	2.58621	-0.51724
0.03	2.20588	-0.66176
0.04	1.82927	-0.73171
0.05	1.5	-0.75
0.06	1.22951	-0.7377
0.07	1.01351	-0.70946
0.08	0.8427	-0.67416
0.09	0.70755	-0.63679
0.1	0.6	-0.6
0.11	0.5137	-0.56507

2. Select **Import/ Import Wizard** to open Import Wizard dialog. Then choose **Clipboard** in **Data Source** group and click **Finish** to import the data.



3. Select **Tools: Fitting Function Organizer** from menu (or press **F9**) to bring up the **Fitting Function Organizer** and define a new fitting function named **ComplexFitting** in **NewCategory** (create the category if not exist) as follow:

<b>Function Name:</b>	ComplexFitting
<b>Function Type:</b>	User-Defined
<b>Independent Variables:</b>	omega
<b>Dependent Variables:</b>	y1,y2
<b>Parameter Names:</b>	A,tau
<b>Function Form:</b>	Origin C
<b>Function:</b>	<pre>complex cc = A/(1+1i*omega*tau); y1 = cc.m_re; y2 = cc.m_im;</pre>

4. Note: To use the imaginary unit "i" for creating complex numbers, you need to write it as "1i" in Origin C, as in the above **Function** row. And **complex** is a class that implements a complex number data type. It contains both a Real and an Imaginary component.
5. For more details about creating user-defined fitting function, please refer to [User Defined Fitting Function using Origin C](#).
6. Highlight all the columns and select **Analysis: Fitting: Non-linear Curve Fit** from menu to bring up the NLFit dialog. Select the function **ComplexFitting** from **NewCategory** on the **Settings: Function**

**Selection** page. Set the input datasets in the **Data Selection** page as follow:

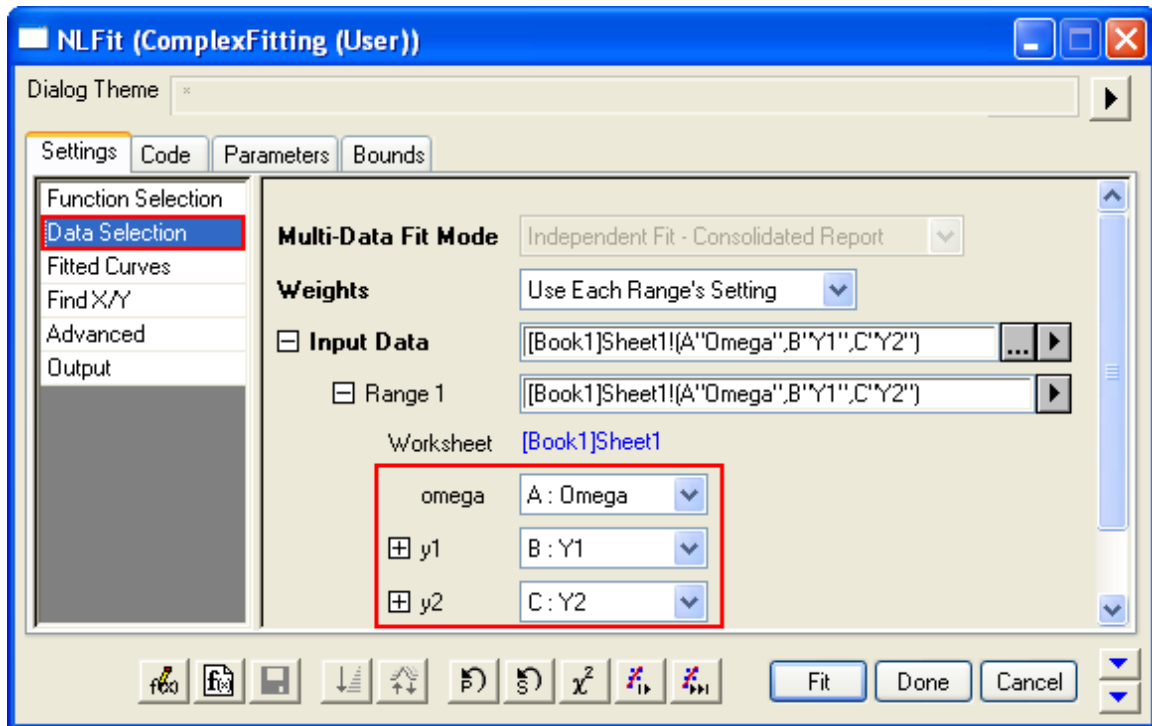

7. Select **Parameters Tab** and set the initial values as follows:

Param	Meaning	Fixed	Value	Error
A	?	<input type="checkbox"/>	1	--
tau	?	<input type="checkbox"/>	1	--

8. Click **Fit** to generate the fitting report sheet. You can see the results from the report worksheet as below:

#### Parameters

		Value	Standard Error
Y1,Y2	A	2.36712	0.15413
	tau	15.84746	1.94844

#### Statistics

	Y1,Y2
Number of Points	24
Degrees of Freedom	22
Reduced Chi-Sqr	0.12339
Residual Sum of Squares	2.71451
Adj. R-Square	0.92387
Fit Status	Succeeded(100)

From the Statistics table, we can see that the fitting is fairly successful.

#### 4.3.3.19 Fitting with Convolution

### 4.3.3.19.1 Summary

When performing curve fitting to experimental data, one may encounter the need to account for instrument response in the data. One way to do this is to first perform deconvolution on the data to remove the instrument response, and then perform curve fitting as a second step. However, deconvolution is not always reliable as the results can be very sensitive to any noise present in the data. A more reliable way is to perform convolution of the fitting function with the instrument response while performing the fitting. This tutorial will demonstrate how to perform convolution while fitting.



If your data is a convolution of Gauss and Exponential functions, you can simply use built-in fitting function [GaussMod](#) in **Peak Functions** category to directly fit your data.

Minimum Origin Version Required: Origin 2016 SR0.

### 4.3.3.19.2 What you will learn

This tutorial will show you how to:

- Access fitting information during iterations.
- Perform convolution while fitting.

### 4.3.3.19.3 Example and Steps

#### Background

Let's start this example by importing `\Samples\Curve Fitting\FitConv.dat`.

A(X)	B(Y)	C(Y)
Sampling	Signal	Impulse
0	-0.19775	0
0.1	-0.32893	0
0.2	0.10055	0
0.3	0.09394	0
0.4	-0.1292	0
0.5	0.06346	1.48672E-6
0.6	0.19453	1.3383E-4

The source data includes sampling points, output signal, and the impulse response. This experiment assumes that the output signal was the convolution of an exponential decay function with a Gaussian response:

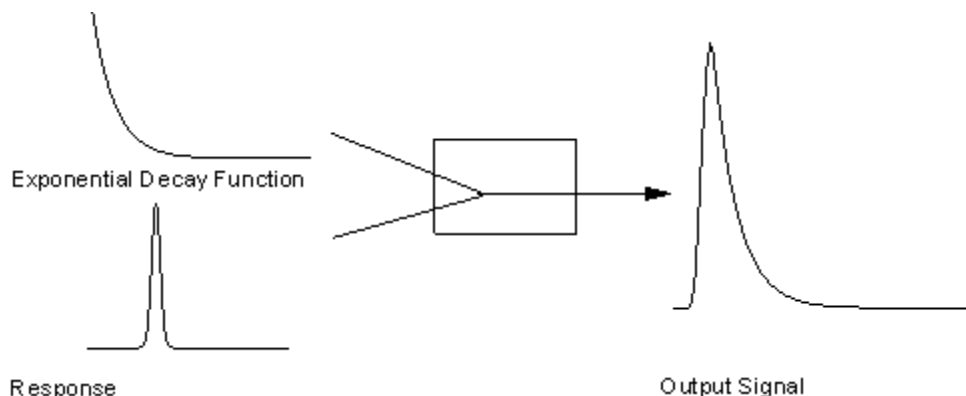

Now that we already have the output signal and response data, we can get the exponential decay function by fitting the signal with the below model:

$$y = y_0 + \int_{-\infty}^{+\infty} A e^{-tx} \otimes Response, dx$$

#### Define the Function

Obviously, column 1 and column 2 are x and y respectively in the function. How about column 3, the impulse response? We will access this column within the fitting function, and compute the theoretical exponential curve from the sampling points. Then we can use fast Fourier transform to perform the convolution.

Press **F9** to open the **Fitting Function Organizer** and define a function like:

**Function Name:** FitConv  
**Function Type:** User-Defined  
**Independent Variables:** x  
**Dependent Variables:** y  
**Parameter Names:** y0, A, t  
**Function Form:** Origin C  
**Function:**

Click the button (icon) beside the **Function** box and write the function body in **Code Builder**:

```
#pragma warning(error : 15618)

#include <origin.h>

// Header files need to be included

#include <ONLSF.H>

#include <fft_utils.h>

//

//

void _nlsfFitConv(

// Fit Parameter(s):

double y0, double A, double t,

// Independent Variable(s):
```

```

double x,

// Dependent Variable(s):

double& y)

{

    // Beginning of editable part

    NLFitContext *pCtxt = Project.GetNLFitContext();

    Worksheet wks;

    DataRange dr;

    int c1,c2;

    dr = pCtxt->GetSourceDataRange(); //Get the source data range

    dr.GetRange(wks, c1, c2); //Get the source data worksheet

    if ( pCtxt )

    {

        // Vector for the output signal in each iteration.

        static vector vSignal;

        // If parameters were updated, we will recalculate the convolution
result.

        BOOL bIsNewParamValues = pCtxt->IsNewParamValues();

        if ( bIsNewParamValues )

        {

            // Read sampling and response data from worksheet.

            Dataset dsSampling(wks, 0);

```



```
Dataset dsResponse(wks, 2);

int iSize = dsSampling.GetSize();

vector vResponse, vSample;

vResponse = dsResponse;

vSample = dsSampling;

vSignal.SetSize(iSize);

vResponse.SetSize(iSize);

vSample.SetSize(iSize);

// Compute the exponential decay curve

vSignal = A * exp( -t*vSample );

// Perform convolution

int iRet = fft_fft_convolution(iSize, vSignal, vResponse);

//Correct the convolution by multiplying the sampling
interval

vSignal = (vSample[1]-vSample[0])*vSignal;

}
```

```

        NLSFCURRINFO    stCurrInfo;

        pCtxt->GetFitCurrInfo(&stCurrInfo);

        // Get the data index for the iteration

        int nCurrentIndex = stCurrInfo.nCurrDataIndex;

        // Get the evaluated y value

        y = vSignal[nCurrentIndex] + y0;

        // For compile the function, since we haven't use x here.

        x;

    }

    // End of editable part
}

```

Traditionally, for a particular  $x$ , the function will return the corresponding  $y$  value. However, when convolution is involved, we need to perform the operation on the entire curve, not only for a particular data point. So, from Origin 8 SR2, we introduced the [NLFitContext class](#) to achieve some key information within the fitter. In each iteration, we use NLFitContext to monitor the fitted parameters; once they are updated, we will compute the convolution using the fast Fourier transform by the [fft\\_fft\\_convolution](#) method. The results are saved in the vSignal vector. Then for each  $x$ , we can get the evaluated  $y$  from vSignal with the current data index in NLSFCURRINFO.

#### Fit the Curve

In the fitting function body, we read the response data directly from the active worksheet. So, you should perform the fit from the worksheet.

1. Highlight column B and press **Ctrl + Y** to bring up the **Nonlinear Fitting** dialog.
2. Choose *X Data Type* from *Fitted Curves* page as **Same as Input Data**.
3. Go back to the Function Selection page to select the *FitConv* function you just defined.
4. Go to the Parameter tab to initialize the parameters as  $y_0=0$ ,  $A=10$ ,  $t=1$ .
5. Click the **Fit** button to generate the results.

If you use a fitting function similar to this tutorial, please note when you run **NLFit** in Origin, in **NLFit** dialog, choose **X Data Type** from **Fitted Curves** page as **Same as Input Data**.

#### 4.3.3.20 Quoting Built-in Functions in Your New Function

#### 4.3.3.20.1 Summary

This tutorial will show you how to reference a built-in function when creating a user-defined fitting function.

Minimum Origin Version Required: Origin 8.0 SR6

#### 4.3.3.20.2 What you will learn

This tutorial will show you how to:

- Define a piecewise fitting function
- Access built-in functions in you new function
- Auto initialize the parameters

#### 4.3.3.20.3 Steps

##### Data

Start by importing the file `\Samples\Curve Fitting\Asymmetric Gaussian.dat` into a new workbook.

Highlight column B and create a graph. The peak in the data is slightly skewed to the right. How to fit such a curve? One idea is to divide the curve into two parts - We can consider this curve to be composed of two Gaussian function as below. These two Gaussian curves share the same baseline and peak center, but differ in peak width and amplitude.

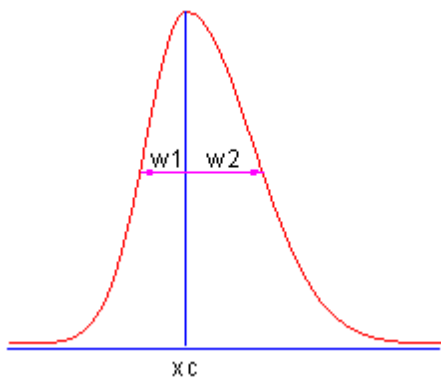

##### Define the Function

Press **F9** to open the **Fitting Function Organizer** and define the function as below:

<b>Function Name:</b>	AsymmetricGauss
<b>Function Type:</b>	User-Defined
<b>Independent Variables:</b>	x
<b>Dependent Variables:</b>	y

<b>Parameter Names:</b>	y0, xc, w1, w2, A1, A2
<b>Function Form:</b>	<a href="#">Origin C</a>
<b>Function:</b>	y = x<xc? nlf_Gauss(x, y0, xc, w1, A1) : nlf_Gauss(x, y0, xc, w2, A2);

**Note:**

For versions before **Origin 8.1**, the function body should be defined as:

```
y = x<xc? nlfxGauss(x, y0, xc, w1, A1) : nlfxGauss(x, y0, xc, w2, A2);

x; y0; xc; w1; w2; A1; A2;
```

Listing the parameters at the end is used to avoid the "parameter not used inside the function body" error, although you already use these parameters. This is required to compile the function successfully.

When calling **nlf\_FuncName** to reuse built-in functions, the syntax is:

```
nlf_FuncName( independent variable, parameter list ... )
```

where **FuncName** is the fitting function name. Besides, the old notation, **nlfxFuncName** also supported.

The *Parameter List* follows the parameter order in function definition file for the built-in function (the FDF file. You can open the FDF file in Notepad. The files are located in the \\Origin EXE Folder\FitFunc\). Note that, the function name we use is the DLL interface name. The actual name in the [General Information] section of the FDF file. Look at the *Function Source* item and the value is **fgroup.FuncName**, and use the *FuncName*. In most cases, this function name is consistent with the function name visible in the NLFit dialog. For a few functions such as Voigt, these names are different.

For parameter initialization of this skewed gaussian function, we can simply copy the initialization code of the built-in gauss function, and make a few minor modifications:

```
xc = peak_pos(x_y_curve, &w1, &y0, &A1);

w2 = w1;

A2 = A1;
```

The final function body should be as below:

**Function Name**

**File Name(.FDF)**

**Brief Description**

**References**

**Function Type**

**Function Model**

**Independent Variables**

**Dependent Variables**

**Parameter Names**

**Function Form**

**Treat All Numbers As Double**

**Derivatives**

**Function**

**Peak Function**

**Parameter Settings**

**Enable Auto Initialization**

**Use OriginC**

**Parameter Initialization**

Once compiled successfully, save the function and fit the curve. The results should be as below:

		Value	Standard Error
Amplitude 1	y0	1.80002	4.79492E-5
	xc	4.50001	3.44845E-5
	w1	1.80003	4.49861E-5
	w2	2.99998	4.87666E-5
	A1	30	0.00103
	A2	49.99962	0.00111

#### 4.3.3.21 Fit Function with Non-constant Background

##### 4.3.3.21.1 Summary

Many of the Origin built-in functions are defined as:

$$y = y_0 + \dots$$

Where  $y_0$  can be treated as the "constant background". How about fitting a curve with a non-constant background? One option is to use the Peak Analyzer we provide. The Peak Analyzer includes multiple methods to subtract the baseline, including exponential or polynomial backgrounds. In this tutorial, we will show you how to fit such curves without using the Peak Analyzer.

Minimum Origin Version Required: Origin 8.0 SR6

##### 4.3.3.21.2 What you will learn

- Review [Worksheet Query](#).
- Quote a built-in function by `nfxFuncName` method.
- Auto Initialize the parameters.

##### 4.3.3.21.3 Example and Steps

###### Prepare the Data

Let's start this tutorial by importing `\Samples\Spectroscopy\Peaks on Exponential Baseline.dat`. From the worksheet sparkline, we can see that there are two peaks in the curve. To simplify the problem, we will fit just one peak in this example.

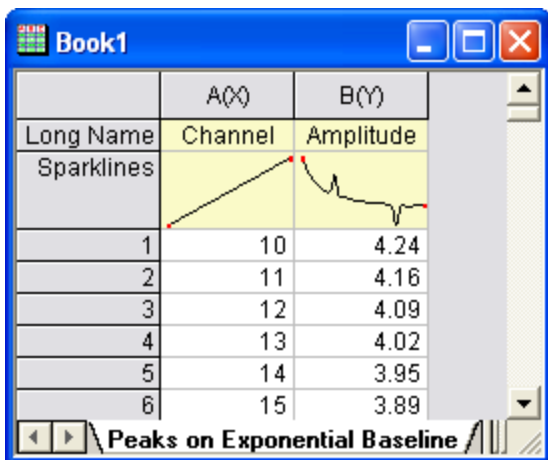

Now bring up the [Worksheet Query dialog](#) from **Worksheet : Worksheet Query**. And we will extract data from row 1 to row 240:

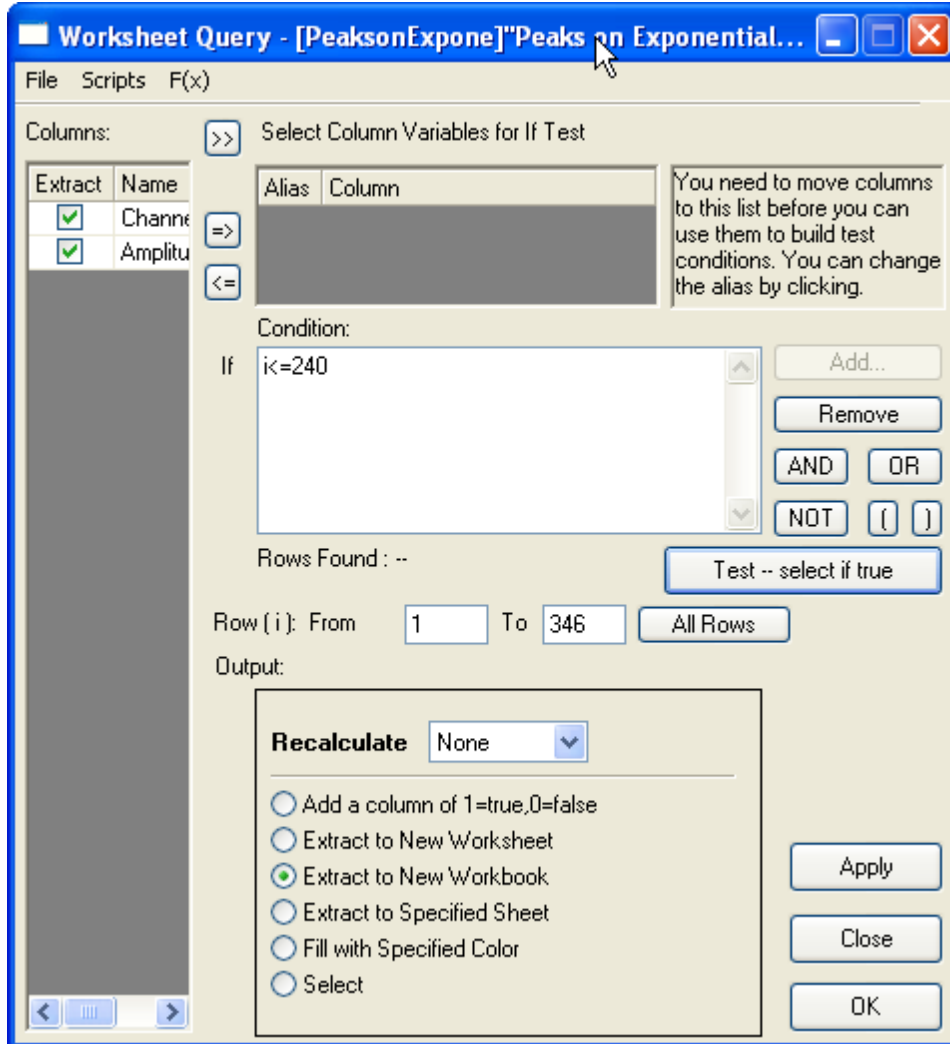

So the curve we will fit should look like this:

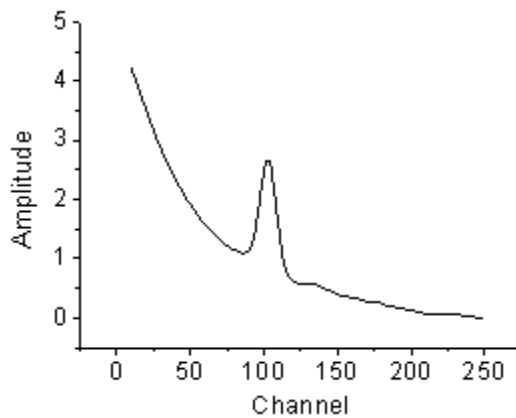

**Define the Function**

As illustrated below, we can consider the source curve is the combination of an exponential decay component (the background) with a Voigt peak:

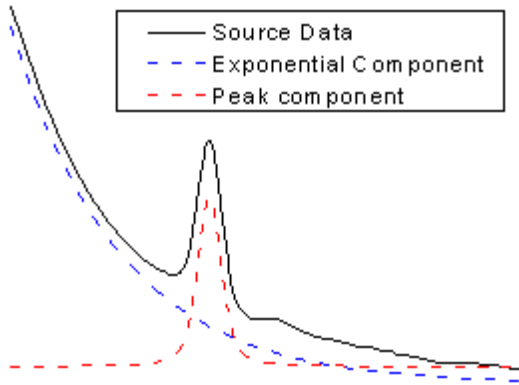

So should we write down the whole equation to define the function? Like:

$$y = y_0 + A_1 e^{-x/t_1} + A_2 \frac{2w_L \ln 2}{\pi^{3/2} w_G^2} \int_{-\infty}^{\infty} \frac{e^{-t^2}}{\left(\sqrt{\ln 2} \frac{w_L}{w_G}\right)^2 + \left(\sqrt{4 \ln 2} \frac{x-x_c}{w_G} - t\right)^2} dt$$

Well, this is a complicated equation and it includes infinite integration. Writing such an equation directly is painful. Now that we already have these two built-in functions:

ExpDec1:

$$y = y_0 + A e^{-x/t}$$

Voigt:

$$y = y_0 + A \frac{2w_L \ln 2}{\pi^{3/2} w_G^2} \int_{-\infty}^{\infty} \frac{e^{-t^2}}{\left(\sqrt{\ln 2} \frac{w_L}{w_G}\right)^2 + \left(\sqrt{4 \ln 2} \frac{x-x_c}{w_G} - t\right)^2} dt$$

we can simply use the **nlfxFuncName** method to quote these two built-in functions and create a new one. Press **F9** to open the **Fitting Function Organizer** and define a function as below:

<b>Function Name:</b>	ExpVoigt
<b>Function Type:</b>	User-Defined
<b>Independent Variables:</b>	x
<b>Dependent Variables:</b>	y
<b>Parameter Names:</b>	y0, A1, t1, xc, A2, wG, wL



<b>Function Form:</b>	<a href="#">Origin C</a>
<b>Function:</b>	$y = \text{nlf\_ExpDec1}(x, y0, A1, t1) + \text{nlf\_Voigt}(x, y0, xc, A2, wG, wL) - y0;$

**Note:**

1. Some of the built-in function names do not consistent with the actual DLL function name. Just like this Voigt function, it's defined in Voigt5.FDF, and if you open the FDF file by Notepad, you can see a line under [GENERAL INFORMATION] section says:

Function Source=fgroup.Voigt5

The name after "fgroup" is the actual name we should put into **nlf\_FuncName**.

2. Besides, for versions before **Origin 8.1 SR2**, the function body should use old *nlfxFuncName* notation and define as:

```
y = nlfxExpDec1(x, y0, A1, t1) + nlfxVoigt(x, y0, xc, A2, wG, wL)
- y0;

x; xc; A1; t1; A2; wG; wL;
```

Listing the parameters at the end is done to avoid the "parameter not used inside the function body" error, although you already use these parameters. If not, you will not compile the function successfully.



Click the  button on the right of the **Parameter Settings** and enter these parameter initial values:

<b>y0:</b>	0
<b>A1:</b>	5
<b>t1:</b>	50
<b>xc:</b>	100
<b>A2:</b>	50

<b>wG:</b>	10
<b>wL:</b>	10

So the final function definition part should look like:

**Function Type** User-Defined

**Function Model** Explicit

**Independent Variables** x

**Dependent Variables** y

**Parameter Names** y0,A1,t1,xc,A2,wG,wL

**Function Form** Origin C

**Treat All Numbers As Double**

**Derivatives**

**Function**

```
= nlf_ExpDec1(x, y0, A1, t1) + nlf_Voigt(x, y0, xc, A2, wG, wL) - y0;
```

**Peak Function**

**Parameter Settings**

```
InitialValues = 0(V),5(V),50(V),100(V),50(V),10(V),10(V)
Meanings = ?,?,?,?,?,?
LowerBounds = -(l, Off),-(l, Off),-(l, Off),-(l, Off),-(l, Off),-(l, Off),-(l, Off),-(l, Off)
UpperBounds = -(l, Off),-(l, Off),-(l, Off),-(l, Off),-(l, Off),-(l, Off),-(l, Off),-(l, Off)
NamingMethod = User-Defined
NumberOfSignificantDigits = 0,0,0,0,0,0,0
Unit = .....
Format = .....
CustomDisplay = .....
```

#### Auto Parameter Initialization

In the above section, we set fixed parameter initial values. If you know the possible fitted results, you can set the initial values in this way. But how about when the data is changed? Origin provides an Origin C interface to "guess" the initial values. To use the parameter initialization code, make sure to check the **Enable Auto**

**Initialization** and **Use OriginC** checkboxes, and edit the code in Code Builder by clicking the  icon. (P.S: If you know the initial values very well, or you don't like coding, please skip this section.)

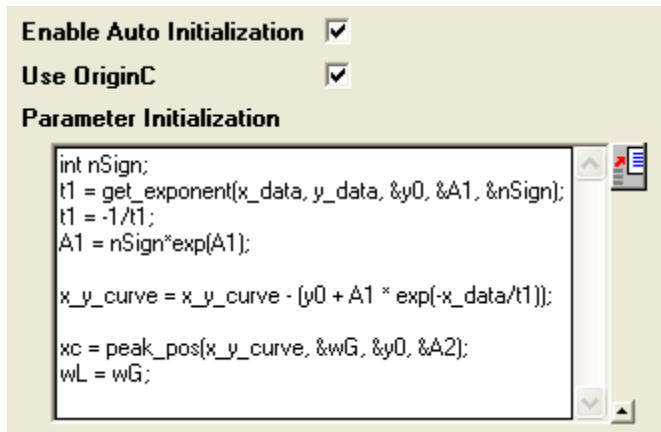

Now that the curve is composed by two components, we can guess the parameter values by separating these two parts, the initialization code includes:

1. Use the [get\\_exponent](#) function to fit the curve and get the parameter values for exponential component.
2. Remove the background -- exponential component -- from source data.
3. Approaching the peak by Gaussian peak using [peak\\_pos](#) function and set the initial values for peak component

So, the initialization code in Code Builder should look like this:

```

void _nlsfParamExpVoigt(

// Fit Parameter(s):

double& y0, double& A1, double& t1, double& xc, double& A2, double& wG, double& wL,

// Independent Dataset(s):

vector& x_data,

// Dependent Dataset(s):

vector& y_data,

// Curve(s):

Curve x_y_curve,

// Auxiliary error code:

int& nErr)

```

```

{

    // Beginning of editable part

    int nSign;

    // Evaluates the parameters' value, y0, ln(A) and R for y = y0+A*exp(R*x).

    t1 = get_exponent(x_data, y_data, &y0, &A1, &nSign);

    // Set the exponential component values for the fitting function.

    t1 = -1/t1;

    A1 = nSign*exp(A1);

    // Remove the exponential component from the curve;

    x_y_curve = x_y_curve - (y0 + A1 * exp(-x_data/t1));

    // Fit to get peak values.

    xc = peak_pos(x_y_curve, &wG, &y0, &A2);

    wL = wG;

    // End of editable part

}

```

**Note:**

When you check the **Enable Auto Initialization** and enter the initialization code, this code will cover the initial values in **Parameter Settings**.

**Fit the Curve**

No matter what kind of parameter initialization method you used, highlight column B and press **Ctrl + Y** to bring up the NLFit dialog, select the ExpVoigt function and fit. The result should be:

		Value	Standard Error
Amplitude	y0	0.04862	0.00724
	A1	5.08842	0.02599
	t1	50.67096	0.51939
	xc	102.81043	0.07241
	A2	32.91106	0.92012
	wG	9.65255	0.67731
	wL	5.7529	0.81022

#### 4.3.3.22 Fitting with Piecewise Functions

##### 4.3.3.22.1 Summary

We will show you how to define piecewise fitting function in this tutorial.

Minimum Origin Version Required: Origin 8.0 SR6

##### 4.3.3.22.2 What you will learn

This tutorial will show you how to:

- Define piecewise (conditional) fitting functions.

##### 4.3.3.22.3 Example and Steps

We can start this tutorial by importing the sample `\Samples\Curve Fitting\Exponential Decay.dat` data file. Highlight column D and plot a Scatter Graph. You can fit this curve using built-in functions under Growth/Sigmoidal category, however, in this tutorial, we will separate the curve into two parts by a piecewise function.

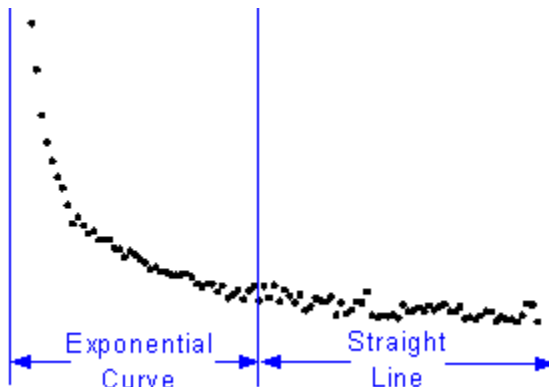

So the equation will be:

$$y = \begin{cases} a + bx + e^{-\frac{x-x_c}{t1}}, & \text{if } x < x_c \\ a + bx, & \text{if } x \geq x_c \end{cases}$$

##### Define the Function

Press **F9** to open the **Fitting Function Organizer** and define a function like:

<b>Function Name:</b>	piecewise
<b>Function Type:</b>	User-Defined
<b>Independent Variables:</b>	x
<b>Dependent Variables:</b>	y
<b>Parameter Names:</b>	xc, a, b, t1
<b>Function Form:</b>	<a href="#">Origin C</a>
<b>Function:</b>	

Click the  button on the right of the **Function** edit box and define the fitting function in Code Builder using:

```
void _nlsfpiecewise(
// Fit Parameter(s):
double xc, double a, double b, double t1,
// Independent Variable(s):
double x,
// Dependent Variable(s):
double& y)
{
    // Beginning of editable part
    // Divide the curve by if condition.
    if(x<xc) {
```

```

        y = a+b*x+exp(-(x-xc)/t1);

    } else {

        y = a+b*x;

    }

    // End of editable part

}

```

**Fit the Curve**

Press **Ctrl + Y** to bring up NLFit dialog with the graph window active. Select the *piecewise* function we defined and initialize the parameter values:

<b>xc:</b>	1
<b>a:</b>	1
<b>b:</b>	-1
<b>t1:</b>	0.1

Click **Fit** button to generate the results:

<b>xc:</b>	0.24
<b>a:</b>	36.76585
<b>b:</b>	-24.62876
<b>t1:</b>	0.04961

Note that this function is sensitive to *xc* and *t1*, different initial values could generate different results.

#### 4.3.3.23 Fit Curve Through Certain Points

##### 4.3.3.23.1 **Summary**

This tutorial shows you three methods to force a fit curve to go thru a particular point. Choice of method depends on function expression and the data point you want the fit curve to go through.

#### 4.3.3.23.2 What you will learn

- Learn different methods to force a curve to go through a point.
- Fix fitting parameters during nonlinear fitting.
- Use general linear constraints in nonlinear fitting.
- Fit with weights.

#### 4.3.3.23.3 Example and Steps

##### Fixing Function Parameters

This method works only when the point you want to fit through is related to a function parameter. One typical example: force the fitted line to go through the origin point, (0, 0), when fitting a straight line,  $y = a + b * x$ . In this particular case we know that if we let  $a = 0$ , the line will go through (0,0).

1. Import the data "*\Samples\Curve Fitting\Linear Fit.dat*" into an Origin worksheet.
2. Highlight one of the Y column, column D for example, and select **Analysis: Fitting: Nonlinear Curve Fit** to bring up the **NLFit** dialog.
3. Choose the **Line** function after selecting the **Polynomial** category.
4. Click the **Fitted Curves** page on **Settings** tab. Under the **X Data Type** branch, make sure the **Range** option is **Use Input Data Range + Margin**, and then enter **10** in the **Range Margin(%)** edit box. This option will lengthen the fitted curve.
5. Click the **Fit until converged** button . You can see from the **Fit Curve** tab that the curve does not go through the origin point.



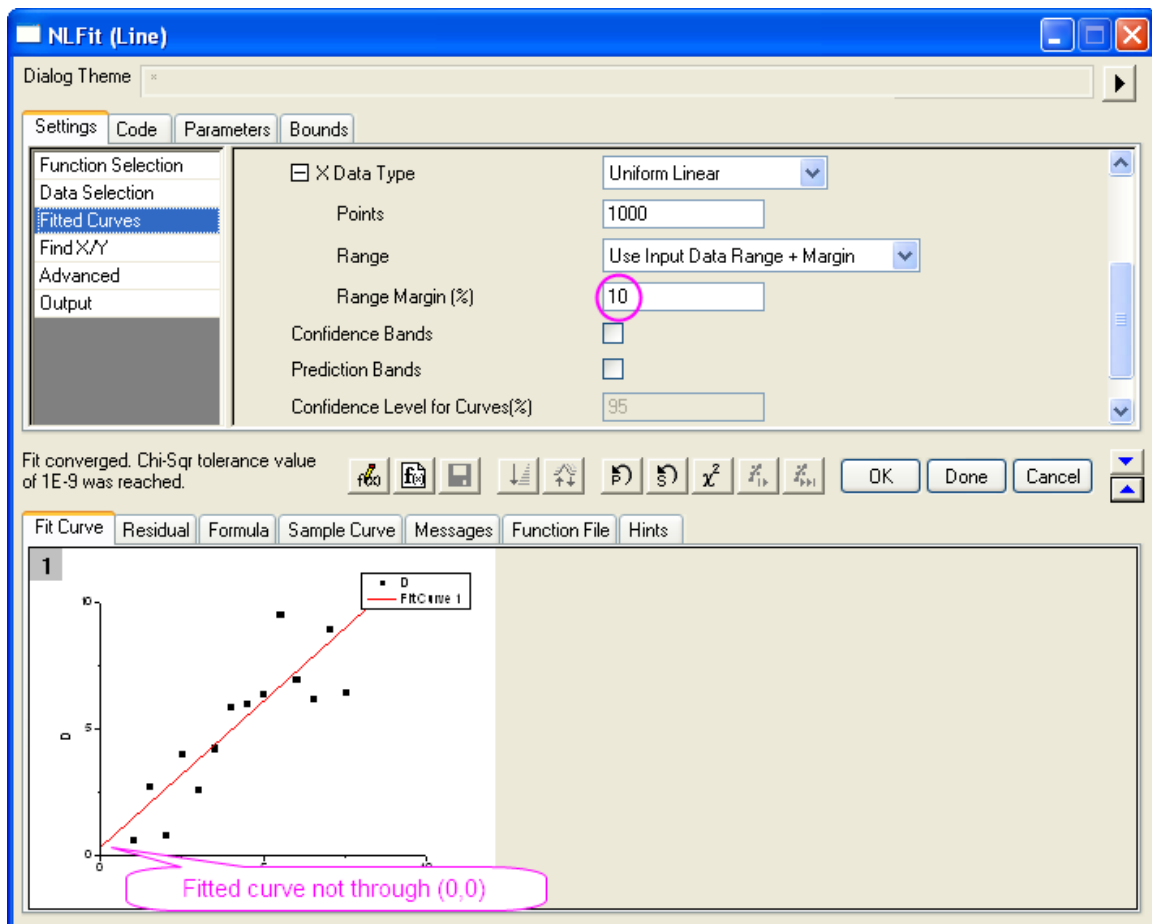

- Now go to the **Parameters** tab, check the **Fixed** checkbox for parameter **A** and fix the value to **0**. Click the **Fit until converged** to fit the curve again. Now you can see the curve go through zero.

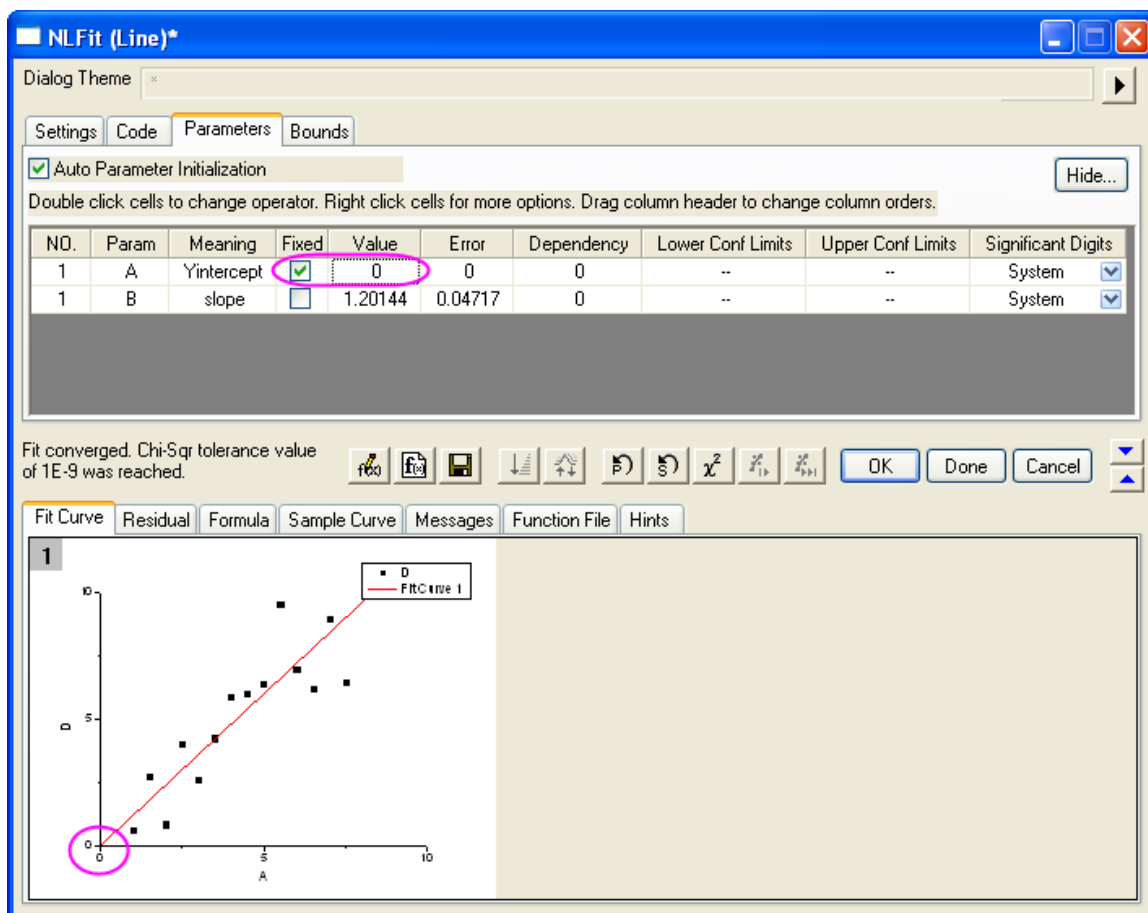

**Note:** You can also use the **Fix Intercept** option in the **Linear Fit** dialog to force the linear fitted line to go through the origin point.

#### Use Linear Constraint

This method works when the fitting function is based on a LINEAR model, such as **Line**, **Parabola**, or **Cubic**, etc.

We will show you how to force the fitted curve to go through a particular point by using linear constraint:

1. Import the data "*\Samples\Curve Fitting\Polynomial Fit.dat*" into Origin worksheet.
2. Highlight column B and press **Ctrl + Y** to bring up the **NLFit** dialog.
3. Select **Parabola** ( $y = A + B * x + C * x^2$ ) from the **Polynomial** category. From the **Fit Curve** tab, we can see the initial value already fits the data very well.
4. Suppose we want to force the curve through  $(10, 100)$ . Substitute  $(10, 100)$  to the fitting function ( $y = A + B * x + C * x^2$ ). we then have  $100 = A + 10 * B + 100 * C$ . We can use this equation as a general linear constraint condition. Select the **Constraints** page on **Code** tab. Check the **Enable Linear Constraints** checkbox, and enter the following expression into the edit box.

$$A + 10*B + 100*C = 100$$

5. Click the **Fit until converged** button . We can see the fitted curve deviates from the data points, but it goes through the specified point.

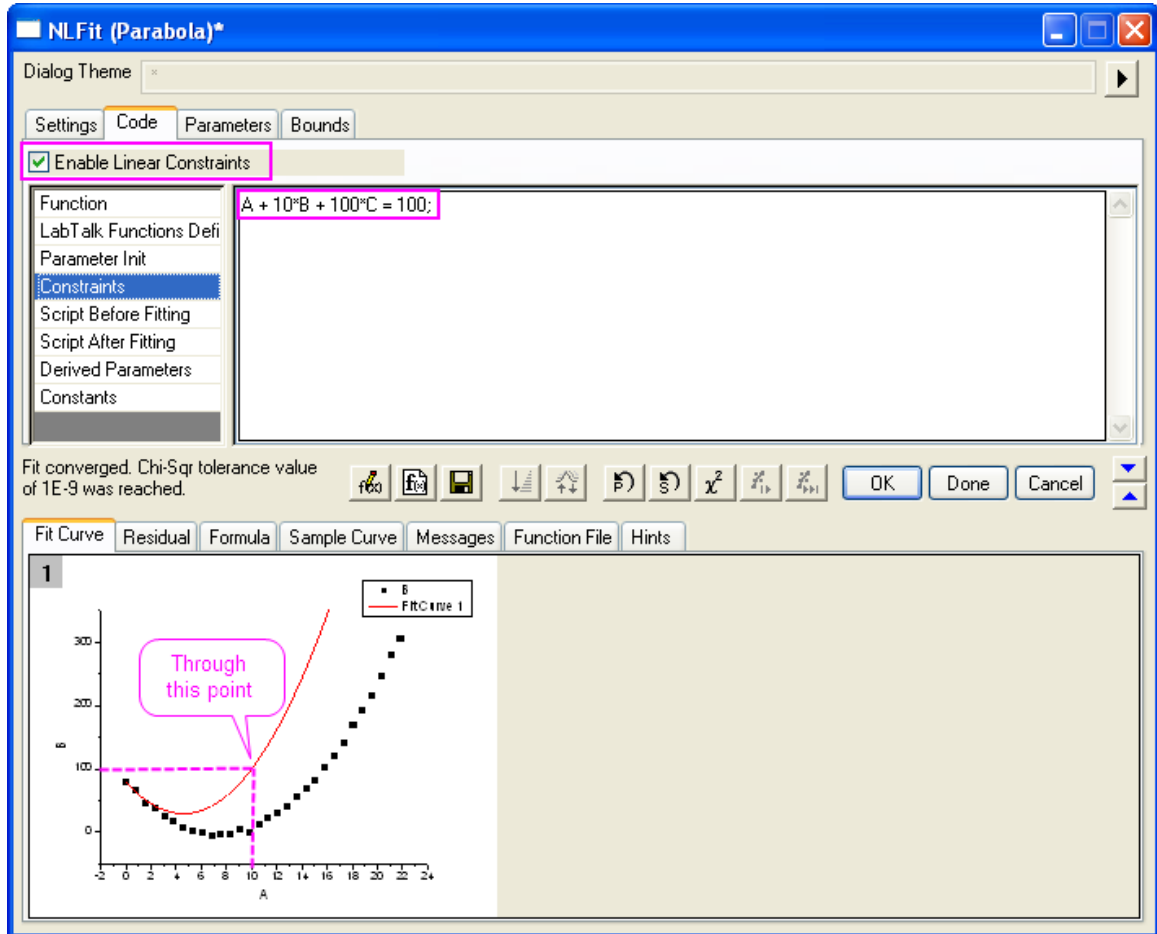

### Use weighting

If the parameters are some eigenvalues such as upper or lower asymptotes, and your raw data includes the points you want to fit through, you can fit the curve by assigning larger weights to these particular points. This is not an analytical solution, but you can assign larger weights to reduce the error:

1. Prepare data by running the following script:



```

newbook;

string fname$ = system.path.program$;

fname$ += "Samples\Curve Fitting\Replicate Response Data.dat";

impasc fname$ options.PartImp.Partial:=1 options.PartImp.LastCol:=2;

wks.addcol();

col(a) = log(col(a)) + 5;

col(c)[1] = 100;

for(int ii = 2; ii < wks.maxrows; ii++)

{

    col(c)[ii] = 1;

}

col(c)[wks.maxrows] = 100;

```

2. First, let's see how the fitted curve looks when there is no weighting. Highlight column B and bring up NLFit dialog from **Analysis: Fitting: Nonlinear Curve Fit**. Select the **Logistic** function from **Growth/Sigmoidal** category. Then click the **Fit until converged** button . From the **Fit Curve** tab, we can see the curve does not go through any points near the top.

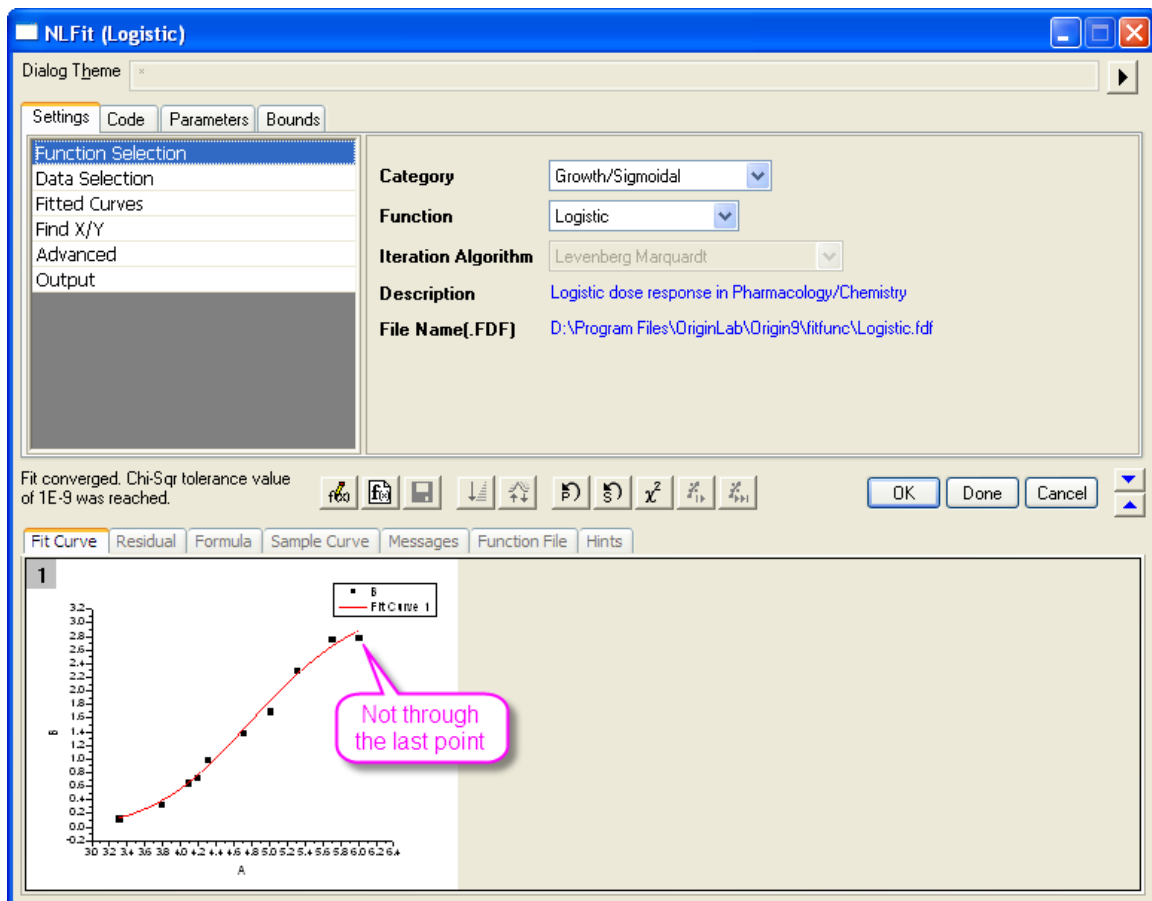

- Note that in the raw data worksheet, we have prepared column C and assigned large values for the first and last data points. If we use this column as weights, these two points will contribute more impact on the fitted curve and hence force the curve to go through these two points.

	A(X)	B(Y)	C(Y)
Long Name			
1	3.30103	0.13136	100
2	3.77815	0.34384	1
3	4.07918	0.6554	1
4	4.17609	0.73699	1
5	4.30103	1.00157	1
6	4.69897	1.39062	1
7	5	1.70785	1
8	5.30103	2.31437	1
9	5.69897	2.77326	1
10	6	2.79321	100

Now, activate the **Data Selection** page on the **Settings** tab. Expand the **Input Data** branch as below to

expose the weighting option. Choose the **Direct Weighting** method and assign column **C** as the weighting dataset. Then click the **Fit until converged** button .

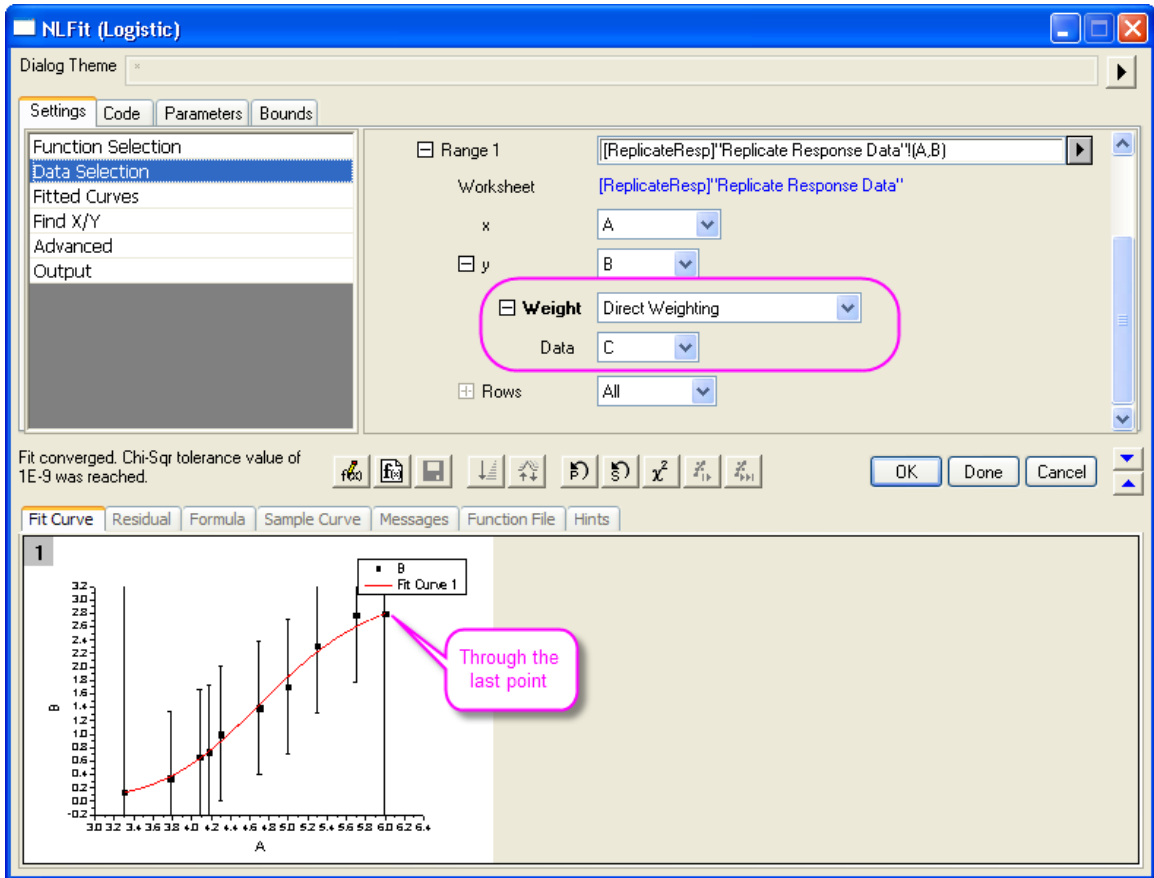

From the preview result, we can see that the fitted curve goes through the first and last data points.

#### 4.3.3.24 Distribution Fit with the Probability Density Function and Cumulative Distribution Function

##### 4.3.3.24.1 Summary

To know the location or scale parameters of a sample distribution, one can [perform distribution fit](#) on the data. However, you can also fit a probability density function or cumulative distribution function on the binned data to get these values. This tutorial shows you how to estimate these parameters by curve fitting.

Minimum Origin Version Required: Origin 2016 SR2

##### 4.3.3.24.2 What you will learn

- Generating Normally Distributed Data for Fitting
- Fitting with Probability Density Function (PDF)
- Fitting with Cumulative Distribution Function (CDF)

#### 4.3.3.24.3 Example and Steps

##### Generating Normally Distributed Data for Fitting

1. Run the following script to create sample dataset

```
newbook;

col(2) = normal(1000) * 2 + 5;
```

This script generates 1000 normally distributed points where  $mean \approx 5$  and  $\sigma \approx 2$ .

2. We can first perform simple descriptive statistics on this column to see the corresponding *Moments* output.

Highlight the data column and select **Statistics: Descriptive Statistics: Statistics on Column** to open the dialog. Select **Quantities** tab, then make sure the **Mean** and **Standard Deviation** checkboxes are selected. And the click **OK** to generate report.

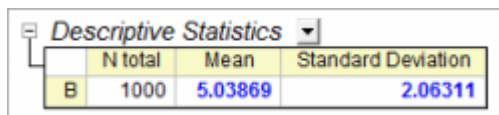

	N total	Mean	Standard Deviation
B	1000	5.03869	2.06311

From the report worksheet, we can see the Mean and Standard Deviation are very close to the value we just set.

##### Fitting with Probability Density Function (PDF)

1. To fit the data with the PDF, we should calculate the binned data with **Frequency Counts** tool first. Highlight the source data column and select **Statistics: Descriptive Statistics: Frequency Counts** from menu. This dialog will count the number of data points on specified bins.
  - Expand the **Computation Control** branch, and make sure **Bin Size** radio button is selected beside **Step by**. Set the **Bin Size** to  $0.5$  (you'll have to clear the **Auto** check box).
  - Make sure the **Bin Center**, **Count** and **Cumulative Count** check boxes under **Quantities to Compute** branch are selected. Then click **OK** to count the data.
2. Highlight the *Count* column on the Frequency Counts result worksheet, select **Plot>2D: Bar: Column** to create a column graph. Now we have the histogram of the source data.
3. With the graph active, select menu **Analysis: Fitting: Nonlinear Curve menu** to open the **NLFit** dialog. Then select the **Gauss** function from the **Statistics** category. Leave other options as defaults and click the **Fit** button directly to output fitting report.

**Parameters**

		Value	Standard Error	t-Value	Prob> t	Dependency
Count	y0	3.0748	2.43769	1.26136	0.23581	0.72827
	xc	5.06021	0.03539	142.9789	6.87713E-18	4.21494E-8
	w	3.85483	0.09718	39.6656	2.47941E-12	0.64633
	A	957.18458	29.19989	32.78042	1.64633E-11	0.81885
	sigma	1.92741	0.04859			
	FWHM	4.53871	0.11442			
	Height	198.12122	3.59688			

Reduced Chi-sqr = 22.6059496582  
 COD(R<sup>2</sup>) = 0.99671948929079  
 Iterations Performed = 6  
 Total Iterations in Session = 6  
 Fit converged. Chi-Sqr tolerance value of 1E-9 was reached.  
 Standard Error was scaled with square root of reduced Chi-Sqr.  
 sigma, FWHM, Height are derived parameter(s).

From the fitting report, we can see that the fitted *xc* and *sigma* are close to 5 and 2.

**Fitting with Cumulative Distribution Function (CDF)**

- To fit the data with the CDF, we should start from the cumulative binned data. Select the **FreqCounts1** sheet from the previous section. Highlight the *Cumulative Count* column. Select menu **Plot>2D: Scatter: Scatter** to plot the CDF points.
- With the graph active, select menu **Analysis: Fitting: Nonlinear Curve Fit** to open the **NLFit** dialog. Select the **NormalCDF** function from the **Statistics** category. Leave other options as defaults and click the **Fit** button directly to output fitting report.

**Parameters**

		Value	Standard Error	t-Value	Prob> t	Dependency
Cumulative Count	y0	-0.16051	2.6327	-0.06097	0.95258	0.81992
	A	997.35111	3.74698	266.17464	1.37769E-20	0.80301
	xc	4.56388	0.01581	288.58432	6.13952E-21	0.50656
	w	1.98179	0.02161	91.70031	5.82139E-16	0.47152

Reduced Chi-sqr = 17.4739968996  
 COD(R<sup>2</sup>) = 0.9999258384619  
 Iterations Performed = 4  
 Total Iterations in Session = 4  
 Fit converged. Chi-Sqr tolerance value of 1E-9 was reached.  
 Standard Error was scaled with square root of reduced Chi-Sqr.

From the fitting report, we can see that the fitted *xc* and *w* are close to 5 and 2.



After you got binned data from the **Frequency Counts** tool, you can also fit the binned data with your user-defined probability density function or cumulative distribution function. [View this page for defining and fitting with a user-defined function.](#)



#### 4.3.3.25 Fitting Integral Function with a Sharp Peak

##### 4.3.3.25.1 Summary

In this tutorial, we will show you how to define an integral fitting function with a sharp peak in the integral function, and perform a fit of the data using this fitting function.

Because the integral function contains a sharp peak, the integral should be performed in three segments so that the sharp peak can be integrated in a narrow interval.

Minimum Origin Version Required: Origin 9.0 SR0

##### 4.3.3.25.2 What you will learn

This tutorial will show you how to:

- Define an integral fitting function.
- Integrate a function with a sharp peak.
- Divide the integral interval into several segments.

##### 4.3.3.25.3 Example and Steps

###### Import Data

1. Open a new workbook.
2. Copy data in [Sample Data](#) to the workbook.
3. Highlight column B, and select **Plot: Symbol: Scatter** from Origin menu. The graph should look like:

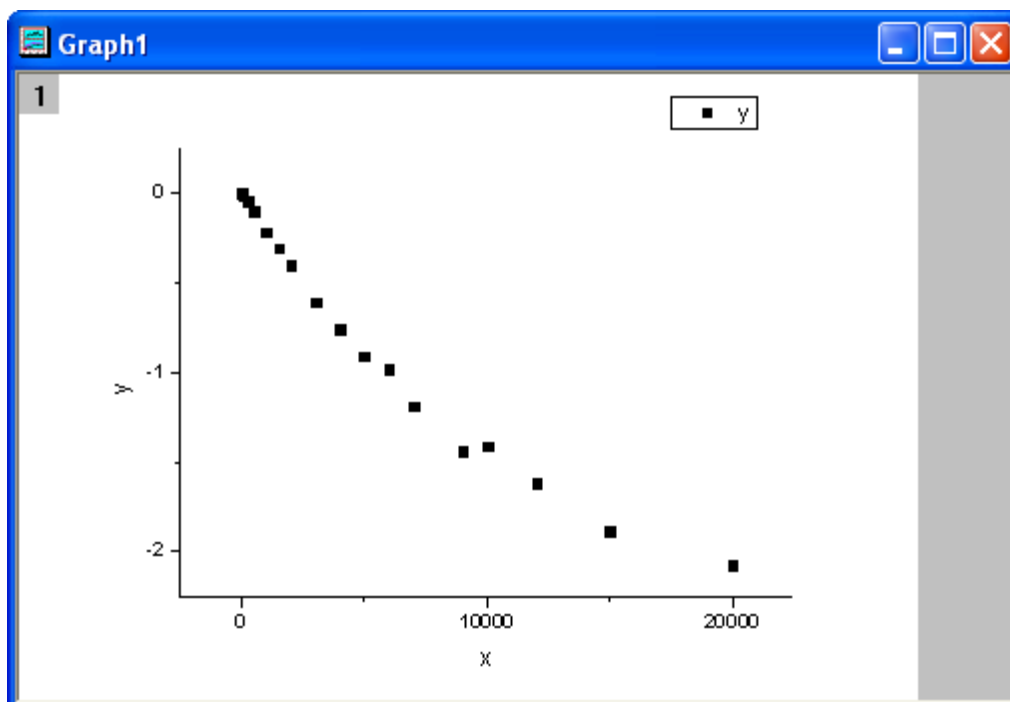

###### Define Fitting Function

The fitting integral function is described as follows:

$$y = \log\left(\int_0^1 \frac{1}{\sqrt{2\pi b}} e^{-\frac{(t-a)^2}{2b^2} - xt} dt\right)$$

where a and b are parameters in the fitting function.

Initial parameters are: a=1e-4, b=1e-4. Note that the integral function contains a peak whose center is about a and width is 2b. And the peak's width (2e-4) is very narrow compared with the integral interval [0,1]. To make sure it is integrated correctly at the neighborhood of the peak center, the integral interval [0,1] is divided into three segments: [0,a-5\*b], [a-5\*b,a+5\*b], [a+5\*b,1]. It is integrated in each segment, and then the three integrals are summed up.

The fitting function can be defined using the **Fitting Function Builder** tool.

1. Select **Tools: Fitting Function Builder** from Origin menu.
2. In the **Fitting Function Builder** dialog's **Goal** page, click **Next** button.
3. In the **Name and Type** page, select **User Defined** from **Select or create a Category** drop-down list, type **fitpeak** in the **Function Name** field, and select **Expression** in **Function Type** group, check **Include Integration During Fitting** check box. And click **Next** button.
4. In the **Integrand** page, type **myint** in **Integrand Name** edit box, **t** in **Integration Variable** edit box and **a, b, x** in **Arguments** edit box. Type the following script in **Integrand Function** box.

```
return 1/(sqrt(2*pi)*b)*exp(-(t-a)^2/(2*b^2)-x*t);
```

And click **Next** button.

5. In the **Variables and Parameters** page, type **a, b** in the **Parameters** field. Click **Next** button.
6. In the **Expression Function** page, click **Parameters** tab, and set **Initial Value** for parameters a and b to 1e-4, click **Integrand** tab, and set **Value** for **Lower Limit** and **Upper Limit** to 0 and 1, **Value** for **a, b, x** to a, b, x respectively.
7. In the **Expression Function** page, click **Insert** button. In the **Quick Check** group, type 0 in **x=** edit box, click **Evaluate** button, and it shows y=9.3e-21. This implies that the peak is not integrated correctly because y should approach 1 for x=0. Divide the integral into three segments, and type following script in **Function Body** box.

```
integral(myint, 0, a-5*b, a, b, x)+integral(myint, a-5*b, a+5*b, a, b, x)+
integral(myint, a+5*b, 1, a, b, x)
```

Click **Evaluate** button again, and it shows y=0.84, hence it is clear that the peak is integrated correctly this time.

8. In the **Expression Function** page, update the script in **Function Body** box as follows.

```
log(integral(myint, 0, a-5*b, a ,b ,x)+integral(myint, a-5*b, a+5*b, a ,b
,x)

+integral(myint, a+5*b, 1, a ,b ,x))
```

Click **Finish** button.

#### Fit the Curve

1. Select **Analysis: Fitting: Nonlinear Curve Fit** from Origin menu. In the **NLFit** dialog, select **Settings: Function Selection**, in the page select **User Defined** from the **Category** drop-down list and **finpeak** function from the **Function** drop-down list. **Note** that initial parameters have been set during defining the fitting function.
2. Click **Fit** button to fit the curve.

#### Fitting Results

The fitted curve should look like:

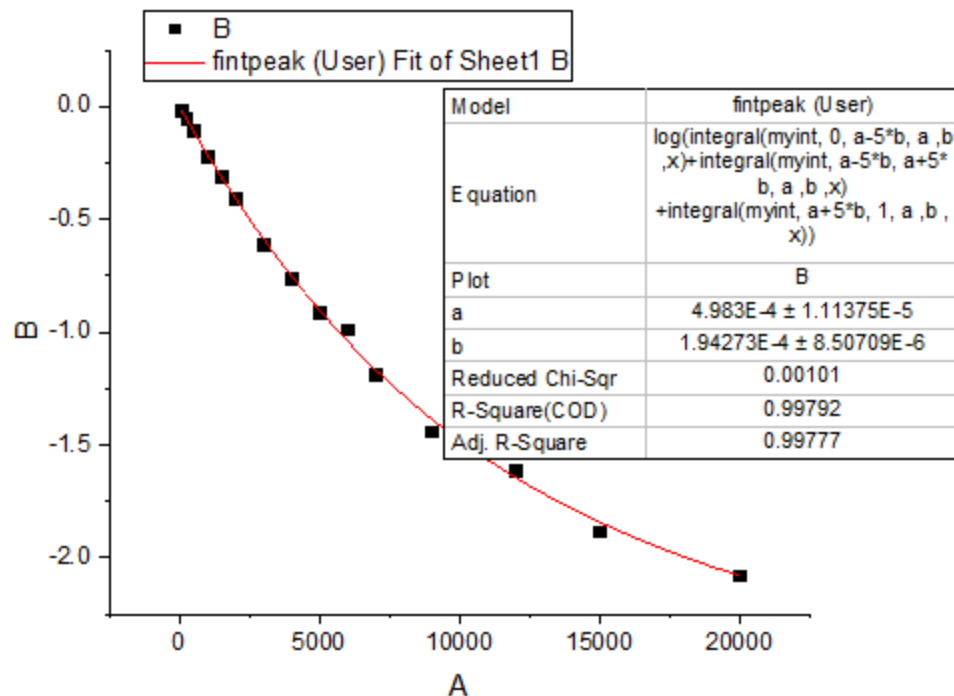

Fitted Parameters are shown as follows:

Parameter	Value	Standard Error
a	4.98302E-4	1.07593E-5
b	1.94275E-4	8.21815E-6

The **Adj. R-Square** is 0.99799. Thus the fitting result is very good.

#### Sample Data

x	y
0	-0.00267
60	-0.01561
240	-0.05268
500	-0.10462
1000	-0.22092
1500	-0.31004
2000	-0.40695
3000	-0.61328
4000	-0.75884
5000	-0.9127
6000	-0.98605
7000	-1.18957
9000	-1.43831

10000	-1.41393
12000	-1.61458
15000	-1.88098
20000	-2.07792

#### 4.3.3.26 Fitting with a Piecewise Linear Function

##### 4.3.3.26.1 Summary

In this tutorial we will show you how to define a piecewise fitting function consisting of two linear segments, perform a fit of the data using this fitting function, and calculate the intersection location for two linear segments from the fitting result.

Minimum Origin Version Required: Origin 8.6 SR0

##### 4.3.3.26.2 What you will learn

This tutorial will show you how to:

- Define a piecewise (conditional) fitting function.
- Auto initialize parameters.
- Calculate the intersection location of the piecewise fit lines.

##### 4.3.3.26.3 Example and Steps

###### Import Data

1. Open a new workbook.
2. Click the **Import Single ASCII** button  to bring up the Open dialog. Browse to **\Samples\Curve Fitting** folder and select the file **Step01.dat**.
3. Right click on the **Sensor E x** column (column J), and select **Set As: X** from the context menu. Highlight **Sensor E y** column, and select **Plot: Symbol: Scatter** from Origin menu. The graph should look like:

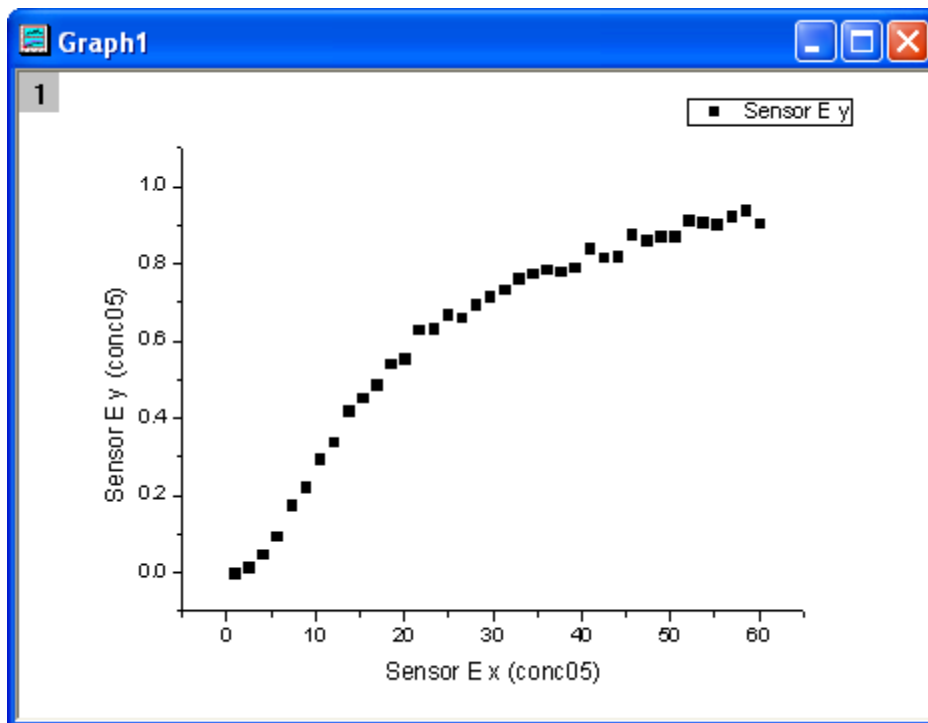

#### Define Fitting Function

From the above graph, the curve consists of two segments of lines. It can be fitted with a piecewise linear function. The function can be expressed as:

$$y = \begin{cases} \frac{y_1(x_3 - x) + y_3(x - x_1)}{x_3 - x_1}, & \text{if } x < x_3 \\ \frac{y_3(x_2 - x) + y_2(x - x_3)}{x_2 - x_3}, & \text{if } x \geq x_3 \end{cases}$$

where  $x_1$  and  $x_2$  are x values of the curve's endpoints and they are fixed during fitting,  $x_3$  is the x value at the intersection of two segments, and  $y_1, y_2, y_3$  are y values at  $x_i, i = 1, 2, 3$  respectively.

The fitting function can be defined using the **Fitting Function Builder** tool.

1. Select **Tools: Fitting Function Builder** from Origin menu.
2. In the **Fitting Function Builder** dialog's **Goal** page, click **Next** button.
3. In the **Name and Type** page, select **User Defined** from **Select or create a Category** drop-down list, type **pw12s** in the **Function Name** field, and select **Origin C** in **Function Type** group. And click **Next** button.
4. In the **Variables and Parameters** page, type **x1,y1,x2,y2,x3,y3** in the **Parameters** field. Click **Next** button.
5. In the **Origin C Fitting Function** page, click the  button on the right of the **Function Body** edit box and define the fitting function in **Code Builder** as follows.

```

if( x < x3 )

    y = (y1*(x3-x)+y3*(x-x1))/(x3-x1);

else

    y = (y3*(x2-x)+y2*(x-x3))/(x2-x3);

```

Click **Compile** button to compile the function body. Then click **Return to Dialog** button. Click **Next** button.

6. In the **Parameter Initialization Code** page, click the  button on the right of the **Initialization Code** edit box and initialize the fitting parameters in **Code Builder** as follows.

```

int n1, n2, n3;

x_data.GetMinMax( x1, x2, &n1, &n2 );

x3 = x1 + (x2 - x1)/2;

y1 = y_data[n1];

y2 = y_data[n2];

vector vd;

vd = abs( x_data - x3 );

double xta, xtb;

```

```
vd.GetMinMax( xta, xtb, &n3 );

y3 = y_data[n3];
```

Click **Compile** button to compile it. Then click **Return to Dialog** button. Click **Finish** button.

**Define Derived Parameters for Slopes and Intercepts**

During function defined process, you can also define some additional derived Parameters such as slopes and intercepts , which are computed from the function parameter values after the fitting process ends.

1. Click **<<Back** button twice to go back to **Variables and Parameters** page, type **a1,b1,a2,b2** in the **Derived Parameters** field.
2. Click **Next** button four times to go to **Derived Parameters** page, fill in the **Meaning** column and type the equations in the **Derived Parameters Equations** area as follows, then click **Finish** button.

$$a1=(y1*x3-y3*x1)/(x3-x1);$$

$$b1=(-y1+y3)/(x3-x1);$$

$$a2=(y3*x2-y2*x3)/(x2-x3);$$

$$b2=(-y3+y2)/(x2-x3);$$

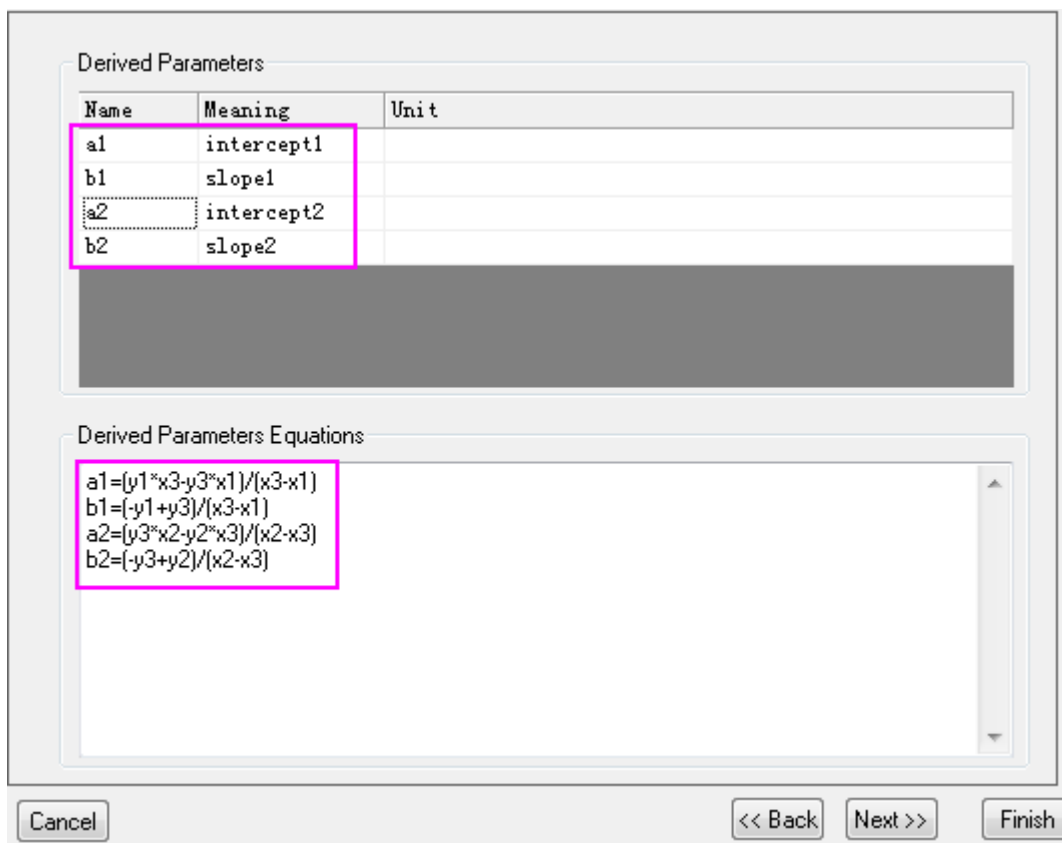

**Fit the Curve**



1. Select **Analysis: Fitting: Nonlinear Curve Fit** from Origin menu. In the **NLFit** dialog, select **Settings: Function Selection**, in the page select **User Defined** from the **Category** drop-down list and **pw12s** function from the **Function** drop-down list.
2. In the **NLFit** dialog, select **Parameters** tab, and fix parameters **x1**, **x2** as shown in the dialog.

NO.	Param	Meaning	Fixed	Value	Error	Dependency
1	x1	?	<input checked="" type="checkbox"/>	0.8	--	--
1	y1	?	<input type="checkbox"/>	0	--	--
1	x2	?	<input checked="" type="checkbox"/>	60	--	--
1	y2	?	<input type="checkbox"/>	0.90662	--	--
1	x3	?	<input type="checkbox"/>	30.4	--	--
1	y3	?	<input type="checkbox"/>	0.73608	--	--

3. Click **Fit** button to fit the curve.

### Fitting Results

The fitted curve should look like:

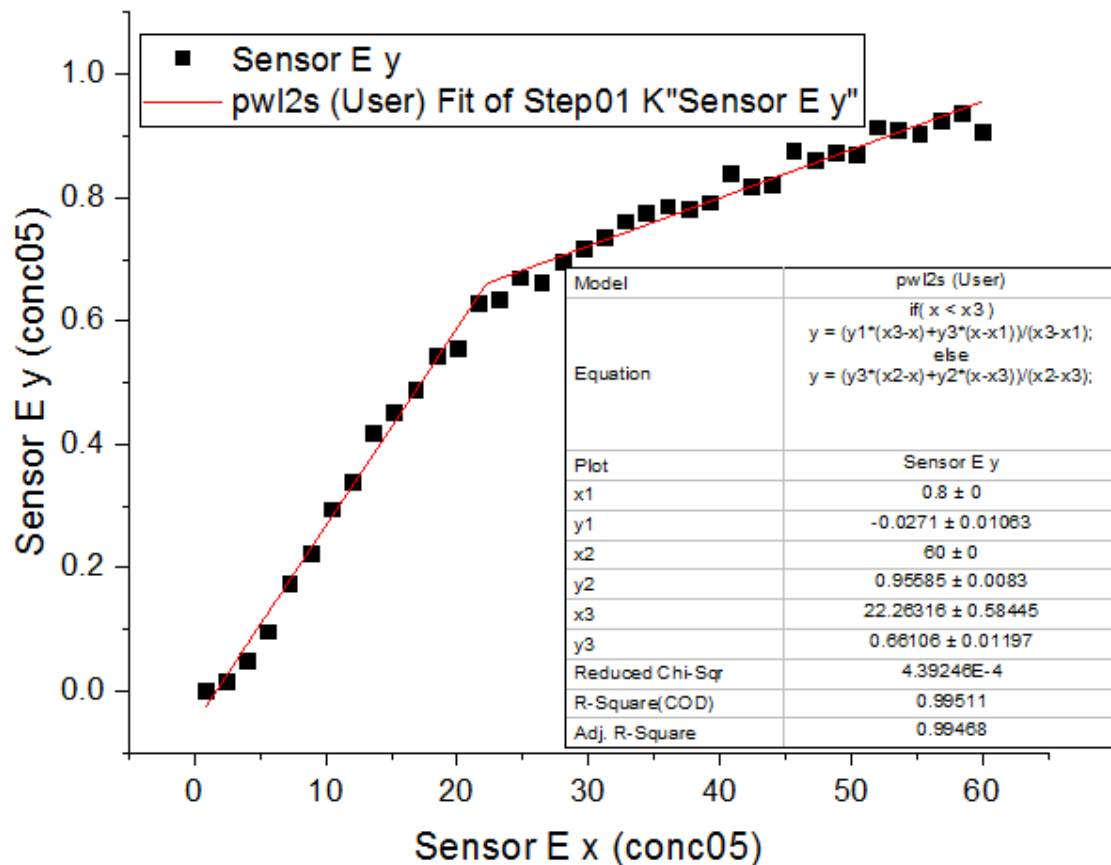

Fitted Parameters are shown as follows.

Parameter	Value	Standard Error
x1	0.8	0
y1	-0.0271	0.01063
x2	60	0
y2	0.95585	0.0083
x3	22.26316	0.58445
y3	0.66106	0.01197
a1	-0.05275	0.01123
b1	0.03206	8.7153E-4
a2	0.48715	0.01664
b2	0.00781	3.86455E-4

Thus the intersection point for the two segments is (22.26316, 0.66106).

**Note** that fitting with a piecewise linear function for more than two segments can be done in a similar way.

#### 4.3.3.27 Fitting with an Ordinary Differential Equation

##### 4.3.3.27.1 Summary

In this tutorial we will show you how to define an ordinary differential equation (**ODE**) in the **Fitting function Builder** dialog and perform a fit of the data using this fitting function.

Minimum Origin Version Required: Origin 9.1 SR0

##### 4.3.3.27.2 What you will learn

This tutorial will show you how to:

- Define an ODE fitting function.
- Call NAG functions using Origin C code.
- Recalculate the ODE result only when parameters are updated.
- Interpolate on the ODE result.

### 4.3.3.27.3 Example and Steps

In this tutorial, we will use a first order ordinary differential equation as an example:

$$\frac{dy}{dx} = ay$$

$$y|_{x=x_0} = y_0$$

where **a** is a parameter in the ordinary differential equation and **y0** is the initial value for the ODE. NAG functions **d02pvc** and **d02pcc** are called using the Runge-Kutta method to solve the **ODE** problem.

#### Import Data

1. Open a new workbook.
2. Click the **Import Single ASCII** button  to bring up the Open dialog. Browse to the **\Samples\Curve Fitting** folder and select the file **Exponential Growth.dat**.
3. Highlight **B** column, and select **Plot: Symbol: Scatter** from Origin menu. The graph should look like:

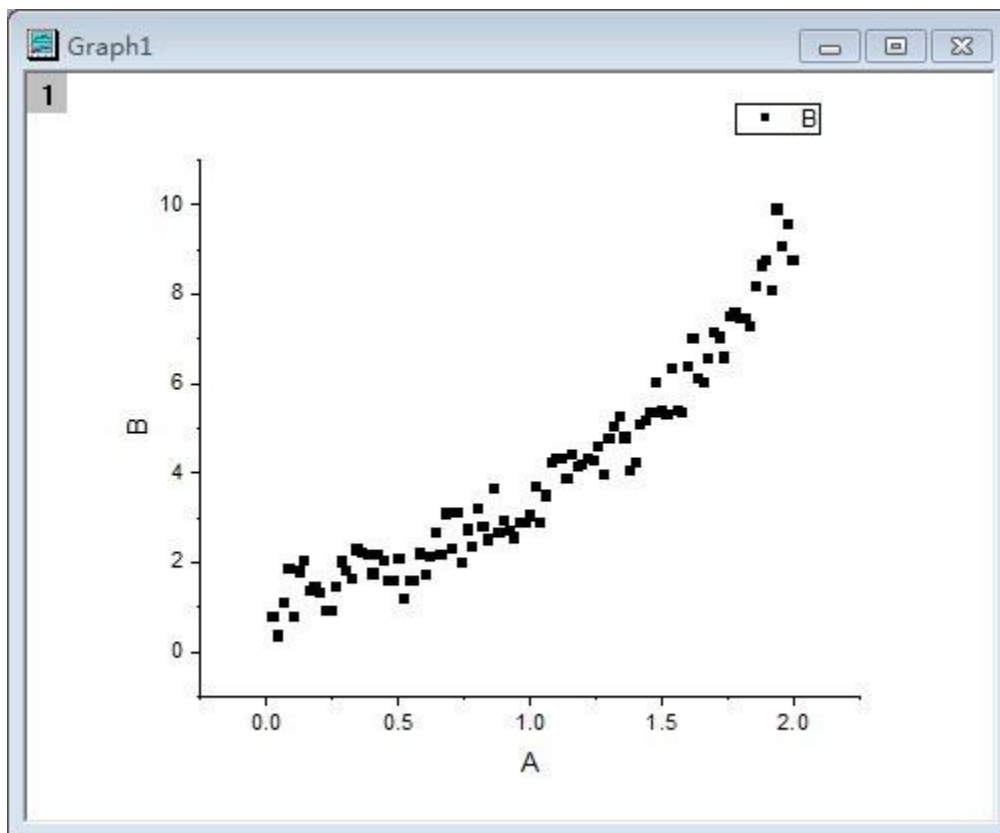

#### Define Fitting Function

The fitting function can be defined using the **Fitting Function Builder** tool.

1. Select **Tools: Fitting Function Builder** from Origin menu.

2. On the **Fitting Function Builder** dialog's **Goal** page, ensure the **Create New Function** radio button is selected. Click the **Next** button.
3. On the **Name and Type** page, From the **Select or create a Category** drop-down list select **User Defined**. For **Function Name** type **FitODE**. In the **Function Type** section select the **Origin C** radio button. Click **Next**.
4. On the **Variables and Parameters** page, in the **Parameters** field type **a, y0**. Click **Next**.
5. On the **Origin C Fitting Function** page, click the  button on the right of the **Function Body** edit box and define the function in **Code Builder** as follows. Include header files for NAG and fitting:

```
#include <oc_nag.h>

#include <ONLSF.H>
```

Define a static function to solve ODE by calling NAG functions. Call NAG function **d02pvc** to establish ODE model and **d02pcc** to solve the model:

```
struct user // parameter in the ODE

{

    double a;

};

//Define the differentiate equation: y'=a*y

static void NAG_CALL f(Integer neq, double t, double y[], double yp[],
Nag_User *comm)

{

    neq; //Number of ordinary differential equations

    t; //Independent variable
```

```
y; //Dependent variables

yp; //First derivative

struct user *sp = (struct user *) (comm->p);

double a;

a = sp->a;

yp[0] = a*y[0];
}

//Use Runge-Kutta ODE23 to solve ODE

static bool nag_ode_fit( const double a, const double y0, const double
tstart,

const double tend, const int nout, vector &vP )
{

//nout: Number of points to output

if( nout < 2 )

return false;
```

```
vP.SetSize( nout );

vP[0] = y0;

int neq = 1; //Number of ordinary differential equations

Nag_RK_method method;

double hstart, tgot, tinc;

double tol, twant;

int i, j;

vector thres(neq), ygot(neq), ymax(neq), ypgot(neq), ystart(neq);

Nag_ErrorAssess errass;

Nag_ODE_RK opt;

Nag_User comm;

struct user s;

s.a = a;

comm.p = (Pointer)&s;
```

```
ystart[0] = y0;

for (i=0; i<=neq; i++)

    thres[i] = 1.0e-8;

errass = Nag_ErrorAssess_off;

hstart = 0;

method = Nag_RK_2_3;

tinc = (tend-tstart)/(nout-1);

tol = 1.0e-3;

NagError nagErr1;

//Setup ODE

d02pvc(neq, tstart, ystart, tend, tol, thres, method,

    Nag_RK_range, errass, hstart, &opt, &nagErr1);

if( nagErr1.code != NE_NOERROR )

    return false;
```

```
for (j=1; j<nout; j++)  
  
{  
  
    twant = tstart + j*tinc;  
  
    NagError nagErr2;  
  
    //Solve ODE  
  
    d02pcc(neq, f, twant, &tgot, ygot, ypgot, ymax, &opt, &comm,  
&nagErr2);  
  
    if( nagErr2.code != NE_NOERROR )  
  
        return false;  
  
    vP[j] = ygot[0];  
  
}  
  
//Free functions for Runge-Kutta suite  
  
d02ppc(&opt);  
  
return true;  
  
}
```

Define the fitting function body **\_nlsfFitODE**:



```
NLFitContext *pCtxt = Project.GetNLFitContext();

if ( pCtxt )
{
    static vector vX, vY;

    static int nSize;

    BOOL bIsNewParamValues = pCtxt->IsNewParamValues();

    // If parameters were updated, we will recalculate the ODE result.

    if ( bIsNewParamValues )
    {
        //Initial and final values of the independent variable

        double tstart = 0.02, tend = 2, tinc;

        int nout = 100; //Number of points

        tinc = (tend-tstart)/(nout-1);

        vX.Data( tstart, tend, tinc );

        nSize = vX.GetSize();

        if( !nag_ode_fit( a, y0, tstart, tend, nout, vY) )
```

```

return;

}

//Interpolate y from fitting data's x on the ODE result.

ocmath_interpolate( &x, &y, 1, vX, vY, nSize );

}

```

Click the **Compile** button to compile the function body. To return, click **Return to Dialog** button. The **Evaluate** button on the dialog has a black figure of a running person. Clicking on it will show  $y=2.6627270424371$ . This implies that the function works. Click **Next**.

- In the **Parameter Initialization Code** page, select **Use Custom Code** radio button, and type the code in the **Initialization Code** box:

```

//Set the start y value in fitting data as the initial value of y0

y0 = y_data[0];

a = 1;

```

and click **Finish**.

**Note:** In order to monitor the the fitted parameters, [NLFitContext class](#) was introduced in defining fitting function to achieve some key information within the fitter

#### Fit the Curve

- Highlight **B** column, then select **Analysis: Fitting: Nonlinear Curve Fit** from Origin menu. In the **NLFit** dialog, select **Settings: Function Selection**, in the page select **User Defined** from the **Category** drop-down list and **FitODE** function from the **Function** drop-down list.
- Select **Parameters** tab, and fix **y0** as shown in the dialog.

NO.	Param	Meaning	Fixed	Value	Error	Dependency	Lower Cor
1	a	?	<input type="checkbox"/>	1	--	--	-
1	y0	?	<input checked="" type="checkbox"/>	0.77038	--	--	-

- Click **Fit** button to fit the curve.

#### Fitting Results

The fitted curve should resemble the following image:

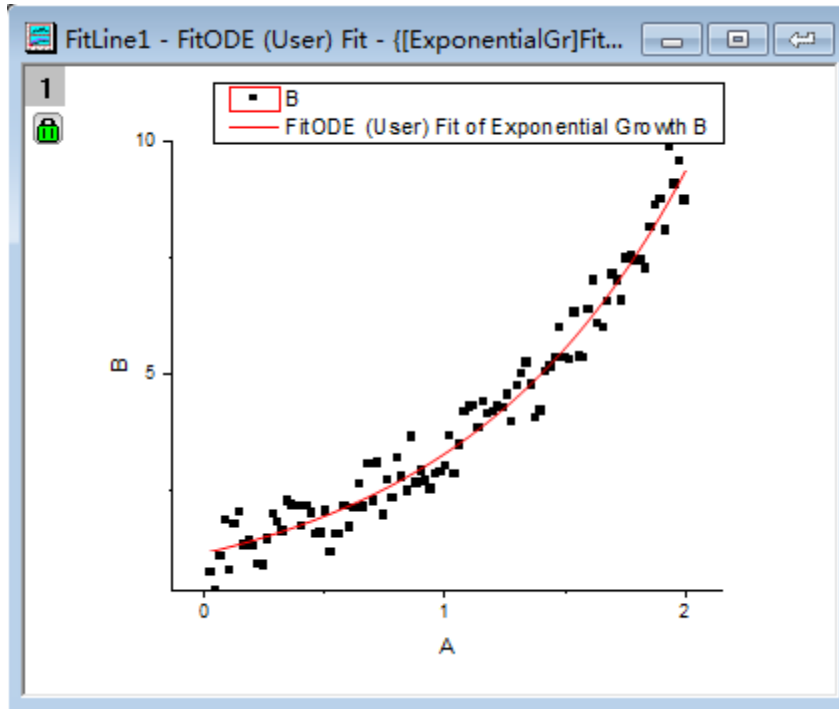

Fitted Parameters will be shown as in the following table:

Parameter	Value	Standard Error
a	1.30272	0.00858
y0	0.77038	0

**Note:** Fitting with more complex ODE fitting functions can also be done in a similar way.

#### 4.3.3.28 Fitting with Convolution of Two Functions

##### 4.3.3.28.1 Summary

In this tutorial, we will show you how to define a convolution of two functions, and perform a fit of the data with non-evenly spaced X using this fitting function.



If your data is a convolution of Gauss and Exponential functions, you can simply use built-in fitting function [GaussMod](#) in **Peak Functions** category to directly fit your data.

Minimum Origin Version Required: Origin 9.0 SR0

#### 4.3.3.28.2 What you will learn

This tutorial will show you how to:

- Sample a function.
- Calculate a convolution of two functions.
- Define constants in the fitting function.
- Pad zeroes before the convolution.
- Interpolate the convolution result for non-evenly spaced X.
- Use a parameter to balance the speed and the precision.
- Use Y Error Bar as weight.

#### 4.3.3.28.3 Example and Steps

##### Import Data

1. Open a new workbook.
2. Click the **Import Single ASCII** button  to bring up the Open dialog. Browse to **\Samples\Curve Fitting** folder and select the file **ConvData.dat**. Note that column A is not evenly spaced. We can use LabTalk **diff** function to verify it.
3. Right click on column C, and select **Set As: Y Error** from the short-cut menu. Highlight column B and C, and select **Plot: Symbol: Scatter** from the Origin menu. The graph should look like:

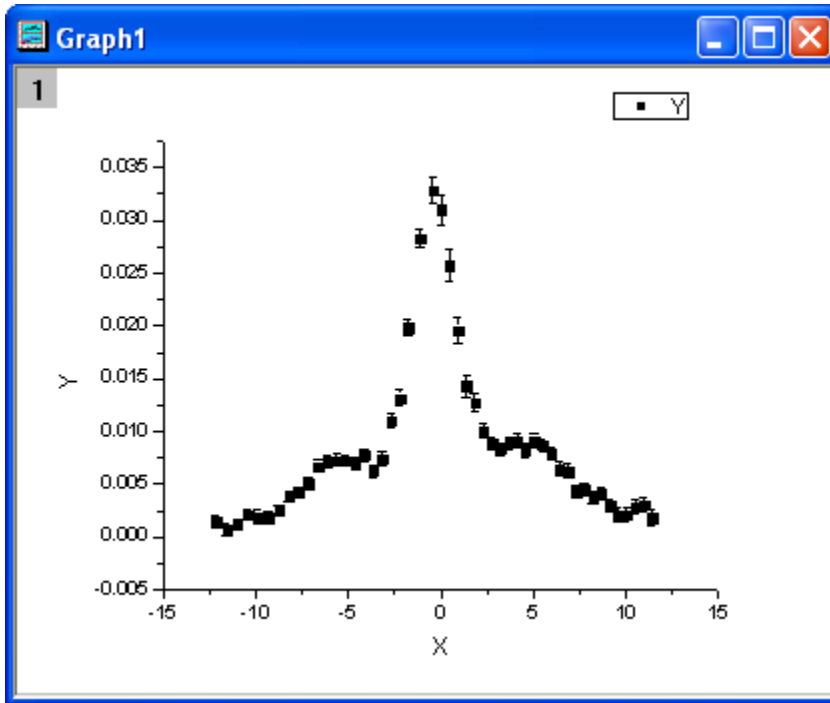

#### Define Fitting Function

The fitting function is a convolution of two functions. It can be described as follows:

$$y = y_0 + b_1x + \frac{b_2 A_2}{w_2 \sqrt{\pi/2}} e^{-\frac{2(x-x_{c2})^2}{w_2^2}} + (f * g)(x)$$

where

$$f(x) = \frac{s}{\pi} \cdot \frac{\tau_L x_0^2 (x_L^2 - x_0^2)}{(x - x_{c1}) \tau_L ((x - x_{c1})^2 - x_L^2)^2 + ((x - x_{c1})^2 - x_0^2)^2},$$

$$g(x) = \frac{1}{w_1 \sqrt{\pi/2}} e^{-\frac{2x^2}{w_1^2}}$$

And  $x_0, x_L, \tau_L, s, y_0, b_1$  and  $b_2$  are fitting parameters.  $w_1, x_{c1}, w_2, x_{c2}$  and  $A_2$  are constants in the fitting function.

The fitting function can be defined using the **Fitting Function Builder** tool.

1. Select **Tools: Fitting Function Builder** from Origin menu.
2. In the **Fitting Function Builder** dialog's **Goal** page, click **Next**.
3. In the **Name and Type** page, select **User Defined** from **Select or create a Category** drop-down list, type **convfunc** in the **Function Name** field, and select **Origin C** in **Function Type** group. And click **Next**.
4. In the **Variables and Parameters** page, type **x0,xL,tL,s,y0,b1,b2** in the **Parameters** field, **w1,xc1,w2,xc2,A2** in the **Constants** field. Click **Next**.
5. In the **Origin C Fitting Function** page, set initial parameters as follows:

```
x0 = 3.1  
  
xL = 6.3  
  
tL = 0.4  
  
s = 0.14  
  
y0 = 1.95e-3  
  
b1 = 2.28e-5  
  
b2 = 0.2
```

Click **Constants** tab, set constants as follows:

```
w1 = 1.98005  
  
xc1 = -0.30372  
  
w2 = 5.76967  
  
xc2 = 3.57111  
  
A2 = 9.47765e-2
```

Click the  button on the right of the **Function Body** edit box and define the fitting function in **Code Builder** as follows:

Include header files,

```
#include <ONLSF.H>  
  
#include <fft_utils.h>
```

Define the function body

```
NLFitContext *pCtxt = Project.GetNLFitContext();

if ( pCtxt )

{

    // Vector for the output in each iteration.

    static vector vX, vY;

    static int nSize;

    BOOL bIsNewParamValues = pCtxt->IsNewParamValues();

    // If parameters were updated, we will recalculate the convolution
    result.

    if ( bIsNewParamValues )

    {

        //Sampling Interval

        double dx = 0.05;

        vX.Data(-16.0, 16.0, dx);

        nSize = vX.GetSize();

        vector vF, vG, vTerm1, vTerm2, vDenominator, vBase, vAddBase;
```

```
double Numerator = tL * x0^2 * (xL^2 - x0^2);

vTerm1 = ( (vX - xc1) * tL * ( (vX - xc1)^2 - xL^2 ) )^2;

vTerm2 = ( (vX - xc1)^2 - x0^2 )^2;

vDenominator = vTerm1 + vTerm2;

//Function f(x)

vF = (s/pi) * Numerator / vDenominator;

//Function g(x)

vG = 1/(w1*sqrt(pi/2))*exp(-2*vX^2/w1^2);

//Pad zeroes at the end of f and g before convolution

vector vA(2*nSize-1), vB(2*nSize-1);

vA.SetSubVector( vF );

vB.SetSubVector( vG );

//Perform circular convolution

int iRet = fft_fft_convolution(2*nSize-1, vA, vB);

//Truncate the beginning and the end
```



```

vY.SetSize(nSize);

vA.GetSubVector( vY, floor(nSize/2), nSize + floor(nSize/2)-1 );

//Baseline

vBase = (b1*vX + y0);

vAddBase = b2 * A2/(w2*sqrt(pi/2))*exp( -2*(vX-xc2)^2/w2^2 );

//Fitted y

vY = dx*vY + vBase + vAddBase;

}

//Interpolate y from x for the fitting data on the convolution result.

ocmath_interpolate( &x, &y, 1, vX, vY, nSize );

}

```

Click **Compile** button to compile the function body. And click the **Return to Dialog** button.

Click **Evaluate** button, and it shows  $y=0.02165$  at  $x=1$ . And this indicates the defined fitting function is correct. Click **Next**.

- Click **Next**. In the **Bounds and General Linear Constraints** page, set the following bounds:

```

0 < x0 < 7

0 < xL < 10

```

```

0 < tL < 1
0 <= s <= 5
0 < b2 <= 3
    
```

Click **Finish**.

**Note:** In order to monitor the the fitted parameters, [NLFitContext class](#) was introduced in defining fitting function to achieve some key information within the fitter

**Fit the Curve**

1. Select **Analysis: Fitting: Nonlinear Curve Fit** from the Origin menu. In the **NLFit** dialog, select **Settings: Function Selection**, in the page select **User Defined** from the **Category** drop-down list and **convfunc** function from the **Function** drop-down list. Note that **Y Error Bar** is shown in the active graph, so column C is used as Y weight, and **Instrumental** weighting method is chosen by default.
2. Click the **Fit** button to fit the curve.

**Fitting Results**

The fitted curve should look like:

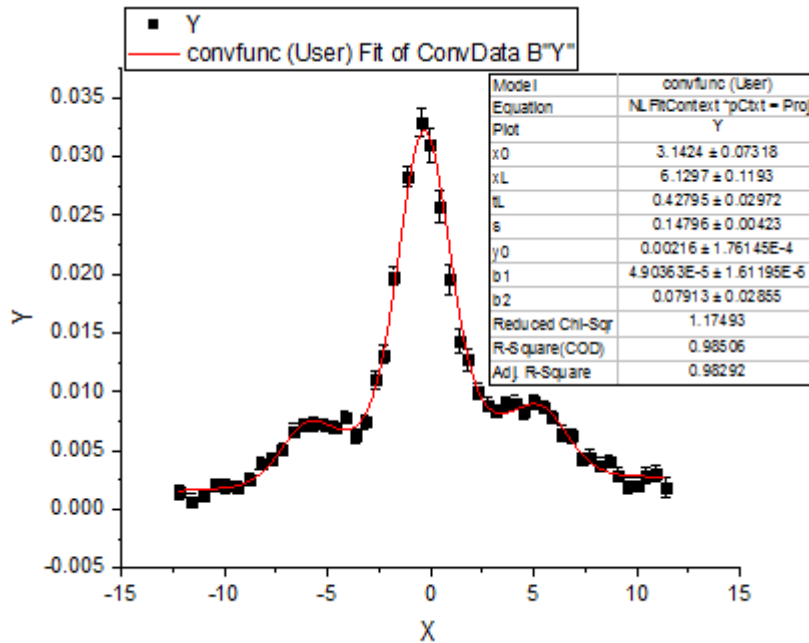

Fitted Parameters are shown as follows:

Parameter	Value	Standard Error
-----------	-------	----------------

<b>x0</b>	3.1424	0.07318
<b>xL</b>	6.1297	0.1193
<b>tL</b>	0.42795	0.02972
<b>s</b>	0.14796	0.00423
<b>y0</b>	0.00216	1.76145E-4
<b>b1</b>	4.90363E-5	1.61195E-5
<b>b2</b>	0.07913	0.02855

Note that you can set a smaller value for **dx** in the fitting function body, the result may be more accurate, but at the same time it may take a longer time for fitting.

#### 4.3.3.29 Parameter Initialization for Rational Functions

##### 4.3.3.29.1 Summary

In this tutorial, we will show you how to calculate initial parameters for rational fitting functions using the multiple linear regression method, and perform a fit of the data using calculated initial parameters.

Minimum Origin Version Required: Origin 9.0 SR0

##### 4.3.3.29.2 What you will learn

This tutorial will show you how to:

- Calculate initial parameters for rational fitting functions.
- Perform multiple linear regression using Origin C code.

##### 4.3.3.29.3 Example and Steps

###### Algorithm

In this tutorial, we will use the following rational function as an example:

$$y = \frac{a + bx + cx^2}{1 + dx + ex^2}$$

where **x** is the independent variable, **y** is the dependent variable, and **a**, **b**, **c**, **d**, **e** are fitting parameters.

Multiplying both sides by the denominator on the right side yields:

$$y + dxy + ex^2y = a + bx + cx^2$$

and the equation can be expressed as:

$$y = a + bx + cx^2 - dxy - ex^2y$$

Substituting fitting data  $(x_i, y_i)$   $i = 1 \dots N$  into the equation gives:

$$\begin{cases} a + bx_1 + cx_1^2 - dx_1y_1 - ex_1^2y_1 = y_1 \\ a + bx_2 + cx_2^2 - dx_2y_2 - ex_2^2y_2 = y_2 \\ \vdots \\ a + bx_N + cx_N^2 - dx_Ny_N - ex_N^2y_N = y_N \end{cases}$$

Hence estimating initial parameters for a rational polynomial fitting function becomes a multiple linear regression problem with linear coefficients **a, b, c, d, e**.

$$\begin{bmatrix} 1 & x_1 & x_1^2 & -x_1y_1 & -x_1^2y_1 \\ 1 & x_2 & x_2^2 & -x_2y_2 & -x_2^2y_2 \\ \vdots & & & & \\ 1 & x_N & x_N^2 & -x_Ny_N & -x_N^2y_N \end{bmatrix} \begin{bmatrix} a \\ b \\ c \\ d \\ e \end{bmatrix} = \begin{bmatrix} y_1 \\ y_2 \\ \vdots \\ y_N \end{bmatrix}$$

Origin provides a function [ocmath\\_multiple\\_linear\\_regression](#) in Origin C for multiple linear regression, which can be called in initialization code.

#### Import Data

1. Open a new workbook.
2. Copy data in [Sample Data](#) to the workbook.
3. Highlight column B, and select **Plot: Symbol: Scatter** from Origin menu. The graph should look like:

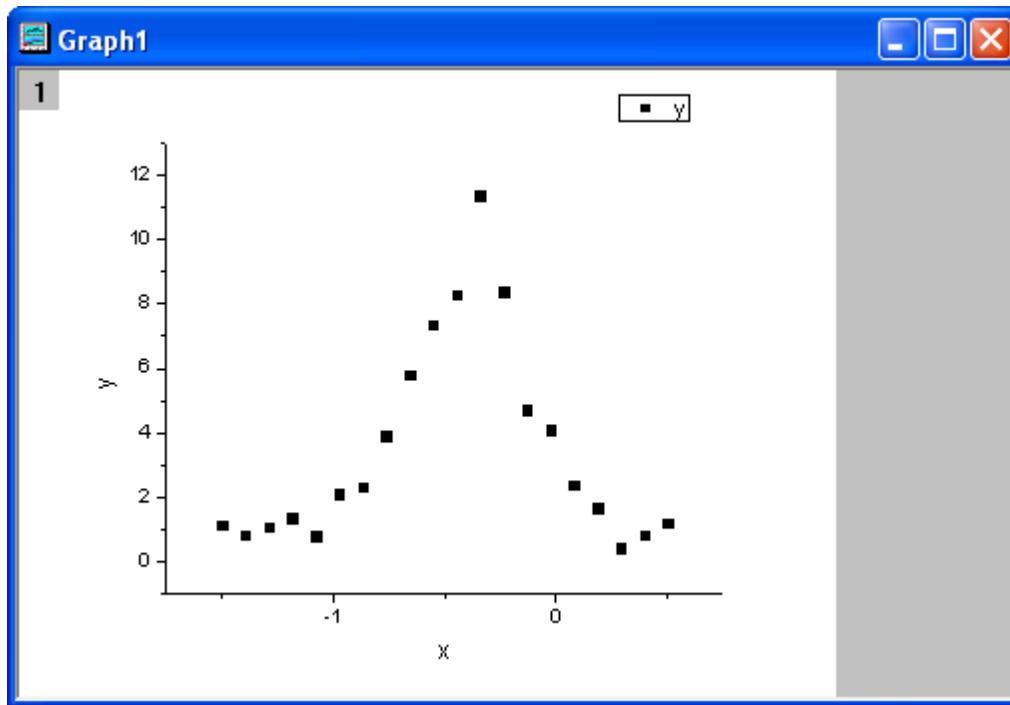

#### Define Fitting Function and Initialize Parameters

The fitting function can be defined using the **Fitting Function Builder** tool.

1. Select **Tools: Fitting Function Builder** from Origin menu.
2. In the **Fitting Function Builder** dialog's **Goal** page, click the **Next** button.
3. In the **Name and Type** page, select **User Defined** from the **Select or create a Category** drop-down list, type **rationalfunc** in the **Function Name** field, and select **Expression** in the **Function Type** group. Click the **Next** button.
4. In the **Variables and Parameters** page, type **a, b, c, d, e** in the **Parameters** field. Click the **Next** button.
5. In the **Expression Function** page, type the following script in the **Function Body** box.

$$(a+b*x+c*x^2) / (1+d*x+e*x^2)$$

Click the **Evaluate** button, and it shows  $y=1$  at  $x=1$ , hence this implies the expression is correct.

Click the **Next** button.

6. In the **Parameter Initialization Code** page, select **Use Custom Code** radio button, click the **Open Code Builder** button  to the right of the **Initialization Code** box, and initialize fitting parameters as follows, in terms of the [algorithm](#).

```
UINT nOSizeN = x_data.GetSize(); //Number of points

UINT nVSizeM = 5; //Number of parameters

matrix mX(nOSizeN, 5);

//Construct matrix for data points of independent variables

vector vCa(nOSizeN), vCb, vCc, vCd, vCe;

vCa = 1;

mX.SetColumn( vCa, 0 );

vCb = x_data;

mX.SetColumn( vCb, 1 );

vCc = x_data^2;

mX.SetColumn( vCc, 2 );

vCd = -x_data*y_data;

mX.SetColumn( vCd, 3 );

vCe = -x_data^2*y_data;

mX.SetColumn( vCe, 4 );

//Options for multiple linear regression
```

```
LROptions stLROptions;

stLROptions.UseReducedChiSq = 1;

stLROptions.FixIntercept = 1; //Fix the intercept at 0.

FitParameter stFitParameters[ 6 ]; // should be nVSizeM+1

UINT nFitSize = nVSizeM + 1;

int nRet = ocmath_multiple_linear_regression(mX, nOSizeN, nVSizeM,
y_data,

    NULL, 0, &stLROptions, stFitParameters, nFitSize );

if( nRet == STATS_NO_ERROR )

{

    a = stFitParameters[1].Value;

    b = stFitParameters[2].Value;

    c = stFitParameters[3].Value;

    d = stFitParameters[4].Value;

    e = stFitParameters[5].Value;

}
```

Click the **Compile** button to compile the code. And click the **Return to Dialog** button. Click **Finish** to close the **Fitting Function Builder** dialog.

**Fit the Curve**

1. Select **Analysis: Fitting: Nonlinear Curve Fit** from Origin menu. In the **NLFit** dialog, select **Settings: Function Selection**, in the page select **User Defined** from the **Category** drop-down list and **rationalfunc** function from the **Function** drop-down list.
2. Click the **Parameters** tab. Initial parameters calculated from initialization code are listed in the dialog, and the fitting function curve for initial parameters is shown as follows. It seems that initial parameters from initialization code are very good.

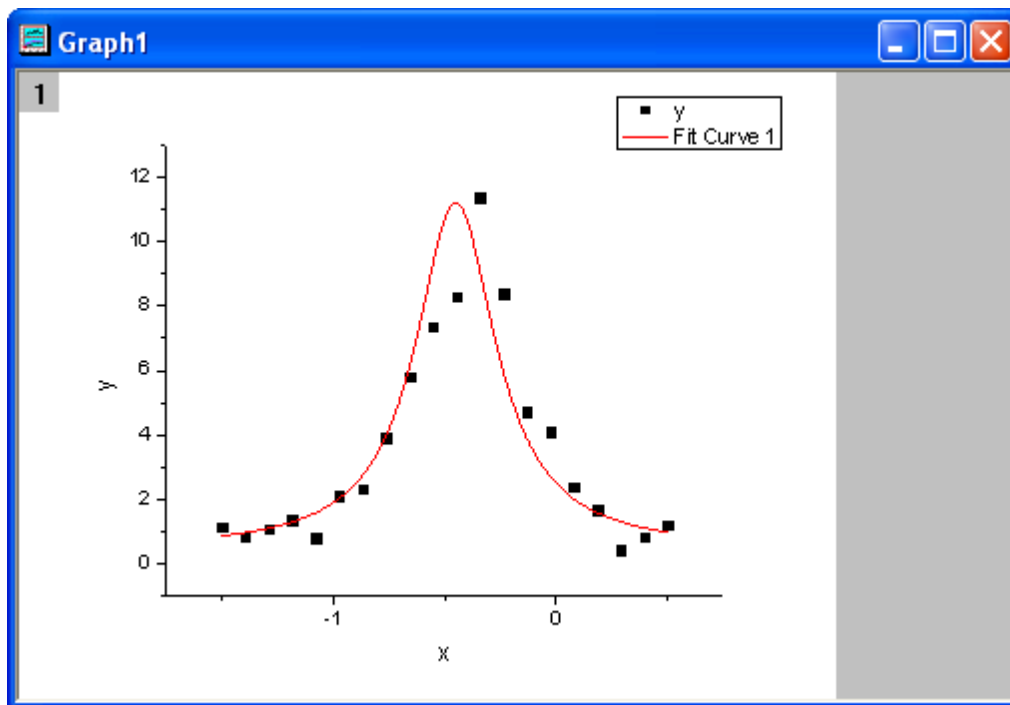

3. Click the **Fit** button to fit the curve.

#### Fitting Results

The fitted curve should look like:



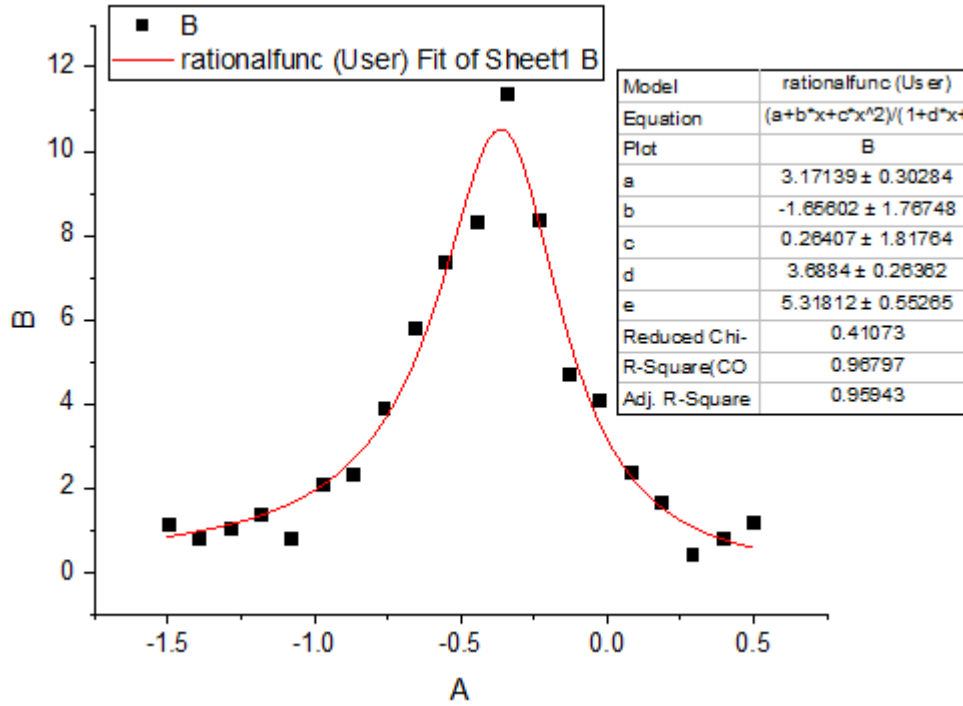

Fitted Parameters are shown as follows:

Parameter	Value	Standard Error
a	3.17139	0.30284
b	-1.65602	1.76748
c	0.26407	1.81764
d	3.6884	0.26362
e	5.31812	0.55265

Sample Data

x	y
-1.5	1.13173
-1.39474	0.8262

## Tutorials for Origin

-1.28947	1.06999
-1.18421	1.37155
-1.07895	0.79569
-0.97368	2.11346
-0.86842	2.32006
-0.76316	3.9205
-0.65789	5.81904
-0.55263	7.38037
-0.44737	8.31272
-0.34211	11.39718
-0.23684	8.39808
-0.13158	4.7305
-0.02632	4.11105
0.07895	2.39105
0.18421	1.65394
0.28947	0.42953
0.39474	0.83337
0.5	1.18758

**Note:** You can also use this method to initialize parameters for other rational polynomial fitting functions.

#### 4.3.3.30 Surface Fitting with Multiple Peaks

Origin provides several built-in surface fitting functions which can be used to perform fitting on 3D data. The surface fitting function is similar to the nonlinear fitting function.

Surface Fitting is only available in OriginPro.

Minimum Origin Version Required: OriginPro 9.0 SR0

##### 4.3.3.30.1 What you will learn

- How to do surface fitting on matrix data.
- How to fit the surface with multiple peaks.

##### 4.3.3.30.2 Steps

This tutorial is associated with the **Surface Fitting (Pro Only)** folder in the **Tutorial Data.opj** (<Origin EXE Folder>\Samples\Tutorial Data.opj).

1. With the matrix sheet active, click **Analysis** on the main menu, and then click **Nonlinear Matrix Fit...** to open the NLFit dialog. (Alternatively, you can plot the matrix as a 3D surface or contour, and then select **Nonlinear Surface Fit...** to open the same dialog.)
2. Click **Function Selection**, select **Gauss2D** from the **Function** dropdown menu.

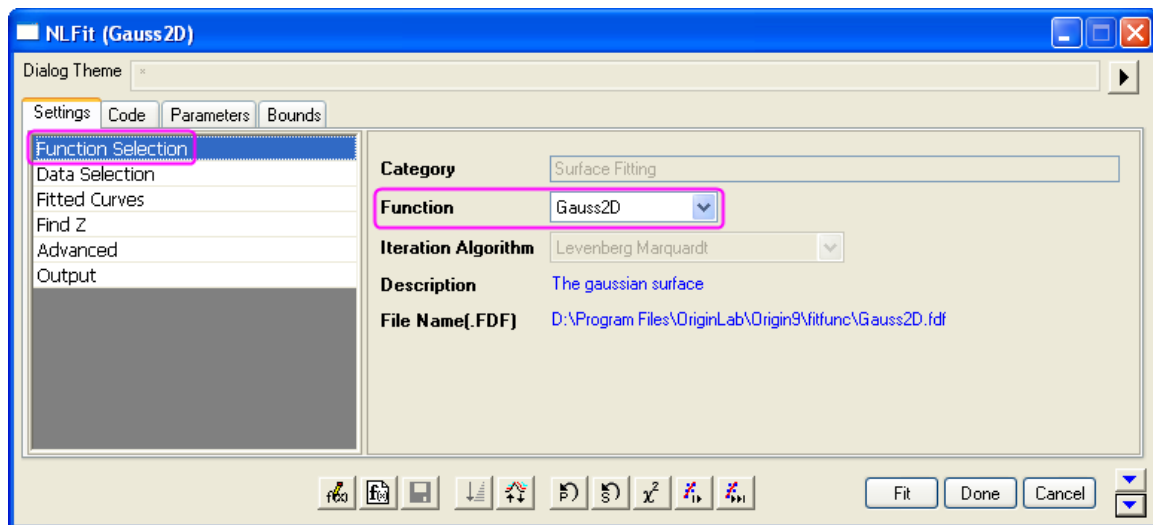

3. Click **Advanced**, set **Number of Replicas** to **3**, and set **Peak Direction** as **Positive**.

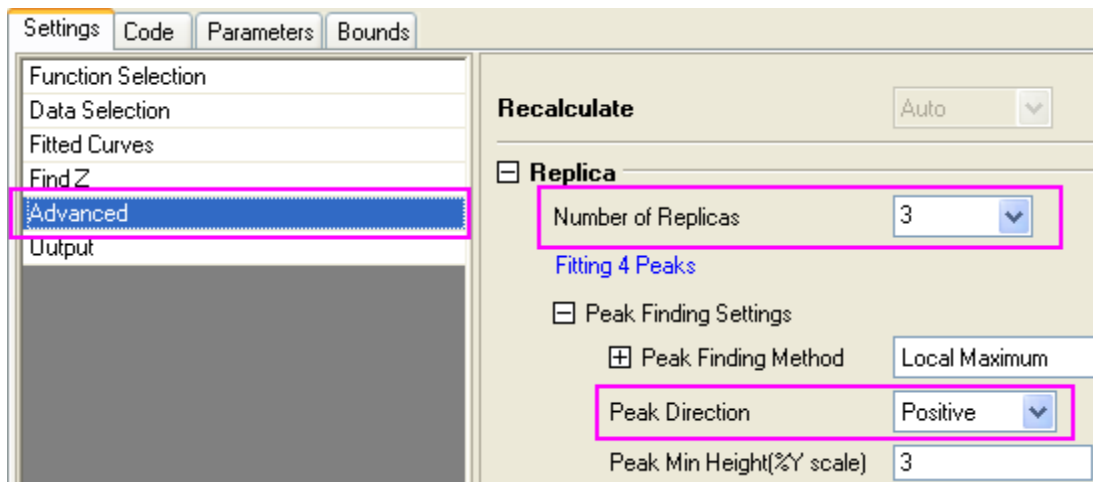

- Click **Fit** to perform a multiple peak fit and generate a report worksheet with fitting results.

#### 4.3.3.31 Nonlinear Multiple Variables Fitting

##### 4.3.3.31.1 Summary

Origin supports fitting functions with multiple dependent or independent variables. With the nonlinear fitting function, you can define multiple variables and separate them with semicolons. Since global fitting allows you to fit only one function at a time, this is a good way to defeat that limitation.

Origin ships with three built-in functions with multiple dependent and independent variables. These functions, available in the Multiple Variables category, are actually composites consisting of two ordinary functions. The GaussianLorentz function, for example, is a combination of the Gaussian and Lorentz functions, sharing  $y_0$  and  $x_c$ :

$$y_1 = y_0 + \frac{A_1}{w_1 \sqrt{\pi/2}} e^{-2 \frac{(x-x_c)^2}{w_1^2}}$$

$$y_2 = y_0 + \frac{2A_2}{\pi} \frac{w_2}{4(x-x_c)^2 + w_2^2}$$

This tutorial will demonstrate how to fit such multi-variable functions.

##### 4.3.3.31.2 What you will learn

- Use Nonlinear Multiple Variables Fitting to fit a curve with two different functions.
- Assign data to fitting variables.

##### 4.3.3.31.3 Steps

- Start with a new project or create a new workbook and import the data file `\samples\curve fitting\Gaussian.dat`.

The screenshot shows a window titled "Gaussian - Gaussian.dat" with a table and sparklines. The table has columns for Long Name, Units, Comments, Sparklines, A(X), B(Y), and C(Y). The data rows are numbered 1 to 10. Sparklines are visible for the first three columns of each row.

	A(X)	B(Y)	C(Y)
Long Name	Channel	Amplitude	Error
Units			
Comments			
Sparklines			
1	1	3	1.732
2	2	7	2.646
3	3	5	2.236
4	4	3	1.732
5	5	2	1.414
6	6	6	2.449
7	7	10	3.162
8	8	7	2.646
9	9	6	2.449
10	10	3	1.732

- Highlight Column(A) and Column(B). In the main menu, click **Analysis**, then point to **Fitting**, and then click **Nonlinear Curve Fit**.
- In the NLFit dialog's left panel, select **Function Selection**. In the right panel, select **Multiple Variables** in the Category dropdown menu. In the Function dropdown menu, select **GaussianLorentz**.

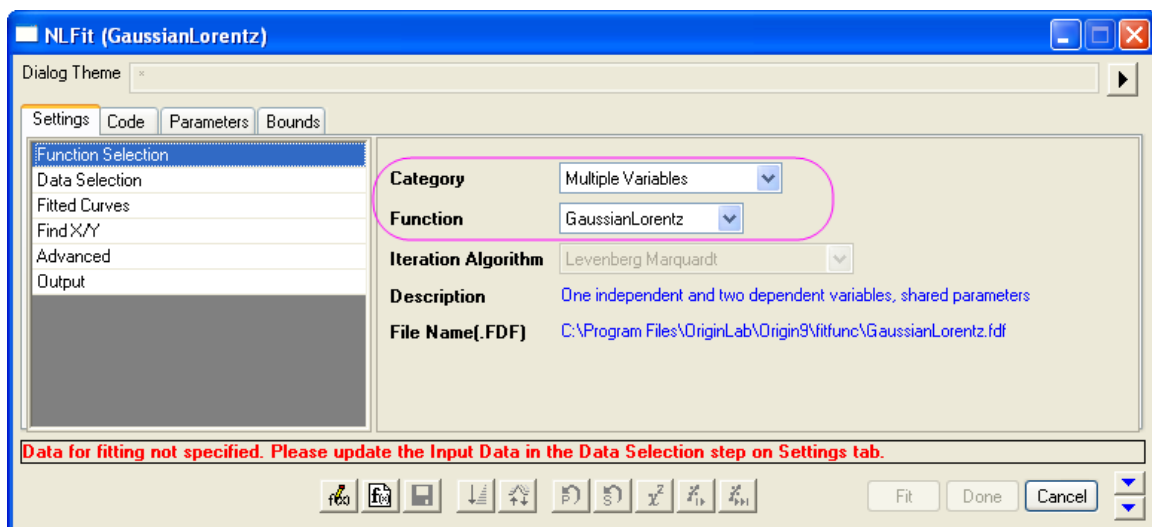

As you can see on the Sample Curve tab, the equations in this fitting function share the same parameters,  $y_0$  and  $x_c$ .

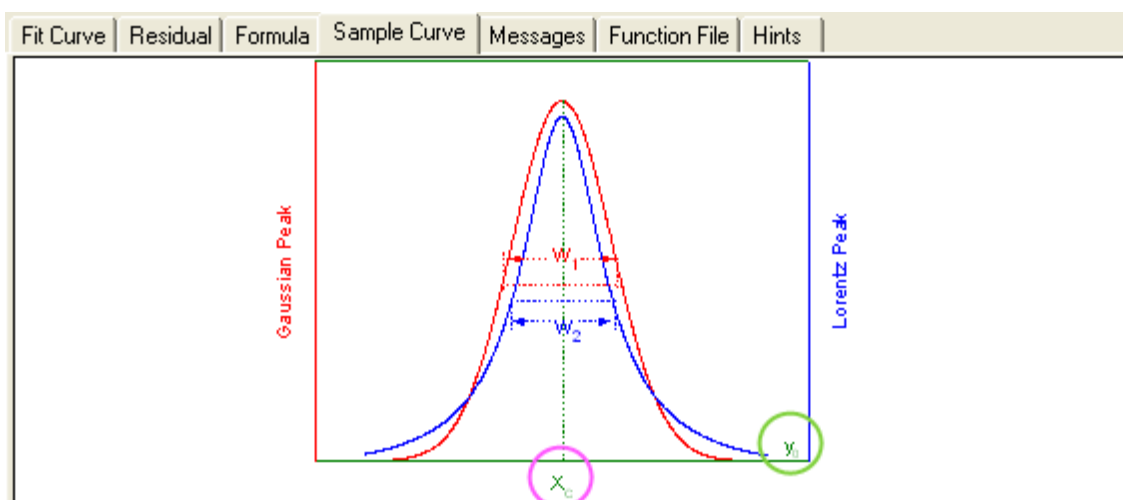

4. In the NLFit dialog's left panel, select **Data Selection**. In the right panel, expand the **Range** node and assign data to the fitting variables. In this example, we have assigned column B to both  $y1$  and  $y2$ , which means that both expressions will fit the same dataset.

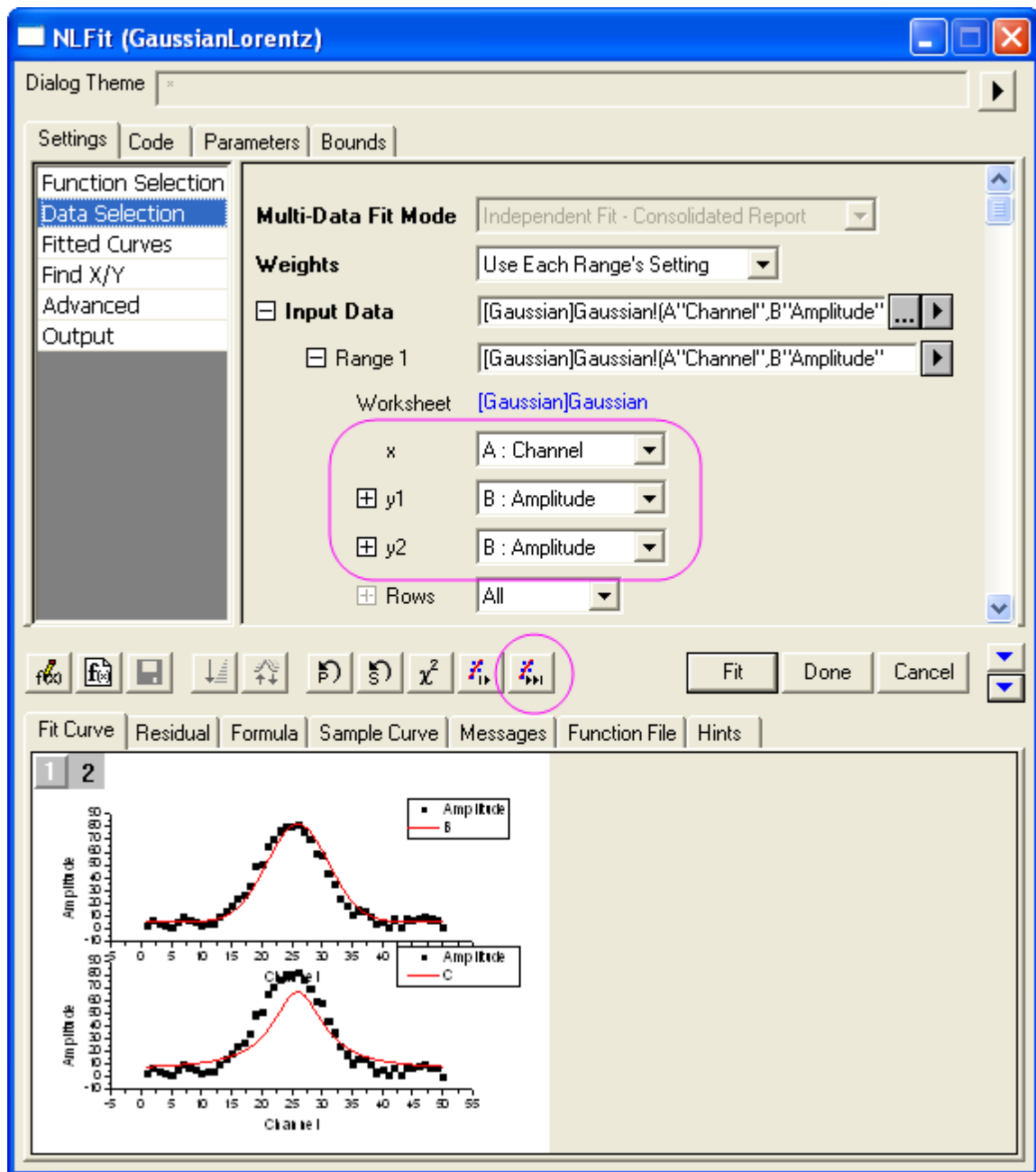

- Click **Fit until converged** to fit, then **OK**. In the results sheet, compare parameters A and w, with the Gaussian and Lorentz functions sharing the same offset and peak center.

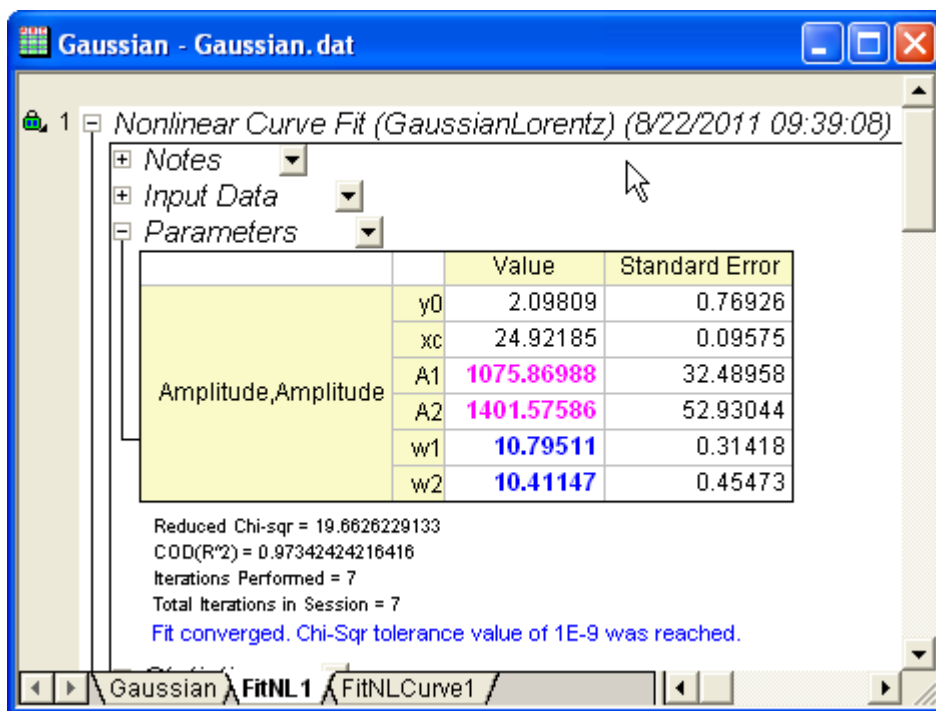

#### 4.3.3.32 Modifying Derived Parameters in Build-in Functions

##### 4.3.3.32.1 Summary

Derived parameters are additional parameters computed using the fitted parameter values. You can define your own derived parameters for any built-in or user-defined fitting functions. They are not involved in the fitting process and are computed only at the end of the fitting session.

##### 4.3.3.32.2 What you will learn

- How to add derived parameters in a built-in fitting function by Fitting Function Organizer.
- How to remove derived parameters in a built-in fitting function by Fitting Function Organizer.

##### 4.3.3.32.3 Adding Derived Parameters

1. The built-in Gauss function fits the peak area with the following equation:

$$y = y_0 + \frac{A}{w\sqrt{\pi/2}} e^{-2\frac{(x-x_c)^2}{w^2}}$$

$$h = \frac{A}{w\sqrt{\pi/2}}$$

Suppose that you also want to know the peak height, which can be computed as follows:

2. Select **Tool: Fitting Function Organizer** in the menu. In the left panel of the dialog, select **Origin Basic Funcions: Gauss**.



- Go to **Derived Parameters** section and input the  $h=A/(w*\sqrt{\pi/2})$

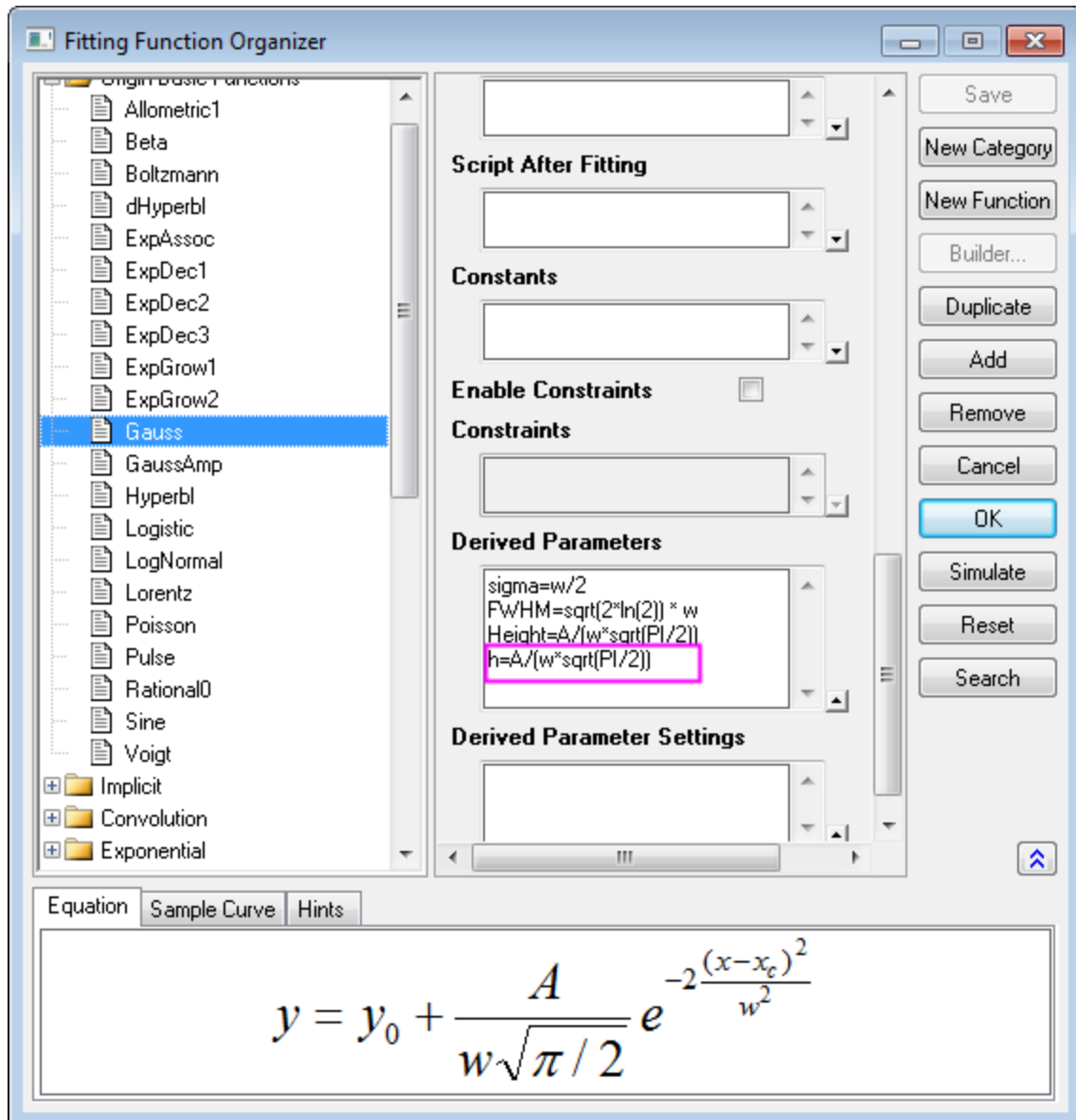

**Note:**

- Each derived parameter should be specified in a separate row.
  - Derived parameters cannot be computed from other derived parameters.
- Click on **Save** and the **OK** button.
  - Create a new workbook and import the data file `\samples\curve fitting\Gaussian.dat`, using **Data: Import from File: Single ASCII**.
  - Highlight column A and B, then select **Analysis: Fitting: Nonlinear Curve Fit** to open the **Nonlinear Curve Fitting** dialog, and select **Gauss** from the Function drop-down list.

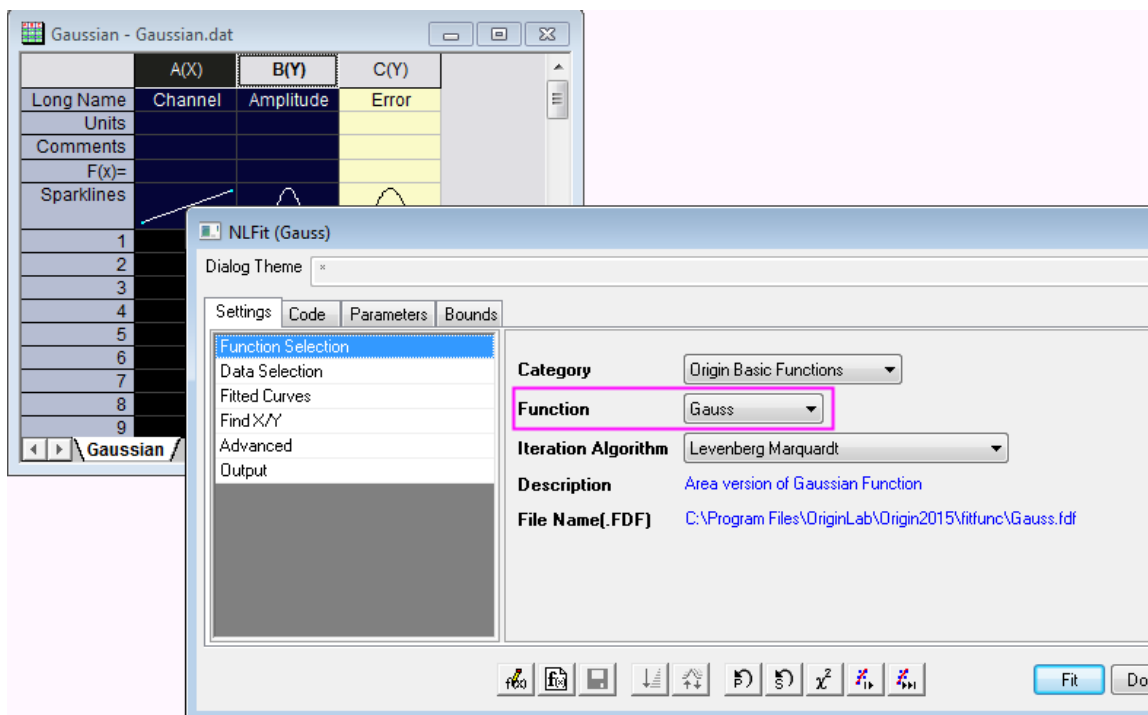

7. Go to **Code** tab and click **Derived parameters** on the left panel. You can see the Derived Parameters listed on the right panel.

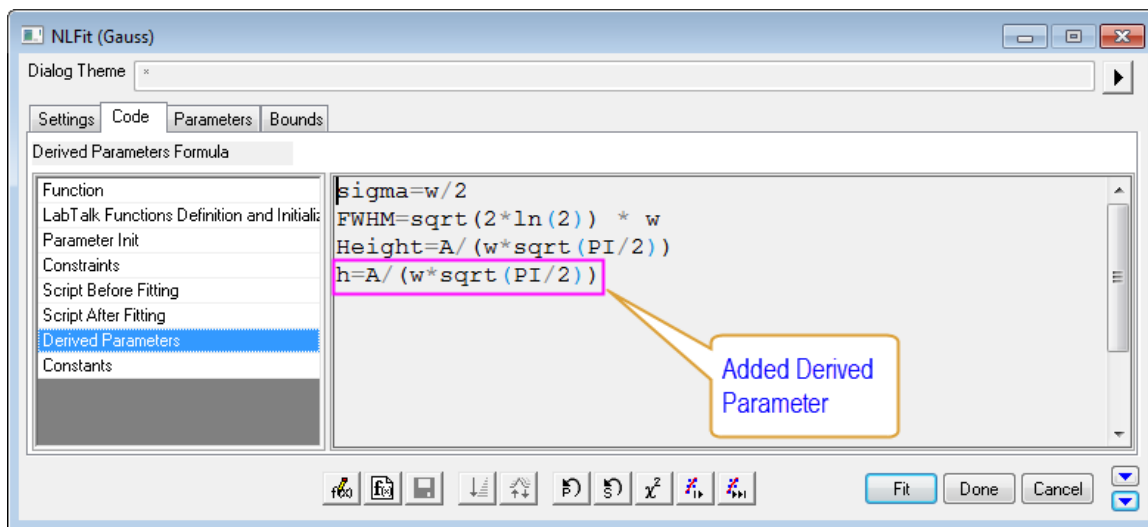

8. Click **Fit** button to generate report sheets. After fitting, Origin will compute the height and include the result in the Parameters table on the fitting results worksheet.

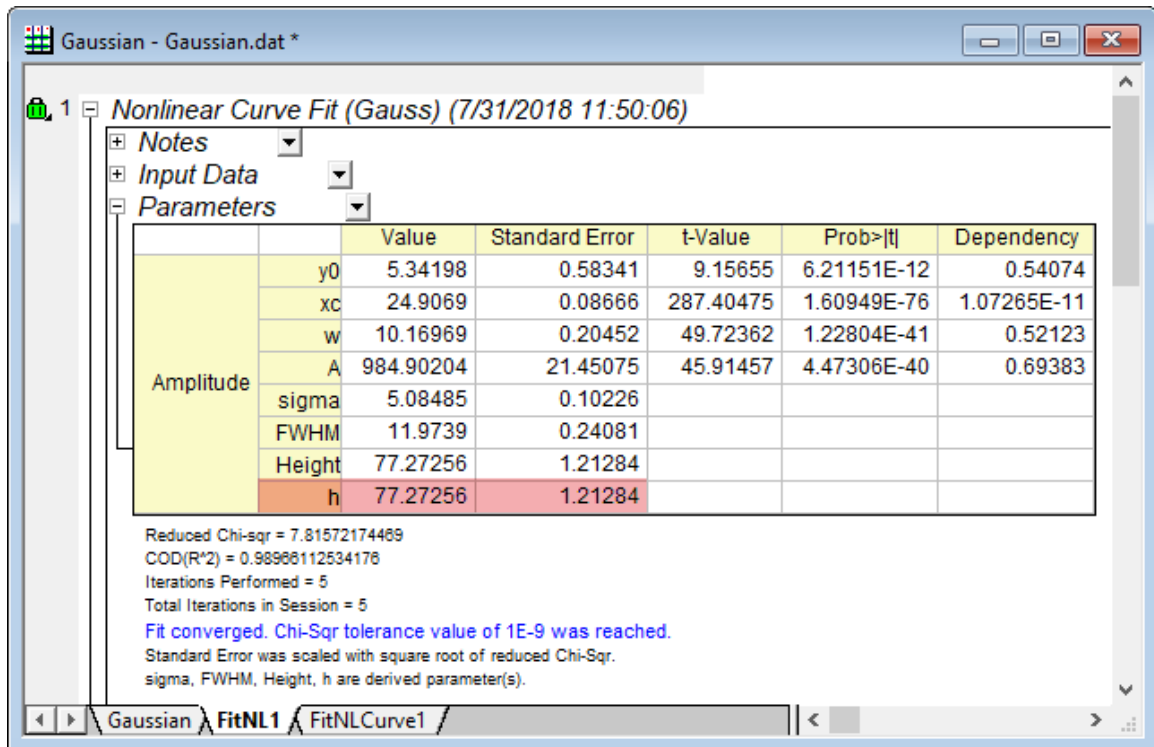

9. If you want to obtain the confidence interval for derived parameters, you can click on the green lock and select **Change Parameters** to go back to the **NLFit** dialog. Click **Advanced** option under **Settings** tab, expand **Quantities** node on the right panel and check the **LCL** and **UCL** checkboxes under **Fit Parameters** branch. Click **Fit** button to recalculate.

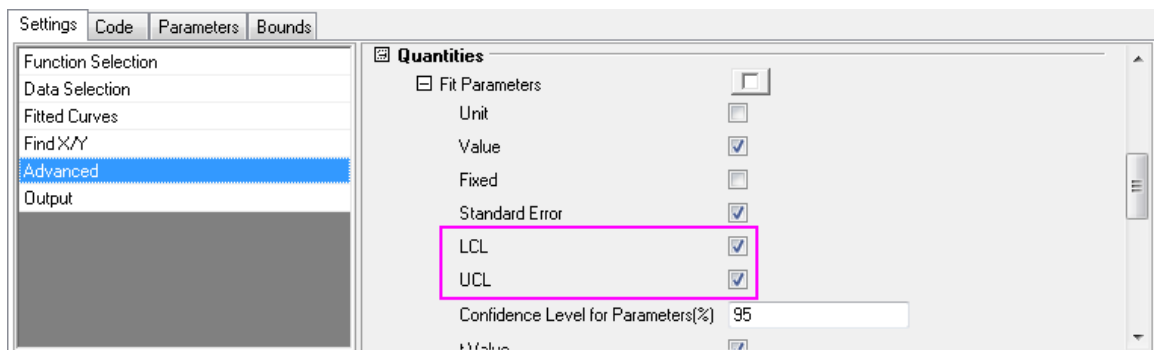

10. Then confidence interval 95% *LCL* and 95% *UCL* are calculated for both parameters and derived parameters as below:

Parameters

		Value	Standard Error	t-Value	Prob> t	95% LCL	95% UCL	Dependency
Amplitude	y0	5.34198	0.58341	9.15655	6.21151E-12	4.16764	6.51631	0.54074
	xc	24.9069	0.08666	287.40475	1.60949E-76	24.73246	25.08134	1.07265E-11
	w	10.16969	0.20452	49.72362	1.22804E-41	9.75801	10.58138	0.52123
	A	984.90204	21.45075	45.91457	4.47306E-40	941.72392	1028.08016	0.69383
	sigma	5.08485	0.10226			4.879	5.29069	
	FWHM	11.9739	0.24081			11.48917	12.45862	
	Height	77.27256	1.21284			74.83123	79.71389	
	h	77.27256	1.21284			74.83123	79.71389	

Reduced Chi-sqr = 7.81572174469  
 COD(R<sup>2</sup>) = 0.98966112534176  
 Iterations Performed = 5  
 Total Iterations in Session = 5  
 Fit converged. Chi-Sqr tolerance value of 1E-9 was reached.  
 Standard Error was scaled with square root of reduced Chi-Sqr.  
 sigma, FWHM, Height, h are derived parameter(s).

#### 4.3.3.32.4 Removing Derived Parameters

You can also remove derived parameters from result sheet. Continue with the tutorial above, follow the steps below:

1. Select **Tool: Fitting Function Organizer** in the menu to open the dialog again. In the left panel of the dialog, select **Origin Basic Functions: Gauss**.

- Go to **Derived Parameters** section and remove expression  $h=A/(w*\sqrt{\pi/2})$  from that panel.

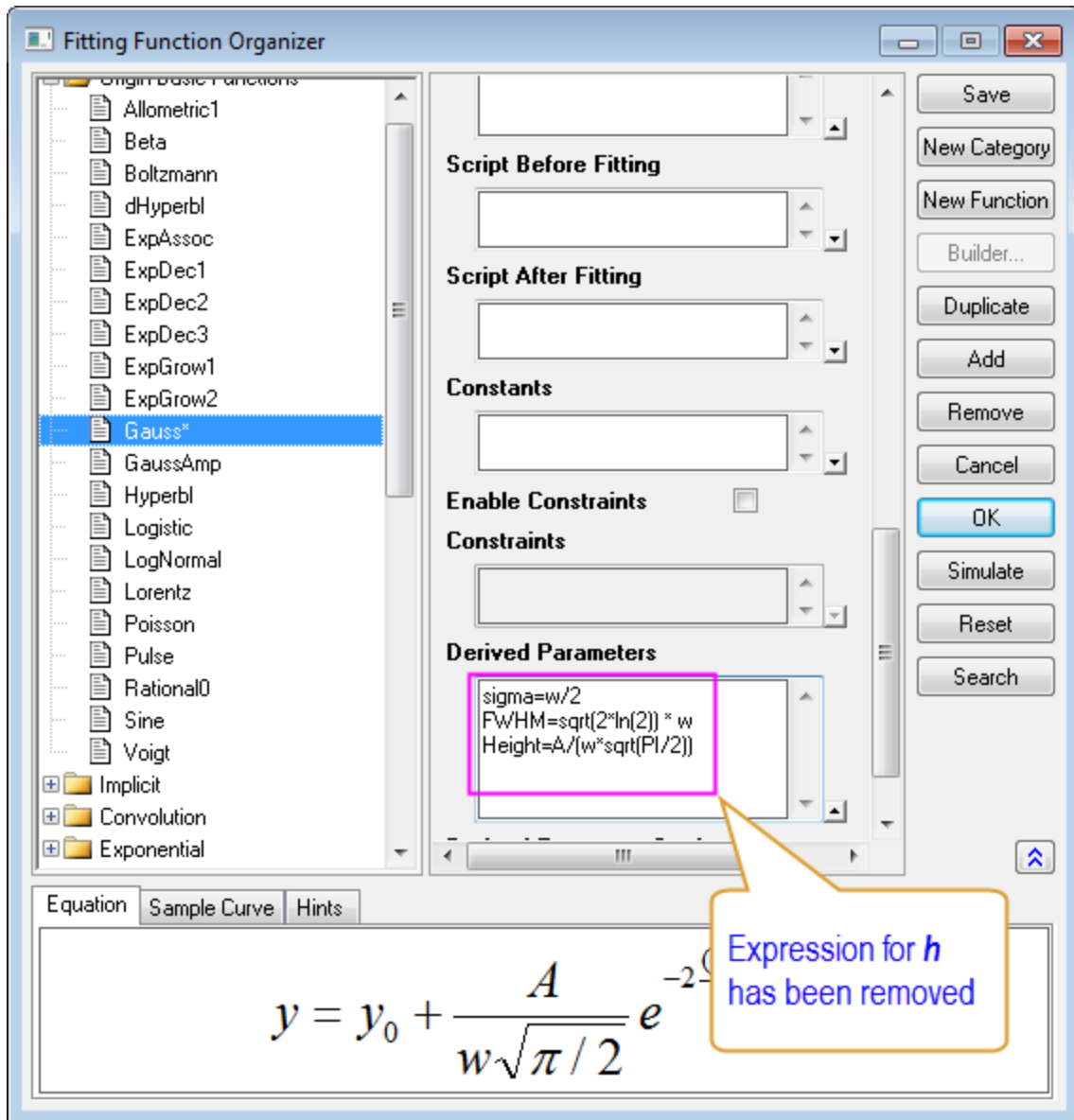

- You may need to wait one or two seconds before the **Save** button is enabled. Click **Save** button and then **OK** button to close dialog.
- Click on the green lock on the top left corner in result sheet *FitNL1* to change parameters and click **Fit** button again in the appeared **NLFit (Gauss)** dialog. We will see the derived parameter  $h$  has been removed from result table.

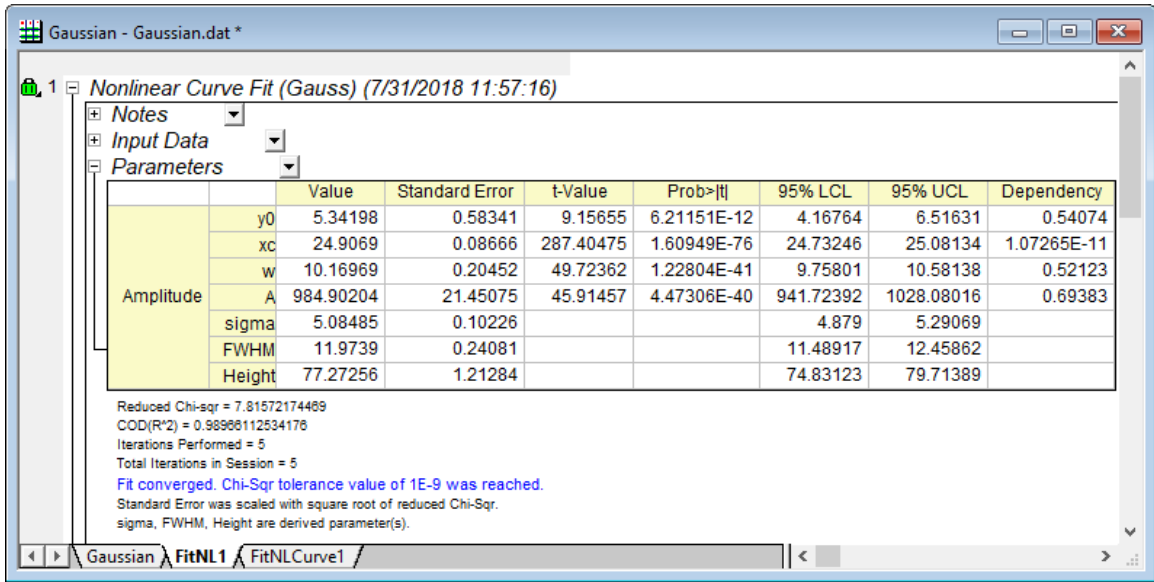

#### 4.3.3.33 Fit Multiple Datasets by Fitting One and then Using Those Fit Parameters for Other Datasets

##### 4.3.3.33.1 Summary

In some cases, you might have multiple datasets, and want to fit them using the user-defined function without parameter initial code. For increased efficiency, you can fit one and then apply the fit parameters for other datasets.

Minimum Origin Version Required: Origin 8.6

##### 4.3.3.33.2 What you will learn

This tutorial will show you how to:

- Create a user-defined fitting function in Fitting Function Builder
- Perform an independent fit.
- Fit one of multiple datasets by doing 1-iteration, full-iteration.
- Apply the parameter values of one dataset to other datasets.

##### 4.3.3.33.3 Steps

###### Create a User-Defined Function in Fitting Function Builder

The **Fitting Function Builder** can be used to create or edit a user-defined function. In the following section, we will define a fitting function *MyExp* with this tool.

1. Select **Tools: Fitting Function Builder...** from the main menu (or press **F8**) to open the **Fitting Function Builder**. Select the **Create a New Function** radio box.

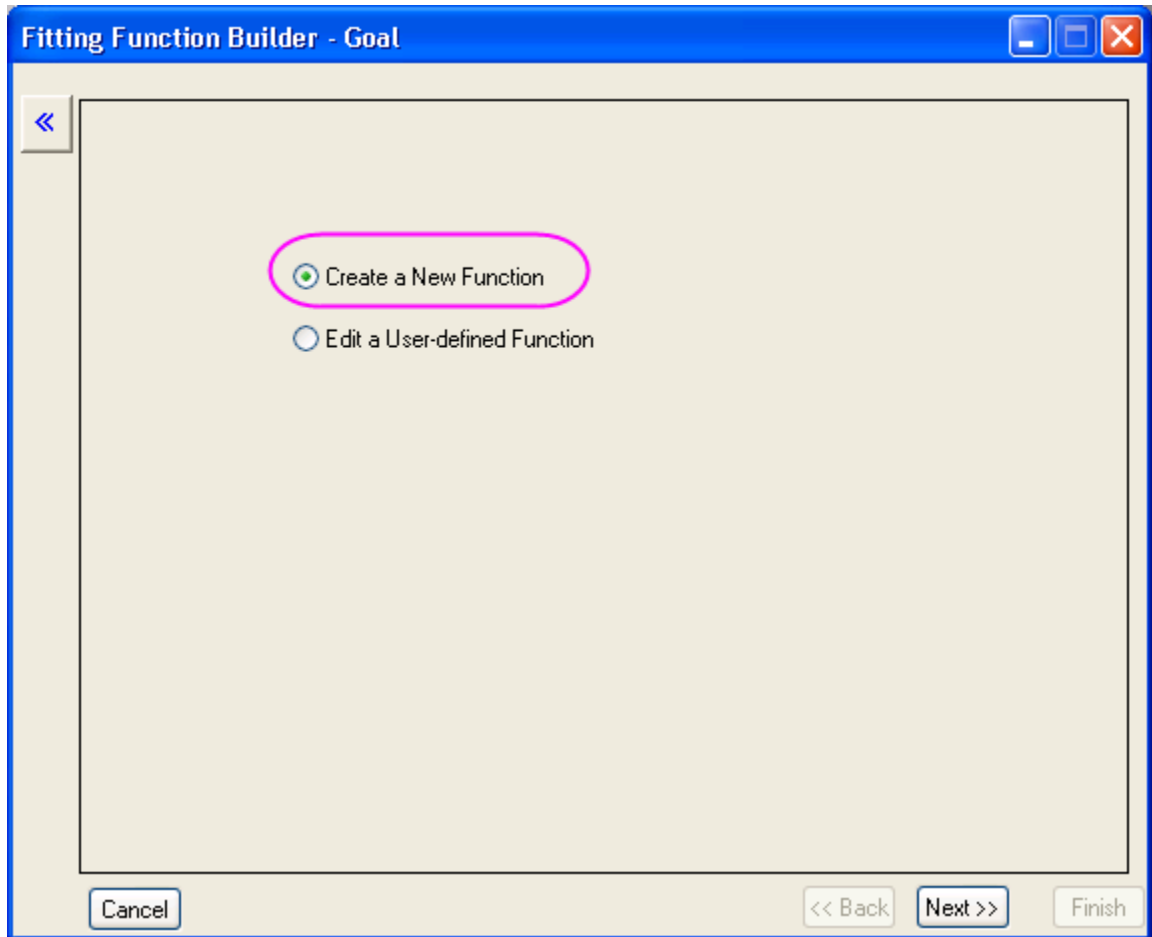

2. Click the **Next** button to go to the **Name and Type** page. Enter *MyExp* in the **Function Name** box and select the **Origin C** radio box for the **Function Type**.

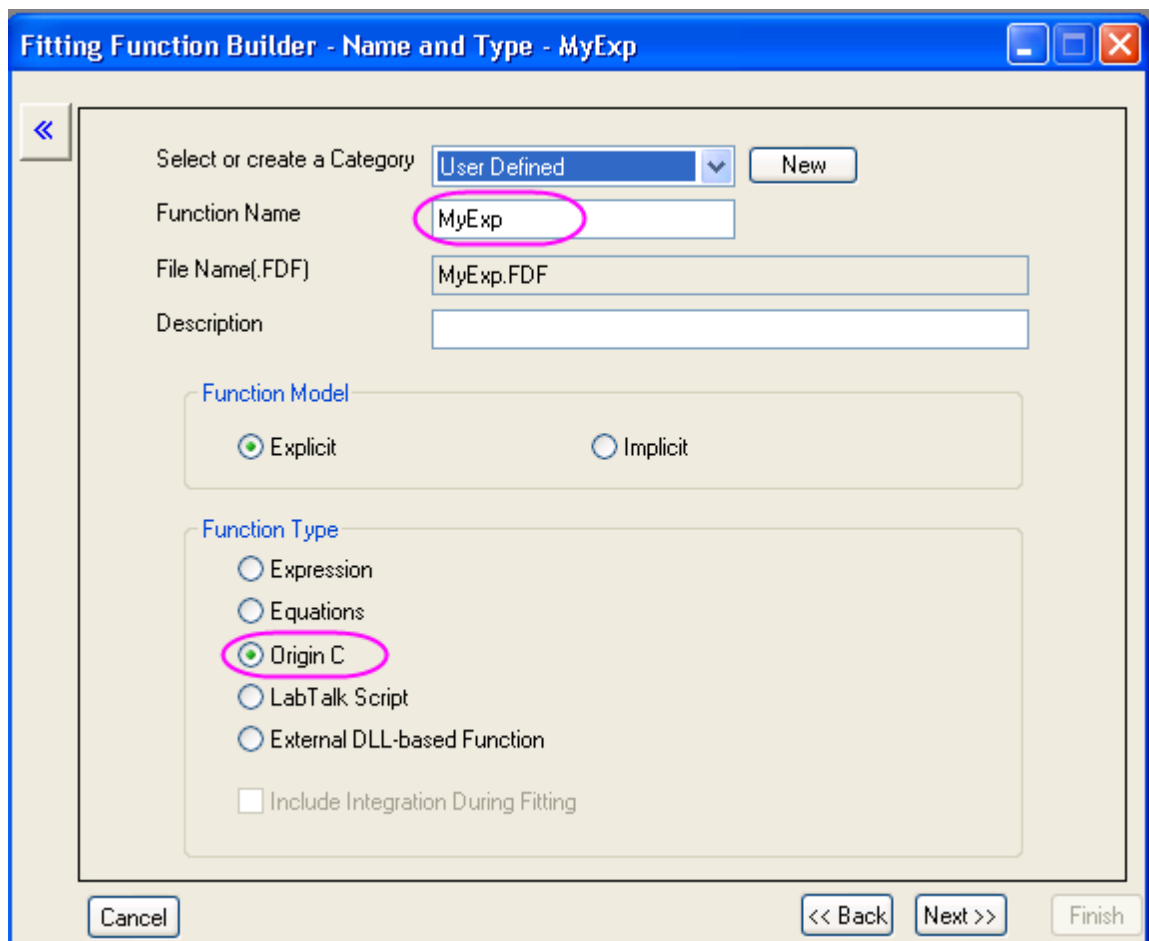

3. Click the **Next** button to go to the **Variables and Parameters** page. Enter the variables and parameters as shown in the following screenshot:



Fitting Function Builder - Variables and Parameters - MyExp

Independent Variables: x

Dependent Variables: y

Parameters: y0,a,b

Derived Parameters:

Constants:

Peak Function

Cancel << Back Next >> Finish

4. Click the **Next** button to go to the **Origin C Fitting Function** page. Enter the function body  $y=y0+a*exp(b*x)$  in the **Function Body** box. To verify the correctness of the function, click the button beside the Function box to open the Origin Code Builder.

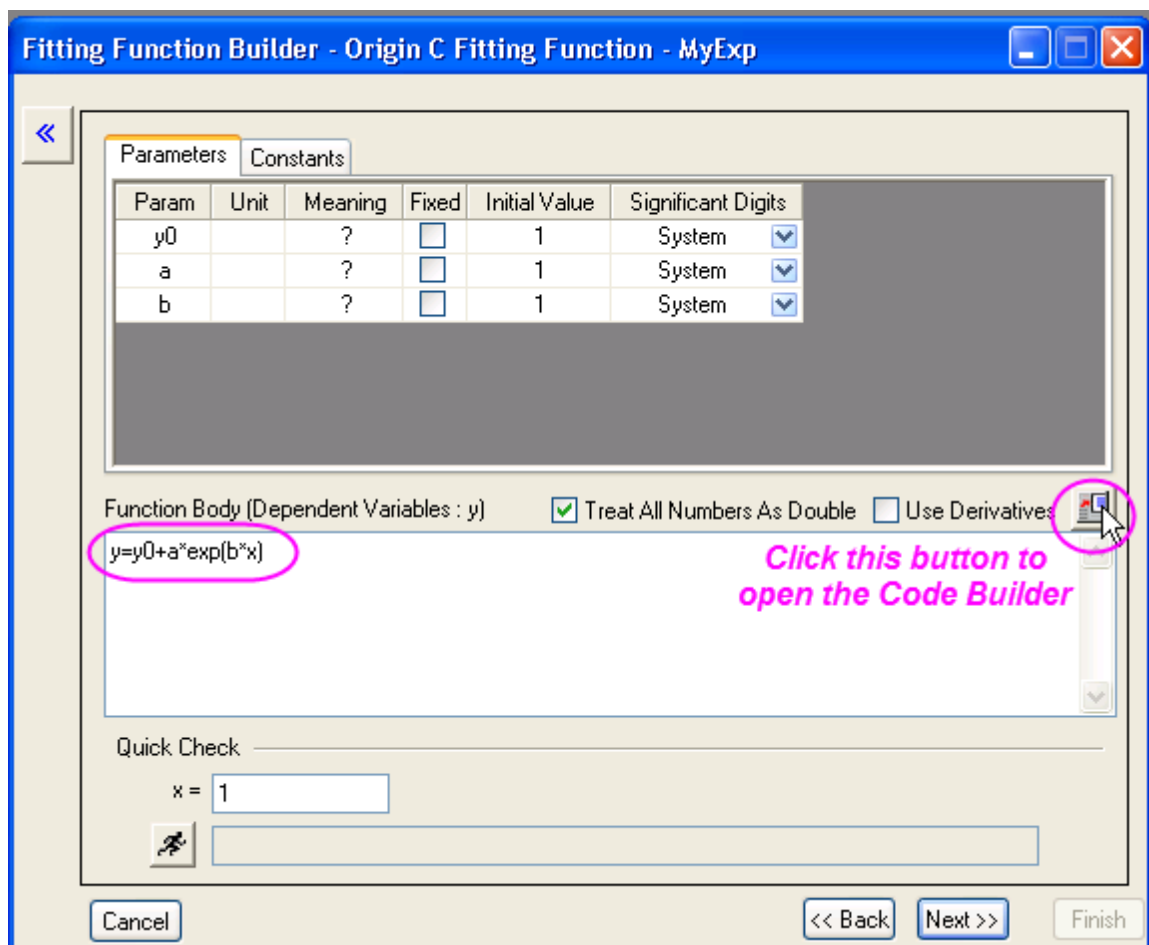

In the **Code Builder**, click the **Compile** button to compile the function. If passed, the message *Compile Done* will show, and then you can click the **Return to Dialog** button to return to the **Fitting Function Builder**.

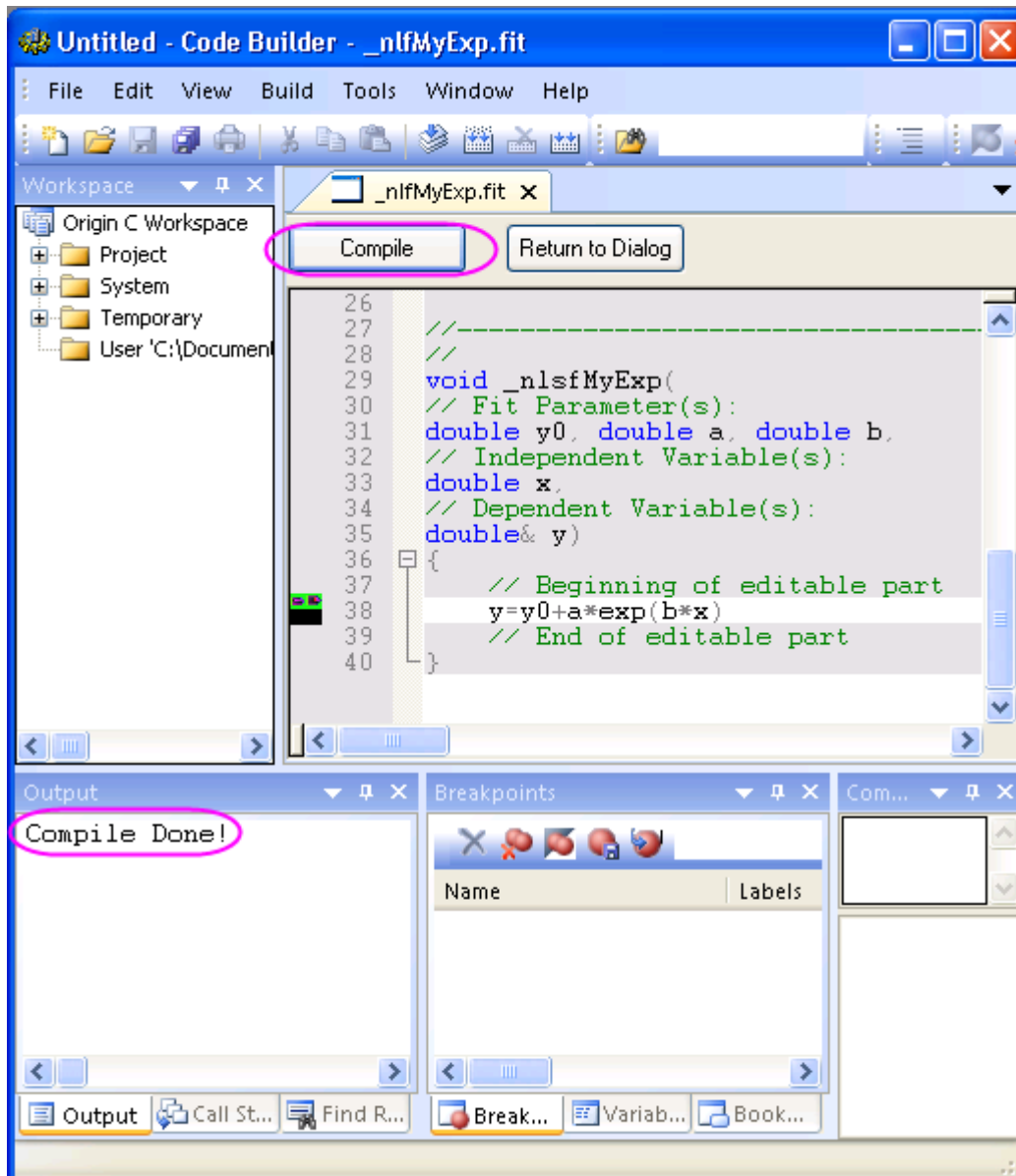

5. Click the **Finish** button to create this fitting function *MyExp*.

#### Fit Multiple Dataset with User-Defined Fitting Function

1. Import `\Samples\Curve Fitting\Exponential Decay.dat` to Origin worksheet.
2. Highlight all columns and then select **Analysis: Fitting: Non-linear Curve Fit** from the menu to open the **NLFit** dialog.
3. Select the function just defined in **Settings** tab, **Function Selection** page:

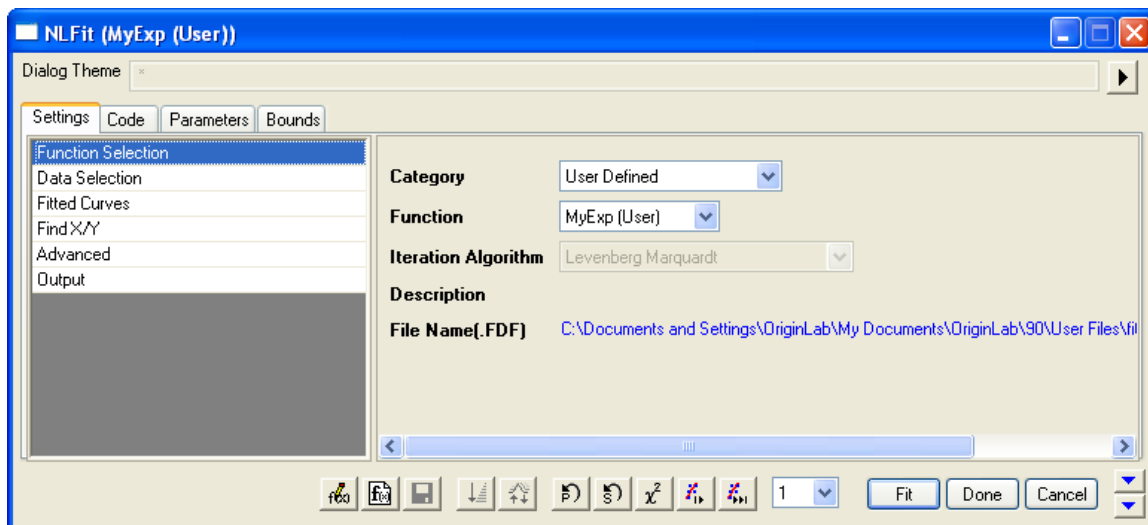

- Switch to **Parameters** tab, enter *80, 100, -5* on the **Value** column as initial values for  $y_0, a, b$  of the first dataset. Then select *1* from the independent fit drop-down list and iterate the first dataset until converged.

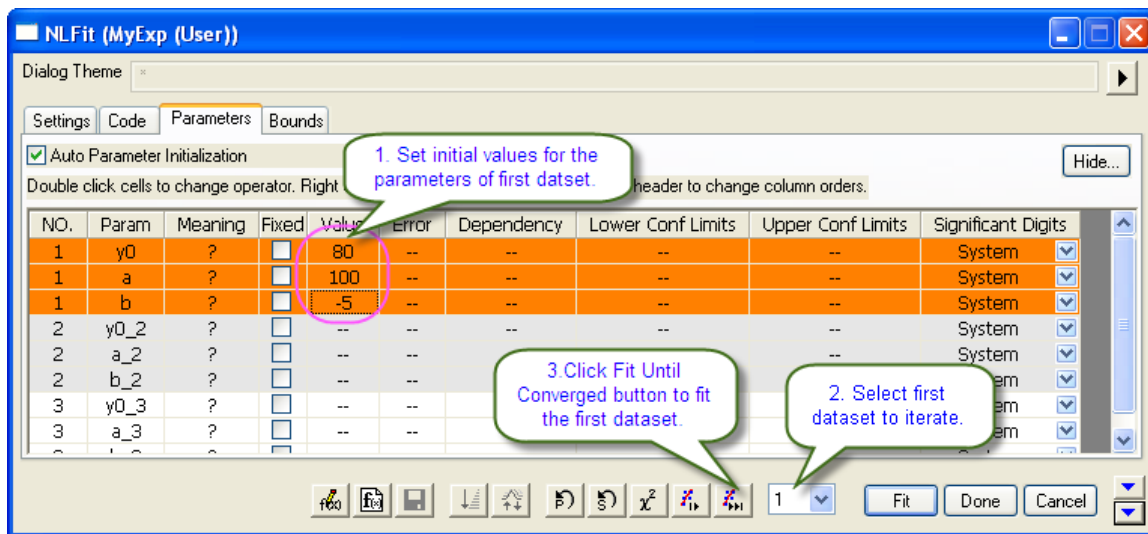

- The parameter values are calculated and the fitting result is hinted in the bottom left corner of this dialog.

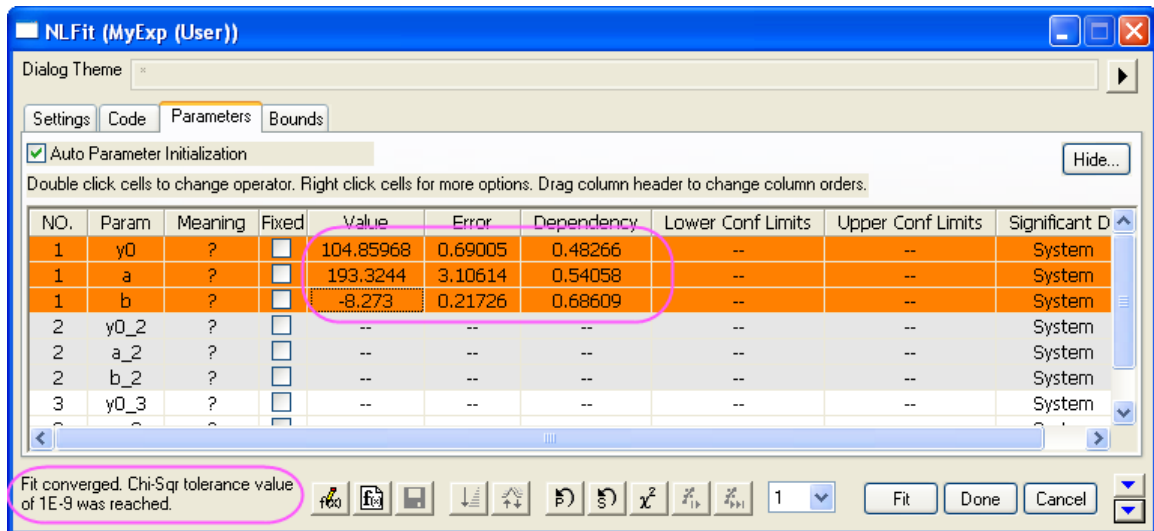

6. To initialize the parameters of other datasets, apply the parameter values of the first dataset to other datasets by right-clicking the values, and then selecting **Apply Whole Set of "Value" to All Datasets** from the fly-out menu.

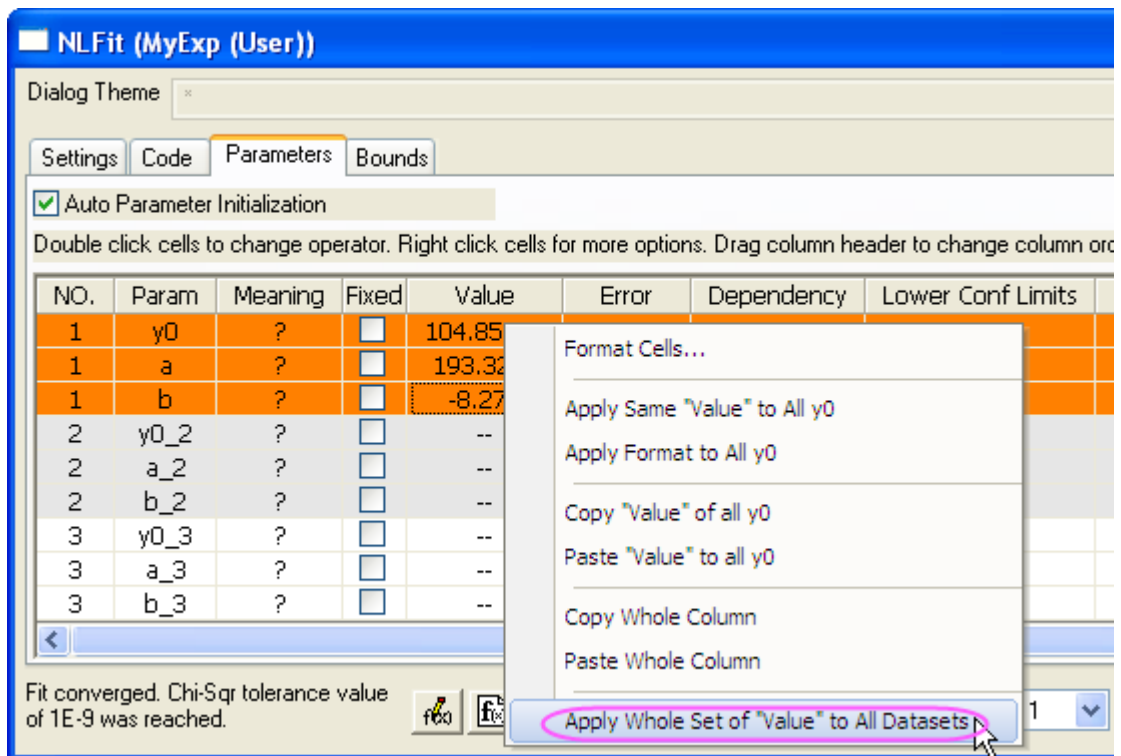

7. Click **Fit** button to finish the fitting for all datasets.

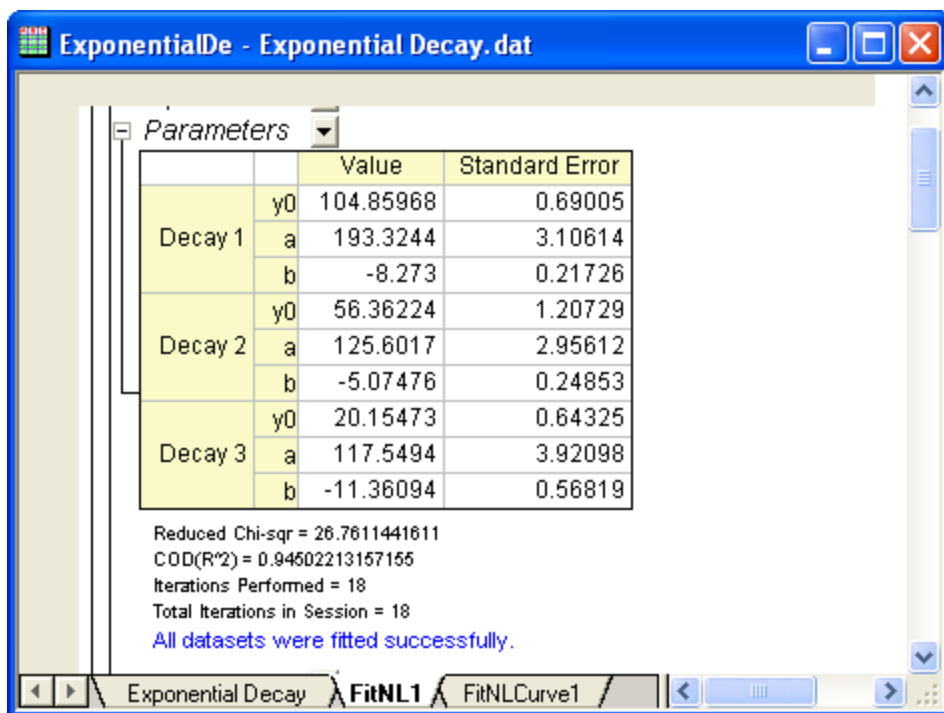

#### 4.3.3.34 Implicit Fitting with Three Variables

##### 4.3.3.34.1 Summary

This tutorial will show you how to define an implicit fitting function with three independent variables, then perform implicit fitting with it on fitting data.

Minimum Origin Version Required: OriginPro 9.0 SR1

##### 4.3.3.34.2 What you will learn

This tutorial will show you how to:

1. Define an implicit fitting function.
2. Perform implicit fitting with three independent variables.
3. Plot the fitted surface manually.

##### 4.3.3.34.3 Examples and Steps

###### Import Data

1. Click the **Import Single ASCII** button  to bring up the Open dialog. Browse to `\Samples\Curve Fitting` folder and select the file `Ellipsoid.dat` file.
2. Highlight column C, right click on selection and choose **Set As: Z** from the context menu. Select **Plot: 3D Symbol/Bar/Vector: 3D Scatter** from Origin menu. Double click on the graph. In the **Plot Details** dialog, select **Layer1** in the left panel, click **Axis** tab, set **X, Y, Z Length** as 100, 75, 50 respectively.

Click the **Fit frame to layer** button in the **3D Rotation** toolbar. The graph should look like:

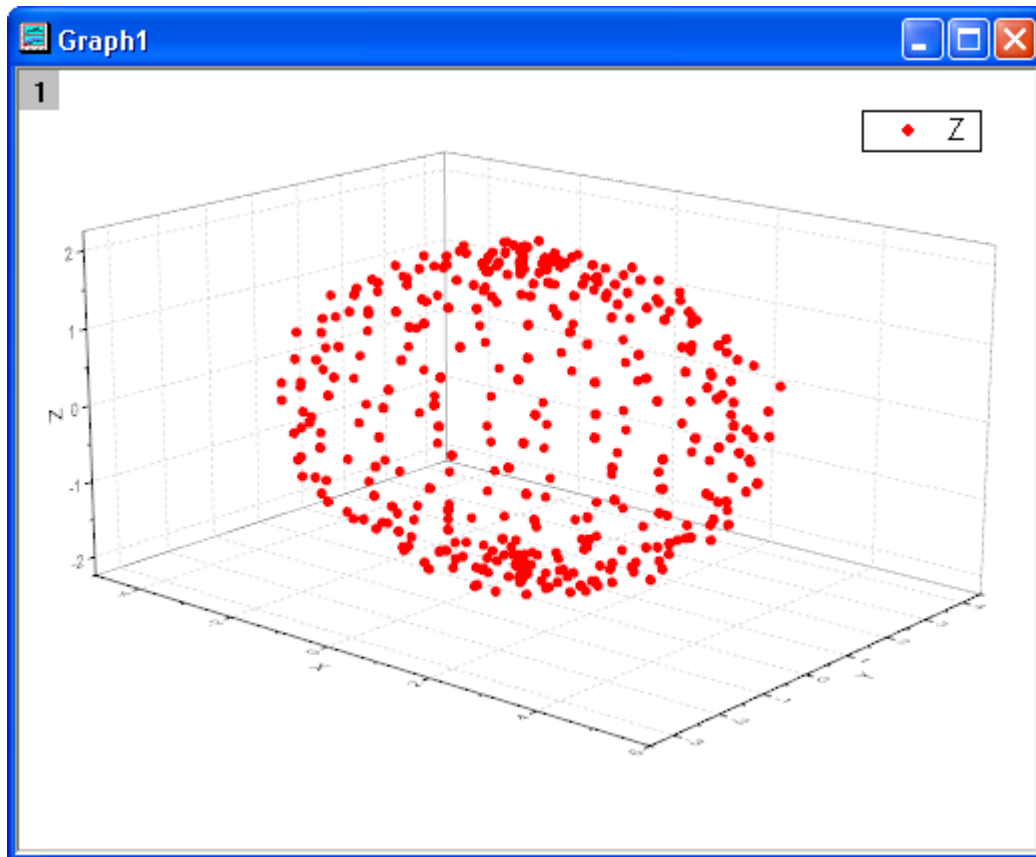

#### Define Fitting Function

The graph can be fitted with an ellipsoid. The function can be expressed as:

$$\frac{(x - x_0)^2}{a^2} + \frac{(y - y_0)^2}{b^2} + \frac{(z - z_0)^2}{c^2} = 1$$

where  $(x_0, y_0, z_0)$  is the ellipsoid's center location, **a**, **b** and **c** are semi-principal axes lengths, **x**, **y** and **z** are three independent variables for fitting data.

The fitting function can be defined using the **Fitting Function Builder** tool.

1. Select **Tools: Fitting Function Builder** from the Origin menu.
2. In the **Fitting Function Builder** dialog's **Goal** page, click **Next**.
3. In the **Name and Type** page, select **Implicit** from **Select or create a Category** drop-down list, type **Ellipsoid** in the **Function Name** field, and select **Implicit** in **Function Model** group. And click **Next**.

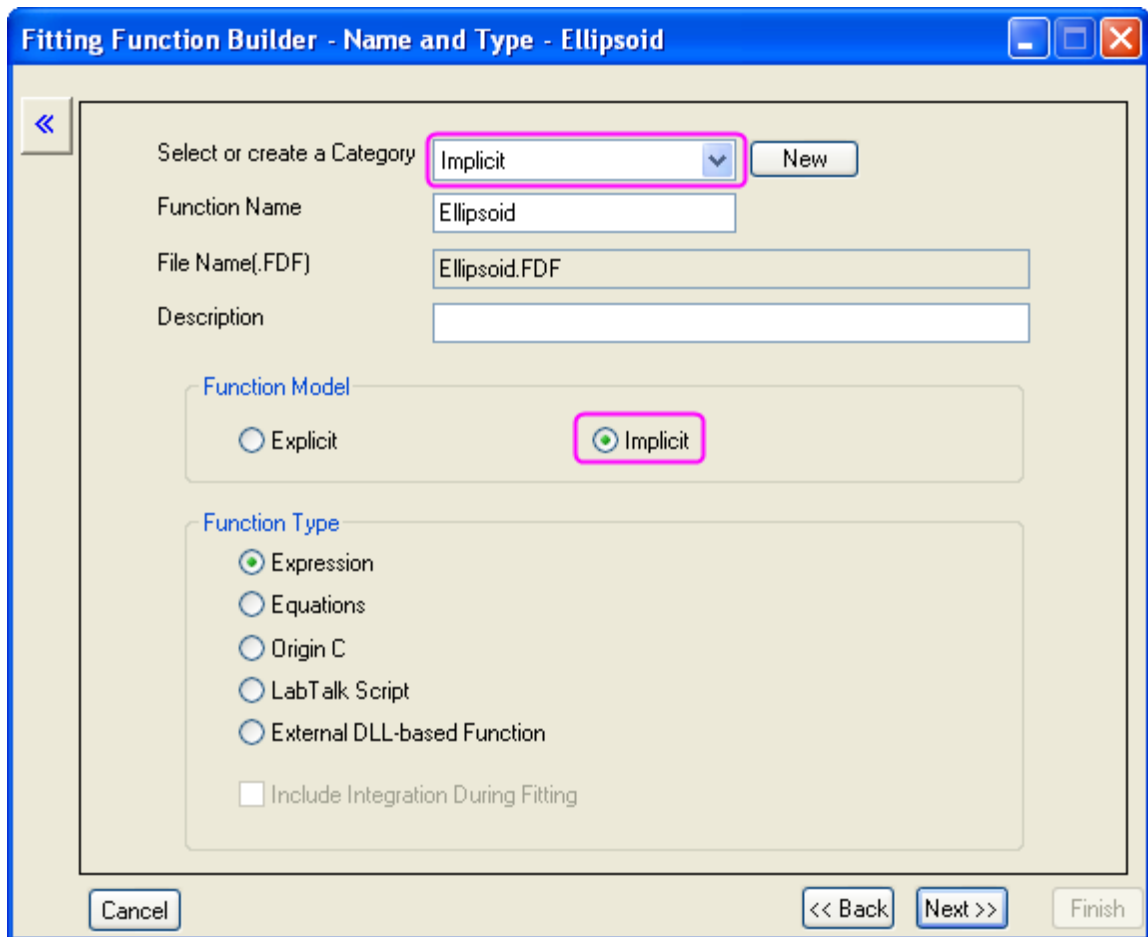

**Note** that implicit functions must be defined in **Implicit** category.

4. In the **Variables and Parameters** page, type **x, y, z** in the **Variable** field and **x0, y0, z0, a, b, c** in the **Parameter** field. Click **Next**.
5. In the **Expression Function** page, type the following script in the **Function Body** edit box.

```
(x-x0)^2/a^2+(y-y0)^2/b^2+(z-z0)^2/c^2-1
```

**Note** that for an implicit function  $f_1(x_i, p_i) = f_2(x_i, p_i)$  where  $x_i$  ( $i=1,2..$ ) are independent variables,  $p_i$  ( $i=1,2..$ ) are parameters, it must be defined as  $f = f_1(x_i, p_i) - f_2(x_i, p_i)$  in Origin where **f** is the **Estimate**.

Set initial parameters as follows in the **Parameters** tab.





x0=0 y0=0 z0=0 a=3 b=3 c=3

In the **Quick Check** group, click **Evaluate** button, it shows  $f=-0.667$  at  $x=1, y=1, z=1$ .

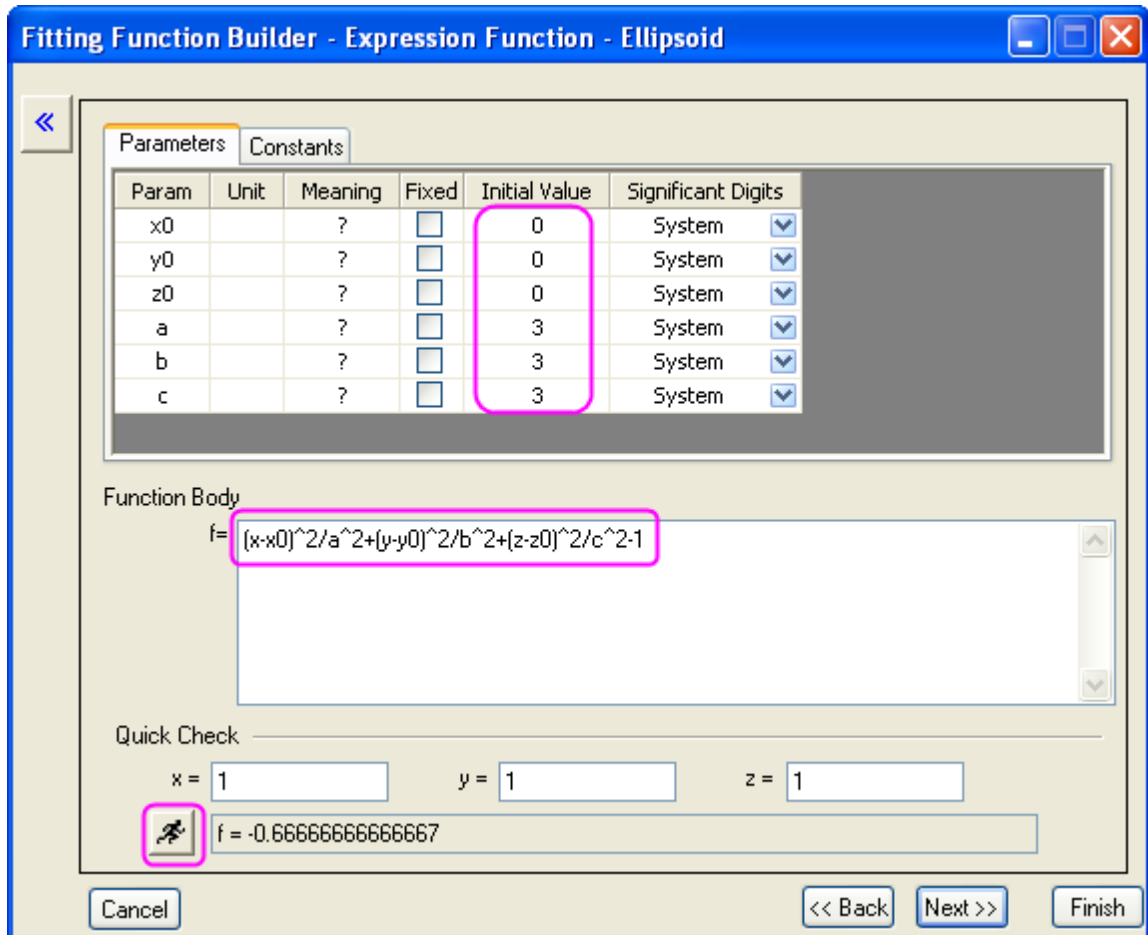

Click **Next** button, then click **Next** button again.

- In the **Bounds and General Linear Constraints** page, set lower bounds for **a**, **b** and **c**,

a>0 b>0 c>0

Click **Finish** button to close the dialog.

**Note** that a message in **Messages Log** is shown that the implicit function is saved in the **User Files** folder.

#### Fit the Curve

- For implicit fitting with more than 2 independent variables, Origin only supports input data from workbooks not graphs. So we have to make the workbook for fitting data active before fitting. Select

**Analysis: Fitting: Nonlinear Implicit Curve Fit** from Origin menu. In the **NLFit** dialog, select **Settings: Function Selection**, in the page select **Ellipsoid** function from the **Function** drop-down list.

2. Select **Data Selection** page, expand **Input Data: Range1**, and choose column A as X, column B as Y and column C as Z. An error message is shown at the bottom of the **Settings** panel. Following the suggestion of the error message, go to the **Fitted Curves** page and change the Data Type of X to **Fitted Point for Input Data**. The **Data Type of y** and **z** should automatically change as well.

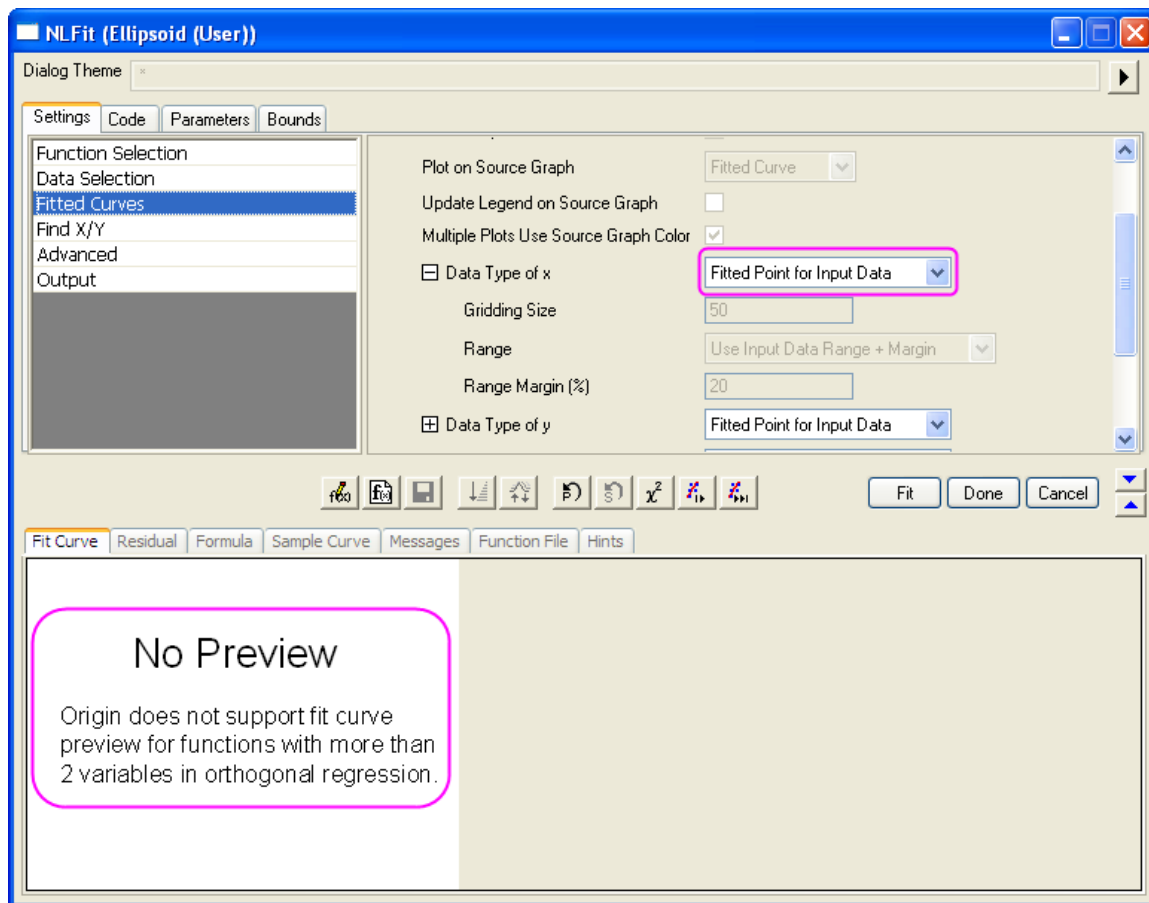

**Note** that Origin doesn't support **Fit Curve** preview in the **NLFit** dialog or fitted surface in the fitted report for implicit fitting with more than two independent variables.

3. Since initial parameters have been set in **Fitting Function Builder** dialog, we can click **Fit** button to fit the curve.

**Fitting Results**

Switch to the fitted report. **Parameters** and **Statistics** tables are shown in the report.

Fitted Parameters are shown as follows.

Parameter	Value	Standard Error
<b>x0</b>	0.41073	0.01576

<b>y0</b>	0.32043	0.01352
<b>z0</b>	0.00147	0.00749
<b>a</b>	4.00325	0.02076
<b>b</b>	3.00097	0.01881
<b>c</b>	1.99972	0.00933

And **Adj. R-Square** is 0.99823, which means the fitted result is very good. **Note** that this result is from Origin9.0 32Bit, while in Origin9.0 64Bit the result is slightly different, and the latter is better.

In the **FitODRCurve1** worksheet, the first three columns show **XYZ** coordinates for fitted points.

**Note** that in the implicit fitting, **x**, **y** and **z** are all independent variables, they will all be adjusted during iterations in the fitting.

#### Fitted Surface

Although Origin9.0SR1 doesn't show the fitted surface in the fitted report for implicit fitting with more than two independent variables, in this example you can plot the fitted ellipsoid using **3D Parametric Function Plot** tool in Origin as follows.

1. Make the fitted report active, run following LabTalk script in the **Script Window** in order to get fitted parameter variables.

```
getnlr tr:=tt;

x0=tt.x0;

y0=tt.y0;

z0=tt.z0;

a=tt.a;

b=tt.b;

c=tt.c;
```

Variables **x0**, **y0**, **z0**, **a**, **b** and **c** can be used in following steps.

2. Make **Graph1** active. Select **File: New: Function Plot: 3D Parametric Function Plot** from Origin menu. In the **Create 3D Parametric Function Plot** dialog, set **u** from 0 to pi, **v** from 0 to 2\*pi. And define **X**, **Y** and **Z** as follows.

$$X(u, v) = x_0 + a * \sin(u) * \cos(v)$$

$$Y(u, v) = y_0 + b * \sin(u) * \sin(v)$$

$$Z(u, v) = z_0 + c * \cos(u)$$

And choose **Add to Active Graph** from the drop-down list at the bottom left of the dialog.

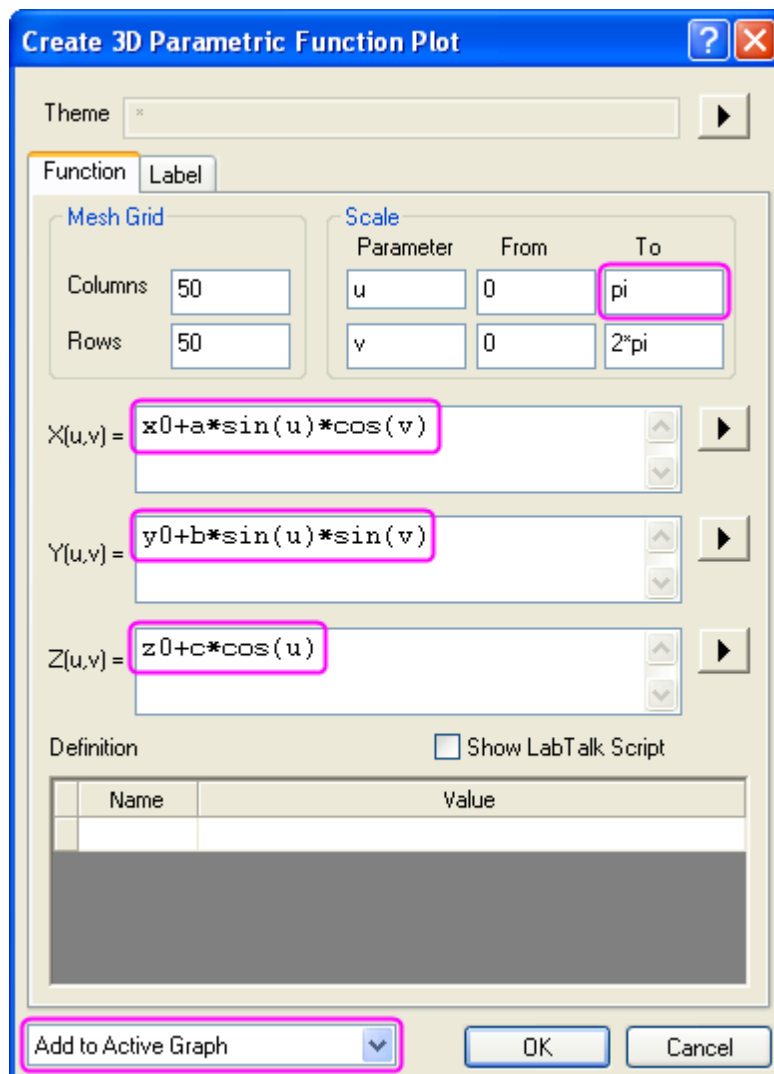

Click **OK** button to close the dialog. A 3D ellipsoid plot will be added to **Graph1**.

3. Double click on the graph. In the **Plot Details** dialog, you can customize the graph as follows.
 

**Note** that only OpenGL of 2.1 or higher version supports 3D transparency in Origin9.0. You can select **Preferences: 3D OpenGL Settings** from Origin menu to see your OpenGL version, if your OpenGL version is lower than 2.1, you should ignore the setting for 3D transparency in Step 3.2.

  1. Select **Layer1** in the left panel, click **Size/Speed** tab, clear **Worksheet data, maximum points per curve** check box in the **Speed Mode, Skip Points if needed** group. Click **Lighting** tab, choose **Directional** in the **Mode** group, and select blue color as **Ambient** color in the **Light Color** group.
  2. Select the second plot in the **Layer1** branch, click **Surface** tab, set **Transparency** as 50%. Select **Fill** tab, and change **Fill piece by piece** color to white in the **Front Surface** group. Click **OK** button to close the dialog.

The graph for the fitted ellipsoid will look like:

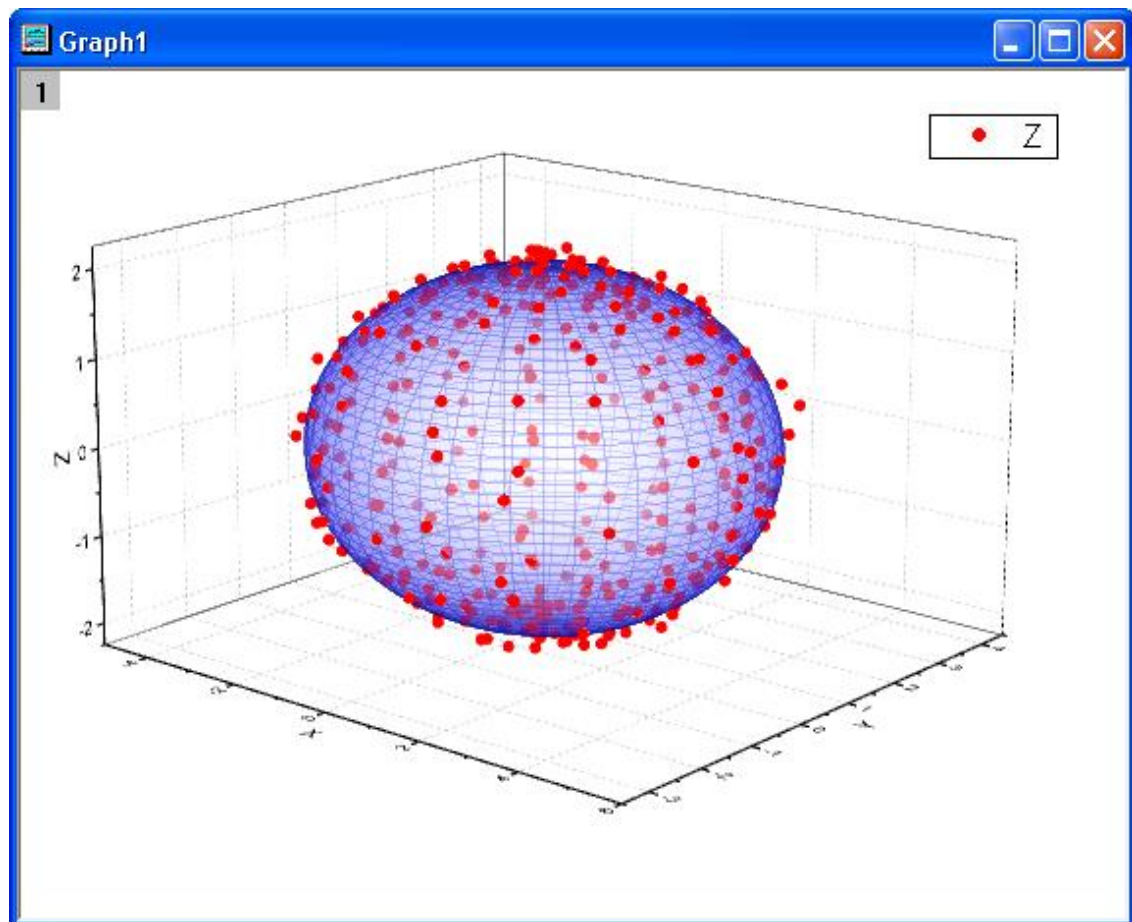

#### 4.3.3.35 Nonlinear fitting using Orthogonal Distance Regression

##### 4.3.3.35.1 Summary

When performing non-linear curve fitting to experimental data, one may encounter the need to account for errors in both independent variables and dependent variables. In Origin, you can utilize the Orthogonal

Distance Regression (ODR) to fit your data with implicit or explicit functions. This tutorial will demonstrate how to perform non-linear curve fitting on data with both X errors and Y errors using ODR with a built in function.

Minimum Origin Version Required: Origin 9.1

#### 4.3.3.35.2 What you will learn

This tutorial will show you how to use Orthogonal Distance Regression to fit nonlinear data with both X and Y errors.

#### 4.3.3.35.3 Example and Steps

1. Open a new workbook.
2. Click the **Import Single ASCII** button  to bring up the Open dialog. Browse to the **\Samples\Curve Fitting** folder and select the file **ODR fitting.dat**.
3. Highlight column *XError* (long name) and right click to select **Set As: X Error** to set it as X error column.
4. Highlight column *YError* (long name) and right click to select **Set As: Y Error** to set it as Y error column.
5. Highlight all four columns and go to **Plot:Symbol:Scatter** to make a scatter plot with both X and Y error bars.
6. Go to **Analysis:Fitting:Nonlinear Curve Fit:Open dialog...** to open **NLFit** dialog.
7. On **Function Selection** page, select **Category** as **Polynomial**, **Function** as **Poly4** and **Iteration Algorithm** as **Orthogonal Distance Regression (Pro)**.

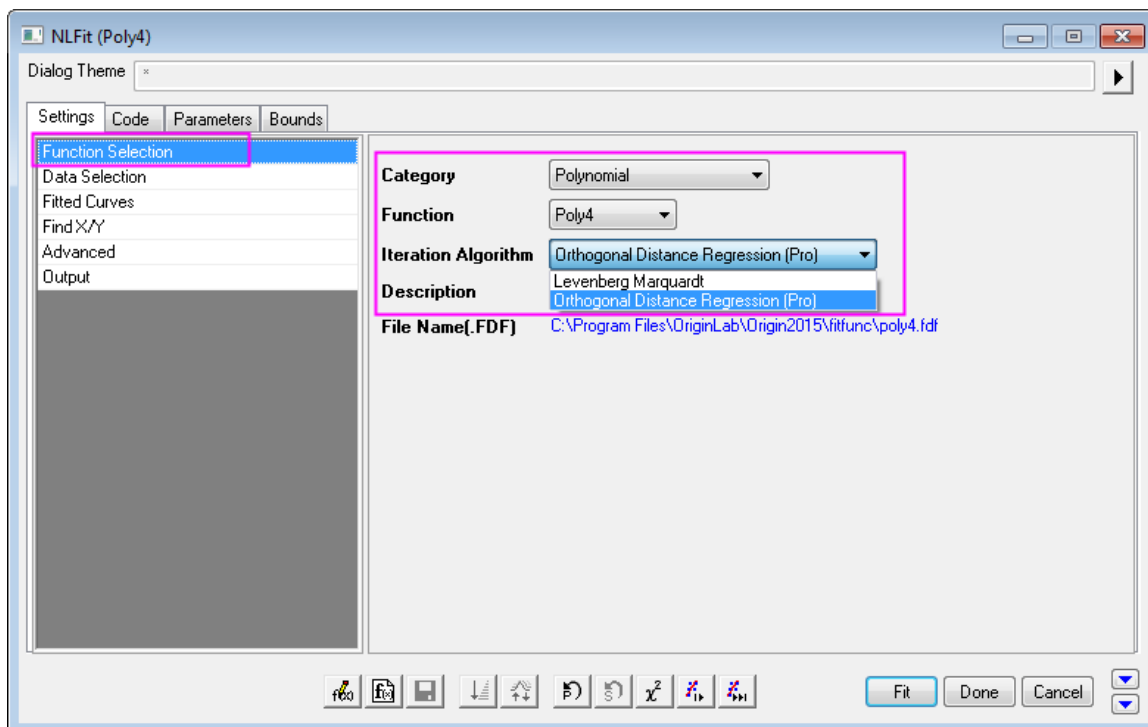

8. Since X error and Y error columns have been specified in step 3, 4 so that when **Orthogonal Distance Regression** is selected as iteration algorithm these two columns will be automatically assigned as corresponding weight for X and Y data respectively. You can go to **Data Selection** page and expand **x**

and **y** nodes under **Input Data** to see.

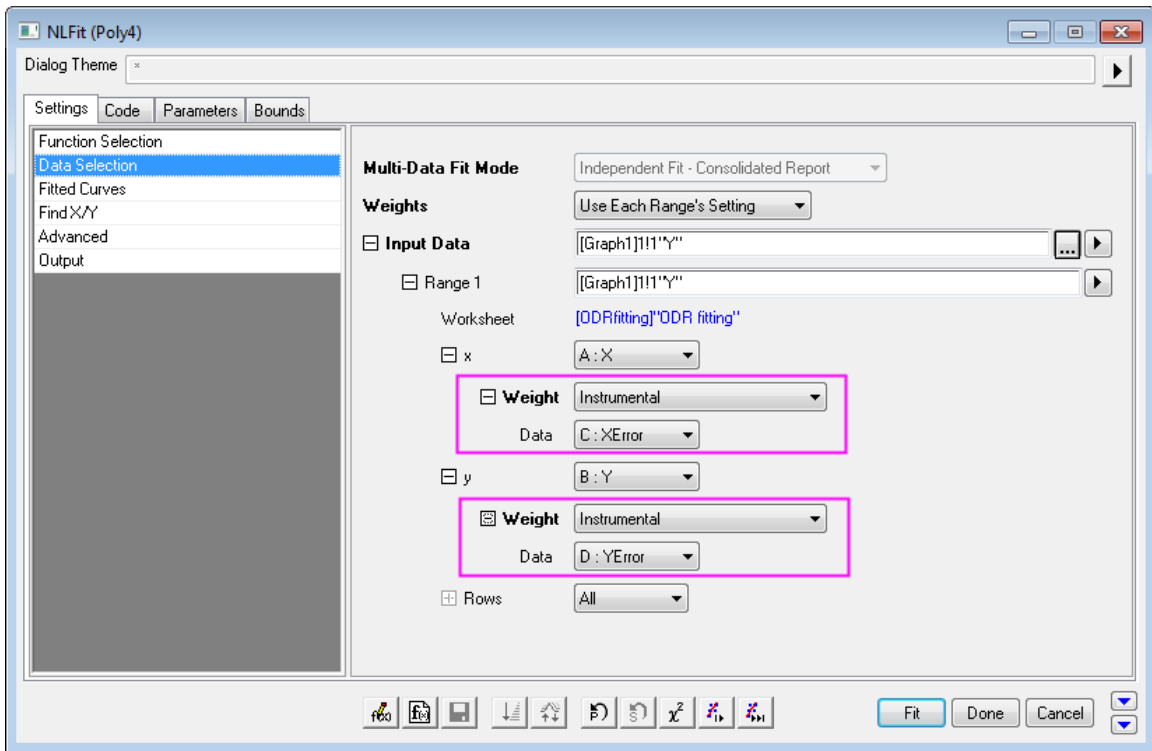

- Click **Fit** button and choose **No** radio box in the appeared **Reminder Message** dialog, and click **OK** to close it, the fitting results are as shown below:

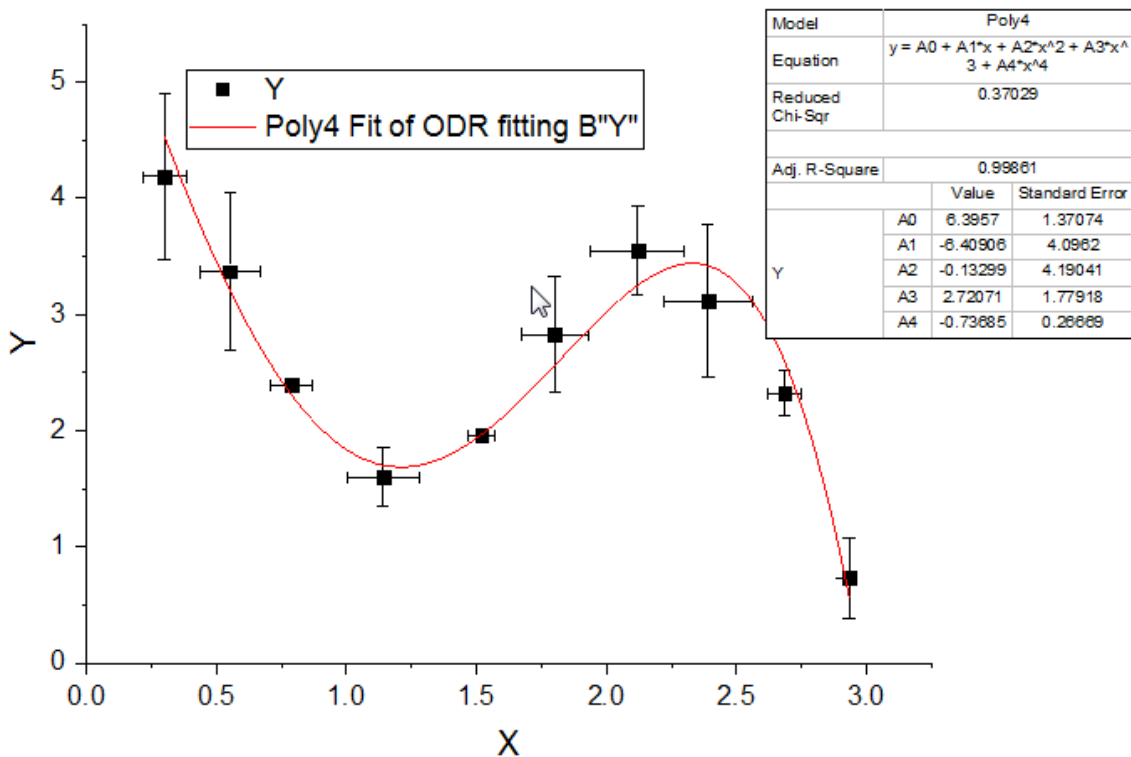

You can refer to [this page](#) for the details of the algorithm of ODR as well as Levenberg Marquardt (L-M) algorithm. Another example of using Orthogonal Distance Regression for Implicit Functions can be found [here](#).

## 4.4 Signal Processing

### 4.4.1 Signal Processing

- [FFT and IFFT](#)
- [FFT Filter](#)
- [Smoothing](#)
- [STFT \(Short-Time Fourier Transform\)](#)
- [IIR Filter](#)
- [2D FFT and Filter](#)
- [Convolution](#)
- [Wavelet](#)
- [Coherence and Correlation](#)
- [Decimation and Signal Envelope](#)
- [Rise Time](#)
- [Sound Processing](#)

### 4.4.2 FFT and IFFT

#### 4.4.2.1 [Summary](#)

FFT (Fast Fourier Transform) is able to convert a signal from the time domain to the frequency domain. IFFT (Inverse FFT) converts a signal from the frequency domain to the time domain. The FFT of a non-periodic signal will cause the resulting frequency spectrum to suffer from leakage. Origin provides several windows for performing FFT to suppress leakage.

#### 4.4.2.2 [What You Will Learn](#)

In this tutorial, you will learn how to:

- Perform FFT on signal with different windows.
- Recover the original signal with the spectrum.
- Perform FFT on a graph by using the FFT gadget.

#### 4.4.2.3 [FFT Gadget](#)

Origin's FFT gadget places a rectangle object to a signal plot, allowing you to perform FFT on the data contained in the rectangle. This is convenient for quickly observing the FFT effect on the data.

The following tutorial shows how to use the FFT gadget on the signal plot.



1. Start with a new workbook, and import the data <Origin Installation Directly>\Samples\Signal Processing\Chirp Signal.dat.

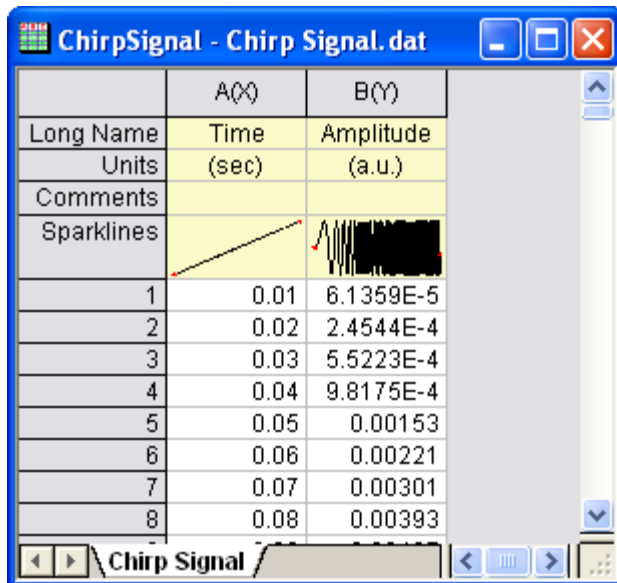

	A(X)	B(Y)
Long Name	Time	Amplitude
Units	(sec)	(a.u.)
Comments		
Sparklines		
1	0.01	6.1359E-5
2	0.02	2.4544E-4
3	0.03	5.5223E-4
4	0.04	9.8175E-4
5	0.05	0.00153
6	0.06	0.00221
7	0.07	0.00301
8	0.08	0.00393

2. Highlight column B and make a line plot by clicking menu item **Plot>2D: Line: Line**.

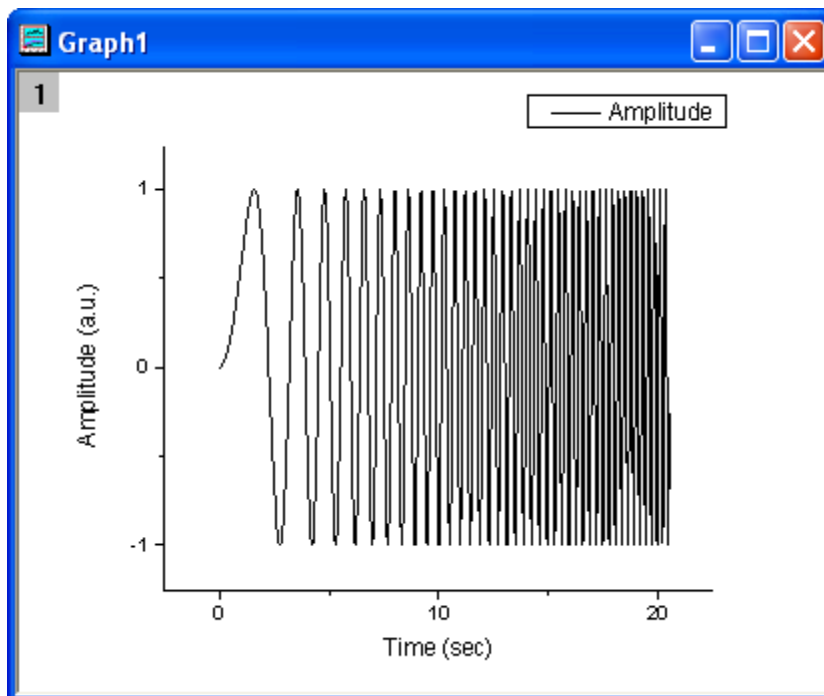

3. With the plot active, select menu **Gadgets: FFT...** to start the FFT gadget.

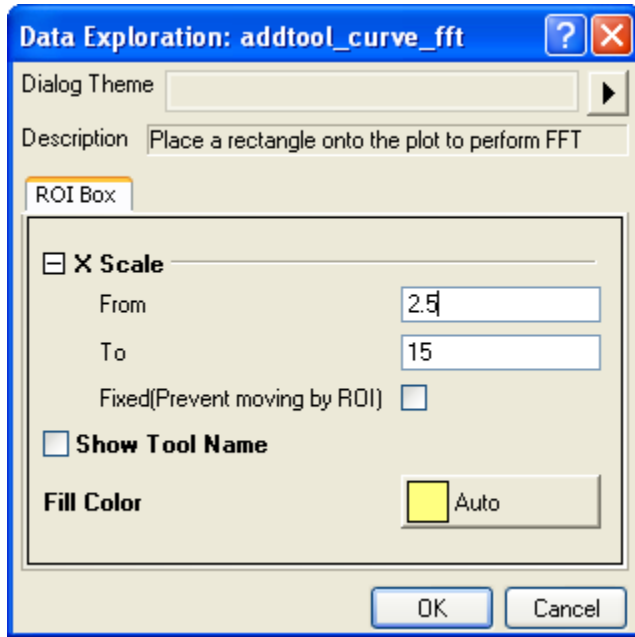

- Using the default settings, click **OK** to add the rectangular Region of Interest (ROI) to the graph.

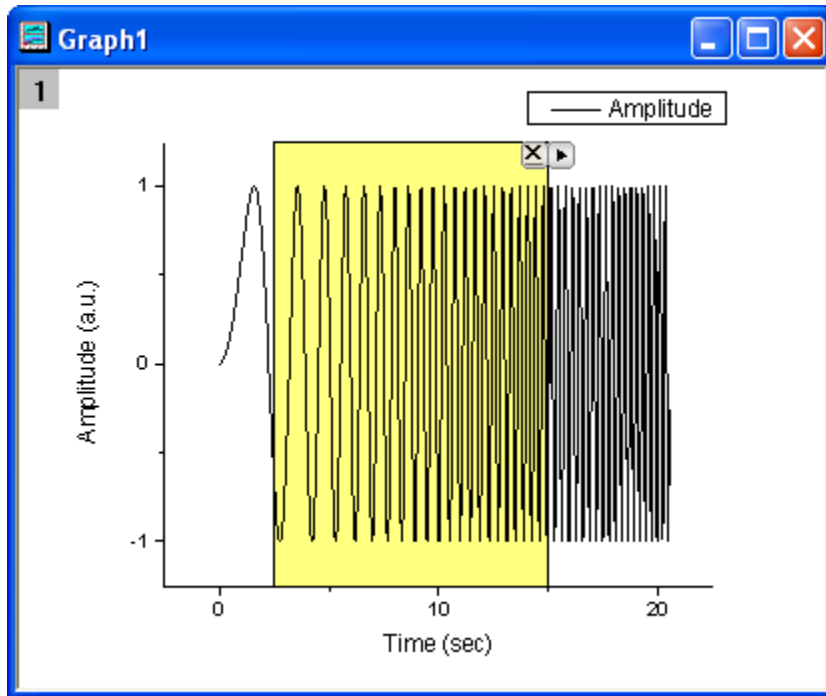

- Note that the **FFTPREVIEW** graph is created showing the FFT results for the selected data.

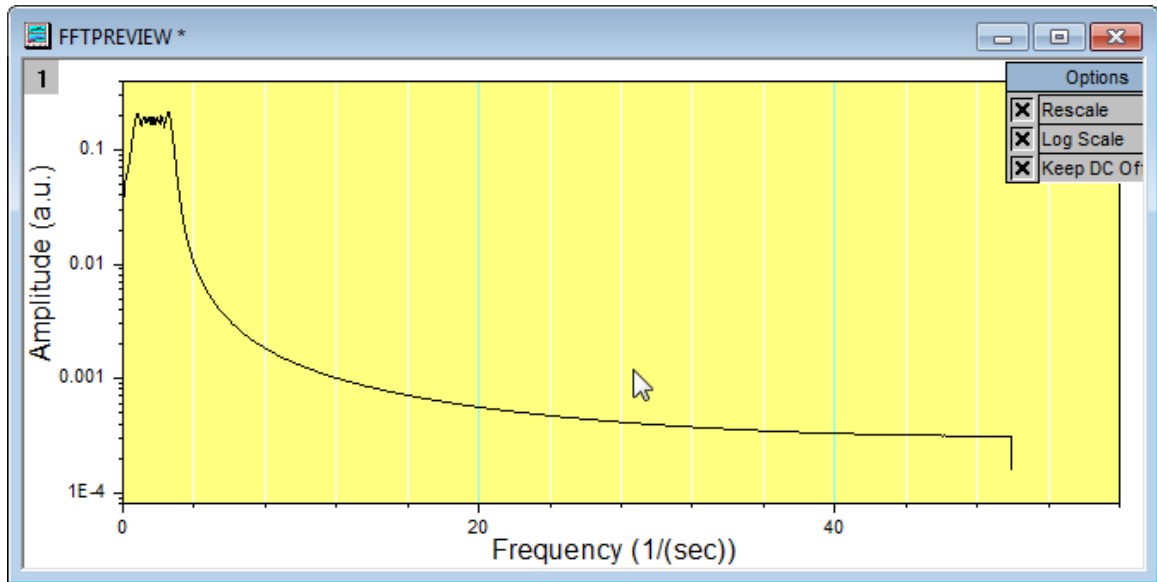

6. You can move the rectangle left and right to cover different portions of the data. You can also change the width of the rectangle to cover different numbers of data points. Repositioning or resizing the ROI changes the **FFTPREVIEW** graph.

#### 4.4.2.4 FFT

In this example, we are going to change the window for suppressing the spectrum leakage.

1. Use the same data as the **FFT Gadget** subsection above.
2. Highlight column B, then select menu **Analysis: Signal Processing: FFT: FFT....** This opens the **FFT: fft1** dialog box.
3. In the dialog, check the **Auto Preview** box at the bottom to preview the result in the right panel. Change the **Window** to **Blackman**, but keep the remaining default settings. In the right panel, we can see that there is a sharp narrow peak spectrum for Amplitude. The **Blackman** window has suppressed the spectrum leakage very well.

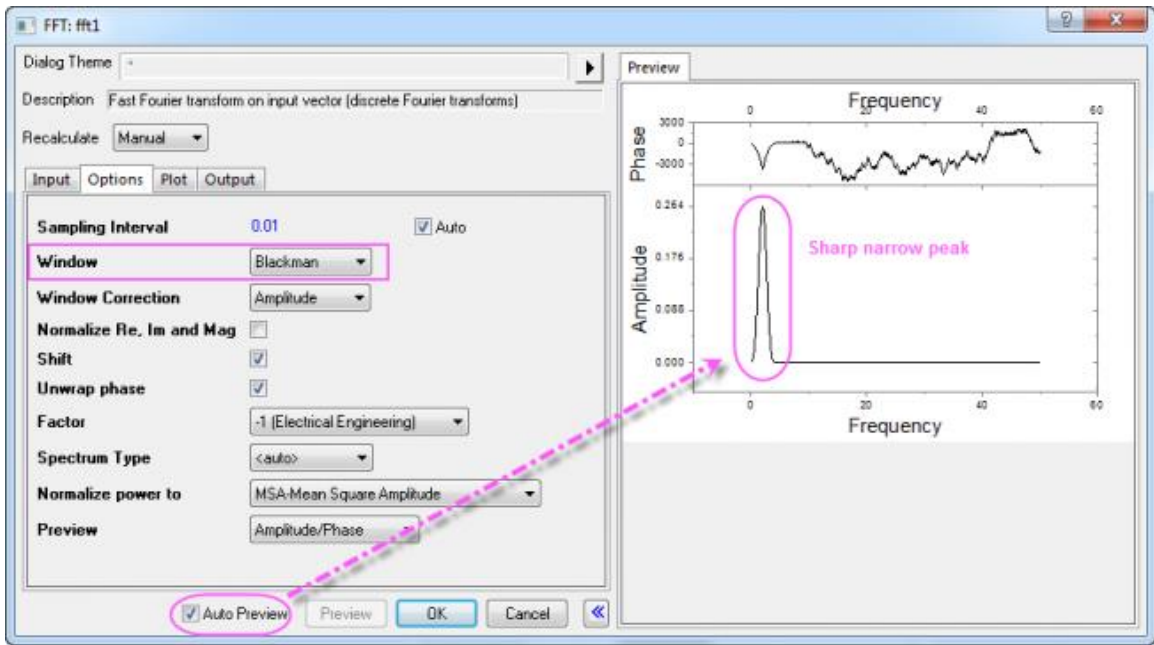

4. Click **OK** to generate the resulting data and graphs.

The screenshot shows a data table with the following columns: A(X) (Frequency), B(Y) (Complex), and C(Y) (Real). The table contains 12 rows of data. The 'Complex' column contains complex numbers in the form of a + bi.

	A(X)	B(Y)	C(Y)
Long Name	Frequency	Complex	Real
Units	1/(sec)	(a.u.)	(a.u.)
Comments	FFT of [ChirpSignal]"Chirp Signal"@"Amplitude"	FFT of [ChirpSignal]"Chirp Signal"@"Amplitude"	FFT of [ChirpSignal]"Chirp Signal"@"Amplitude"
F(x)=			
2	0.04883	1.35312 + 0.05927i	1.35312
3	0.09766	1.80944 - 0.13873i	1.80944
4	0.14648	2.36092 - 0.85292i	2.36092
5	0.19531	2.59074 - 2.27207i	2.59074
6	0.24414	1.81698 - 4.29756i	1.81698
7	0.29297	-0.72738 - 6.18918i	-0.72738
8	0.3418	-5.26597 - 6.2992i	-5.26597
9	0.39063	-10.37639 - 2.47017i	-10.37639
10	0.43945	-12.17611 + 6.17883i	-12.17611
11	0.48828	-5.63361 + 16.26424i	-5.63361
12	0.53711	10.26547 + 18.73255i	10.26547

#### 4.4.2.5 IFFT

This example will show how to recover the signal from the results of doing an FFT. To do so, both settings for FFT and IFFT need to be the same, and the **Spectrum Type** needs to be **Two-sided** and **Window** needs to be set to **Rectangle**.

1. Start with your **FFT** results, above, and click on any of the green locks. Select **Change Parameters...** from the menu to open the dialog box again.

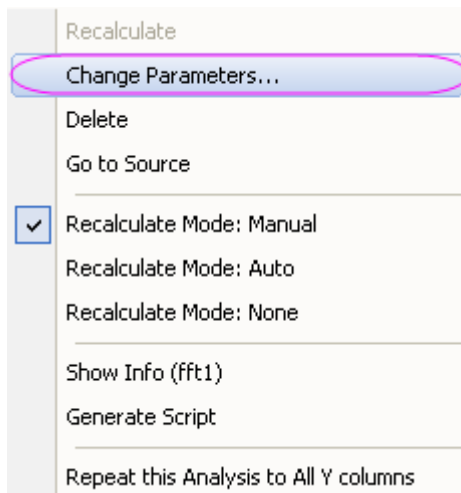

- As mentioned above, the **Window** needs to be set to **Rectangle**, and **Spectrum Type** should be **Two-sided**, so edit these two settings.

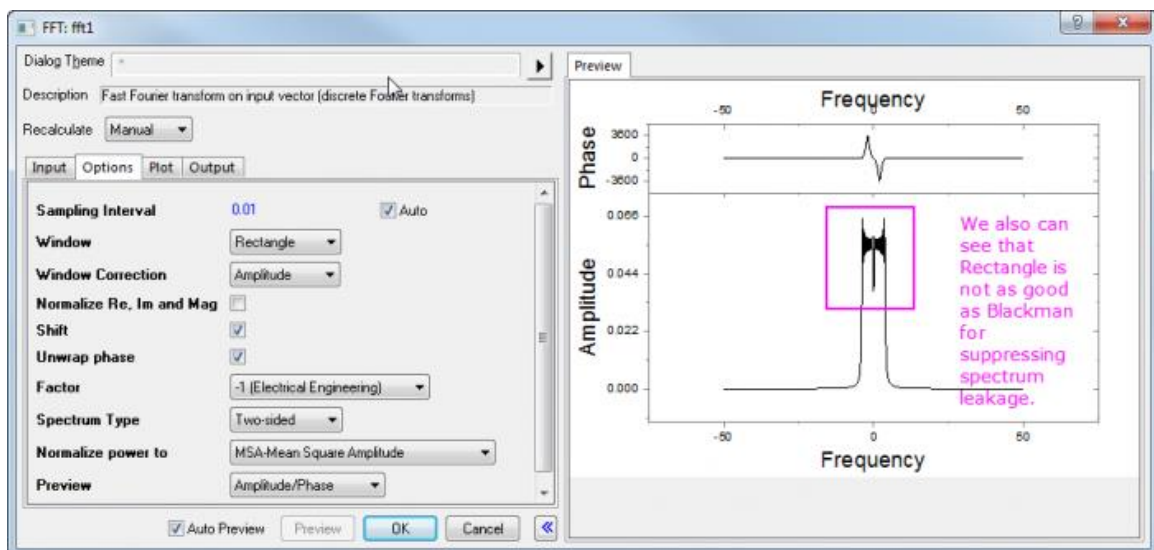

- Click **OK** and the results will be modified.
- Go to the **FFTResultData1** worksheet. We can see one column is Complex, one column is Real, and one is Imaginary. Here, we can use the Complex column (the Real column and Imaginary column also can be used). Highlight it and select the menu item **Analysis: Signal Processing: FFT: IFFT...** to open the **FFT: ifft1** dialog. (Note, if using Real and Imaginary columns, the first line for **Input** should be the Real column, and the **Imaginary** box should point to the Imaginary column.) Check the **Auto Preview** check box at the bottom to preview the result in the right panel.

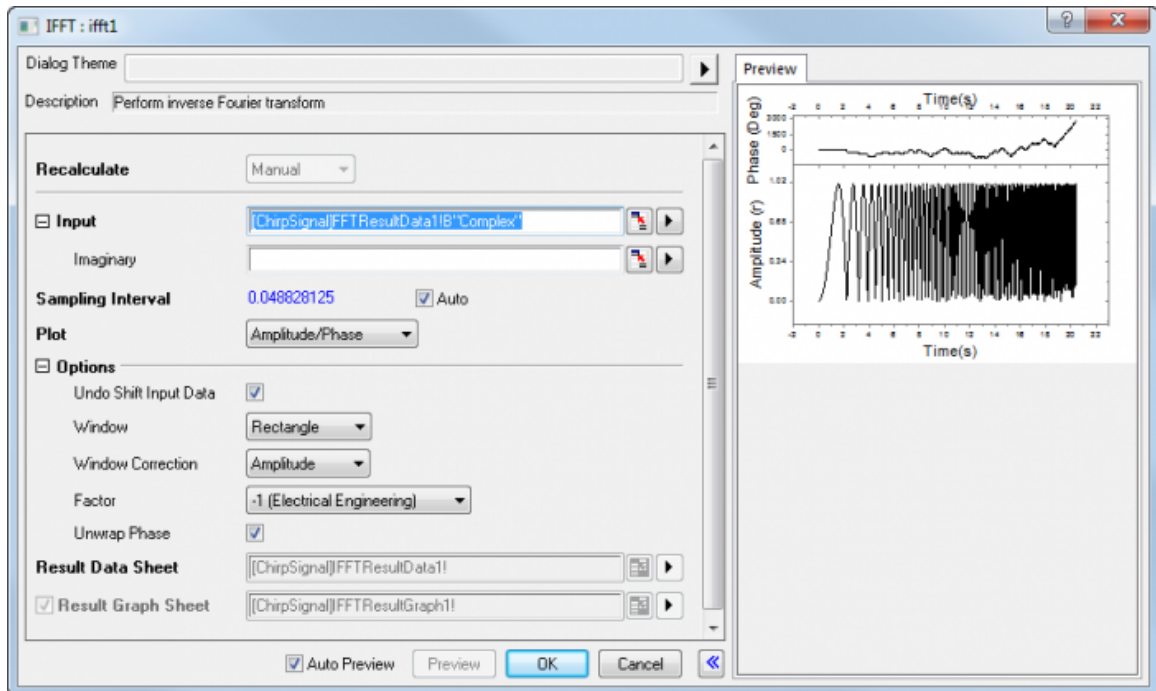

5. Keep the default settings and click the **OK** button.
6. Now, we can make a comparison between the IFFT result (in **IFFTResultData1** worksheet) and the original signal data. As the image below shows, they are almost the same.

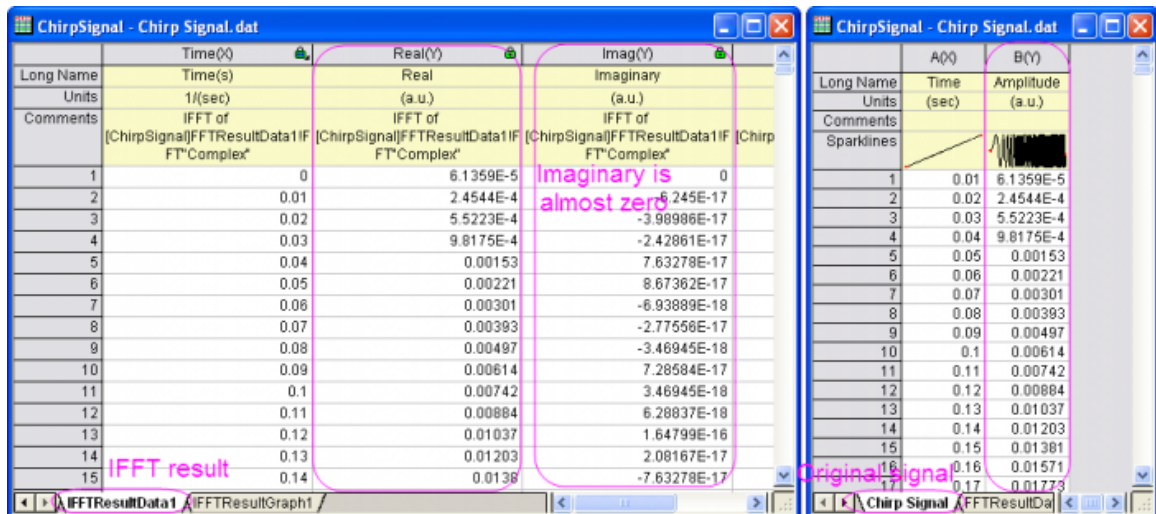

### 4.4.3 FFT Filter

#### 4.4.3.1 Summary

Origin offers an FFT filter, which performs filtering by using Fourier transforms to analyze the frequency components in the input dataset.

There are six types of filters available in the FFT filter function: low-pass, high-pass, band-pass, band-block, threshold and low-pass parabolic. Low-pass filters block all frequency components above the cutoff frequency, allowing only the low frequency components to pass. High-pass filters work in the opposite way: they block frequency components that are below the cutoff frequency.

This tutorial will show you how to perform the low-pass and band-pass filtering using Origin's FFT filter.

#### 4.4.3.2 What you will learn

This tutorial will show you how to:

- Perform low pass filtering.
- Perform band pass filtering.

#### 4.4.3.3 Low-pass Filter

1. Start with an empty workbook.
2. Select **Data: Import from File: Sound(WAV)** menu item and import the file **Origin 8 Message.wav** located at <Origin EXE Folder>\Samples\Signal Processing\. Accept the default import settings.

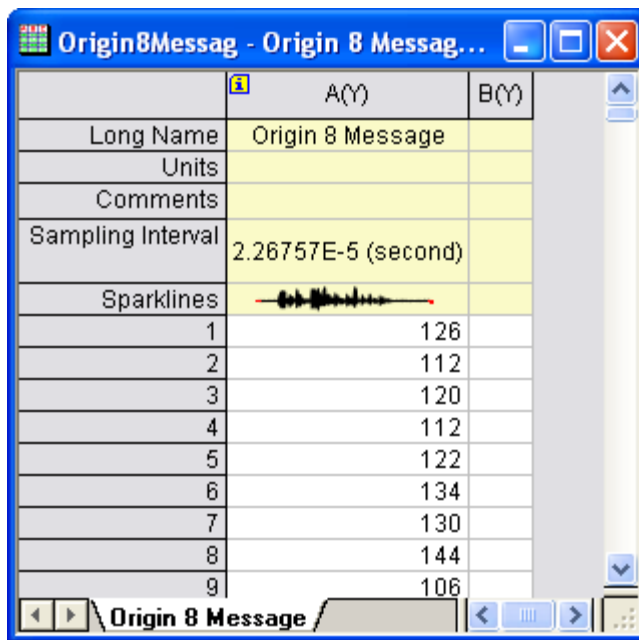

3. Highlight column A(Y) and click the **Line**  button on the **2D Graph** toolbar to create a line plot.
4. This signal is a sound wave and it is already known that the high frequency components can be regarded as noise, and should be blocked. So we will use the **Low Pass** method in the **FFT Filter** tool to approximate the low frequency component for further analysis.
5. Make sure the line plot is active, then select **Analysis:Signal Processing:FFT Filters** to open the `fft_filters` dialog box.

6. Make sure the **Filter Type** is set to **Low Pass**.
7. Check the **Auto Preview** box to turn on the **Preview** panel:

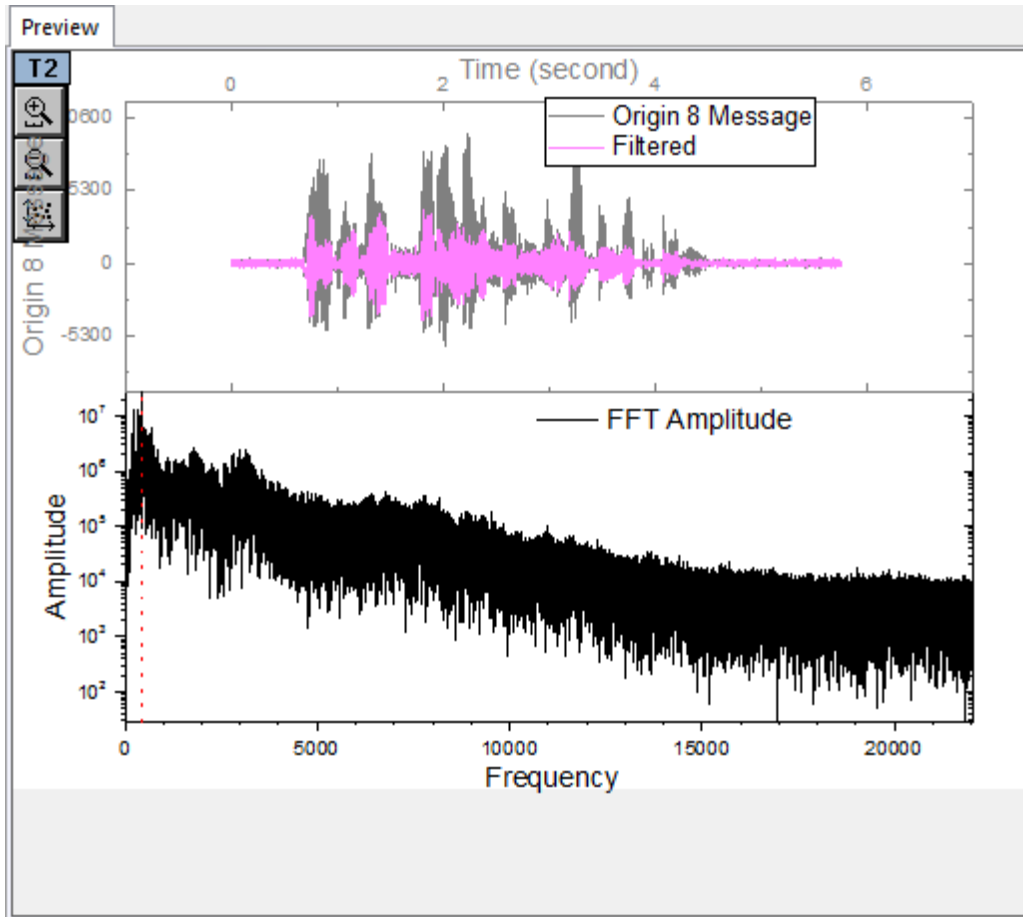

The top two images show the signal in the time domain, while the bottom image shows the signal in the frequency domain after Fast Fourier Transform. The X position of the red vertical dot line indicates the cutoff frequency. By moving the vertical line horizontally, you can preview the comparison between the original signal and the filtered signal in real time, in the top part of this panel.

8. Move the vertical line to the X position of the peak amplitude (as in the image below). Note that human error may be introduced during this step, but it is acceptable since we only want to roughly filter the signal.



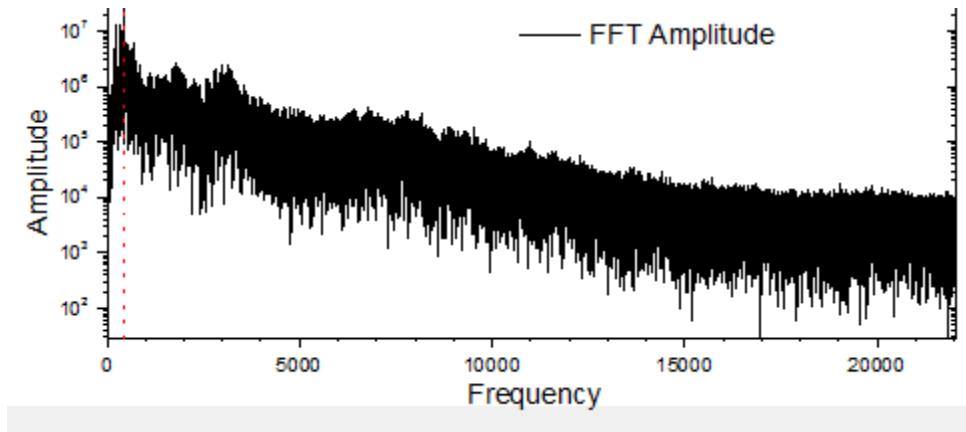

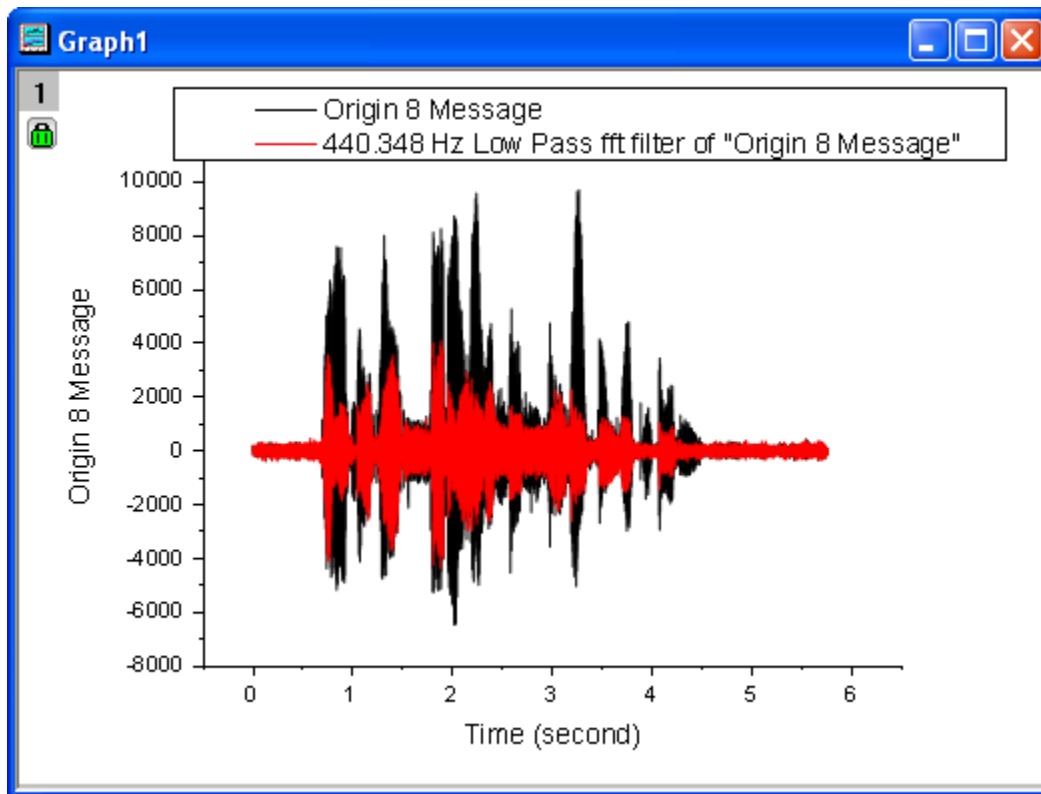

9. Click **OK** to apply the FFT filter to the original signal.
10. The signal after filtering will be added to the data plot of original signal. Select **Graph:Speed Mode** and turn off speed mode in this graph. The resulting graph should look like this:



11. In the resulting graph, we can see that the high frequency components are blocked by the Low Pass FFT filter.

#### 4.4.3.4 Band-pass Filter

1. Start with a new workbook.

2. Click the **Import Single ASCII**  button and import the file **fftfilter3.dat** located at <Origin EXE Folder>\Samples\Signal Processing.
3. Highlight column B and click the **Line**  button on the **2D Graphs** toolbar to generate a line plot.

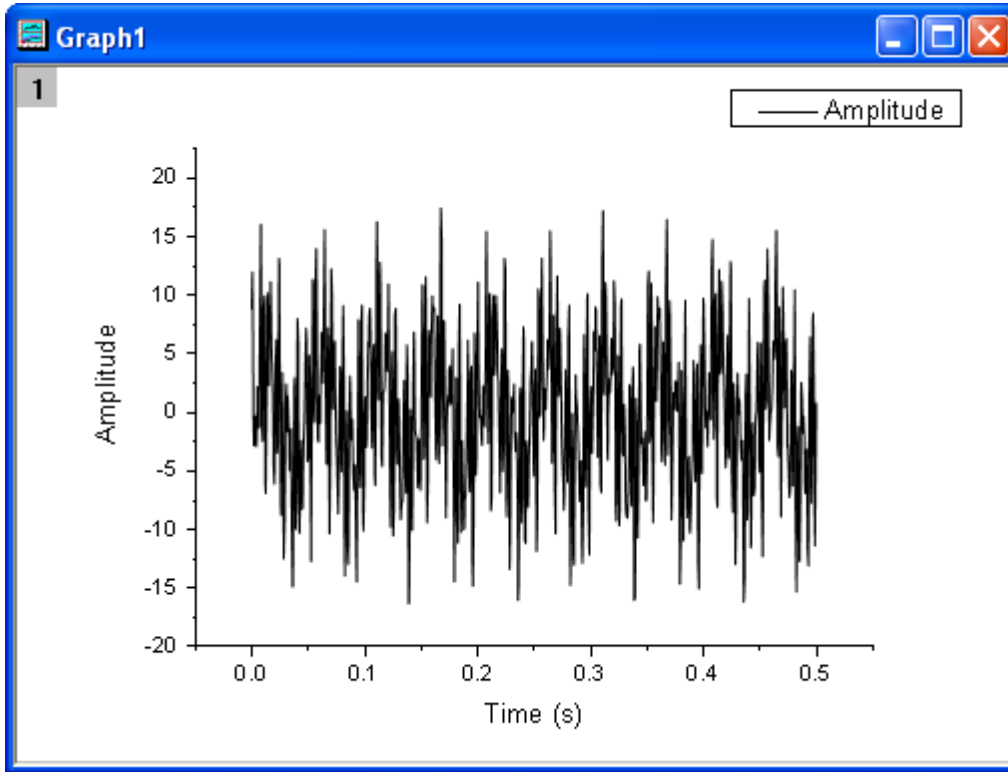

4. With the graph active, select **Analysis:Signal Processing:FFT Filters**. This opens the **fft\_filters** dialog box.
5. Check the **Auto Preview** box to enable the **Preview** panel.
6. From the plot of frequency domain (the image below), we can see that this signal has components at several different frequencies> Now we are going to get the component at about 300Hz. So we will use the **Band Pass** method.

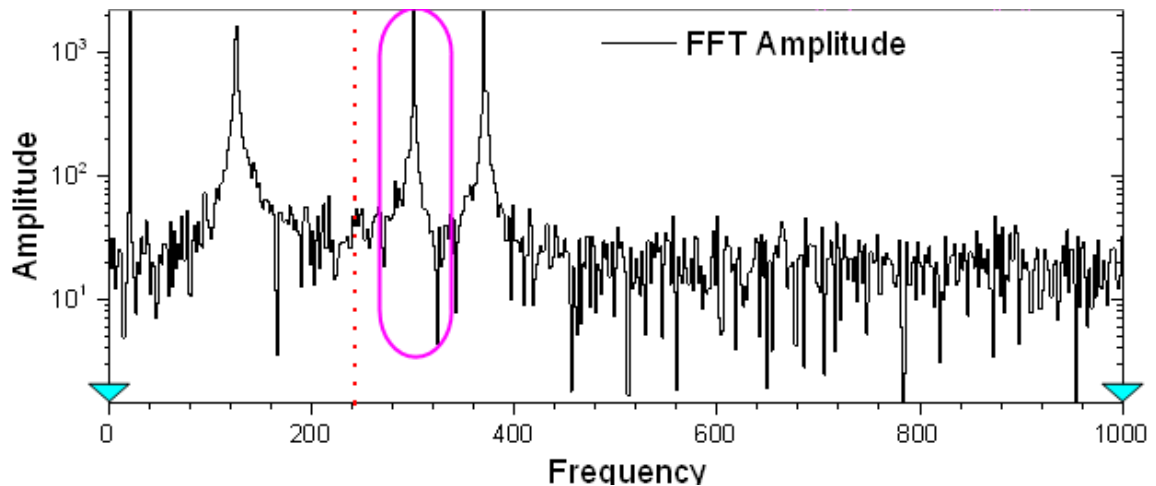

7. Set the **Filter Type** to be **Band Pass**.

When **Band Pass** is chosen, there will be two vertical red lines in the preview panel, marking the Lower Cutoff Frequency and Upper Cutoff Frequency. You can similarly move these two lines and get the real time preview of filtering results in the top parts of this panel.

8. Enter the values of the lower and upper cutoff frequencies according to the image below:

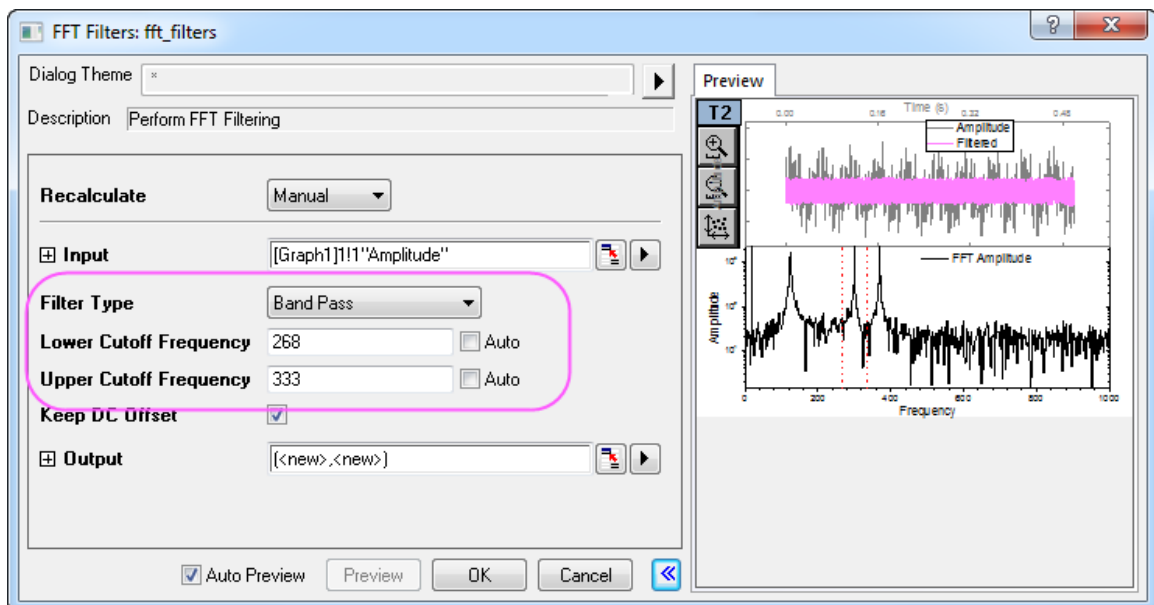

As long as only the desired amplitude peak stays within the cutoff frequency range, the error in filtering could be considered as acceptable even though the values of upper and lower cutoff frequencies may slightly differ for different cases.

9. Click **OK** to execute filtering.
10. We obtain the components at a frequency of around 300 Hz after filtering.

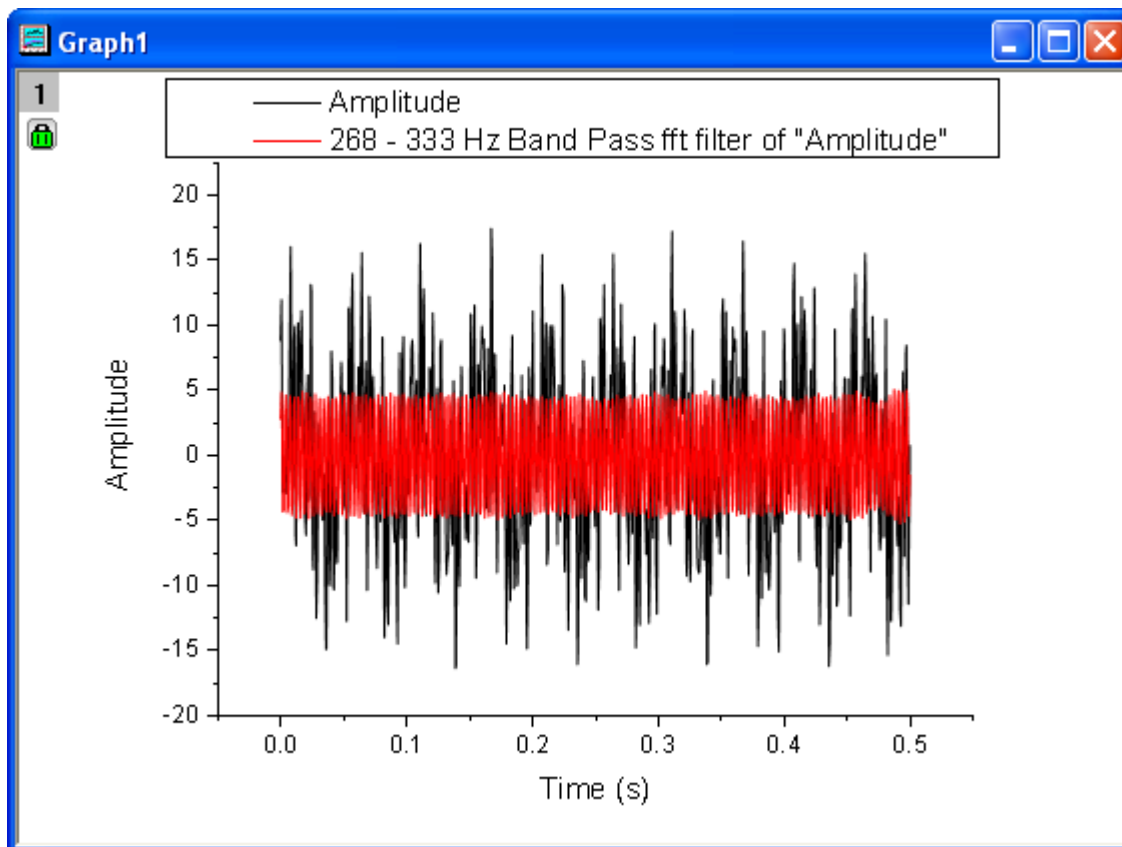

#### 4.4.4 Smoothing

##### 4.4.4.1 Summary

Smoothing is a common technique for removing noise from signals. Origin provides multiple smoothing methods, including Adjacent Averaging, Savitzky-Golay, Percentile Filter, and FFT Filter. Additionally, there is a wavelet-based tool available.

For matrix data, Origin's smoothing is performed in two ways. If the number of columns or rows is less than 32, it will expand the matrix first, then shrink it back to the original size. If greater than 31, the matrix is first shrunk, then expanded.

##### 4.4.4.2 What You Will Learn

This tutorial will show you how to:

- Smooth signals by several methods.
- Smooth signals using wavelets.
- Smooth a 3D surface.

##### 4.4.4.3 Smoothing by Several Methods

1. Start with an empty workbook.

2. Select menu item **Data: Import from File: Single ASCII...** to import the data **Signal with High Frequency Noise.dat** under the folder *<Origin Installation Directory>\Samples\Signal Processing\*.

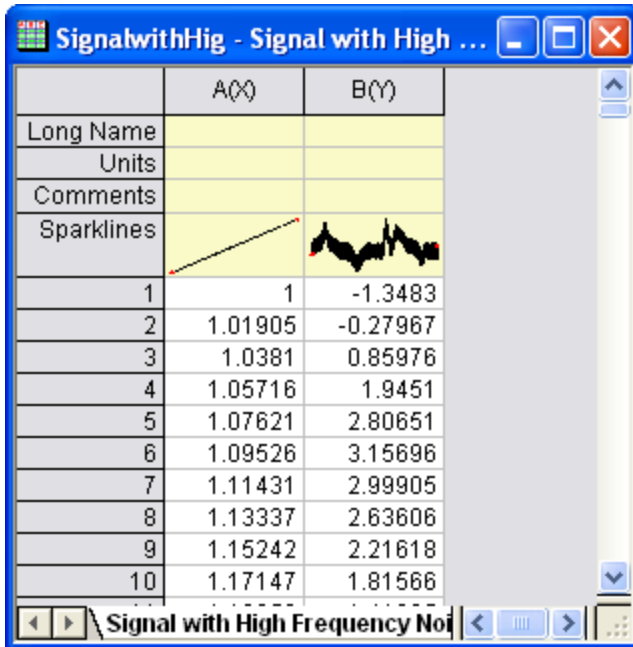

3. Highlight column B in the worksheet. Then, select menu item **Analysis: Signal Processing: Smooth...** (if the tool has been used before, select **Open Dialog**) to open the **Smooth** dialog box.

#### 4.4.4.3.1 Adjacent-Averaging

The Adjacent-Averaging method performs a broad smoothing of data.

1. Choose **Adjacent-Averaging** for **Method**. Set the **Points of Window** to **100** and **Boundary Condition** to **Periodic**. To preview the result in the right panel, check the **Auto Preview** check box.

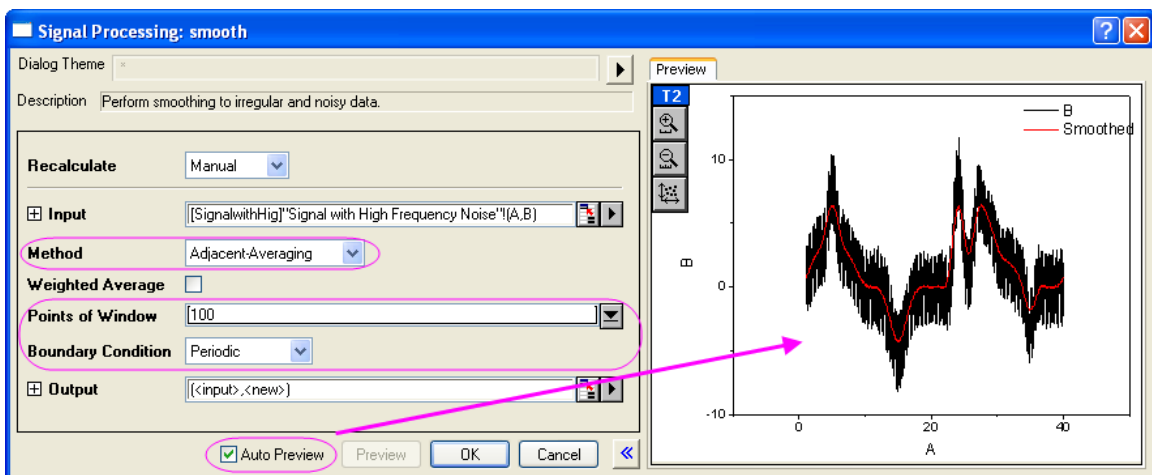

2. Click **OK** to generate the result.

#### 4.4.4.3.2 Savitzky-Golay

The Savitzky-Golay method is good for preserving the shapes of signal peaks.

1. Select column B again. On the **Analysis** menu, click **Signal Processing: Smooth:Open Dialog....**
2. In the **smooth** dialog box, set **Method** to **Savitzky-Golay**. Set **Points of Window** to **100**, **Boundary Condition** to **Periodic** and **Polynomial Order** to **3**.

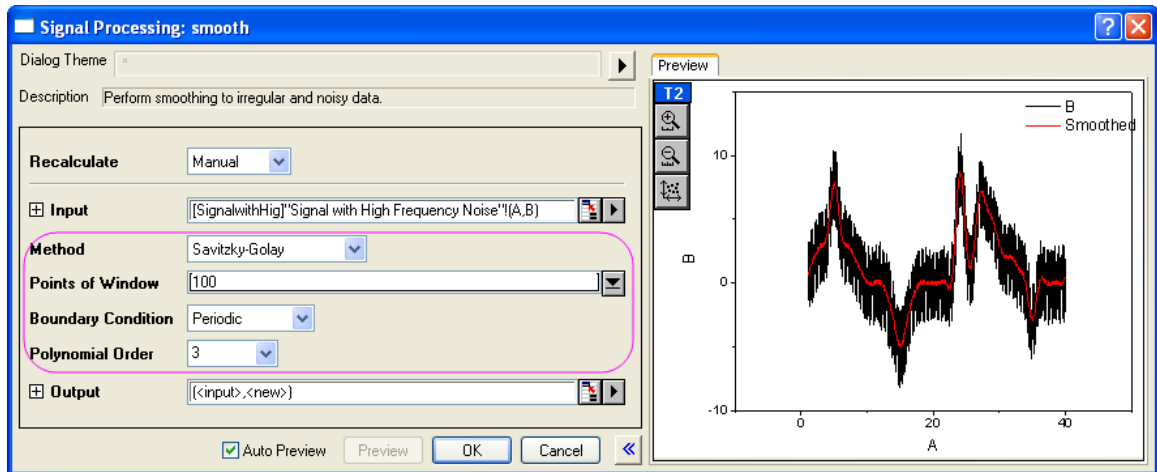

3. Click **OK**.

#### 4.4.4.3.3 Percentile Filter

1. Select column B again. On the **Analysis** menu, click **Signal Processing: Smooth:Open Dialog....**
2. For **Method**, choose **Percentile Filter**. Set **Points of Window** to **100**, **Boundary Condition** to **Periodic**, and for **Percentile** accept the default value of **50**.

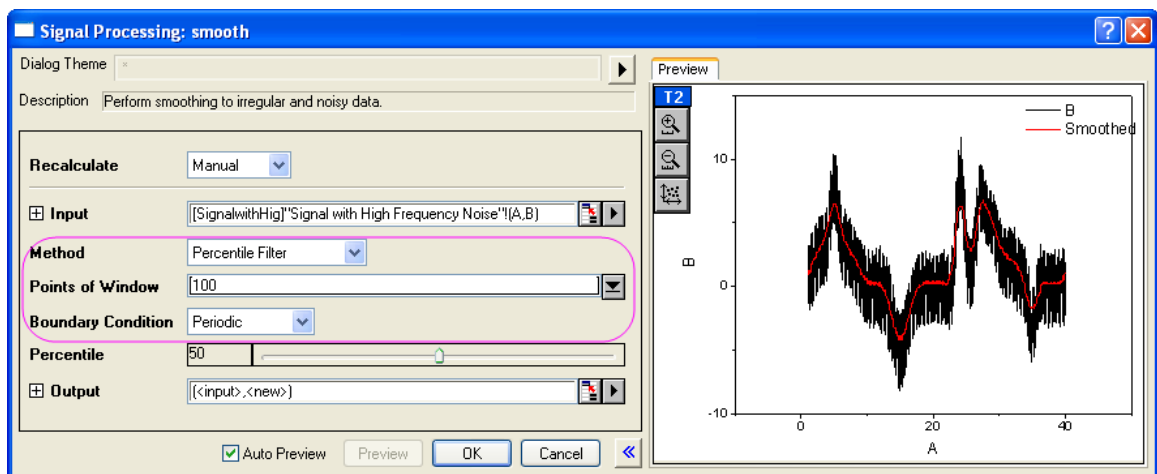

3. Click **OK** button.

#### 4.4.4.3.4 FFT Filter

1. Select column B again. On the **Analysis** menu, click **Signal Processing: Smooth:Open Dialog.....**
2. Set **Method** to **FFT Filter**. Set **Points of Window** to **100**.

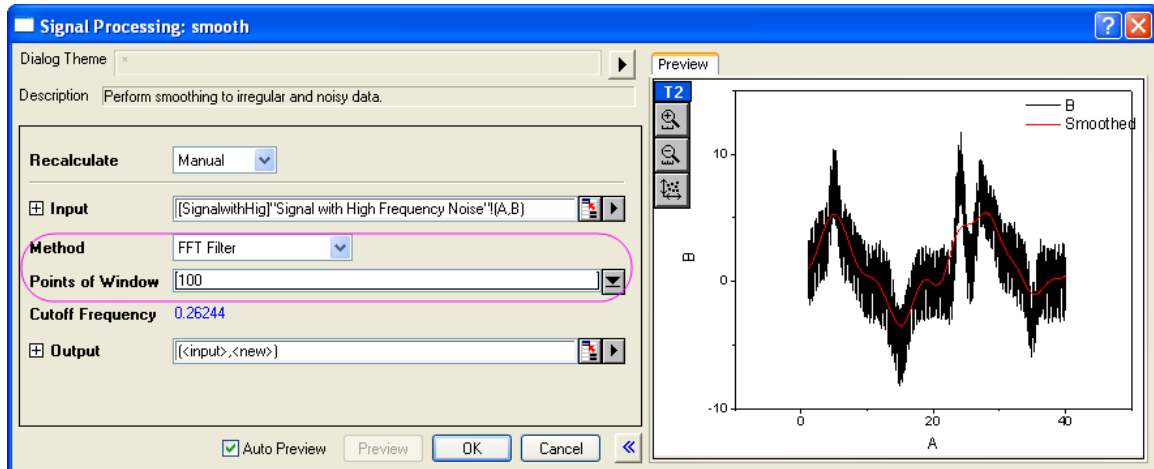

3. Click **OK** to close the dialog box.
4. Note that in the worksheet, there are now four added columns containing the results of your four smoothing operations. Highlight those four columns (C,D,E,F), then from the menu select **Plot>2D: Line: Line** to make a line graph with these four datasets.

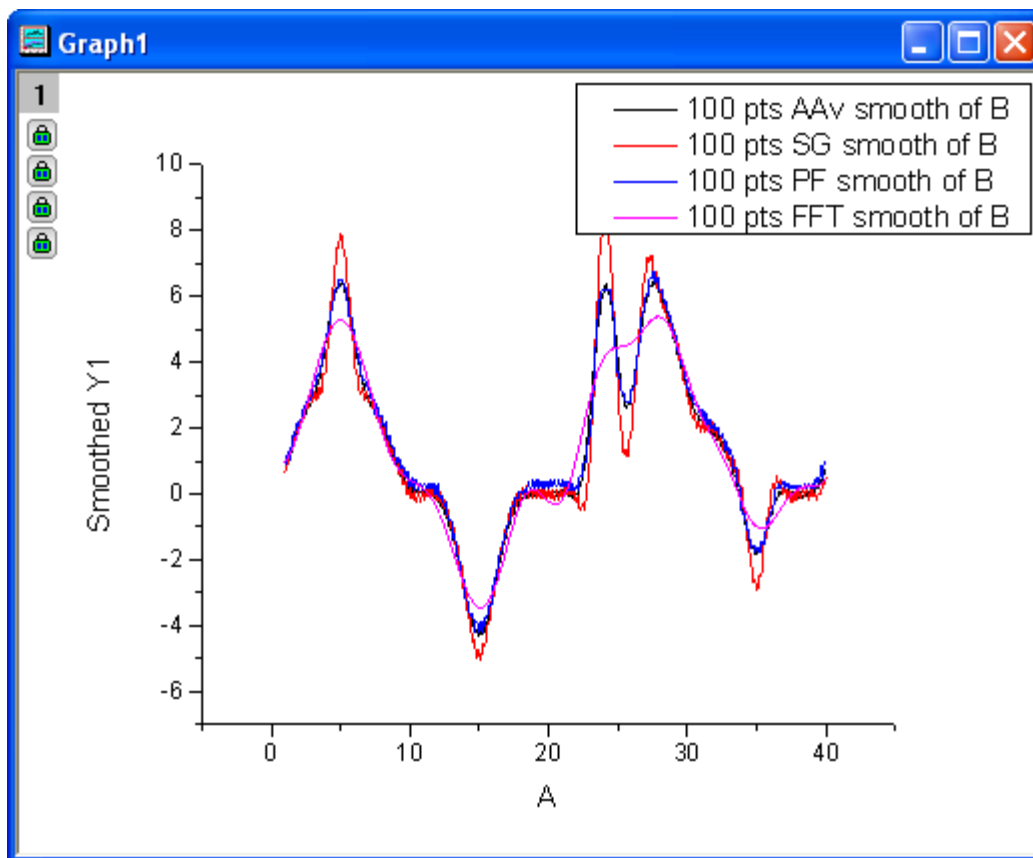

5. Comparing the results of the four methods, you can see that the Savitzky-Golay method did the best job of preserving peaks in the data, while the FFT Filter method did the poorest job of preserving peaks.

#### 4.4.4.4 Smoothing by Wavelet

1. Start a new workbook.
2. Select menu item **Data: Import from File: Single ASCII...** to import the data **Signal with High Frequency Noise.dat** under the folder *<Origin Installation Directory>\Samples\Signal Processing\*.



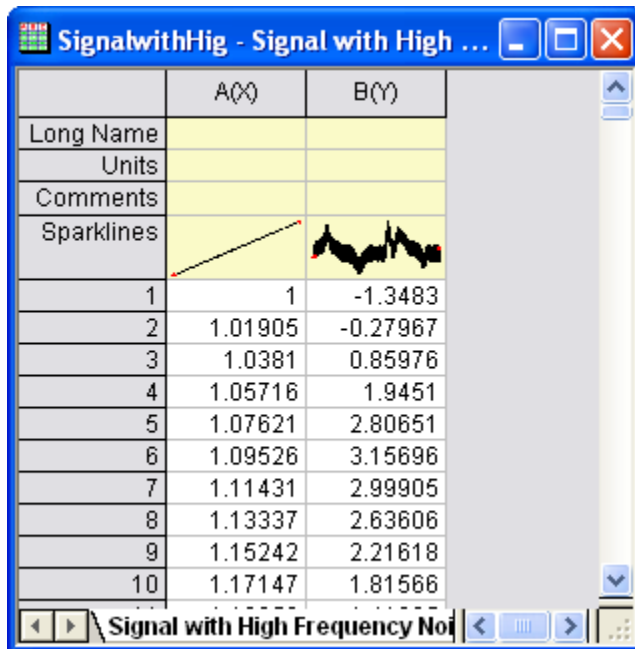

- Highlight column B, and from the menu select **Analysis: Signal Processing: Wavelet: Smooth...** to open the **Smooth: wtsmooth** dialog box.
- In the dialog, set **Wavelet Type** to **DB6**, and **Cutoff (%)** to **98**. Check **Auto Preview** to preview the result in the right panel.

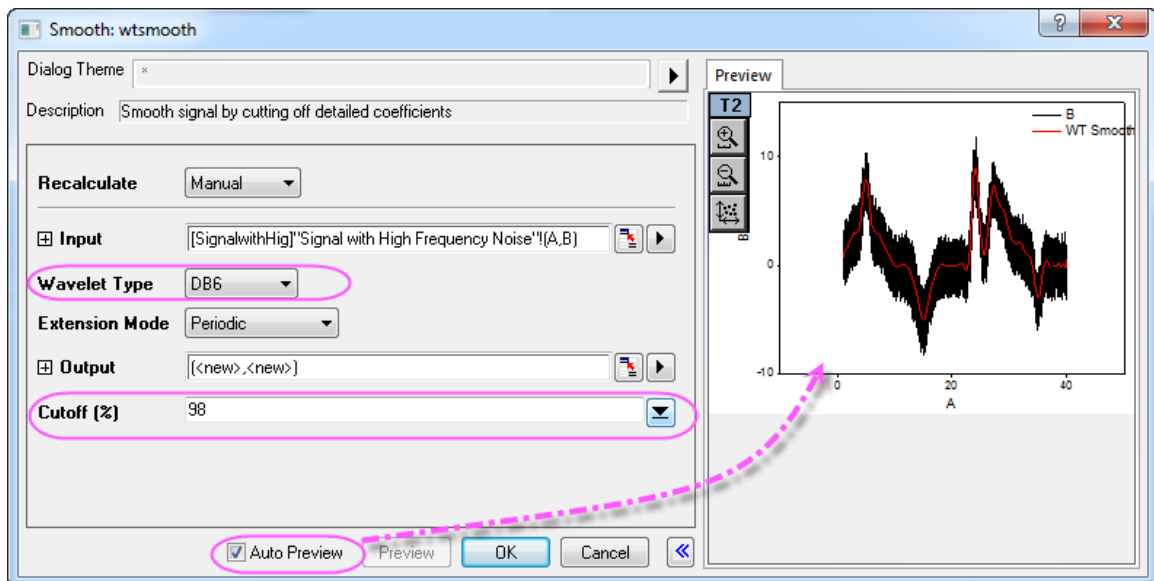

- Click **OK** to close the dialog box and generate your result.
- To see the difference between the original signal and the smoothed signal, highlight all columns in the worksheet and from the menu select **Plot>2D: Line: Line**.

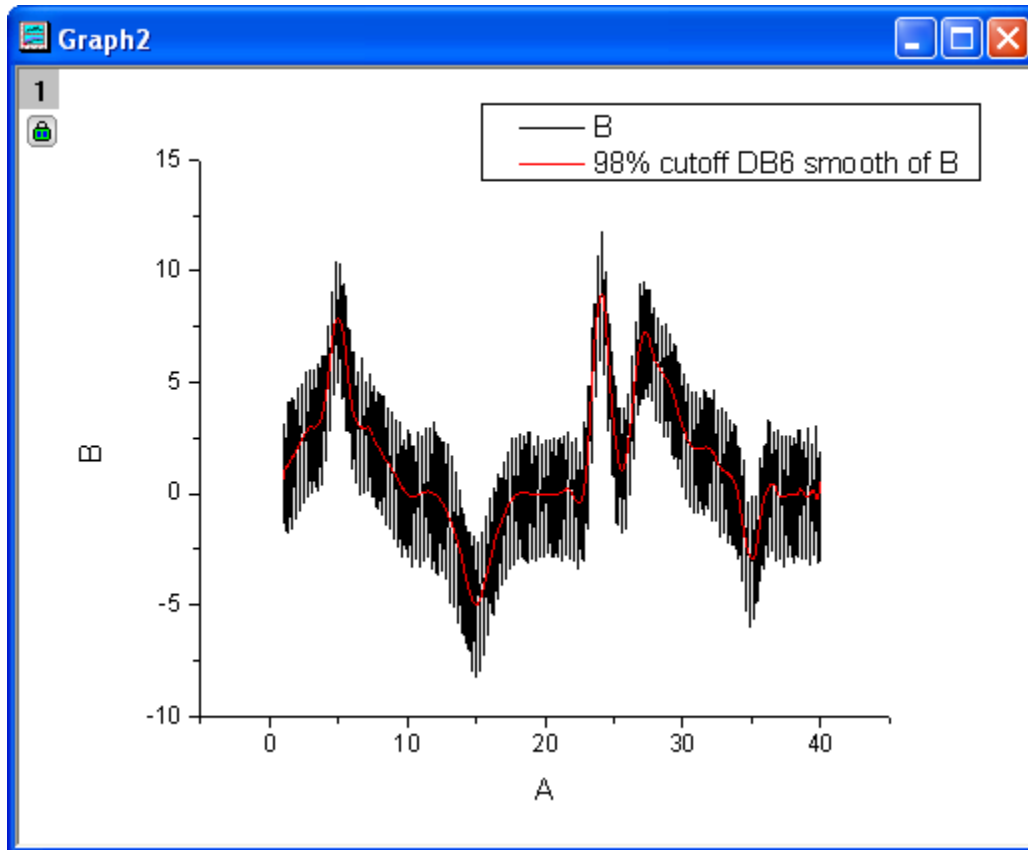

#### 4.4.4.5 Smoothing Matrix

1. Start with a new matrix book.
2. Select menu **Data: Import from File: Image to Matrix...** to import the image **scale.jpg** under the folder *<Origin Installation Directory>\Samples\Image Processing and Analysis\* (if the impImage dialog box opens, simply accept the defaults and click **OK**).
3. Origin is not able to apply to perform smoothing on an image so we must convert the image to matrix data first. From the menu select **Image: Conversion: Convert to Data...** Accept the dialog box default settings and Click **OK**.
4. With the converted matrix activated, select menu **View: Image Mode** to view this matrix as image.

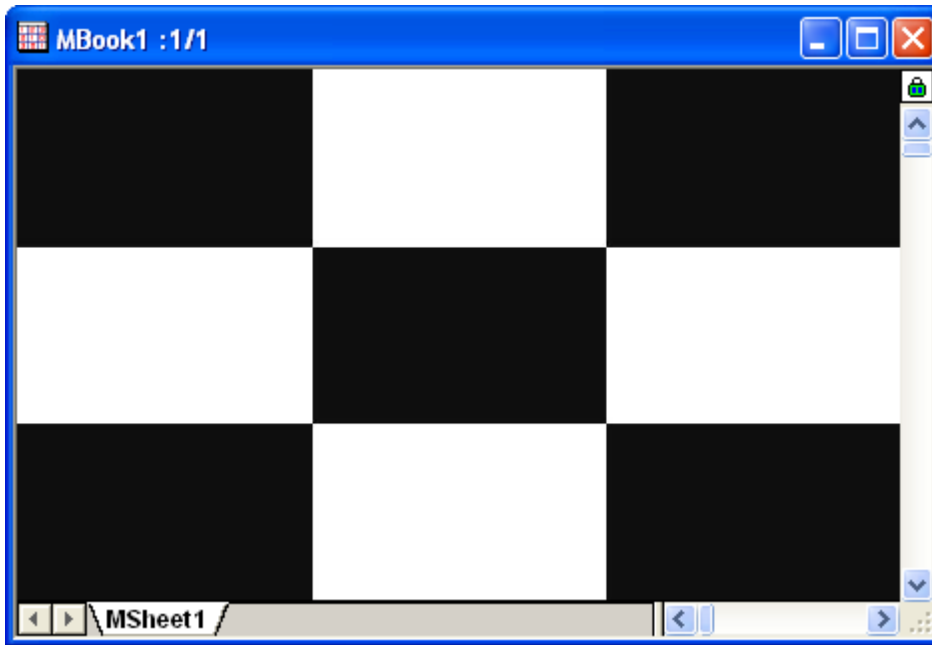

5. To perform smoothing, select **Analysis: Signal Processing: Smooth...** This opens the **Smooth: msmooth** dialog box.

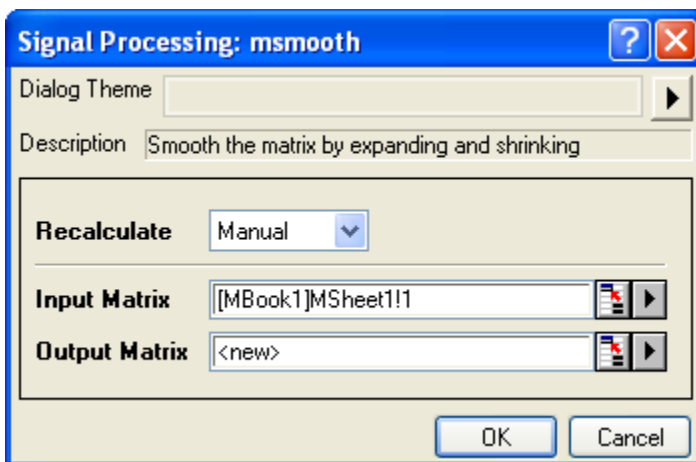

6. Accept the default settings and click **OK**. To view the result, select **View: Image Mode** from the menu.

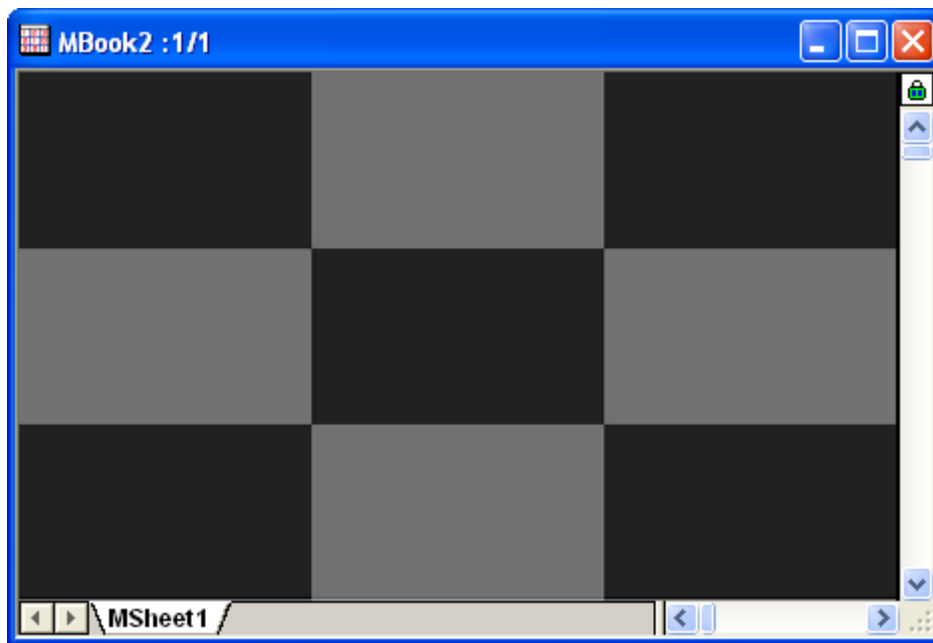

#### 4.4.5 STFT (Short-Time Fourier Transform)

##### 4.4.5.1 Summary

Short-Time Fourier Transform (STFT) is a time-frequency analysis technique suited to non-stationary signals. Short-Time Fourier Transforms can provide information about changes in frequency over time.

##### 4.4.5.2 What You Will Learn

In this tutorial, you will learn how to:

1. Perform Short-Time Fourier Transform (STFT).
2. Change dialog settings to improve the time and frequency resolution.
3. Change window type to improve resolution.

##### 4.4.5.3 Steps

1. Start with a new workbook, and import the data **<Origin Installation Directory>\Samples\Signal Processing\Chirp Signal.dat**.

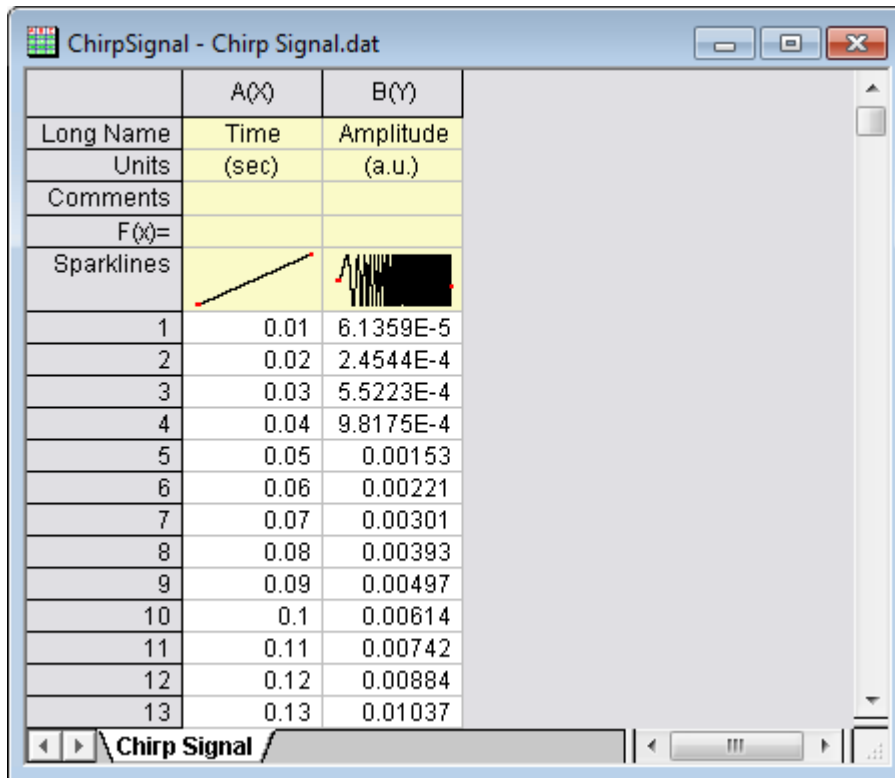

- Highlight column B, and select menu **Analysis: Signal Processing: STFT...** to open the **STFT: stft** dialog box.
- In the dialog box, check **Auto Preview** at the bottom of the dialog so that you can preview your results in the right panel. Uncheck the **Auto** check box next to **Window length** and **Overlap**, then change **Window length** to **8**, and **Overlap** to **7**. Set **Window Type** to **Hanning** and **Option** to **Amplitude Result**.

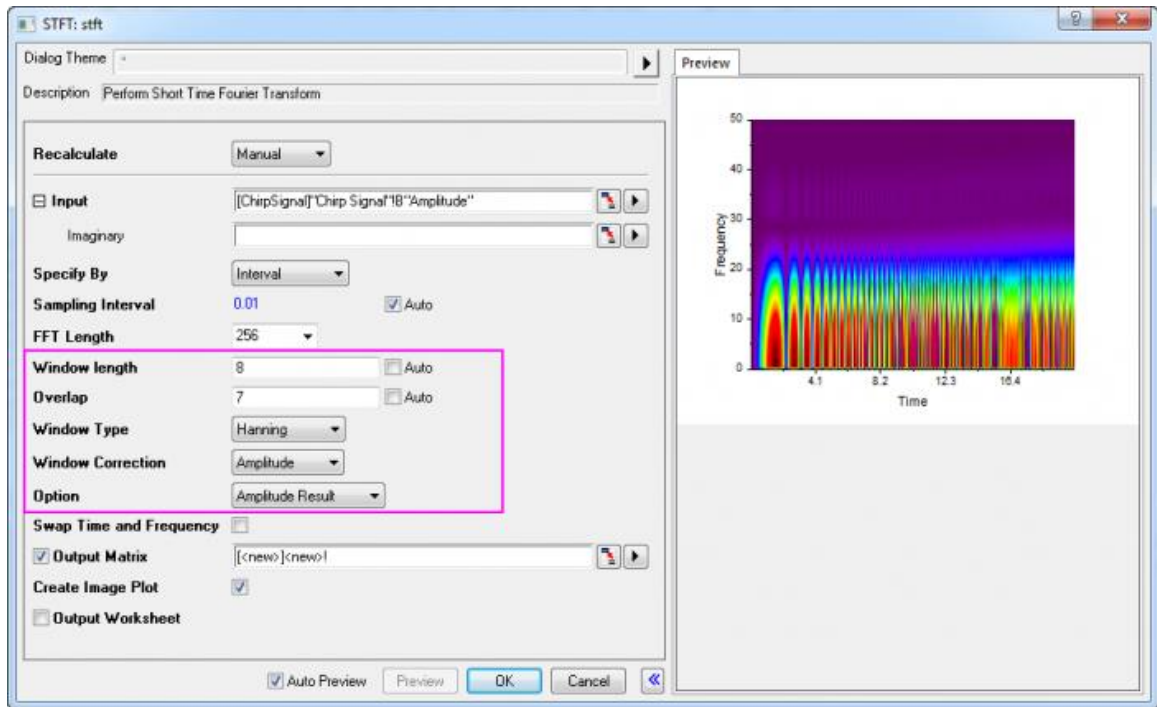

4. Click **OK** to perform STFT with the chosen settings and obtain your results, including a matrix book with data and a color fill contour plot.

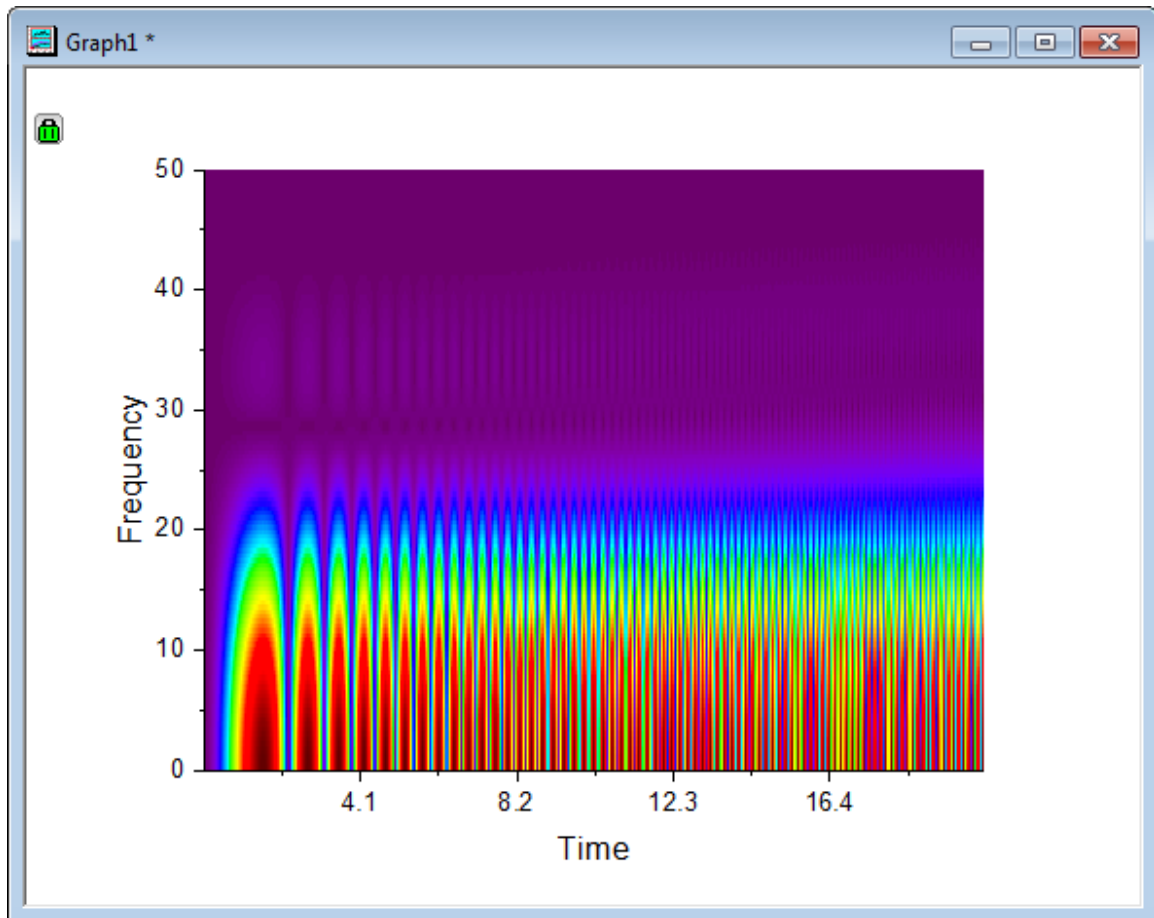

5. We can see from the above image that the time resolution is good, but the frequency is not so apparent. Click on the lock on the graph, then choose **Change Parameters...** from the menu. This reopens the STFT dialog box. Change the **Window Type** to **Rectangle** and click **OK**.

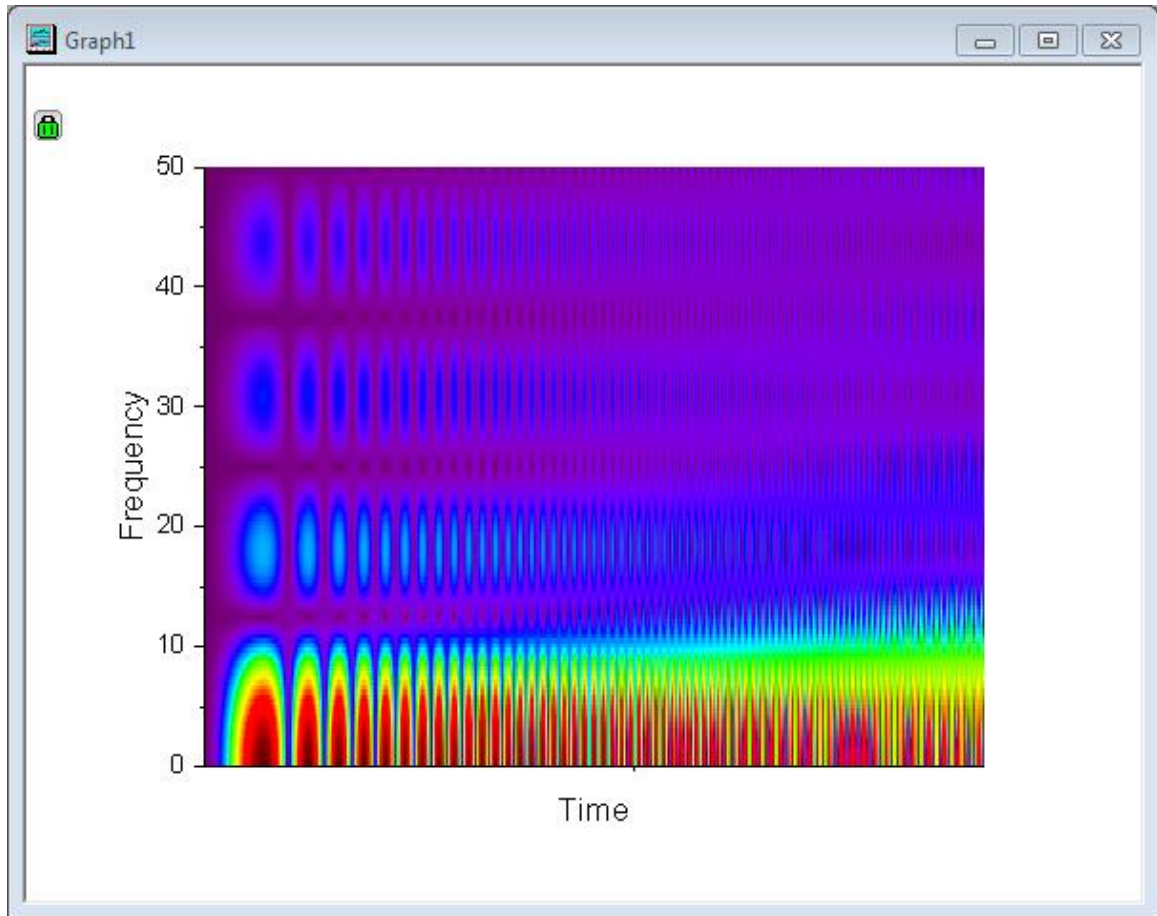

6. Now, we are better able to see resolution of both time and frequency. Please note that it is not possible to optimize for both time and frequency; the best we can do is to find the balance between them.
7. To view the result in 3D, activate the resulting matrix, then select menu **Plot>3D:Surface:3D Color Map Surface** to create a 3D surface of the result.
8. Double click on the 3D graph to open the **Plot Details** dialog, and go to the **Colormap/Contours** tab in the right panel. Click the **Line...** heading to open the **Contour Lines** dialog and **Hide All** lines.



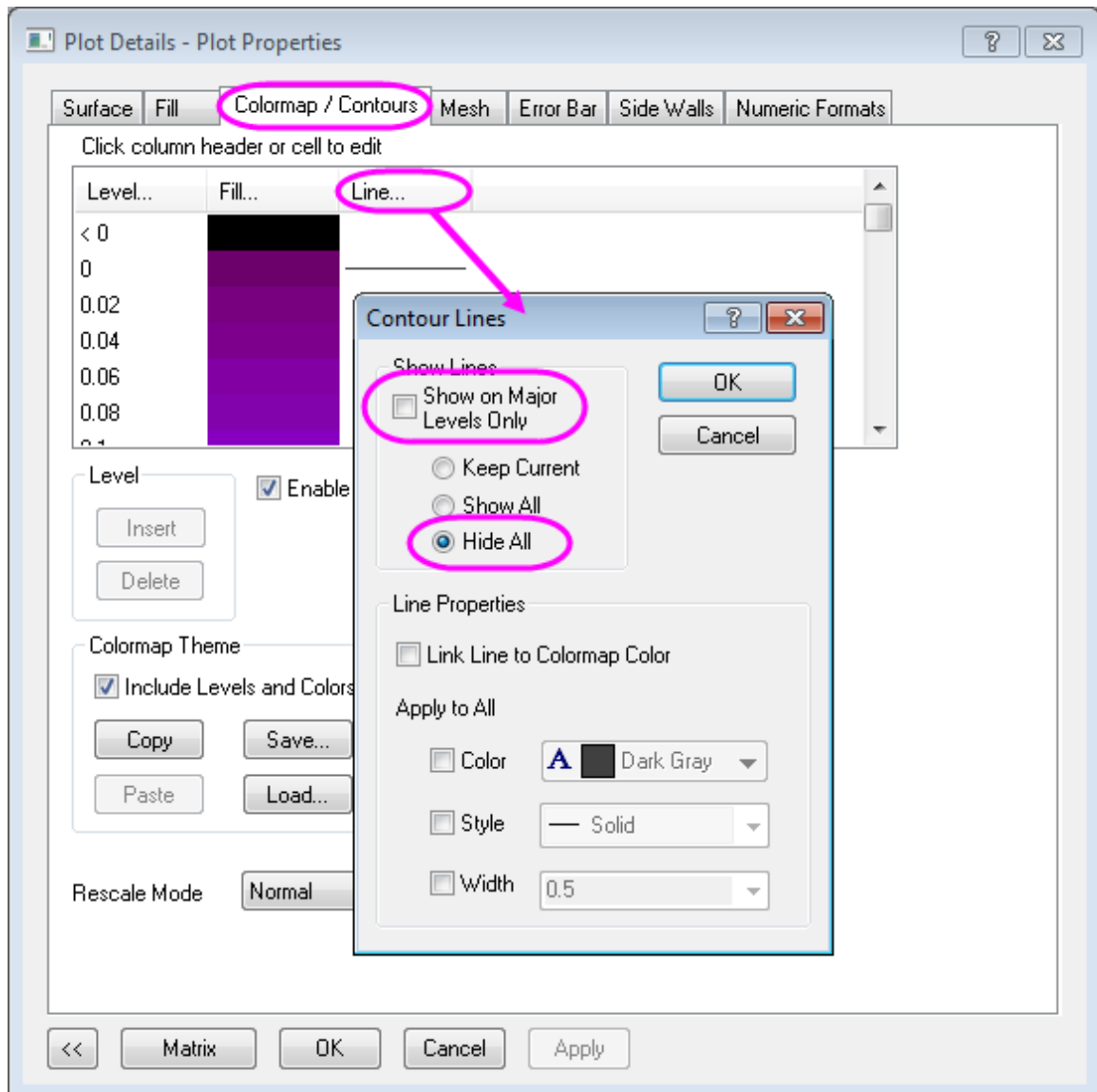

9. Go to the **Mesh** tab and clear the **Enable** check box.

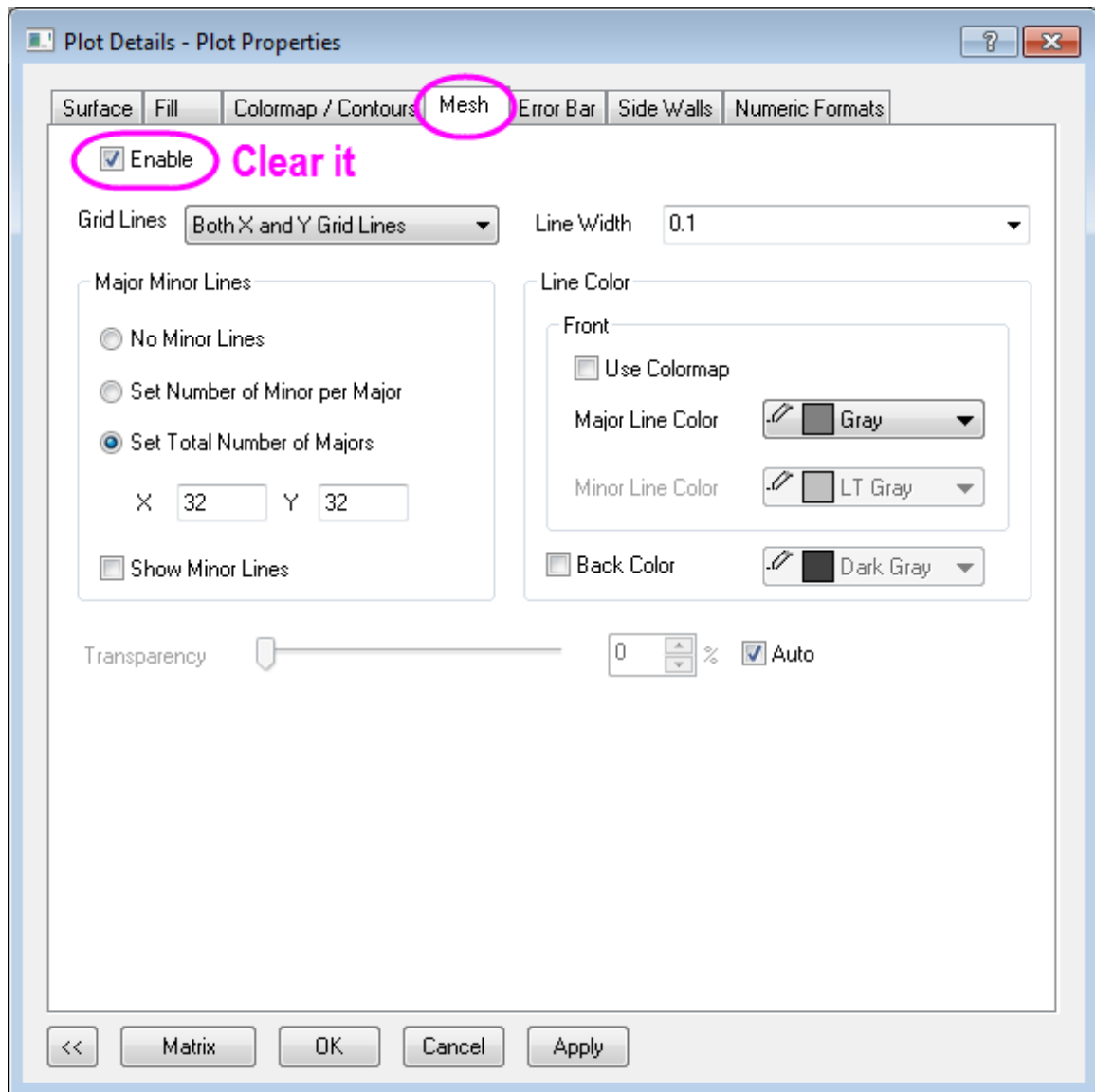

10. Click **OK** to finish the settings. To get a better view, rotate the graph.

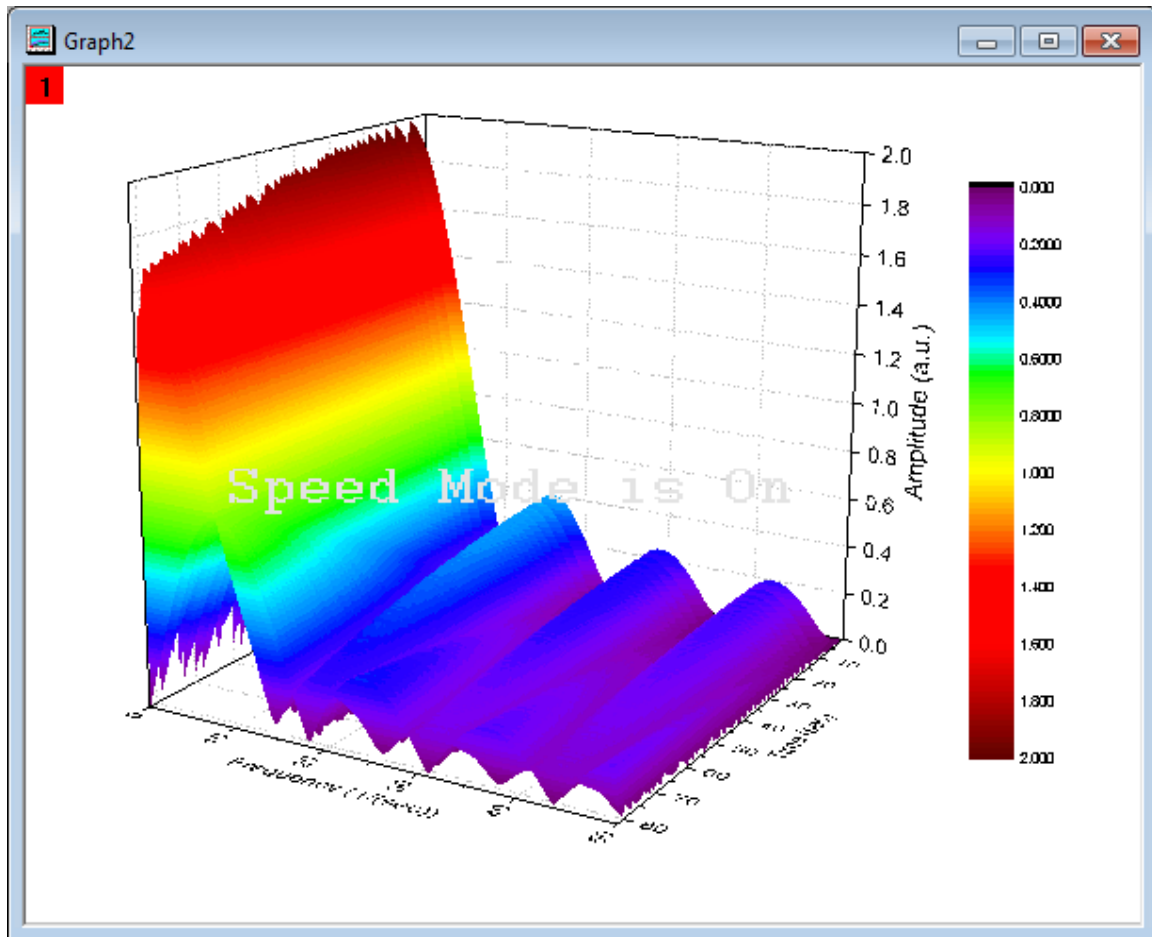

## 4.4.6 IIR Filter

### 4.4.6.1 Summary

In OriginPro, it is possible to design, analyze, and implement IIR (Infinite Impulse Response) digital filters. The IIR filter supports four methods, including **Butterworth**, **Chebyshev Type I**, **Chebyshev Type II**, and **Elliptic**.

This provides users more choices in signal processing.

Minimum Origin Version Required: 9.0 SR0

### 4.4.6.2 What You Will Learn

This tutorial will show you:

- How to design and apply an IIR filter
- A comparison between IIR filter and FFT filter

### 4.4.6.3 Steps

#### 4.4.6.3.1 Design and Apply IIR Filter

1. Start with a new worksheet and import the **EMG Recording.dat** file from `\Samples\Signal Processing\`.
2. Highlight column B and Select **Analysis:Signal Processing:IIR Filter** from the top menu to open the dialog.
3. Change the Response type as **High Pass**, keep the Method as **Butterworth**, uncheck the **Minimum** for Filter Order and set it as **4**. In the Frequency Specification branch, set the Cutoff Frequency( $F_c$ ) as **20**, then check the **Forward-Backward Filtering**. The dialog settings should look like the following figure, and the IIR filter is designed.

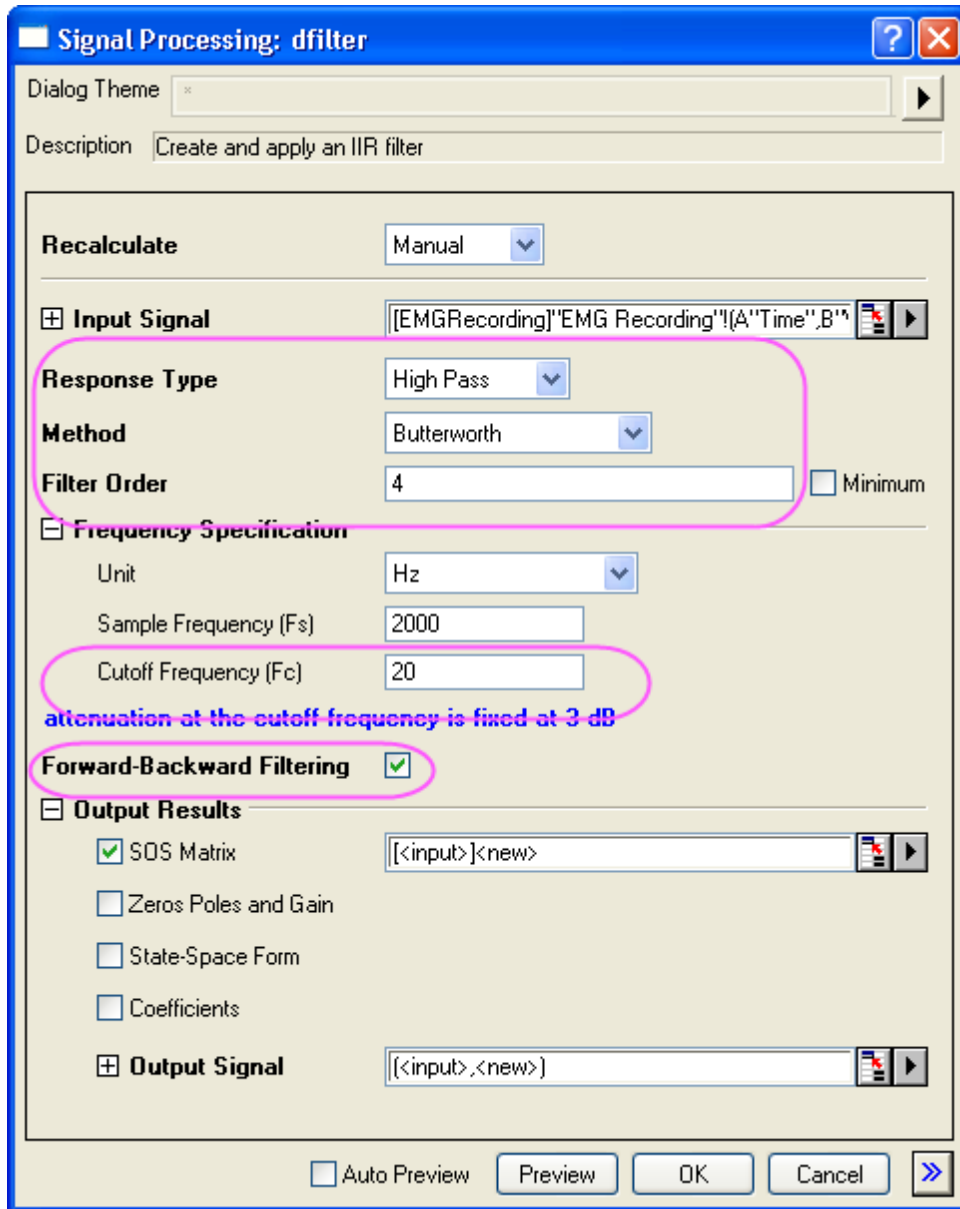





4. Click **OK** to apply the created IIR filter to the input dataset.

5. A new column will be added to the original data as a new column of filtered data and a new SOS Matrix worksheet.

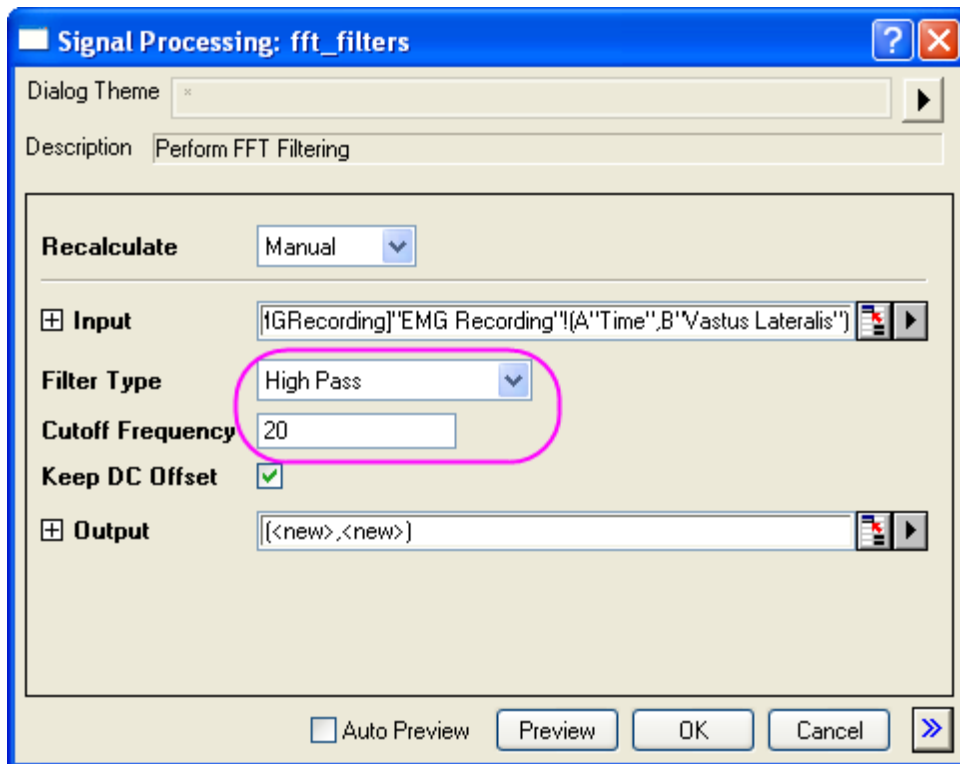
#### 4.4.6.3.2 Compare Results with FFT Filter

1. Highlight column B in the original worksheet, perform FFT filter by **Analysis:Signal Processing:FFT Filters**.
2. In the opened dialog, choose **High Pass** for Filter Type and set **20** as Cutoff Frequency.



3. Click OK button. Column C in the EMGRecording worksheet is the filtered result of the previously designed IIR filter, highlight column B and column C to generate a line plot with the  button (Graph 1).
4. Use the scale in button  to zoom the area between 12.5s and 13.3s.
5. Column E in the EMGRecording worksheet is the filtered result of the FFT filter, highlight column B and column E to generate a line plot with the  button (Graph 2).
6. Also use the scale in button  to zoom the area between 12.5s and 13.3s, the two graphs could be used for visualized comparison.

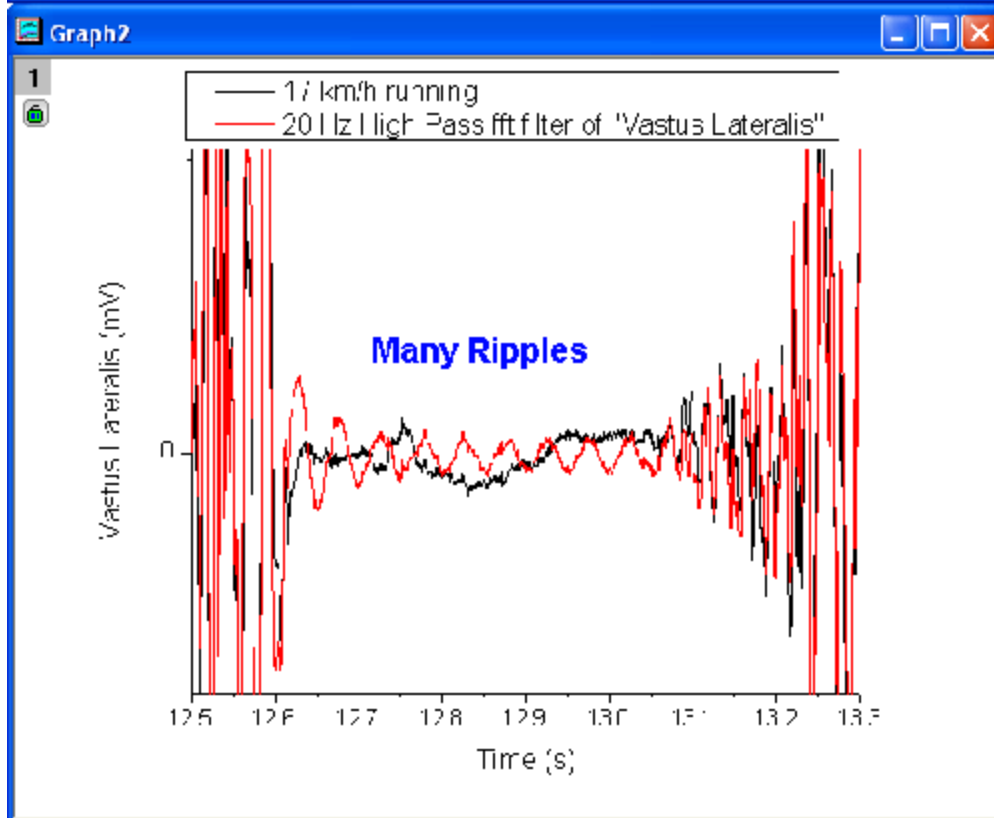
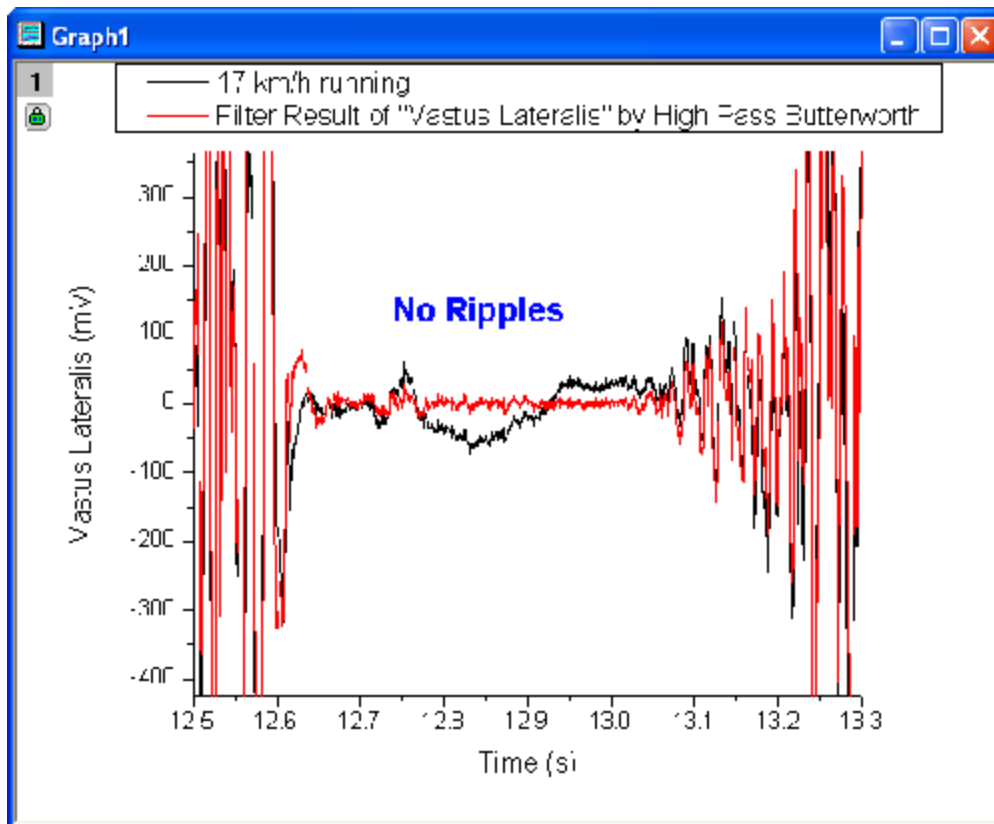

- Note that there are many ripples in the FFT filter result, but almost no ripples in the IIR filter result.

#### 4.4.6.3.3 Ripples in FFT Filter

- Highlight column E and click on the  button to create a line plot (Graph 3).
- Activate Graph 3, choose **Gadget:FFT** and set the X Scale as From **12.664** To **13.052**.
- Click OK to bring up the preview window, in which ripples are almost pure 20.125 Hz sine.

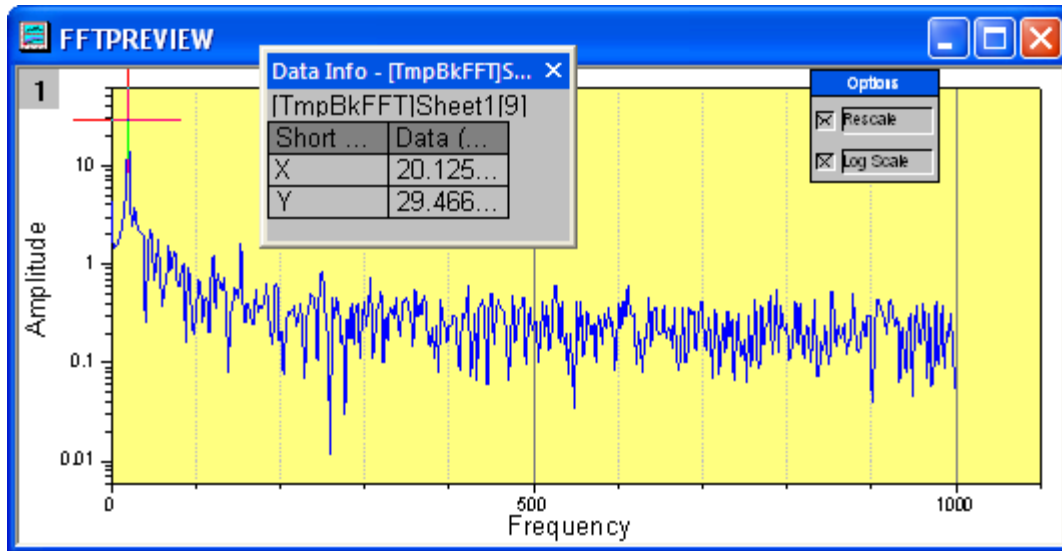

- Now we would try to remove the ripples at 20.125 Hz by applying another high pass filter at 25 Hz, keep highlighting column E and select **Analysis:Signal Processing:FFT Filters**.
- Select **High Pass** for Filter Type and set Cutoff Frequency as **25**.
- The result is listed in Column G, highlight column G and click on the  button to create a line plot(Graph 4).
- Activate Graph 4, choose **Gadget:FFT** and set the X Scale as From **12.664** To **13.052**, in the preview window, there are still ripples, and they are shifted from 20.125 Hz to 25.157 Hz.

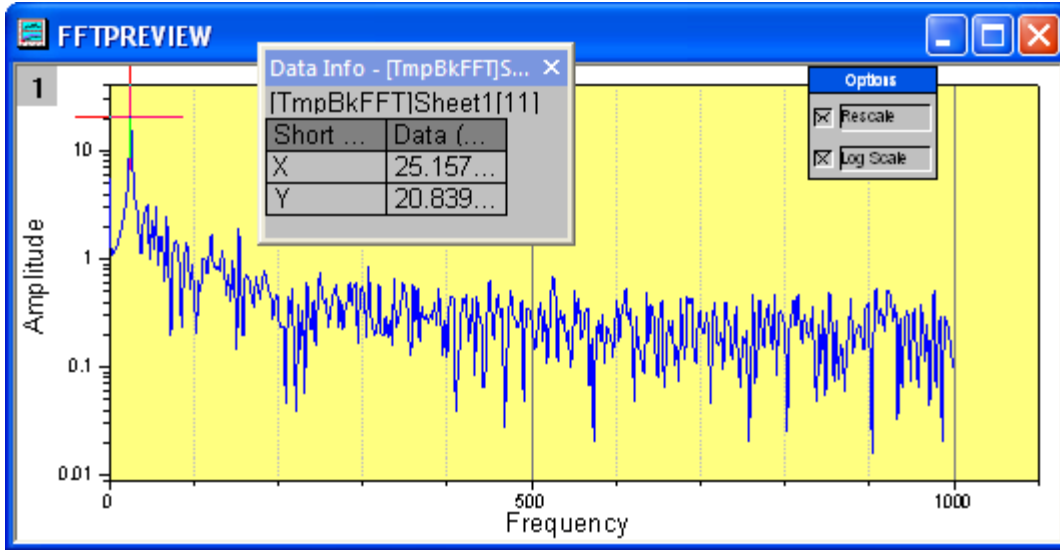

- Note that the ripples could not be removed by FFT filter for this dataset.

#### 4.4.7 2D FFT and Filter

##### 4.4.7.1 Summary

2D FFT (2-dimensional Fast Fourier Transform) can be used to analyze the frequency spectrum of 2D signal (matrix) data. Conversely, 2D IFFT (2-dimension Inverse Fast Fourier Transform) is able to reconstruct a 2D signal from a 2D frequency spectrum. OriginPro provides both for conversion between time and frequency domains in 2 dimensions, together with the 2D FFT filter to perform filtering on a 2D signal.

##### 4.4.7.2 What You Will Learn

This tutorial will show you how to:

1. Convert image into data.
2. Perform 2D FFT on matrix data with DC shift to center.
3. Perform 2D IFFT on the 2D FFT result to recover the original matrix data.
4. Perform 2D FFT filter on matrix data.

##### 4.4.7.3 Steps

###### 4.4.7.3.1 2D FFT

1. Start with a new matrix book, and select menu item **Data: Import from File: Image to Matrix...** to import the image **<Origin Installation Directory>\Samples\Image Processing and Analysis\cell.jpg**.



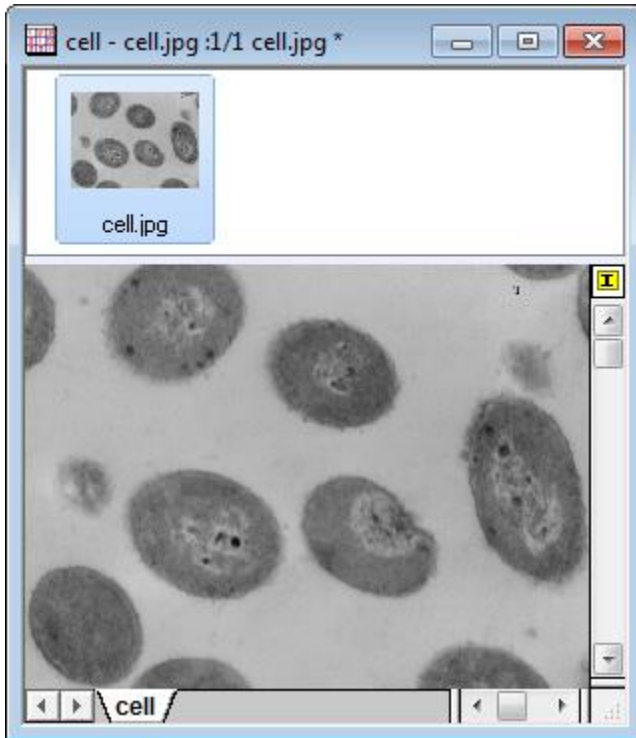

2. Because Origin is not able to perform analyses on image data directly, we need to convert the image to matrix data first. So, select menu item **Image: Conversion: Convert to Data** to bring up the **Convert to Data: img2m** dialog box. Set **Type** to **byte(1)**.

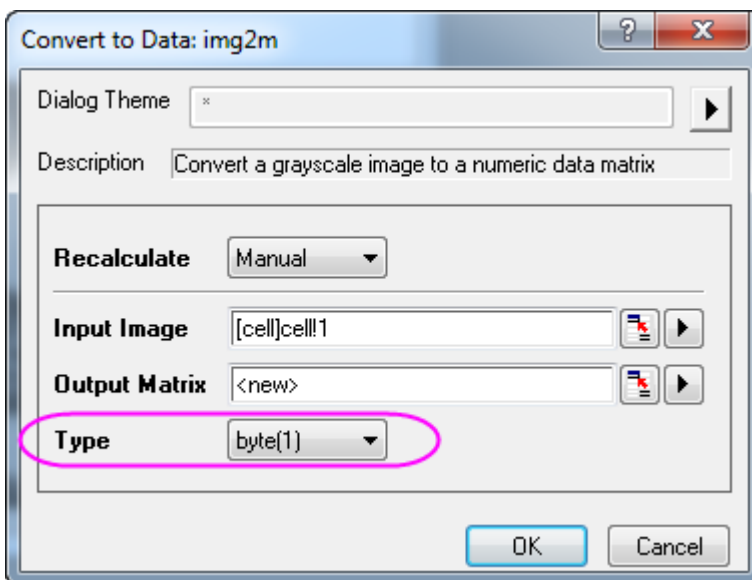

3. Click **OK** to finish the conversion. The result shows below. You can choose menu item **View: Data Mode** and **View: Image Mode** to convert between data mode and image mode.

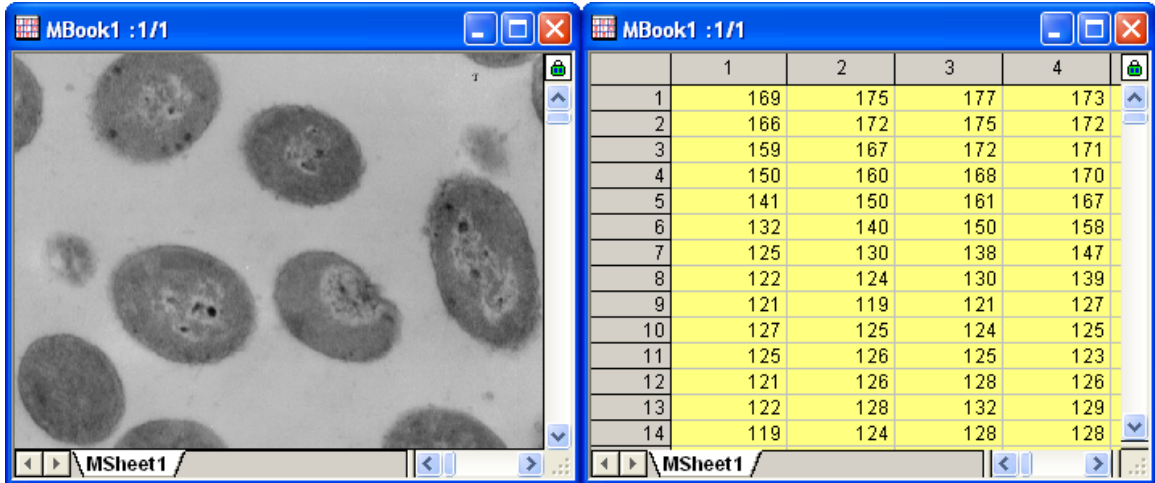

- With the converted result matrix active, select the menu item **Analysis: Signal Processing: FFT: 2D FFT...** to open the **2D FFT: fft2** dialog box. Check the **DC Shift Center** check box to shift the direct current to center. In the **Output** node, only check **Complex Matrix** and **Log Amplitude Matrix**.

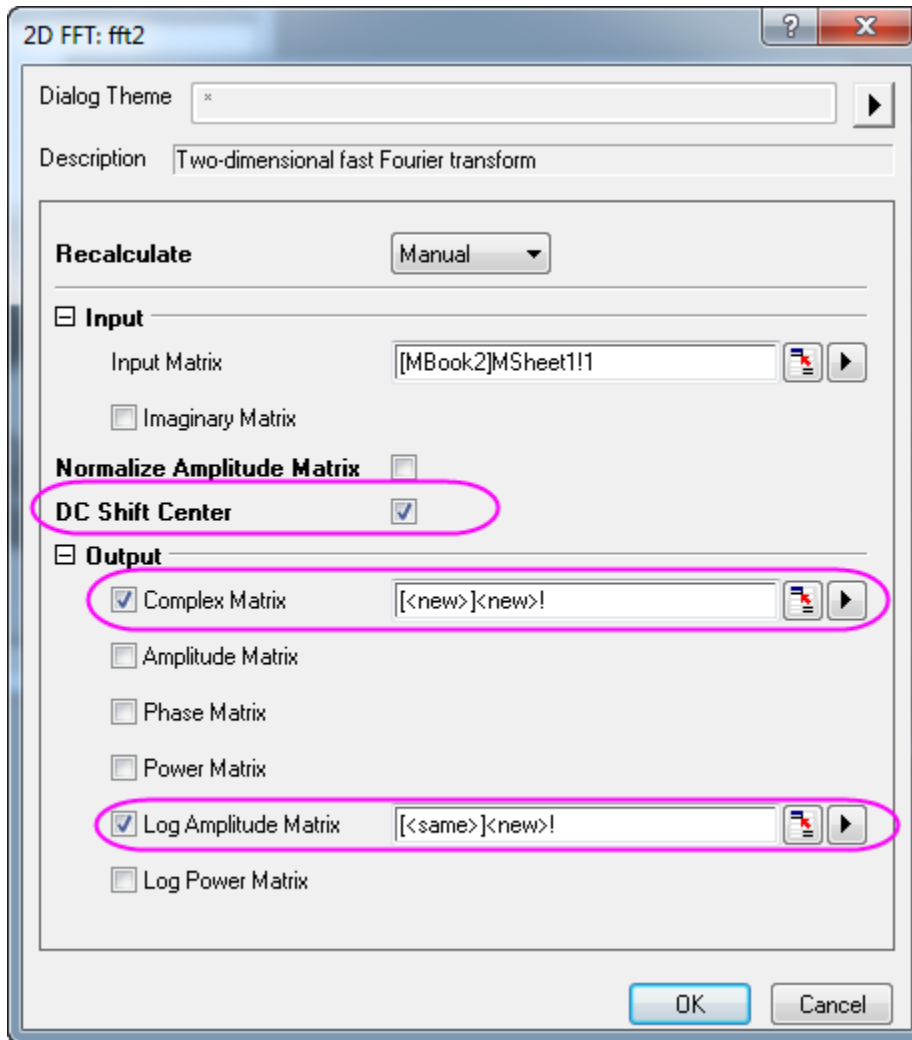

- Click the **OK** button to generate the FFT results. Both the complex matrix and the log amplitude matrix are in the same matrix book. Change to image mode (**View:Image Mode**) for the log amplitude matrix. The results should look like this:

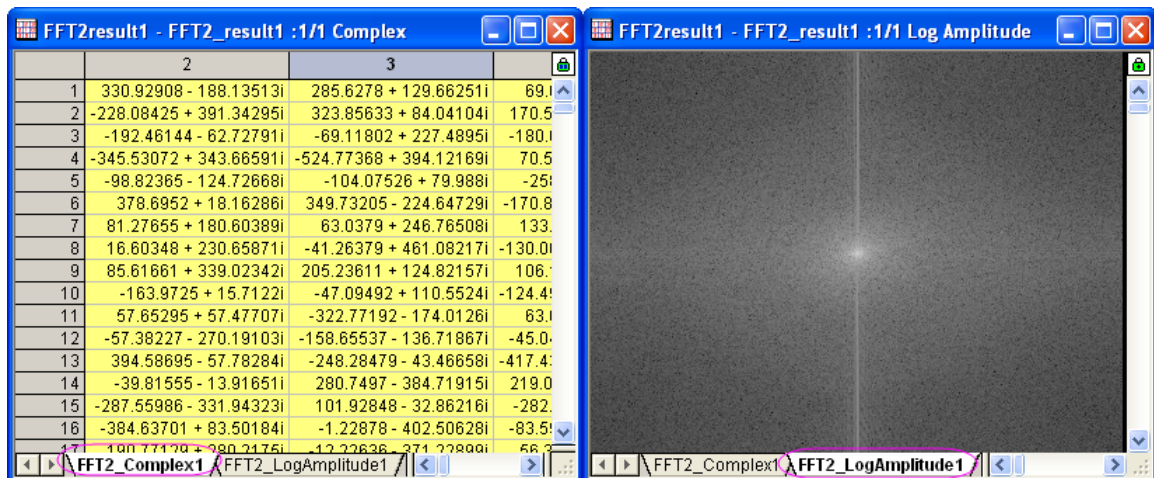

#### 4.4.7.3.22D IFFT

1. Start with the complex matrix (FFT2\_Complex1) generated in the **2D FFT** section above. Make it the active window.
2. Select the menu item **Analysis: Signal Processing: FFT: 2D IFFT...** to bring up the **2D IFFT: ifft2** dialog box.
3. In the dialog box, the imaginary matrix is not needed because the **Input Matrix** is a complex matrix. Check **Undo Shift** because DC has been shifted. **Output** should have the **Real Matrix** and **Imaginary Matrix** boxes checked.

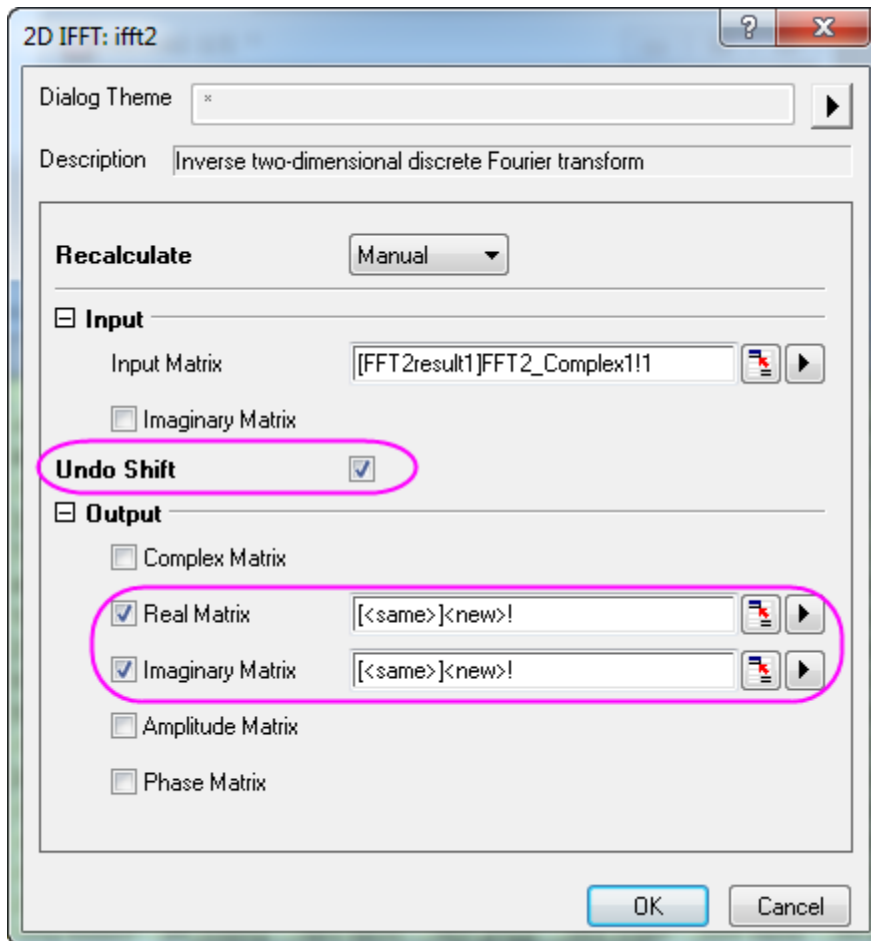

4. Click the **OK** button, and the result will be output to the same matrix book as the input complex matrix.

	1	2	3	4	5	6
1	169	175	177	173	174	
2	166	172	175	172	173	
3	159	167	172	171	172	
4	150	160	168	170	171	
5	141	150	161	167	170	
6	132	140	150	158	164	
7	125	130	138	147	155	
8	122	124	130	139	148	
9	121	119	121	127	134	
10	127	125	124	125	128	
11	125	126	125	123	123	
12	121	126	128	126	125	
13	122	128	132	129	127	
14	119	124	128	128	128	
15	116	118	122	126	128	
16	120	119	122	126	128	
17	113	111	120	128	127	

5. From the comparison shown below, the IFFT has recovered the original signal.

	1	2	3	4
1	169	175	177	173
2	166	172	175	172
3	159	167	172	171
4	150	160	168	170
5	141	150	161	167
6	132	140	150	158
7	125	130	138	147
8	122	124	130	139
9	121	119	121	127
10	127	125	124	125
11	125	126	125	123
12	121	126	128	126
13	122	128	132	129
14	119	124	128	128

Original data

	1	2	3	4
1	169	175	177	173
2	166	172	175	172
3	159	167	172	171
4	150	160	168	170
5	141	150	161	167
6	132	140	150	158
7	125	130	138	147
8	122	124	130	139
9	121	119	121	127
10	127	125	124	125
11	125	126	125	123
12	121	126	128	126
13	122	128	132	129
14	119	124	128	128

Real part of IFFT result

	1	2	3	4
1	-1.93268E-15	5.44939E-15	-6.91026E-15	9.55
2	4.57624E-15	-8.91733E-16	-8.59599E-15	8.73
3	1.07486E-15	1.15949E-14	-3.12589E-16	1.18
4	1.95427E-15	4.24465E-15	-9.11875E-15	9.7
5	2.04847E-15	-2.64704E-16	-6.58922E-15	4.64
6	5.29929E-15	8.36949E-16	-2.18698E-15	1.05
7	2.35274E-15	3.19136E-15	-7.50514E-15	7.39
8	4.07856E-15	-6.79411E-16	-5.33021E-15	1.64
9	4.76753E-15	3.24993E-15	3.29736E-15	9.6
10	1.72977E-15	-1.15521E-15	-8.02665E-15	1.16
11	5.20158E-15	1.58656E-16	-3.0464E-15	8.05
12	8.8207E-15	9.41593E-16	1.81782E-15	1.48
13	2.49731E-15	1.76823E-15	-7.46221E-15	9.2
14	3.44932E-16	5.83679E-16	-1.56851E-15	1.46

Imaginary part of IFFT result

#### 4.4.7.3.32D FFT Filter

1. Start with an empty matrix book and from the menu select **Data: Import from File: Image to Matrix...** to import the image **<Origin Installation Directory>\Samples\Image Processing and Analysis\myocyte1.tif**.

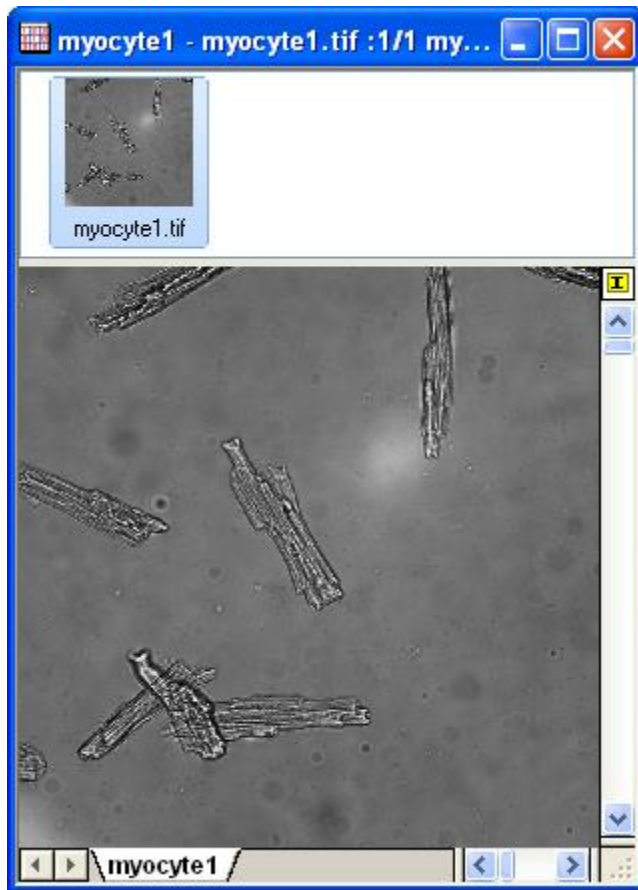

2. With the imported image active, select the menu item **Image: Conversion: Convert to Data**. This opens the **Convert to Data: img2m** dialog box. Set **Type** to **byte(1)** and click **OK** to finish the conversion.

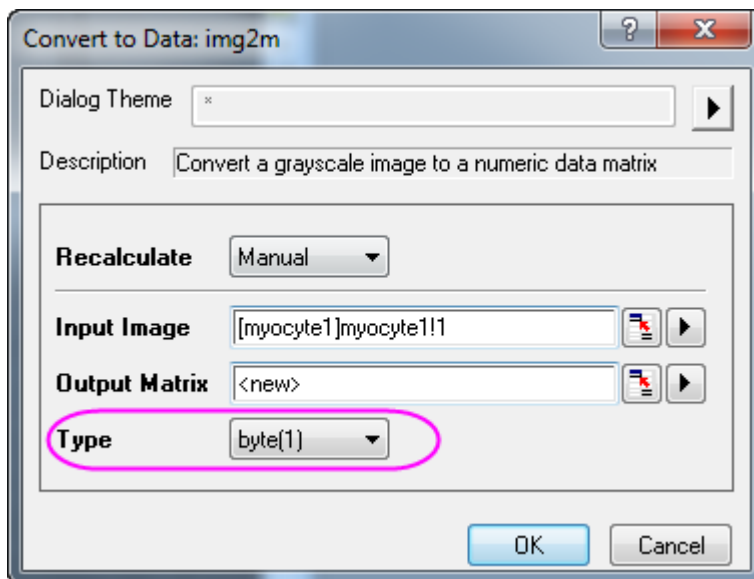

3. Activate the converted matrix and select the menu item **Analysis: Signal Processing: 2D FFT Filters...**. This opens the **2D FFT Filters: fft\_filter2** dialog box.
4. In the dialog box, check the **Auto Preview** check box at the bottom to view the result in the right panel. Set **Filter Type** to **Band Pass**, and set **Lower Cutoff Value** and **Upper Cutoff Value** to **0.05** and **0.25** respectively. For other controls, keep the default values.

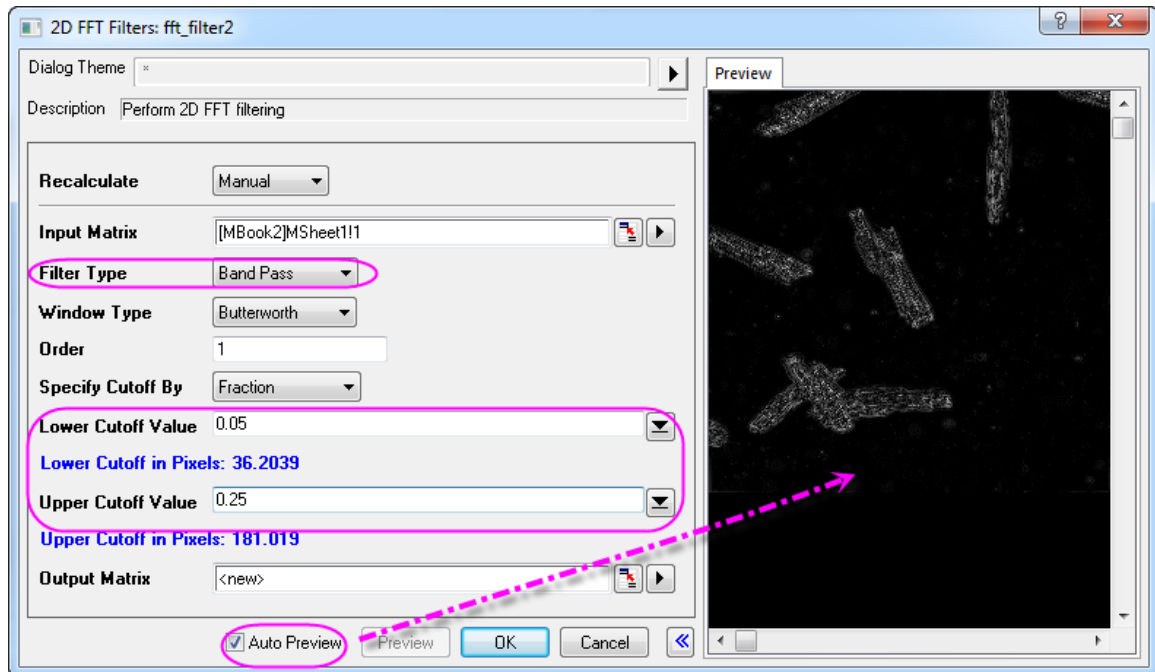

5. Click **OK** to obtain the filtered result. As the image below shows, the background noise (the light) is removed.

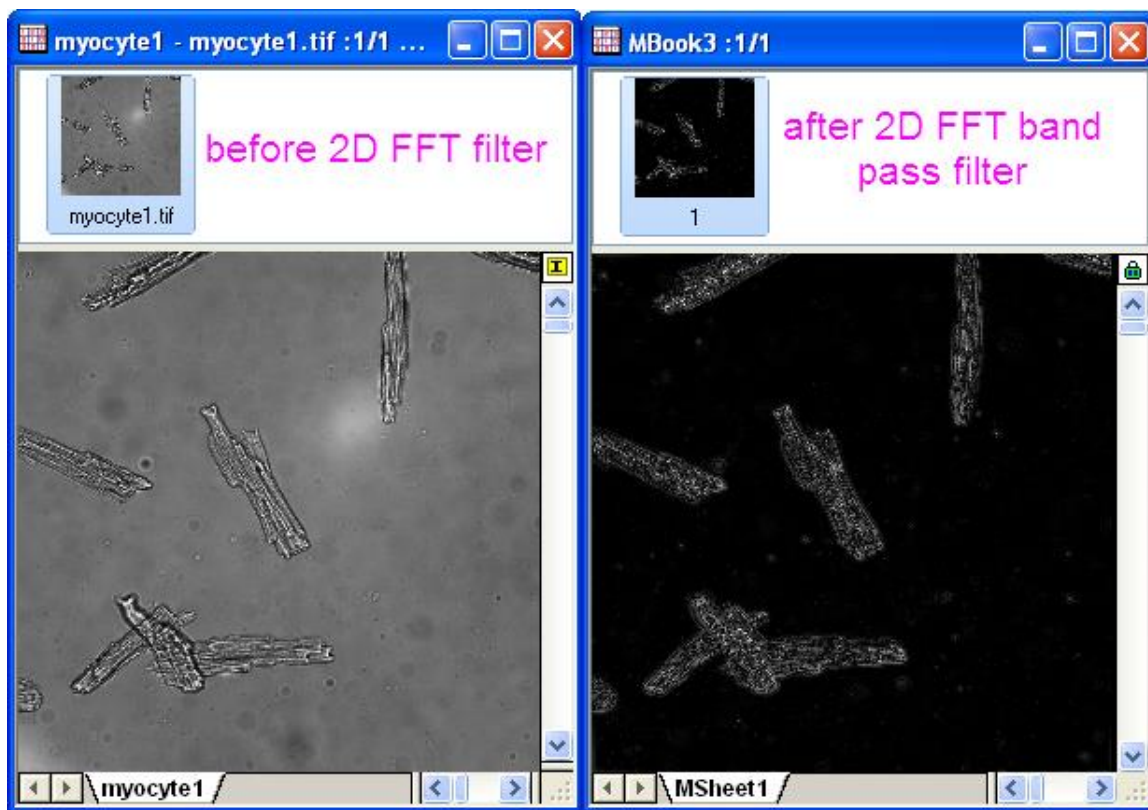

## 4.4.8 Convolution

### 4.4.8.1 Summary

Convolution is commonly used in signal processing. Origin uses the convolution theorem, which involves the Fourier transform, to calculate the convolution.

### 4.4.8.2 What You Will Learn

With this tutorial, you will learn how to perform convolution in Origin.

### 4.4.8.3 Steps

1. Start with a new workbook.
2. Import the data **<Origin Installation Directory>\Samples\Signal Processing\Convolution.dat**.



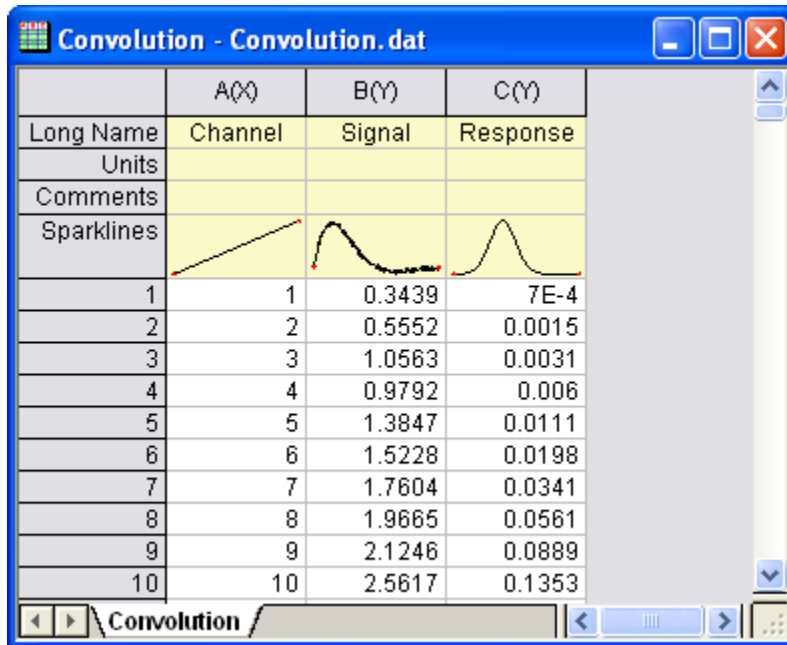

- Highlight column B and C, and from the menu select **Analysis: Signal Processing: Convolution....** This opens the **Convolution: conv** dialog box. In the dialog, column B is labelled as Signal, and column C as Response and the Sample Interval will be set according to the input signal's associated X column.
- Expand the **Options** node and change **Convolution Type** to *Circular*, to repeat the data within range for the data outside range, but not pad with zeroes.

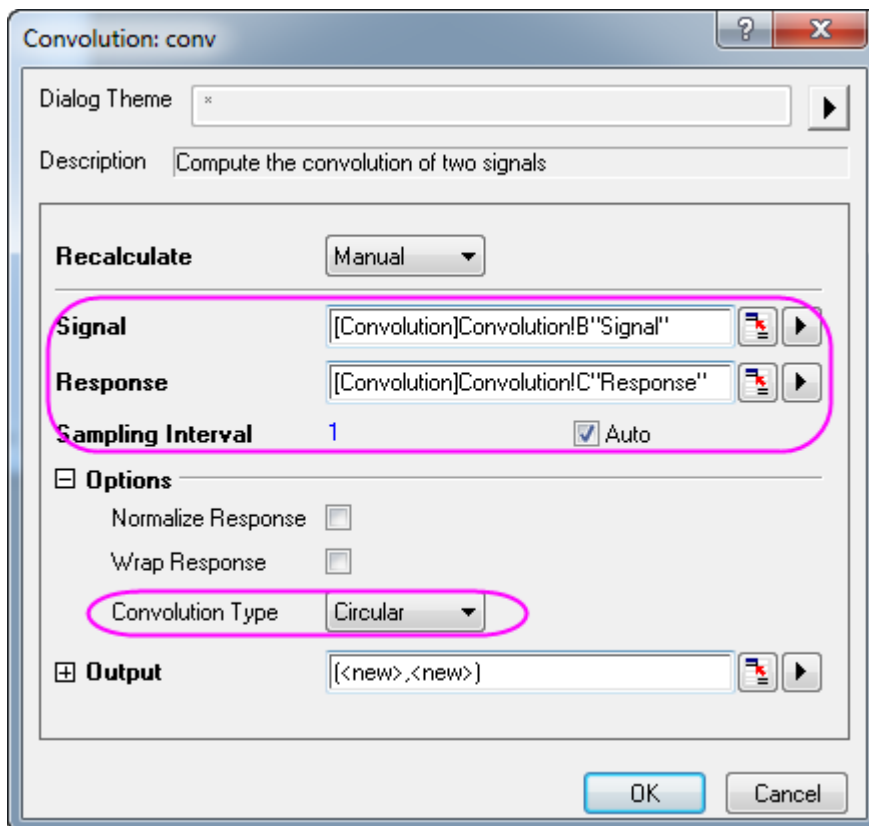

5. Click **OK** to obtain the result.
6. In the worksheet, highlight column B and E (press CTRL to select non-adjacent columns), then from the menu select **Plot: Line: Line** to make a graph with input signal and the output signal.

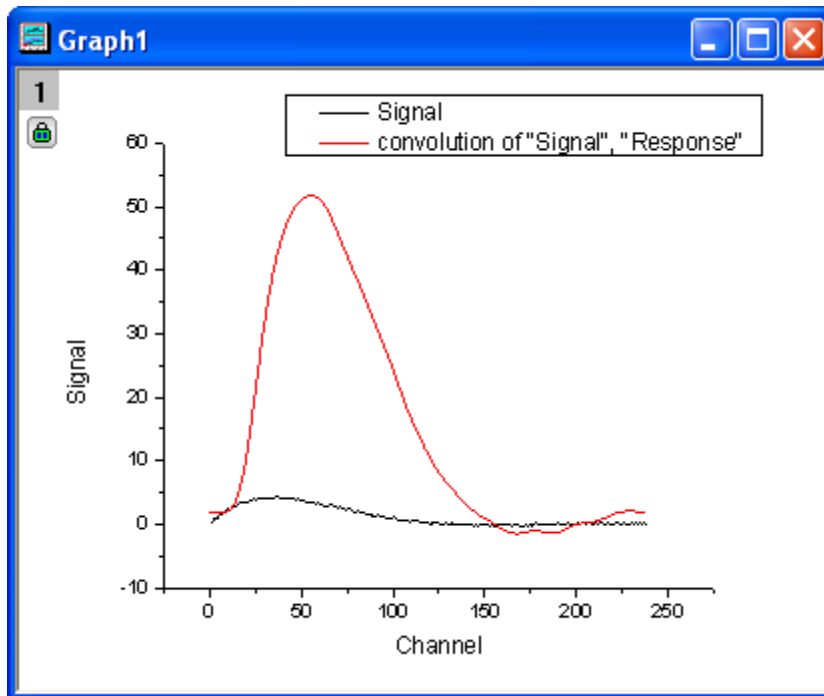

## 4.4.9 Wavelet

### 4.4.9.1 Summary

Wavelet transforms are useful for analyzing signals which exhibit sudden changes of phase and frequency, local maxima and minima, or related parameters. Wavelet transforms have become a popular tool in time-frequency analysis, especially for analysis of non-stationary signals. OriginPro provides wavelet transform tools for both continuous and discrete transforms.

### 4.4.9.2 What You Will Learn

This tutorial will show you how to:

1. Perform one-level discrete wavelet decomposition and reconstruct a signal from approximation coefficients and detail coefficients.
2. Apply multi-level discrete wavelet decomposition.
3. Perform continuous wavelet transform.
4. Remove noise from signals by using wavelet transform.
5. Perform 2D wavelet decomposition and reconstruction on matrix data.
6. Convert an image to matrix data.
7. Merge graph windows into one graph.

### 4.4.9.3 1D Wavelet Transform

#### 4.4.9.3.1 **Decomposition**

1. Start with a new workbook, and select menu **Data: Import from File: Single ASCII...** to import the data **<Origin Installation Directory>\Samples\Signal Processing\Chirp Signal.dat** into the worksheet.

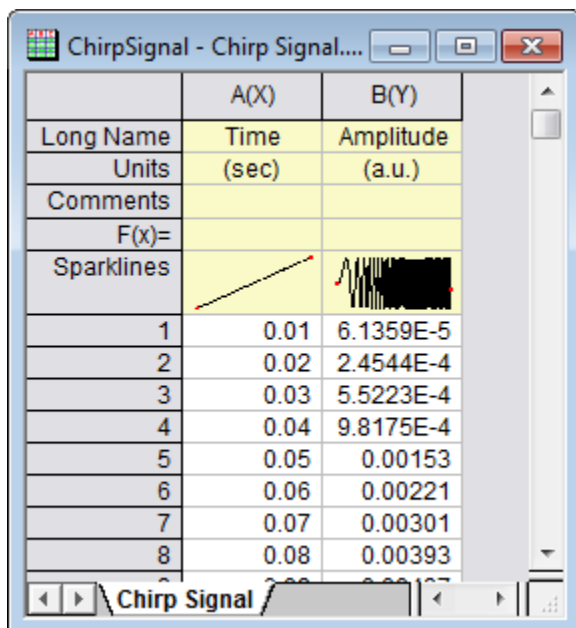

2. Highlight column B, and select menu item **Analysis: Signal Processing: Wavelet: Decompose...** to open the **Decompose: dwt** dialog.
3. In the dialog, choose **DB6** for **Wavelet Type & Order**, and **Zero-padded** for **Extension Mode**.

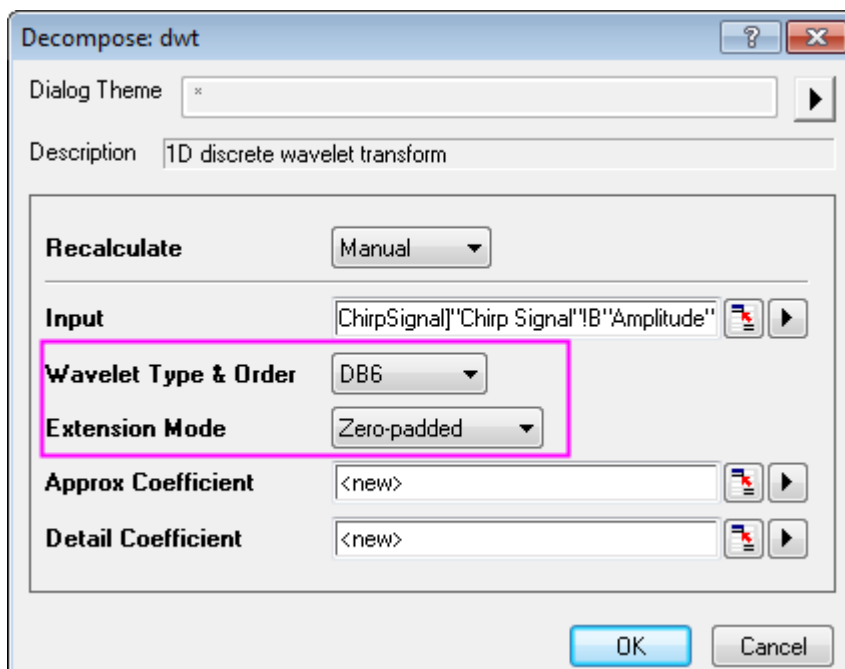

4. Click **OK** to close the dialog box and output the approximation coefficients and the detail coefficients.

- Highlight columns B, C, and D (columns C and D should contain your approximation coefficients and your detail coefficients, respectively). From the menu, select **Plot: Multi-panel: Stack...** to open the **Stack: plotstack** dialog box.
- In this dialog, clear the **Link Layers** check box in the **Options** node. Check the **Auto Preview** check box at the bottom to see the preview graph in the right panel.

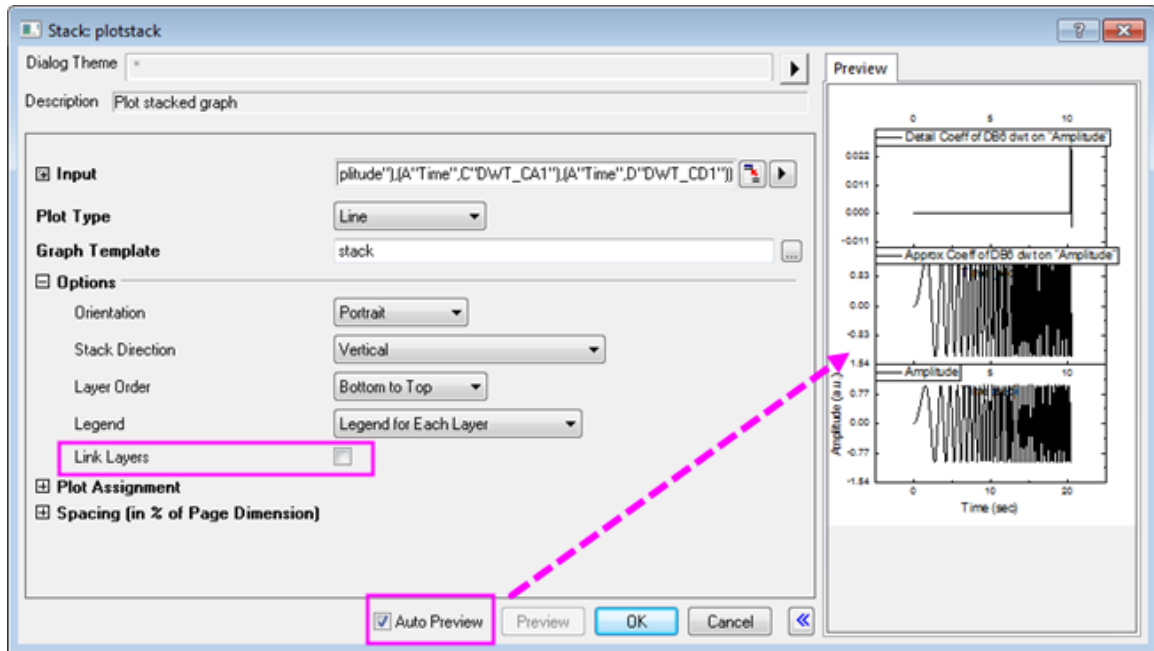

- Click **OK** to close the dialog box and create a stack graph.

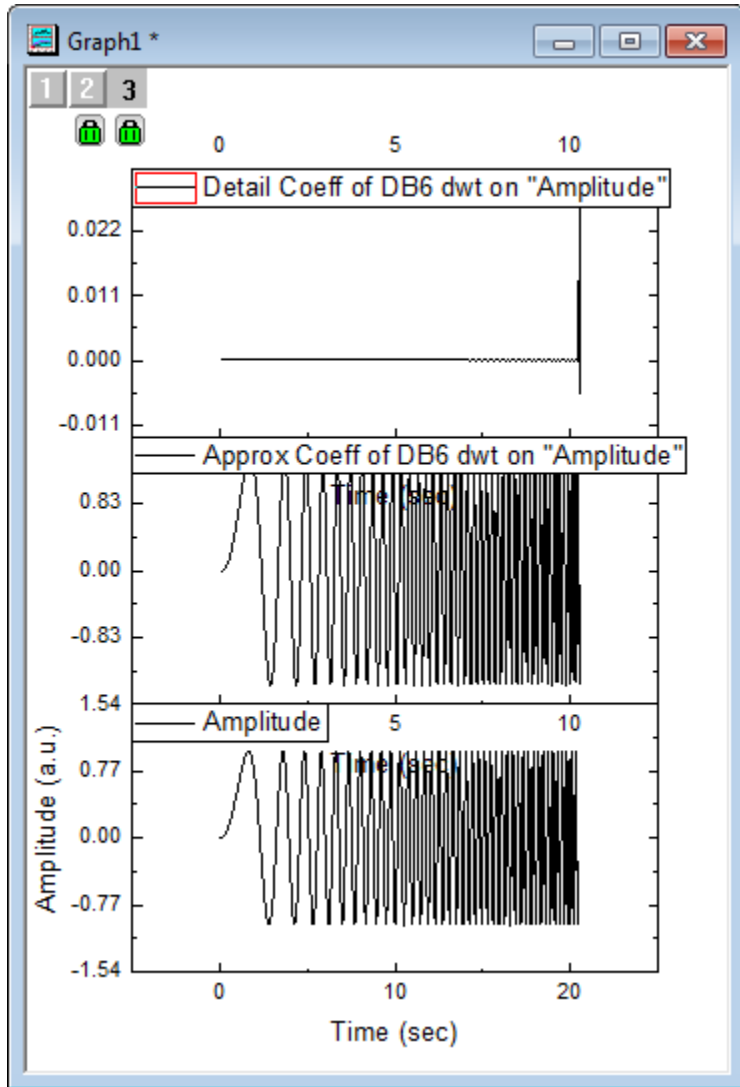

**Note:** To perform level 2 (3, 4, etc.) discrete wavelet decomposition, repeat steps 2 to 4 on the approximation coefficients (column C, in our example). Multi-scale wavelet decomposition (available in OriginPro) is demonstrated below.

#### 4.4.9.3.2 Reconstruction

Reconstruction is the inverse operation of decomposition and this example will recover the signal from the result generated above.

1. Highlight columns C and D (your approximation coefficients and detail coefficients, from above).
2. Choose menu item **Analysis: Signal Processing: Wavelet: Reconstruction...** to bring up the **Reconstruction: idwt** dialog box.
3. To reconstruct the signal, we need to specify the same **Wavelet Type**, and **Boundary**, so set them to **DB6** and **Zero-padded**, respectively.

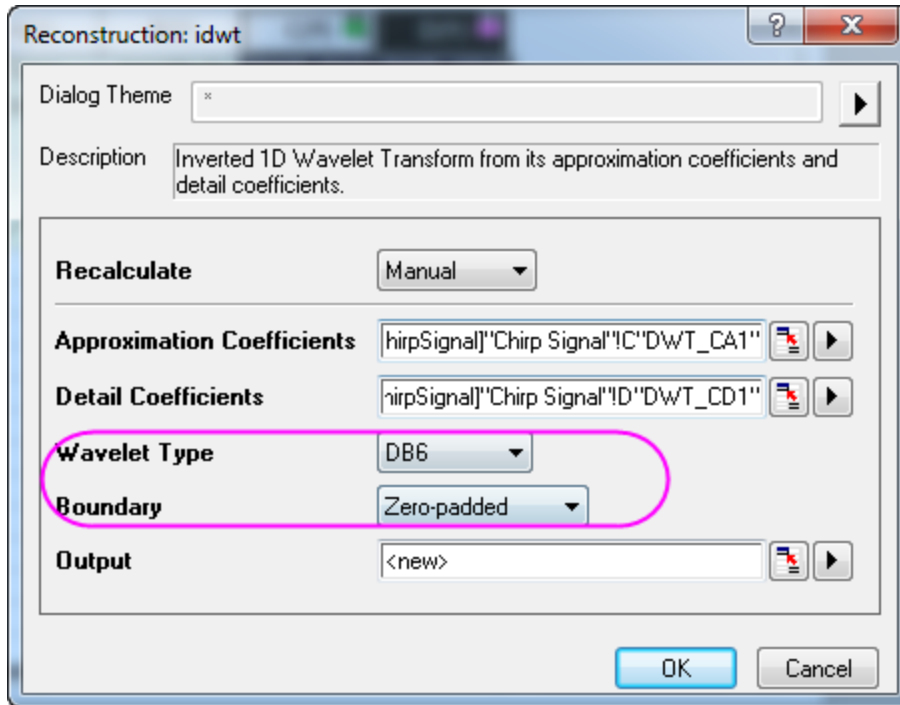

4. Click **OK** and the recovered signal is output to column E of the worksheet.
5. Press CTRL and select columns B and E. From the menu, choose **Plot: Line: Line** to make a graph with these two columns of data.

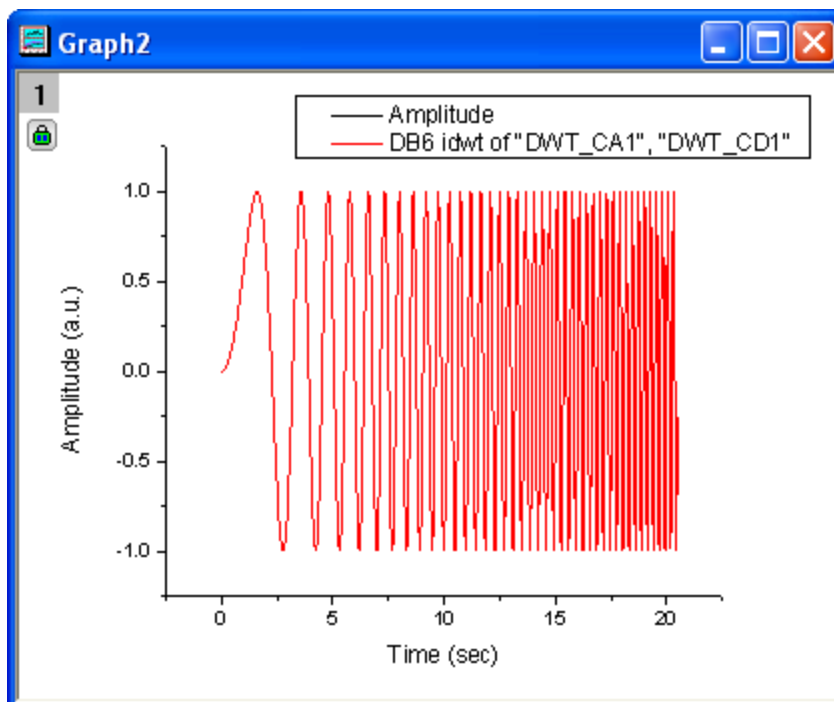

6. We can see from the resulting graph that the original signal and the recovered signal overlay each other.

#### 4.4.9.3.3 Multi-Scale Wavelet Decomposition

1. Start with a new workbook, and then import the same data used in the **Decomposition** section above.
2. Highlight column B and select menu item **Analysis: Signal Processing: Wavelet: Multi-Scale DWT...** to open the **Multi-Scale DWT: mdwt** dialog box.
3. In the dialog, change **Extension Mode** to **Zero-padded**, and **Decomposition Level** to **3**. Click the arrow button beside **Multiple Coeff Data** and select [

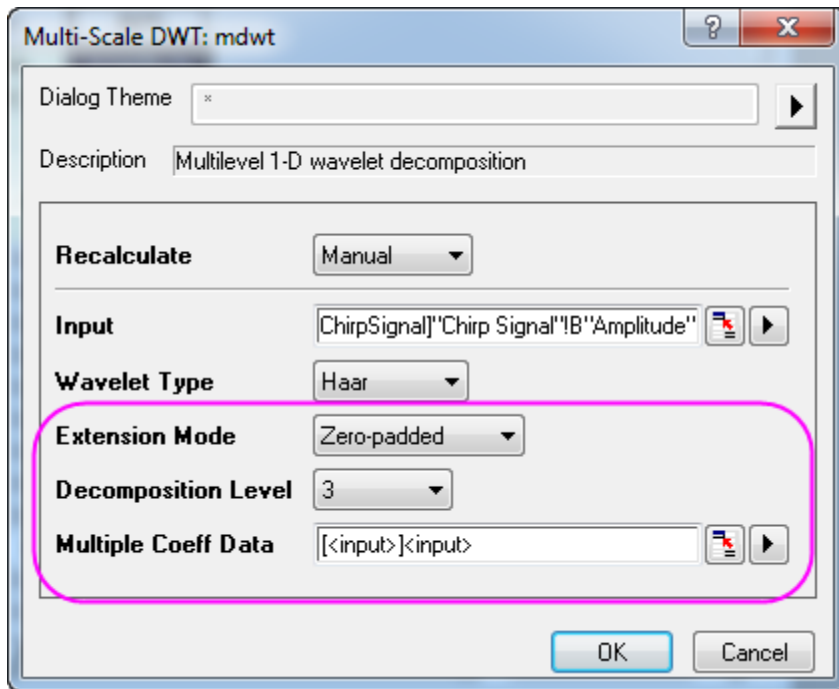

4. Click **OK** to obtain 3rd level discrete wavelet decomposition results. The coefficients are stored in the same worksheet as the input signal.
5. Select all columns in the worksheet, then choose menu **Plot: Multi-panel: Stack...** to open the **Stack: plotstack** dialog box. Click the arrow button to the right of **Dialog Theme** and select **System Default**. Check the **Auto Preview** check box at the bottom of the dialog box to preview the graph.



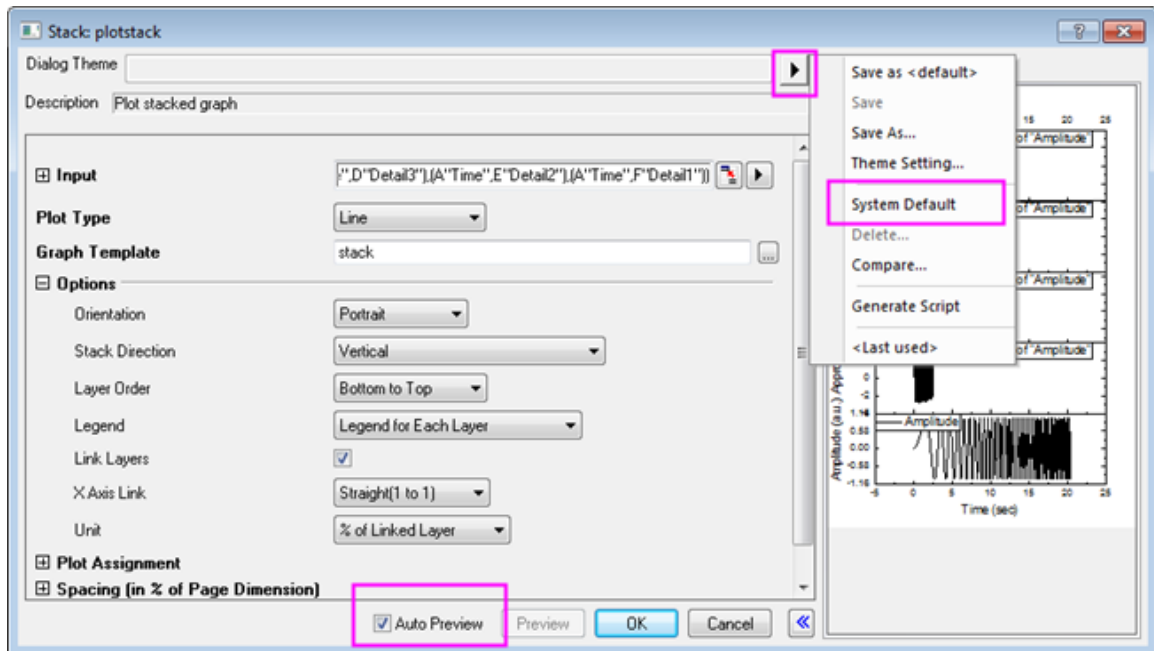

6. Click **OK**. The resulting graph is shown below.

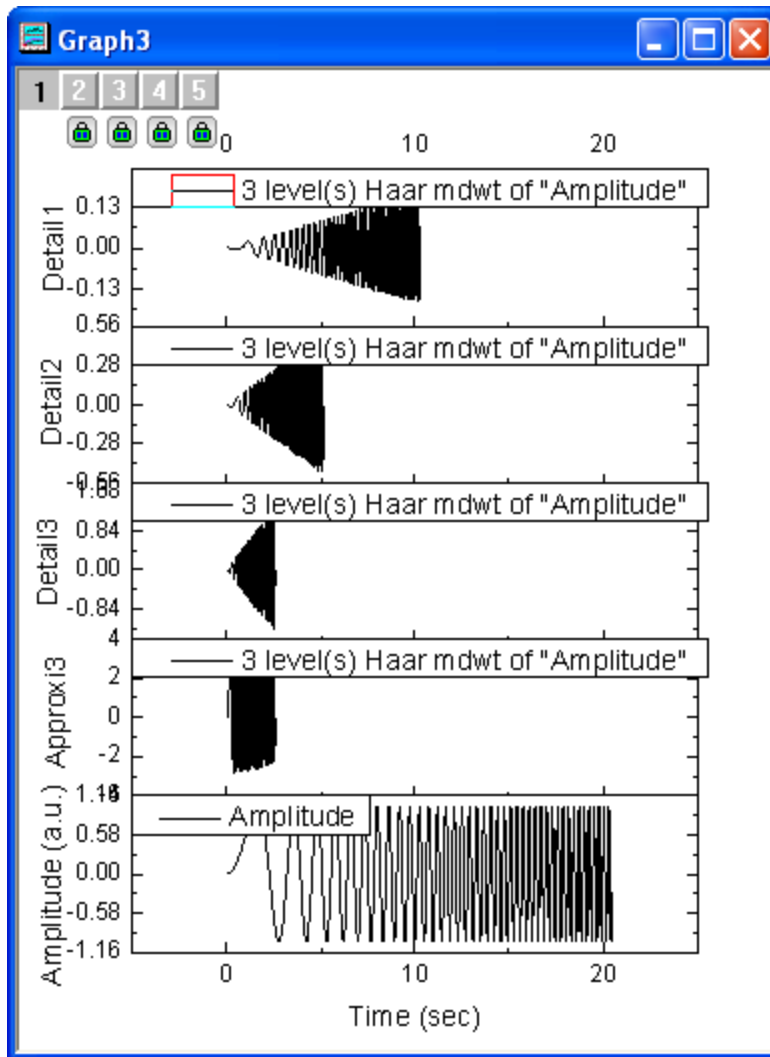

#### 4.4.9.3.4 Continuous Wavelet Transform

1. Start with a new workbook with two empty columns (columns A and B) in a single worksheet.
2. Select column A and then right-click and choose **Set Column Values...** from the shortcut menu. This opens the **Set Values** dialog box. In the text box, enter `data(0, 1, 1/1023)` and click **Apply**. This fills column A with data.

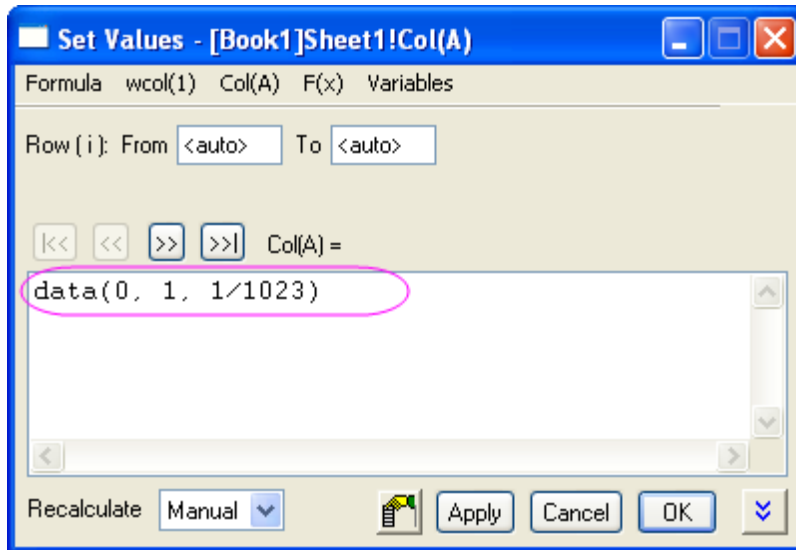

3. Click the **>>** button to select column B. Enter  $\sin(1.5/(0.25-\text{col}(A)))+\cos(0.2/(0.2-\text{col}(A)))$  and click **OK**.

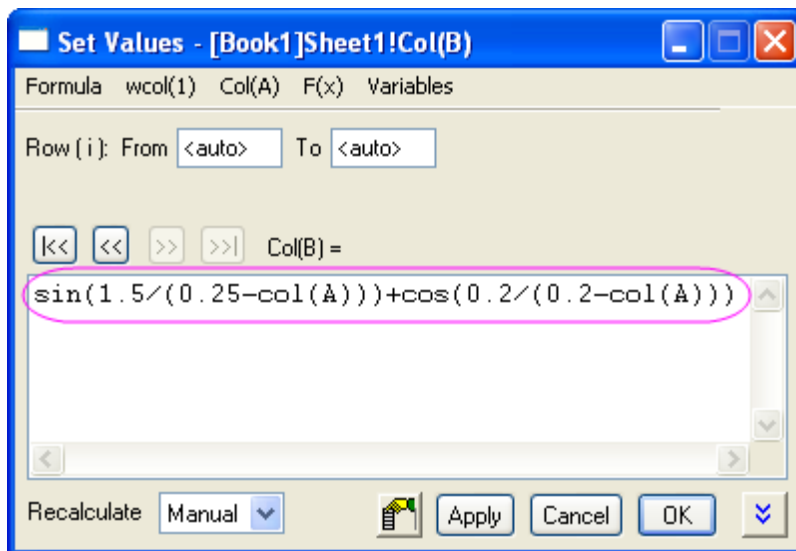

4. We can make a plot to see how the data looks. With column B selected, choose **Plot: Line: Line** from the menu.

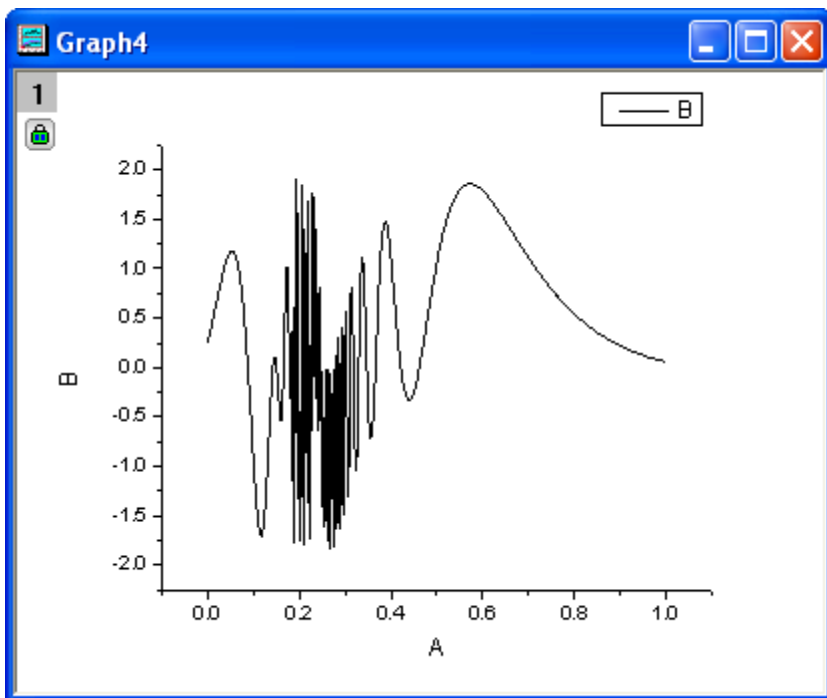

5. With the worksheet active, add a new column to the worksheet by selecting **Column: Add New Columns...** from the menu. In the dialog box, accept the default value of 1 and click **OK**.

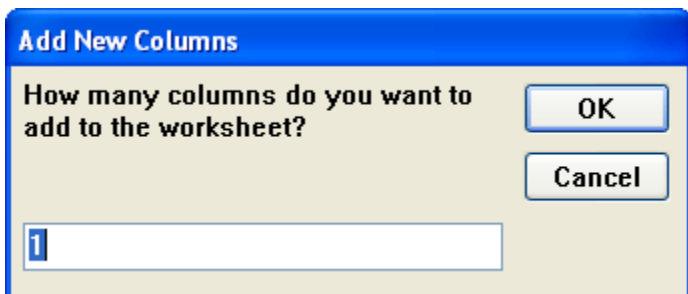

6. Column C is added to the worksheet. Select it, right-click and choose **Set Column Values** from the shortcut menu. In the text box, enter *data(1, 512)* and click **OK**.

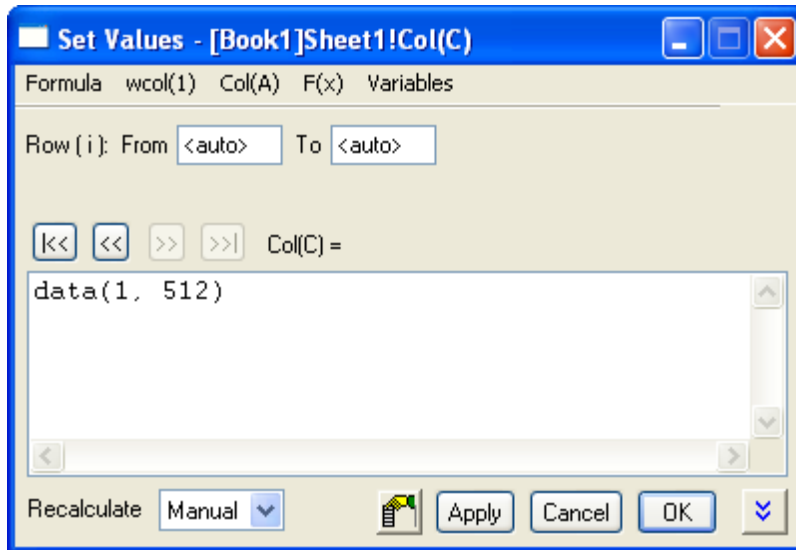

7. Select both columns B and C, then from the menu, select **Analysis: Signal Processing: Wavelet: Continuous Wavelet...** to open **Continuous Wavelet: cwt** dialog box.
8. In the dialog, set **Wavelet Type** to **MexHat**, and check **Coefficient Matrix**.

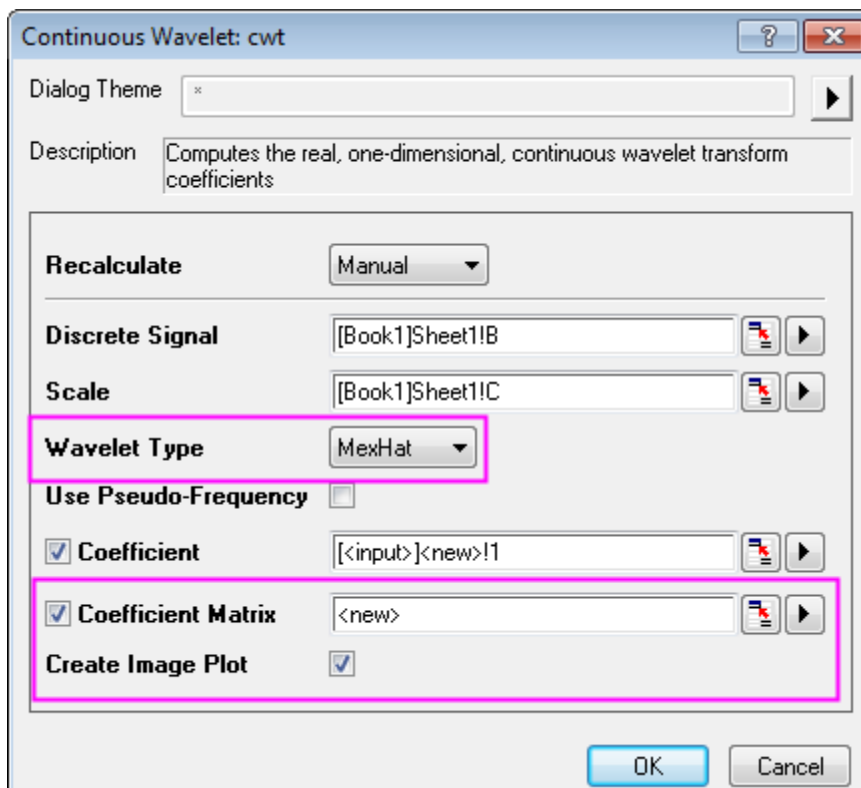

9. Click **OK** button to exit dialog.

- The coefficients are output to a new worksheet and a matrix and a contour plot is added. Double-click on the plot to open the **Plot Details** dialog box. Select the **Colormap** tab and click on the **Fill...** heading. The **Fill** dialog box opens with color controls. Click **Load Palette**, and choose **Pumpkin Patch** from the **Select Palette** menu. Click **OK** to return to the **Plot Details** dialog box.

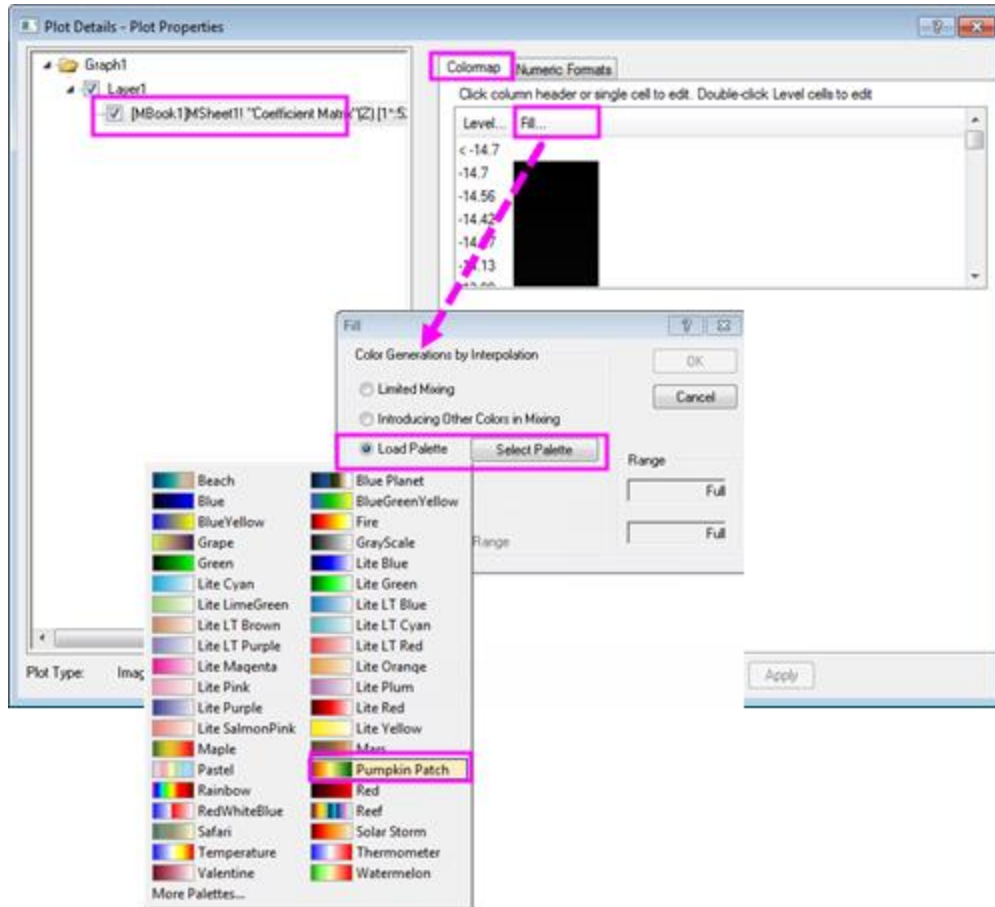

- Click **OK** to change the color of the contour plot. It should now look like the graph below.

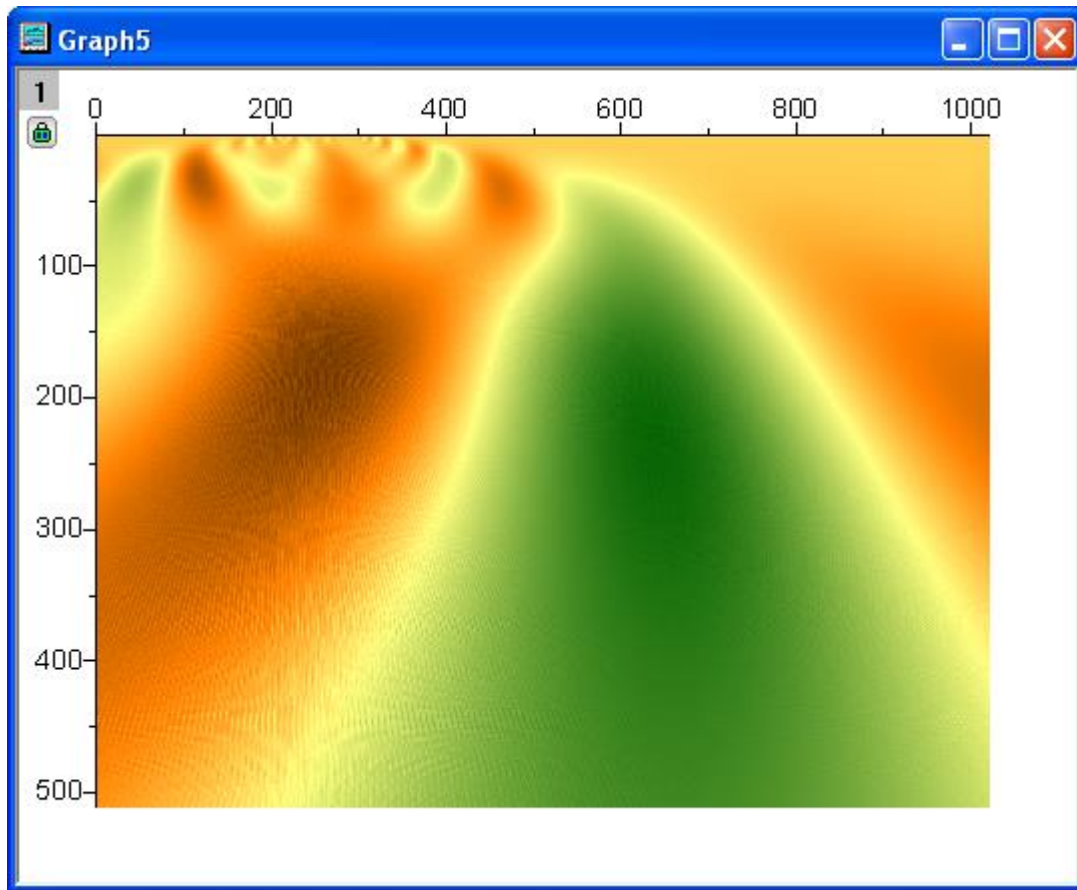

#### 4.4.9.3.5 Noise Removal by Wavelet Transform

1. Start with a new workbook and from the menu, select **Data: Import from File: Single ASCII...**  
Import the file **<Origin Installation Directory>\Samples\Signal Processing\Signal with Shot Noise.dat** .

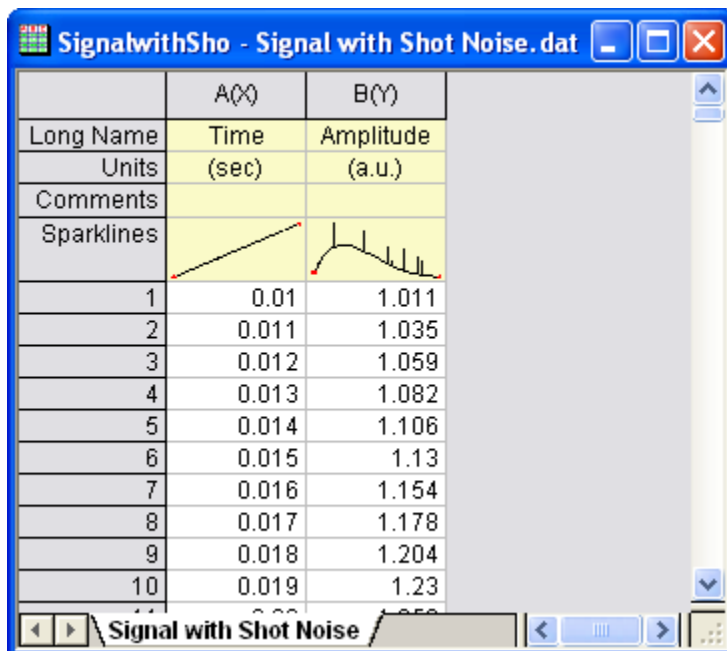

2. We can see from the Sparklines in the image above that there is shot noise in the signal. Highlight column B and select menu **Analysis: Signal Processing: Wavelet: Denoise...** to bring up the **Denoise: wtdenoise** dialog box.
3. Check **Auto Preview** to preview your result. Set **Wavelet Type** to **DB9**, **Extension Mode** to **Zero-padded**, **Threshold Type** to **sqrtwolog**, and **Thresholding Level** to **7**.

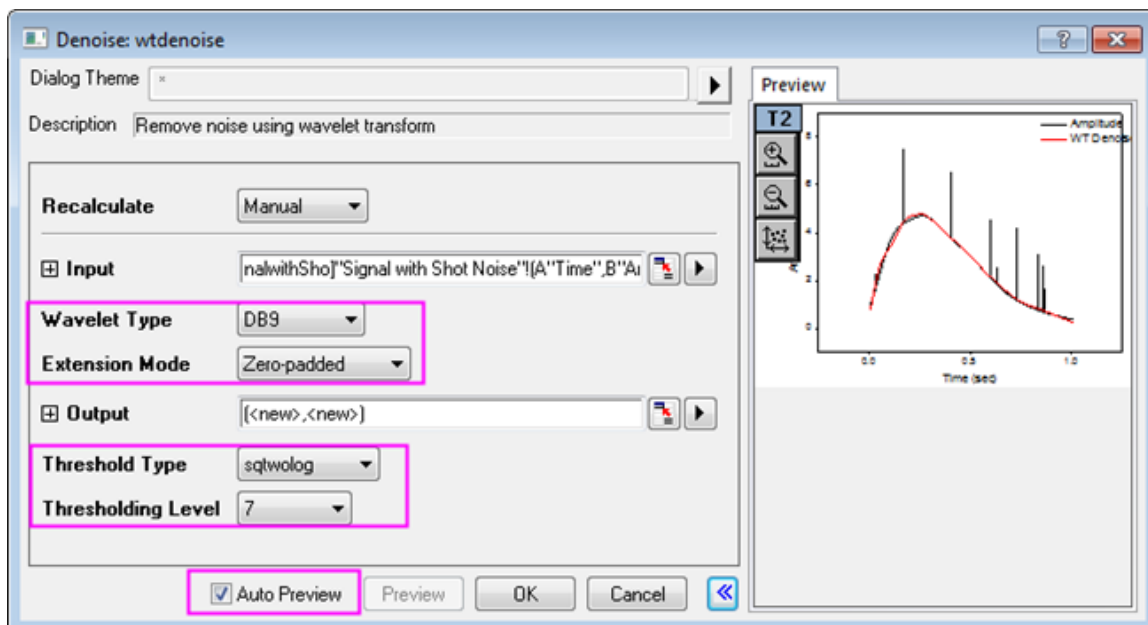

4. Click **OK** to remove the shot noise from the signal. Results are output to worksheet columns C and D.



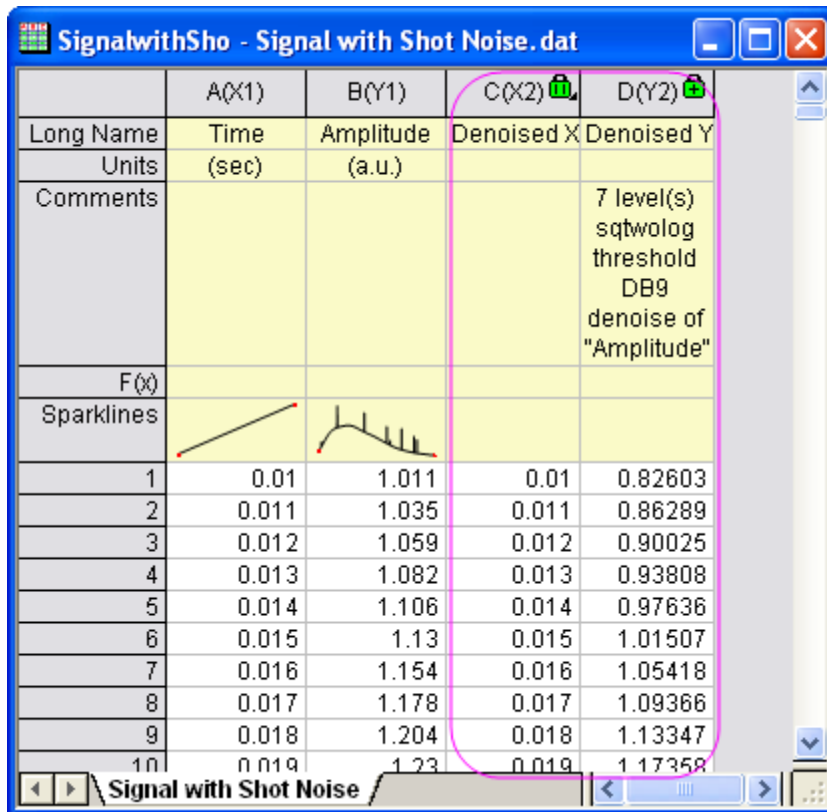

- Highlight all columns in the worksheet, then choose menu item **Plot: Line: Line** to make a graph with the original signal and the cleaned-up signal. We see from the graph below that the shot noise has been removed.

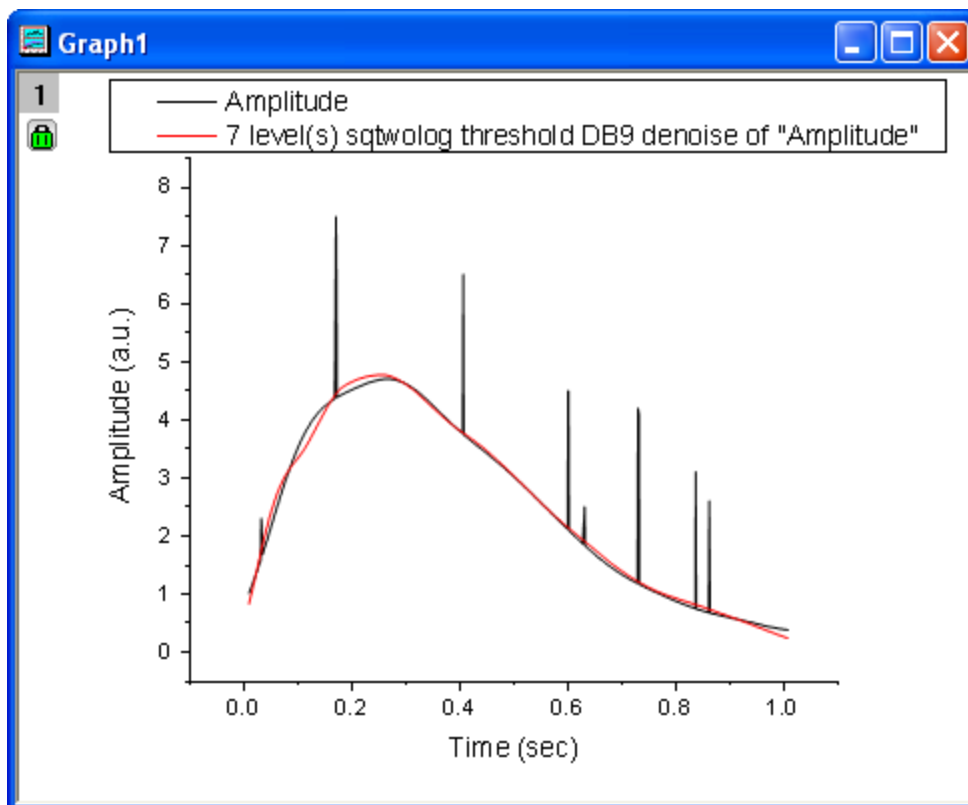

#### 4.4.9.4 2D Wavelet Transform

##### 4.4.9.4.12D Wavelet Decomposition

1. Start with a new matrix book. From the menu, choose **Data: Import from File: Image to Matrix...** and import the image, **<Origin Installation Directory>\Samples\Image Processing and Analysis\Car.bmp**.



- To begin, we need to convert the image into data. To do this, select menu item **Image: Conversion: Convert to Data**. The **Convert to Data: img2m** opens. Set **Type** to **byte(1)**.

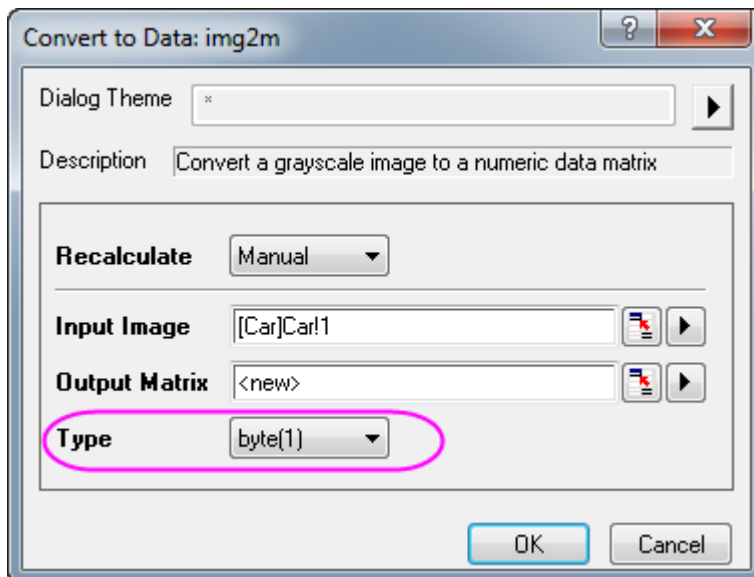

- Click **OK** to obtain the converted matrix data.
- With the converted matrix active, select menu **Analysis: Signal Processing: Wavelet: 2D Decompose...** and open the **2D Decompose: dwt2** dialog box.

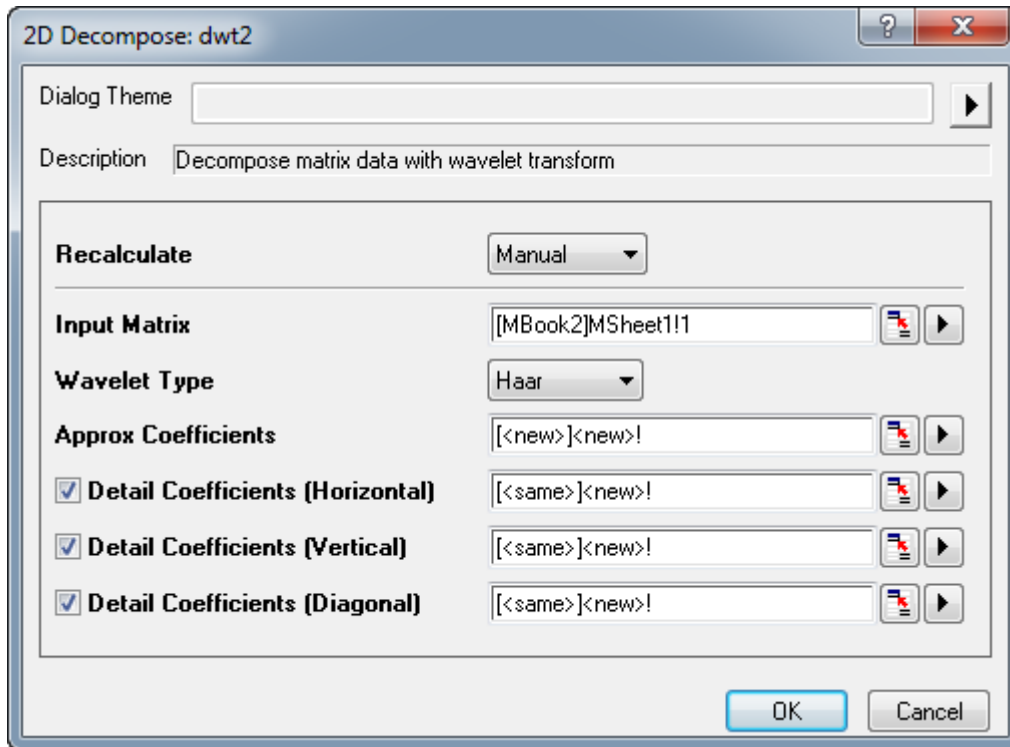

5. Accept the default settings and click **OK**. This performs 2D wavelet decomposition on the matrix data. A matrix book with four matrix sheets (CA, CH, CV, and CD) is generated. CA, CH, CV, and CD contain approximation coefficients, horizontal detail coefficients, vertical detail coefficients, and diagonal detail coefficients respectively. You can change the view mode to image mode by choosing **View: Image Mode** from the menu.



6. With the CA matrix sheet active, make an image plot by selecting **Plot: Image Plot** from the menu. Repeat for CH, CV, and CD matrix sheets.
7. Double click on graph of them to open the **Plot Details** dialog, in the left panel, activate **Layer1**, and then go to the **Size/Speed** tab in the right panel, and uncheck **Matrix data, maximum points per dimension**. Click **OK**. select the axes related objects (including axis, label) in the graph and press the DELETE key to delete them.

## 4.4.10 Coherence and Correlation

### 4.4.10.1 Summary

Coherence measures the degree of linear dependency of two signals by testing for similar frequency components. If two signals correspond to each other perfectly at a given frequency, the magnitude of coherence is 1. If they are totally unrelated coherence will be 0.

Correlation is another measure of the relationship between two signals. A correlation coefficient is used to evaluate similarity. If two signals have a high degree of similarity, the magnitude of the computed correlation coefficient is large. If there is little or no linear relationship between two signals, the magnitude of the coefficient is small.

### 4.4.10.2 What You Will Learn

This tutorial will show you how to:

1. Test coherence and find out the frequency where two signals are in the highest degree of linear dependency.
2. Perform correlation and find the lag to translate a dataset.

### 4.4.10.3 Coherence

1. Start with a new workbook.
2. Select the menu item **File: Import: Single ASCII...** to import the data **<Origin Installation Directory>\Samples\Signal Processing\Coherence.dat**.

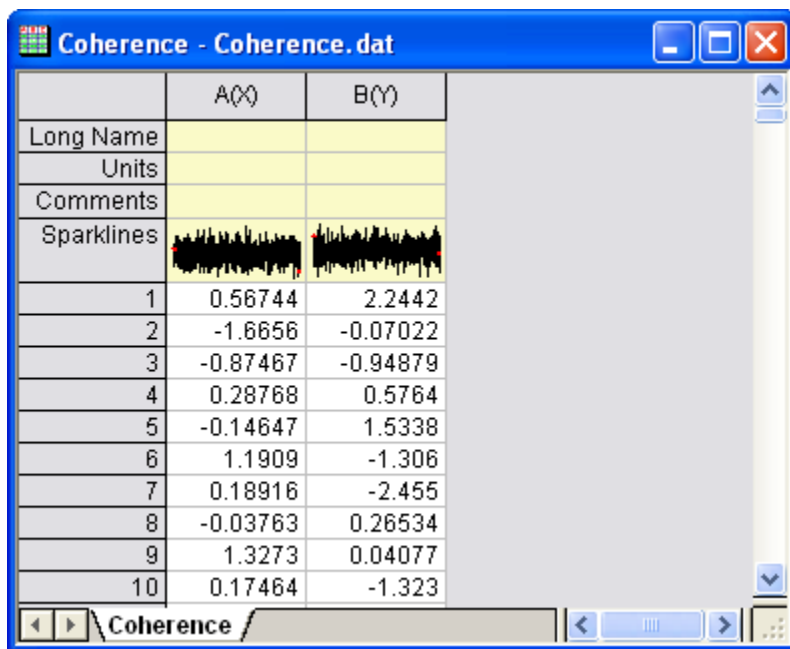

3. Select column A, then right-click and select **Set As: Y** from the shortcut menu. This sets the plot designation for column A to Y.
4. Highlight the two columns and from the menu select **Analysis: Signal Processing: Coherence....** This opens the **Coherence: cohere** dialog box.
5. Change the **Window Type** to *Welch*, and click **OK**.

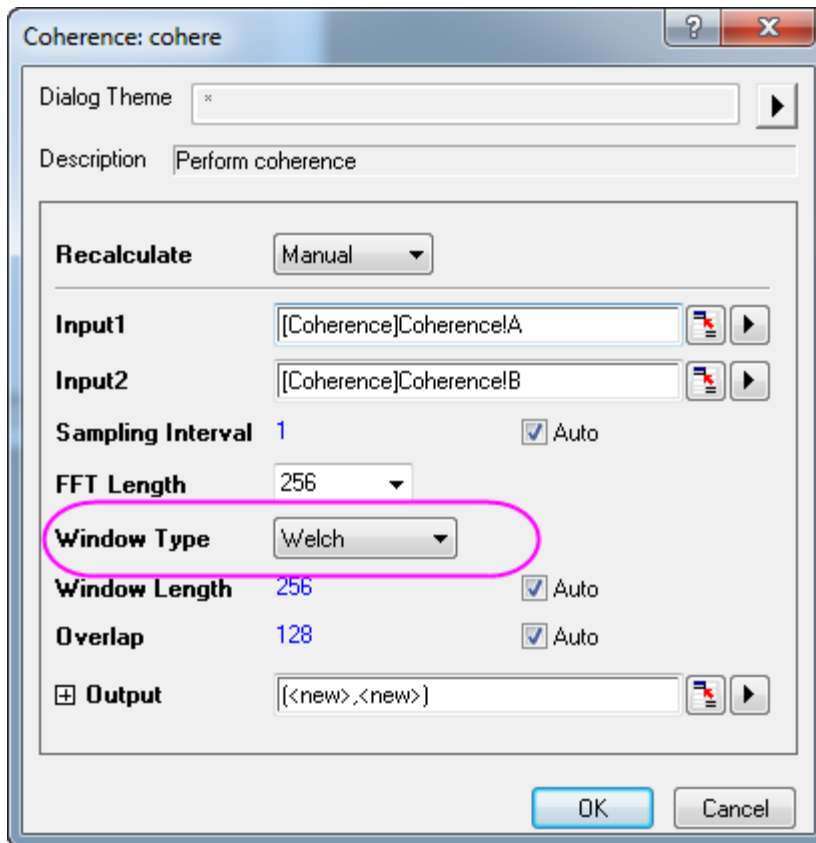

6. Two columns of data are added to the worksheet. Highlight these two new columns and from the menu select **Plot: Line: Line** to plot coherence against frequency.

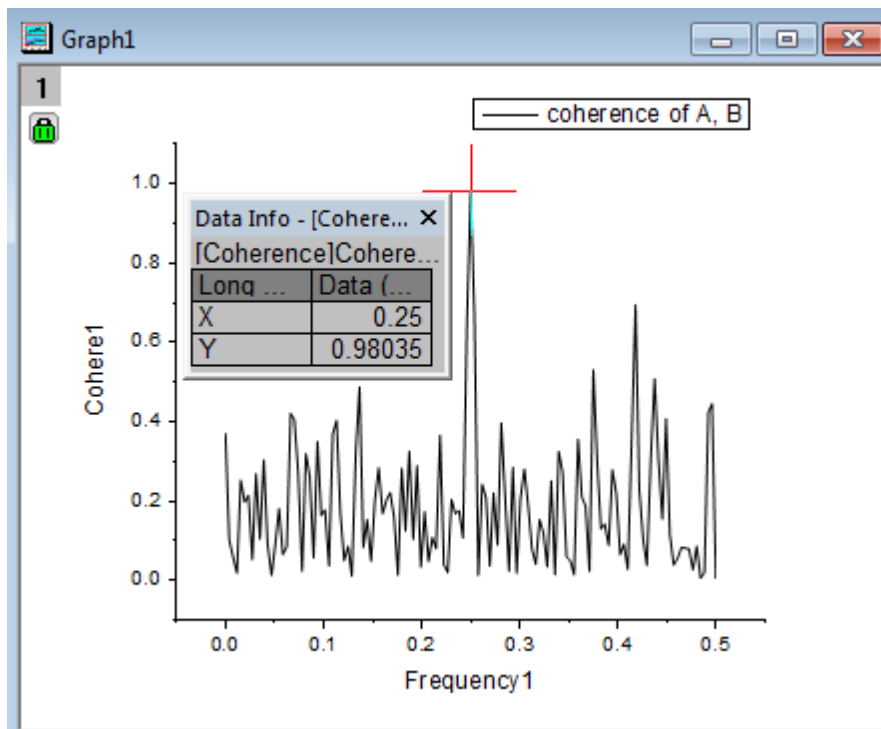

7. Select the **Data Reader** on the **Tools** toolbar to read the strongest peak in the graph. The image above shows that at a frequency of 0.25 there is a strong peak, indicating a strong correspondence between the two signals at this frequency.

#### 4.4.10.4 1D Correlation

1. Start with a new workbook.
2. Select menu **File: Import: Single ASCII...** and import the file **<Origin Installation Directory>\Samples\Signal Processing\Correlation.dat**.

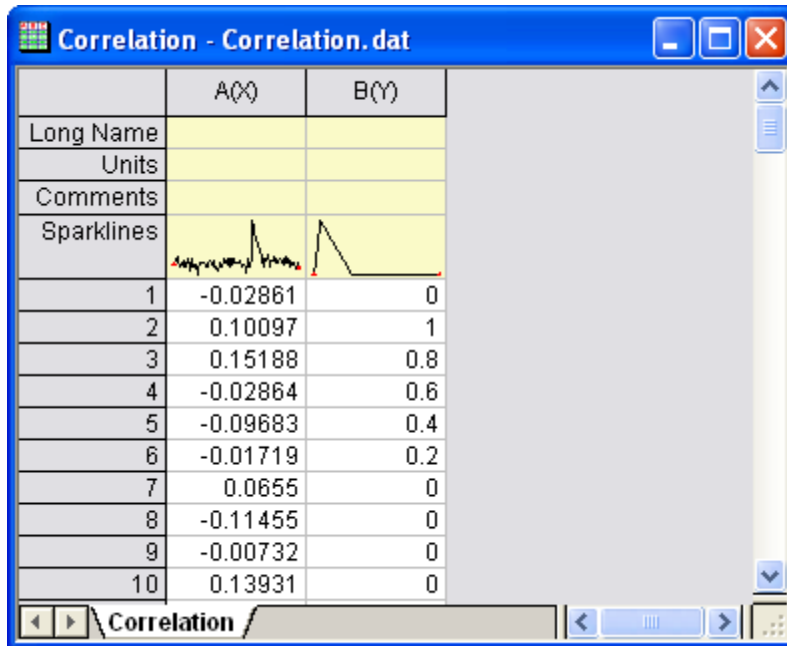

3. Select column A. Right click on it to open the shortcut menu, then choose item **Set As: Y** to set this column's plot designation to Y.
4. Highlight the two columns and from the menu select **Analysis: Signal Processing: Correlation...**. This opens the **Correlation:corr1** dialog box. Accept the default settings.



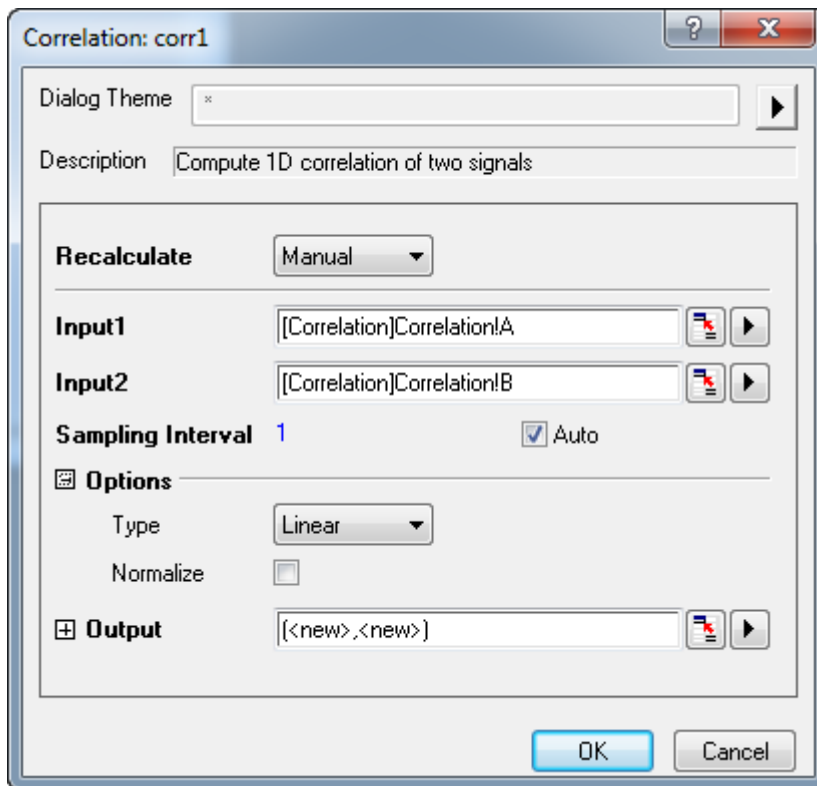

5. Click **OK** to perform a correlation on the two signals.
6. The correlation result and a time lag column are output to the worksheet. Highlight column D, and from the menu select **Plot: Line: Line** to plot the result.

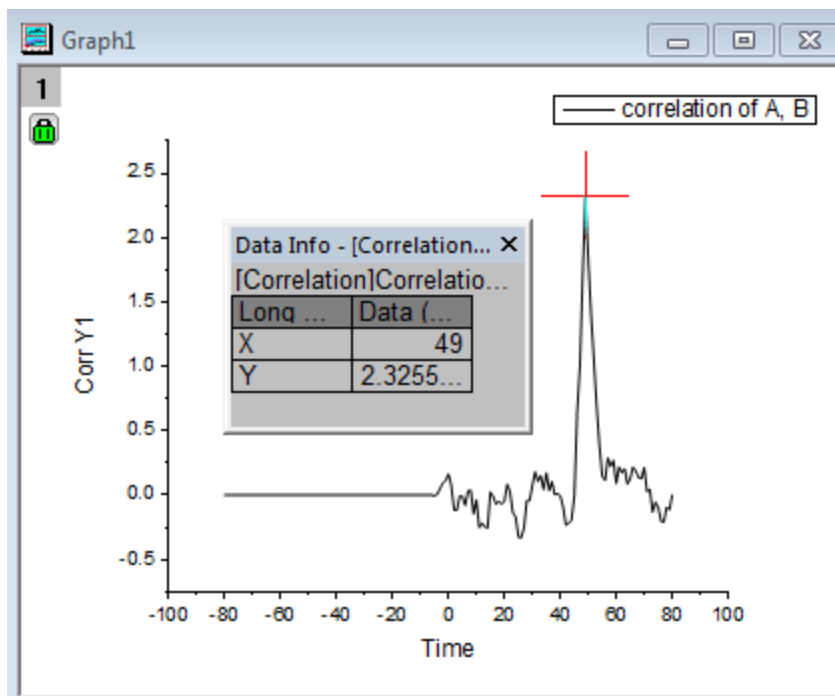

- The Data Reader in the image above shows that at Time = 49, there is a strong positive peak, which means that the second dataset needs to be translated forward 49 units to align these two signals.
- Return to the worksheet, highlight column A and B, then from the menu select **Plot: Multi-Panel: Vertical 2 Panel** to plot the two signals to two separate graph layers.

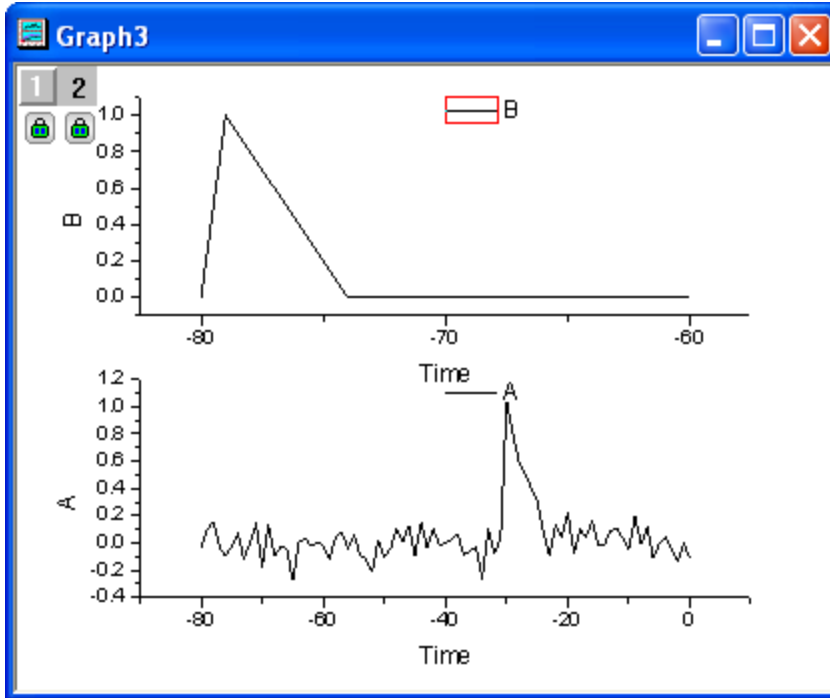

- Double click on the top plot to open the **Plot Details** dialog box. In the left panel, select **Layer 2** (take care not to clear the check box). Go to the **Link Axes Scales** tab in the right panel and click the **Straight (1 to 1)** radio button in the **X Axis Link** group.

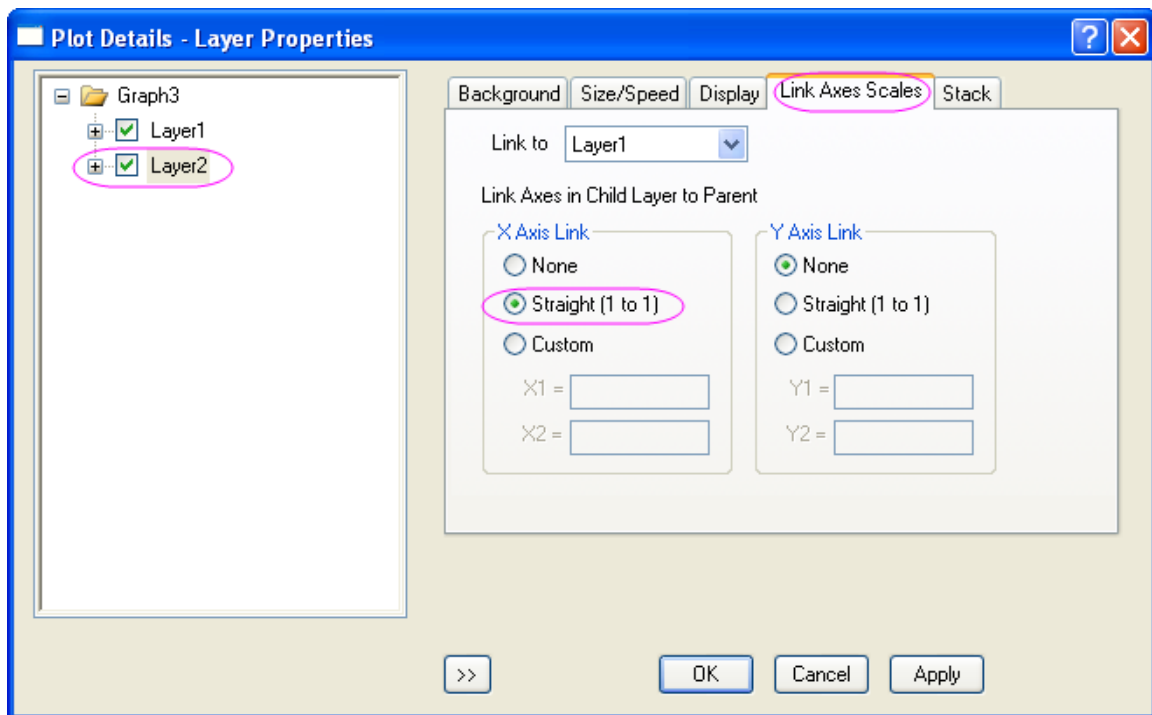

10. Click **OK** and both X axes now have the same scale.

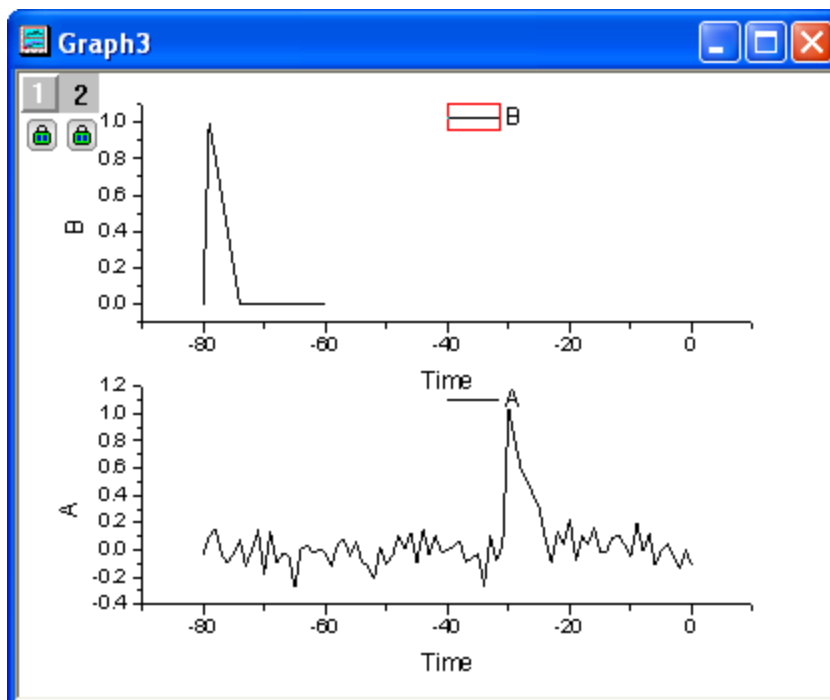

11. To make the datasets movable, delete the lock by clicking on it and choosing **Recalculate Mode: None**. Click **OK** if the **Reminder Message** dialog pops up.

- Select the top plot, then select menu **Analysis: Data Manipulation: Horizontal Translate** to add a vertical line to the layer, together with a triangle button. Click on the triangle button to open a menu and uncheck **Keep Tool after Translation**. Open the menu again, select **Translate Duplication in: New Columns** from the menu. Another two columns will be added and the source data of current curve will be copied to these two new columns.

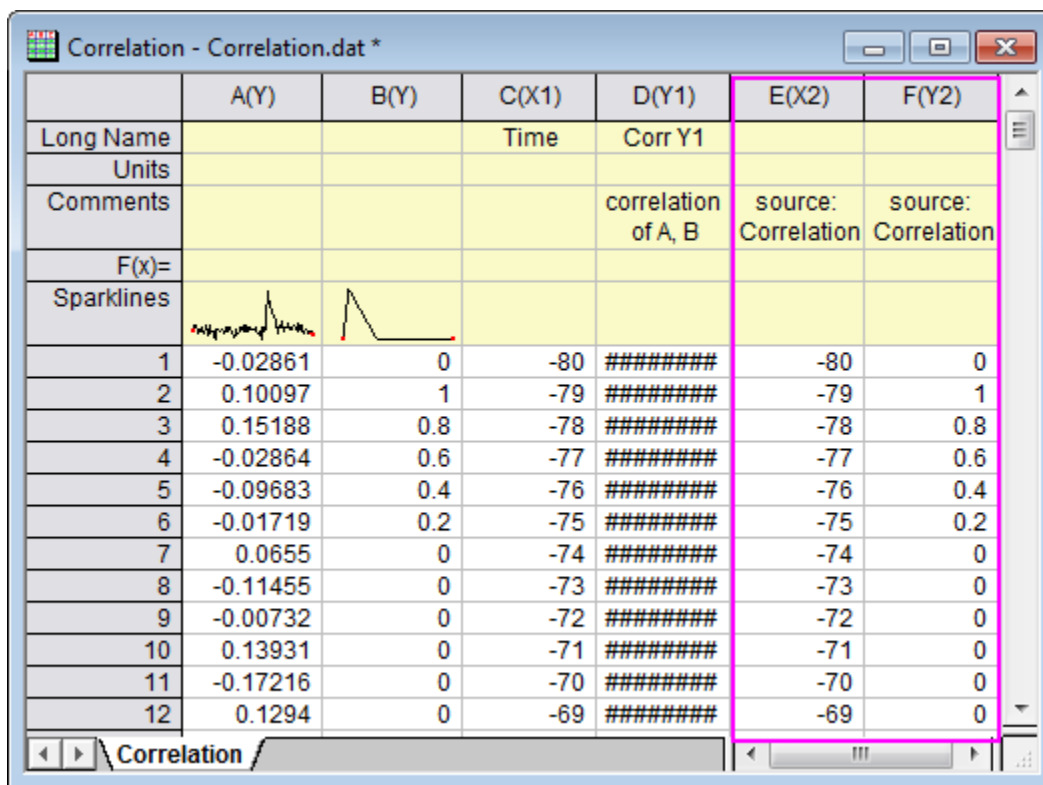

- Again, open the menu and click **Shift Curve...** to bring up the **Shift Curve** dialog box. Set **Value** to 49.

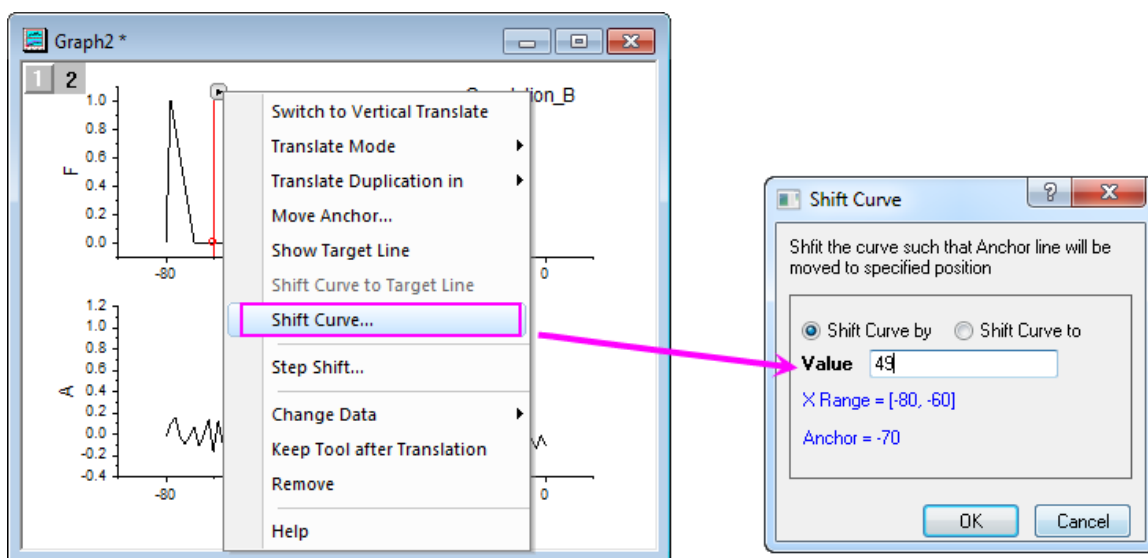

14. Click **OK** to translate the plot. This should align the two signals.

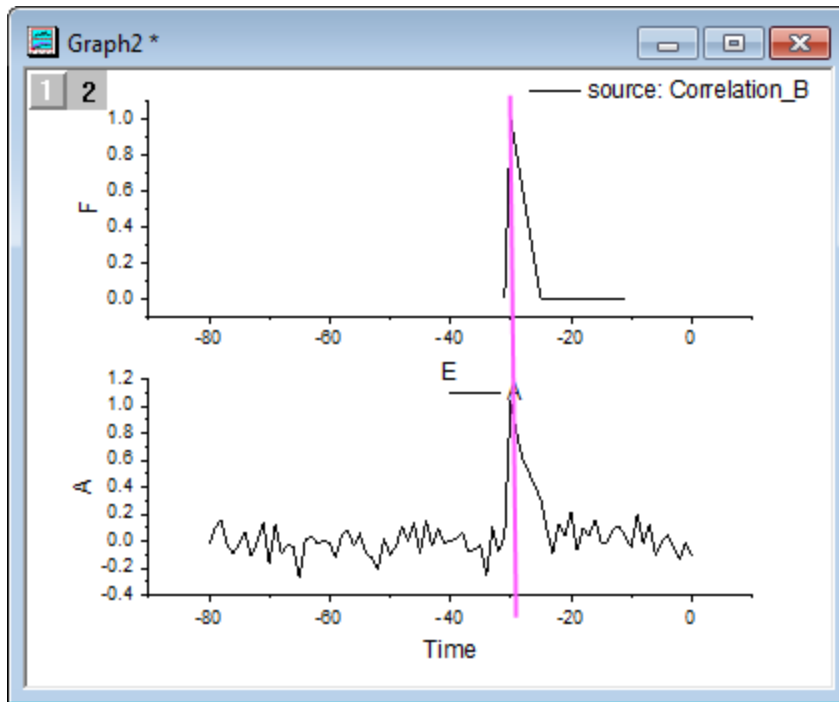

#### 4.4.11 Decimation and Signal Envelope

##### 4.4.11.1 Summary

Decimation is used to reduce the size of the signal sequence by merging every N samples into one.

Envelope detection adds an envelope curve to the input signal. Origin's signal envelope tool computes an envelope and plots an upper envelope, a lower envelope, or both.

##### 4.4.11.2 What You Will Learn

This tutorial will show you how to:

1. Decimate a signal to reduce the size of the input signal sequence.
2. Perform envelope detection to add the envelope curve.

##### 4.4.11.3 Decimation

In this tutorial, we are going to perform decimation on sunspot count data. Measurements of sunspot number were collected every month for more than 200 years. We will use decimation to reduce our dataset to one sunspot count for each year.

1. Start with a new workbook, and import the data **<Origin Installation Directory>\Samples\Signal Processing\Sunspot.dat**.

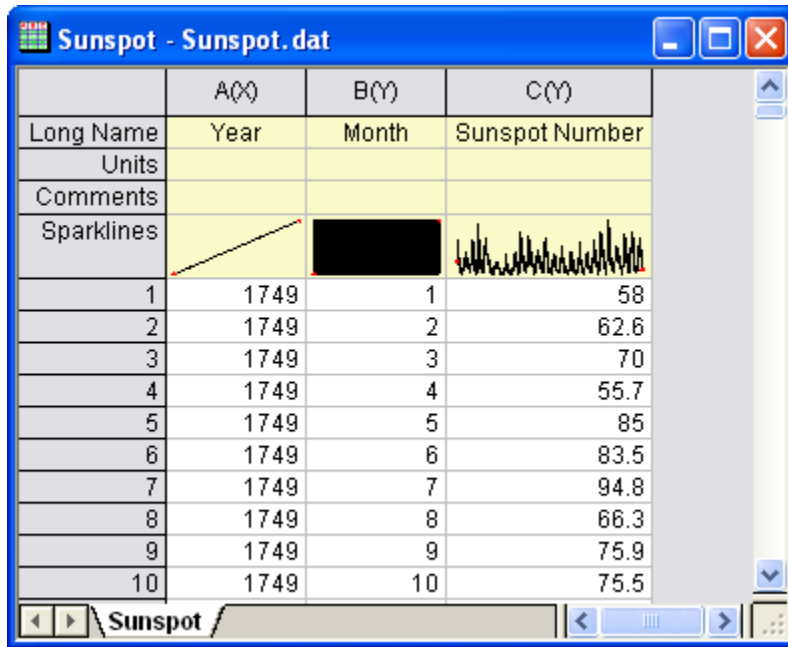

2. Select column A. Right click on the column and choose **Set As: Y** to set this column's plot designation to Y. This will ensure that sunspot number is not associated with column A as X. That is because decimation needs the X column data to be strictly monotonic.
3. Select column C and from the menu choose **Analysis: Signal Processing: Decimation....** This opens the **Decimation: decimate** dialog box.
4. In the dialog, set **Resample Factor** to **12**. Set the **Filter Type** to **Moving Average Filter**. To preview the result in the right panel, check the **Auto Preview** check box.

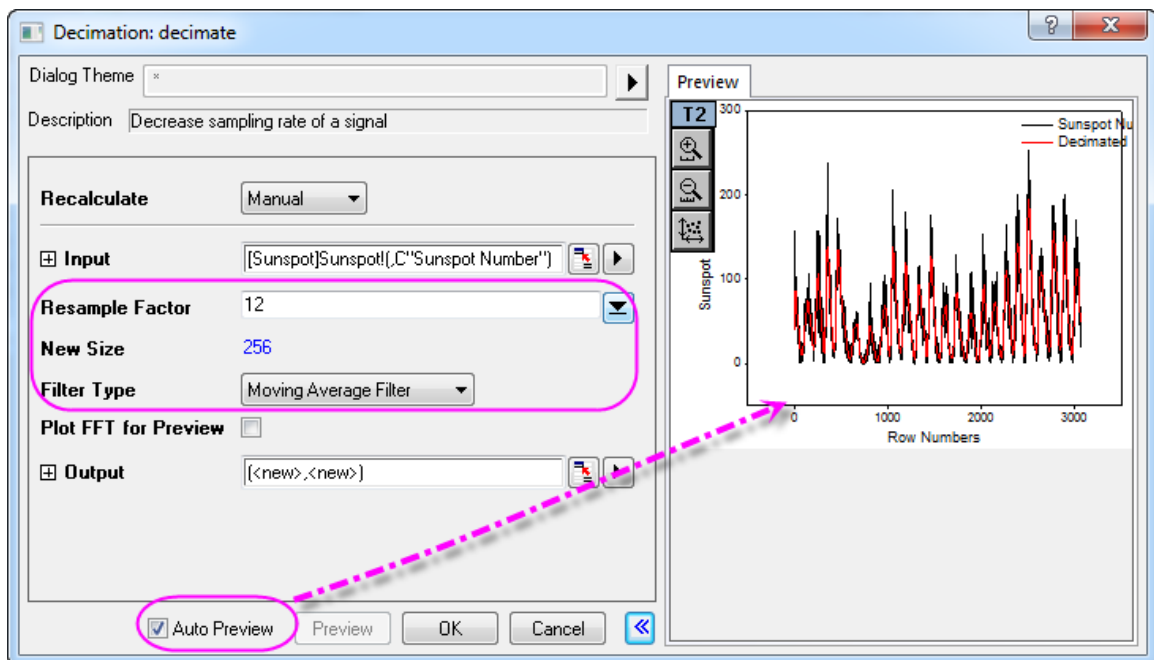

5. Click **OK** to output results.
6. In the worksheet, select column D (the X column generated from the result), then right-click and choose **Insert** from the shortcut menu to insert a new column. Right click again and choose **Set As: Y** to change the column's plot designation as Y.
7. Highlight the newly inserted column and right click on it and choose **Set As: X** from the context menu to change this column's plot designation to X. Right-click on the column again and choose **Set Column Values...** to bring up the **Set Values** dialog box and enter `data(1749, 1749 + 255)` into the text box and and click **OK**.

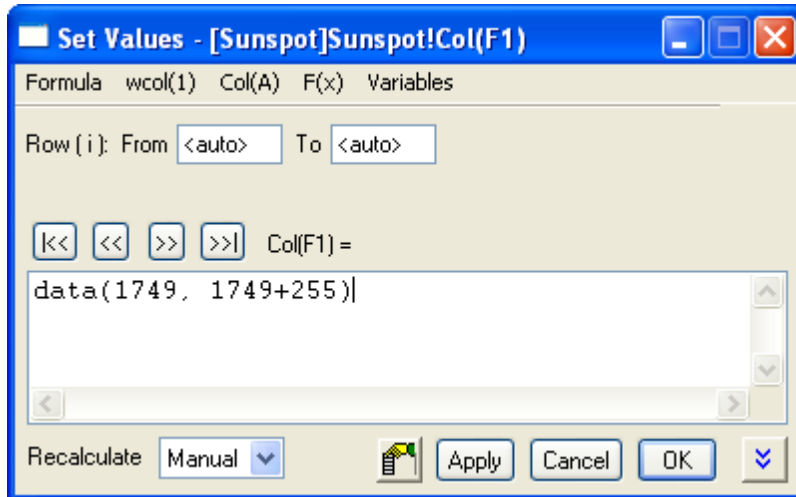

8. Select column A, then right-click to choose **Set As: X** from the shortcut menu, to set the column's plot designation back to X. The final worksheet will look similar to the one below.

**Sunspot - Sunspot.dat**

	A(X1)	B(Y1)	C(Y1)	F1(X2)	D(Y2)	E(Y2)
Long Name	Year	Month	Sunspot Number		Decimated	Decimated
Units						
Comments						MA decimation of "Sunspot Number"
Sparklines						
1	1749	1	58	1749	1	39.80828
2	1749	2	62.6	1750	13	86.53432
3	1749	3	70	1751	25	65.58876
4	1749	4	55.7	1752	37	46.8645
5	1749	5	85	1753	49	39.20533
6	1749	6	83.5	1754	61	17.91893
7	1749	7	94.8	1755	73	10.72722
8	1749	8	66.3	1756	85	10.39822
9	1749	9	75.9	1757	97	20.27811
10	1749	10	75.5	1758	109	43.33136
11	1749	11	158.6	1759	121	49.33373
12	1749	12	85.2	1760	133	60.62604

- Press CTRL and select columns C and E. From the menu, choose **Plot: Multi-Panel: Vertical 2 Panel** to make a graph. Note that the decimated line looks smoother as the image below shows.

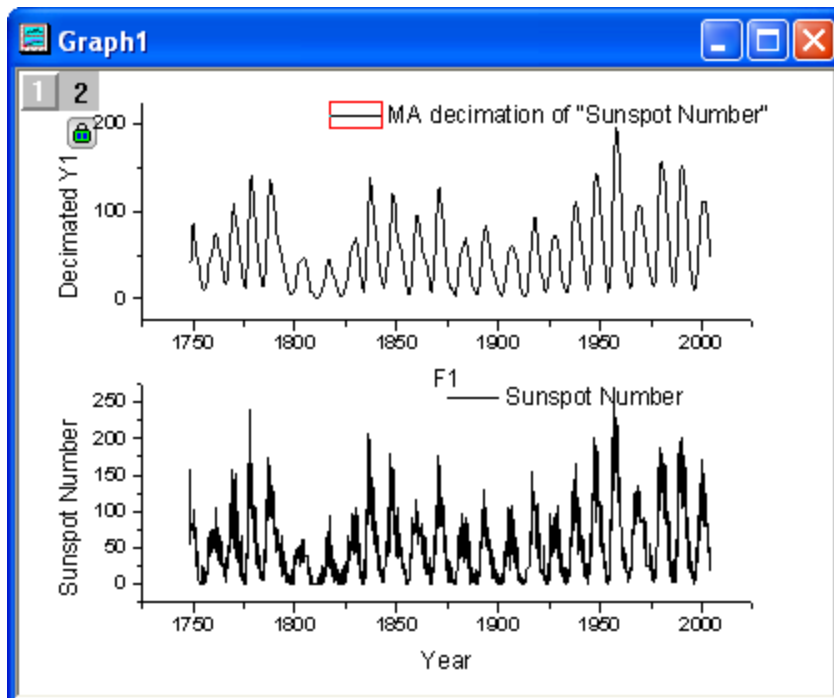

#### 4.4.11.4 Signal Envelope



1. Start with a new workbook.
2. Select menu item **Data: Import from File: Single ASCII...** to import the data <Origin Installation Directory>\Samples\Signal Processing\Gaussian Envelope.dat.

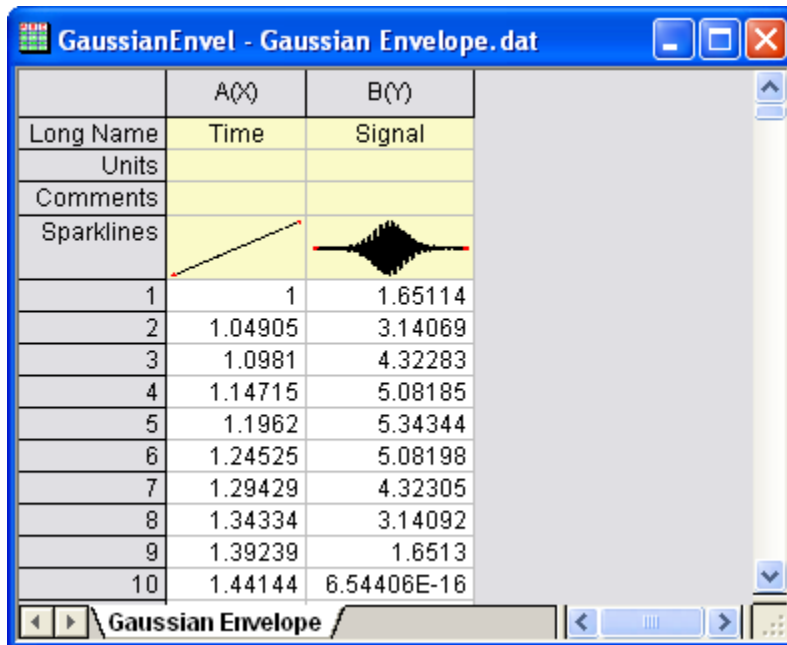

3. Highlight column B and from the menu choose **Plot: Line: Line** to create a line plot.

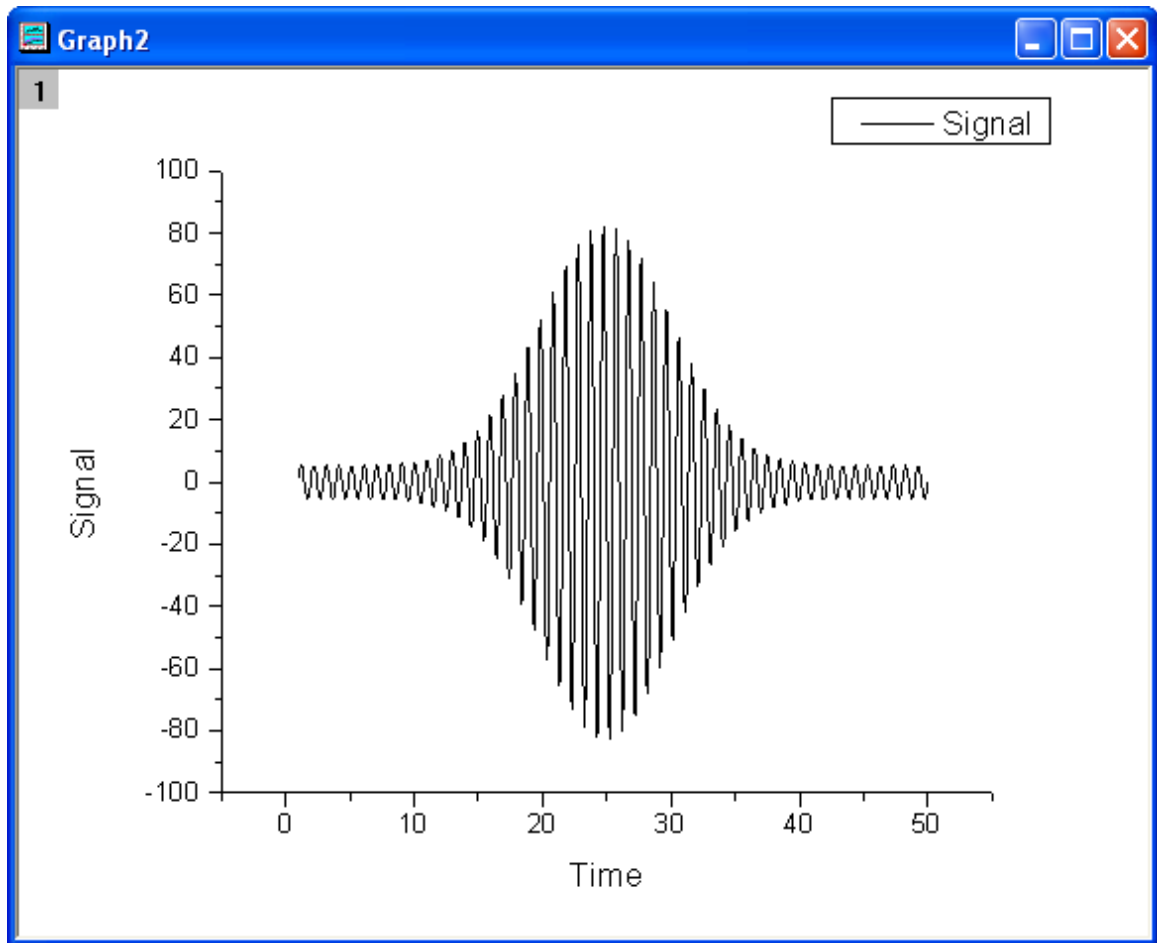

4. With this graph active select **Analysis: Signal Processing: Envelope...** from the menu. This opens the **Envelope: envelope** dialog box.
5. In the dialog box, set **Envelope Type** to **Both Envelopes**, and **Smooth Points** to **10**. Check the **Auto Preview** box to preview the result in the right panel.

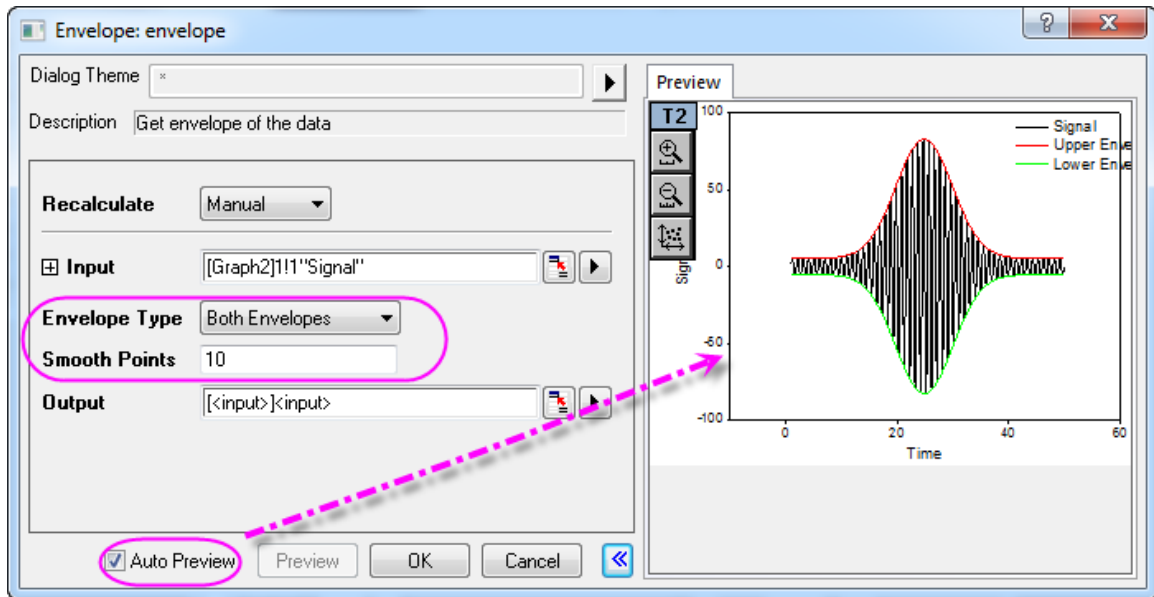

- Click **OK** to create the graph showing upper and lower envelope curves.

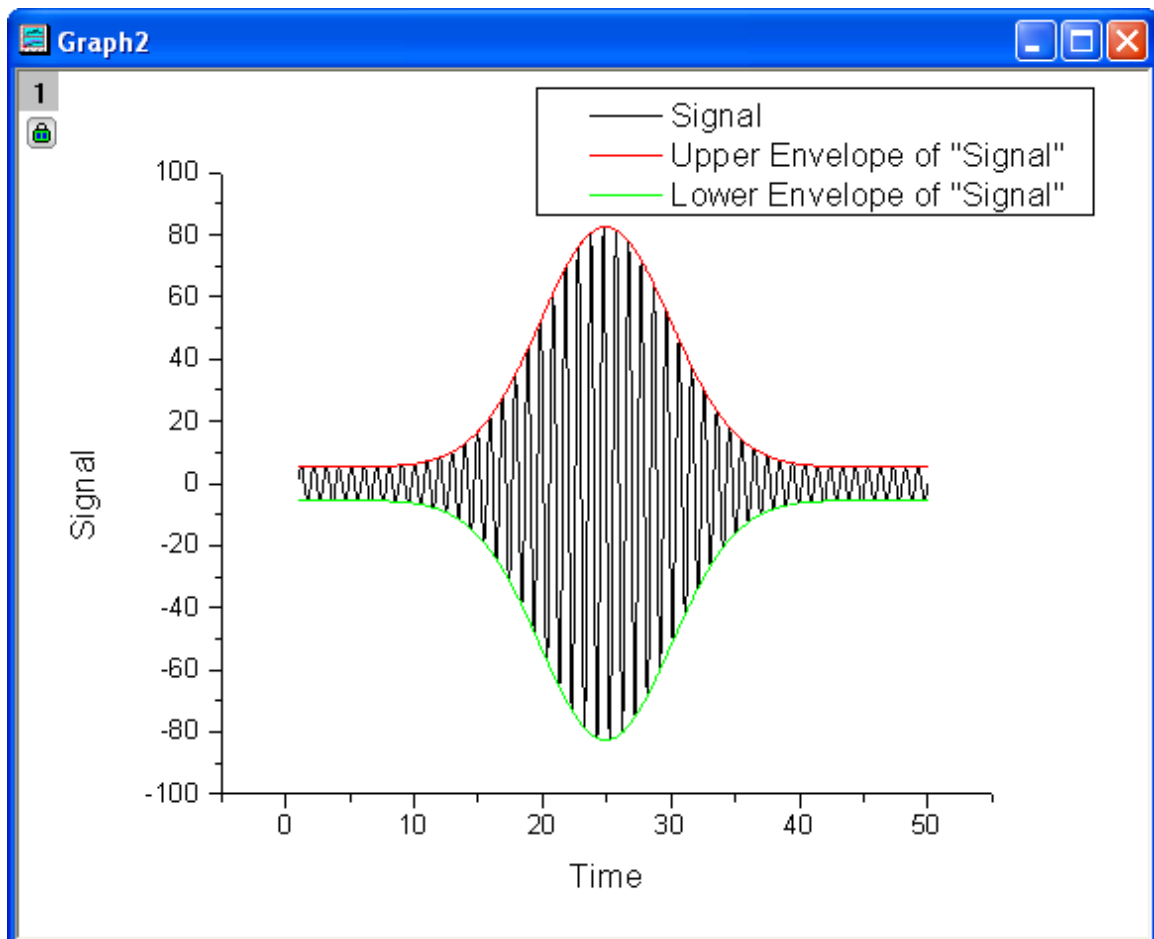

#### 4.4.12 Rise Time

4.4.12.1 Summary

In a step-like signal, rise time refers to the time required to change from a specified low value to a specified high value (or from a specified high value to a specified low value in the case of fall time). Origin's rise time tool allows you to graphically select a rectangular area tracing a rising or falling step in the signal, and from it calculate the rise time or fall time for this selected step.

4.4.12.2 What You Will Learn

With this tutorial, you will learn how to:

1. Use the Rise Time gadget tool to calculate the fall time.
2. Change the settings for fall time calculation.
3. Set the display elements on the graph.
4. Select the desired output options and output the result to worksheet.

4.4.12.3 Steps

1. Start a new workbook.
2. Select menu **Data: Import from File: Single ASCII...** to import the data file **<Origin Installation Directory>\Samples\Signal Processing\Step Signal with Random Noise.dat**.

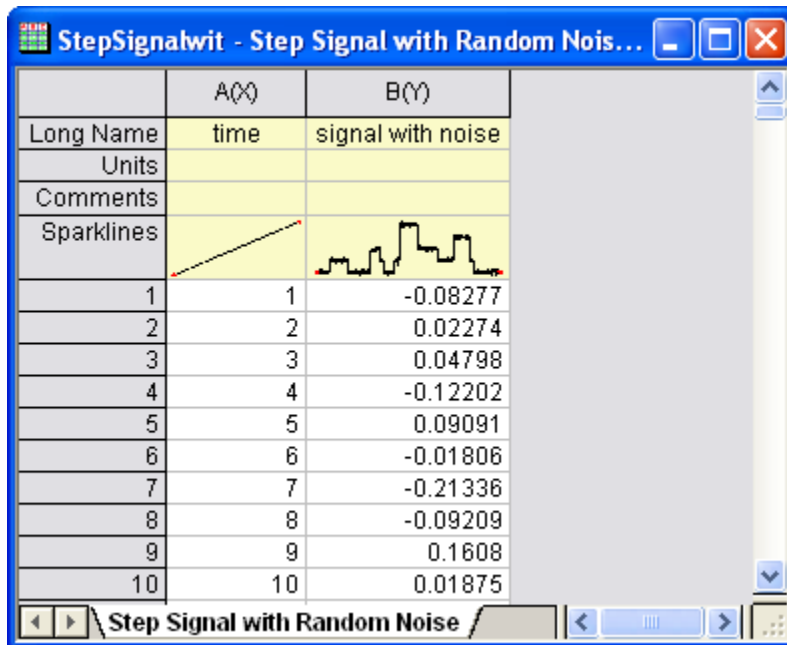

3. Highlight column B and make a line plot of it by selecting **Plot: Line: Line** from the menu.

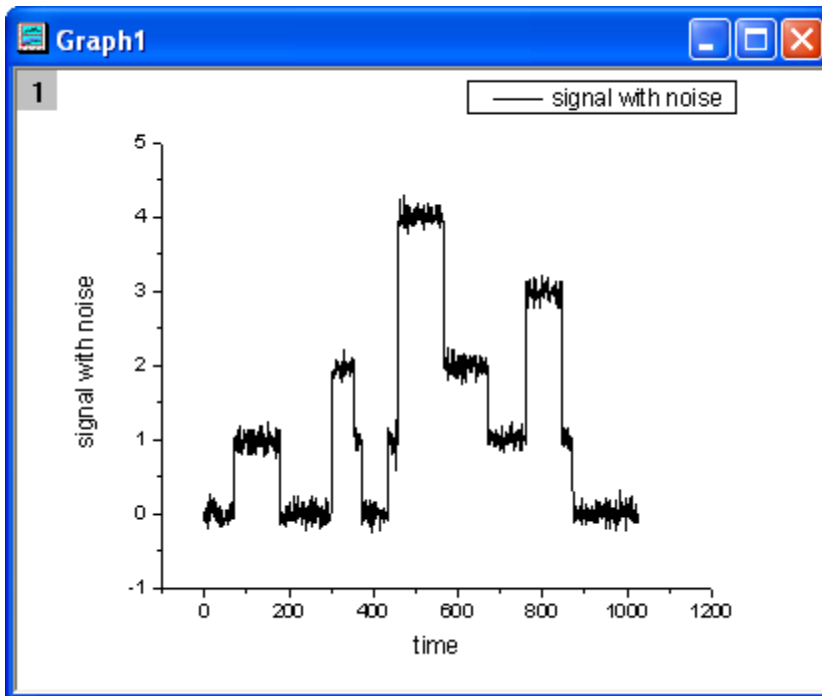

4. Click the **Scale In** () button on the **Tools** toolbar, then select a range along the X axis from about 500 to 700, so that we can focus on this portion of the plot.

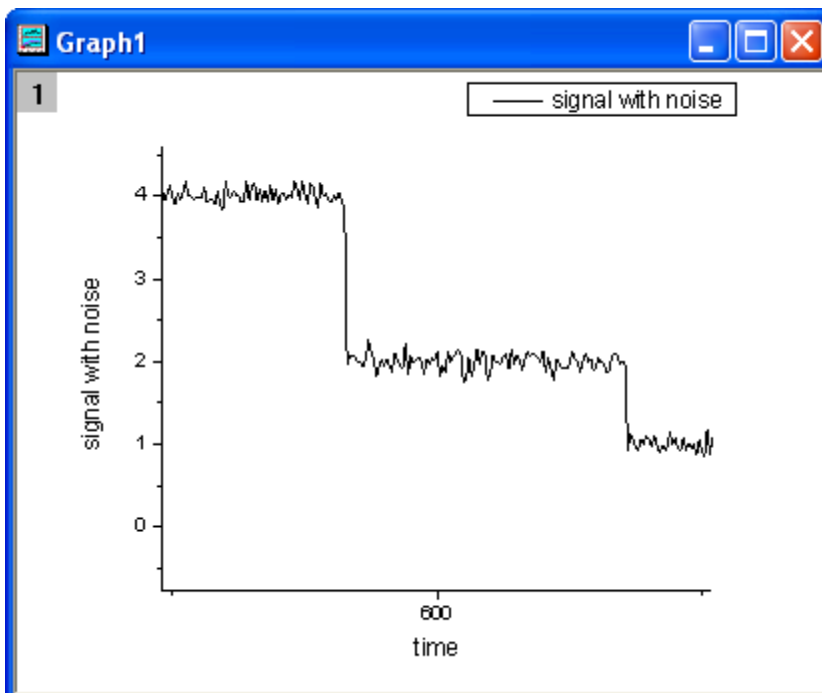

5. With the graph active, choose **Gadgets: Rise Time...** from the menu to launch the tool.

- In the dialog box, click the **ROI Box** tab and set **X Scale From** to **510** and **To** to **650**. Set **Tool** to **Fall Time** and **Method** to **Histogram**.

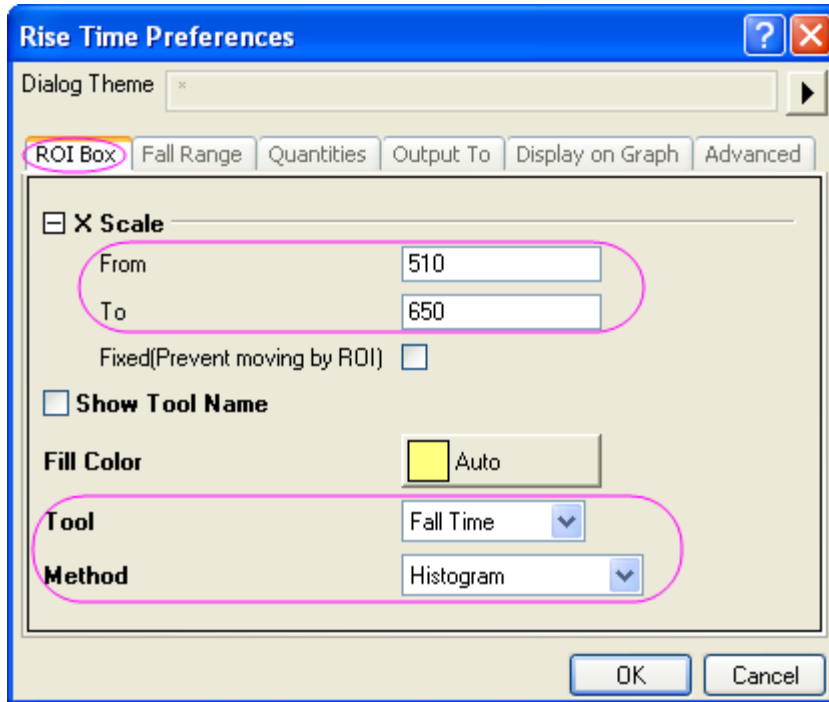

- Click the **Fall Range** tab and change **From (%) of Step Height** to **20** and **To (%) of Step Height** to **80**.

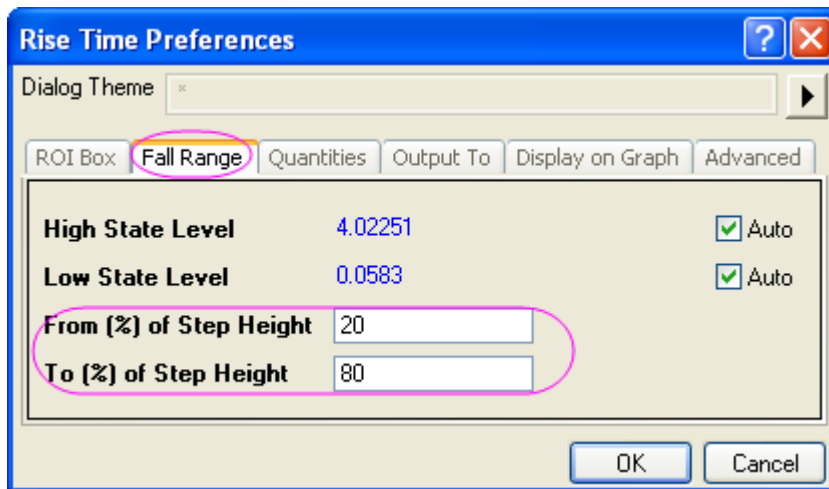

- Click the **Quantities** tab, check only three check boxes: **Dataset Name(name)**, **Fall Range(dVref)** and **Fall Time(dT)**.

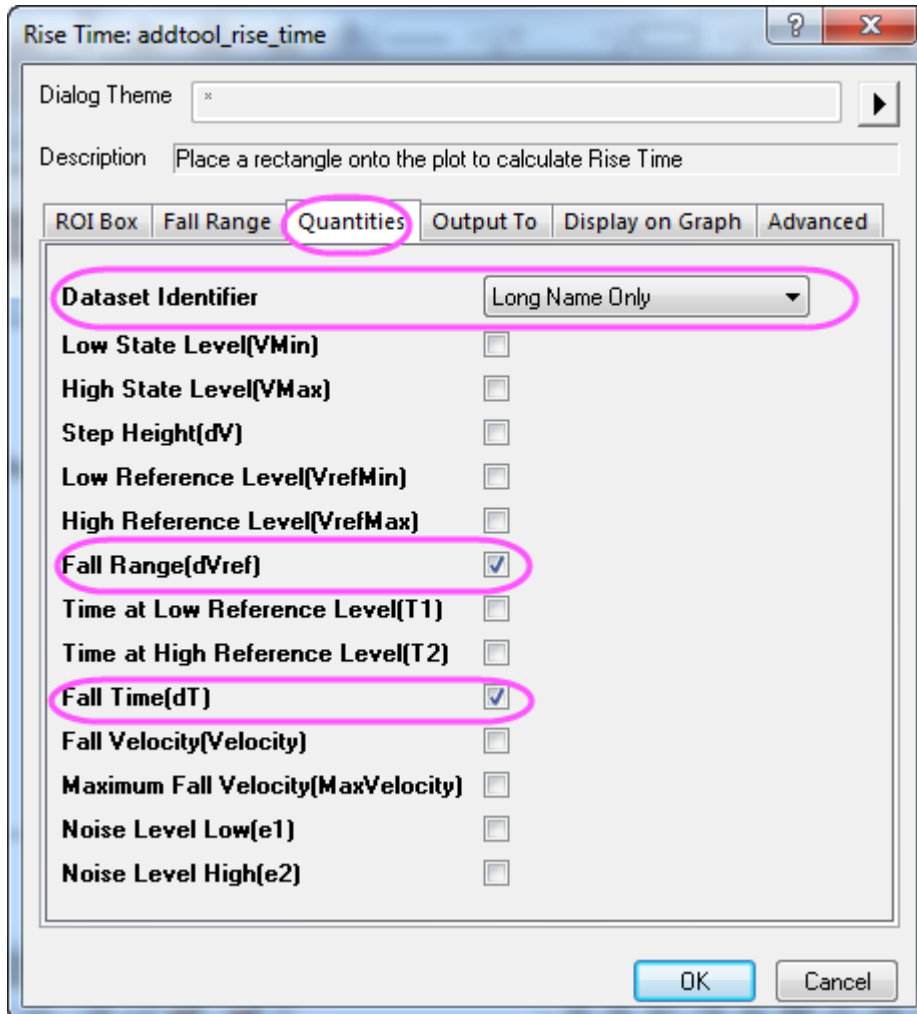

9. Click the **Output To** tab, clear **Script Window** and check **Append to Worksheet**.

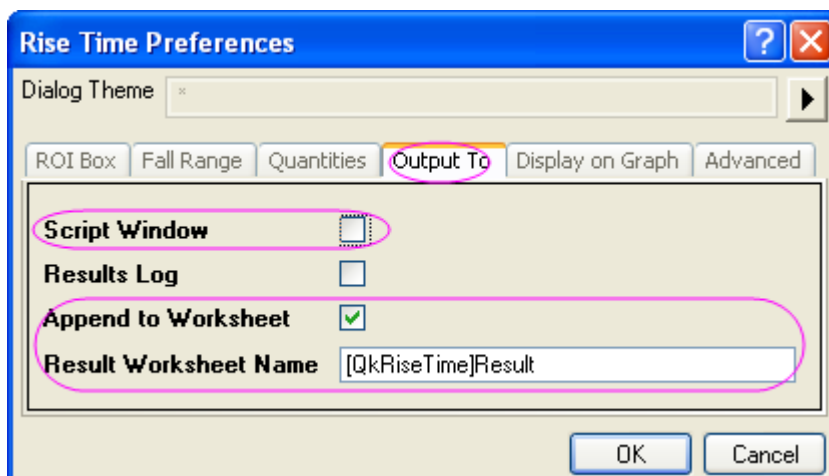

10. Click the **Display on Graph** tab, expand the **Indicator** branch, and change **Edge Color** to **Blue**.  
Check **Fall Range**.

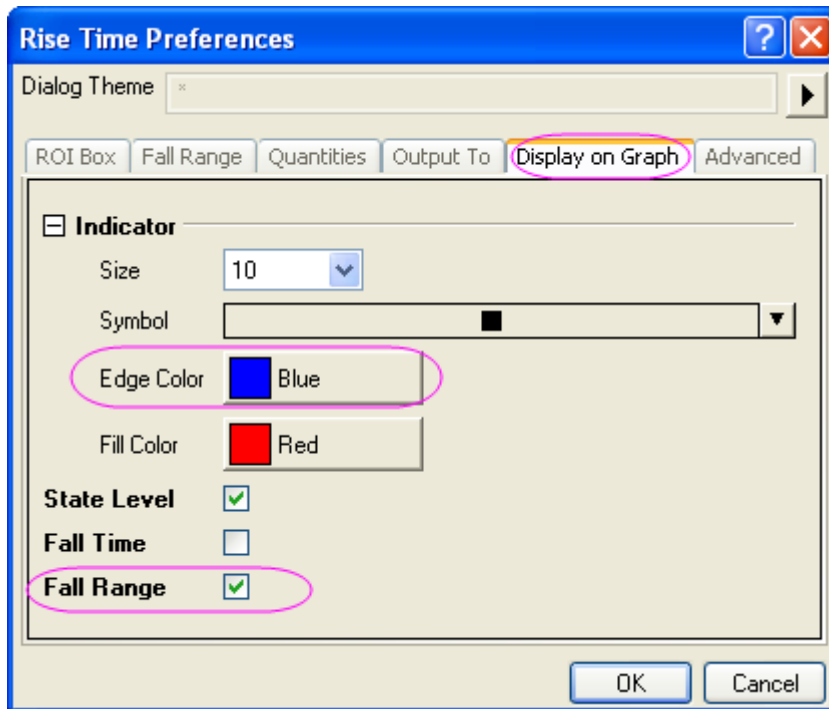

11. Click **OK** to add the rectangular region-of-interest (ROI) to the graph.

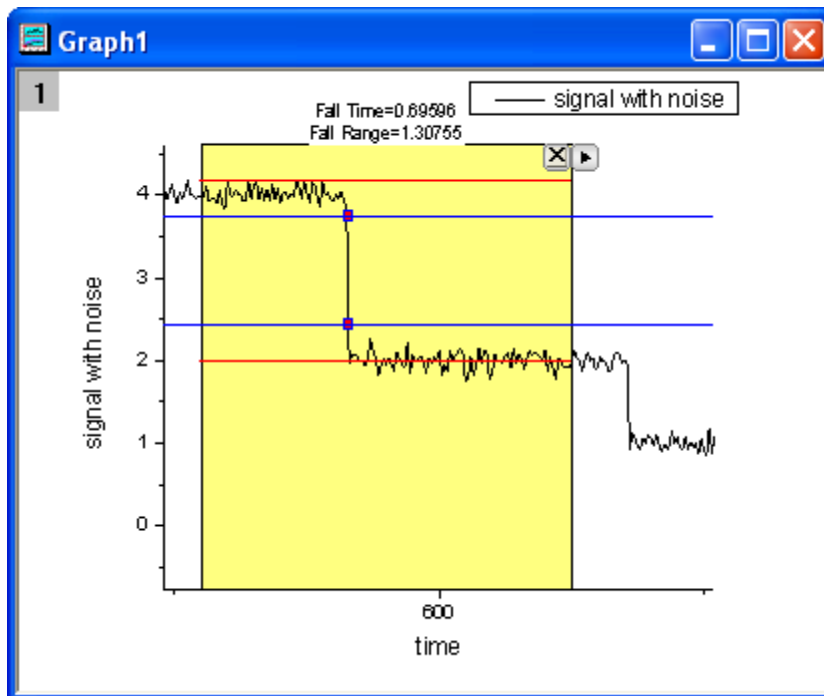

12. As the above image shows, the two red horizontal lines delineate the upper level and lower level. The vertical distance between the two blue lines is the fall range, shown by the two indicator points on the line plot. At the top of the rectangle, the fall time and fall range are reported.



13. Click on the triangle button in the upper-right corner of the ROI to open a menu and select **Fix ROI Position**, so that the yellow ROI rectangle is locked in place.

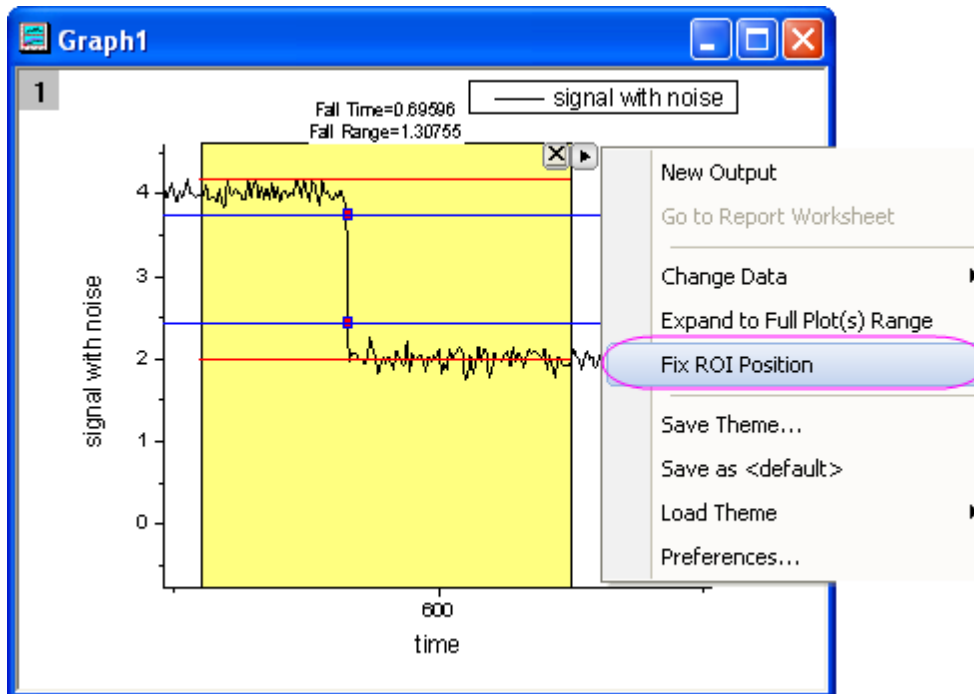

14. Open the menu again and click **New Output** to output the results. Open the menu again and choose **Go to Report Worksheet**.

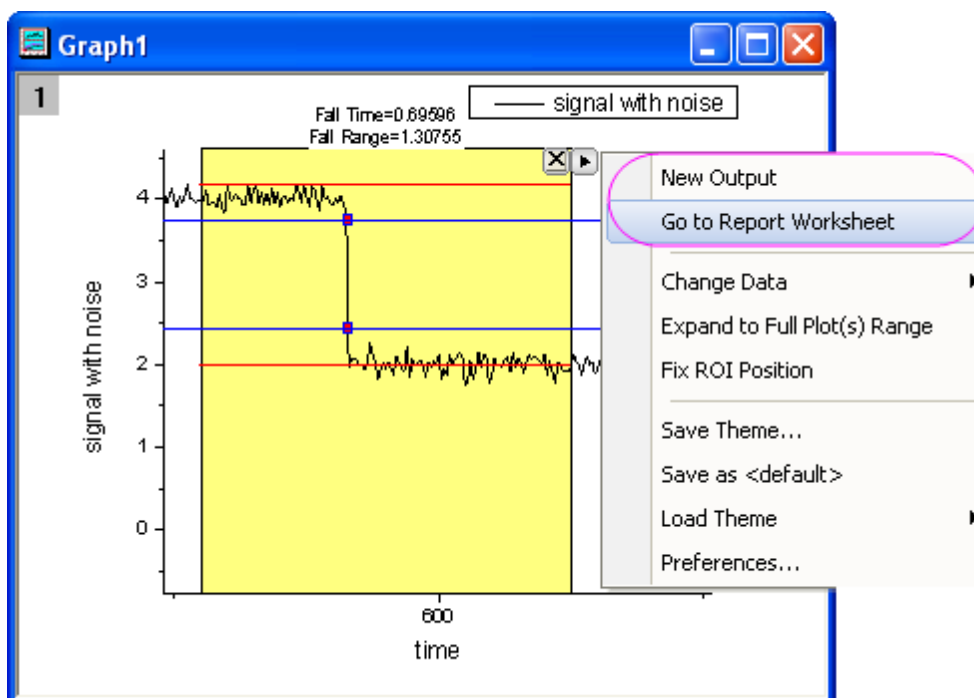

15. The report worksheet is activated and we can see that the three parameters that we chose on the **Quantities** tab are reported.

	A	B	C
Long Name	Dataset Name(name)	Fall Range(dVref)	Fall Time(dT)
Units			
Comments			
1	[StepSignalwit] Step ...	1.30755	0.69596
2			
3			
4			
5			
6			
7			
8			

#### 4.4.13 Sound Processing

##### 4.4.13.1 Summary

Origin features some useful signal processing tools, such as smoothing, FFT filtering, and spectral analysis tools like the Fast Fourier Transform (FFT) . These can be useful for performing sound analysis. This tutorial will remove a specific noise from an audio signal (.WAV file) based on the spectral range of the noise.

Minimum Origin Version Required: Origin 9 SR0

##### 4.4.13.2 What You Will Learn

1. Import a sound file (.WAV) into Origin.
2. How to view sampling interval information.
3. How to use FFT gadget to check the frequency spectra of a signal.
4. Perform FFT filter on the audio signal.
5. Export a filtered signal as a .WAV file.

##### 4.4.13.3 Steps

In this tutorial, we will use "Origin8 Message.wav" and "Dial Tone.wav" which can be found under the subfolder "\\Samples\Signal Processing\" of the Origin installation folder.

Play the sound file "Origin 8 Message.wav" and you will hear a dial tone noise in the background. The 2nd file is a recording of the dial tone.

1. Start Origin, and create a new project with an empty worksheet in a workbook.
2. Select menu **File: Import: Sound (WAV)...** to open the **Sound** dialog. (Hint: if this menu item is not shown, select menu **File: Import: Customize...** to open the **Import Menu Customization** dialog to add it.) Navigate to the "\\Samples\Signal Processing\" folder and double click "Origin 8

Message.wav" and "Dial Tone.wav" to add them to the import list. Make sure **Show Options Dialog** is checked and click **OK**.

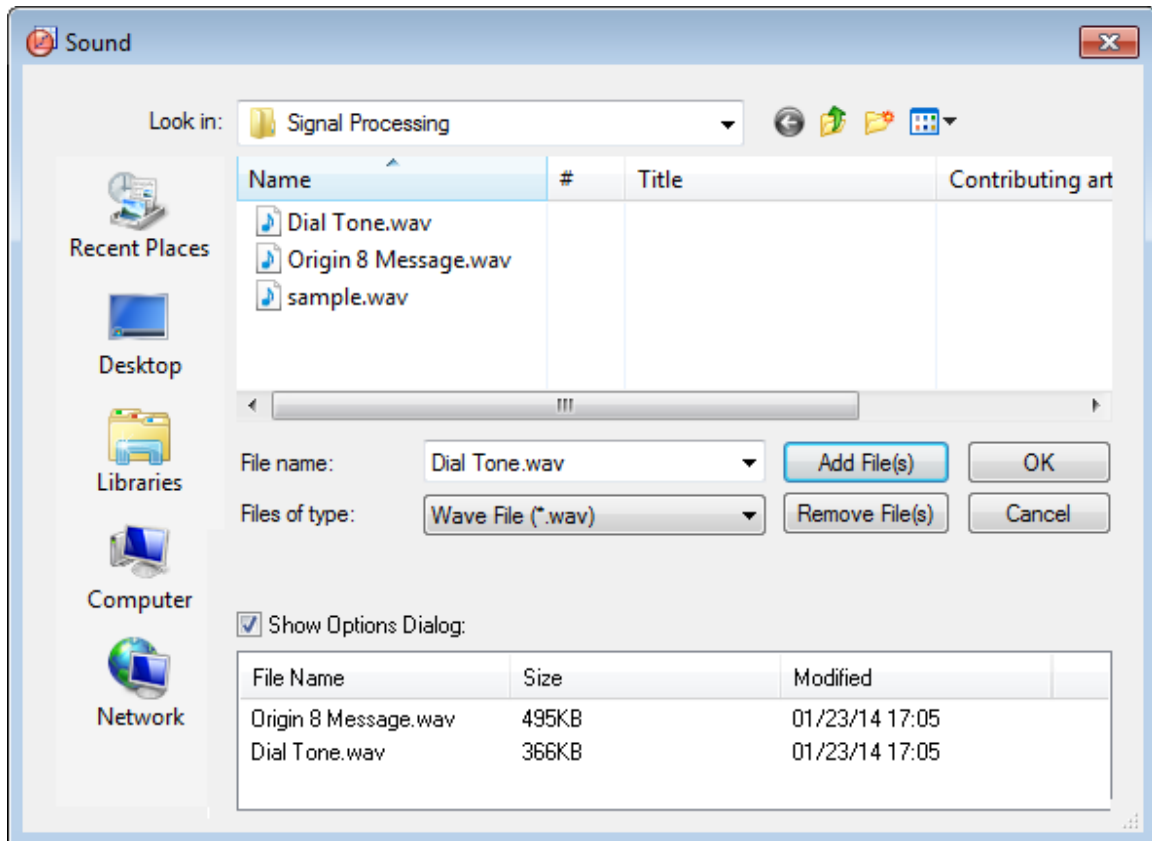

- In the **Import and Export: impWav** dialog, click the triangle button to the right of **Dialog Theme**, and select *System Default* from the context menu. Then expand **Import Options** node, change **Multi-File (except 1st) Import Mode** to *Start New Sheets*.

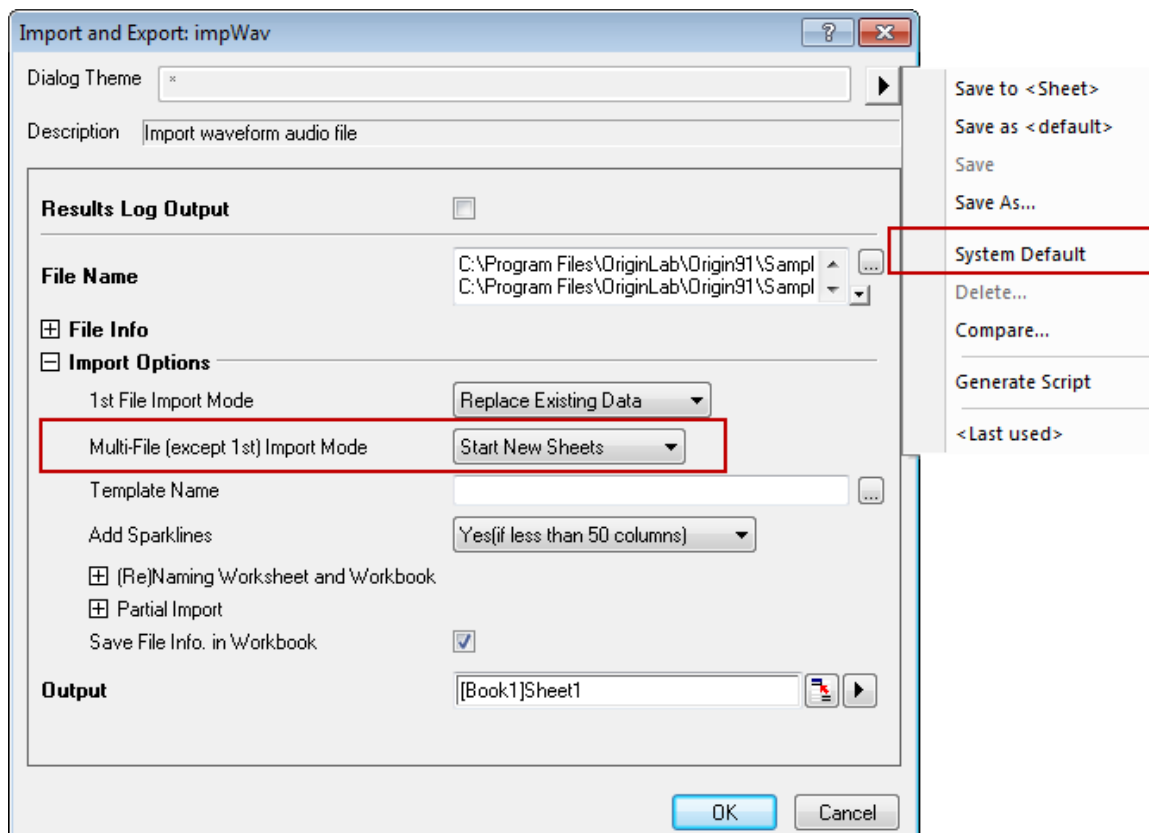

4. Click **OK** to import the two sound files into two

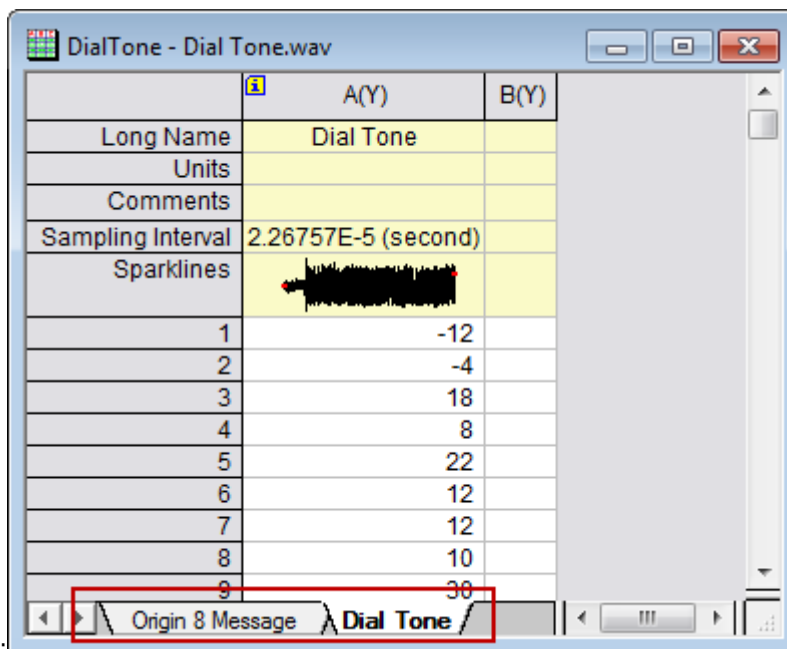

worksheets :

5. In each worksheet, we can see the **Sampling Interval** has the same value of *2.26757E-5 (second)*. Click the *i* icon in the top left corner of the column and the **Column additional information** dialog pops up with the sampling interval information. Click **OK** to close this dialog.

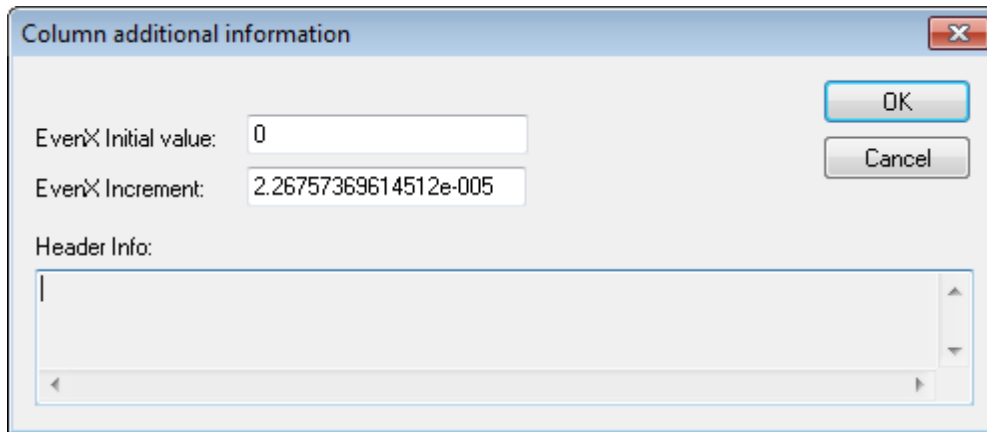

6. With **Dial Tone** worksheet activated, highlight column A, and select menu **Plot: Line: Line** to make a line plot.

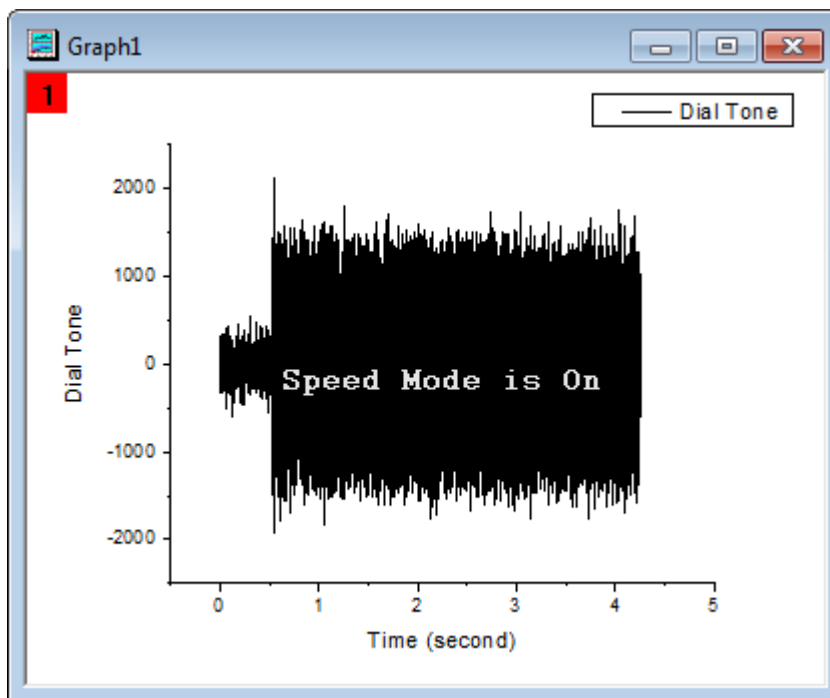

7. Using this graph, select menu **Gadgets: FFT...** to open the **Data Exploration: addtool\_curve\_fft** dialog. Using the default settings, click **OK** button to perform an FFT of the data and create the **FFTPREVIEW** graph with the results.

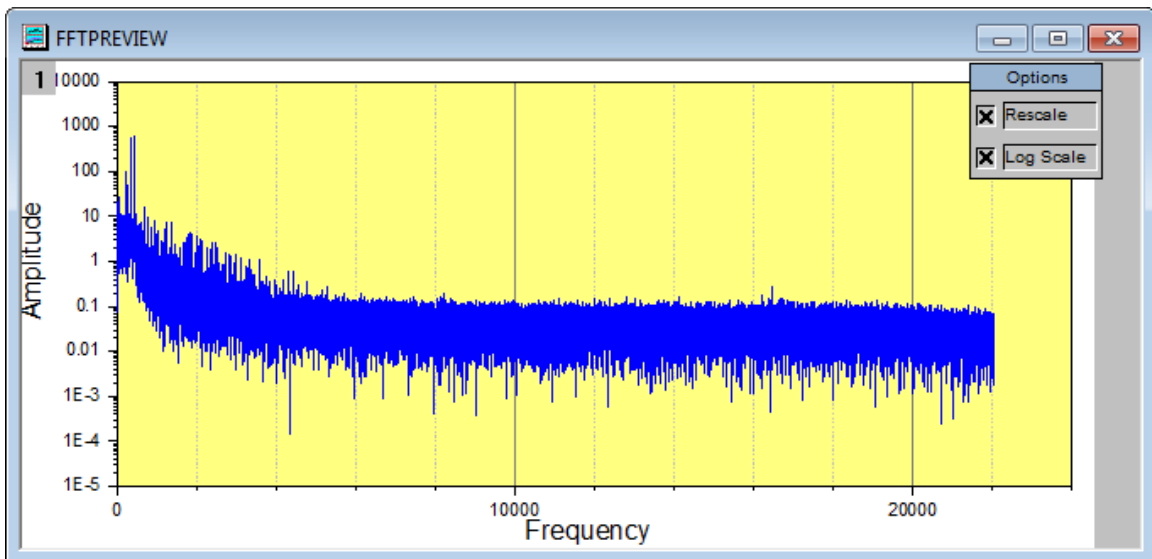
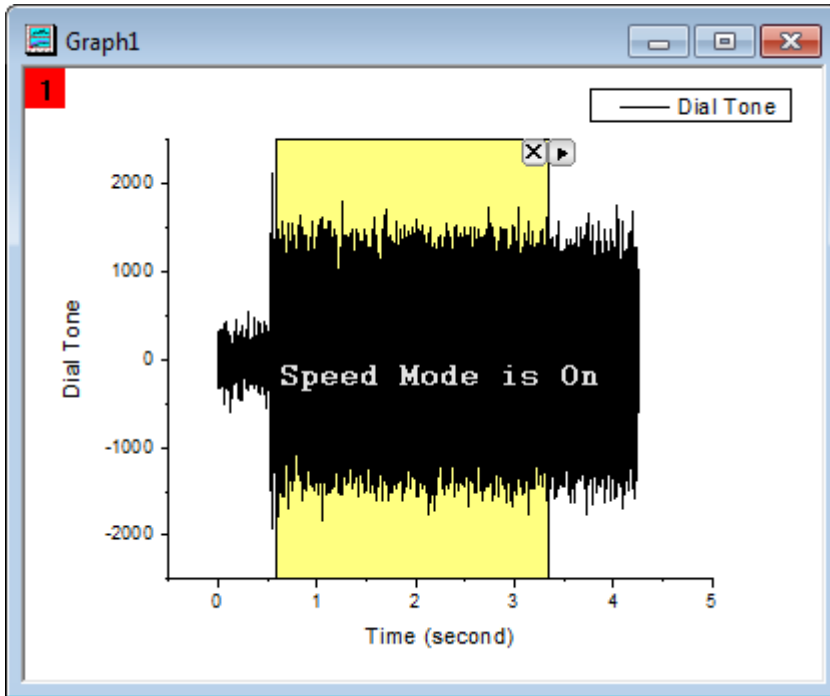

8. Uncheck the **Log Scale** checkbox on the **FFTPREVIEW** graph, and then select menu **Graph: Rescale to Show All** to rescale the graph. We can see that the distribution of frequency is mainly under 2000 Hertz with the largest peaks being under 500 Hertz.

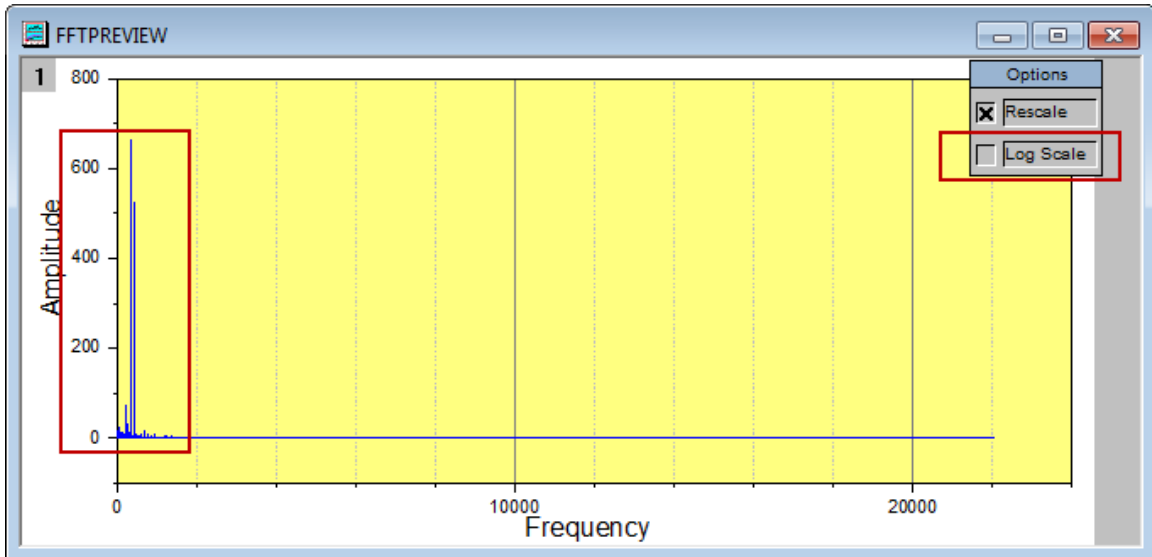

9. Activate the worksheet **Origin 8 Message** and highlight column A. Select menu **Analysis: Signal Processing: FFT Filters** to open the **Signal Processing: fft\_filters** dialog. In the dialog, change **Recalculate** to *None*, select *High Pass* for **Filter Type**, uncheck the **Auto** checkbox for **Cutoff Frequency** and change value to 500. Clear **Keep DC Offset** checkbox. We can auto preview the result by ticking the **Auto Preview** checkbox at the bottom, and the result will be shown in the right panel, which can be shown or hidden by using the button in the bottom right corner of the left panel.

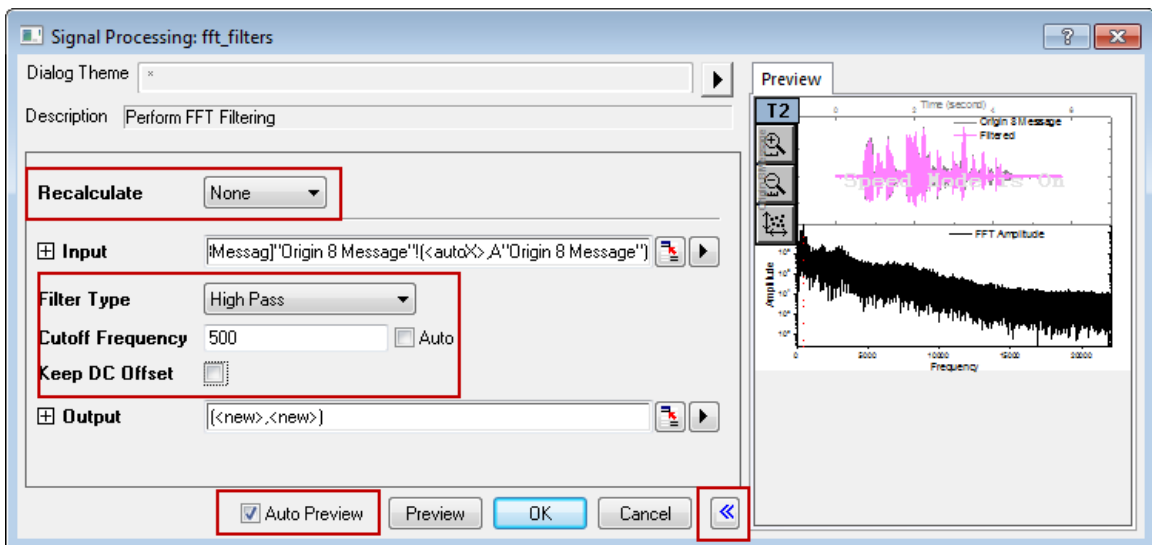

Note: If **Recalculate** is not *None*, the results need to be copied to new columns without the recalculate lock for changing the **Data Type**, see step 11 below.

10. Click **OK** to generate the results. We can see that the filtered result is in floating point format. In order to create a new WAV file, we need to convert this to an integer format.

	A(Y)	B(Y)	C(X1)	D(Y1)
Long Name	Origin 8 Message		Filtered X1	Filtered Y1
Units				
Comments				500 Hz High Pass fft filter of "Origin 8 Message"
Sampling Interval	2.26757E-5 (second)			
Sparklines				
1	126		0	60.05184
2	112		2.26757E-5	41.48331
3	120		4.53515E-5	45.0095
4	112		6.80272E-5	32.64136
5	122		9.07029E-5	38.38947
6	134		1.13379E-4	46.26404
7	130		1.36054E-4	38.27481
8	144		1.5873E-4	48.43108
9	106		1.81406E-4	6.74163

- Highlight column D (the filtered result column), and then choose **Properties...** item from the right-click context menu, to open the **Column Properties** dialog. In this dialog, expand **Options** node, set **Format** to *Numeric*, then change **Data Type** to *Short(2)*. Click **OK** to apply these settings to column D and close this dialog.



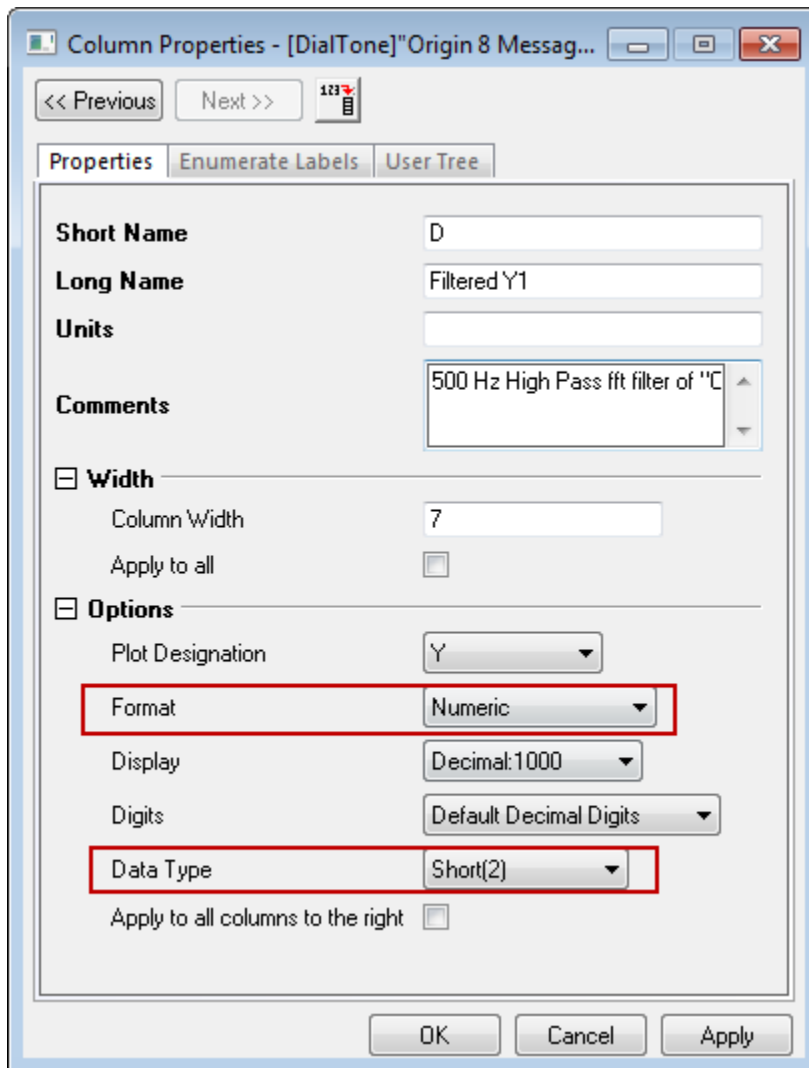

12. Keeping column D highlighted, select menu **File: Export: Sound (WAV)...**. In the open dialog, enter a file name (such as *Origin 8 Message\_filtered.wav*) and save to a familiar location. Make sure the **Show Options Dialog** checkbox is ticked.
13. Click **Save** button and the **Import and Export: expWAV** dialog pops up. Clear the **Auto** checkbox for **Column**, and change it to 4.

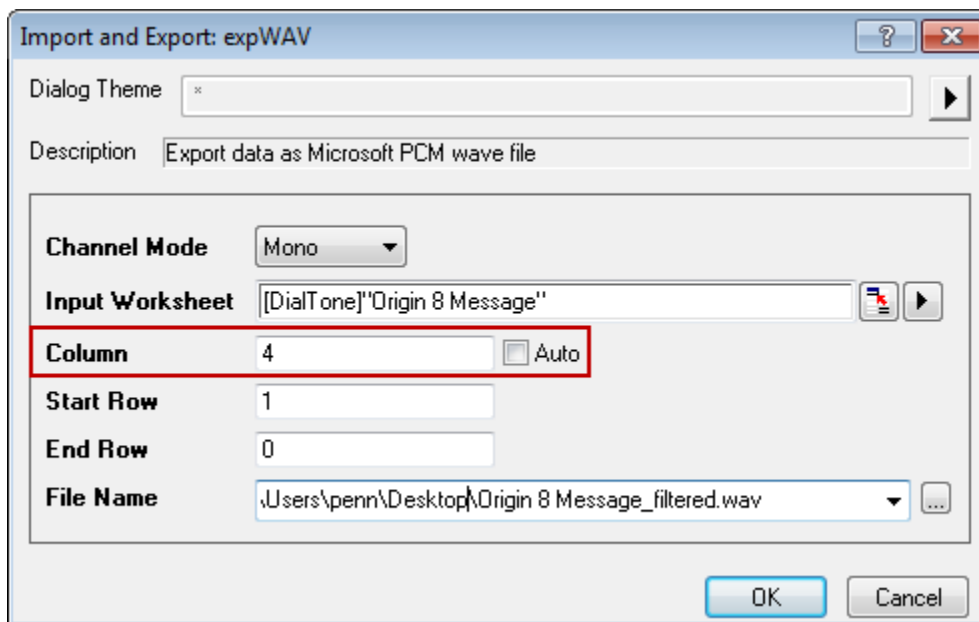

Note: The **Column** is specified for the Y column, and Origin will find its sampling interval if exists or its associated X column. If no X column or the X column is not even spacing, there will be error messages.

14. Click **OK** to export column D as a wave file. Now you can play this wave file and hear that the dial tone has been removed. Note that information with the same spectra as the dial tone is also removed.

## 4.5 Peak Analysis

### 4.5.1 Peak Analysis

- 4.5.1.1 [Create and Subtract Baseline with Peak Analyzer](#)
- 4.5.1.2 [Batch Peak Analysis Using Theme with Script Before Each Process](#)
- 4.5.1.3 [Combine Quick Peaks Gadget with Peak Analyzer](#)
- 4.5.1.4 [Peak Finding](#)
  - [Picking and Marking Peaks](#)
- 4.5.1.5 [Peak Integration](#)
  - [Integrating Peaks](#)
- 4.5.1.6 [Peak Fitting](#)

- [Peak Fitting with Baseline](#)
- [Peak Fitting with Preset Peak Parameters](#)
- [Setting the Fix, Share Status or Bounds for Multiple Peak Parameters Simultaneously](#)

## 4.5.2 Create and Subtract Baseline with Peak Analyzer

### 4.5.2.1 Summary

In OriginPro, the **Peak Analyzer** is capable of creating and subtracting baseline. There are various ways for baseline creation. You can generate baseline anchor points automatically or manually and then connect them with interpolation or fit them with a function.

Minimum Origin Version Required: 2016 SR0

### 4.5.2.2 What you will learn

- How to create baseline with 2nd Derivative method
- How to create baseline with Asymmetric Least Squares (ALS) Method (Pro)
- How to subtract a baseline from the spectrum

### 4.5.2.3 Steps

#### 4.5.2.3.1 Create baseline with 2nd Derivative method

1. Start a **New Workbook** and import the *<Origin EXE Folder>\Samples\Spectroscopy\Baseline.dat*. Highlight the second column. In the main menu, select **Analysis: Peaks and Baseline: Peak Analyzer** to open the dialog of the **Peak Analyzer**.
2. In the first page (the **Goal** page) of the **Peak Analyzer**, select **Create Baseline** as **Goal**. Click **Next** to go to the **Baseline Mode** page.

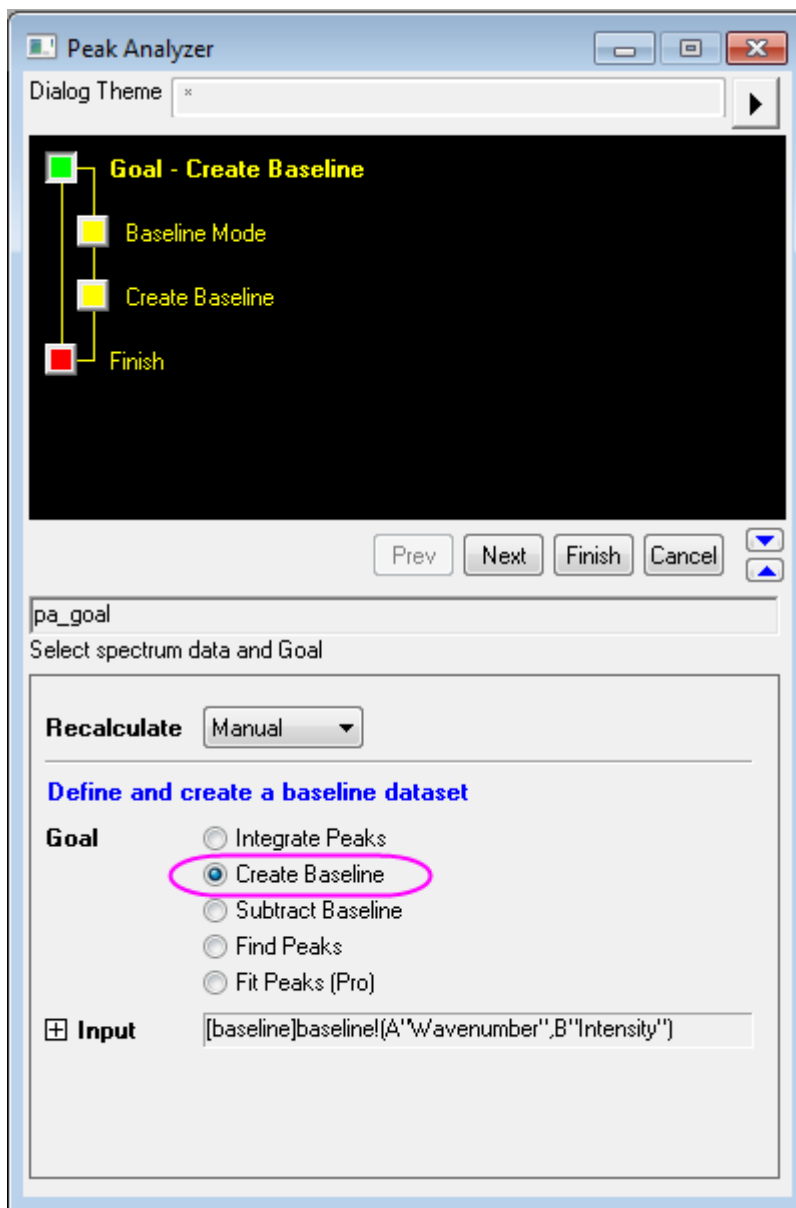

- Next we are going to create an user defined baseline for this spectrum by defining anchor points. On the **Baseline Mode** page, select **User defined** from the **Baseline Mode** dropdown list. Check on **Snap to Spectrum** to make sure when you add or move a baseline anchor point, it will be pulled back onto the spectrum.
- The first two methods in **Anchor Points Finding** are the most commonly used, and they can find anchor points automatically based on the derivative of the spectrum. If the baseline is approximately constant, **1st Derivative and 2nd Derivative** is more powerful, otherwise, we should use **2nd Derivative**. In this example, the baseline is more curly, so we use **2nd Derivative** method for locating anchor points.

For other methods in **Anchor Points Finding** and related smoothing parameters, you can refer to the link: [Baseline Mode Page](#).

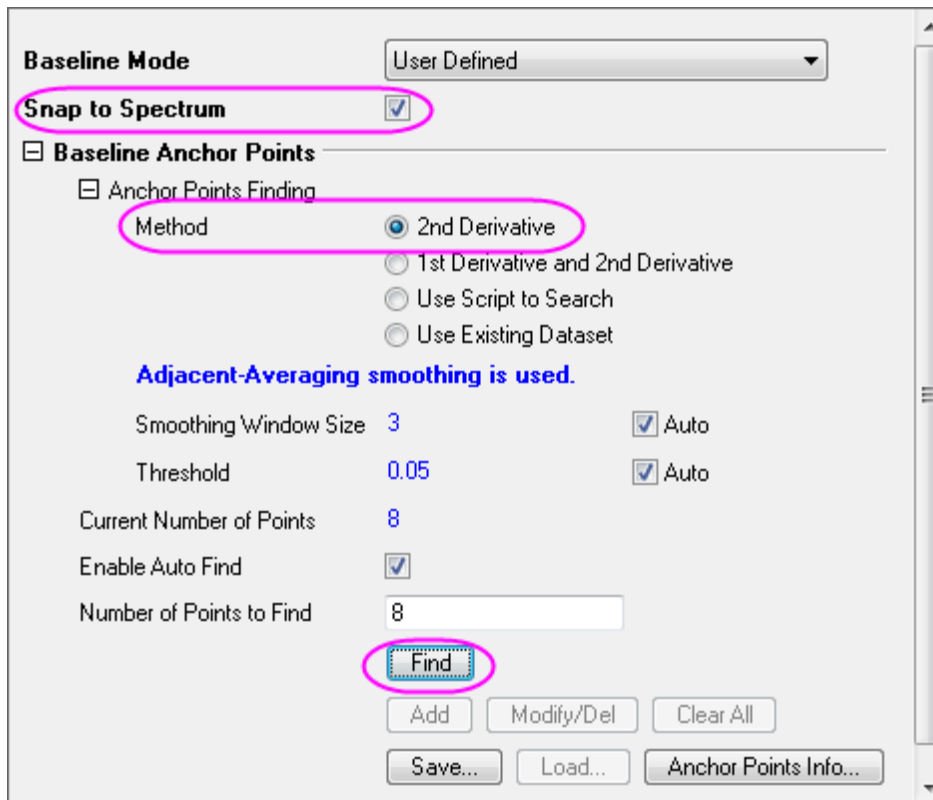

5. Now click the **Find** button in the **Baseline Anchor Points** group. You can preview the anchor points in preview window.

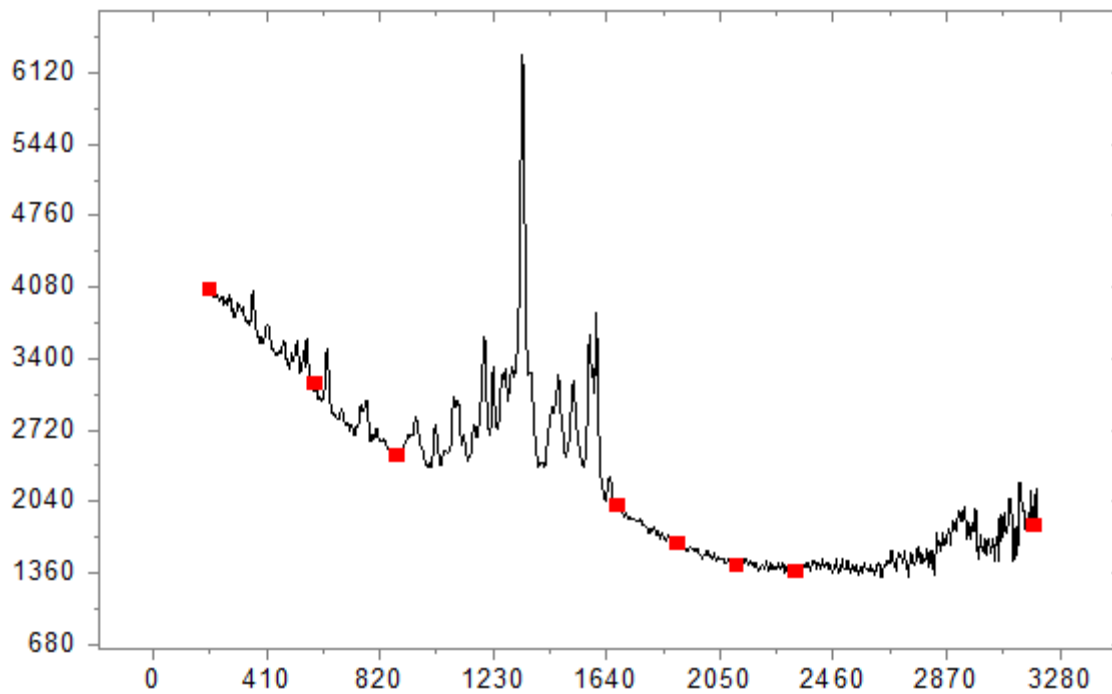

6. Click **Next** to go to the **Create Baseline** page, select **Interpolation** in the **Connect by** drop-down list. In **Interpolation** method group, select **Spline** from the drop-down list. You can preview the spectrum in preview window, and then click **Finish** to get the baseline data.

The image shows a software dialog box for creating a baseline. The 'Connect by' dropdown menu is set to 'Interpolation'. Below it, the 'Snap to Spectrum' checkbox is checked. The 'Baseline Anchor Points' section contains 'Add' and 'Modify/Del' buttons. The 'Number of Baseline Points' is set to 1501, and the 'Same as Input Data' checkbox is checked. Under the 'Interpolation Method' section, the 'Spline' radio button is selected, while 'Line' and 'BSpline' are unselected.

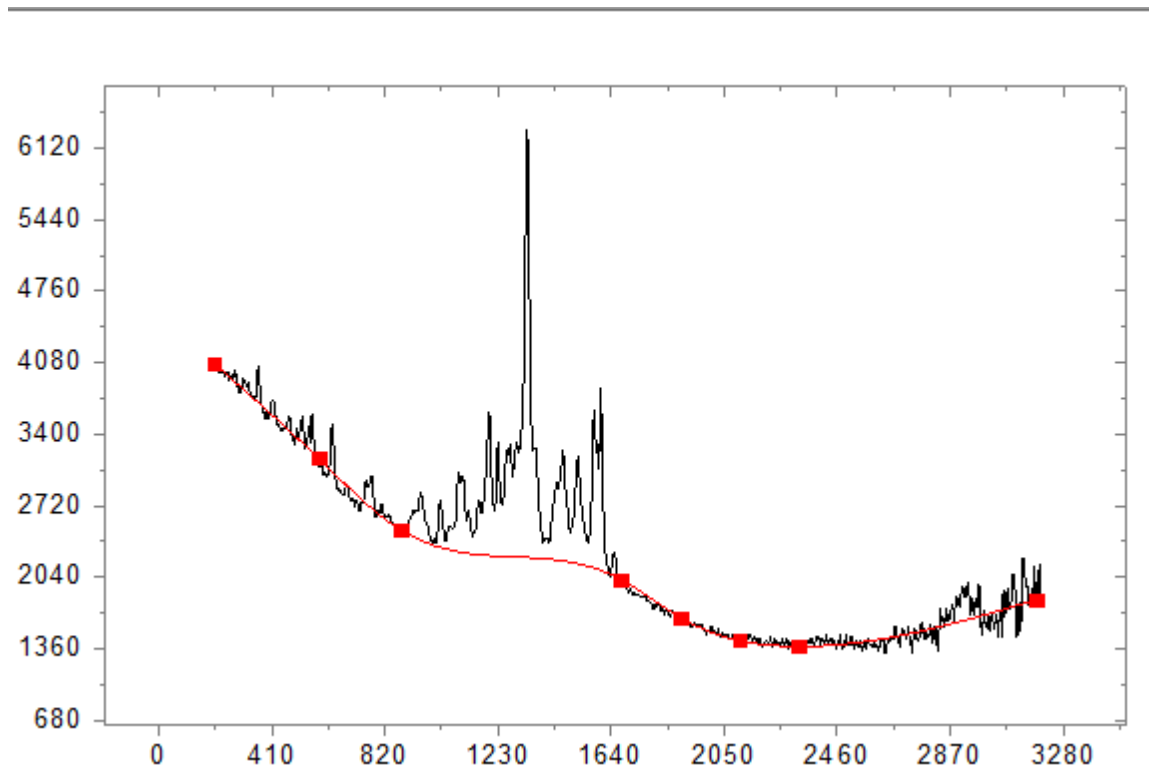

#### 4.5.2.3.2 Create baseline with ALS Method (Pro)

1. Start from the **Baseline Mode** page, and select the **Asymmetric Least Squares Smoothing Baseline** (ALS) as the baseline method. The ALS baseline can be tuned easily with a few parameters without pre-selecting any anchor points.

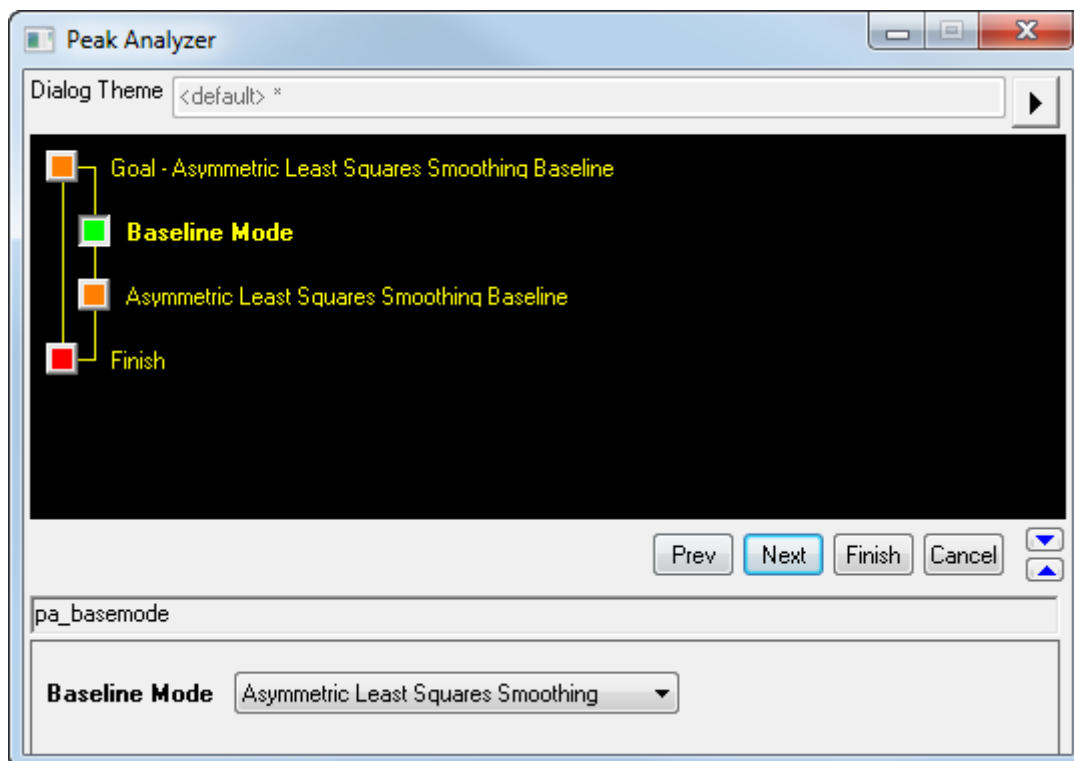

2. Click **Next** go to **Asymmetric Least Squares Smoothing Baseline** page, adjust the parameters to make the baseline optimal, then click **Finish** button to output the results table and graph.



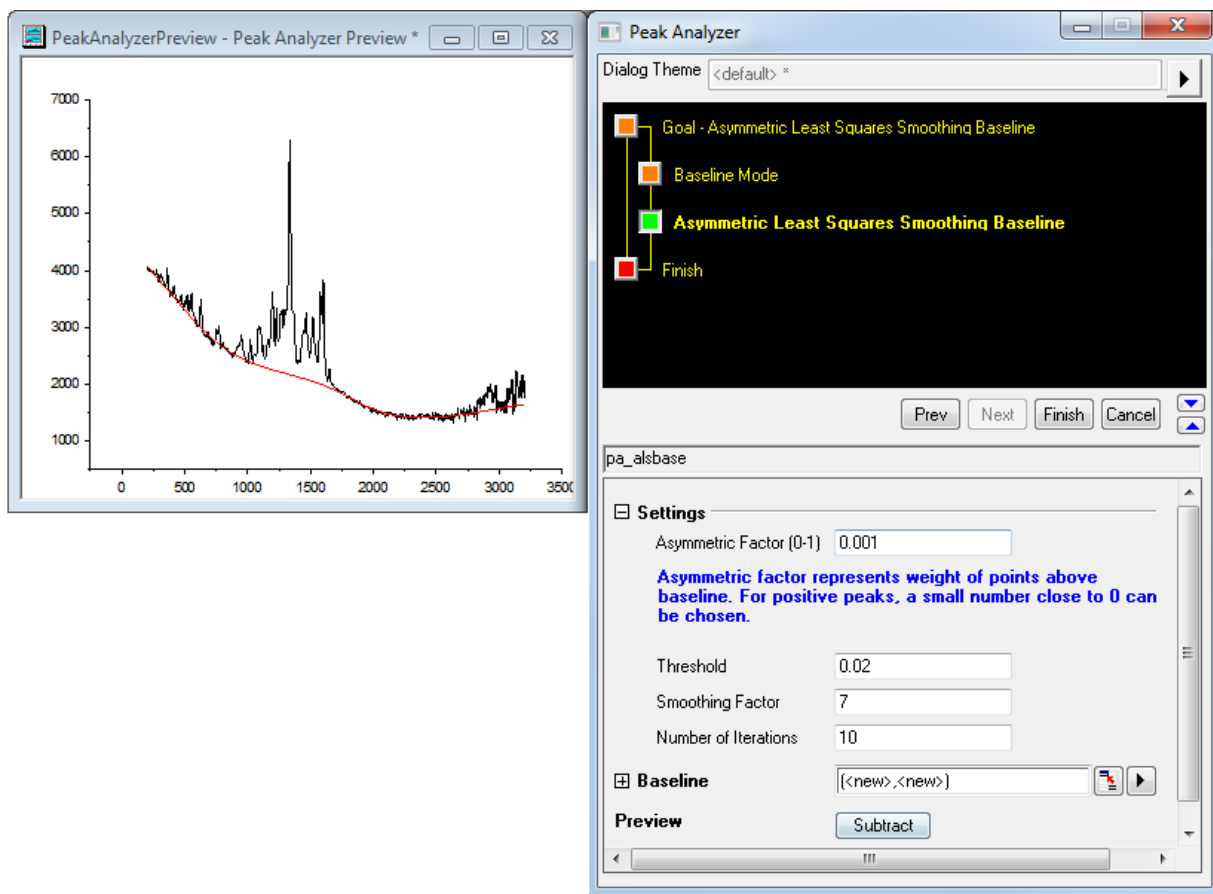

#### 4.5.2.3 Subtract Baseline from a Spectrum

1. If you want to subtract baseline, select **Subtract Baseline** as the **Goal** at start page.
2. After you created a baseline, click **Next** button to go to **Subtract Baseline** page.
3. Click **Subtract** button for previewing the subtracted data. The baseline data and subtracted spectrum will be outputted after clicking **Finish** button. The figures below displayed the **Subtract Baseline** page and the preview of the subtracted spectrum.

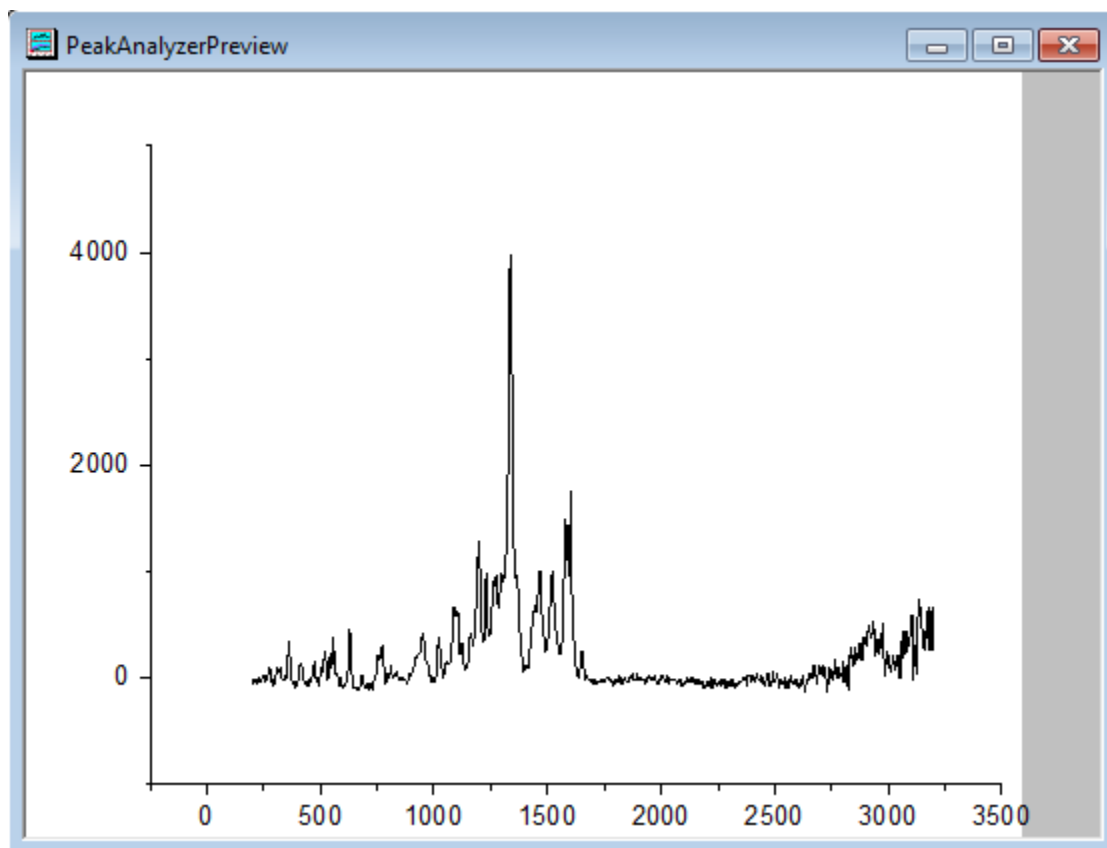
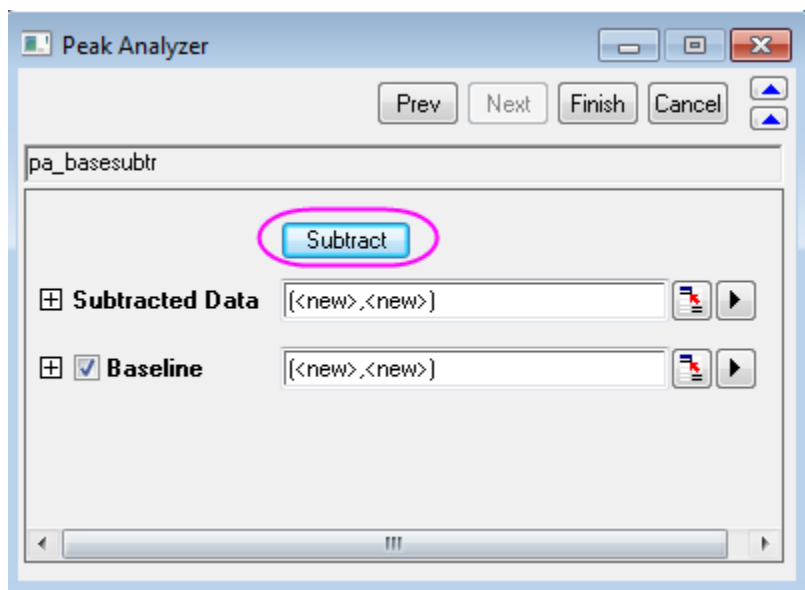

### 4.5.3 Use Script to Search for Baseline Anchor Points in Peak Analyzer

#### 4.5.3.1 Summary

In OriginPro, the **Peak Analyzer** is capable of creating and subtracting baseline. You can create a baseline by finding baseline anchor points first and then connect those anchor points either by interpolation or by fitting. To search for those baseline anchor points, you can either use built-in methods or define the search method on your own using LabTalk scripts.

#### 4.5.3.2 What you will learn

- How to create baseline with user-defined scripts
- How to integrate peaks from user-defined baseline

#### 4.5.3.3 Steps

##### 4.5.3.3.1 Create baseline with User-Defined Scripts

1. Start a **New Workbook** and import the *<Origin EXE Folder>\Samples\Spectroscopy\Chromatography\Liquid chromatogram.dat*. Highlight the second column. In the main menu, select **Analysis: Peaks and Baseline: Peak Analyzer** to open the dialog of the **Peak Analyzer**.
2. Make sure **Goal** is selected as **Integrate Peaks** and click **Next** button to go to **Baseline Mode** page.
3. Select **Baseline Mode** as **User Defined** and continue to select **Anchor Points Finding Method** under **Baseline Anchor Points** node as **Use Script to Search**.
4. Enter *apt\_x* and *apt\_y* in **X=** and **Y=** edit boxes, respectively. Then paste the scripts shown below into **Before Formula Script** box. Click **Find** button will run the scripts and the detected baseline anchor points will display on the preview window.

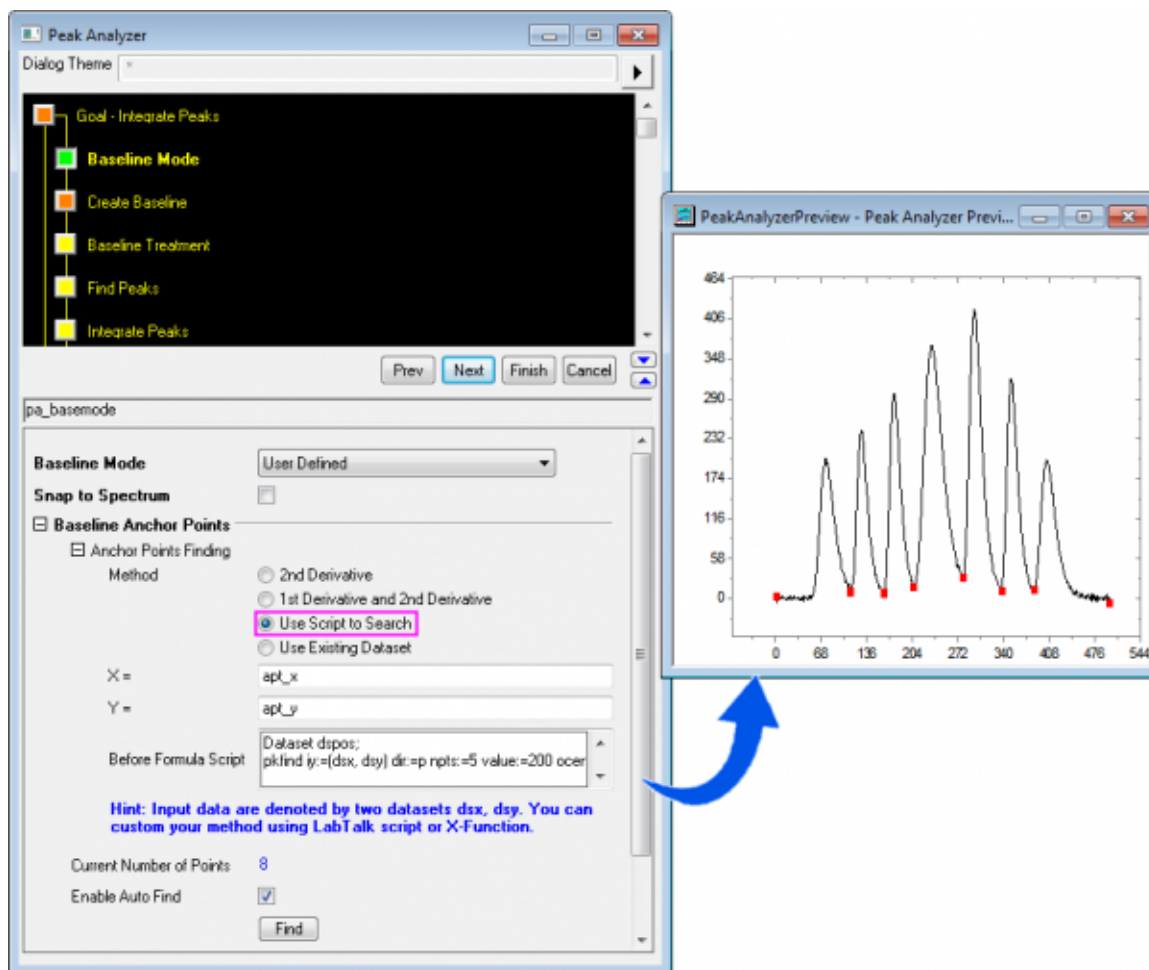

```
Dataset dspos;
```

```
pkfind iy:=(dsx, dsy) dir:=p npts:=5 value:=200 ocenter:=dspos; // Find major peak
positions
```

```
int npk=dspos.GetSize(); // Get major peak numbers
```

```
// Create datasets to store anchor points
```

```
int nn = dsx.GetSize(); // Get source X size
```

```
dataset apt_x, apt_y; // Create datasets to store anchor points
```

```
apt_x.SetSize(npk+1); // Set anchor points number
```

```
apt_y.SetSize(npk+1);
```

```

apt_x[1] = dsx[1]; // Set 1st data point as 1st anchor point

apt_y[1] = dsy[1];

apt_x[npk+1] = dsx[nn]; // Set last data point as last anchor point

apt_y[npk+1] = dsy[nn];

for (ii=1; ii<=npk; ii++)

{

int istart = dspos[ii]; // Get row index of ii-th peak

int iend = dspos[ii+1]; // Get row index of the next peak

range rtemp = [??]!dsy[$(istart):$(iend)]; // Declare the range and point to the
loose dataset

limit rtemp; // Get stats of the subrange

int ind = limit.imin; // Get min Y row index

apt_y[ii+1]=limit.ymin; // Get min Y between two peaks as anchor point

apt_x[ii+1]=dsx[ind];

};

```

The script will firstly find all major peak positions and then treat the minimum between every two adjacent peaks as one baseline anchor point, then add the first and last data points as two baseline anchor points.

**Note:** You can still uncheck **Enable Auto Find** checkbox and then use **Add** or **Modify/Del** to add or remove baseline anchor points.

5. Click **Next** button to go to **Create Baseline** page, make sure **Connect by** is selected as **Interpolation** and the **Interpolation Method** is **Line**. Then click **Finish** to obtain integration areas for each peak.

#### 4.5.4 Batch Peak Analysis Using Theme with Script Before Each Process

##### 4.5.4.1 Summary

Origin can perform batch peak analysis of multiple datasets using an [Analysis Theme](#). You can choose to pre-process the peak data, e.g., exclude unwanted datasets, before actually input it for peak analysis using script specified before each process.

Minimum Origin Version Required: 2016 SR0

#### 4.5.4.2 What Will You Learn

This tutorial will show you how to:

- Save analysis settings as a theme for batch peak analysis
- Write script before each process to pre-process data
- Do batch peak analysis using an analysis theme

#### 4.5.4.3 Steps

##### 4.5.4.3.1 Save Analysis Settings as a Theme

This tutorial is associated with `<Origin EXE Folder>\Samples\Tutorial Data.opj`.

1. Open **Tutorial Data.opj** and browse to the **Script Before Process in Batch PA** folder in **Project Explorer (PE)**.
2. Click on worksheet **Data1** in the workbook. Highlight column *B* and go to menu **Analysis: Peaks and Baseline: Peak Analyzer** to open dialog. Select **Fit Peaks(Pro)** as **Goal**.
3. Click **Next** button, select **None(Y=0)** as **Baseline Mode**. Click **Next** button twice to go to **Fit Peaks(Pro)** page, expand **Configure Graph** subnode under **Result** node and set **Create Summary Graph** to **<None>** to turn off generating report graph, which can speed up the analysis process.
4. Now click the  button next to the **Dialog Theme** control and select **Save as ...** to open **Theme Save as...** dialog. In the **Theme Name** edit box, enter *MyPeakAnalysis* and click **OK** button to save it.
5. Click **Finish** Button to perform the analysis and output results.

##### 4.5.4.3.2 Prepare Script for Pre-processing Peak Data

The **Batch Peak Analysis Using Theme** dialog provides three edit boxes to allow running script before each process, after each process and at the end of all processes. In this section we will mainly show how to write script before each process to pre-process the peak data.

1. Activate worksheet **Data1** again, we can see from the sparkline of each dataset that some of peak data are very noisy, e.g., column *C, E, F*, and we want to exclude such noisy dataset if it reaches certain noise level.
2. The way used to identify whether data is noisy in this tutorial follows the routine below:
  - Filter raw data with a high-pass FFT filter to obtain the high-frequency noise from the data.
  - Find the standard deviation(SD) of the noise and the corresponding raw data.
  - Set a criteria that if the ratio of the square of SD of the noise over the square of SD of the raw data is over 30%, it will be regarded as noisy data and will be excluded for batch analysis.
3. Follow the routine above, the script for pre-excluding noisy data is as following:



```

dataset dr;

fft_filters iy:=_ry filter:=high oy:=dr; // Perform high-pass fft filter
to obtain noise

stats dr;

double nSD = stats.sd; // Calculate SD of noise

stats _ry;

double sSD = stats.sd; // Calculate SD of raw data

if(nSD^2/sSD^2>0.3) // Set noise identification criteria

    _skip=1;

else

    _skip=0;

```

where `_ry` refers to current y data, `_skip` determines whether to skip current dataset.

#### 4.5.4.3.3 Batch Analyze Datasets Using Analysis Theme

1. Activate worksheet **Data1**, highlight all columns in the sheet and go to menu **Analysis: Peaks and Baseline: Batch Peak Analysis Using Theme...** to open dialog.
2. Select *MyPeakAnalysis* from **Theme** drop-down list, **Peak Properties(Pro)** from **Result Sheet** drop-down list.
3. To output results to a specified sheet, you can enter the range syntax in **Output Sheet** edit box. Suppose we want to export to *MyResults* sheet in *MySummary* book, you can input `[MySummary]MyResults!` in the edit box.

4. Input the script we wrote in section above into **Script Before Each Process** under **Script** node.

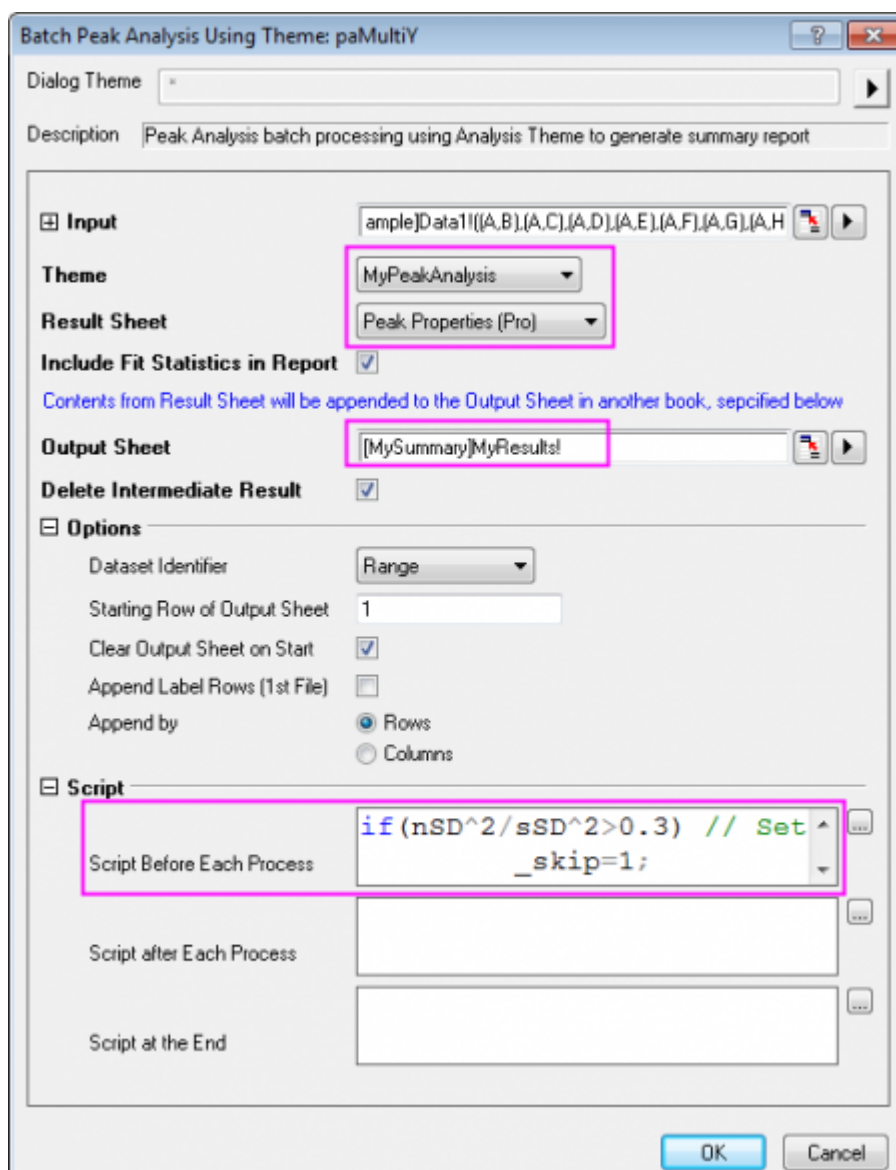



5. Click **OK** button to perform batch peak analysis and you will see noisy datasets(say column C, E and F) are excluded in **MyResults** sheets.

	A(Y)	B(Y)	C	D(Y)	E(Y)	F(Y)	G(Y)	H(Y)	I(Y)	J(Y)
Long Name	Dataset	Peak Index	Peak Type	Area Fit	Area FitT	Area FitTP	Center Max	Center Grv	Max Height	FWHM
Units										
Comments										
Parameters										
1	[Sample]Data1!(A,B)	1	Gaussian	62.965	62.96315	26.83319	1.00146	1.00146	111.9851	0.5282
2	[Sample]Data1!(A,B)	2	Gaussian	#####	#####	52.29279	3.99952	3.99952	#####	0.7740
3	[Sample]Data1!(A,B)	3	Gaussian	48.98016	48.98016	20.87402	6.99981	6.99981	#####	0.2484
4	[Sample]Data1!(A,D)	1	Gaussian	66.69304	66.69304	11.37578	1.2	1.2	#####	0.2873
5	[Sample]Data1!(A,D)	2	Gaussian	#####	#####	30.09463	3.8	3.8	#####	0.3611
6	[Sample]Data1!(A,D)	3	Gaussian	#####	#####	38.35519	6.3	6.3	#####	0.1950
7	[Sample]Data1!(A,D)	4	Gaussian	#####	#####	20.1744	8.8	8.8	#####	0.1956
8	[Sample]Data1!(A,G)	1	Gaussian	93.24854	93.24854	30.21961	1.8	1.8	#####	0.7235
9	[Sample]Data1!(A,G)	2	Gaussian	#####	#####	39.84866	5	5	#####	0.6582
10	[Sample]Data1!(A,G)	3	Gaussian	92.36032	92.36026	29.93173	8	8	89.14607	0.9733
11	[Sample]Data1!(A,H)	1	Gaussian	#####	#####	45.4566	2.49826	2.49826	#####	0.5965
12	[Sample]Data1!(A,H)	2	Gaussian	#####	#####	54.5434	7.50242	7.50242	#####	0.9573

## 4.5.5 Combine Quick Peaks Gadget with Peak Analyzer

### 4.5.5.1 Summary

The Quick Peaks gadget provides an intuitive way to carry out peak analysis, and Peak Analyzer provides further options for peak finding, fitting, etc. You can first use Quick Peaks gadget to find peaks and then use the Peak Analyzer to analyze the peaks. You can save the whole analysis as a theme in the Peak Analyzer for future use and/or batch processing.

Minimum Origin Version Required: OriginPro 9.0 SR0

### 4.5.5.2 What You Will Learn

This tutorial will show you how to:

- Use the Quick Peaks gadget to find peaks.
- Open the Peak Analyzer from Quick Peaks gadget.
- Further analyze the peaks found in Quick Peaks gadget using the Peak Analyzer.

### 4.5.5.3 Steps

This tutorial is associated with <Origin EXE Folder>\Samples\Tutorial Data.opj.

1. Open **Tutorial Data.opj** and browse to the **Quick Peaks Gadget** folder in **Project Explorer (PE)**.
2. Highlight all columns in the **Nitrate** worksheet and click the  button on **2D Graph** toolbar to generate a line graph.
3. Activate the generated graph window and select **Gadgets:Quick Peaks**.
4. In the **ROI box** tab, change the **From** and **To** values of X scale to **34.75** and **35** respectively, select the **Fixed(Prevent moving by ROI)** check box.

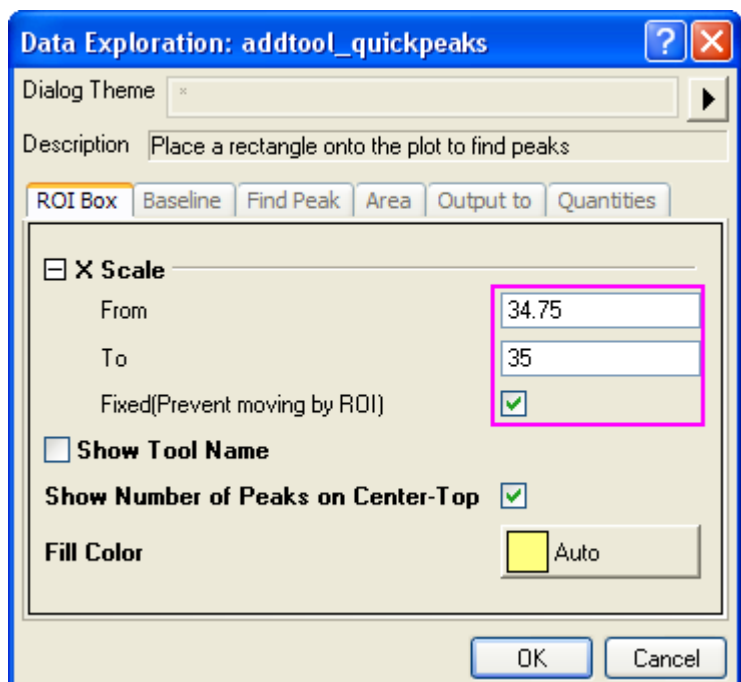

5. In the **Baseline** tab, select the **Full Plot Range** radio button for **Range**.

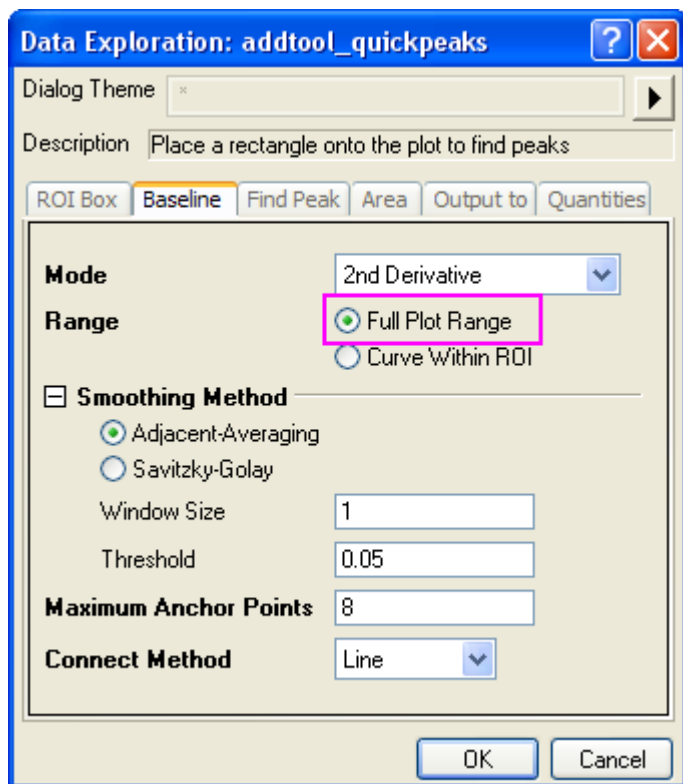

6. In the **Find Peak** tab, change the **Method** for **Peak Filtering** to **By Number**, and set the **Number of Peaks** as **3**, select **Blue** as the color of the **Peak Label**.

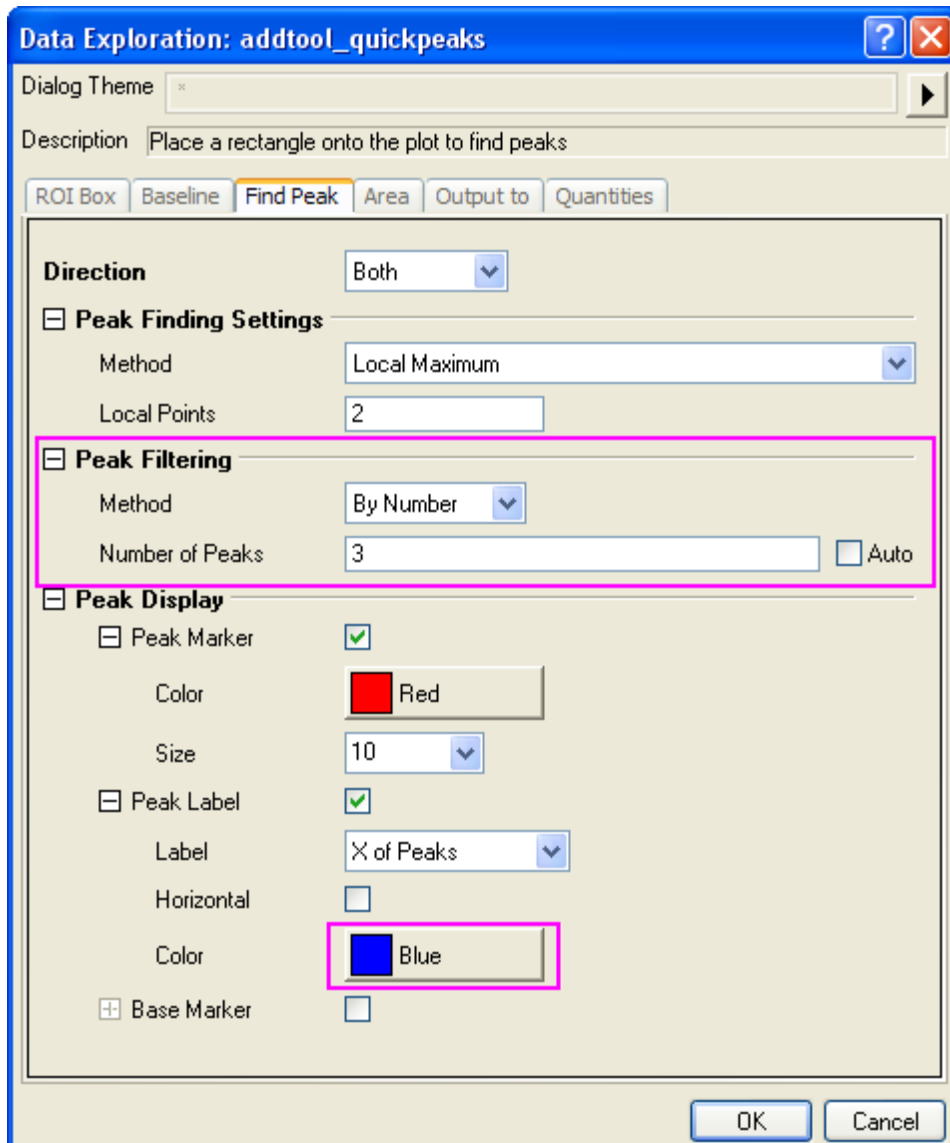

7. In the **Output to** tab, change the **Result Worksheet Name** to **[QkPeak]%C\_Result2**.

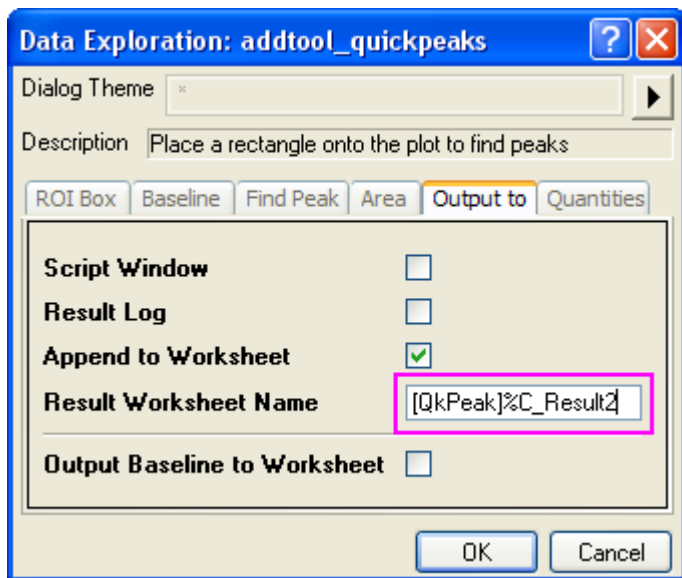

8. In the **Quantities** tab, you can decide which quantities to output. Leave only the check boxes for **Peak ID**, **Peak X**, **Peak Y**, **Height**, **Peak Area** and **FWHM** checked, and clear the other check boxes. Click **OK** to add the gadget to the plot.

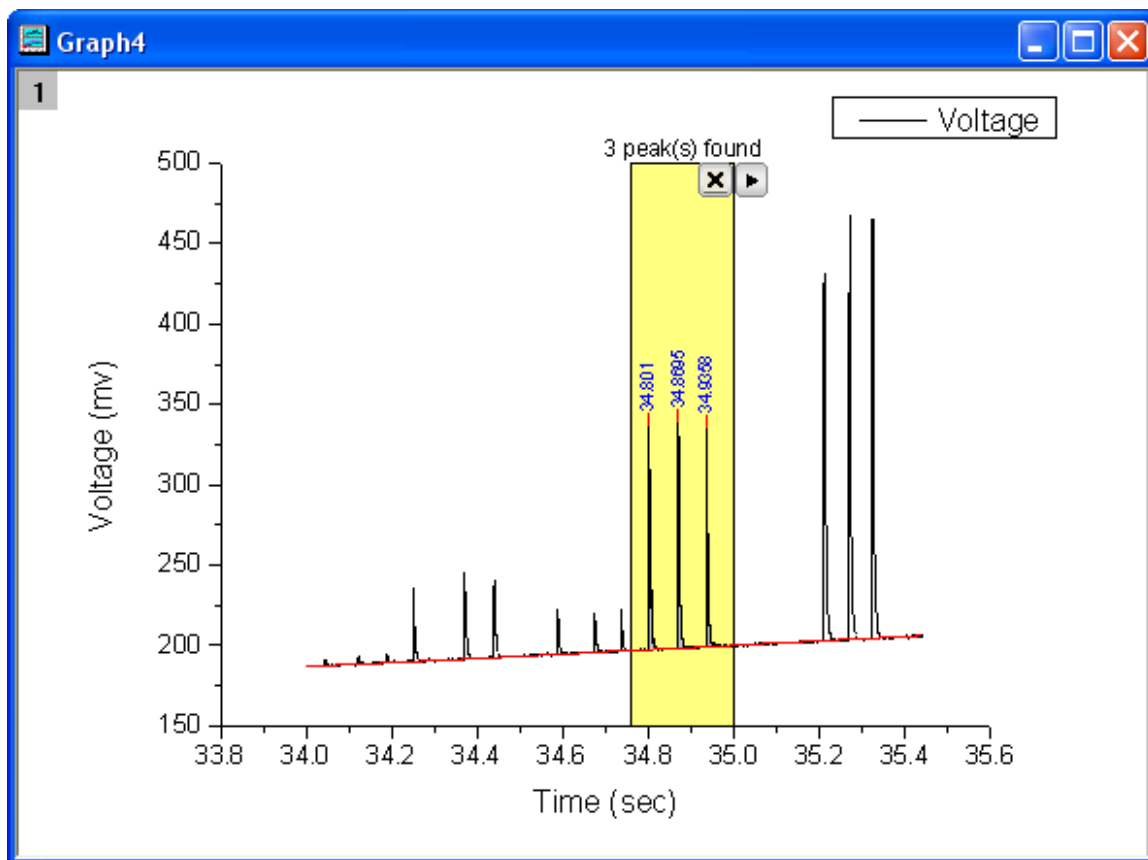

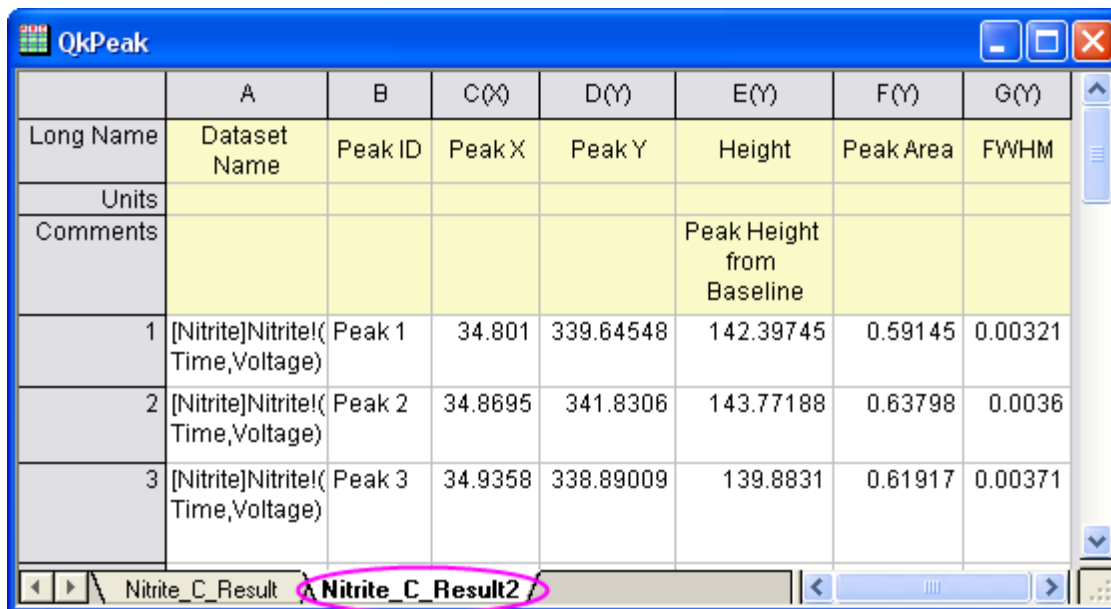

9. Click the triangle button  to the right of the ROI box and select **New Output** to generate the report worksheet.
10. Bring up the context menu again to select **Go to Report Worksheet** to open the result worksheet.

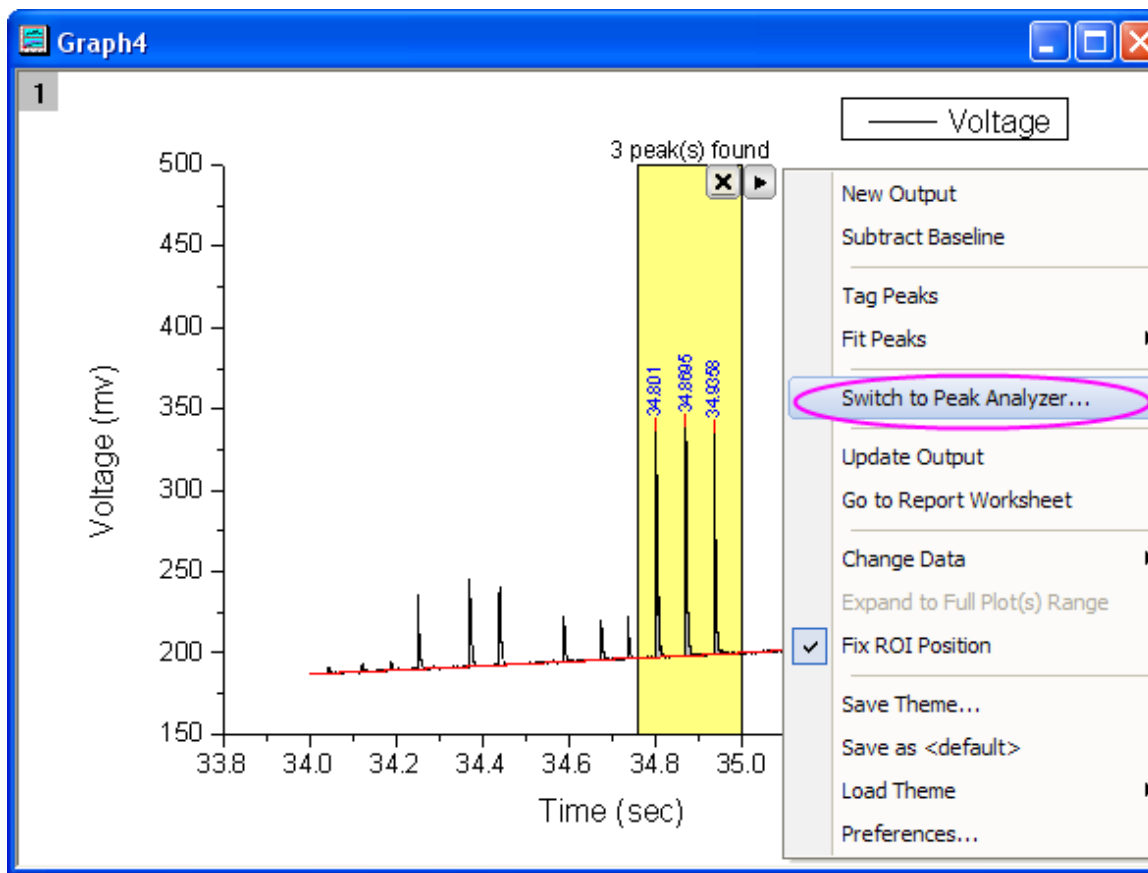

	A	B	C(X)	D(Y)	E(Y)	F(Y)	G(Y)
Long Name	Dataset Name	Peak ID	Peak X	Peak Y	Height	Peak Area	FWHM
Units							
Comments					Peak Height from Baseline		
1	[Nitrite]Nitrite!(Time,Voltage)	Peak 1	34.801	339.64548	142.39745	0.59145	0.00321
2	[Nitrite]Nitrite!(Time,Voltage)	Peak 2	34.8695	341.8306	143.77188	0.63798	0.0036
3	[Nitrite]Nitrite!(Time,Voltage)	Peak 3	34.9358	338.89009	139.8831	0.61917	0.00371

11. Now we are going to open the Peak Analyzer to carry out peak fitting. Bring up the context menu and choose **Switch to Peak Analyzer**.



12. The Peak Analyzer is opened, the **Fit Peaks** goal is already selected, the baseline mode and peak finding method follow the settings in the Quick Peaks gadget.
13. Go to the **Fit Peaks** page directly and click the **Fit** button to fit the three found peaks with default Gaussian function.
14. Click the  button and select **Save As** in the context menu to save this analysis as a theme with the name **MyQuickPeaks**.

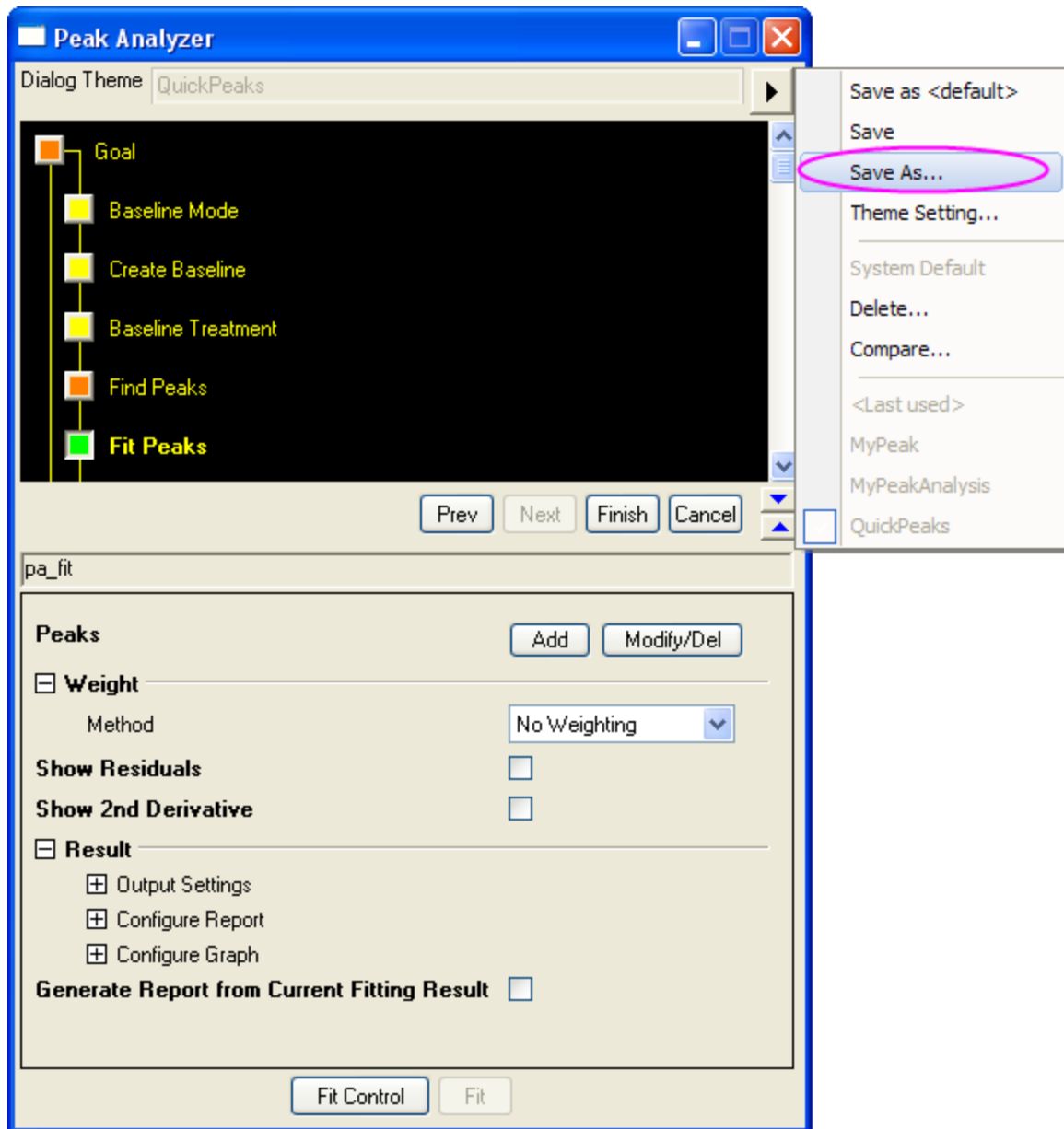

15. In the Peak Analyzer, click the **Finish** button to generate the peak fitting results.

**Notes:** The theme can be used in the batch peak analysis. Select **Analysis:Peaks and Baseline:Batch Peak Analysis using Theme** to open the **paMultiY** dialog. The batch peak analysis is very useful when you have multiple data files that are similar. You can refer to [this example](#) for more details.

## 4.5.6 Peak Finding

### 4.5.6.1 Peak Finding

- [Picking and Marking Peaks](#)

#### 4.5.6.2 [Picking and Marking Peaks](#)

##### 4.5.6.2.1 Summary

The Peak Analyzer provides several methods to pick peaks automatically. Also, user can opt to add/delete/modify the peaks manually.

Labels are added to the peak centers after they are found or added, to show user the positions of the current peaks.

Minimum Origin Version Required: Origin 8.0 SR6

##### 4.5.6.2.2 What you will learn

- How to use and customize the auto peak finding in the Peak analyzer
- How to customize the labels for the peak centers

##### 4.5.6.2.3 Steps

1. Start a new workbook and import the file <Origin Program Folder>\Samples\Spectroscopy\HiddenPeaks.dat.
2. Highlight the second column.
3. Create a line plot by selecting **Plot: Line: Line**.
4. With the graph active, select **Analysis: Peaks and Baseline: Peak Analyzer** to open the dialog of the Peak Analyzer.
5. In the first page (the **Start** page), select the **Find Peaks** radio button in the **Goal** group. Then click the **Next** button to go to the next page.



6. In the **Baseline Mode** page, select **None(Y=0)** for **Baseline Mode**.



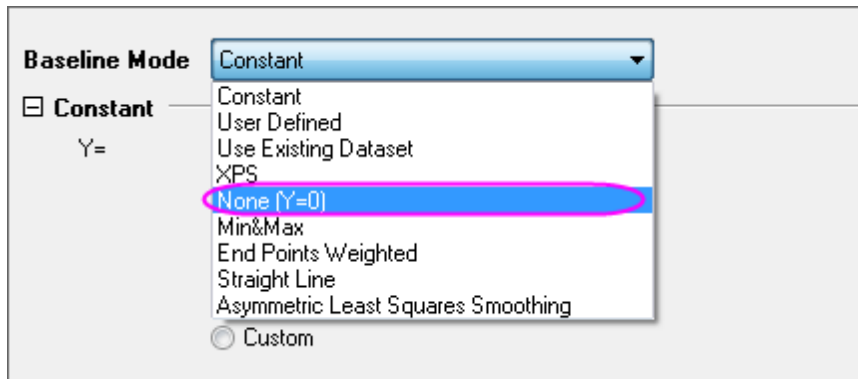

Click the **Next** button to go to the **Find Peaks** page.

7. In the **find Peaks** page:

1. Expand the **Peak Finding Settings** branch. Make sure that **Local Maximum** is selected for **Method**. Then click the **Find** button. Only five peaks are detected.

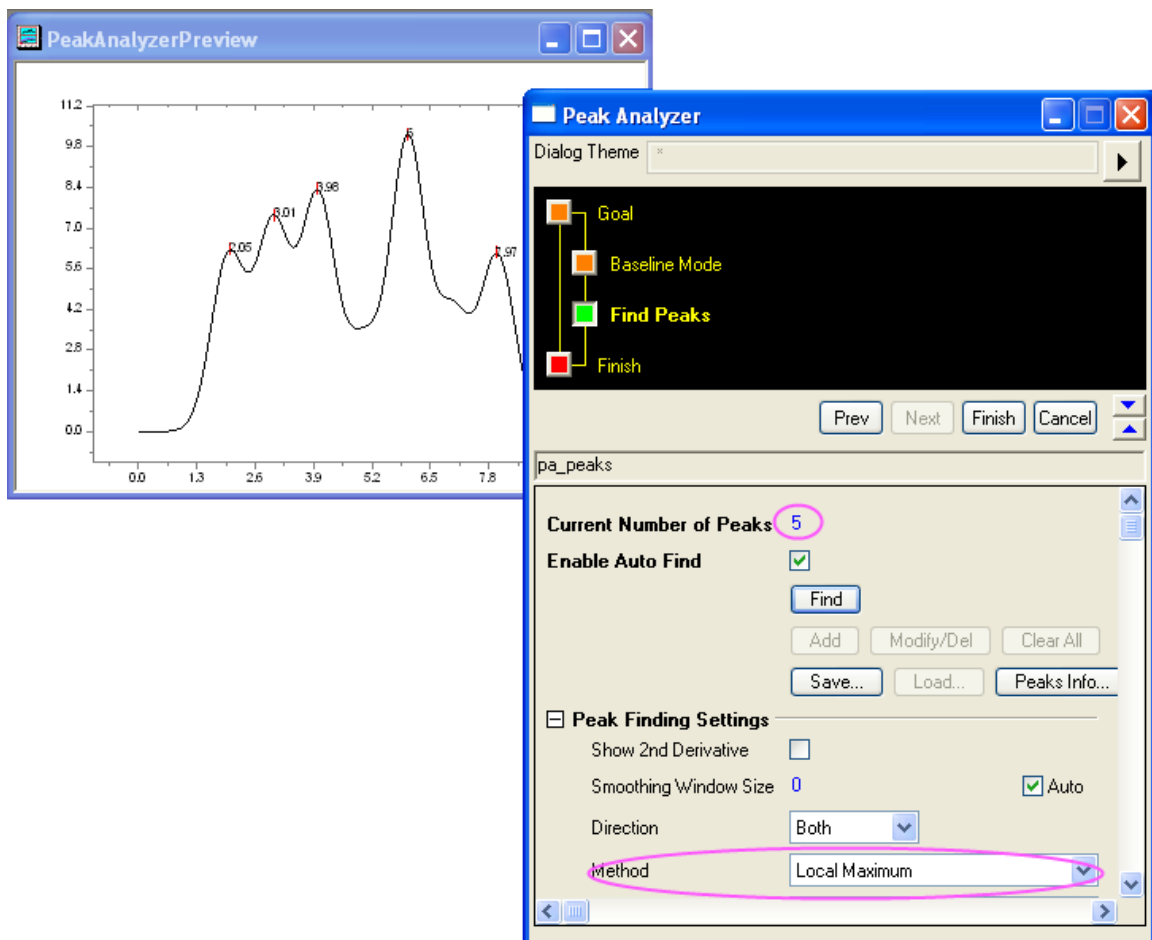

2. Change **Method** to **2nd Derivative (Search Hidden Peaks)**. Click the **Find** button again. This time, seven peaks are detected.

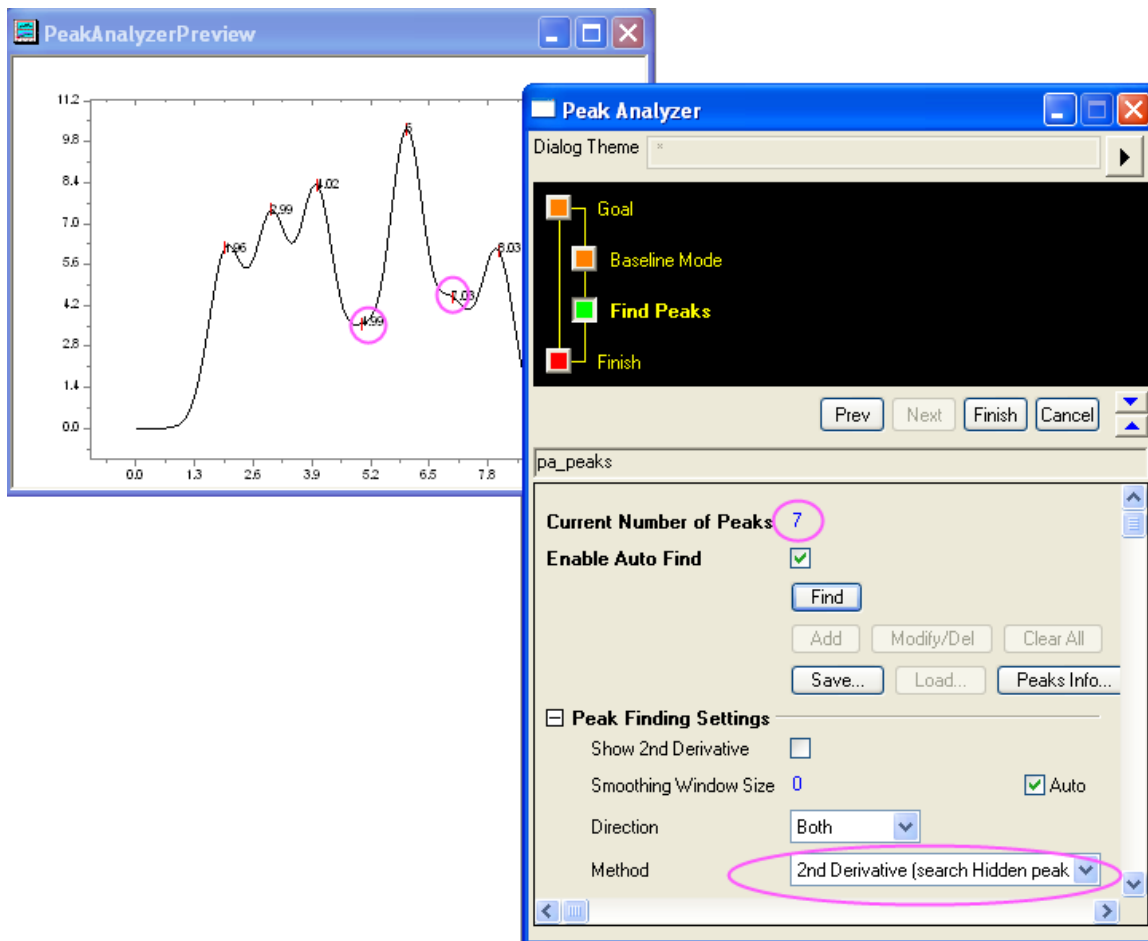

3. Click **Finish** to complete the analysis. We will get this final graph:

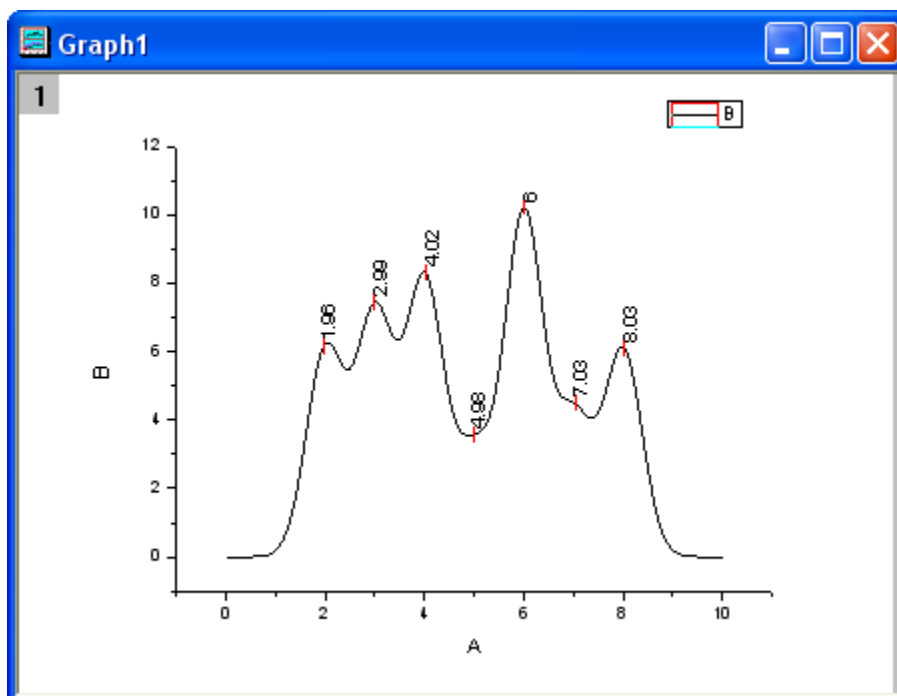

## 4.5.7 Peak Integration

### 4.5.7.1 Peak Integration

- [Integrating Peaks](#)

### 4.5.7.2 Integrating Peaks

#### 4.5.7.2.1 Summary

Use the Peak Analyzer to integrate peaks and find their areas.

Minimum Origin Version Required: Origin 8.0 SR6

#### 4.5.7.2.2 What you will learn

- How to pick an existing dataset as baseline
- How to subtract a baseline from the spectrum data
- How to calculate peak areas with the Peak Analyzer

#### 4.5.7.2.3 Steps

1. Start a new workbook and import the file `\Samples\Spectroscopy\Peaks with Base.DAT`.
2. Highlight the second column.

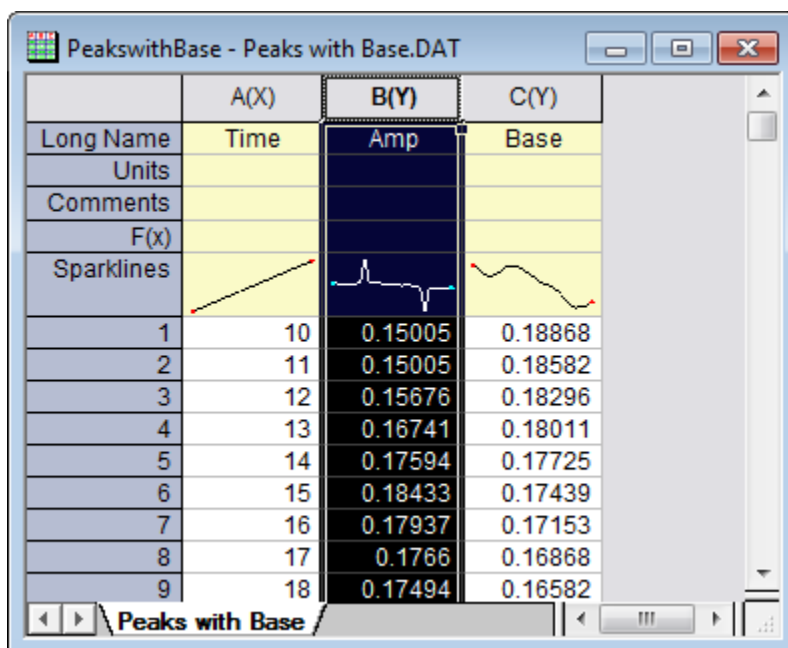

3. In the main menu, click **Analysis**, then point to **Peaks and Baseline**, and then click **Peak Analyzer**.

4. In the first page (the **Goal** page) of the **Peak Analyzer**, select **Integrate Peaks** in the **Goal** group. Click **Next** to go to the **Baseline Mode** page.

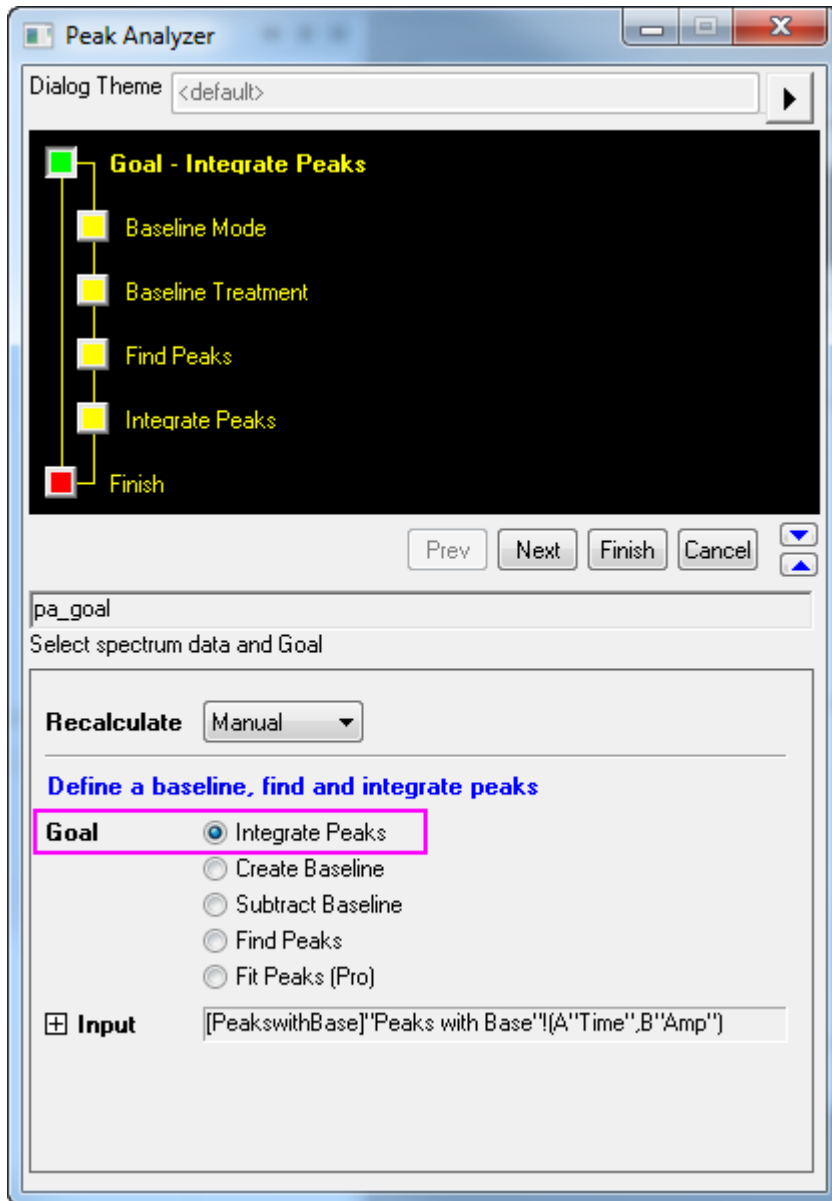

5. On the **Baseline Mode** page, select **Use Existing Dataset** from the **Baseline Mode** dropdown list. Click the **triangular button** to the right of the Dataset dropdown menu, and then select **[PeakswithBase]\"Peaks with Base\"!C\"Base\"** on the fly-out menu. Click **Next** to go to the **Baseline**

**Treatment** page of the Peak Analyzer.

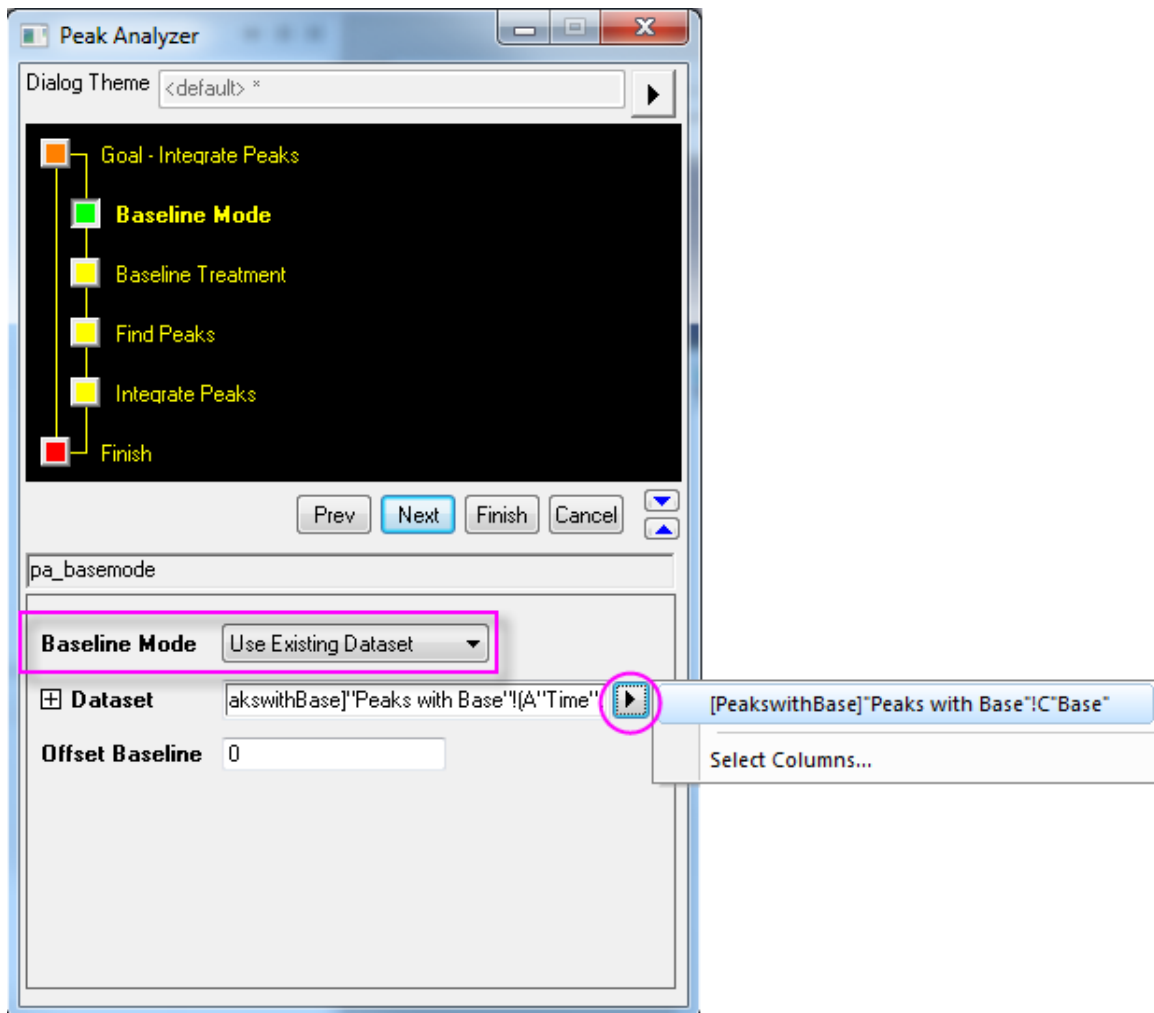

6. Select the **Auto Subtract Baseline** check box. Click the **Integrate Peaks** page icon in the upper panel (or click **Next** twice to go to the Integrate Peaks page). In the preview graph, you will see two numbered

yellow rectangles representing two peaks found with the default settings.

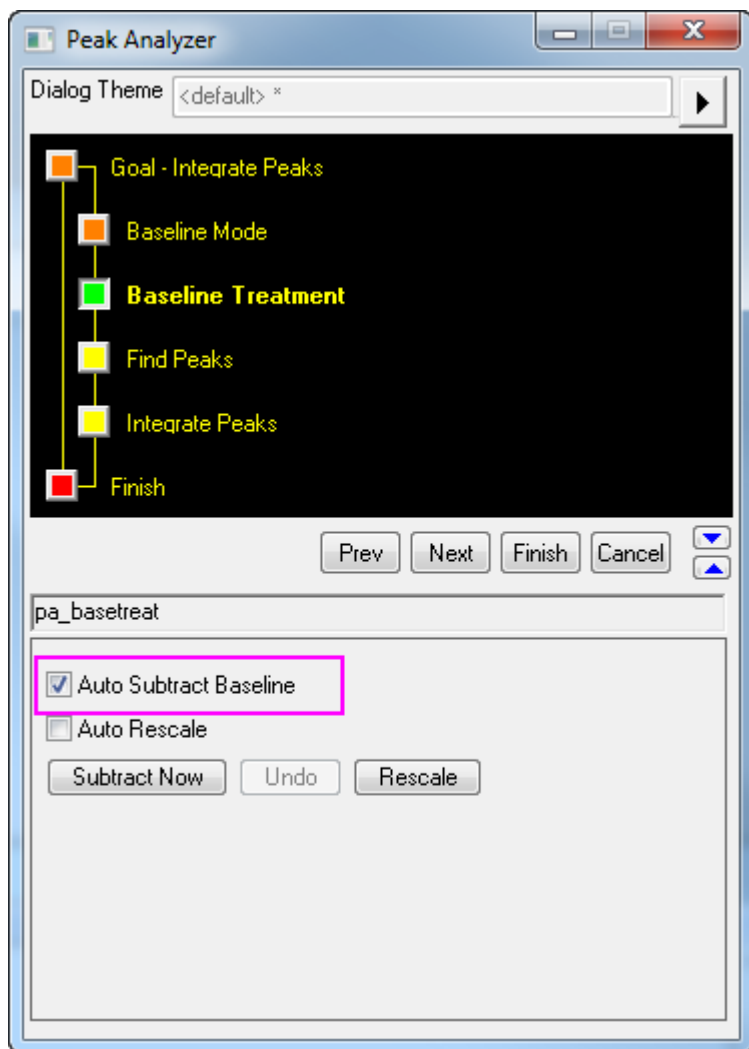

7. For **Integration Window Width**, select **Adjust on Preview Graph**. On the graph, click inside the rectangle marked with **1**. A pair of "handles" appears on either side of the yellow integration window. Drag these handles to adjust the range for which integration will be performed. Click inside the rectangle

marked with **2** and adjust the integration range for the second peak.

The image displays the Peak Analyzer software interface. On the left is the 'Peak Analyzer' dialog box, and on the right is the 'PeakAnalyzerPreview' window. The 'Peak Analyzer' dialog box has a 'Dialog Theme' dropdown and a list of steps: Goal - Integrate Peaks, Baseline Mode, Baseline Treatment, Find Peaks, Integrate Peaks (highlighted in green), and Finish. Below this is a 'Prev' button. The 'PeakAnalyzerPreview' window shows a chromatogram with two peaks. The first peak is labeled '1' and the second is labeled '2'. Two yellow shaded regions represent integration windows around each peak. A pink callout box labeled 'handles' points to green handles on the integration windows. Below the preview is a detailed configuration panel for the 'Integrate Peaks' step. It includes a 'pa\_int' label and the instruction 'Calculate the peak area'. A blue heading reads 'Move the yellow rectangles to change integration limits'. The 'Number of Ranges to Integrate' is set to 2, with an 'All Peaks' checkbox checked. The 'Integration Window Width' is set to 'Adjust on Preview Graph' (selected with a radio button and highlighted by a pink box). Other options include 'Auto' and 'Fix Width For All Peaks'. Under the 'Quantities' group, there are input fields for 'Integration Result' and 'Integral Curves Data', both with '[<input>]<new>' and '[<same>]<new>' options and navigation buttons.

- In the **Integrate Peaks** page of the Peak Analyzer, make sure all the desired quantities to compute have been selected in the **Quantities** group. For example, if you want to calculate the peak centroid for each peak, select the **Peak Centroid** check box. If you don't want to output the percent areas, clear the **Percent Area** check box. When you are done, click **Finish** to perform the analysis.

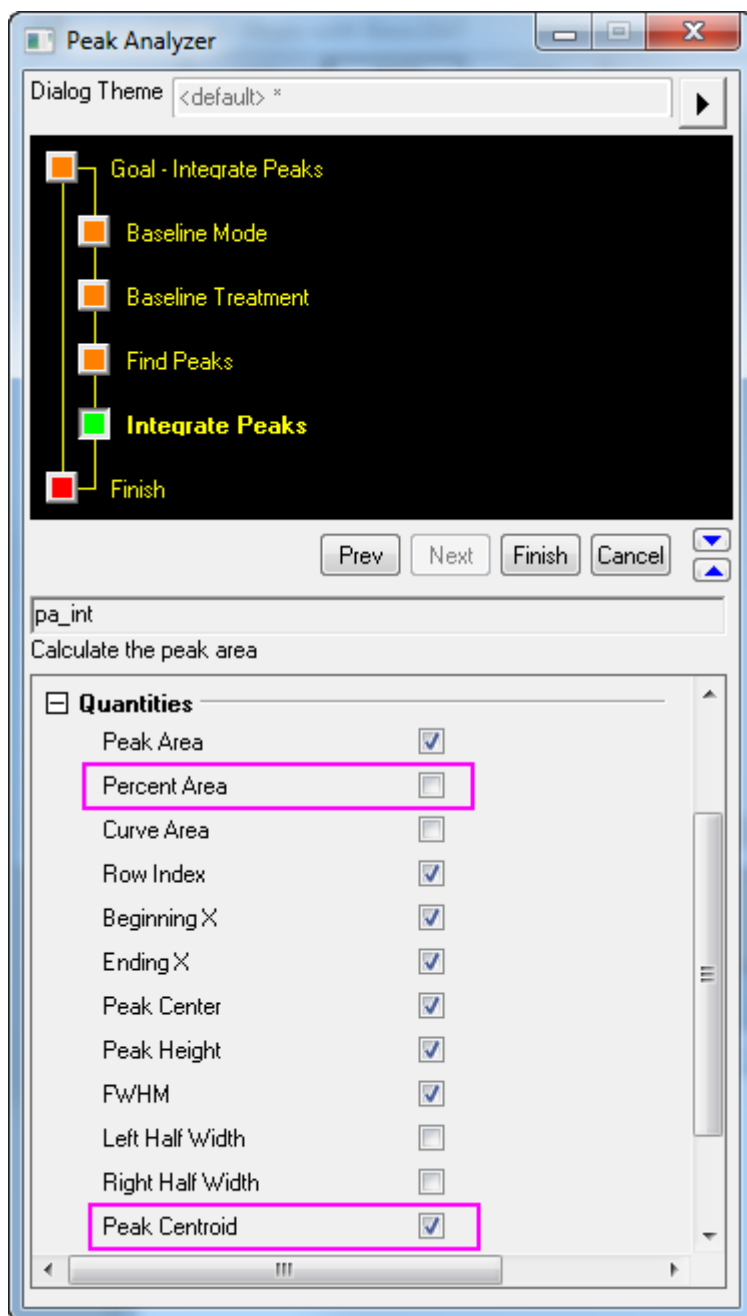

The result is in a worksheet named *Integration\_Result1*.



	Index	Area	Row Index	Beginning X	Ending X	FWHM	Center	Height	Centroid
1	1	26.62295	93	77	119	13.16915	103	1.87906	102.12429
2	2	-27.62137	267	249	293	13.28994	277	-1.9043	275.88972
3									

If the Area check box was selected in the Quantities group, peak area data appears in the Area column of the result worksheet.

## 4.5.8 Peak Fitting

### 4.5.8.1 Peak Fitting

- [Peak Fitting with Baseline](#)
- [Peak Fitting with Preset Peak Parameters](#)
- [Setting the Fix, Share Status or Bounds for Multiple Peak Parameters Simultaneously](#)

### 4.5.8.2 Peak Fitting with Baseline

#### 4.5.8.2.1 Summary

In OriginPro, the **Peak Analyzer** is capable of performing multiple peak fitting with several baseline subtraction options.

There are various ways to create a baseline for your spectrum data. You can select a few anchor points and then fit them with a function. The fitting of the baseline can be done along with the peak fitting.

#### 4.5.8.2.2 What You Will Learn

- How to perform fitting of peaks
- How to fit the baseline

#### 4.5.8.2.3 Steps

1. Start a new worksheet and import the file <Origin Program Folder>\Samples\Spectroscopy\Peaks on Exponential Baseline.dat.

2. Highlight the second column in the worksheet.

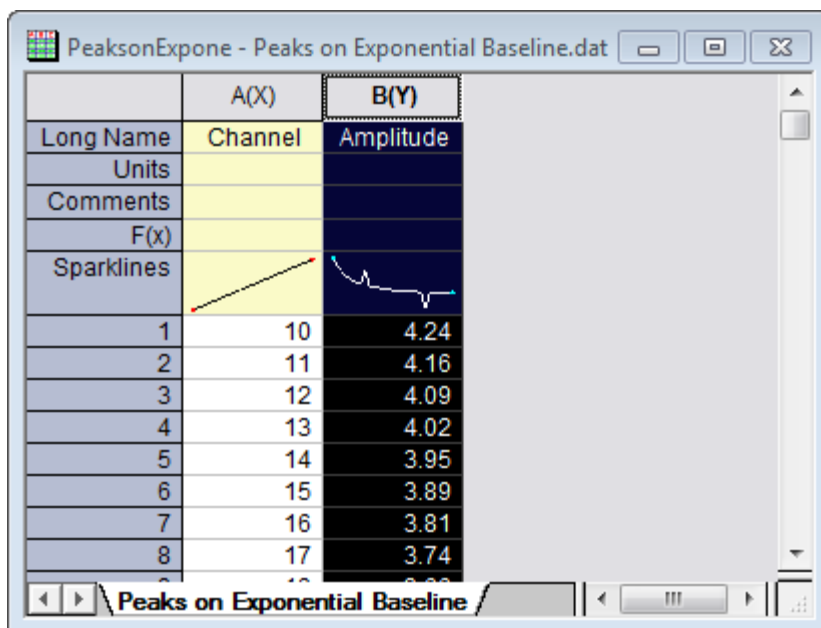

3. Select **Analysis: Peaks and Baseline: Peak Analyzer** from the main menu to open the **Peak Analyzer**.

4. Select the **Fit Peaks** radio button in the **Goal** group on the first page.



5. Click **Next** to go to the **Baseline Mode** page. In the **Baseline Mode** page, select **User Defined** from the **Baseline Mode** drop-down list. Click the **Find** button in the **Baseline Anchor Points** group. Eight anchor

points should be found.

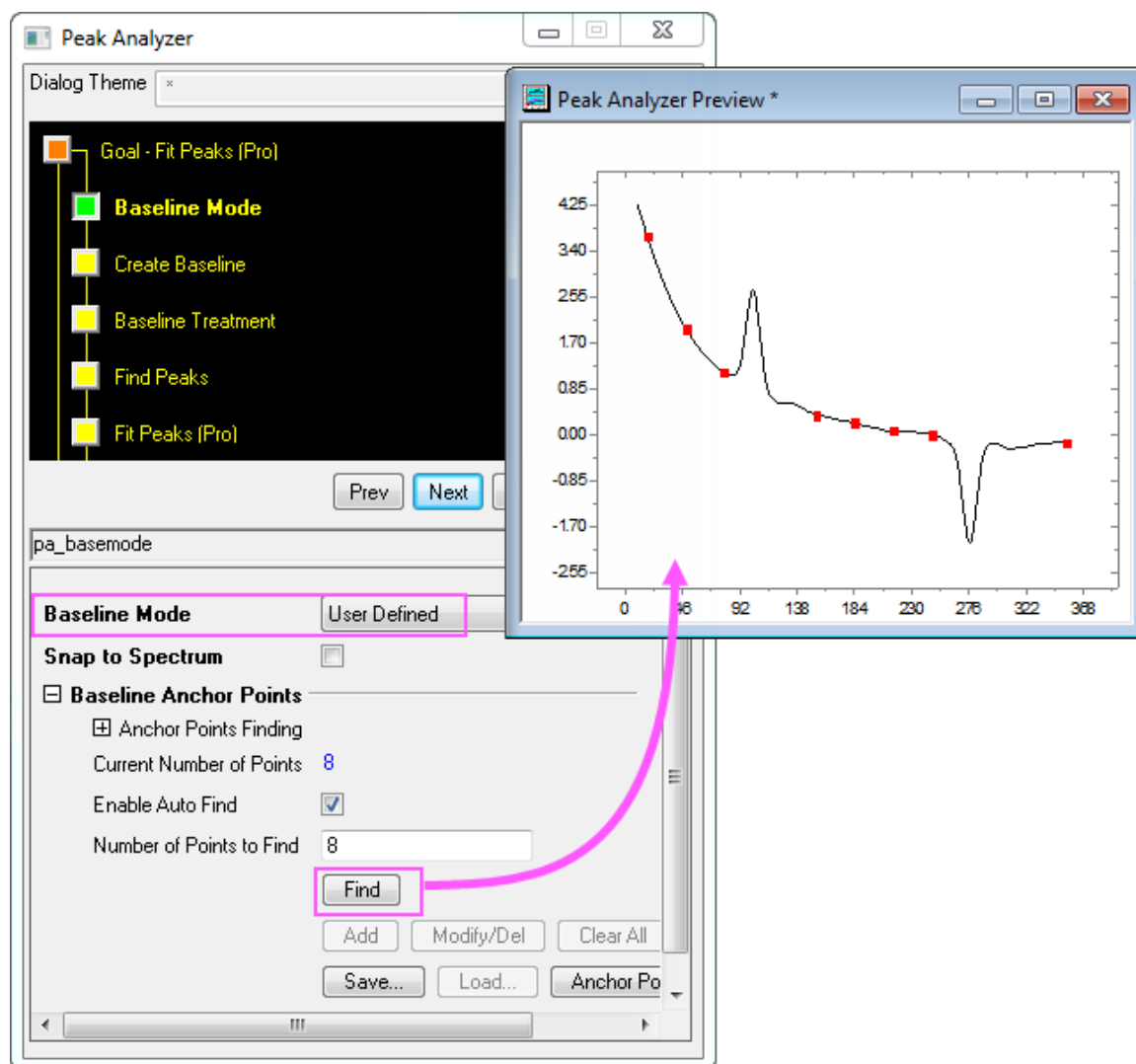

6. Click **Next** to go to the **Create Baseline** page. In the **Create Baseline** page, select **Fitting** with the **Connect By** drop-down list. In the **Fitting** group, select **ExpDec2** from the **Function** drop-down list.

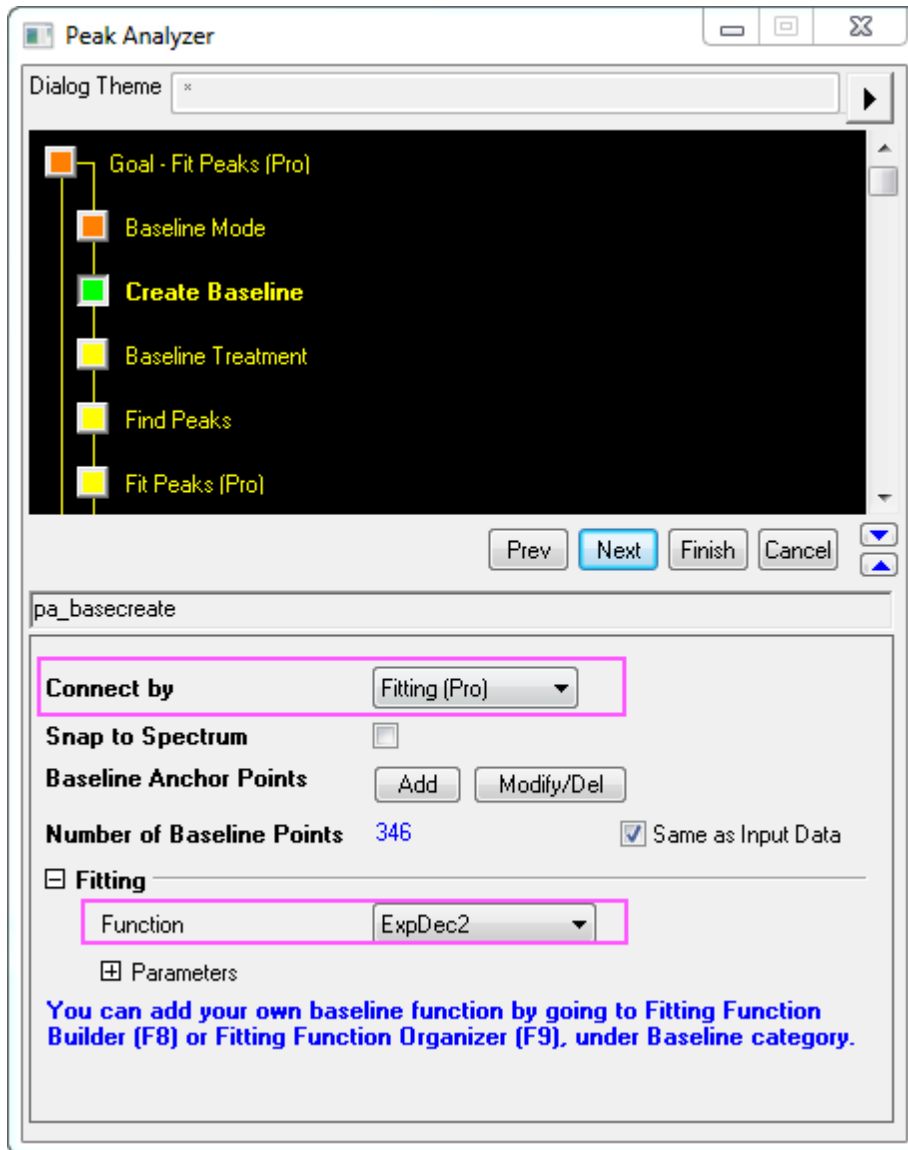

7. Click **Next** to go to the **Baseline Treatment** page. In the **Baseline Treatment** page, select the **Fit Baseline with Peaks** check box.

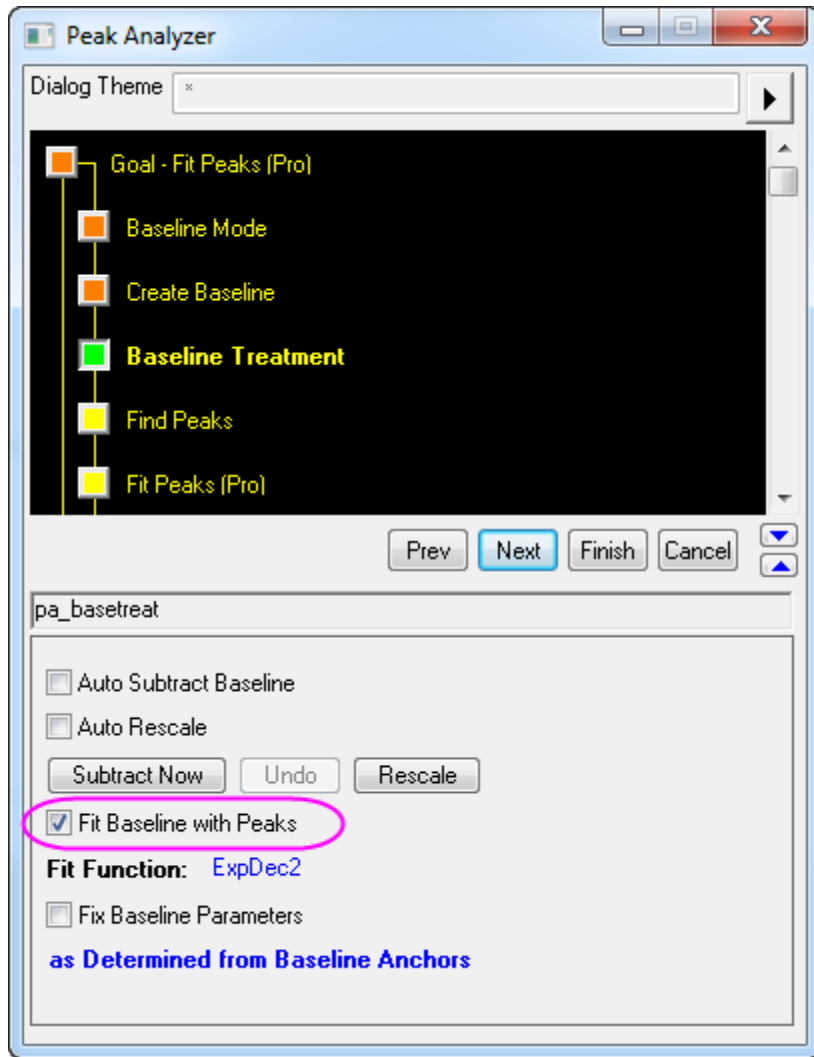

- Click **Next** to go to the **Find Peaks** page. In the **Find Peaks** page, click the **Find** button to search peaks. Two peaks should be found.

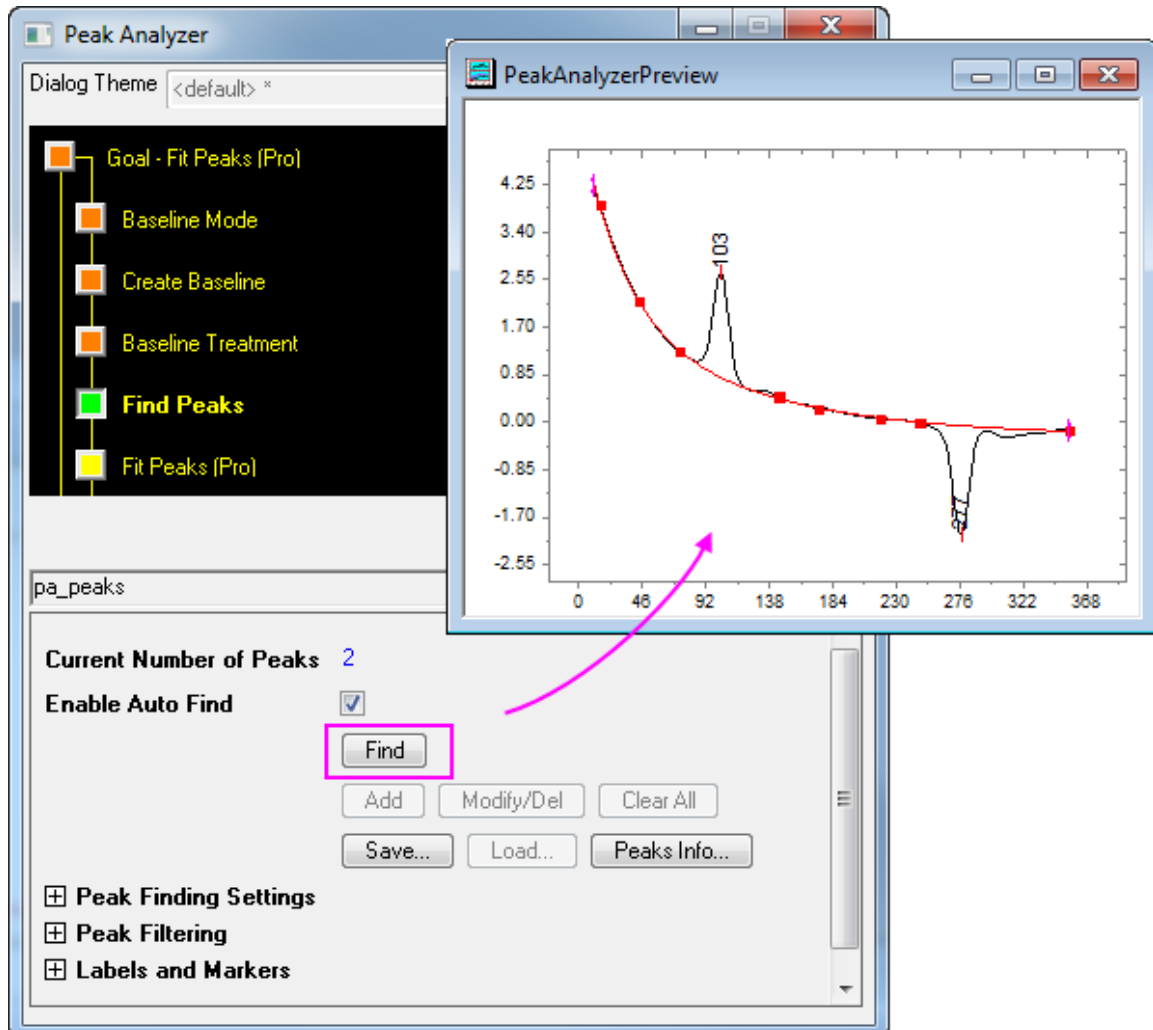

- Click **Next** to go to the **Fit Peaks** page. In the **Fit Peaks** page, click the **Fit Control** button to open the **Peak Fit Parameters** dialog.

- In the **Peak Fit Parameters** dialog, make sure that both peak types are Gaussian. Click the **Fit Until Converge** button.

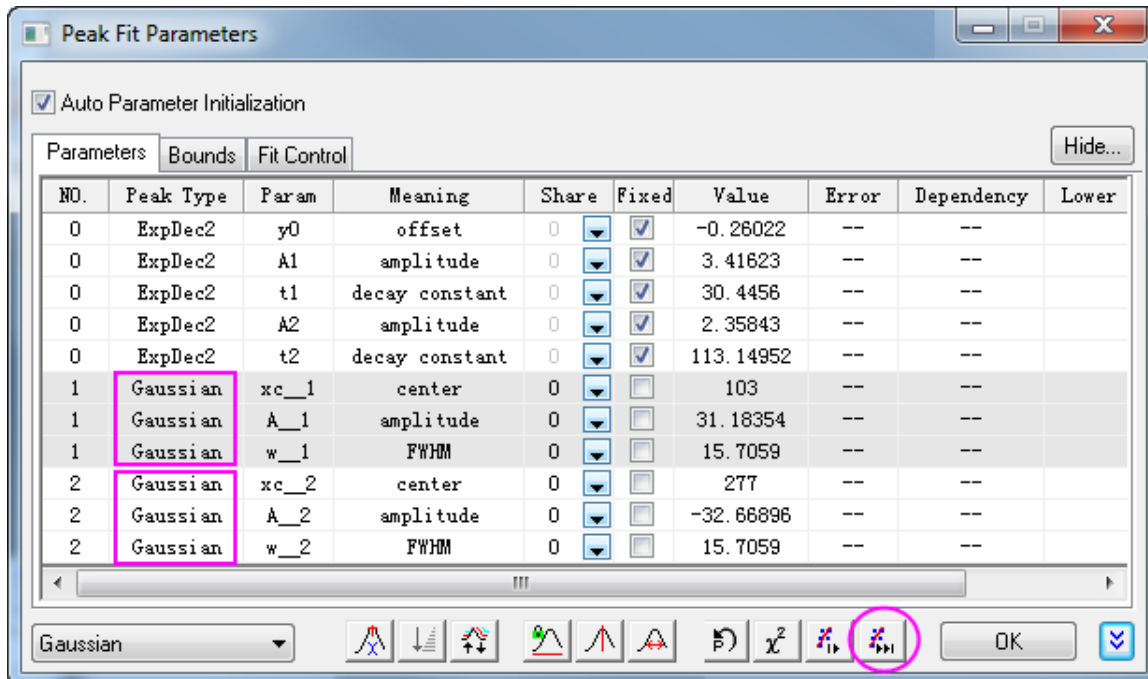

- When the fitting is done, click **OK** to close this dialog.
- Back to the **Fit Peaks** page, click **Finish** to complete the analysis. See the results in the source workbook and the graph report.

#### 4.5.8.3 Peak Fitting with Preset Peak Parameters

##### 4.5.8.3.1 Summary

In some cases, you may want to perform peak fitting with preset peak parameters. For example, you may have many datasets with fixed numbers of peaks and the centers of these peaks do not vary from dataset to dataset. What you are interested in is mainly other parameters of the peaks, for example, heights. Using the theme feature of the Peak Analyzer, you may carry out peak fitting with fixed peak parameters easily.

Minimum Origin Version Required: OriginPro 2016 SR0

##### 4.5.8.3.2 What You Will Learn

- How to save Peak Analyzer settings in a theme and reuse them
- How to fix peak parameters

##### 4.5.8.3.3 Steps

###### Save a theme with peak positions and peak parameters

- Start a new worksheet and import the file <Origin Program Folder>\Samples\Spectroscopy\HiddenPeaks.dat.



- Highlight the second column and select **Analysis: Peaks and Baseline: Peak Analyzer** from the Origin menu to open the **Peak Analyzer**.

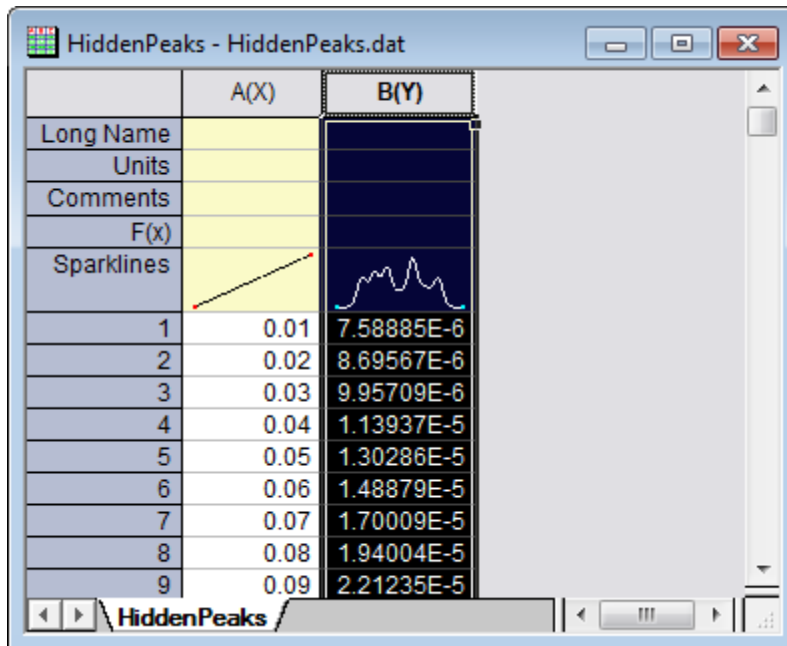

3. On the first page, select the **Fit Peaks** radio button in the **Goal** group. Click **Next** to go to the **Baseline Mode** page.

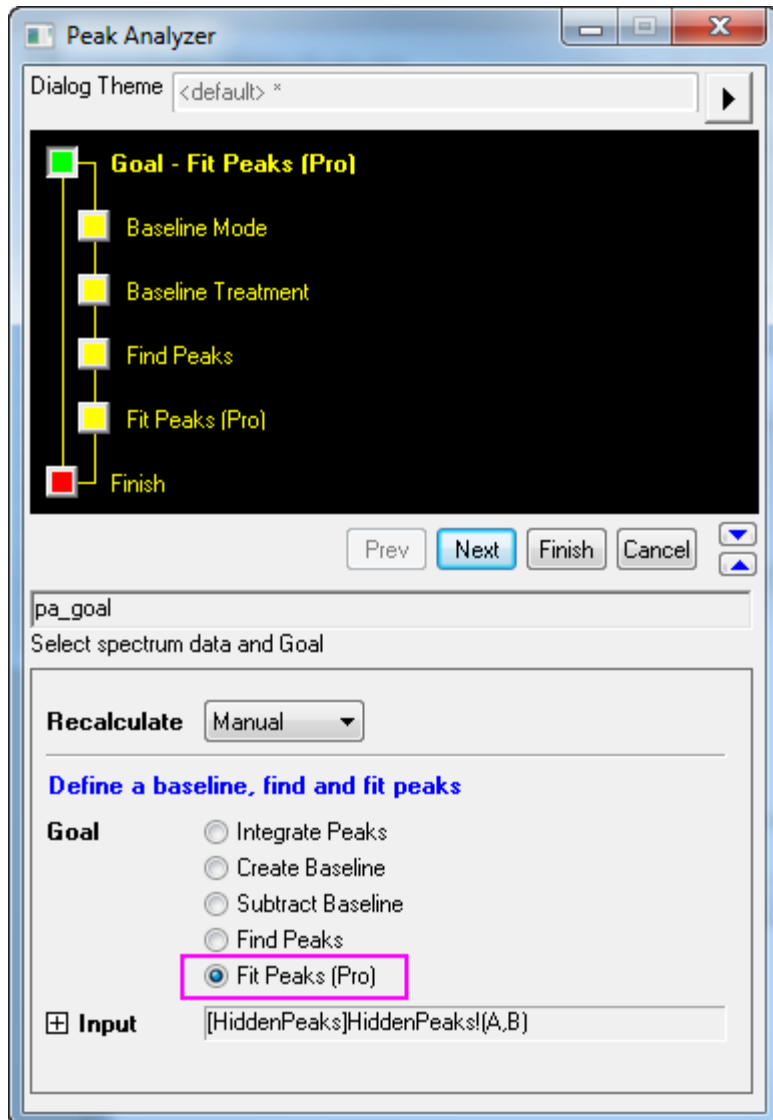

4. In the **Baseline Mode** page, select **None (Y=0)** with the **Baseline Mode** drop-down list. Click **Next** to go to the **Find Peaks** page.



5. In the **Find Peaks** page:

- a. Clear the **Enable Auto Find** check box, because we want to find the peaks manually. Click the **Peaks Info** button to open the **Peak Info** dialog.

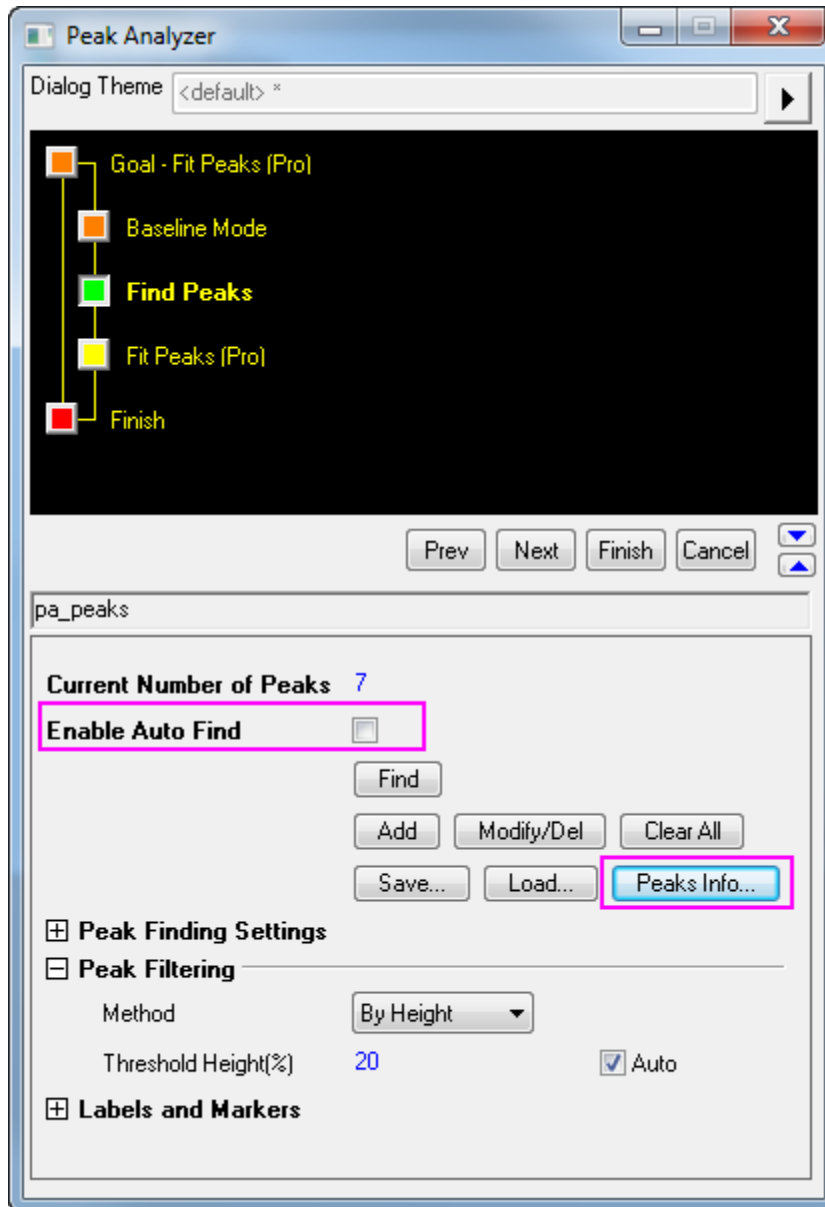

- b. In the **Peak Info** dialog, click the **Add** button seven times to add 7 peaks. Enter the peak centers and heights as follows:

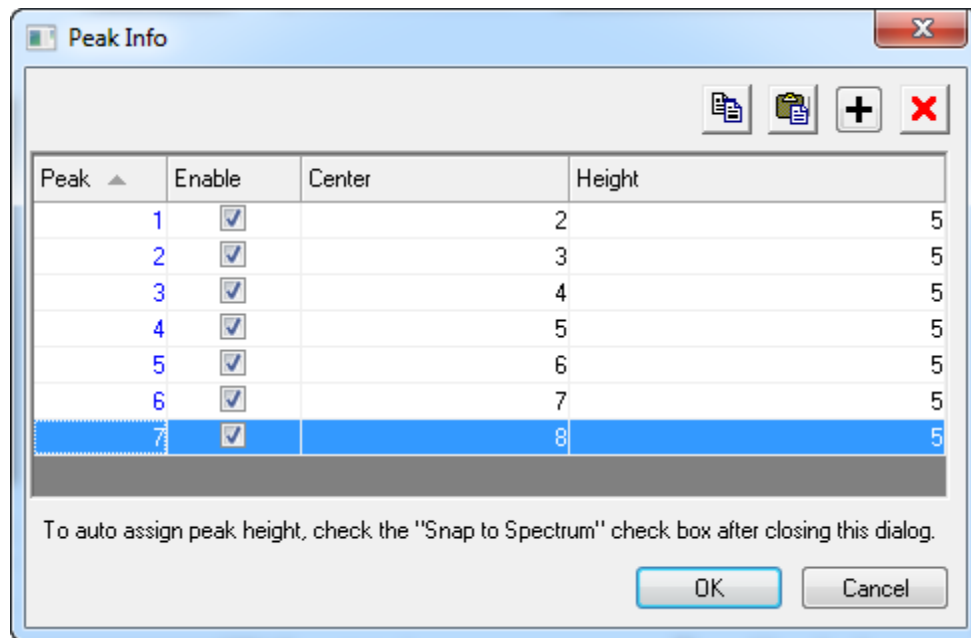

Click **OK** to return to the Peak Analyzer.

- c. Click **Next** to go to the **Fit Peaks** page.
6. In the **Fit Peaks** page:
- a. Click **Fit Control** to open the **Peak Fit Parameters** dialog.
  - b. In the **Peak Fit Parameters** dialog, click the **Fix or release all peak centers** button. Then click the **Fit Until Converge** button. When the fitting is done, click **OK** to return to the **Peak Analyzer** dialog.

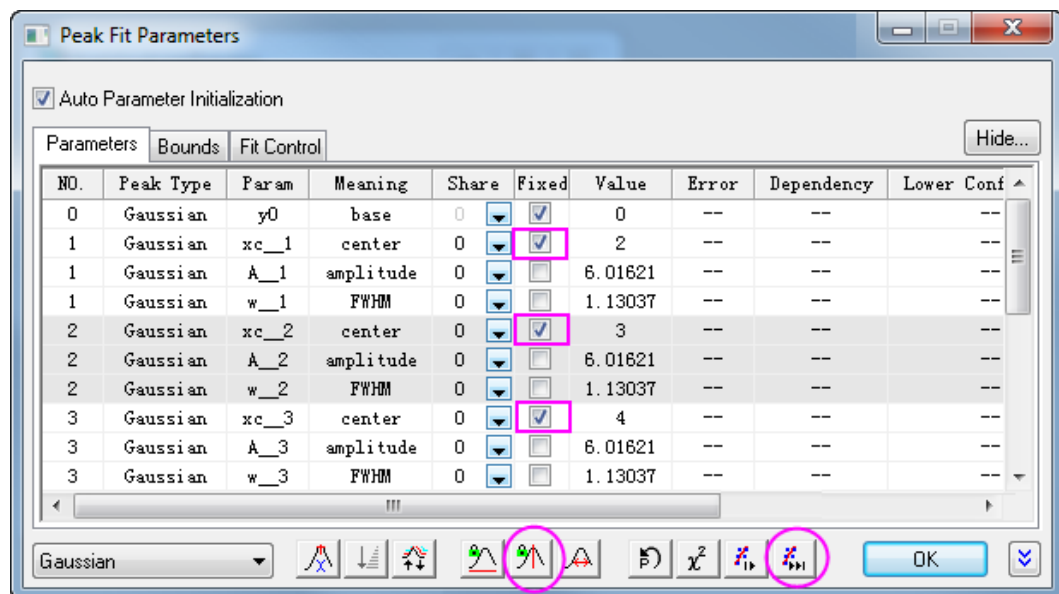

- c. Click the right-sided triangle button to the right of **Dialog Theme** in the upper panel. Select **Save As** from the short-cut menu. The **Theme Save as** dialog opens.
- d. In the **Theme Save as** dialog, enter **MyFitting** after **Theme Name**. Clear and select the check boxes as the screenshot below:

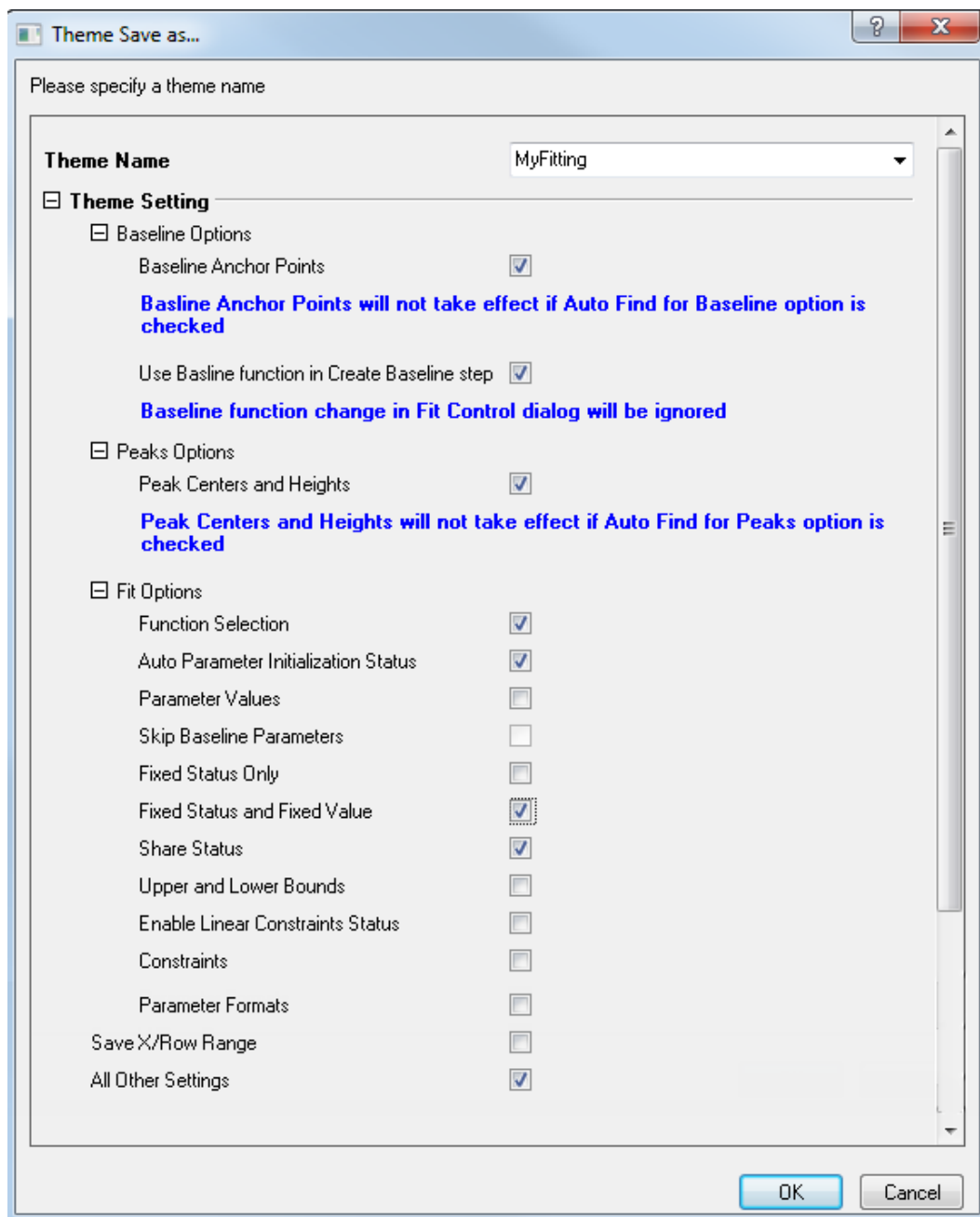

Click **OK** to save the theme. This should bring you back to the **Peak Analyzer** dialog.

- e. Click the **Finish** button in the **Peak Analyzer** to complete the analysis.

#### Reuse the theme

1. Start another new workbook and import the file <Origin Program Folder>\Samples\Spectroscopy\HiddenPeaks.dat.
2. Highlight the second column
3. Select **Analysis: Peaks and Baseline: Peak Analyzer** from the Origin menu to open the **Peak Analyzer** dialog.

- On the first page of the **Peak Analyzer**, click the right-sided triangle button to the right of **Dialog Theme**. From the short-cut menu, pick **MyFitting**.

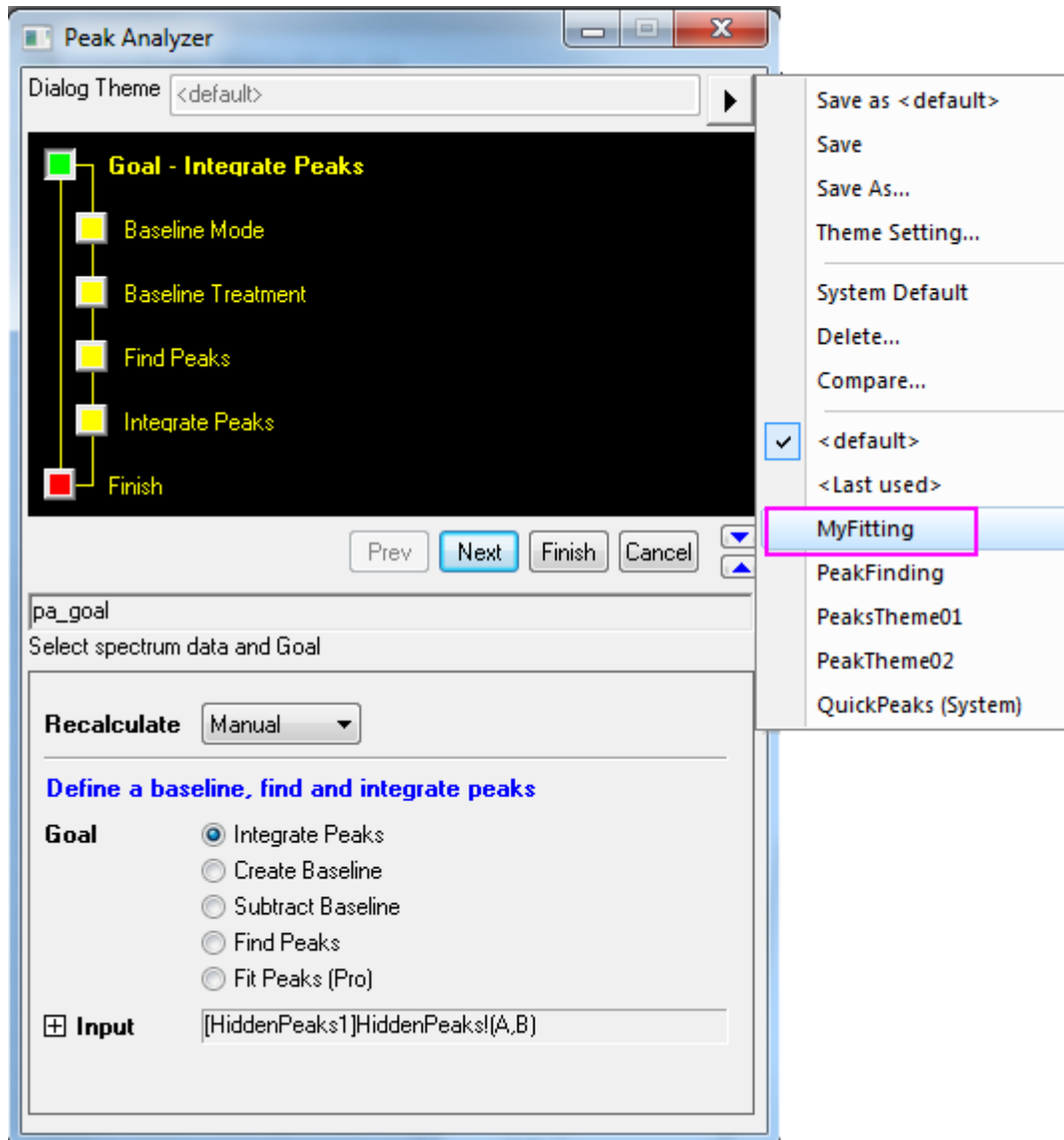

- Click **Next** to check if the settings in every step are correct. Note that in the **Find Peaks** page, you can see the peak centers and heights are same as last time.
- When you reach the last page, click the **Fit Control** button to open the **Peak Fit Parameters** dialog. Make sure that all peak centers are fixed and the values are the same as last time. Click **OK** to return to the **Peak Analyzer**.
- Click **Finish** to complete the analysis. Check the results to see whether they are the same as the results we got last time.

#### 4.5.8.4 Setting the Fix, Share Status or Bounds for Multiple Peak Parameters Simultaneously

##### 4.5.8.4.1 Summary

When performing peak analysis, one often wants to fix parameter values, or share parameters between multiple peaks, or specify bounds. If your data has a few peaks, you can simply perform these settings for each peak. But if your data has many, it may be time consuming to set individually. To make the process more efficient, the **Peak Analyzer** offers context menus which can allow you to set the fix, share status or bounds for multiple peak parameters simultaneously. For more details about these settings, please refer to the Origin Help File.

Minimum Origin Version Required: OriginPro 8.0 SR6

#### 4.5.8.4.2 What You Will Learn

- How to set share status of multiple peak parameters simultaneously.
- How to set upper bounds and upper bound values to multiple peak parameters simultaneously.

#### 4.5.8.4.3 Steps

1. Start a new workbook and import the file *<Origin Program Folder>\Samples\Spectroscopy\Positive & Negative Peaks.dat*.
2. Highlight the second column and select **Analysis: Peaks and Baseline: Peak Analyzer** to open the **Peak Analyzer** dialog. In the first page (the **Start** page), select the **Fit Peaks** radio button in the **Goal** group. Then press the **Next** button to go to the next page.
3. In the **Baseline Mode** page, select **Constant** with the **Baseline Mode** drop-down list and choose **Mean** in the **Constant** group. Then click **Fit Peaks** in the wizard map to directly go to the **Fit Peaks** page.



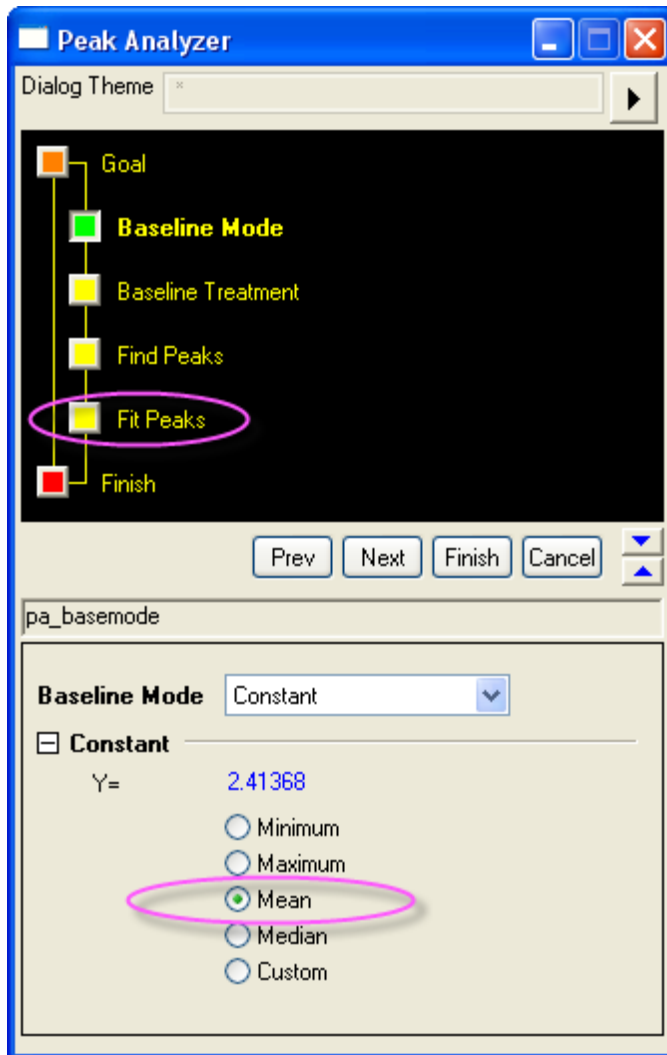

4. In the **Fit Peaks** page:
  1. click **Fit Control** button to open the **Peak Fit Parameters** dialog. In the lower left corner of the dialog, set the fitting function to **Voigt**.
  2. Make sure the **Parameters** tab is active and then select **1** in the **Share** column of the **wG\_1** row. Then right click on it and select **Apply Same "Share" to All wG**. Then you will find that all the parameters with the **wG** prefix are shared in the same group.

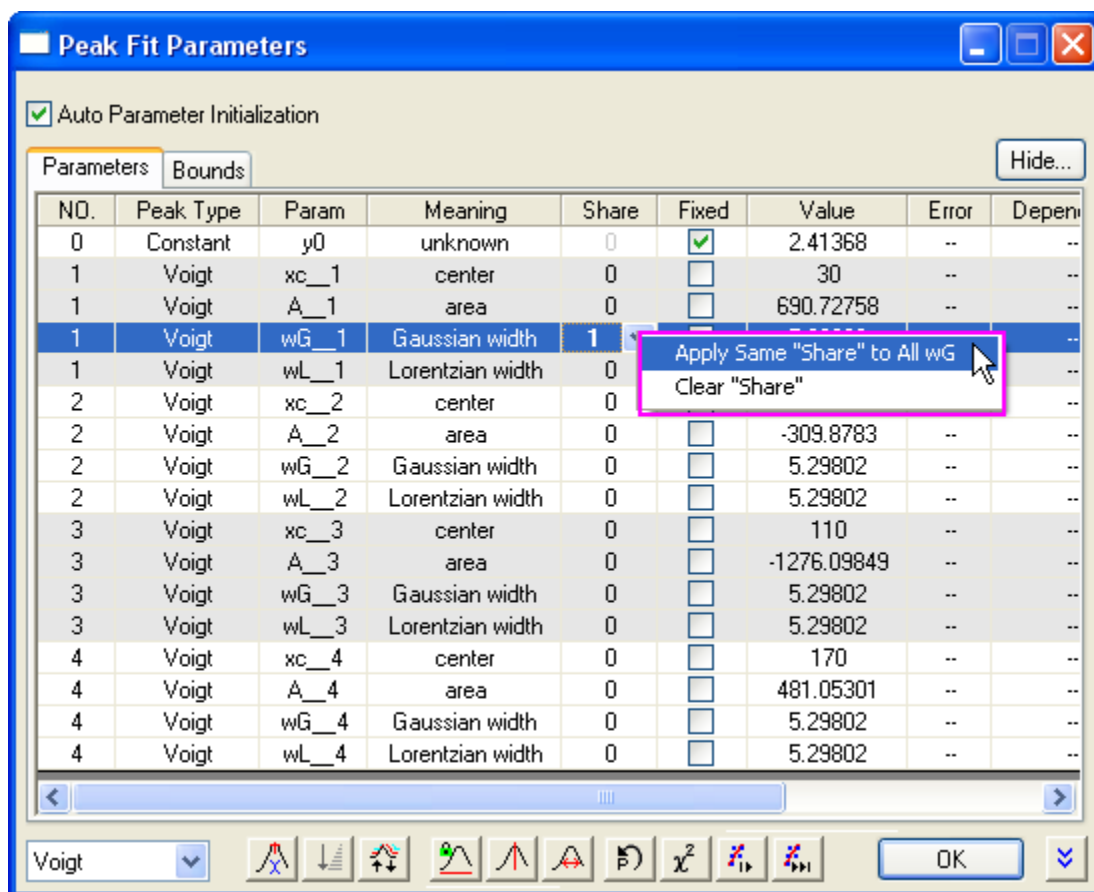

- Then select **2** in the **Share** column of the **wL\_1** row. Then right click on it and select **Apply Same "Share" to All wL**. Then you will find that all the parameters with the **wL** prefix are shared in the same group. After this, the **Parameters** tab should look like below:

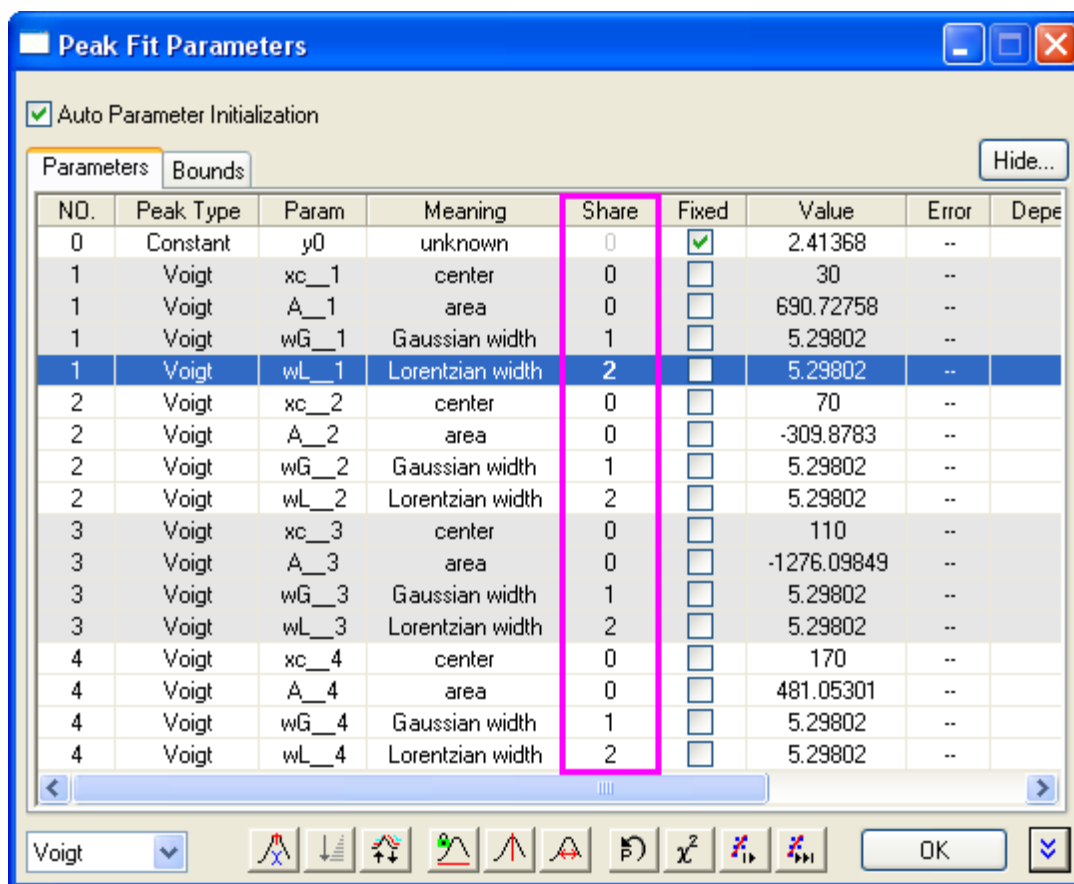

4. Activate the **Bounds** tab. Double-click in the cell in the first **Gaussian width** row and the second **< or <=** column. And you will find **<=** is shown in this cell (the **<** will be shown if you double-click in the cell for one more time). Then type **5** into the **Upper Bounds** column in the same row.
5. Then right click on it and select **Apply Same "Bounds" to All wG**.

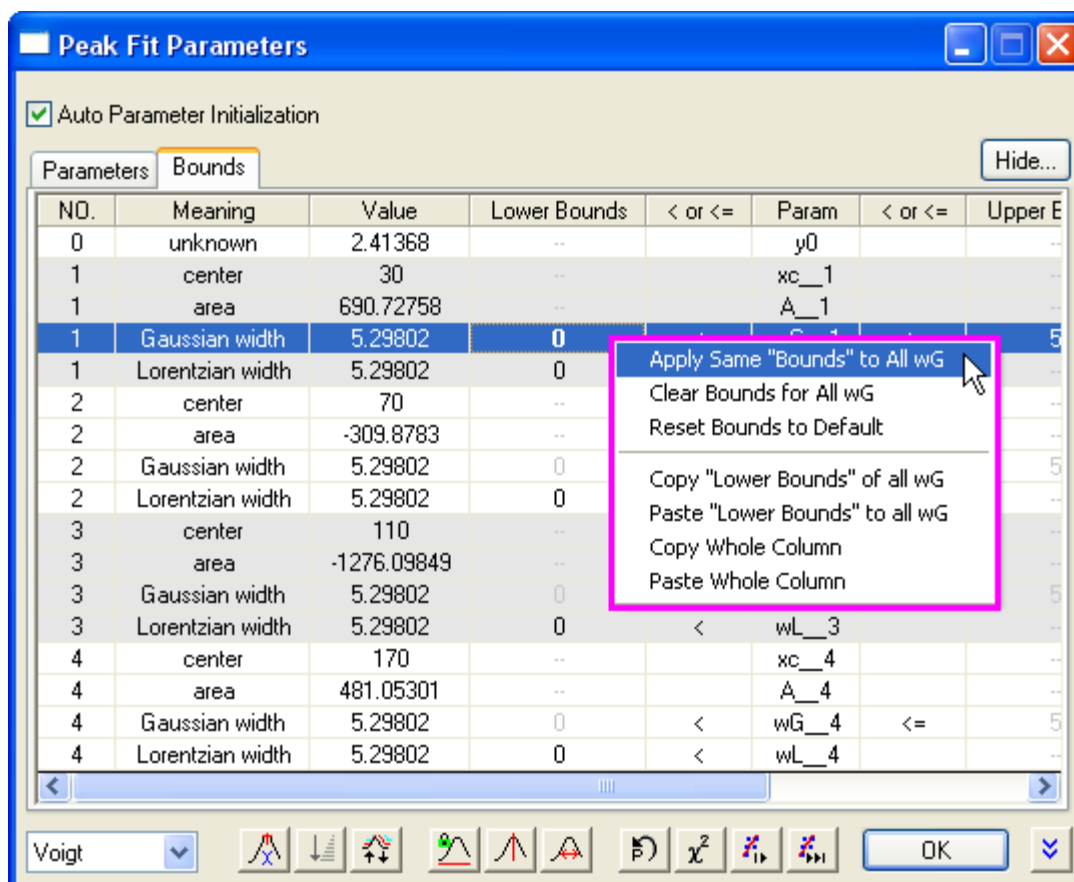

After this, the **Bounds** tab should look like:

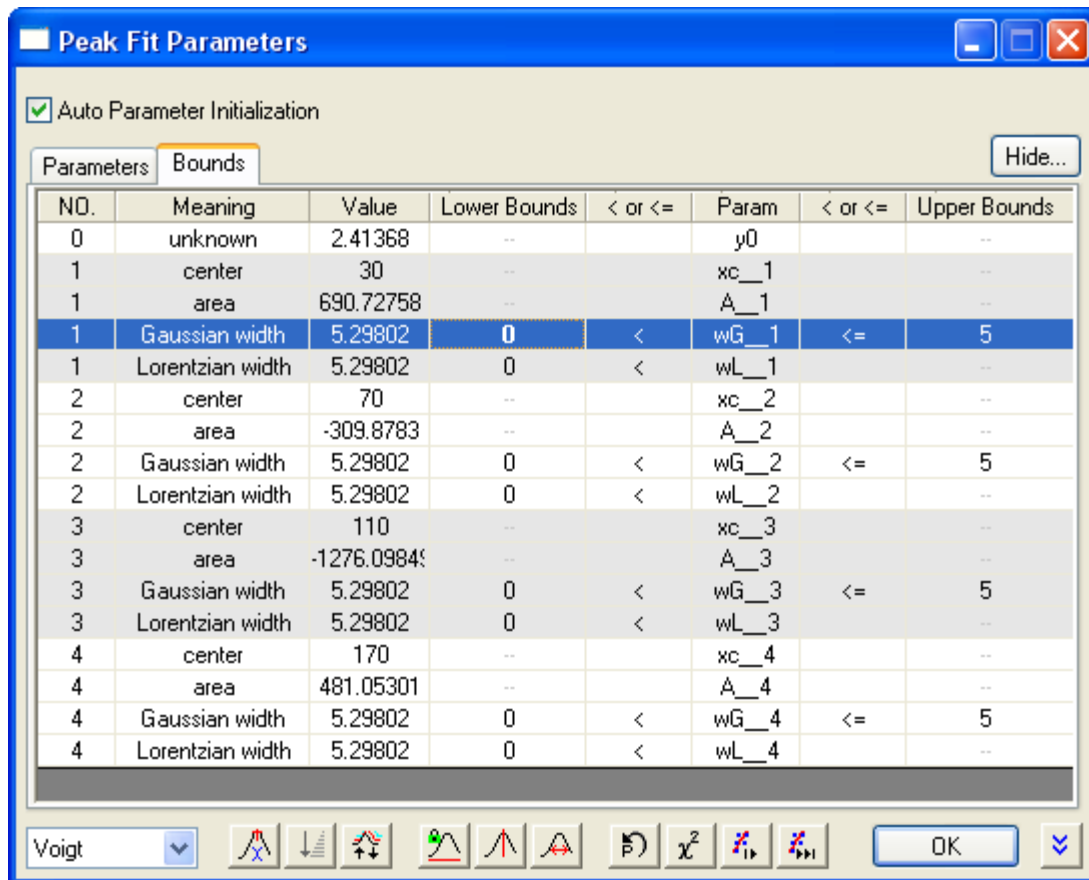

- Click the **Fit Until Converged** button. When the fitting is done, click **OK** to close the dialog.
- Back in the **Fit Peaks** page, click **Finish** to complete the analysis. See the results in the source workbook and the graph report.

## 4.6 Data Manipulation

### 4.6.1 Data Manipulation

#### 4.6.1.1 Setting Column Values

- [Set Column/Cell Values](#)

#### 4.6.1.2 Worksheet Data Operations

- [Worksheet Query](#)
- [Data Reduction](#)
- [Data Filter](#)

- [Lock Filter with Analysis](#)

#### 4.6.1.3 [Pivot Table](#)

#### 4.6.1.4 [Categorical Values Ordering and Sharing](#)

### 4.6.2 Setting Column Values

#### 4.6.2.1 [Setting Column Values](#)

- [Set Column/Cell Values](#)

#### 4.6.2.2 [Set Column/Cell Values](#)

##### 4.6.2.2.1 Summary

Origin provides several ways to fill a worksheet column with values. Use **Auto Fill** or script commands to fill a series of values. Use the **F(x)** row or the **Set Values** dialog box to define a mathematical formula to generate or transform a data set. Refer to values in other columns from the same sheet or from other sheets and books. Select from a large collection of built-in functions to compute values. Create variables from metadata stored in worksheets or column headers, and use these variables in your column formula.

This tutorial will show you how to compute column values by:

- Filling a Column with an Arithmetic Series
- Using Built-in Functions
- Using Other Columns
- Using Cell Values
- Using Variables from Workbook Metadata



Beginning with version 2018 SR0, Origin supports to [use a formula to set cell values](#).

Then, this tutorial will also show you:

- How to Enter Formula in worksheet cell to compute cell values
- Auto behaviors of setting cell values

##### 4.6.2.2.2 Setting Column values

###### Filling a Column with Arithmetic Series

Origin provides multiple methods to fill a column with arithmetic series.

## Using Auto Fill

1. Enter a few starting values in cells.

The screenshot shows an Excel window titled 'Book1' with a spreadsheet containing the following data:

	A(X)	B(Y)
Long Name		
Units		
Comments		
F(x)		
1	1	
2	3	
3		
4		
5		
6		
7		
8		
9		
10		

2. Select the two cells.
3. Move the mouse to the bottom right-hand corner of the second cell. The cursor will change to display "+".

The screenshot shows the same Excel window, but with the first two rows of data selected. A small black box with a white plus sign is visible at the bottom right corner of the second cell, indicating the start of an auto-fill operation.

4. Drag the mouse toward the bottom of the column. The column will be filled with 1, 3, 5, 7, ... .

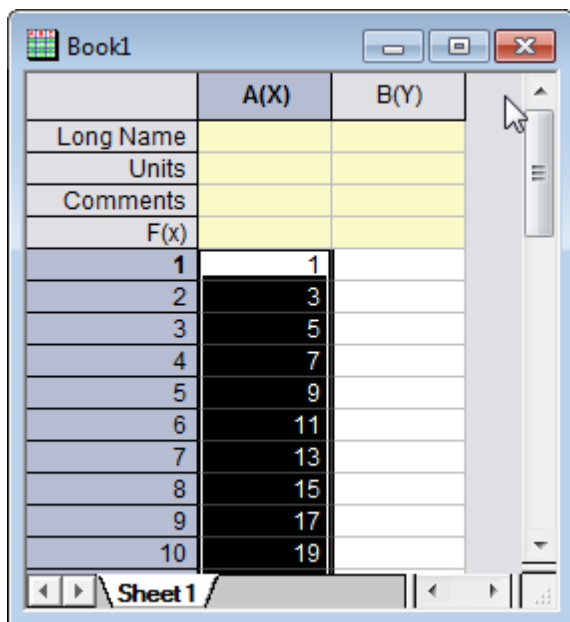

Note that a row can also be auto filled by dragging towards the right. In addition, to copy a *sequence* of cell values to other column or row cells, press SHIFT while selecting the desired sequence, then press CTRL and drag.

Using Filling A Set of Numbers

1. Right click on the column B and select **Fill Column with: A Set of Numbers** from the context menu to bring up the **PatternN** dialog
2. Enter 23 in the *To* edit box. Enter 2 in the *Increment* edit box

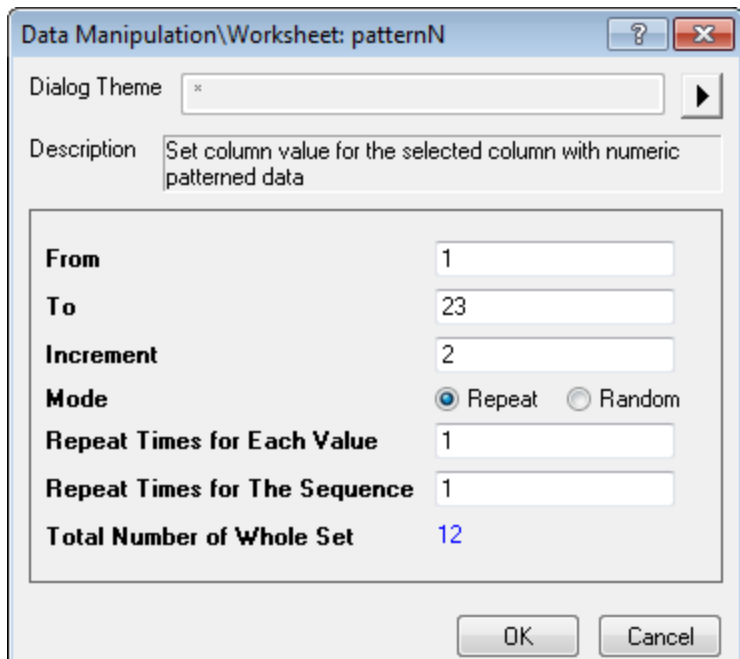



- After you click the **OK** button, Column B will be filled with values: 1, 3, 5, 7, ..., 23

#### Using Other Columns

We will show you how to enter expressions in the **F(x)** row to set column values.

- Create a new workbook. Import US Metropolitan Area Population.dat from the **\Samples\Data Manipulation\** folder.
- Add a new column to the worksheet (right-click to the right of the last column in the worksheet and select **Add New Column** from the context menu). Change the Long Name of the column to *Population/Sq. Mi.*
- To calculate the population density, enter the expression, **B/A**, in the F(x) row of column E.

	A(X)	B(Y)	C(Y)	D(Y)	E(Y)
Long Name	Population	Sq. Mi.	Density	Metropolitan Area	Population/Sq. Mi
Units					
Comments					
F(x)=					A/B
Sparklines					
1	119655	915.7	130.7	Abilene, TX	130.67053
2	112561	685.5	164.2	Albany, GA	164.20277
3	874304	3248.5	269.1	Albany-Schenectady-Troy, NY	269.14083

- The column will get computed using data from the other two columns.

#### Using Built-in Functions

- Create a new workbook. Import *Step Signal with Random Noise.dat* from the **\Samples\Signal Processing\** folder. We are going to calculate the moving average of column B, that is, calculating the adjacent average value at each point of column B.
- Click the **Add New Columns** button  on the Standard toolbar to add a new column C. Highlight this column and right-click, and then click **Set Column Values...** to open the **Set Values** dialog.

- In **Set Values** dialog, click the **Search and Insert Functions** button  to search for keyword *adjacent average*.

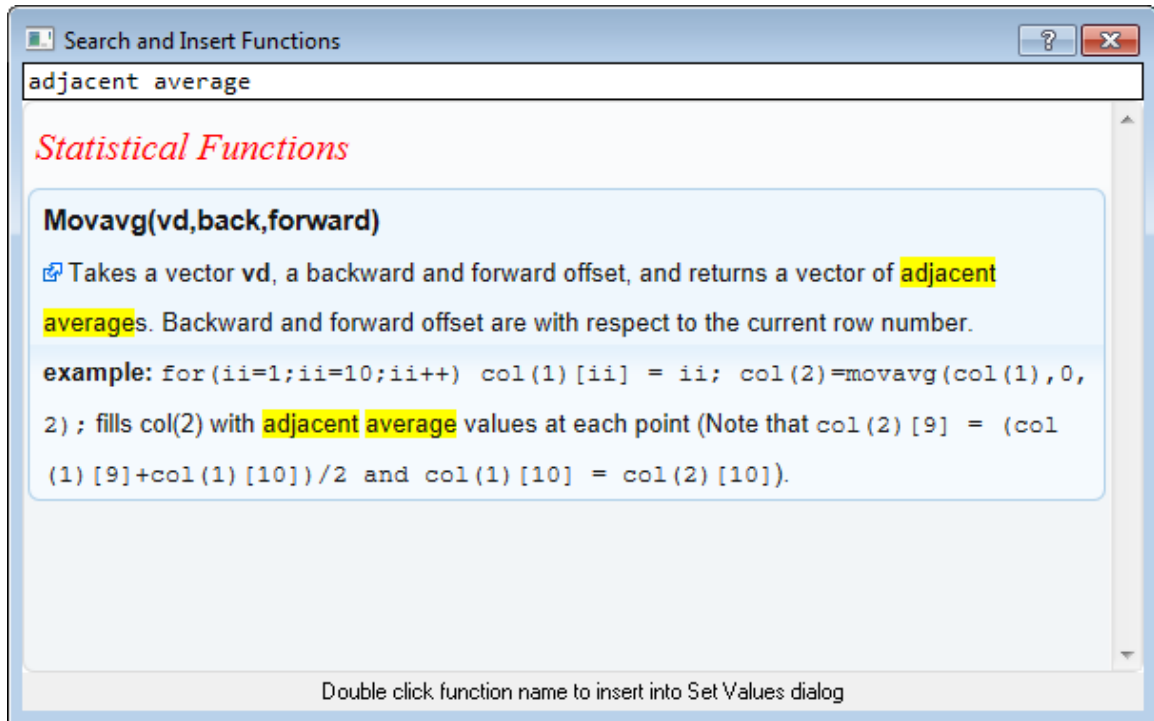

- Double click function name **Movavg(vd,back,forward)** to insert it into dialog and close the dialog.

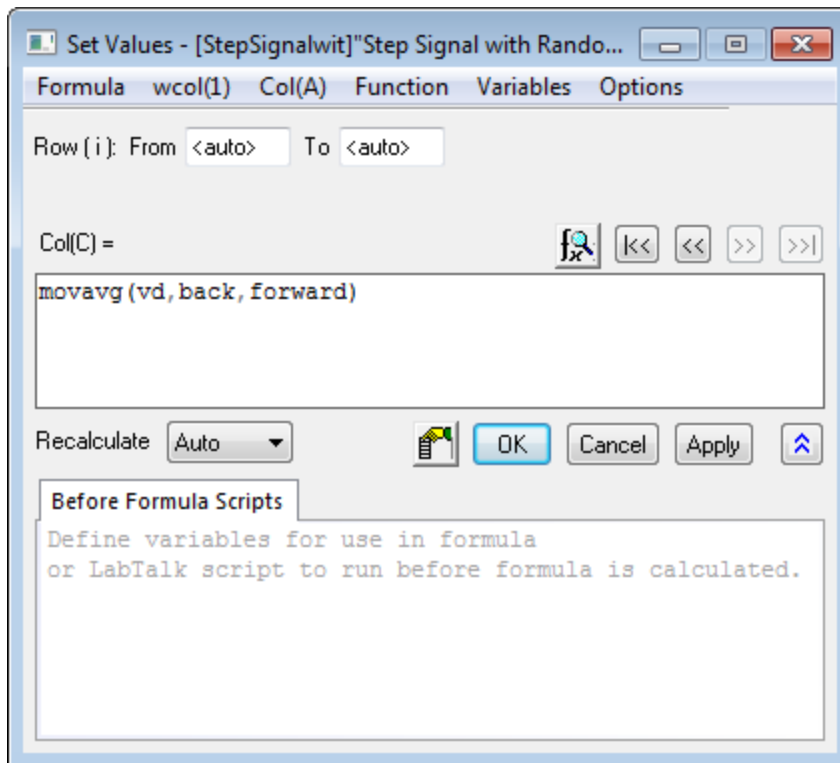

5. Highlight the characters **vd**. replace **vd** with **B**, replace **back** with **0** and replace **forward** with **2**. Your formula should look like this:

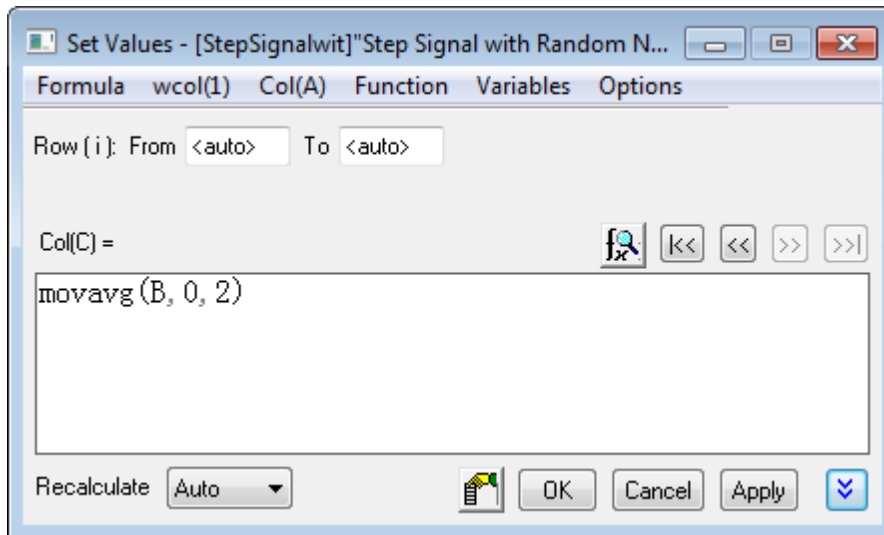

6. Click **OK**. The last column will fill with the moving average from column B.

	A(X)	B(Y)	C(Y)
Long Name	time	signal with noise	
Units			
Comments			
F(x)=			movavg(B,0,2)
Sparklines			
1	1	-0.08277	-0.00402
2	2	0.02274	-0.0171
3	3	0.04798	0.00562
4	4	-0.12202	-0.01639
5	5	0.09091	-0.04684
6	6	-0.01806	-0.10784
7	7	-0.21336	-0.04822
8	8	-0.09209	0.02915
9	9	0.1608	0.0521
10	10	0.01875	-0.01983



When referring to another column in the same worksheet, you can use index (e.g. "col(1)"), short name (e.g. "A" or "col(A)"), or long name (e.g. "signal with noise") to identify the column.

#### Using Columns from Other Sheets

The **Set Values** dialog provides an **Variable** menu to easily insert range variables that point to columns in other books/sheets, which can then be used to compute column values for the current column.

1. Open the project `\Samples\Data Manipulation\Setting Column Values.opj` and click on the **Columns from Other Sheets** subfolder.
2. In the workbook, right-click on the worksheet tab labelled **Sample** and select **Duplicate Without Data**. Rename (by double-clicking on the current name) the new sheet as: **Corrected Sample**.
3. Now you will fill these three columns with data based on formulas that reference columns in the other sheets. Highlight the first column and right-click on it to select **Set Columns Values** to open the dialog. Select **Variables: Add Range Variable by Selection** to open the **Select from Worksheet** dialog. With this dialog, you could select a column from worksheet and insert it as a range variable to the **Before Formula Script** panel.
4. When the **Select from Worksheet** dialog is open, activate the **Sample** sheet, highlight column A to select and click the **Done** button to confirm selection and click **OK** (accept *Column Notation*) in the **Insert Mode** dialog box that appears.
5. "range rTime = Sample!Col(A);" will be automatically inserted into the **Before Formula Scripts** panel. Edit the formula to read as:

```
range rTime = Sample!Col(A);
```

6. Then enter **rTime** in the **Column Formula** and click the **OK** button to generate data for the first column and close the dialog.

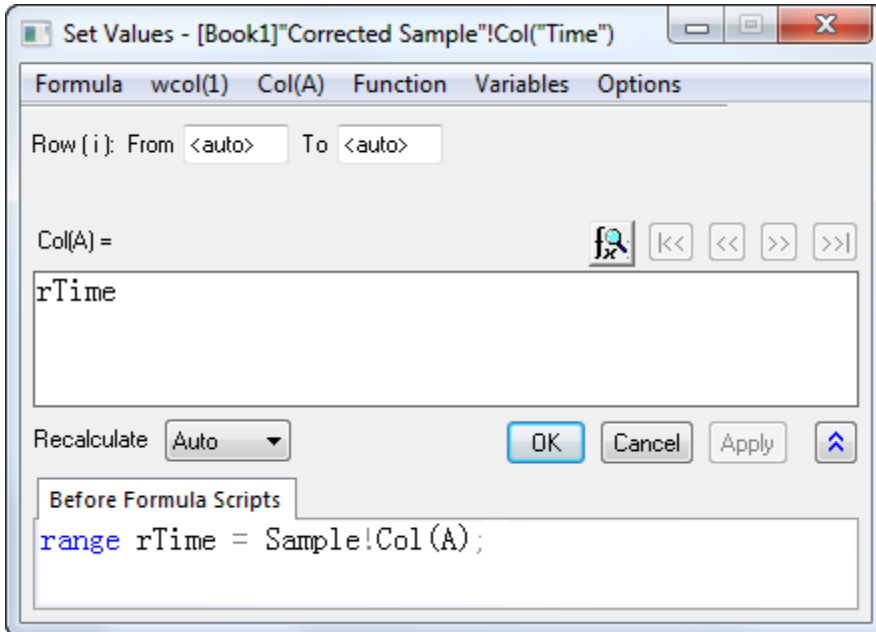

7. In the **Corrected Sample** worksheet, highlight column B and column C and right-click on them. From the shortcut menu, select **Set Multiple Column Values** to open the dialog. Select **Variables: Add Range Variable by Selection** and insert two range variables, one by one, to the **Before Formula Script** panel similarly as the previous steps. Edit these new entries as follows:

```
range rSample = Sample!Col(B);
```

and

```
range rRef = Reference!Col(B);
```

8. Now we will edit the range variables in the **Before Formula Scripts** panel and use another expression to get the same results. Remove the column names **Col(B)** of the two range variables and select **Variables: Predefined Variables: wcol(j)** in both lines so it looks as follows:

```
range rSample = Sample!wcol(j);
```

---

```
range rRef = Reference!wcol(j);
```

10. Then input the following expression into the **Column Formula**:

```
rSample - (rSample[1] - rRef[1])
```

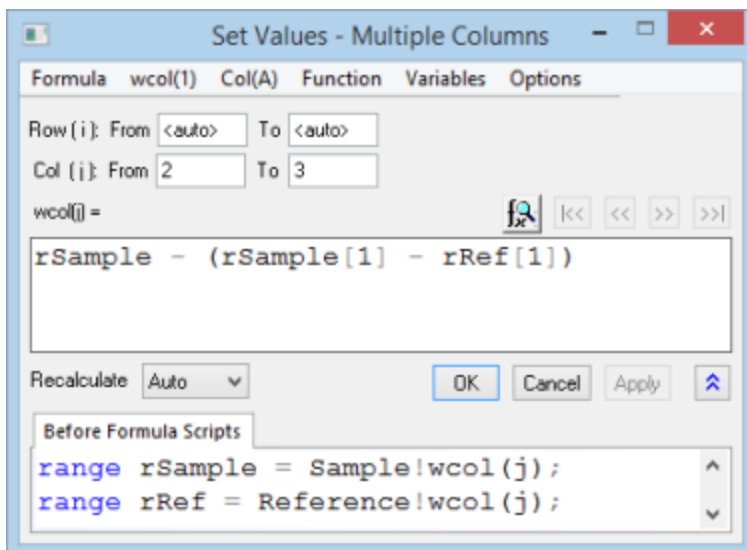

11. Click the **OK** button to generate data for the column B and column C of the **Corrected Sample** worksheet.

	A(X)	B(Y)	C(Y)
Long Nam	Time	Transducer 1	Transducer 2
Units	sec	mV	mV
Sparklines			
F(x)	rTime	rSample - (rSample[1] - rRef[1])	
1	0	20.41	8.23
2	1	19.99	8.17
3	2	20.54	8.17
4	3	20.84	8.21
5	4	20.47	8.16
6	5	21.13	8.16
7	6	20.41	8.05
8	7	20.25	8.11
9	8	20.02	7.96
10	9	20.15	7.95
11	10	20.62	7.98



1. You reference a particular cell value with square brackets, so [1] in the Column Formula expression above means the first element.
2. You can select **Formula: Save** and **Formula: Load** in the **Set Column Values** dialog to save your formulas and reload them into other columns to generate new data.

### Using Cell Values

Values contained in specific worksheet cells can be referenced and used to compute the formula for setting column values. This provides an easy way to use worksheet cells as control cells for updating values in a column.

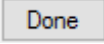
1. Open the project `\Samples\Data Manipulation\Setting Column Values.opj` and switch to the **Cells in a Worksheet** subfolder in Project Explorer.
2. Right-click on column C and select the **Set Column Values...** context menu to bring up the Set Values dialog.
3. Use the **Variables: Add Range Variable by Selection** menu item to open the **Select from Worksheet** dialog. Then select column G(Value) in this worksheet, click the  button. Click **OK** when the **Insert Mode** dialog appears (accept **Column Notation**) to add its expression to the **Before Formula Scripts** panel.
4. In the **Before Formula Scripts** panel, change the name of the range variable to be **rControl** and add these additional lines so that the script looks like below

```
range rControl = Col(G);

//range r1 = Col(7);

int nOrder = rControl[2];

int nPoints = rControl[3];

differentiate -se iy:=(1,2) order:=1 smooth:=1 poly:=nOrder npts:=nPoints
oy:=(1,3);
```

The script calls the **differentiate** X-Function and passes the cell values from column G as arguments for polynomial order and number of points, which controls the Savitzky-Golay smoothing performed during the differentiation.

5. The **Set Values** dialog then should be as following:

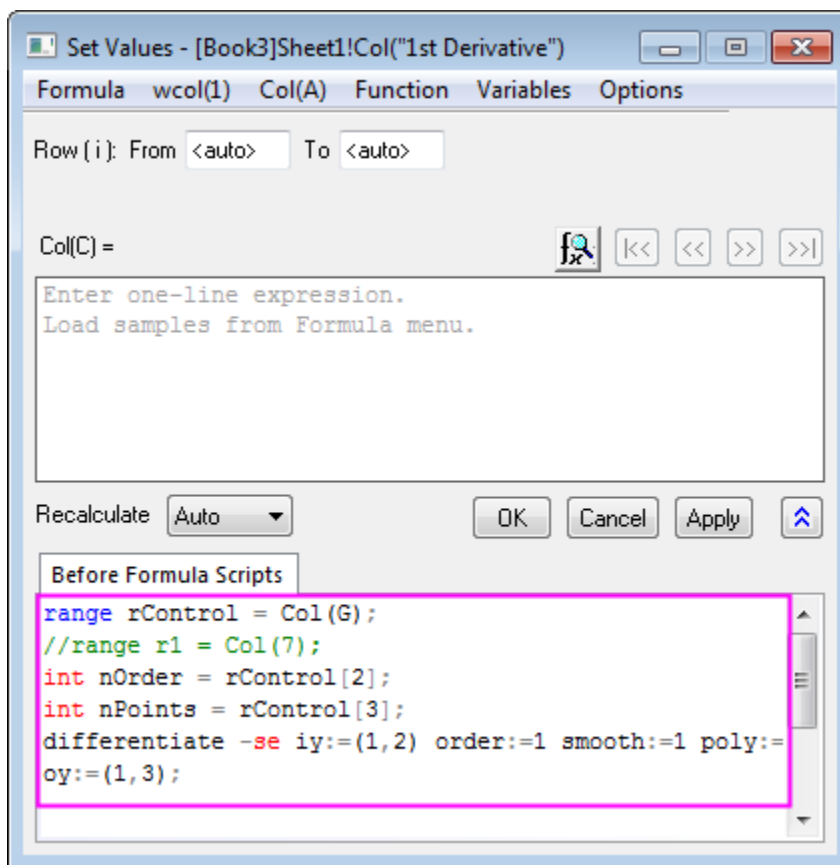

6. Click **OK** to close the dialog and see the results in column C. Now you can try to change the values in column G, to change the output.

Note: Allowed values of polynomial order are 1 to 9.



The graph shown in the worksheet was first created and then embedded into the worksheet by merging a group of cells.

#### Using Variables from Workbook Metadata

Metadata stored in the workbook, such as variables saved when importing data using the Import Wizard, can be referenced and used for computing column values.

1. Open or continue working with **\Samples\Data Manipulation\Setting Column Values.OPJ**, and switch to the **Worksheet Metadata** subfolder from the Project Explorer window.
2. Select column A and right-click to select the **Insert** menu option. A new column is inserted to the left of column A.
3. Select the first column (this newly inserted column) and right-click on it. Then select the **Set Column Values** menu item to open the Set Values dialog.



- Select the **Variables: Add Info Variable** menu item to open the **Insert Variables** dialog. Select **Numeric int** from the **Variable Type** drop-down list. Expand the USER.VARIABLES node and click to highlight **NUMBEROFPOINTS** row with **Value** as **3800**. Press the **Insert** button to insert this variable into the **Before Formula Scripts** panel.

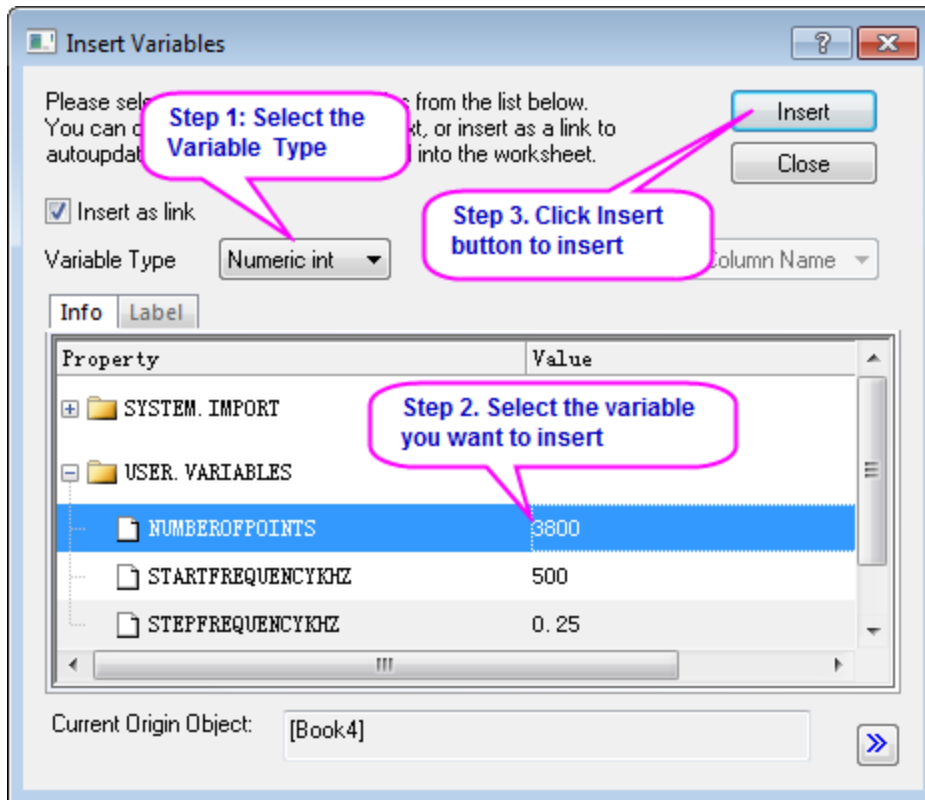

- Next, set **Variable Type** to **Numeric double**. Hold the **Shift** key down to select both **StartFrequencyKHz** and **StepFrequencyKHz**, and then press **Insert** to insert these two variables. Press the **Close** button to close the dialog.
- In the upper **Column Formula** panel, input **{d1:d2:d1+(n1-1)\*d2}** and then press the OK button to generate data and close the dialog. The column will be filled with frequency values.
- Highlight the first and second columns, right-click on them and select **Set As: XYY** to change the plotting designations to X and Y. After you change the long name of the first column to **Frequency**, the worksheet

should look like:

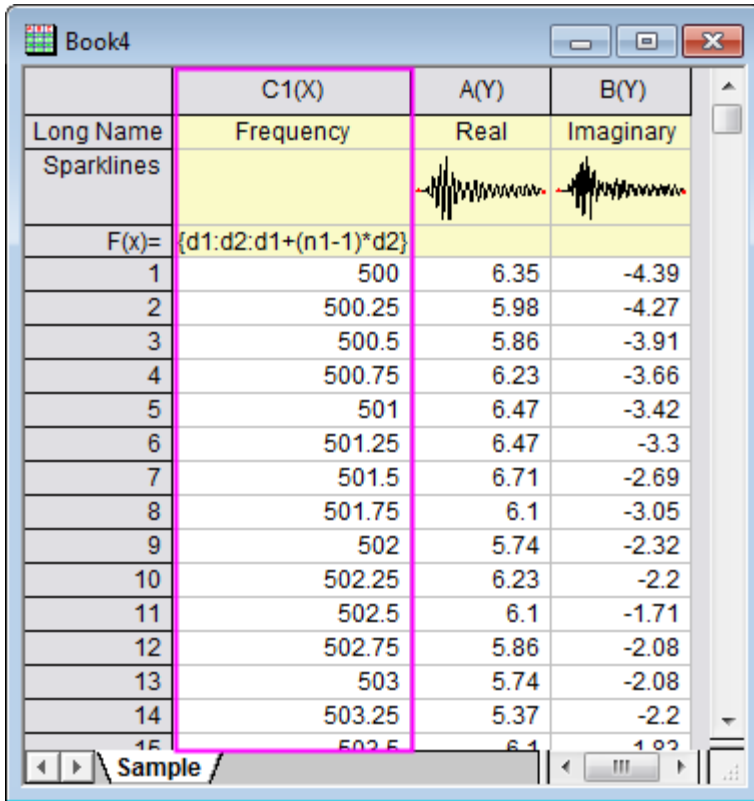

#### 4.6.2.2.3 Setting Cell Values

In the Cell-Edit Mode, you can enter a cell formula beginning with an equals sign "=" into a cell (a data cell or UserDefined Parameter Row cell) just as below.

Morning	Evening	Stats	
(°F)		Morning	Evening
		<code>=count(A,1)</code>	55
97.09975	97.08043	98.23468	98.15735
97.2	97.09497	0.4952297	0.50379
97.29991	97.46701		
97.40002	97.53114		
--	97.51223		
--	97.40901		

Once the formula has been entered, you exit edit mode (in-place edit or **Edit: Edit Mode**) to see the resulting cell value.

Let us use an example to show you how cell formulas work in Origin:

1. Open a new workbook in your Origin Project.

- Import the sample data "automobile2.dat" located at the folder <Origin Program Folder>Samples\Statistics into the workbook.

	A(X)	B(Y)	C(Y)	D(Y)	E(Y)	F(Y)	G(Y)	H(Y)	I(Y)
Long Name	Year	Make	country	luxury	Power	0-60 mph	Weight	Gas Mileage	Engine Displacement
Units					kw	sec	kg	mpg	cc
1	1992		US	N	132	14	2238	11	5736.5
2	1992	Acura	Japan	Y	154	12	2324	11	5212
3	1992	GMC	US	N	158	13	1531	10	5900.4
4	1992	Chrysler	US	N	132	10	2088	12	6277.4
5	1992	Kia	Korea	N	121	12	1202	12	5736.5
6	1992	Suzuki	Japan	N	106	10	1417	14	5736.5
7	1992	Volvo	Sweden	Y	95	14	1661	13	5031.7
8	1992	Mercedes	Germany	Y	132	14	2208	12	5736.5
9	1992	Acura	Japan	Y	128	13	1412	12	5736.5

- Right-click on the header cell of column label row "F(x)=" and select **Add User Parameters** from the context menu to add a user parameter.

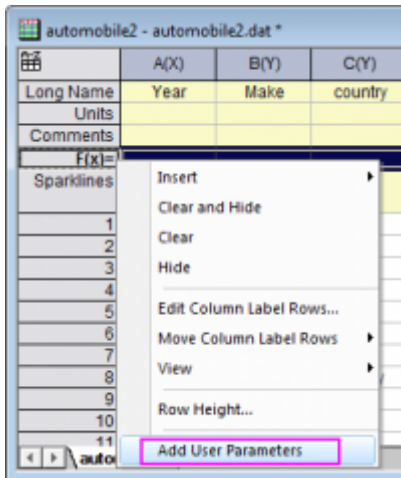

- Here, let's add two user parameters and enter *Mean* and *Std Dev* as their parameter names separately. And then, add one more column at the end of this worksheet, enter *Power/Engine Displacement* as the column Long Name.

	A(X)	B(Y)	C(Y)	D(Y)	E(Y)	F(Y)	G(Y)	H(Y)	I(Y)	J(Y)
Long Name	Year	Make	country	luxury	Power	0-60 mph	Weight	Gas Mileage	Engine Displacement	Power/Engine Displacement
Units					kw	sec	kg	mpg	cc	
F(x)=										
Std Dev										
Mean										
Sparklines										
1	1992		US	N	132	14	2238	11	5736.5	
2	1992	Acura	Japan	Y	154	12	2324	11	5212	
3	1992	GMC	US	N	158	13	1531	10	5900.4	
4	1992	Chrysler	US	N	132	10	2088	12	6277.4	
5	1992	Kia	Korea	N	121	12	1202	12	5736.5	
6	1992	Suzuki	Japan	N	106	10	1417	14	5736.5	
7	1992	Volvo	Sweden	Y	95	14	1661	13	5031.7	
8	1992	Mercedes	Germany	Y	132	14	2208	12	5736.5	
9	1992	Acura	Japan	Y	128	13	1412	12	5736.5	

- Select **Edit: Edit Mode** menu to switch to the Edit Mode. And then, in the cell *Mean* and *Std Dev* of Col("Power"), enter `=mean(this)` and `=stddev(this)` respectively. Once the edit done, click outside the cell

to exit cell-edit mode reselect the **Edit: Edit Mode** menu item to display cell formula results.

	A(X)	B(Y)	C(Y)	D(Y)	E(Y)	F(Y)	G(Y)
Long Name	Year	Make	country	luxury	Power	0~60 mph	Weight
Units					kw	sec	kg
Comments							
F(x)=							
Std Dev					=stddev(This)		
Mean					79.85		
Sparklines							
1	1992		US	N	132	14	2238
2	1992	Acura	Japan	Y	154	12	2324
3	1992	GMC	US	N	158	13	1531
4	1992	Chrysler	US	N	132	10	2088
5	1992	Kia	Korea	N	121	12	1202

**Note:** About the meaning of the variable "This", please refer to [this page](#).

- Click the cell *Mean* of Col("Power") to select it, put the cursor to the lower right corner of this cell. When the cursor turns to a cross +, grab this "+" handle and drag with your mouse horizontally to Col("Engine Displacement"). Release the cursor, you will find other cells of this row will be filled with some result values. Alternately, you could simply double-click on the "+" handle and copy the formula to all *Mean* row cells to the right of Col("Power").

	A(X)	B(Y)	C(Y)	D(Y)	E(Y)	F(Y)	G(Y)	H(Y)	I(Y)	J(Y)
Long Name	Year	Make	country	luxury	Power	0~60 mph	Weight	Gas Mileage	Engine Displacement	Power/Engine Displacement
Units					kw	sec	kg	mpg	cc	
Comments										
F(x)=										
Std Dev					28.07561					
Mean					79.85					
1	1992		US	N	132	14	2238	11	5736.5	

	A(X)	B(Y)	C(Y)	D(Y)	E(Y)	F(Y)	G(Y)	H(Y)	I(Y)	J(Y)
Long Name	Year	Make	country	luxury	Power	0~60 mph	Weight	Gas Mileage	Engine Displacement	Power/Engine Displacement
Units					kw	sec	kg	mpg	cc	
Comments										
F(x)=										
Std Dev					28.07561					
Mean					79.85	15.58824	1337.75882	21.74706	3408.43735	
1	1992		US	N	132	14	2238	11	5736.5	

- Double-click those *Mean* cells, you will find the filled formulas are all same, =mean(this).

E(Y)	F(Y)	G(Y)	H(Y)	I(Y)
Power	0~60 mph	Weight	Gas Mileage	Engine Displacement
kw	sec	kg	mpg	cc
28.07561				
79.85	15.58824	1337.75882	21.74706	=mean(This)
132	14	2238	11	5736.5

- Do the same thing for the **Std Dev** row to calculate the standard deviation for all these five columns.

9. Go to the last column we just added, in the first cell enter =E1/I1.

	A(X)	B(Y)	C(Y)	D(Y)	E(Y)	F(Y)	G(Y)	H(Y)	I(Y)	J(Y)
Long Name	Year	Make	country	luxury	Power	0-60 mph	Weight	Gas Mileage	Engine Displacement	Power/Engine Displacement
Units					kw	sec	kg	mpg	cc	
Comments										
F(x)=										
Std Dev					28.07561	3.14842	341.95962	5.89141	1719.2832	
Mean					79.85	15.58824	1337.75882	21.74706	3408.43735	
1	1992		US	N	132	14	2238	11	5736.5	=E1/I1
2	1992	Acura	Japan	Y	154	12	2324	11	5212	

**Note:** Here, **E1** means the first cell of col(E) and **I1** means the first cell of col(I). You can refer to [this page](#) to learn more about the formula.

10. Release your cursor to execute the division. Use the same way at Step 6 to grab this "+" handle and drag with your mouse vertically to the end cell of this column (**Hint:** If you hover on the lower-right corner of the cell, directly over the cell handle, the cursor changes to a "+" sign. When this "+" sign appears, double-click to extend the formula to the end of the column. This is faster and easier than dragging with your mouse).

	A(X)	B(Y)	C(Y)	D(Y)	E(Y)	F(Y)	G(Y)	H(Y)	I(Y)	J(Y)
Long Name	Year	Make	country	luxury	Power	0-60 mph	Weight	Gas Mileage	Engine Displacement	Power/Engine Displacement
Units					kw	sec	kg	mpg	cc	
Comments										
F(x)=										
Std Dev					28.07561	3.14842	341.95962	5.89141	1719.2832	
Mean					79.85	15.58824	1337.75882	21.74706	3408.43735	
1	1992		US	N	132	14	2238	11	5736.5	0.02301
2	1992	Acura	Japan	Y	154	12	2324	11	5212	
3	1992	GMC	US	N	158	13	1531	10	5900.4	
4	1992	Chrysler	US	N	132	10	2088	12	6277.4	
5	1992	Kia	Korea	N	121	12	1202	12	5736.5	
6	1992	Suzuki	Japan	N	106	10	1417	14	5736.5	
7	1992	Volvo	Sweden	Y	95	14	1661	13	5031.7	
8	1992	#####	#####	Y	132	14	2208	12	5736.5	
9	1992	Acura	Japan	Y	128	13	1412	12	5736.5	

11. Release the cursor to get all division results of col(E)/col(I) at each row.

E(Y)	F(Y)	G(Y)	H(Y)	I(Y)	J(Y)
Power	0-60 mph	Weight	Gas Mileage	Engine Displacement	Power/Engine Displacement
kw	sec	kg	mpg	cc	
28.07561	3.14842	341.95962	5.89141	1719.2832	
79.85	15.58824	1337.75882	21.74706	3408.43735	
132	14	2238	11	5736.5	0.02301
154	12	2324	11	5212	0.02955
158	13	1531	10	5900.4	0.02678
132	10	2088	12	6277.4	0.02103
121	12	1202	12	5736.5	0.02109
106	10	1417	14	5736.5	0.01848
95	14	1661	13	5031.7	0.01888
132	14	2208	12	5736.5	0.02301
128	13	1412	12	5736.5	0.02231
124	17	1518	13	5900.4	0.02102
110	10	1810	13	5212	0.02111

12. Select **Edit: Edit Mode** menu, you can check and edit all these cell formulas.

E(Y)	F(Y)	G(Y)	H(Y)	I(Y)	J(Y)
Power kw	0-60 mph sec	Weight kg	Gas Mileage mpg	Engine Displacement cc	Power/Engine Displacement
=stddev(This)	=stddev(This)	=stddev(This)	=stddev(This)	=stddev(This)	
=mean(This)	=mean(This)	=mean(This)	=mean(This)	=mean(This)	
132	14	2238	11	5736.5	=E1/I1
154	12	2324	11	5212	=E2/I2
158	13	1531	10	5900.4	=E3/I3
132	10	2088	12	6277.4	=E4/I4
121	12	1202	12	5736.5	=E5/I5
106	10	1417	14	5736.5	=E6/I6
95	14	1661	13	5031.7	=E7/I7
132	14	2208	12	5736.5	=E8/I8
128	13	1412	12	5736.5	=E9/I9
124	17	1518	13	5900.4	=E10/I10
110	10	1810	13	5212	=E11/I11
116	14	1899	13	5752.9	=E12/I12
128	17	1696	14	5900.4	=E13/I13
110	15	1488	13	5212	=E14/I14
94	15	1536	13	4949.8	=E15/I15
145	17	1426	12	7031.3	=E16/I16
152	9	1542	12	7031.3	=E17/I17
117	15	1754	12	5736.5	=E18/I18
147	18	2140	10	5031.7	=E19/I19
110	13	1437	11	6556	=E20/I20
165	14	1730	12	7457.4	=E21/I21
139	15	1680	13	6556	=E22/I22
122	10	1952	10	6556	=E23/I23

**Note:** Additionally, you are also allowed to [extend formulas across rows and columns](#). For more details about setting cell values with formula, please refer to [this page](#).

### 4.6.3 Worksheet Data Operations

#### 4.6.3.1 Worksheet Data Operations

- [Worksheet Query](#)
- [Data Reduction](#)
- [Data Filter](#)
- [Lock Filter with Analysis](#)

#### 4.6.3.2 Worksheet Query

##### 4.6.3.2.1 Summary

This tutorial will show you how to use the **Worksheet Query** dialog.

Minimum Origin Version Required: Origin 2019b



#### 4.6.3.2 What you will learn

This tutorial will show you how to:

- Extract numeric and time data
- Use an alias in an extraction condition
- Use LabTalk functions in an extraction condition

#### 4.6.3.2.3 Dialog Overview



The **Worksheet Query** dialog box will differ slightly from the image below if (a) **Spreadsheet Cell Notation (SCN)** is OFF in the active workbook (you see this icon  in the upper-left corner of the workbook), or (b) you have SCN turned ON but you have checked the **Use Alias** box in the upper-right corner of Worksheet Query. The **Worksheet Query** dialog box was modified for version **2019b** to allow for more flexible column naming. You can still work through this tutorial by defining column Aliases. See [Select Column Variables for If Test](#), for guidance.

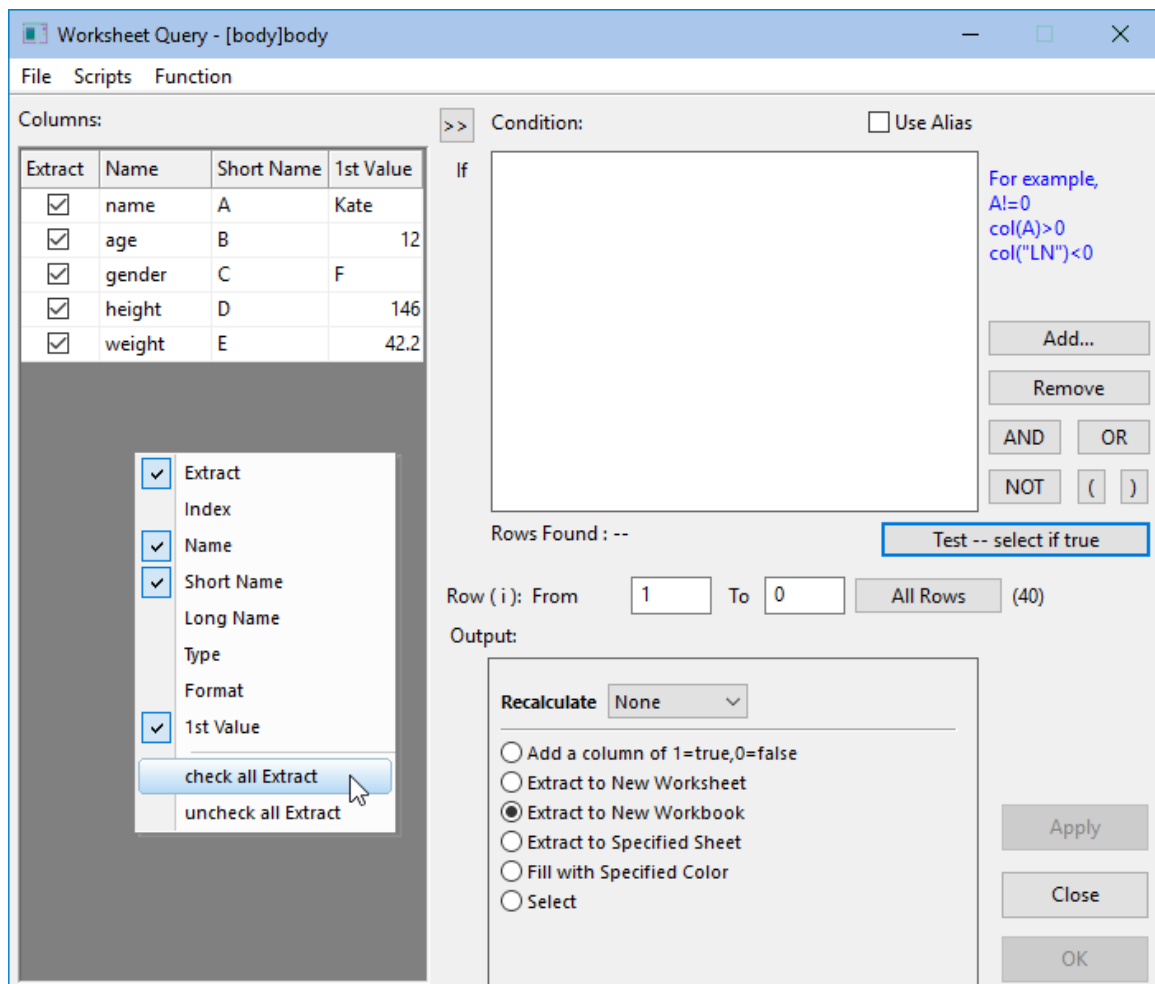

There are two main panels in the **Worksheet Query** dialog:

- The left panel lists all the columns in the active worksheet. Right-click in the left panel and choose which column properties to display (e.g. *Format, 1st Value*, etc). Note that only those columns checked in the **Extract** column will be output when you click **OK** in the dialog box.
- The right panel is where you set, test and execute query conditions. If SCN is off or you have opted to check the **Use Alias** box, select those worksheet columns that you want to use in the extract condition in the left panel, then click the  button to move them into the **Select Column Variable for If Test** box. You will then have the Aliases that you need to define your **Condition**. If you intend to use column names or indices instead of Aliases, you can simply define your **Condition** directly.

#### 4.6.3.2.4 Define the Condition

##### Extract Numerical Data

1. Start with a new workbook and import the file `\Samples\Statistics\body.dat`.
2. Click the menu item **Worksheet: Worksheet Query** to open the Worksheet Query dialog box. If you know [the correct syntax](#), you can type your expression directly into the **Condition** box. To aid you in constructing your expression, you can use the buttons to the right side of **Condition**. Additionally, you can insert functions and variables from the **Function** menu.
3. To extract the data of individuals who are at least 160cm in height, type the following into the Condition box:

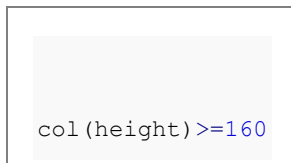

```
col (height) >= 160
```

4. When there are multiple conditions, you can combine these conditions using logical operators **AND, OR, NOT**. We will add a second condition that tests for individuals that weigh no more than 50kg. Click the **AND** button and type the following after **AND**:

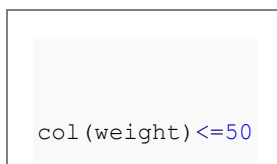

```
col (weight) <= 50
```

Your expression should now look like this:



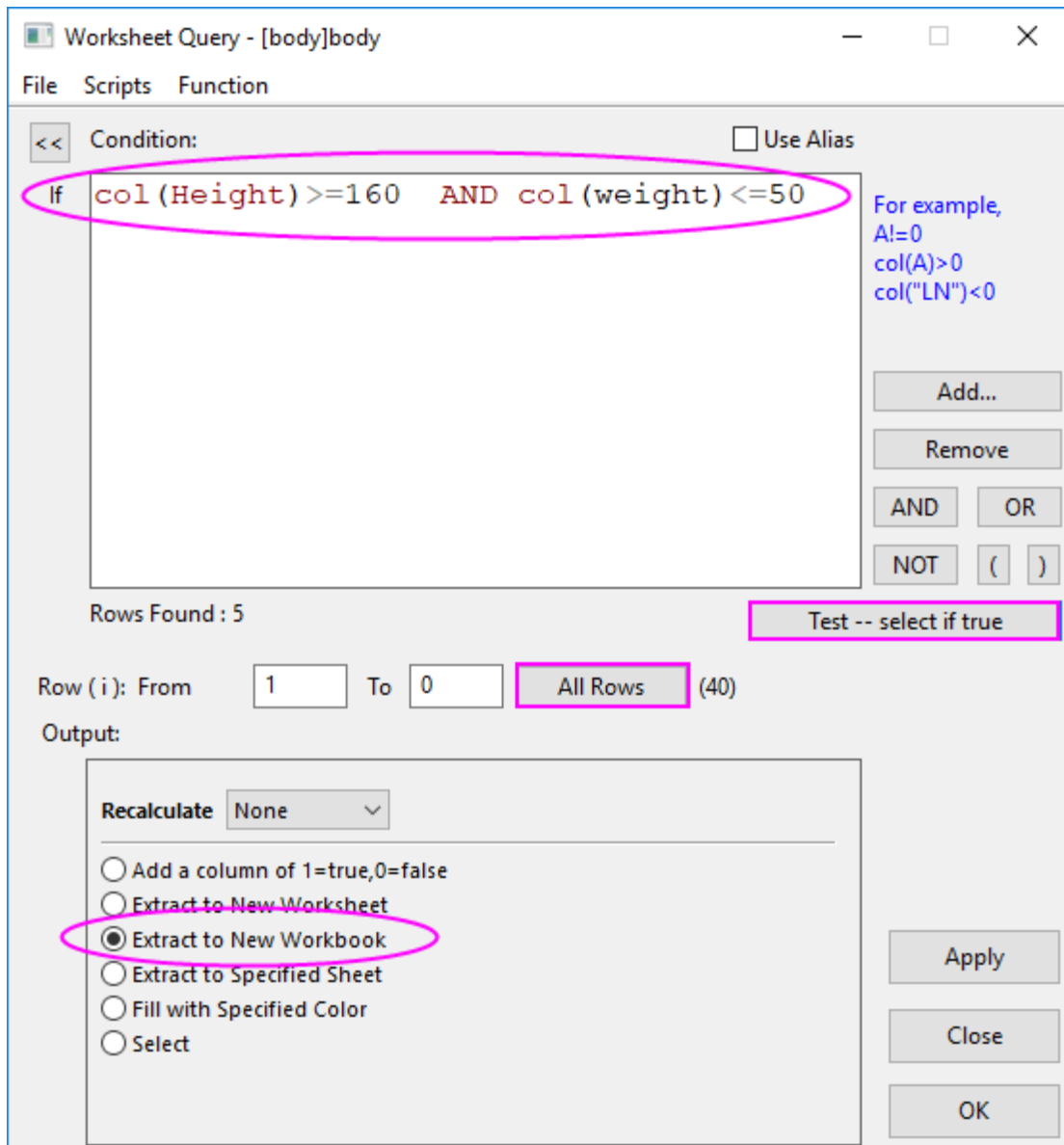

- To test your query, click the **All Rows** button to select all rows (note that the *0* in **1 To 0** signifies the last row in the sheet), then click **Test -- select if true** to test your expression. Origin will return 5 records found.

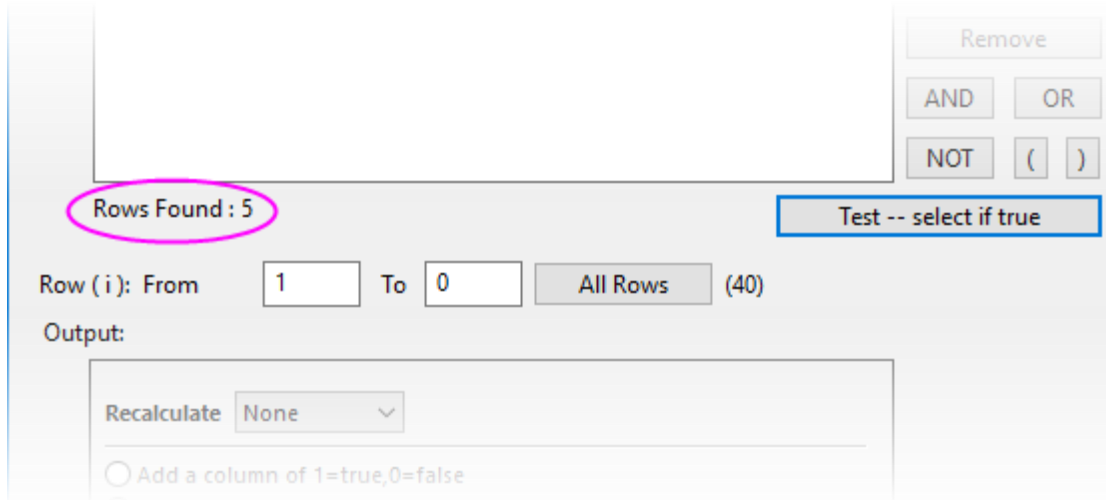

6. Accept other default settings and click the **OK** button. A new workbook containing the 5 found records, is created.

#### Extract Strings

When extracting strings, you need to enclose the string with double quotes (e.g. "California").

1. In order to extract just female (**F**) subjects, we type the following into the **Condition** box:

```
col(gender) == "F"
```

2. Click the **All Rows** button, then click **Test -- select if true**. A message shows that 18 records are found.
3. Accept other defaults and click the **OK** button to close the dialog and extract data for female subjects to a new workbook.

#### Extract Time Data

[Date and Time](#) data are internally saved as numeric values in Origin. Date is the integer part of the numeric value, while Time is the fractional part. You can use the [int\(\)](#) and [frac\(\)](#) functions to return the integer and fractional parts of a number, and use the [Date\(MM/DD/YY\)](#) and [Time\(HH:mm:ss\)](#) functions to convert date-time string data to numeric [Julian day](#) data.

1. Create a new workbook and choose **Data: Import from File: Single ASCII** and import `<Origin Program Path>\Samples\Import and Export\Custom Date and Time.dat`. Note that the "date-time" data in column A is left-aligned, indicating that it is being treated as text strings and not as true date-time data (which is numeric).
2. Select column A, right-click and select **Properties**. Set **Format = Date**, **Display = Custom Display** and in **Custom Display** enter the following:

```
dd'.'MM'.'yyyy HH':'mm':'ss'.'##
```

This formats the date-time strings in column A as date-time numeric data.

- Next, we will extract that portion of worksheet data that falls within the time period 10:00:00 and 11:00:00. Click **Worksheet: Worksheet Query** and in the **Condition** box, enter the following:

```
frac(A) > Time(10:00:00) AND frac(A) < Time(11:00:00)
```

- Click the **All Rows** button, then click **Test -- select if true**. A message shows that 120 records are found.
- Accept other defaults and click the **OK** button to close the dialog and extract data recorded between 10:00:00 and 11:00:00 to a new workbook.

#### 4.6.3.3 Data Reduction

##### 4.6.3.3.1 Summary

Origin offers a number of tools which can be used for data reduction in worksheets: [Data Filters](#), [Worksheet Query](#) and [several X-Functions](#) which reduce the number of data rows by different methods.

Minimum Origin Version Required: 2015 SR0

##### 4.6.3.3.2 What You Will Learn

In this tutorial, you will learn how to:

- Reduce XY data to evenly spaced X
- Reduce Duplicate X Data for XY dataset
- Reduce XY data by Group
- Reduce worksheet rows

##### 4.6.3.3.3 Steps

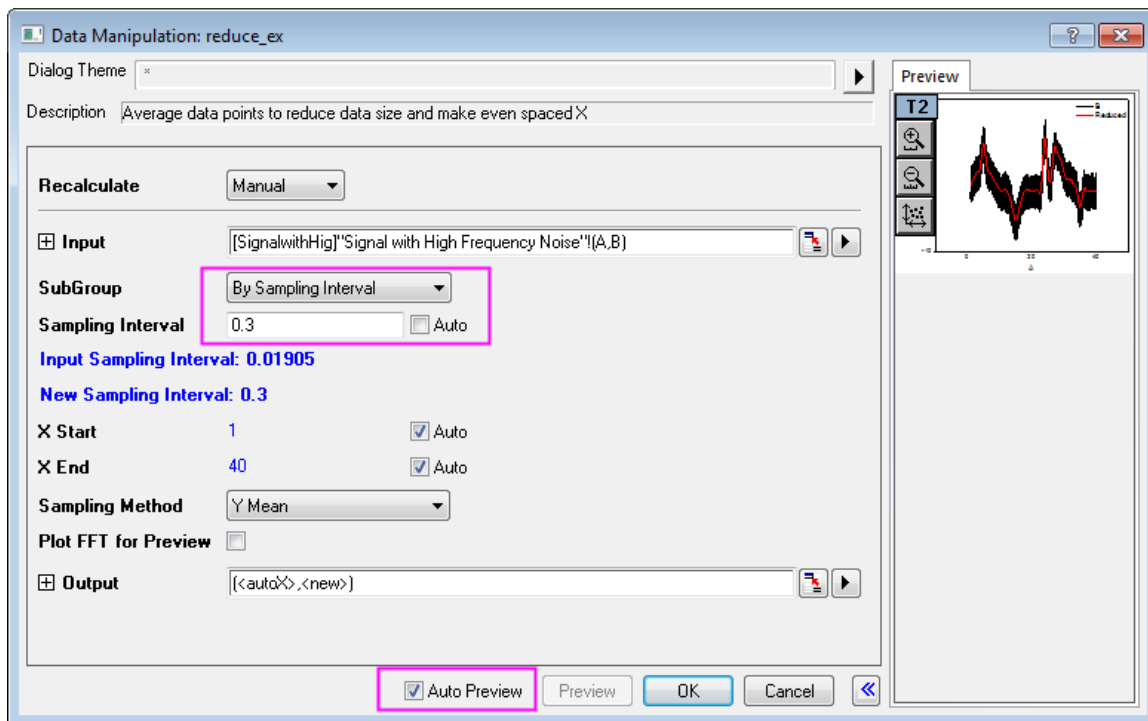

###### Reduce to Evenly Spaced X

- Create a new workbook and click the  button to import the file **Signal with High Frequency Noise.dat** under `<Origin EXE folder>\Samples\Signal Processing` path.
- Highlight column B and select **Analysis:Data Manipulation:Reduce to Evenly Spaced X** to open the **reduce\_ex** dialog. Edit the settings so that they match the following.

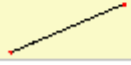

3. Click **OK**. A new column (column C) is added to the worksheet. This column contains its own sampling interval information. Click on the column header to select the column then choose **Column: Show X Column**. In the **Show X Column: colshowx** dialog box, click **OK** to generate an X column using the sampling interval. You can see that the original XY dataset has been reduced by generating a new, larger sampling interval.

SignalwithHig - Signal with High Frequency ...

A-Z	A(X1)	B(Y1)	C	D(Y#)
Long Name				ReduceEX
Units				
Comments			Generated from Sampling Info of D	Y Mean(X Average) Stats Reduction of B
F(x)=				
Sparklines				
121	3.28627	5.45477	37.15	0.01108
122	3.30532	4.93594	37.45	-0.1918
123	3.32438	4.35703	37.75	-0.03399
124	3.34343	3.87166	38.05	-0.12321
125	3.36248	3.41072	38.35	0.07485
126	3.38153	2.826	38.65	-0.00137
127	3.40059	2.05593	38.95	-0.12254
128	3.41964	1.17457	39.25	-0.17762
129	3.43869	0.40375	39.55	0.10425
130	3.45774	0.08745	39.85	-0.26257
131	3.4768	0.40962		
132	3.49585	1.28452		
133	3.5149	2.42692		
134	3.53395	3.65674		
135	3.553	4.83102		
136	3.57206	5.628		
137	3.59111	5.83541		

Signal with High Frequency Noise

- Highlight column B and D (hold down the **Ctrl** key for multiple selection), and click the  button to generate a line plot for original (Black) and reduced (Red) data.
- You can see from the plot that the data size is considerably reduced:

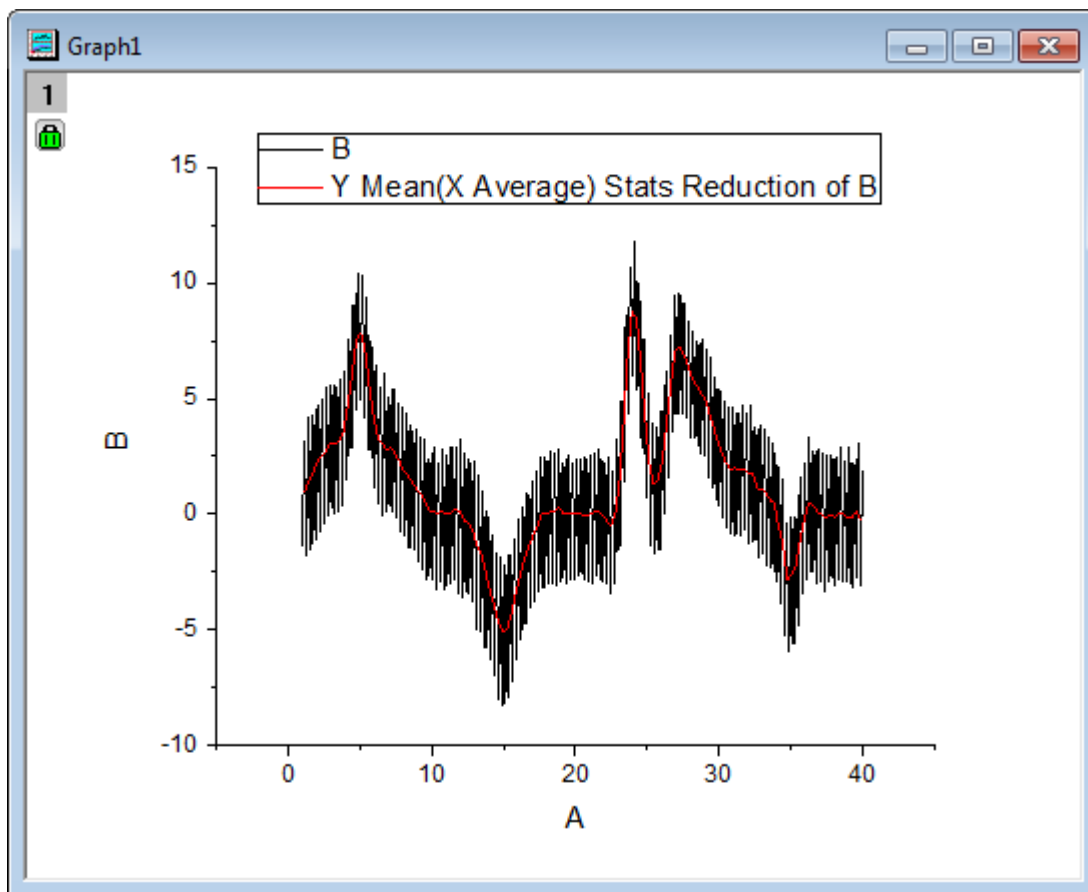

**Reduce Duplicate X**

1. Create a new workbook and click the  button to open the **Import Wizard**. Select the data files **Step01.dat**, **Step02.dat** and **Step03.dat** under the file path <Origin EXE Folder>\Samples\Curve Fitting\. Change the **Import Mode** to **Start New Rows** and make sure the default import filter **step** is applied. Click **Finish** to import these data files.
2. Highlight column A and B, select **Analysis:Data Manipulation:Reduce Duplicate X Data** to open the **reducedup** dialog. Duplicate the settings as depicted below:

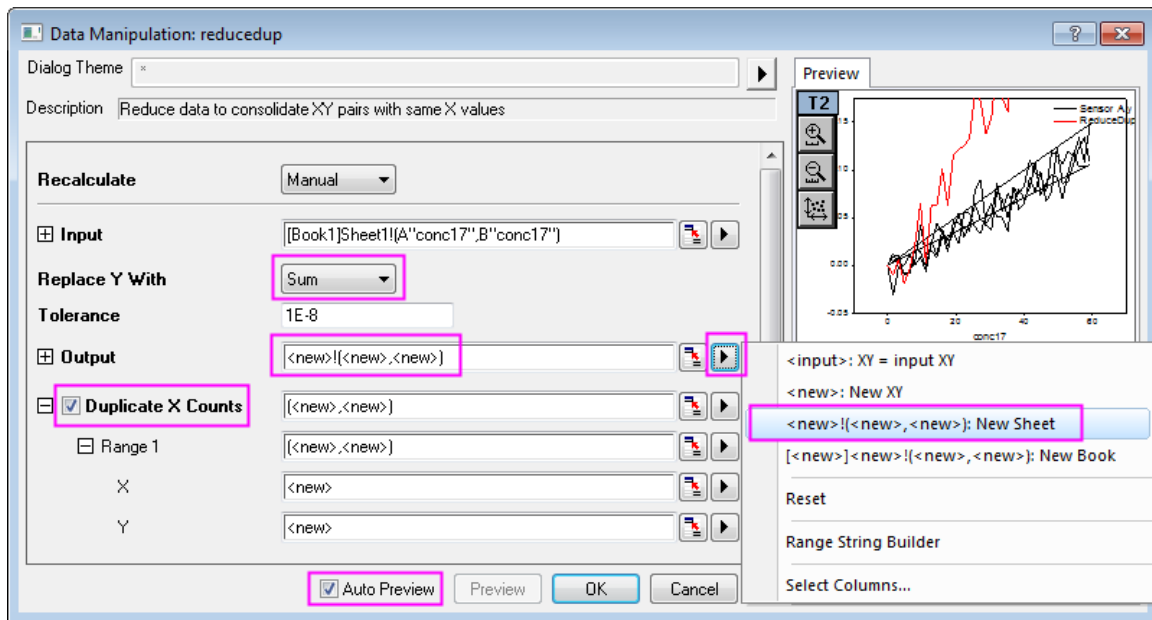

3. Click **OK** to apply settings and in the results sheet **Sheet2**, we can see that for each X value, 3 duplicates are found. In the reduced dataset, the Y values for each duplicated X have been replaced by the sum of the Y values.

	A(X1)	B(Y1)	C(X2)	D(Y2)
Long Name	ReduceDu	ReduceDupY1	DupX1	DupXCount1
Units				
Comments		Duplicates replaced with Sum of "conc17"		
F(x)=				
1	0	0	0	3
2	1.6	-0.01038	1.6	3
3	3.2	0.00635	3.2	3
4	4.8	-0.01886	4.8	3
5	6.4	-0.00427	6.4	3
6	8	0.02093	8	3
7	9.6	0.065	9.6	3
8	11.2	0.00214	11.2	3
9	12.8	0.06268	12.8	3
10	14.4	0.06262	14.4	3
11	16	0.10034	16	3
12	17.6	0.06281	17.6	3
13	19.2	0.11499	19.2	3
14	20.8	0.1214	20.8	3
15	22.4	0.12543	22.4	3
16	24	0.13385	24	3
17	25.6	0.18195	25.6	3
18	27.2	0.17139	27.2	3
19	28.8	0.138	28.8	3

**Reduce/Combine Duplicate Rows**

1. Go to *Sheet1* of the previous section, highlight column A and select **Worksheet:Remove/Combine Duplicated Rows...** to open the **wdeldup** dialog. Select **Average** from **Merge Duplications by** drop-down list, and click the right-sided triangle button on the **Output Worksheet** row to select **<new>:New Sheet** and check the **Output Counts** box and click **OK**.



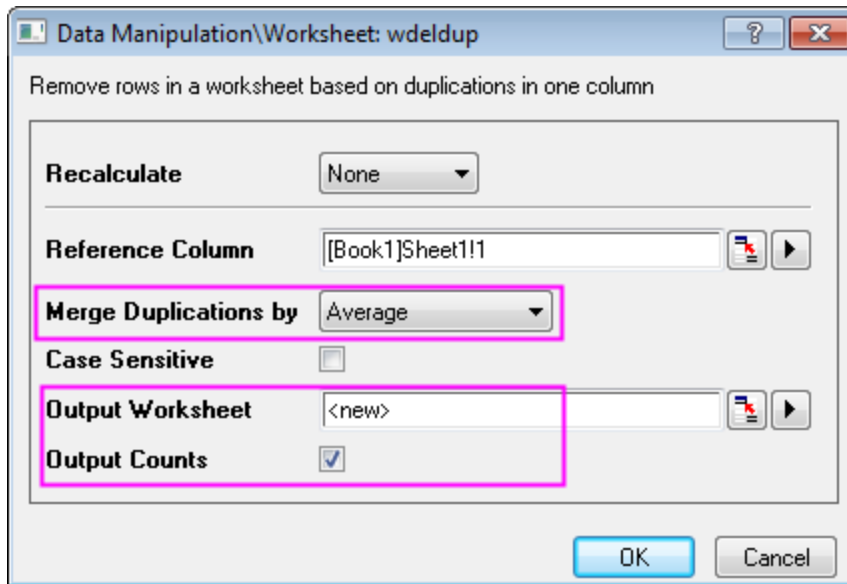

2. Entire worksheet rows are reduced into the average values of merged rows which are determined by duplications in the selected column. A new column **Counts** is added to the end of the result worksheet *wdeldup* and it reports the number of duplicates found for each X value.



	M(X7)	N(Y7)	O(X8)	P(Y8)	Q(Y8)
Long Name	conc23	conc23	conc24	conc24	Counts
Units					
Comments	Sensor G x	Sensor G y	Sensor H x	Sensor H y	
F(x)=					
1	1.2	0	1.4	0	3
2	2.8	0.11737	3	0.17448	3
3	4.4	0.27997	4.6	0.41884	3
4	6	0.40171	6.2	0.57955	3
5	7.6	0.51925	7.8	0.68073	3
6	9.2	0.63123	9.4	0.76457	3
7	10.8	0.69611	11	0.81905	3
8	12.4	0.75454	12.6	0.8929	3
9	14	0.82426	14.2	0.88688	3
10	15.6	0.84269	15.8	0.93241	3
11	17.2	0.86731	17.4	0.9457	3
12	18.8	0.90261	19	1.00258	3
13	20.4	0.93424	20.6	0.98714	3
14	22	0.94843	22.2	1.03746	3
15	23.6	0.95477	23.8	1.0414	3
16	25.2	0.98433	25.4	1.03587	3
17	26.8	0.98297	27	1.05837	3
18	28.4	0.99487	28.6	1.07505	3
19	30	1.01113	30.2	1.08614	3
20	31.6	1.03864	31.8	1.07638	3
21	33.2	1.04718	33.4	1.10826	3
22	34.8	1.03794	35	1.11607	3
23	36.4	1.04631	36.6	1.12785	3
24	38	1.07383	38.2	1.14673	3
25	39.6	1.06616	39.8	1.13881	3
26	41.2	1.07251	41.4	1.14844	3



The tool **Reduce Duplicate X** works for XY dataset only, while the tool **Remove/Combine Duplicate Rows** works for an entire worksheet.

You can also remove duplicate XY data from an XYZ dataset by using the [Statistics on Columns](#) tool, please refer to this [Quick Help](#).

### Reduce by Group

1. Open a new workbook, then click the  button to import the **Magnetization.dat** file under <Origin EXE folder>\Samples\Data Manipulation path.
2. Highlight columns A and B and click the  button to generate a line plot.
3. Activate this graph and select **Analysis:Data Manipulation:Reduce by Group** to open the **reducexy** dialog. Edit your settings as below:

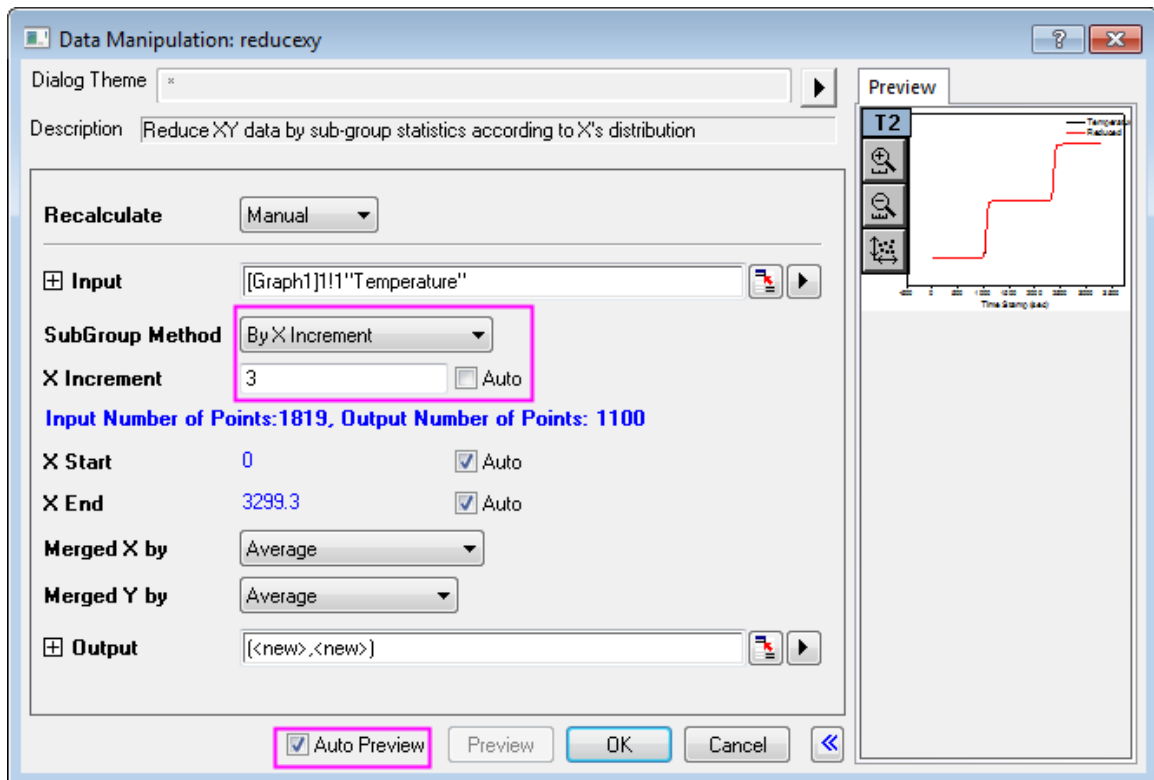

4. Click **OK** to reduce the data. The reduced XY dataset will be added as two new columns at the end of original worksheet:

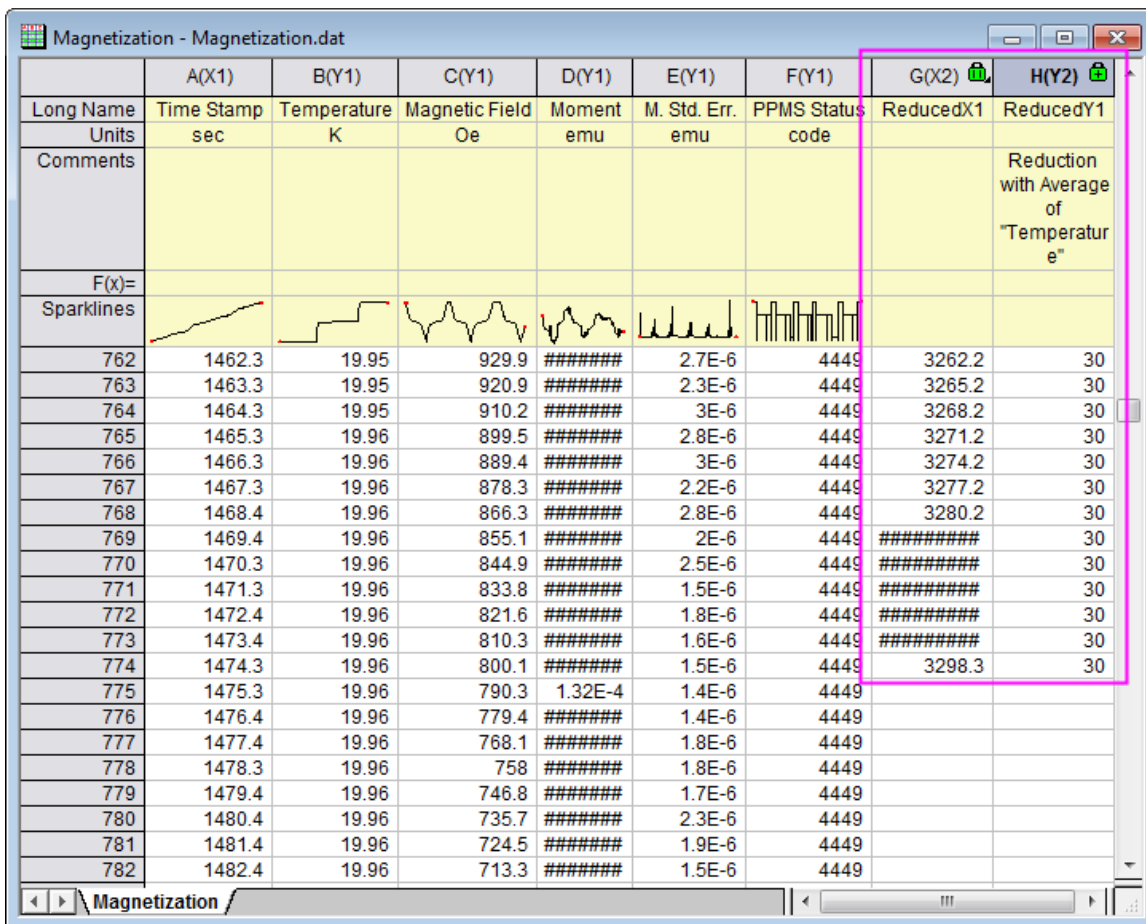

- The reduced XY dataset is added as a new data plot to the original graph:

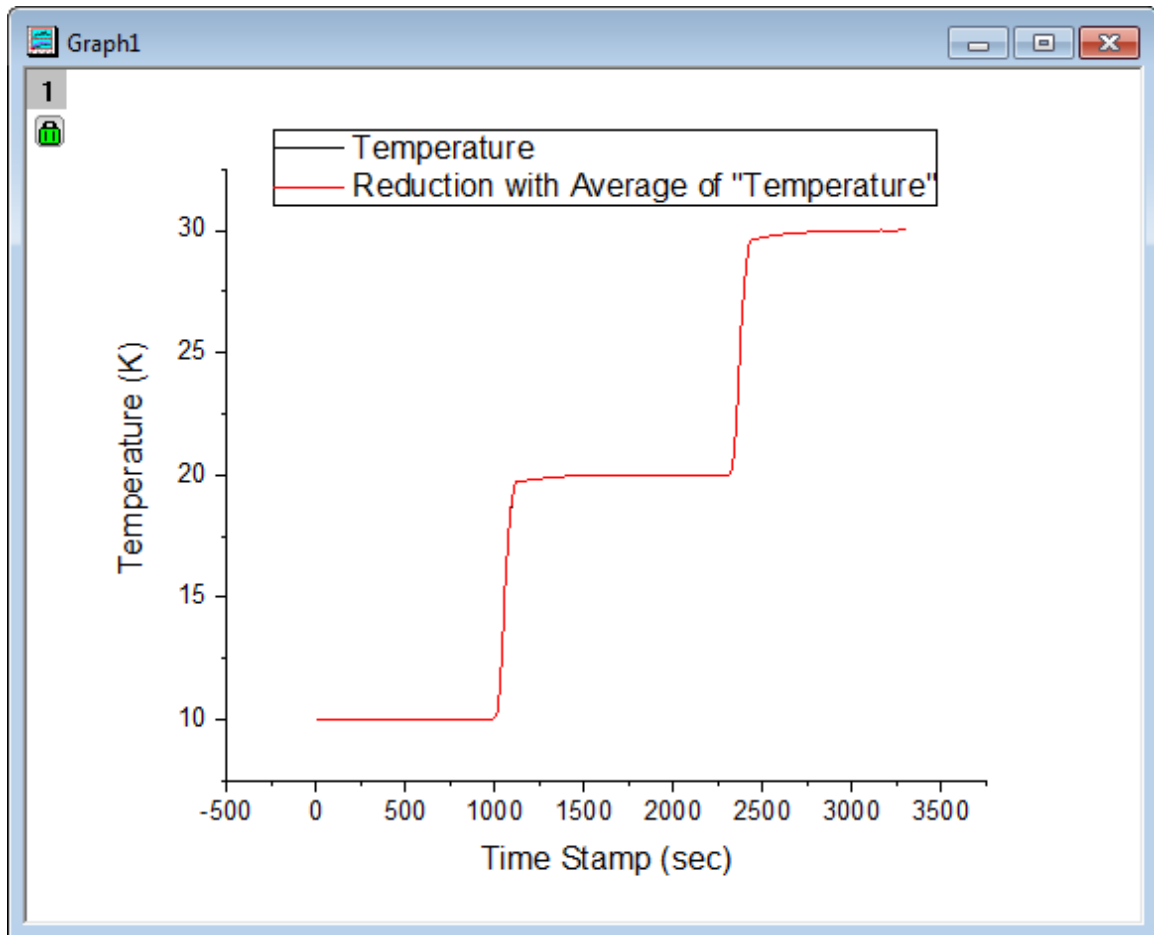

#### Reduce Worksheet Rows

1. Open a new workbook, then Click the  button to import the file **Nitrite.dat** (path is *<Origin EXE folder>\Samples\Spectroscopy*). There are 6392 data points in this file.

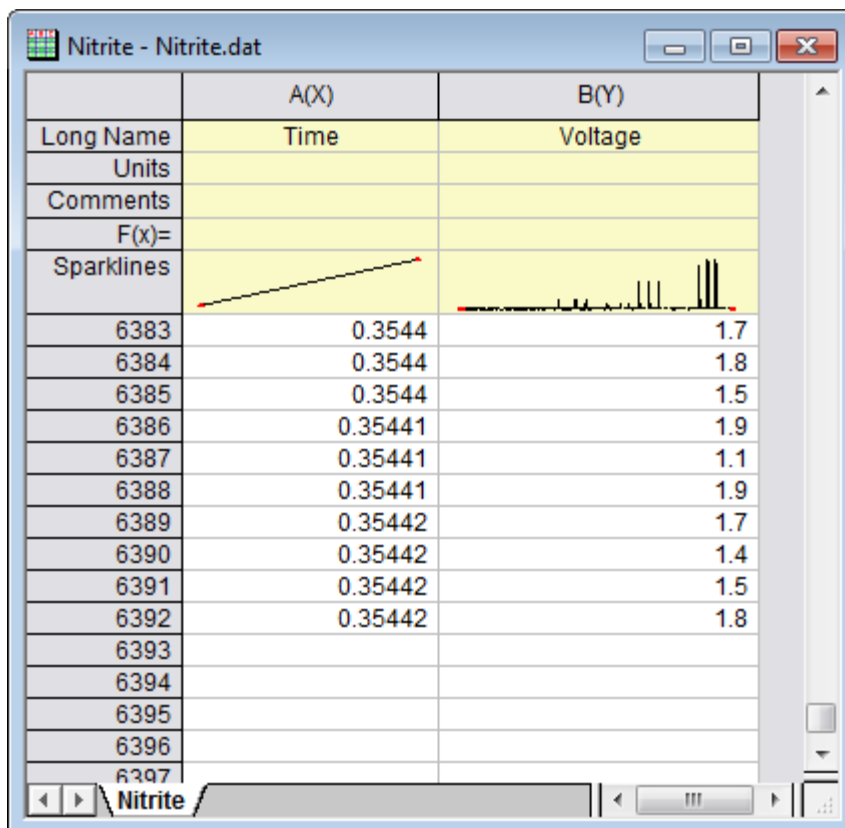

- Highlight both columns in the Nitrite worksheet and select **Worksheet:Reduce Rows** to open the **wreducerows** dialog, and edit the settings to match the image below:

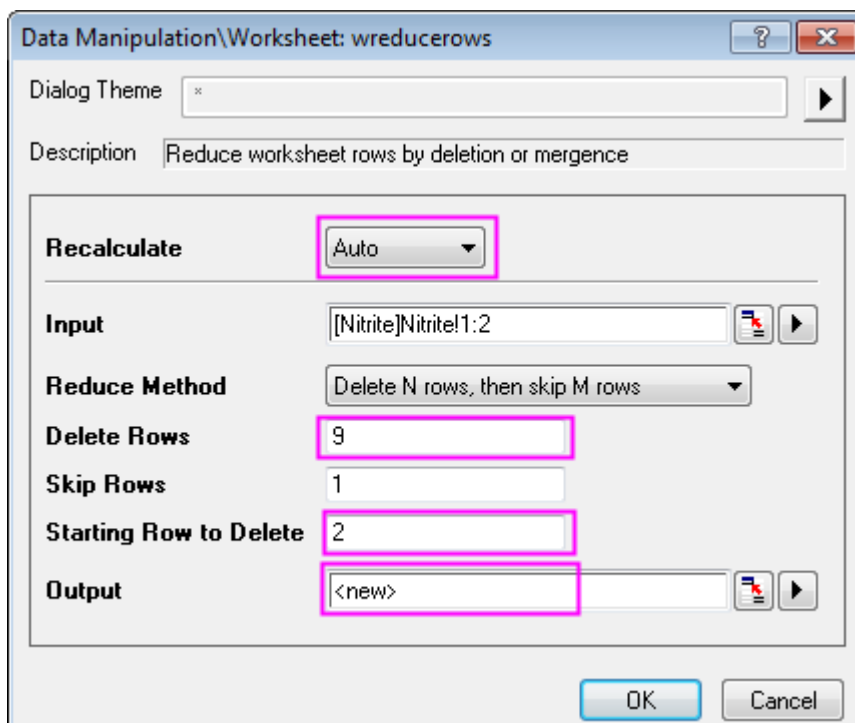

**Note:** You can select the arrow button right to the **Output** select box and choose **<new>:New Column(s)** to make the selection.

3. When you click **OK**, only the first of every 10 rows is kept. Ninety percent of data points are discarded. Remaining data points are output to new columns:

	A(X1)	B(Y1)	C(X2)	D(Y2)
Long Name	Time	Voltage	Time	Voltage
Units				
Comments				
F(x)=				
Sparklines				
634	0.33776	1.3	0.35425	1.5
635	0.33777	0.9	0.35428	1.5
636	0.33777	0.5	0.35431	1.1
637	0.33777	0.8	0.35434	1.6
638	0.33777	0.9	0.35436	2.1
639	0.33778	0.8	0.35439	2.5
640	0.33778	0.8	0.35442	1.5
641	0.33778	1.2		
642	0.33779	1.4		
643	0.33779	0.9		
644	0.33779	0.8		
645	0.3378	0.9		
646	0.3378	0.9		
647	0.3378	0.8		
648	0.3378	1.4		
649	0.33781	0.7		

4. Select the entire worksheet and click the  button to generate line plots for original (Black) and reduced (Red) data:

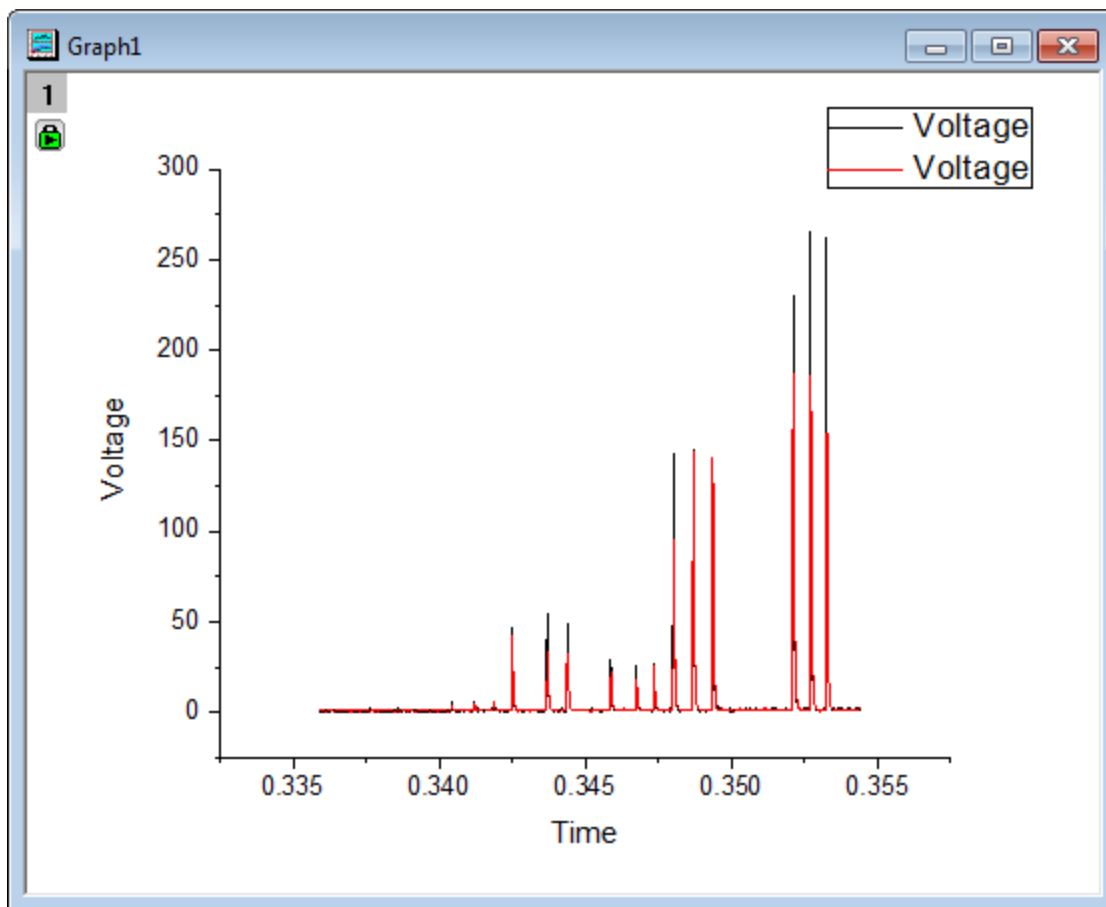

5. Note that peak heights were changed with data reduction. To maintain data plot shape, we should keep more data points. Click the green lock on Graph 1 and choose **Change Parameters** to open the **wreducerows** dialog again. Change the value of **Delete Rows** to **3** and click **OK**.
6. This time 25% of data points were kept, better preserving the shape of the original data plot.



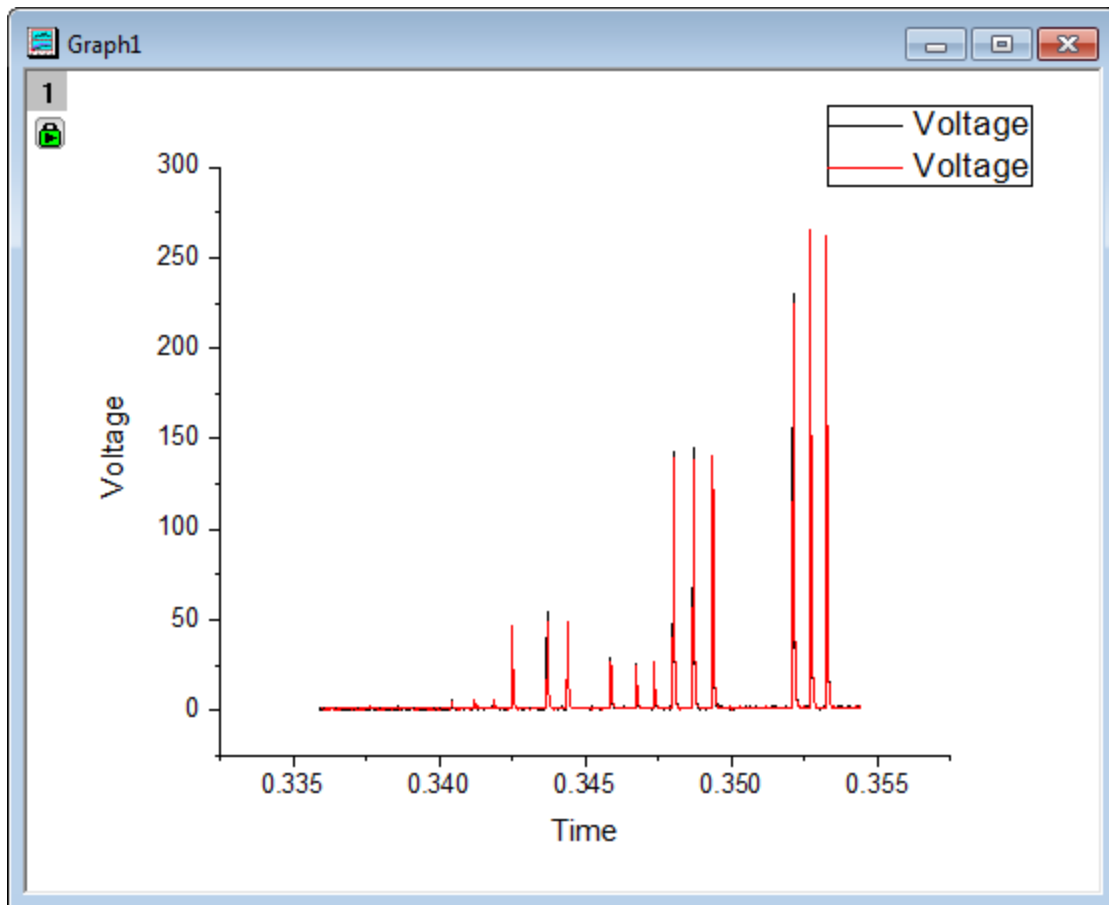

#### 4.6.3.4 Data Filter

##### 4.6.3.4.1 Summary

The **Data Filter** is a column-based tool to reduce rows of worksheet data, and consequently also hide the undesired rows for relevant data analysis and graphing. Three data formats are supported: numeric, text and date/time.



Minimum Origin Version Required: Origin 2015 SR0

##### 4.6.3.4.2 What you will learn

This tutorial will show you how to:

- Use the data filter to reduce worksheet data
- Auto update the graphs and analysis results when apply a column filter
- Add a floating graph to a worksheet.

##### 4.6.3.4.3 Steps

1. Create a new workbook by clicking the **New Workbook** button . Then click the **Import Single ASCII** button  to import the **automobile.dat** file in the <Origin Folder>\Samples\Statistics\ path. Both buttons are located in the **Standard** toolbar.
2. Highlight column C(Power), right click and choose **Set As:X** in the context menu to set this column as X.
3. Highlight column C and G (hold **Ctrl** key when clicking), click the  button on the **2D Graph** toolbar to generate a scatter plot from these two columns.
4. Activate the generated graph and select **Analysis:Fitting:Linear Fit** from menu item to open the **Linear Fit** dialog. In this dialog, set **Recalculate** to **Auto** to ensure auto update of the analysis result, accept other settings as default and click **OK** to carry out the analysis.

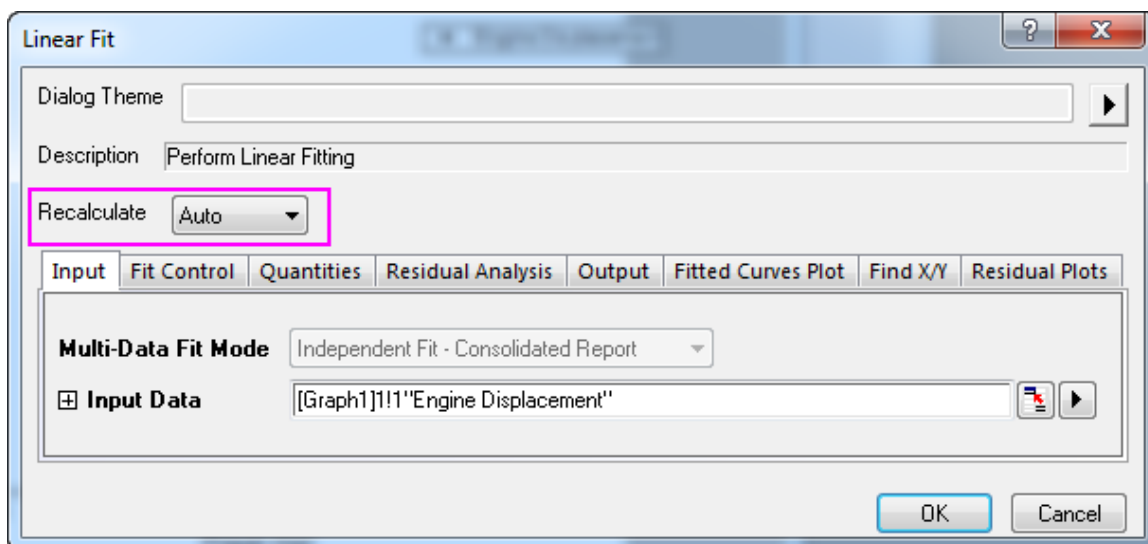

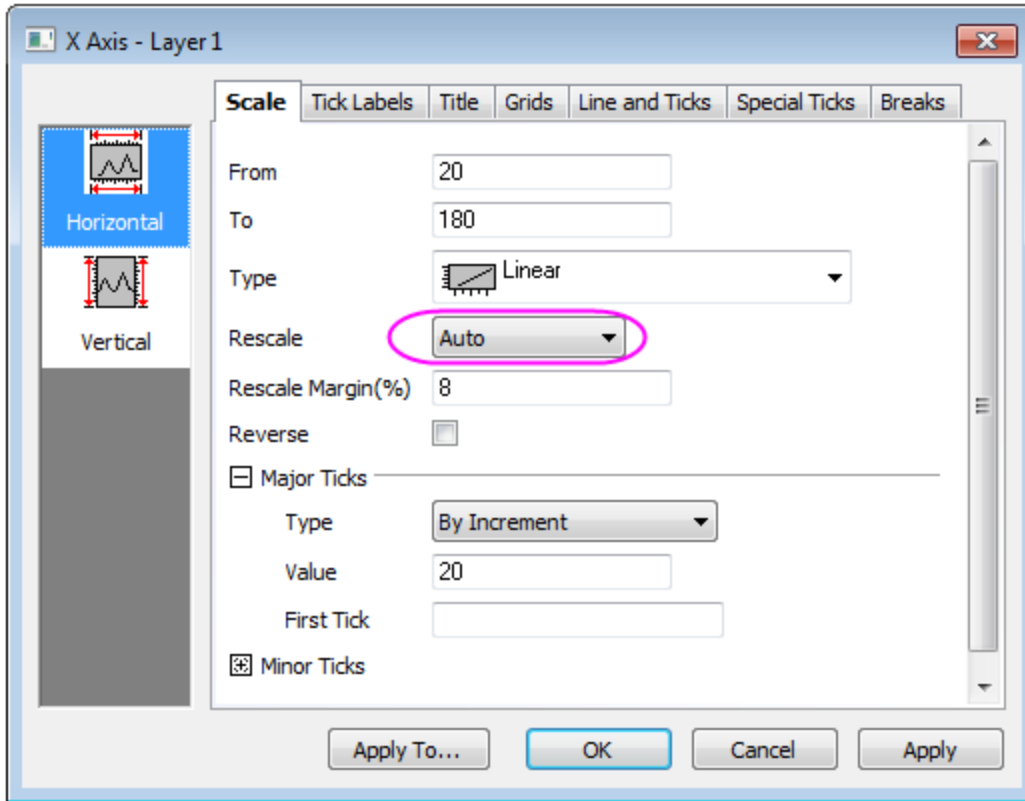

5. A fitted curve and a result table will be added to the graph. Activate the graph again and double click on the X axis to open the **Axis** dialog. Select the **Horizontal** icon in the **Scale** tab, then choose **Auto** for **Rescale**. Do the same for the Y axis (**Vertical** icon) and also set its rescale mode to **Auto**. Click **OK** to apply the settings and close the dialog.



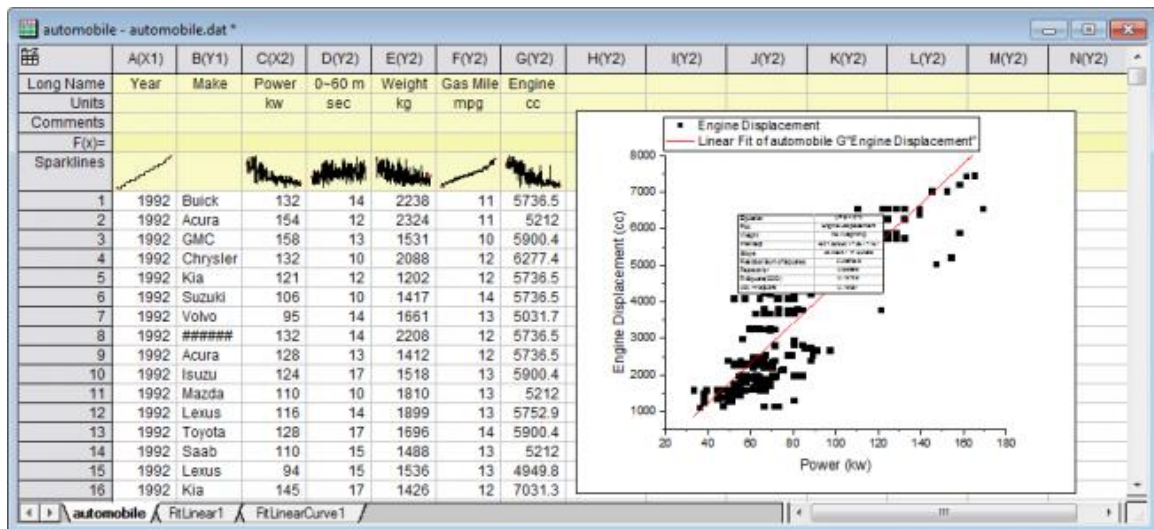

6. Go back to the original worksheet **automobile** and click **Column: Add New Columns** and add 7 columns to the worksheet.
7. Right-click in the gray area to the right side of the worksheet columns and select **Add Graph...** in the context menu to open the **Graph Browser**. In this dialog, select the previously generated graph in the left panel and click **OK** to add this graph as a floating chart to the worksheet. Drag the floating chart onto the empty worksheet columns you just created and resize it using the selection handles.

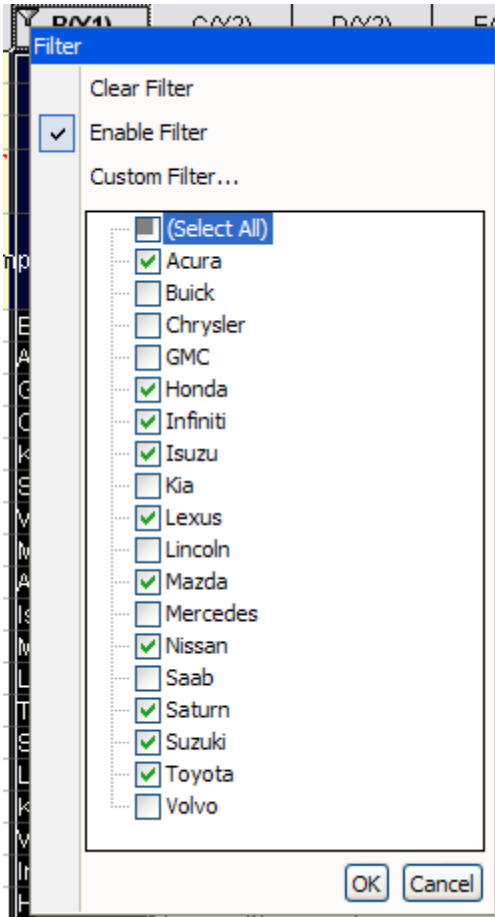

8. Highlight column A and B and click the **Add/Remove Data Filter** button  on the **Worksheet Data** toolbar to add empty data filters to both columns.
9. Click the **Filter** icon  on the column header of column B, clear the check boxes before *Buick*, *Chrysler*, *GMC*, *Kia*, *Lincoln*, *Mercedes*, *Saab*, *Volvo* to hide all rows with these entries, to leave only the Japanese makers. Click **OK** to apply the filter. The worksheet data, graph and analysis result will all be auto updated accordingly.



10. Click the **Filter** icon  on the column header of column A and select **Between**, note that the data type of column A is numeric by default from importing. Accept default setting of the **Between** dialog and click **OK**. A data filter is applied to this column.
11. Again click the **Filter** icon  on column A and this time choose **Custom Filter** in the context menu to customize the filter, change the **Condition** as **x.between(1996,2000)** to set the **From** and **To** value respectively, click the **Test** button and in the original worksheet, only the rows meet this testing condition will be highlighted, this works as a preview of the data reduction.



To view the whole worksheet at this stage, you can minimize the **Custom Filter** dialog, allowing you to scroll up and down the worksheet freely. You can later restore the dialog by clicking the "Minimize" button.

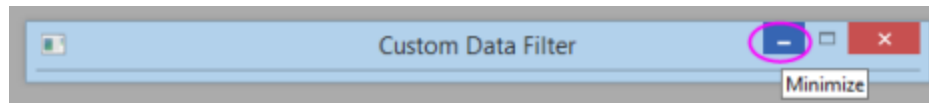

- Click the **OK** button to apply the new filtering condition and the data, graphs and analysis results are updated and the graph is also auto rescaled.

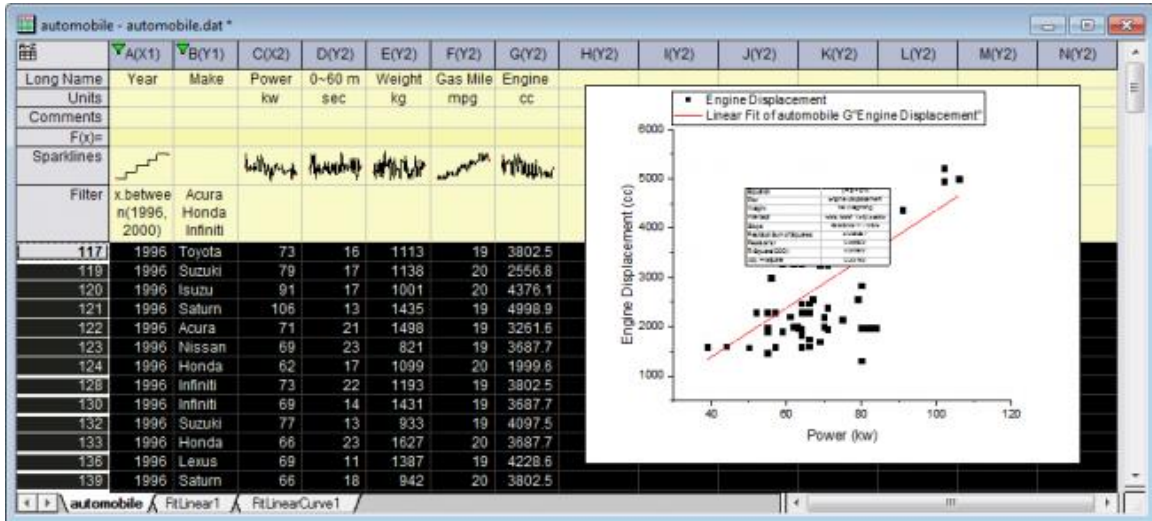

Beginning with Origin 2019, you can copy data filters from one column and paste to other columns of data. Right-click on the column's **Filter** cell and choose **Copy**; or click on the Filter cell and press Ctrl+C to copy the filter. Select your target column(s) and press Ctrl+V to paste the filter and apply it to data in those columns.

#### 4.6.3.5 Lock Filter with Analysis

##### 4.6.3.5.1 Summary

Generally, when graphing or analysis is done on data with a filter, changes in the filter condition of the source worksheet trigger recalculation for the analysis results and graph.

However for [Copy Columns](#) and [Pivot Table](#), in the Recalculate lock icon context menu, there are [three worksheet filter options](#). These are used to control whether the results will be affected by further filter changes.

Minimum Origin Version Required: Origin 9.1 SR0

##### 4.6.3.5.2 What you will learn

- How to copy columns to a new sheet or new workbook
- How to lock a Data Filter condition on copied columns
- How to push back the Data Filter condition to the source worksheet

#### 4.6.3.5.3 Steps

1. Import the Origin sample data *automobile.dat* which is located in **<Origin Program Folder> \Samples\Statistics**.
2. Highlight the **Make** column then from the menu choose **Column: Filter: Add or Remove Filter** or select the **Filter** button from the **Worksheet** toolbar.

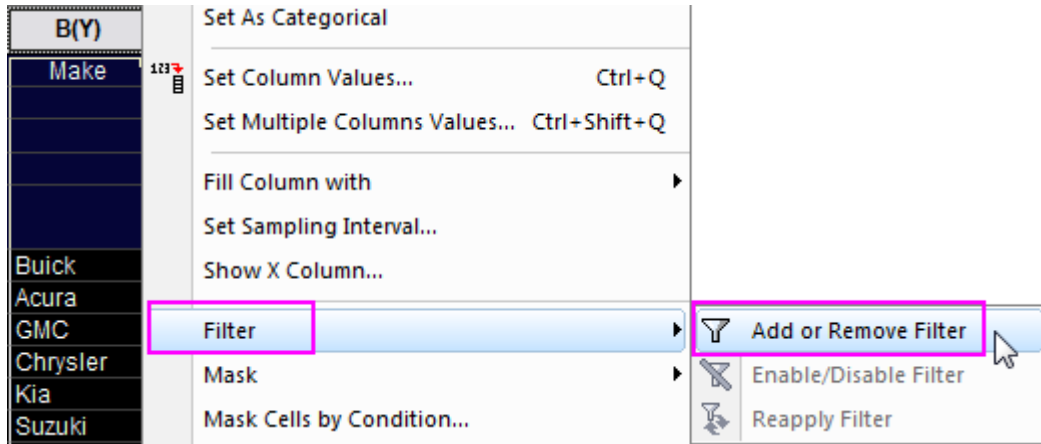

3. To show only the **Honda** data, click on the filter icon  that appears on the top left of the column's first cell. Choose **Select All** to clear all the options. Select **Honda**. Click the **OK** button.

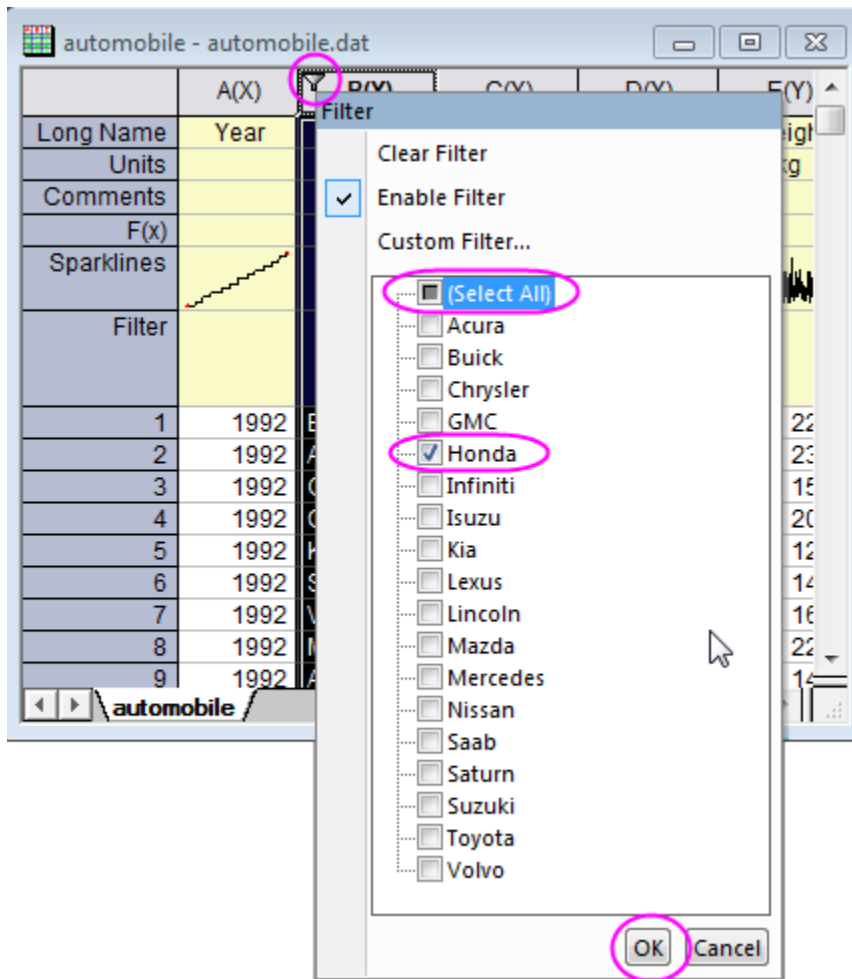

4. To copy columns to a different sheet, hold down the CTRL key and select the **Make**, **Power** and **Engine Displacement** columns. Next, right-click and select the **Copy Columns to...** in the context menu.
5. In the **colcopy** dialog, select **Auto** in the **Recalculate** drop-down list. Make sure the **Destination Columns** is set to a new worksheet in the same workbook (see Tip, below). A new sheet with the copied

columns will be created.

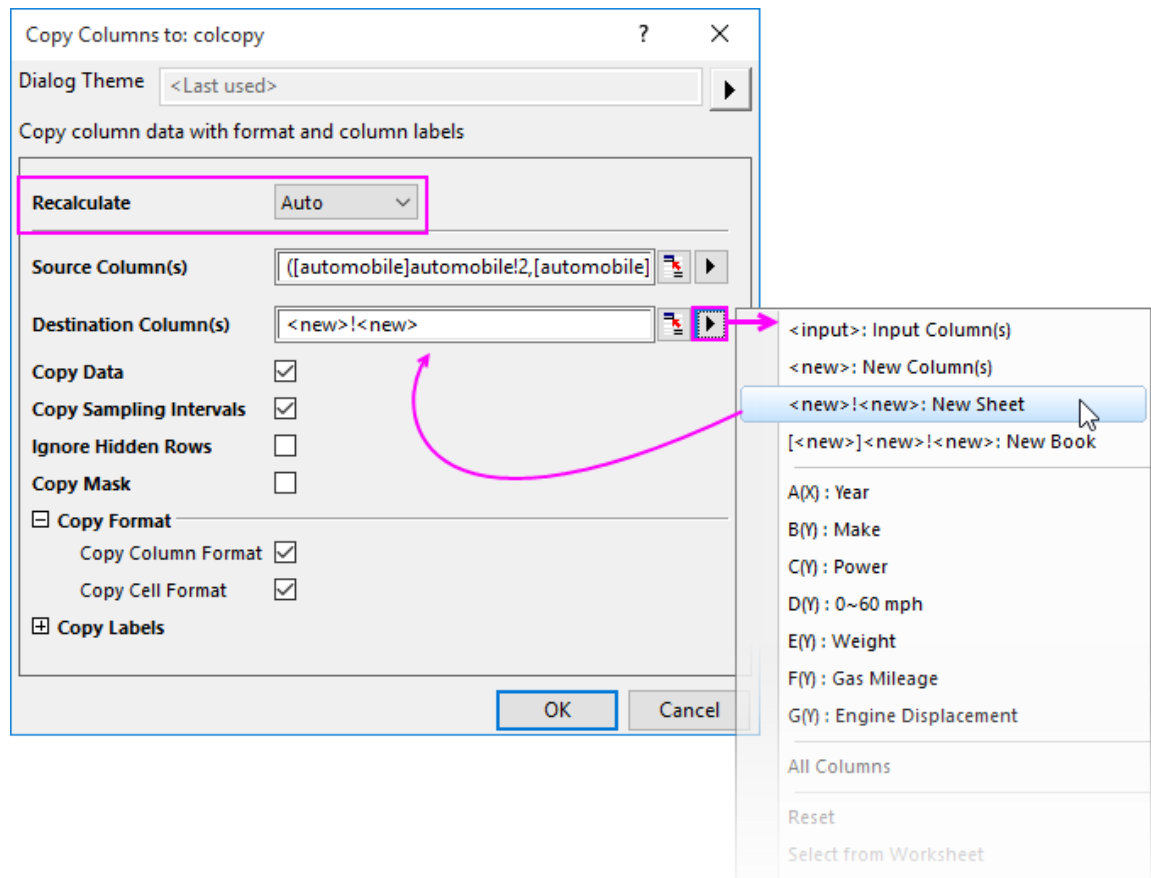

6. Click and drag the sheet tab of the copied worksheet to blank Origin workspace. This will create a new workbook to hold the copied data so the copied data and original data can now be compared side by side.
7. Click on the green Recalculate lock icon on the top left of the first cells' in the columns of this copied sheet. Select **Worksheet Filters: Lock** in the context menu. The filter conditions will be saved into the



operation.

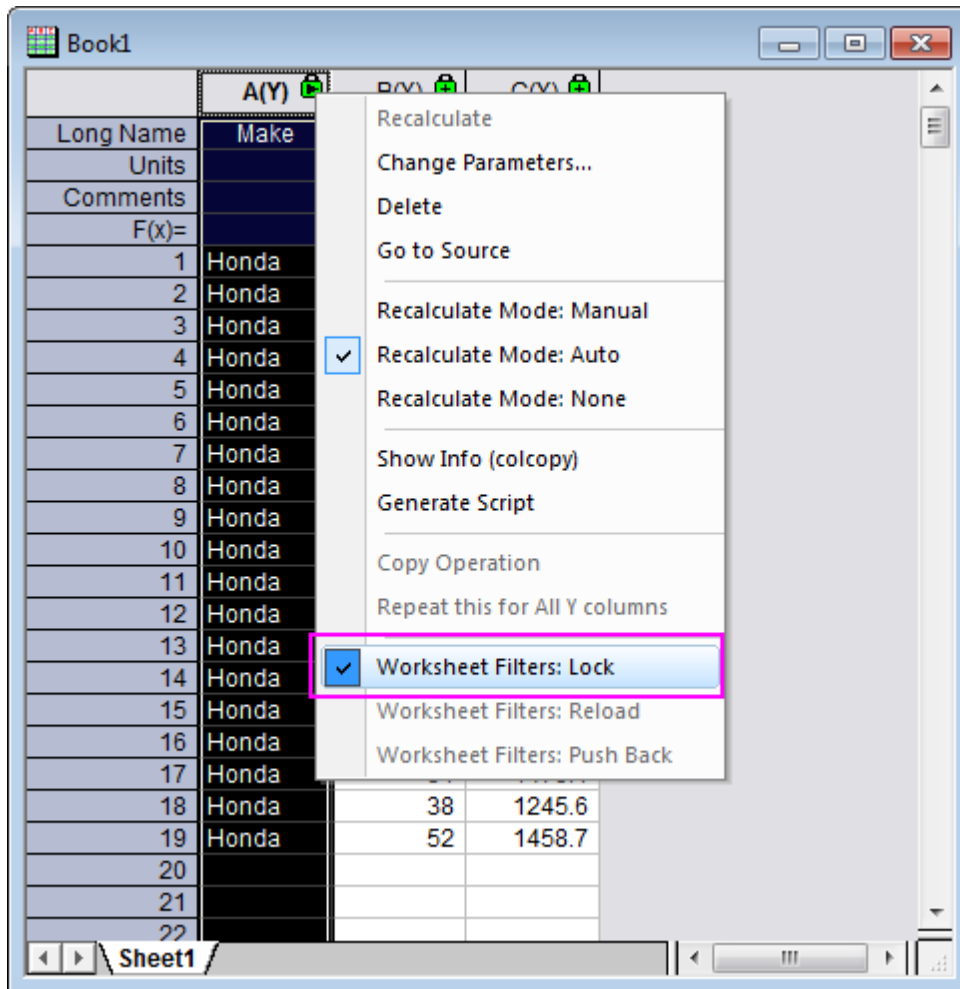

8. In the source worksheet, add Data Filter to **Power** column, and click on the filter icon to select **Greater Than....** In the **Simple Number Filter** dialog, set **Value** to 100, and click **OK**. The filter will show only the **Power** data above 100 in the original workbook but since the filter was locked in the copied workbook the data in it will no longer update.
9. The filter conditions on the original workbook were changed and in order to set them back to the way they are in the copied workbook, use **Push Back**. In the copied sheet, click on the green lock in column(A) and select **Worksheet Filters: Push Back** from the context menu. This will result in the data filter condition in the original workbook being pushed back so that the filter condition set on **Power** no longer applies.



The lock filters options are only available in the *new* sheet created by column copy. If you copy columns to the *same* worksheet, the options will not show in the **Recalculate** lock icon's context menu.

#### 4.6.4 Pivot Table

#### 4.6.4.1 Summary

The Pivot Table provides a quick way to summarize your data, and to analyze, compare, and detect relationships in your data. This tool can sort, count, sum, or compute minimum, maximum, or mean of data stored in a worksheet.

Minimum Origin Version Required: Origin 2015 SR0

#### 4.6.4.2 What you will learn

- How to summarize data by a Pivot Table.
- How to sort output by row or column totals in Pivot Table.
- How to combine small values in columns or rows, and custom extra value.

#### 4.6.4.3 Import Data from Database

1. Before creating a pivot table, we should can import data from database. Suppose we have already set up a database named *AdventureWorks2008R2* on a server machine - *myServer* - running SQL Server, with user name as "accounting", and password as "mydatabase".
2. To connect the database, we use a connection string:

```
Provider=SQLOLEDB.1;Password=mydatabase;Persist Security Info=True;  
  
User ID=accounting;Initial Catalog=AdventureWorks2008R2;Data  
Source=myServer
```

3. Activate an empty worksheet and open SQL Editor by clicking the **Open SQL Editor** button on the **Database Access** toolbar.

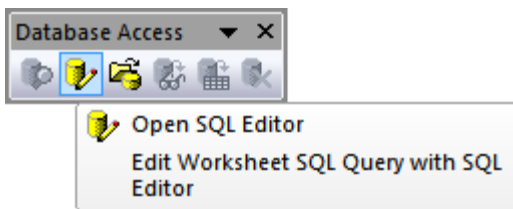

4. Select menu item **Edit Connection String...** from SQL Editor's **File** menu, in the open dialog, put the connection string (see step 1 above) to the text box. And then you can click the **Test** button to test if the connection is fine. If fine, click the **OK** button to connection to the database.

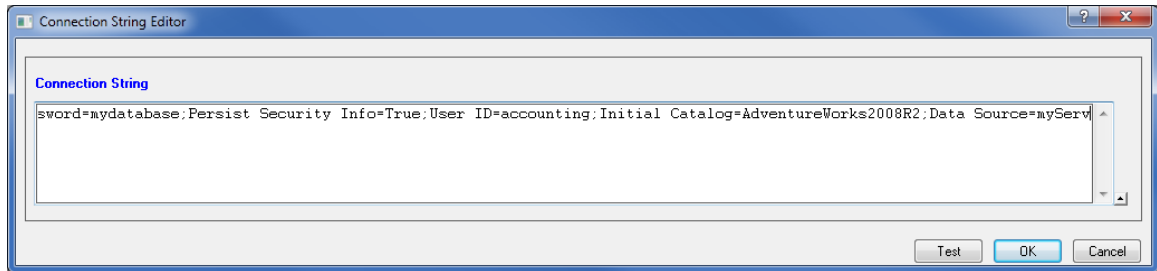

5. In the right text box, put the following SQL statements.
- 6.

```
SELECT

DatePart (yyyy, SOH.OrderDate) AS YEAR,

CR.Name As CustomerCountry,

    Pr.Name As ProductName,

    Pr.Color As ProductColor,

    PC.Name As ProductCategory,

    PS.Name As ProductSubcategory,

    SOH.OrderDate As OrderDate,

    SOD.OrderQty As OrderAmount,

    SOD.LineTotal As TotalCost

FROM Person.CountryRegion AS CR

INNER JOIN Person.StateProvince AS SP

ON SP.CountryRegionCode = CR.CountryRegionCode

INNER JOIN Person.Address AS A
```

```
ON A.StateProvinceID = SP.StateProvinceID

INNER JOIN Person.BusinessEntityAddress AS BEA

ON BEA.AddressID = A.AddressID

INNER JOIN Person.Person AS P

ON P.BusinessEntityID = BEA.BusinessEntityID

INNER JOIN Sales.PersonCreditCard AS PCC

ON PCC.BusinessEntityID = P.BusinessEntityID

INNER JOIN Sales.SalesOrderHeader AS SOH

ON SOH.CreditCardID = PCC.CreditCardID

INNER JOIN Sales.SalesOrderDetail AS SOD

ON SOD.SalesOrderID = SOH.SalesOrderID

INNER JOIN Production.Product AS Pr

ON Pr.ProductID = SOD.ProductID

INNER JOIN Production.ProductSubcategory AS PS

ON PS.ProductSubcategoryID = Pr.ProductSubcategoryID

INNER JOIN Production.ProductCategory AS PC

ON PC.ProductCategoryID = PS.ProductCategoryID

--WHERE SOH.OrderDate BETWEEN '1/1/2005' AND '12/31/2008'
```

7. Select menu **File: Save to Active Worksheet** to save these settings to the worksheet, and then select menu **Query: Import** to import the data into worksheet, and then close SQL Editor. We can see the imported data form the image below.



	A(X)	B(Y)	C(Y)	D(Y)	E(Y)	F(Y)
Long Name	YEAR	CustomerCountry	ProductName	ProductColor	ProductCategory	ProductSubcategory
Units						
Comments						
F(x)=						
1	2005	Canada	Road-150 Red, 62	Red	Bikes	Road Bikes
2	2005	France	Mountain-100 Silver, 44	Silver	Bikes	Mountain Bikes
3	2005	United States	Mountain-100 Silver, 44	Silver	Bikes	Mountain Bikes
4	2005	United States	Road-650 Black, 62	Black	Bikes	Road Bikes
5	2005	Australia	Mountain-100 Silver, 44	Silver	Bikes	Mountain Bikes
6	2005	United States	Road-150 Red, 44	Red	Bikes	Road Bikes
7	2005	Australia	Road-150 Red, 62	Red	Bikes	Road Bikes
8	2005	Australia	Mountain-100 Black, 48	Black	Bikes	Mountain Bikes
9	2005	Australia	Mountain-100 Silver, 38	Silver	Bikes	Mountain Bikes
10	2005	United States	Road-150 Red, 48	Red	Bikes	Road Bikes
11	2005	United States	Road-150 Red, 48	Red	Bikes	Road Bikes
12	2005	United Kingdom	Road-650 Red, 52	Red	Bikes	Road Bikes

8.

9. Click **Close** to close the dialog.

#### 4.6.4.4 Create a Pivot Table

The imported dataset is a total cost summary of three product categories(Bikes,Accessories, Clothing) in six different countries by year. Suppose now you want to create a pivot table to see the yearly *Sum of Total Cost* of different product category. Follow the steps below to create the pivot table.

1. Activate the Sheet1, select **Worksheet: Pivot Table** from the main menu to open the dialog. And specify the following settings in the dialog:
  - For **Pivot Table Row Source**, click the triangle button  to add column A.
  - For **Pivot Table Column Source**, click the triangle button  to add column E.
  - Select **Sum** with the **Summarize by** drop-down list. Then select column I for **Pivot Table Data Source**.
  - Expanding **Options** branch, check **Total for Rows** and **Total for Columns** check boxes, and select **Row Label Ascending** from the **Sort Output Rows** drop-down list.

**Recalculate** Manual

---

**Pivot Table Row Source** [Book1]Sheet1!A:"YEAR"

**Pivot Table Column Source** [Book1]Sheet1!E:"ProductCategory"

**Pivot Table Data Source** [Book1]Sheet1!"TotalCost"

**Summarize by** Sum

**Combine Smaller Values**

Combine Direction None

**Options**

Totals for Rows

Sort Output Rows Row Labels Ascending

Totals for Columns

Sort Output Columns Column Labels Ascending

Normalize by Column Totals None

Show Zeros when Empty

Row Source Extra Values

Column Source Extra Values

2. Click the **OK** button to create the pivot table. The table should like this:

	A(X)	B(Y)	C(Y)	D(Y)	E(Y)
Long Name	YEAR	Sum of TotalCost			
Units					
Comments		Accessories	Bikes	Clothing	Total_YEAR
F(x)=					
UserParam1					
1	2005	0	3.11421E6	0	3.11421E6
2	2006	0	6.26258E6	0	6.26258E6
3	2007	281089.1	8.96743E6	132728.69	9.38125E6
4	2008	391752.38	8.79936E6	192688.76	9.3838E6
5	Total_ProductCategory	672841.48	2.71436E7	325417.45	2.81418E7
6					
7					

4.6.4.5 Combine Small Values

In this section, we will show you how to present those categories with the percentage of the summarized value (Count/Sum/Mean/Min/Max) accounts for that of grand total exceeding a threshold percent, and combine small value categories into a default **Others** category.

1. Based on the above example, click on the lock icon in the **Pivot1** worksheet, and select **Change Parameters** to open the dialog again.

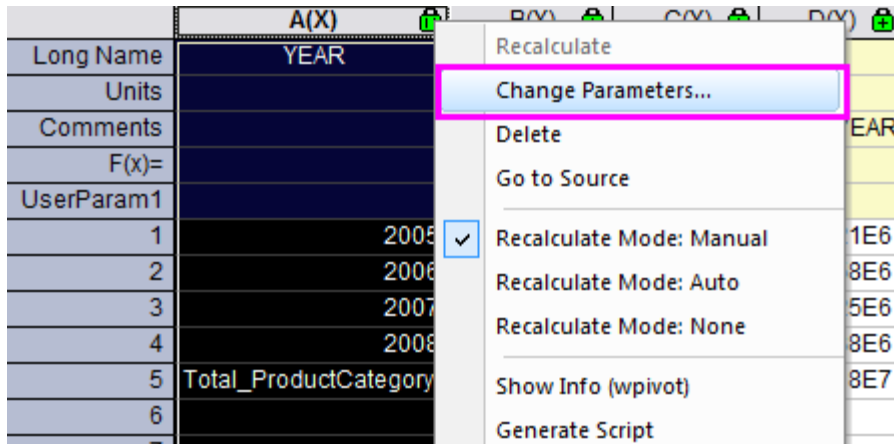

2. Specify the following settings in the dialog:
  - o Expanding **Combine Smaller Values** branch, select **Column** in the **Combine Direction** drop-down list,
  - o Select **By Percent of Grand Total** in **Mode** drop-down list.
  - o Enter **30** in **Percent** textbox and **Other Smaller Items** in the **Column Label** textbox.
  - o Expanding **Options** branch, uncheck the boxes of **Totals for Rows** and **Totals for Columns**

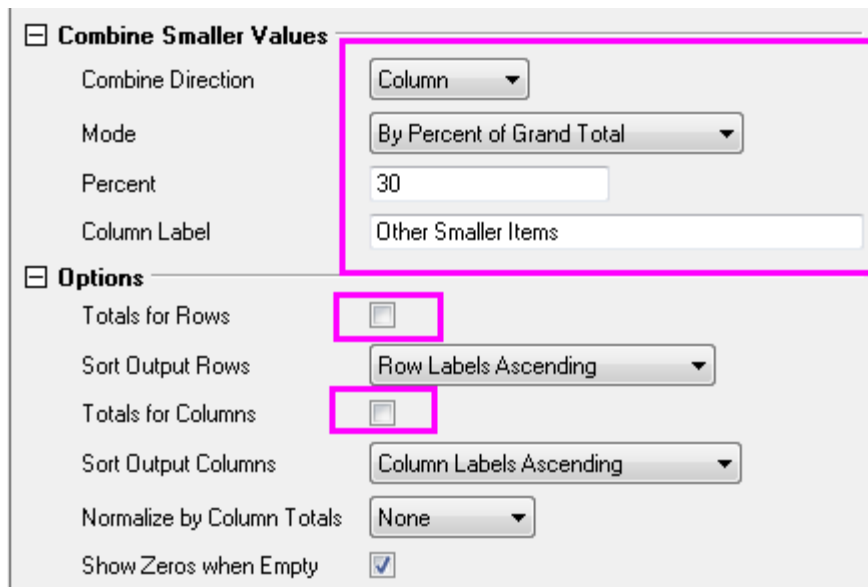

3. Click **OK** button. The pivot table shows the summarization of data by **Sum**. And only Category *Bikes* has the percent of grand total exceeding the threshold percent 30 %, other smaller categories has been

reduced into Category **Other Smaller Items**.

	A(X) 	B(Y) 	C(Y) 
Long Name	YEAR	Sum of TotalCost	
Units			
Comments		Bikes	Other Small
F(x)=			
UserParam1			
1	2005	3.11421E6	0
2	2006	6.26258E6	0
3	2007	8.96743E6	413817.79
4	2008	8.79936E6	584441.14
5			
6			

#### 4.6.4.6 Extra Categories Source

In this section, we will show you how to present those categories that are missing in the source data sheet with ' **Column Source Extra Value**. This is useful when you want to ensure all needed categories will be presented in the result pivot table that might be used for later plotting.

Suppose we want to know the *Sum of Total Cost* of different product categories before *Year* 2007. Follow the steps below to create the pivot table.

- To filter the years before 2007, we use the data filter. Go to Sheet 1 and select **Col A**. Click  button in the main menu bar. Click again the filter icon on **Col A** and select **Less Than**. Customize the pop-out filter dialog as follow, then click OK to close the dialog.

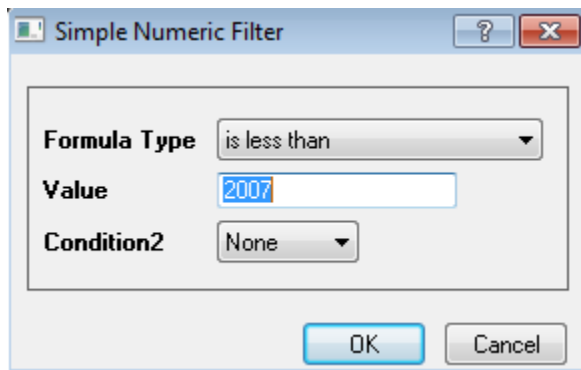

- Click on the lock icon in the **Pivot1** worksheet, and select **Recalculate**. As shown in the following pivot table, only *Bikes* is presented here, because other two product categories do not has any cost data record



in Year 2005 and 2006.

	A(X)	B(Y)
Long Name	YEAR	Sum of Total
Units		
Comments		Bikes
F(x)=		
UserParam1		
1	2005	3.11421E6
2	2006	6.26258E6
3		
4		
5		

- Back to **Pivot1** worksheet, select col(b) and then click **Plot > 2D: Bar: Column** to plot a column graph(*Graph1*).
- Next we want to add two missing categories back into the pivot table. Click on the lock icon in the **Pivot1** worksheet, and select **Change Parameters**. Customize the dialog as follow, click OK to close the dialog. The pivot table would look as follow.

**Options**

Totals for Rows

Sort Output Rows

Totals for Columns

Sort Output Columns

Normalize by Column Totals

Show Zeros when Empty

Row Source Extra Values

Column Source Extra Values

**Separate extra values by '|', for example A|B|C**  
**Combine different column/row info by '.', for example, A\_1|A\_2**

The pivot table would look as follow.

Long Name	YEAR	Sum of TotalCost			
Units					
Comments		Accessories	Bikes	Clothing	Other Smaller Items
F(x)=					
UserParam1					
Filter	Less than 2007				
1	2005	0	3.11421E6	0	0
2	2006	0	6.26258E6	0	0
3	2007	281089.1	8.96743E6	#####	0
4	2008	391752.38	8.79936E6	#####	0
5					
6					
7					
8					

5. Back to **Pivot1** worksheet again. Click again the filter icon on **Col A** and select **Clear Filter** from the pop-up menu to remove the filter. Then select all columns to plot a column graph(*Graph2*). The graph would show the missing categories.
6. Back to **Pivot1** worksheet again, right click the grey area and select **Add Graph** to add Graph2 onto the **Pivot1** worksheet

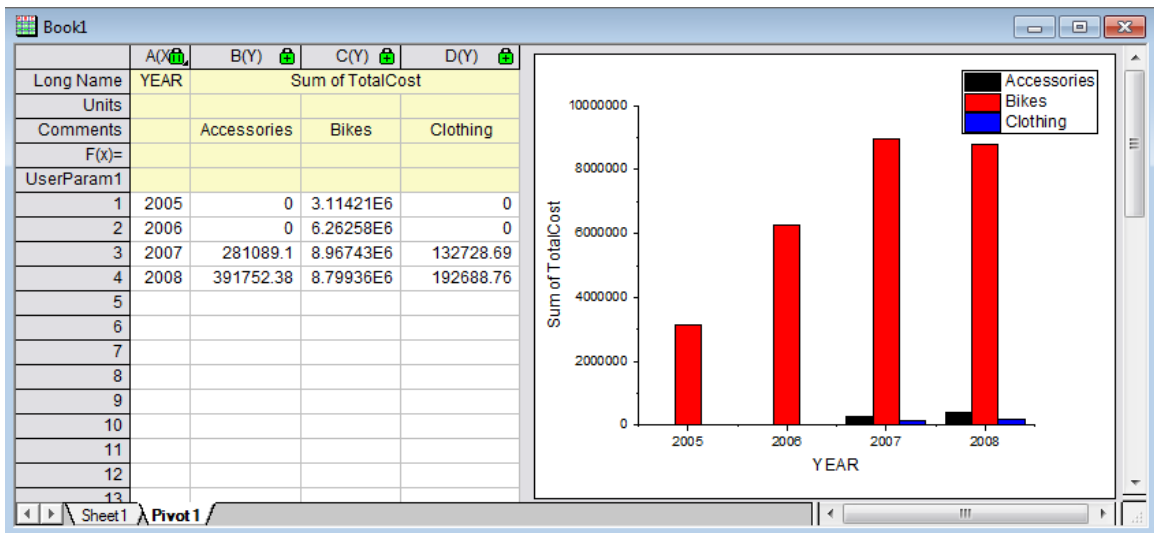

Year filtering can also be obtained in **Database**. In this case, you can customize the favorable time period by rewriting this script:

```
--WHERE SOH.OrderDate BETWEEN '1/1/2005' AND '12/31/2008'
```

#### 4.6.4.7 Create analysis template

In this section we will show you how to create analysis template for the pivot table, reimport data from database and reuse the analysis template to create pivot table for new data.

1. Activate the Book1, click **File: Save Workbook as template** and save it as *SumTotalCost.ogw*.
2. Open a new OPJ file and then click **File: Open** to open *SumTotalCost.ogw*.
3. To change the data source as *AdventureWorks2008* in database,
  - Activate Sheet1 and open SQL Editor by clicking the **Open SQL Editor** button .
  - Click **File: Edit Connection String** then type the following string in the open dialog, click **Test** then click OK to connect the database.

```
Provider=SQLOLEDB.1;Password=mydatabase;Persist Security Info=True;
User ID=accounting;Initial Catalog=AdventureWorks2008;Data Source=myServer
```

- Back to the **SQL Editor** dialog, On the right panel, rewrite the last script as

```
--WHERE SOH.OrderDate BETWEEN '1/1/2001' AND '12/31/2004'
```

- Select menu File: Save to Active Worksheet to save these settings to the worksheet, and then select menu Query: Import to import the data into worksheet, and then close SQL Editor. We can see the imported data form the image below.

	A(X)	B(Y)	C(Y)	D(Y)	E(Y)
Long Name	YEAR	CustomerCountry	ProductName	ProductColor	ProductC
Units					
Comments					
F(x)=					
Filter					
1	2001	Canada	Road-150 Red, 62	Red	Bikes
2	2001	France	Mountain-100 Silver, 44	Silver	Bikes
3	2001	United States	Mountain-100 Silver, 44	Silver	Bikes
4	2001	United States	Road-650 Black, 62	Black	Bikes
5	2001	Australia	Mountain-100 Silver, 44	Silver	Bikes
6	2001	United States	Road-150 Red, 44	Red	Bikes
7	2001	Australia	Road-150 Red, 62	Red	Bikes
8	2001	Australia	Mountain-100 Black, 48	Black	Bikes
9	2001	Australia	Mountain-100 Silver, 38	Silver	Bikes
10	2001	United States	Road-150 Red, 48	Red	Bikes
11	2001	United States	Road-150 Red, 48	Red	Bikes
12	2001	United States	Road-150 Red, 48	Red	Bikes

4. To update the pivot table, go to Sheet'*Pivot1* , click the yellow lock and select **Recalculate**. The pivot table would be updated according to new data.
5. To update the embedded graph,
  - o double click the embedded graph and a floating chart would pop up.
  - o Select the graph and click **Rescale** button to refresh . The floating chart would be updated too.
  - o click the arrow button at the upper right corner of the floating chart to put it back to the worksheet. The worksheet would look as follow.

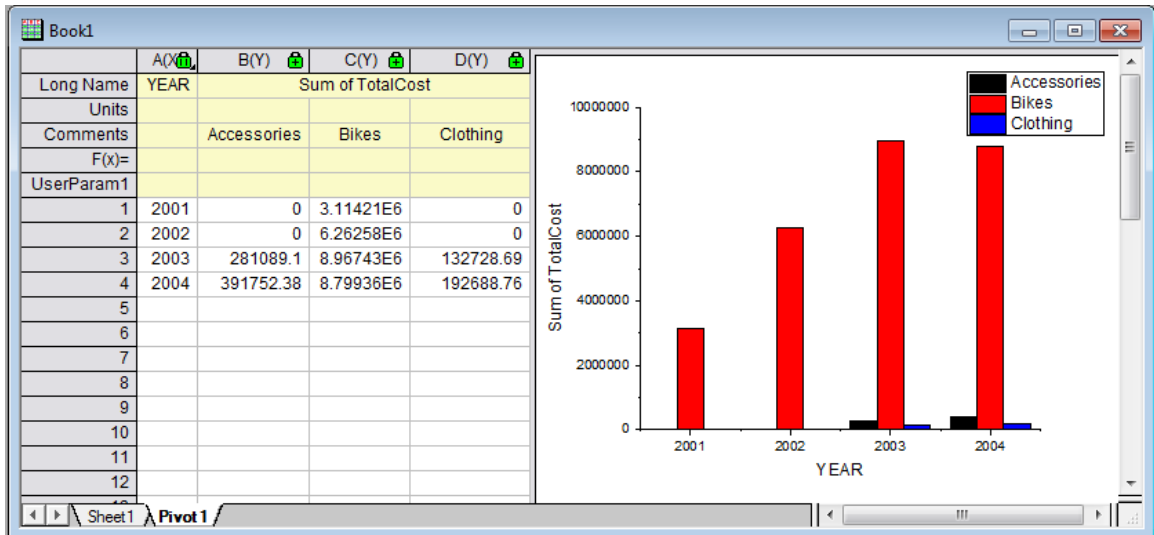

#### 4.6.5 Categorical Values Ordering and Sharing

#### 4.6.5.1 Summary

Categorical values are used to store categories information in a column. In Origin, you have the capacity to manually add, remove, order categories in a column and the categorical information stored in the column will be carried over to result sheet during analysis. You can easily save categories into a text file and share across columns or worksheets.

Minimum Origin Version Required: Origin 2015 SR0

#### 4.6.5.2 What you will learn

- How to manipulate categorical values
- How to order categorical map
- How to share categorical values

#### 4.6.5.3 Manipulate Categorical Values

1. To import the Origin sample data, select **Data: Import from File: Excel(XLS, XLSX, XLSM...)** from the Origin menu. Browse to **<Origin Program Folder>\Samples\Statistics** and select *HouseholdCareSamples.xls*. Click the **Add File(s)** button. Make sure that the **Show Options Dialog:** check box is selected. Click the **OK** button to open the **impMSEExcel** dialog.
2. Specify the following settings in the **impMSEExcel** dialog:
  - Under **File Info**, expand the **HouseholdCareSamples.xls** branch. Unselect **File Sheet(s)**, then check the check boxes next to **HQ Family Mart** and **TX Trust-Mart**.
  - In the **Header Lines** branch, select **1** in **Number of Subheader Lines** drop-down list and then **1** for **Long Names**. Check **Apply Header to All Sheets** box.
  - Click **OK** to import the data into Origin.
3. On the **HQ Family Mart** worksheet, highlight column *Category* (long name) and right click to select **Set As Categorical**. Double click on the **Unsorted** on **Categories** label row to bring up **Categories** dialog.
4. Now we want to only keep **Household Clean, Kitchen Clean, Dishwashing Liquid, Laundry Powder** and **Fabric Conditioner** five categories and order them as listed. To do so, first check **Customize Categories (Add, Delete, Set Arbitrary Order)** box, hold Ctrl key to select unwanted categorical values

and use **Remove** button  to remove them.

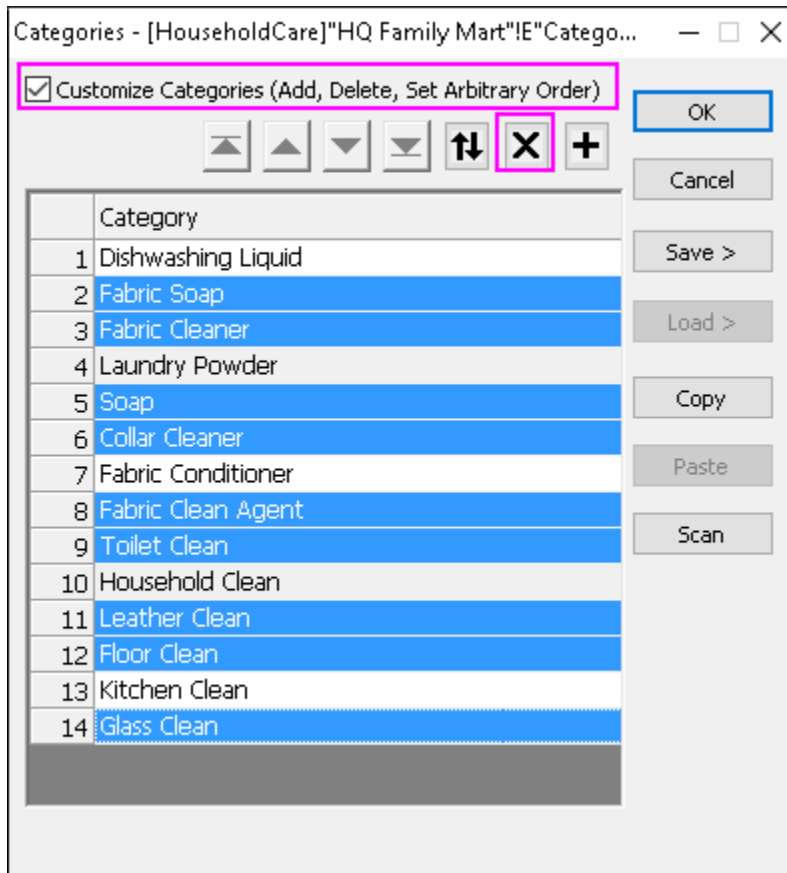

5. Drag the row headings or use the , ,  and  buttons to reorder, as shown below:

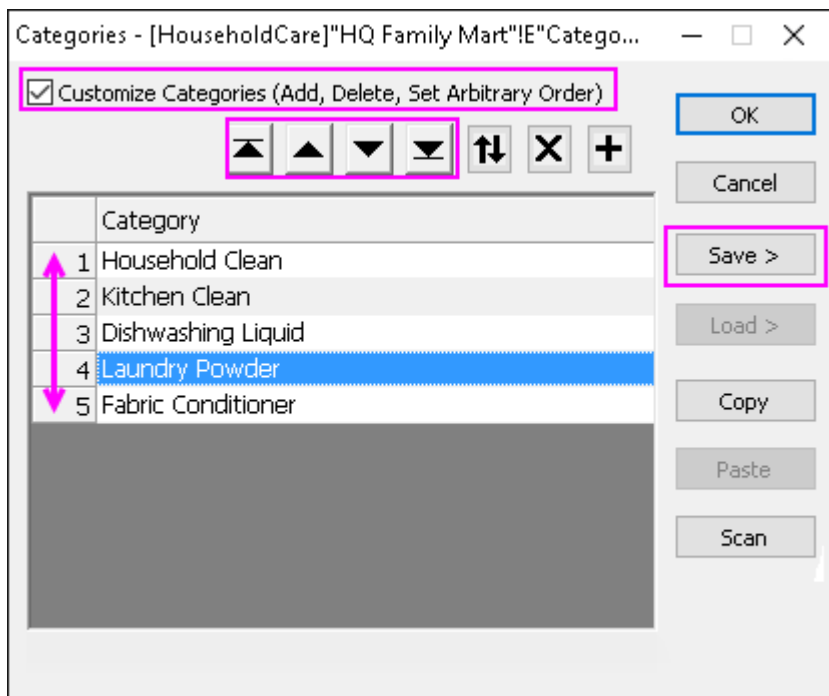

6. Then click **Save >** button and select **Save As** to bring up **Categories Save as** dialog. Enter *HouseholdCare Category* as **Name** and click **OK** to save the categorical values in a text file under displayed **Save Path** for sharing later.

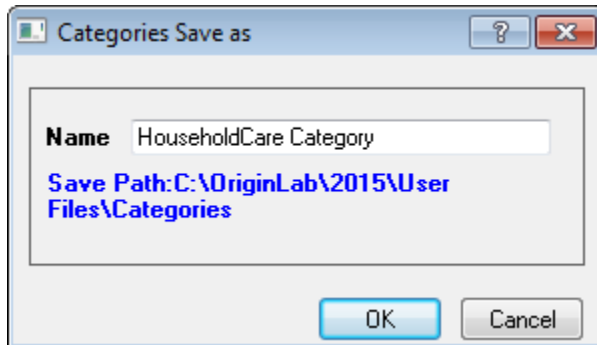

7. Click **OK** to close **Categories** dialog box.
8. Next we want to know the total number of items in each of the five categories specified in step 4 and make a column plot of results. To do so, highlight column *Number* (long name) and go to **Statistics: Descriptive Statistics: Statistics on Columns: Open Dialog...** to bring up **Statistics on Columns** dialog, click right-sided triangle icon on **Group** row to select **E(Y):Category** as grouping column and click **OK** to close the dialog. In the prompt dialog, click **OK**.
9. Switch to *DescStatsQuantities1* flat sheet, select column *N total* (long name) and go to **Plot: 2D: Bar: Column** to create the column plot.
10. Double click on the X axis tick labels to bring up **Tick Labels** page on **Axis** dialog, go to **Format** tab and select **45** from **Rotate (deg.)** drop-down list and click **OK** to close the dialog.
11. Double click on the graph to bring up **Plot Details** dialog, expand **Layer1** node to go to its subnode. In the Pattern tab, expand the **Color** drop-down list in the **Fill** group, select **By Points** tab, and choose the color **Black** under **Increment from** list to set it as the starting color. Click **OK** to close dialog.

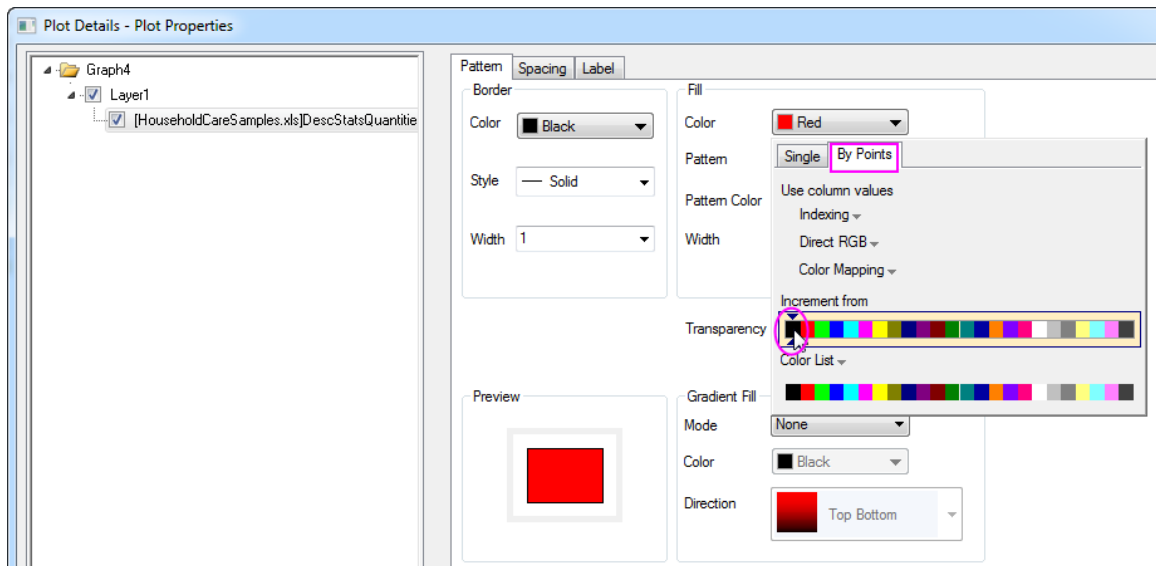

12. Right click on the page and select **Fit Page To Layers...** and click **OK** in the appeared dialog to bring the X axis label into page. Delete the legend, use **Text** tool to add *HQ Family Mart* as graph title. Move X axis

title and added graph title to proper positions, and the column plot looks like the following:

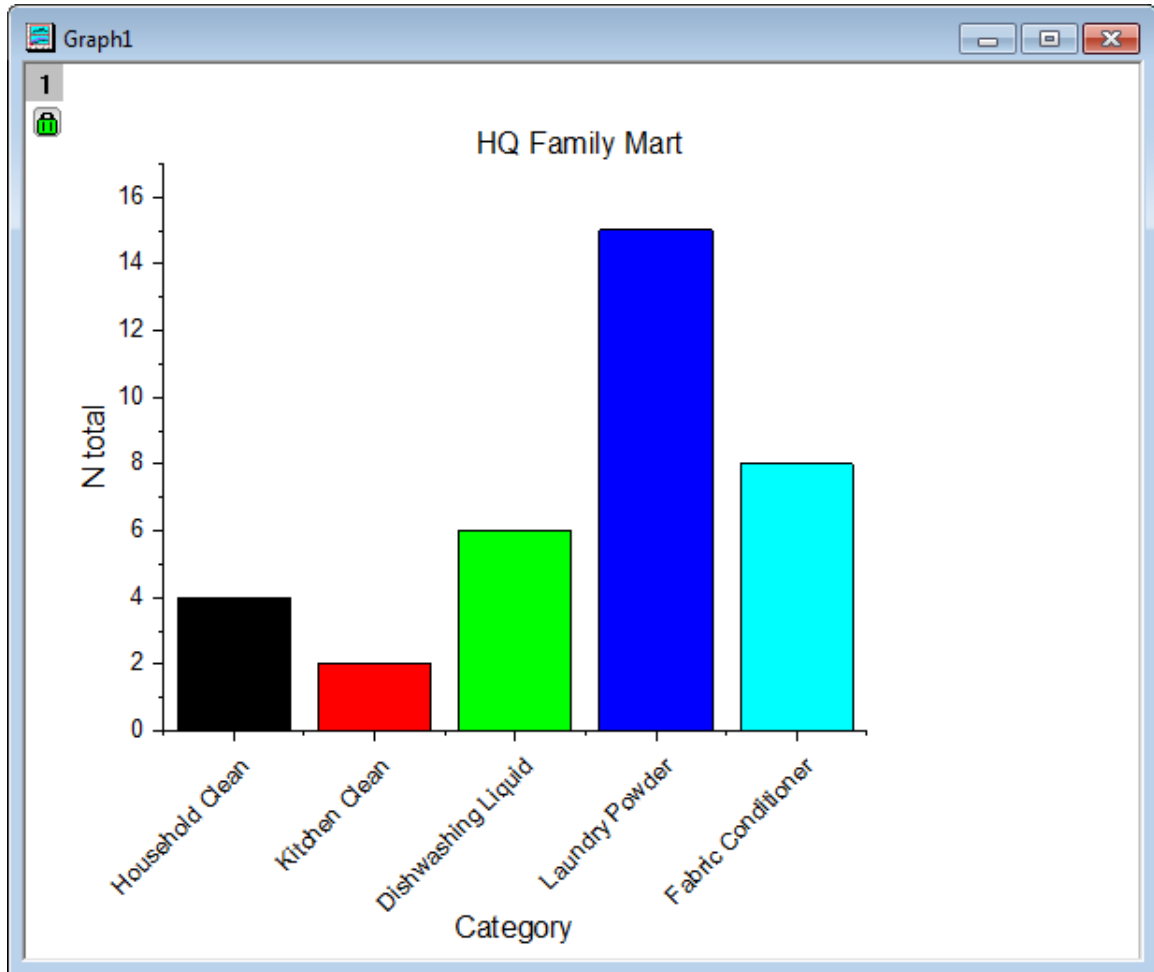

#### 4.6.5.4 Share Categorical Values

1. Continue from the section above, now we want to share the categories saved earlier with second worksheet *TX Trust-Mart*. To do so, activate *TX Trust-Mart* sheet and highlight column *Category* (long name) and right click to select **Set As Categorical**.
2. Double click on the *Unsorted* on **Categories** label row to bring up **Categories** dialog, check **Customize Categories (Add, Delete, Set Arbitrary Order)** box and click **Load >** button on the right and select



appeared *HouseholdCare* Category file.

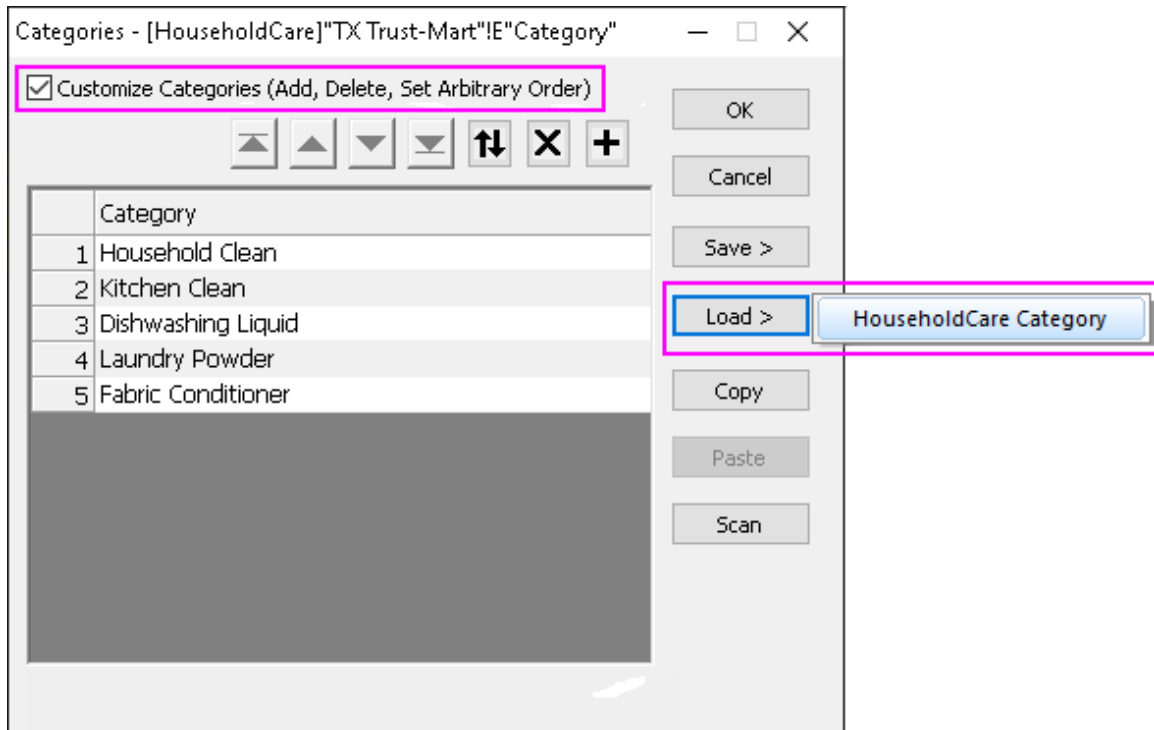

- Follow steps 7-12 in above section and add text *TX Trust-Mart* instead of *HQ Family Mart* in step 12, we will obtain a column plot from *TX Trust Mart* source sheet as following:

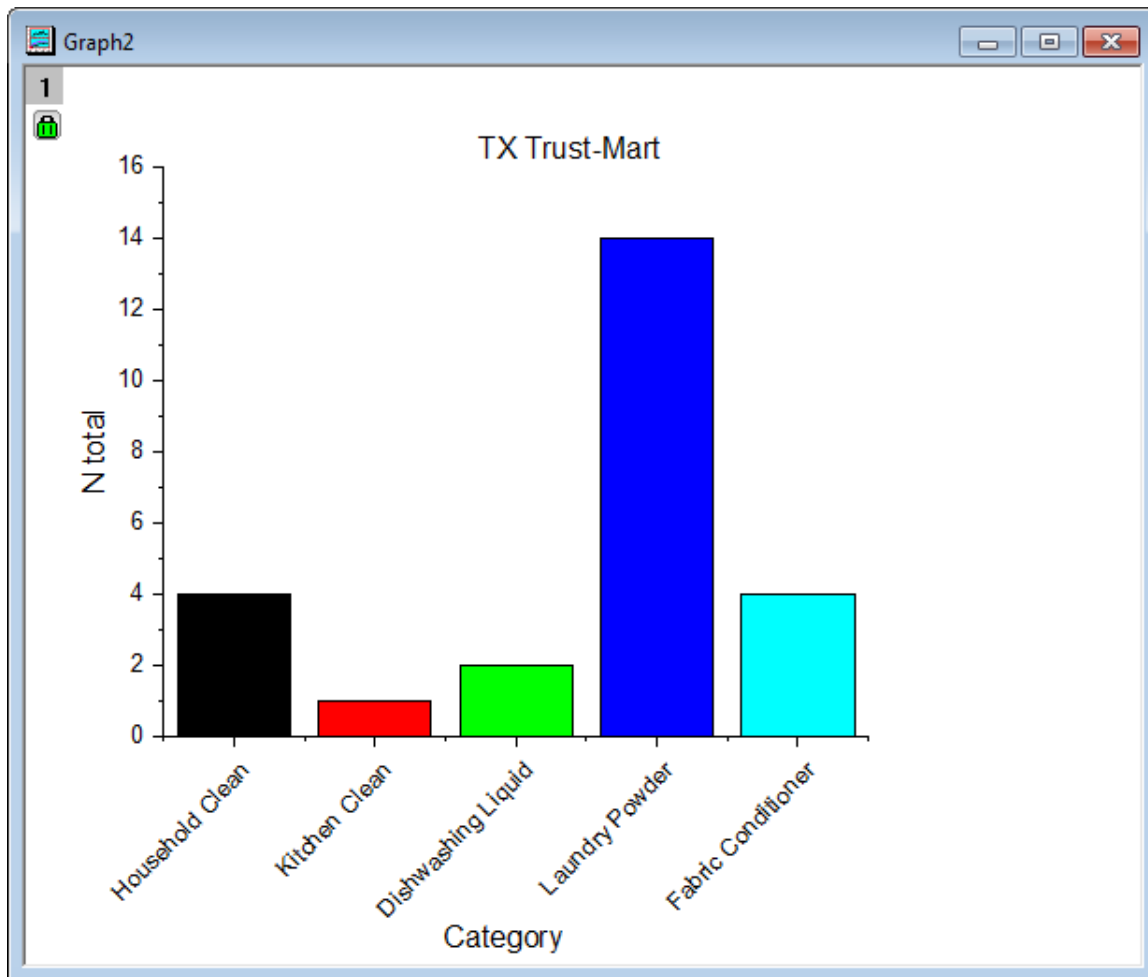

## 4.7 Analysis Templates

### 4.7.1 Analysis Templates

- [Creating and Using Analysis Templates](#)
- [Creating Analysis Templates using Set Column Value](#)
- [Creating a Custom Report Sheet](#)

### 4.7.2 Creating and Using Analysis Templates

#### 4.7.2.1 Summary

Routine tasks can be simplified by creating an Analysis Template. Such templates can contain multiple analysis results and also custom report sheets. A new instance of the template can then be opened at any time and source data can be changed to update all analysis results and custom reports.

Minimum Origin Version Required: Origin 2015 SR0

#### 4.7.2.2 What you will learn

- How to create an analysis template (OGW)
- How to re-use an analysis template with new data

#### 4.7.2.3 Steps

##### 4.7.2.3.1 Importing Data

1. Start with a new workbook.
2. Click the **Import Single ASCII** button  on the **Standard** toolbar to open the ASCII dialog box. Browse to the *<Origin EXE folder>\Samples\Curve Fitting\* folder and select the file **Sensor01.dat**. Make sure that **Show Options Dialog** is selected and click the **Open** button. This will open a dialog for specifying import settings.
3. In the **impASC** dialog, expand the **Rename Sheets and Books** node and clear the **Rename Sheet with (Partial) Filename** box.
4. Click the arrow button next to **Dialog Theme**, and select **Save to <Sheet>** in the fly-out menu. This will save your import settings to the worksheet.
5. Click **OK** to import the file to **Sheet1**.
6. Double-click on the worksheet tab and rename the sheet as **Data**.

##### 4.7.2.3.2 Performing Analysis

1. Highlight column B and use the **Analysis: Fitting: Linear Fit** menu item to open the **Linear Fit** dialog box.
2. Set **Recalculate** to **Auto**, accept other default settings and click **OK** to perform a linear fit. A hierarchical report sheet will be added to the book, with result tables and embedded graphs.
3. Answer Yes to the attention message to go to the **FitLinear1** report sheet.
4. Double-click to open the graph under the **Fitted Curves Plot** tree node. This graph contains the data plot and fitted curve.
5. Click the menu item **View:Show:Frame** to show the graph frame.
6. Double click on the data plot to open the **Plot Details** dialog box. In the left panel, select **FitLine** to open the **Page Properties** dialog box. Go to the **Legends/Titles** tab and clear the **Indicate Active Dataset** check box, then press **OK** to close the dialog.
7. Select **Format: Axes: Y Axis...** in the main menu to open the **Axis** dialog box. Verify that the **Type** under **Major Ticks** node is set to **By Increment** and set the **Value** to **5**. Use Shift/Ctrl key to select both **Horizontal** and **Vertical** icons on the left panel and change the **Rescale** mode to **Auto** for both X and Y axes. Click **Apply** to apply settings and choose **OK** to close the dialog.
8. Manually move the legend object to a suitable position so all text is visible then delete the result table box on the graph. The final graph should look like the image below:

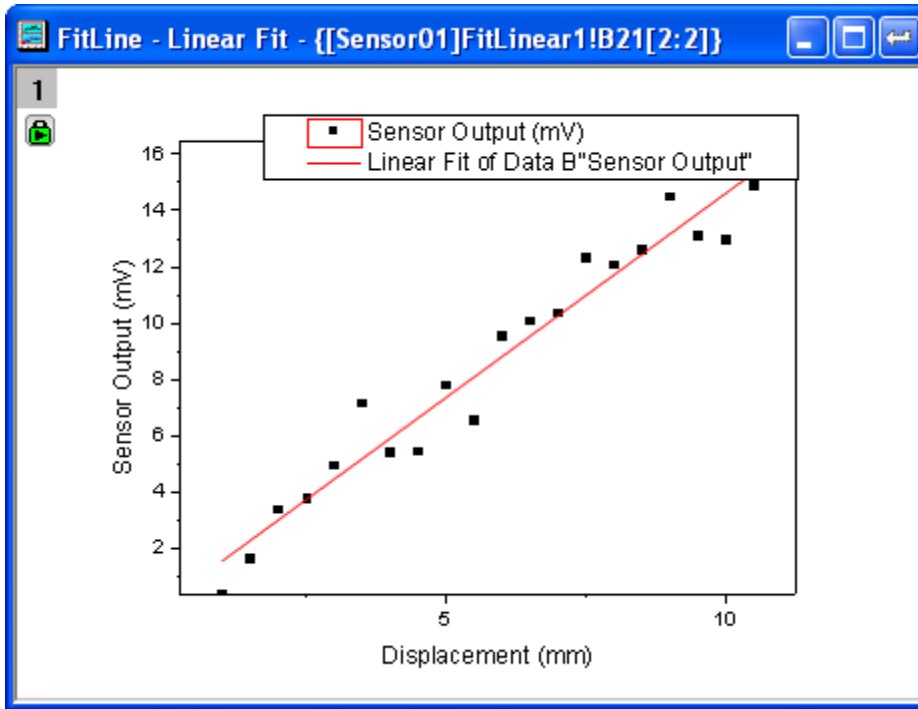

- Put this graph back into the result sheet by clicking on the restore button  at the top right of the title bar.

#### 4.7.2.3.3 Saving an Analysis Template

- Activate the workbook and select **File: Save Workbook as Analysis Template**.
- Browse to the desired location and enter a file name, for example **MySensorData**, and press the **Save** button.
- Now the file **MySensorData.OGW(U)** is saved as an Analysis Template. This template can be re-used in the future to carry out similar analyses.

#### 4.7.2.3.4 Re-using the Analysis Template

- Start a new project, then select the menu item **File: Recent Books**. From the fly-out menu options, select the Analysis Template **MySensorData.ogw(u)** that was saved earlier.

- Make the **Data** worksheet active, and click the **Import Single ASCII** button . Browse to the file **Sensor02.dat** under the *<Origin EXE Folder>\Samples\Curve Fitting\* path and import the file.

**Note:** You can also locate the **Sensor02.dat** file in your local drive, drag and drop it into this **Data** sheet to import.

- Since the **Recalculate** mode was set to **Auto**, the linear analysis will be performed automatically for the new data.

- Go to the **FitLinear1** worksheet and under the **Fitted Curves Plot** node, double-click to open the graph and view the updated results.



The Analysis Template can be used in the batch processing of similar data, see [this tutorial](#) for details.

### 4.7.3 Creating Analysis Templates using Set Column Value

#### 4.7.3.1 Summary

This tutorial will demonstrate how to add a column, set up **Before Formula Script** and have that script run whenever data changes in other columns. This technique can be used to create an **Analysis Template** for repeated analysis of similar data.

Minimum Origin Version Required: Origin 8.0 SR6

#### 4.7.3.2 What you will learn

- How to use Set Column Values to create an analysis template
- How to select rows via the *Go to* function

#### 4.7.3.3 Steps

- Import the data from `\Samples\Statistics\automobile.dat` into a newly created workbook, as below. In this example, we will extract data, according to the *Make* column, into different worksheets.

	A(X)	B(Y)	C(Y)	D(Y)	E(Y)
Long Name	Year	Make	Power	0~60 mph	Weight
Units			kw	sec	kg
Comments					
1	1992	Buick	132	14	2238
2	1992	Acura	154	12	2324
3	1992	GMC	158	13	1531
4	1992	Chrysler	132	10	2088
5	1992	Kia	121	12	1202
6	1992	Suzuki	106	10	1417
7	1992	Volvo	95	14	1661
8	1992	Mercedes	132	14	2208
9	1992	Acura	128	13	1412
10	1992	Isuzu	124	17	1518

- Add an empty column to the worksheet and bring up the **Set Column Values** dialog of the column. In the **Before Formula Script** box, enter the script below.

```
// Data range on which to perform discrete frequency count

range makeCol = !col(make);

// Worksheet to be extracted

range sourceWks = !;

// Clear worksheets

int sheetNum = page.nlayers;

int colNum = wks.ncols - 1;

if (sheetNum>1)

{

    for (jj=2; jj<=sheetNum; jj++)

    {

        layer -d 2;

    }

}

// Tree variable to hold discfreqs outputs

tree tr;

// Perform discrete frequency count
```

```

discfreqs irng:=makeCol rd:=tr;

// String array to get result from tree

StringArray sa;

sa.append(tr.FreqCount1.Data1);

if( sa.GetSize() != NANUM )

{

    // Loop to extract data

    for (ii=1; ii<=sa.GetSize(); ii++)

    {

        string sn$ = sa.GetAt(ii)$;

        // Extract condition string

        string cond$ = "makeCol$ = " + sn$;

        // Create worksheet with different Make name

        newsheet name:=sn$ cols:=colNum outname:=on$ active:=0;

        // Extract data

        wxt test:=cond$ iw:=sourceWks c2:=colNum ow:=on$;

    }

}

```

This script will first perform a discrete frequency count on the *Make* column to get distinct values for *Make*. It will then create a new worksheet for each brand and extract data into these sheets.

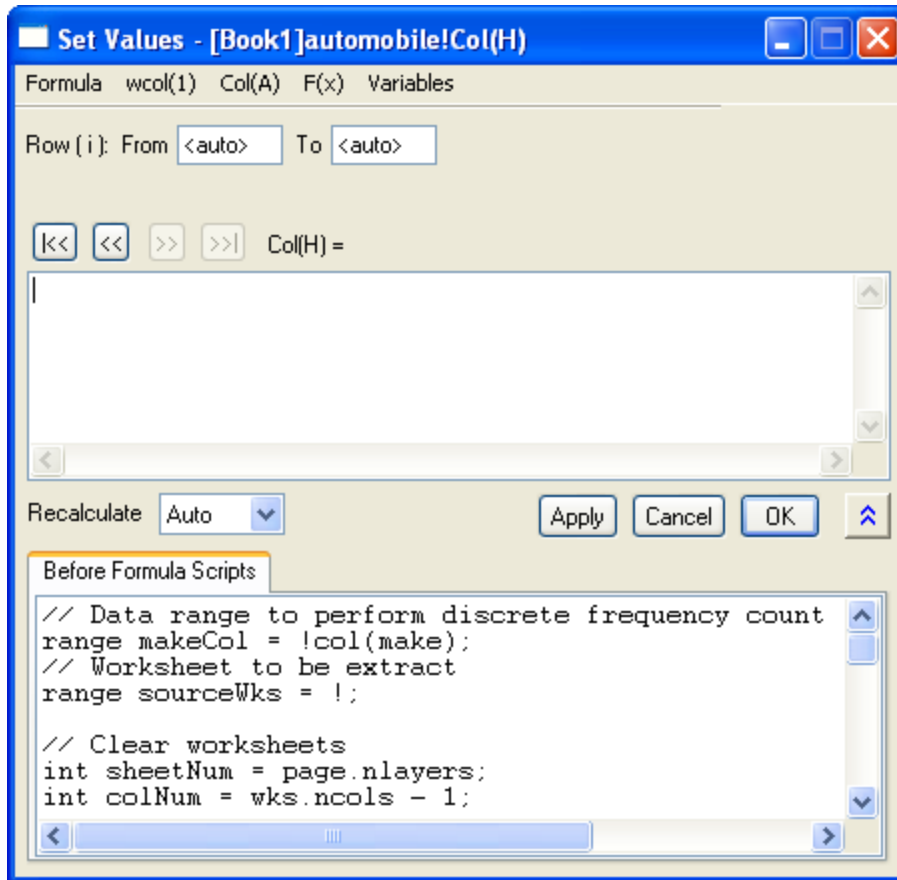

3. Make sure the recalculate mode is set to **Auto** and click **OK**. The data will be separated into different worksheets. Then the empty column (H) with a green lock icon indicates that this procedure can be updated automatically.

	E(Y)	F(Y)	G(Y)	H(Y)
Long Name	Weight	Gas Mileage	Engine Displacement	
Units	kg	mpg	cc	
Comments				
1	2238	11	5736.5	
2	2324	11	5212	
3	1531	10	5900.4	
4	2088	12	6277.4	
5	1202	12	5736.5	
6	1417	14	5736.5	
7	1661	13	5031.7	
8	2208	12	5736.5	
9	1412	12	5736.5	
10	1518	13	5900.4	



4. There are 18 makes of cars in the source data, so 18 new worksheets were created. Now we can check whether auto-update works.  
Go to the **Honda** tab. Notice that there are 19 rows.
5. Switch to the first sheet. Scroll down and delete the last row.

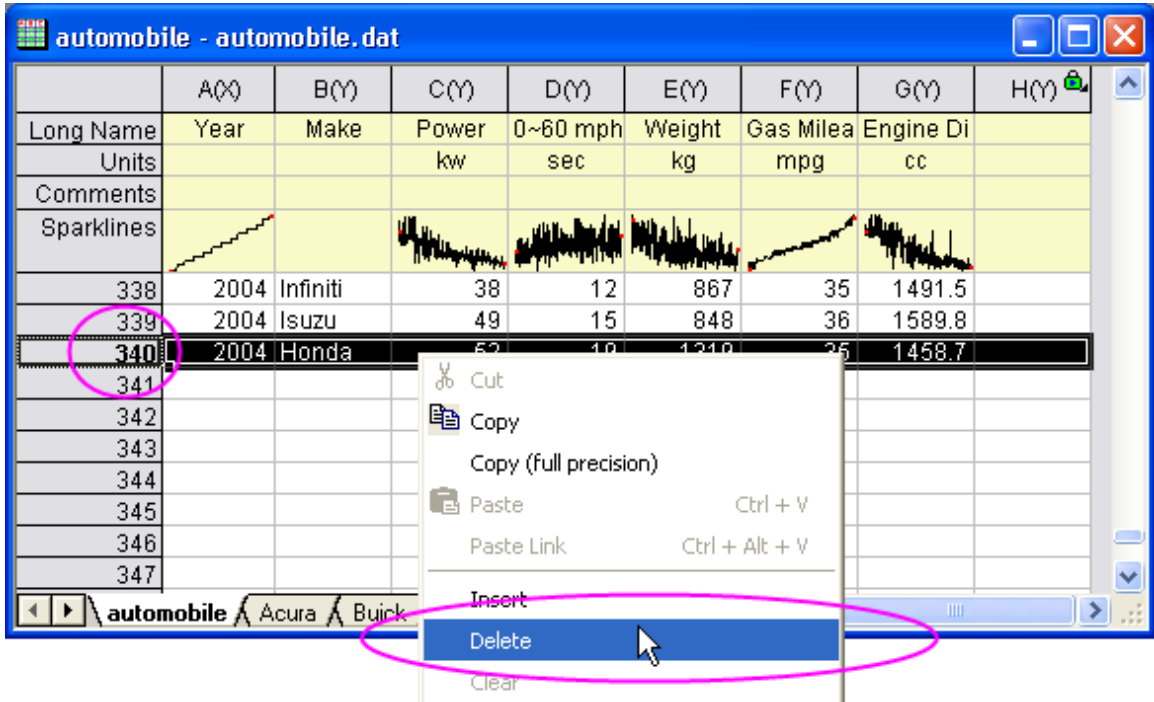

Then auto-update will be triggered. Go to the **Honda** tab. You will see there are only 18 rows.

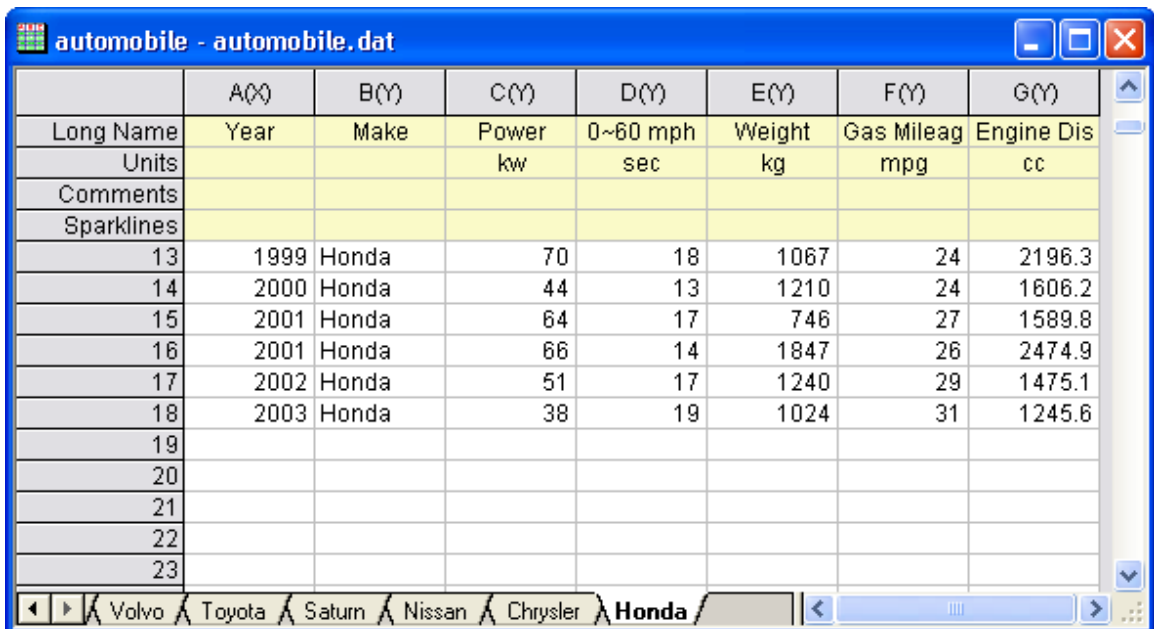

#### 4.7.4 Creating a Custom Report Sheet

#### 4.7.4.1 Summary

Worksheets in Origin can be customized by merging cells and coalescing various objects such as graphs, external images, links to variables and tables/cells in other sheets, into a custom report.

This tutorial will show you how to add a custom report to an existing analysis template. You can then import new data, recalculate results, and export or print the custom report.

**Note:** This tutorial suggests that you can drag-and-drop data files onto Origin. If you do so, [please do not run Origin as administrator](#).

Minimum Origin Version Required: Origin 9.0 SR0

#### 4.7.4.2 What you will learn

- How to create a custom report sheet
- How to save a custom report as part of an Analysis Template (OGW) and re-use it with new data

#### 4.7.4.3 Steps

**Note:** Please complete the previous tutorial named "[Creating and Using Analysis Templates](#)" in which an analysis template named **MySensorData.OGW** is created.

##### 4.7.4.3.1 **Importing Data**

1. Using the **File:Open** menu item, set the **Files of type** drop-down to **Workbooks (\*.ogw)**, then navigate to and open the Analysis Template **MySensorData.OGW**. This analysis template was saved with a linear fit analysis for column B of the first worksheet, and a customized embedded graph with the data and the linear fit line (note that templates do not contain data, so at this point, you see no data and no results).
2. Make the **Data** worksheet active, and click the **Import Single ASCII** button  to directly import the file **Sensor01.dat** under *<Origin EXE Folder>\Samples\Curve Fitting\* path.

**Note:** You can also locate the **Sensor01.dat** file in your local drive, drag and drop it into this **Data** sheet to import.

##### 4.7.4.3.2 **Creating a Custom Report Sheet**

1. Right-click on the **Data** worksheet and select **Add** to add a new worksheet. Rename this worksheet as **Custom Report**.
2. Activate the **Custom Report** sheet and choose **Format:Worksheet** (or hit **F4**) to open the **Worksheet Properties** dialog. Go to the **Size** tab and under the **Size** node, set **Row Number** as **20** and **Column Number** as **9**. Then go to the **Miscellaneous** tab and check the **Auto Add Rows** check box. Click **OK** to apply these settings and close the dialog.
3. In the worksheet, click and drag on the row headers for **Long Name**, **Unit**, **Comments** and **F(x)=** to select these four rows. Then right click and select **Hide** from the context menu. This hides the four rows from the worksheet.

4. Highlight the range of the cells in the first three rows for all columns and click the **Merge Cells** button  located in the **Styles** toolbar to merge the cells. Enter the text **Sensor Data Analysis Report** in this merged cell.
5. In the 5th row, merge the cells in columns G and H. Repeat for the 6th row. In row 5, column F, enter the text **File Name:** In row 6, column F, enter the text **File Date:**.
6. Right click the merged (column G and H) cells in row 5 and choose **Insert Variables** from the context menu. Make sure the dialog settings look like those in the image below and insert the **FILENAME** variable into this cell.

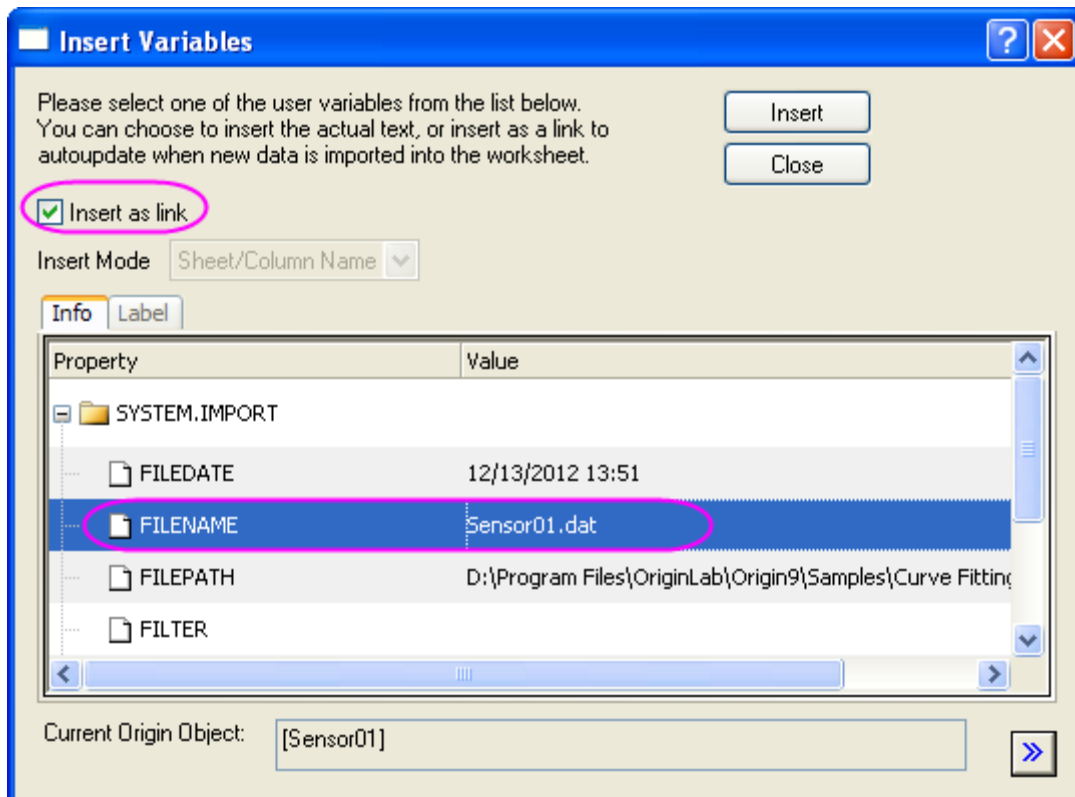

7. Right click the merged (column G and H) cells in row 6 and choose **Insert Variables** from the context menu. Insert the **FILEDATE** variable following the settings in the image below:

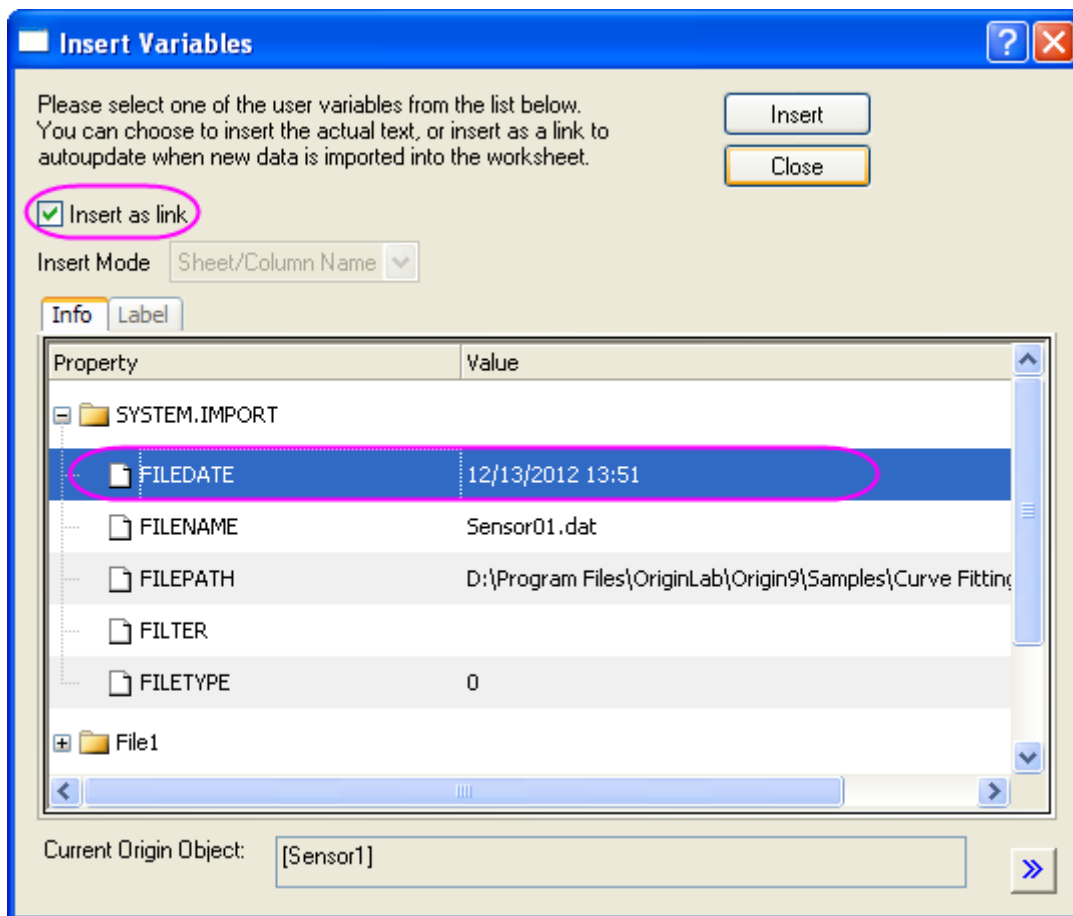



8. Right click on the cell containing the date information and choose **Format Cells** from the context menu. Change the **Format** drop-down to **Date** and click **OK**.
9. Go to the **FitLinear1** worksheet and locate the **Parameters** table. Click the triangle button next to it and choose **Copy Table** from the fly-out menu.
10. Go to the **Custom Report** sheet and select the 9th row in column E. Right click and choose **Paste Link**. Clear the pasted text **Sensor Output** in column E by pressing the **Delete** key.
11. In the 13th row, merge the cells in columns G and H. Do the same in the 14th row.
12. Return to the **FitLinear1** sheet and in the **Statistics** table, select the two data cells for **Pearson's r** and **Adj. R-Square**. Right click and choose **Copy** to copy only these two cells.
13. Go to the **Custom Report** sheet and select the merged cell in the 13th row, then right-click and choose **Paste Link**. The two merged cells are filled with corresponding values. Enter the text **Pearson's r** and **Adj. R-Square** in the cells to the left of these pasted values.
14. In the 8th row, merge the three cells in columns F, G and H. Do the same in rows 12 and 20. Enter the text **Fit Parameters**, **Fit Statistics** and **Report Date: \$(@D, D1)** in rows 8, 12 and 20, respectively.
15. Right click on the merged cells in row 20 and choose **Set Data Style:Rich Text** from the context menu. By enabling rich text, the string **\$(@D,D1)** will display as the actual system date.
16. Hold the CTRL key and select all cells with numeric values, then right-click and choose **Format Cells** in context menu, then choose **Set Decimal Places=** from the **Digits** drop-down menu, and enter **3** as **Decimal Number**, and press OK.

17. Using buttons in the **Style** and **Format** toolbars, change cell borders, font sizes, styles and colors to customize the report as in the image below. You may also need to manually adjust the width of some columns to ensure that all text is displayed.

	A()	B()	C()	D()	E()	F()	G()	H()	I()
1	Sensor Data Analysis Report								
2									
3									
4	--	--							--
5	--	--	--	--		File Name:	Sensor01.dat		--
6			--	--		File Date:	12/13/2012		
7						--	--		
8						<b>Fit Parameters</b>			
9							<b>Value</b>	<b>Standard Error</b>	
10					--	<b>Intercept</b>	0.119	0.504	
11					--	<b>Slope</b>	1.448	0.078	
12						<b>Fit Statistics</b>			
13						<b>Pearson's r</b>	0.975		
14						<b>Adj. R-Square</b>	0.947		
15						--			
16						--			
17						--			
18						--			
19						--			
20									Report Date: Thursday, May 23, 2013

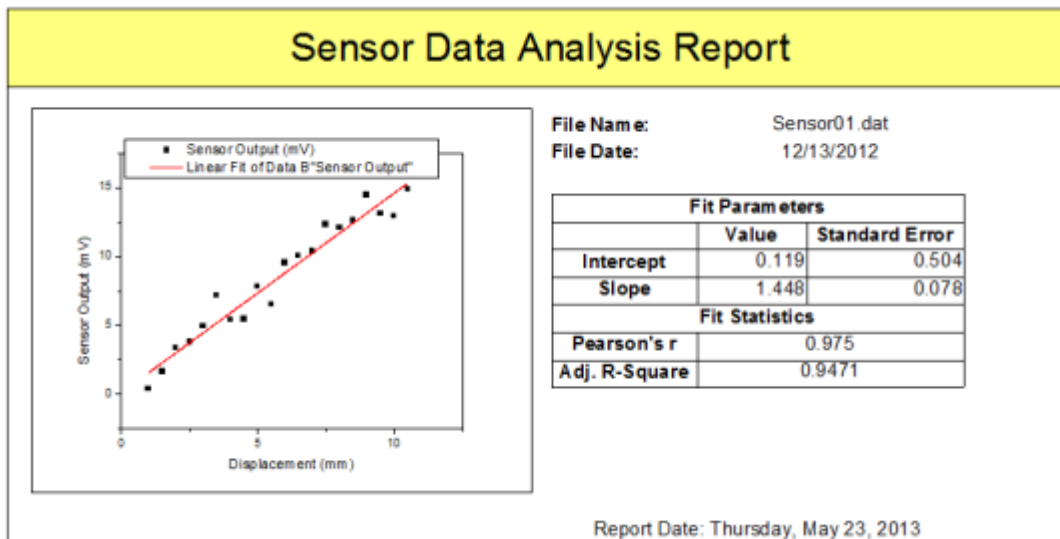
18. Go to the **FitLinear1** sheet and double-click on the graph under **Fitted Curves Plot** to open the embedded graph. Right click on the graph's title bar and choose **Duplicate** from the context menu to duplicate the graph window (Graph1). Double click on the axis of duplicated graph to bring up **Axis** dialog. Go to **Scale** tab under both **X Axis** and **Y Axis** and choose **Auto** from the **Rescale** drop-down list. Then close the original embedded graph window.
19. Return to the **Custom Report** worksheet, right click on the gray area of this worksheet and select **Add Graph** from context menu. In the **Graph Browser**, select **Graph1** which was created by duplicating the embedded graph. Click **OK** to add this graph to this worksheet as a floating chart.
20. You can manually resize and move this floating chart using its anchor points and position it anywhere in the worksheet.
21. Go to **Format:Worksheet** (or press **F4**) to open the **Worksheet Properties** dialog. In the **View** tab, under the **Show Grid Lines** node, clear the check boxes next to **Column Grid** and **Row Grid**. On the **Format** tab, make sure **Apply To** is set to **Data**, and select **Show Missing as Blank** to show missing values as blank instead of displaying the "--" characters. Press **OK** to close this dialog.
22. Select **File:Print Preview** to preview the custom report. It should look similar to the image below:



Beginning with Origin 2018b all merged cells within a *selected* range, including non-contiguous blocks of merged cells, can be un-merged by clicking the **Merge cells** button  on the **Style** toolbar.

#### 4.7.4.3 Saving the Analysis Template

1. Activate the workbook and select **File:Save Workbook as Analysis Template**.
2. Browse to a desired file path and enter the file name **SensorDataReport** and click **Save**.
3. You can use this **SensorDataReport.OGW** as an Analysis Template for future analyses of similar data, and the custom report will also be included in the workbook.

#### 4.7.4.3.4 Re-using the Analysis Template

1. Start a new project and then select the menu item **File: Recent Books** and from the fly-out options select the Analysis Template **SensorDataReport.ogw** which was saved earlier.
2. Make the **Data** worksheet active, and click the **Import Single ASCII** button  to directly import the file **Sensor02.dat** under *<Origin EXE Folder>\Samples\Curve Fitting\* path.

**Note:**You can also locate the **Sensor02.dat** file in your local drive, drag and drop it into this **Data** sheet to import.

3. The linear fit results and the custom report are automatically generated using the newly imported data.

## 4.8 Analysis Themes

### 4.8.1 Summary

In Origin 8, analysis procedures can be controlled by Themes. Themes are actually XML files which save settings in the analysis dialog. For example, after performing the analysis, there will now be a <Last Used> theme for this dialog which has saved the most recently used settings. You can assign a proper name for the theme and use it in the future.

For this tutorial, the Statistics on Columns dialog will be used to demonstrate how to create and use an analysis theme. This analysis provides descriptive statistics about the data such as mean, standard deviation, minimum, maximum, and more. For visualization, a histogram or box chart can also be created in the Analysis Result Sheet.

Minimum Origin Version Required: Origin 8.0 SR6

## 4.8.2 What you will learn

This tutorial will show you how to:

- Perform simple descriptive statistics
- Create an Analysis Theme
- Use the theme

## 4.8.3 Steps

### 4.8.3.1 Save the analysis procedure as Theme

1. Start with a new workbook and import the file `\Samples\Statistics\automobile.dat`.
2. Highlight column C and use the menu item **Statistics: Descriptive Statistics: Statistics on Columns** to open the dialog.
3. Select **Quantities** tab, then expand the **Moments** tree node, and check the *N Total*, *Mean*, *Standard Deviation*, *SE of Mean* and *Sum* box.
4. Expand the **Plots** tree node, and check the *Histograms* and *Box Charts* check boxes. You will then get the corresponding histogram as well as box chart graphs.
5. Your selections in this analysis dialog can be saved as your theme, so that you may easily repeat the procedure. Click the arrow to the right of Dialog Theme and choose **Save as...** ...

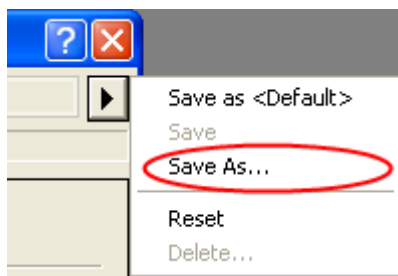

... to bring up this dialog:

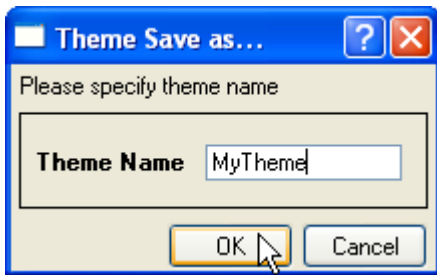

6. Type a proper theme name, such as "MyTheme" and click **OK**.
7. Click the **OK** button in the **Statistics on Columns** dialog. Results are reported to a new worksheet named DescStatsOnCols1.

Descriptive Statistics

	N total	Mean	Standard Deviation	SE of mean	Sum
Power	340	79.85	28.07561	1.52261	27149



You can save a customized dialog theme as default, so it will be used every time you open the dialog of analysis operation. To do this, choose **Save as <Default>** to save the current dialog theme as the default setting of this dialog. It is also possible to delete the default theme and roll back to system default, to do this, choose **Delete** from the fly-out menu.



You can also save your [Analysis Report Sheet](#) configuration to a Theme file by expanding or collapsing output nodes, then choosing **Save Node Configuration** from the shortcut menu. For more information, see **Save Node Configuration** in [this table](#).

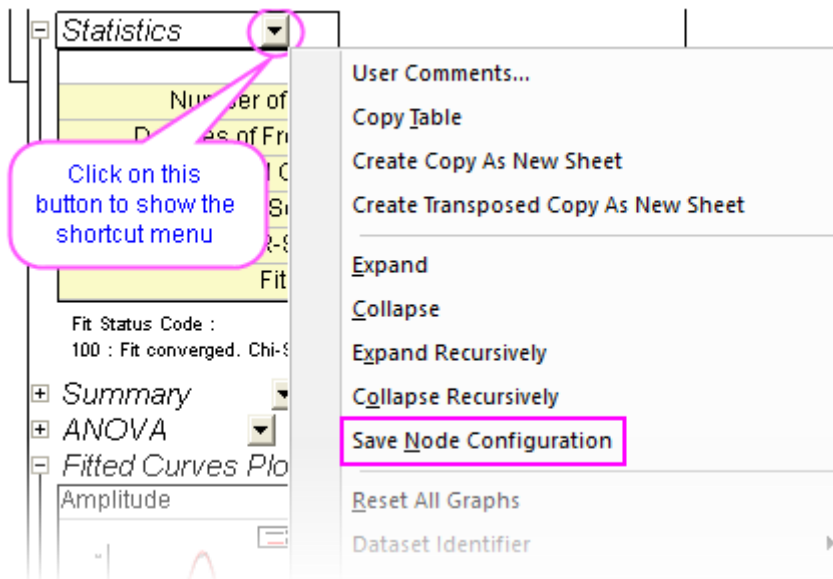

4.8.3.2 Repeat the analysis procedure by Theme



Once you save a theme, there are many ways to use it. For example, you can highlight column E and perform the same statistical analyses on it.

- Open the **Statistics on Columns** dialog from the **Most Recently Used** items at the bottom of the **Statistics** menu. Most of the menu accessible dialogs can be opened from MRU menus.

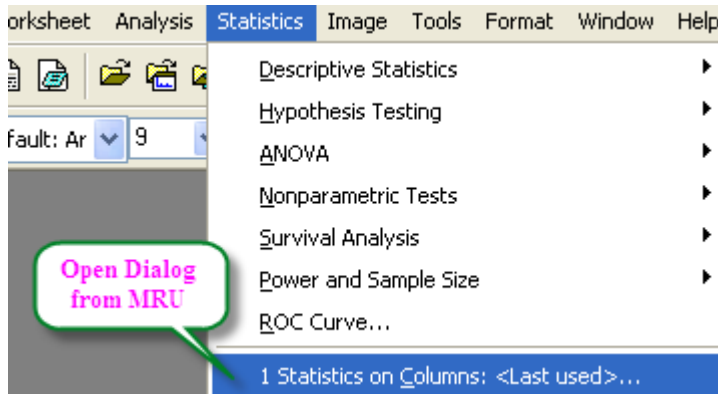

When you open the dialog from MRU, the default theme is <Last Used>. To use the **MyTheme** theme, select *MyTheme* from the **Dialog Theme** shortcut menu. The settings from that theme will then be displayed in the dialog. Click the **OK** button to do the analysis.

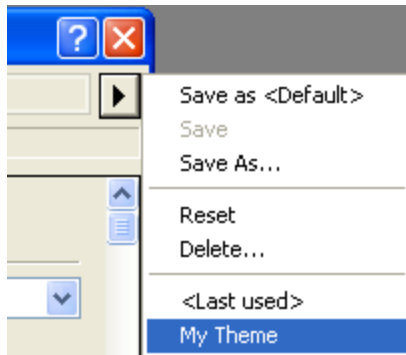

- Another way to apply the analysis theme is to use the cascaded menu item. Once you use an analysis dialog for the first time after installation, or save a theme for a dialog, there will be one more menu level added. You can choose the *MyTheme* menu.

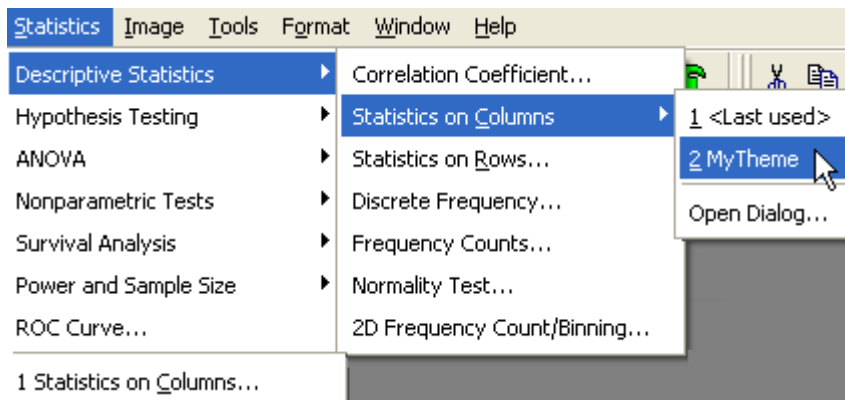

When selecting, *Open Dialog...*, the dialog will open to the <Factory Default> theme. To change the settings of your theme, you can select your theme name from the **Dialog Theme** shortcut menu inside the dialog, make changes, and resave the theme. Alternatively, to open a dialog with a saved theme without performing the analysis, hold down the *shift* key while selecting the theme from the menu. This will bring up the dialog with your theme applied so you can make changes as needed.

## 4.9 Batch Processing

### 4.9.1 Batch Processing

- [Batch Processing Multiple Datasets](#)
- [Batch Processing Multiple Files using Analysis Template](#)
- [Batch Processing with Summary Report in External Excel File](#)
- [Batch Processing with Word Template for Reporting](#)
- [Batch Processing Grouped Datasets Using Analysis Template with Multi-Data Sheets](#)

### 4.9.2 Batch Processing Multiple Datasets

#### 4.9.2.1 Summary

Origin can perform batch analysis of multiple files or datasets, [using a pre-saved Analysis Template](#) or current active workbook with analysis operations. This tutorial will focus on batch analysis of multiple datasets using current active workbook/analysis template.

#### 4.9.2.2 What You Will Learn

This tutorial will show you how to:



- Perform analysis on one sample data and create new result sheet with the results you desired
- Perform batch processing multiple datasets using current active workbook containing analysis operations with recalculation.

4.9.2.3 Steps

## 4.9.2.3.1 Perform fitting on one data firstly

1. Start with a new workbook, click the button  and browse to <Origin EXE folder>\Samples\Curve Fitting\ folder and select file **Sensor01.dat** to import data with default import settings.
2. Highlight col(B) to select **Analysis: Fitting: Linear Fit...** to open the **Linear Fit** dialog. Set **Recalculate** to **Auto**, and then go to the tab **Fit Control**, check **Fix Intercept** check box and set **Fix Intercept at** as **0**.
3. Click **OK** button to perform the fitting.
4. Go to the sheet **FitLinear1**, click the downward arrow aside the **Summary** branch to select **Create Copy as New Sheet**. A new sheet "Summary" will be created with the fitting results. Go to this new sheet, rename it to "Result" and delete the col(A).

## 4.9.2.3.2 Performing the fitting on multiple datasets with Batch Processing tool

1. With the workbook active. elect **File: Batch Processing** from the menu or click the **Batch Processing** button  to open the **Batch Processing** dialog.
2. Select the **Repeatedly Import into Active Analysis Template Window** check box for the **Batch Processing Mode**.  
**Note:** You can also [save an analysis template and use it with Load Analysis Template option](#) in your Batch Processing routines.
3. Select **Import From Files** for the **Data Source** drop-down list.
4. Click on the **Browse** button  in the **File List** section and select all sensor data *Sensor##.dat* from the <Origin EXE Folder>\Samples\Curve Fitting folder.
5. Select **File Name** for the **Dataset Identifier**.
6. Make sure the **Data Sheet** drop-down is set to **Sensor01**.

7. Make sure the **Result Sheet** drop-down is set to **Summary**.

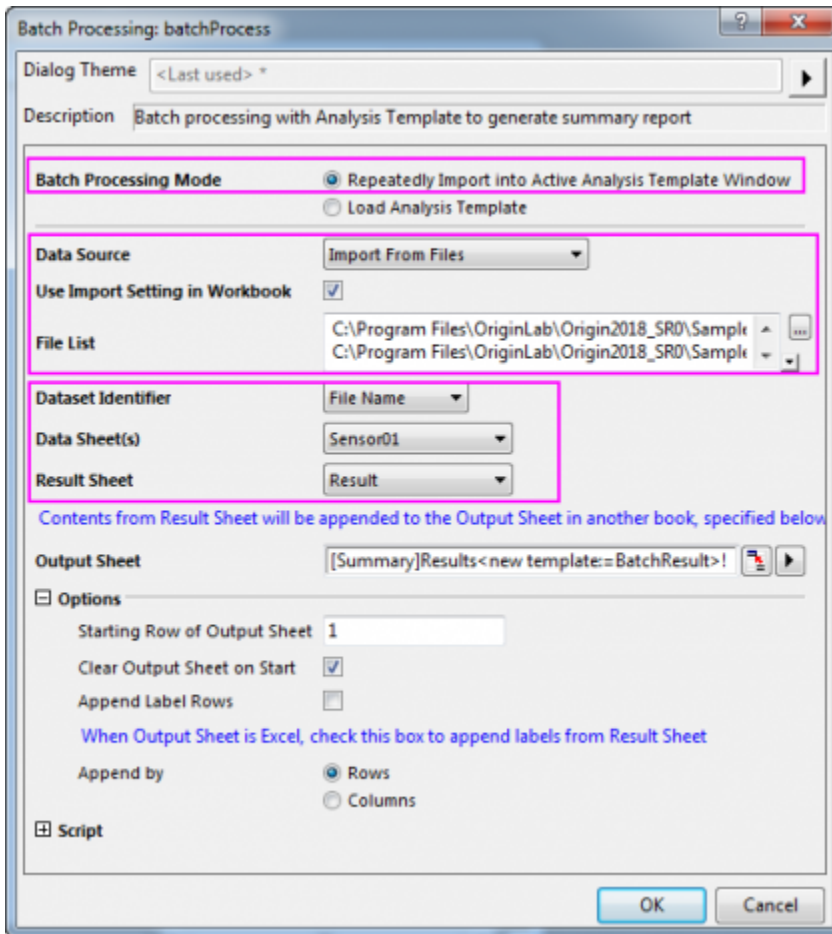

8. Click **OK**. All sensor data will be analyzed, and a workbook "Summary" will be generated, displaying the summarized analysis results based on the **Result** sheet in the original worksheet.

	A(Y)	B(Y)	C(yE $\pm$ )	D(Y)	E(yE $\pm$ )	F(Y)
Long Name	Dataset ID	Intercept	Intercept	Slope	Slope	Statistics
Parameters	Value	Standard Error	Value	Standard Error	Adj. R-Square	
1	Sensor01.dat	0	--	1.46454	0.03425	0.98917
2	Sensor02.dat	0	--	2.50729	0.0282	0.99748
3	Sensor03.dat	0	--	4.50124	0.03048	0.99908
4	Sensor04.dat	0	--	1.3868	0.06444	0.95852
5	Sensor05.dat	0	--	2.82436	0.01652	0.99932
6	Sensor06.dat	0	--	2.9465	0.03261	0.99756
7	Sensor07.dat	0	--	3.392	0.02625	0.9988
8						
9						
10						

## 4.9.3 Batch Processing Multiple Files using Analysis Template

### 4.9.3.1 Summary

Origin can perform **Batch Analysis** utilizing an previously created **Analysis Template** by either importing multiple files, or loading existing datasets.

This tutorial focuses on the former case of batch analysis - importing multiple files with a common (ASCII) file structure, then repeatedly applying the analysis template for the linear curve fitting to the every imported data file.

#### 4.9.3.2 What You Will Learn

This tutorial will show you how to:

- Make an analysis template which contains a Result Summary Sheet to collect the output of batch processing.
- Perform batch processing with multiple data files using an analysis template

#### 4.9.3.3 Steps

In general, the procedure of batch processing is divided into two parts:

1. In preparation, make an **Analysis Template** which is an empty framework of a workbook. This workbook template contains a Result Summary Sheet to collect the outputs of your analysis (e.g., linear curve fitting) during batch processing.
2. Perform the **Batch Processing** using the prepared analysis template for multiple data files.

#### 4.9.3.3.1 Preparing an Analysis Template containing a Result Summary Sheet to Collect Outputs of Batch Processing

Before performing the batch processing, we need to make an analysis template which contains a result worksheet (which may contain a graph in a worksheet cell as shown in this tutorial) to collect the outputs of batch processing inside the analysis template workbook.

**Note1:** Hereafter, you can find the location of **<Origin EXE Folder>** by choosing "**Help: Open Folder: Program Folder**" menu in Origin. Similarly for **<User Files Folder>**, choose "**Help: Open Folder: User Files Folder**" menu.

**Note2:** If you want to skip this preparation step to make the analysis template, you can use the ready-to-use analysis template file, **<Origin EXE Folder> \Samples \Batch Processing \MySensorData.OGWU** (or .OGW in Origin 2017 or before). Also, if you only want learn how to make the analysis template regardless the batch processing, refer to the tutorial, "[Creating and Using Analysis Templates](#)".

1. **Let us import a data file as a model.** In a new workbook, choose "**Data: Import from File: Single ASCII**" menu (or, click  button), navigate to **<Origin EXE folder> \Samples \Curve Fitting \Sensor01.dat** file in the ASCII dialog box, and check **Show Options Dialog** checkbox. Click **OK**. This opens the **impASC** dialog to set import options In the appeared **impASC** dialog, turn OFF the "**Rename Sheet with (Partial) Filename**" check box (under the "**Rename Sheets and Books**" node). By clearing this option, the imported data goes always the same data sheet name (in our case "Data" sheet). Also, click the arrow button next to **Dialog Theme**, and select **Save to <Sheet>** in the flyout menus. By selecting this flyout, Origin saves your import settings to the worksheet, and Origin imports the files always in the same manner. Click **OK**, and the data file is imported to the worksheet. Double-click the **Sheet1** sheet tab and rename to the more meaningful name, "**Data**".
2. **Now, let us perform the linear fit as a sample run.** Highlight column B, and choose the **Analysis: Fitting: Linear Fit: Open Dialog** menu. The **Linear Fit** dialog box will be opened. In the dialog, set **Recalculate** to **Auto** (because we automatize the batch process without manual intervention), and click

**OK** to perform a linear fit. In the workbook, go to the **FitLinear1** analysis report sheet. (In the Reminder box, you can answer **Yes**.)

3. **Now, let us add a Result Summary Sheet to this workbook as a collection place of the output of batch processing.** Go to the **FitLinear1** sheet, and find the **Summary** table in it. This table contains the important analysis results such as the slope and the intercept, and it is a good place to start constructing the Result Summary Sheet. To do so, click the triangle button next to the table name, and choose **Create Copy As New Sheet** flyout. A new sheet named **Summary** is created from the table.
4. **Now, let us design and customize this new Summary sheet for our purpose.** We let it contain the Pearson's  $r$  statistics, and the fitted curve graph. First, click the  button **TWICE** to add two new columns (columns G and H). Let us add the the Pearson's  $r$  to the column G - First, go back to the **FitLinear1** sheet, right-click on Pearson's  $r$  value cell in the **Statistics** table, select **Copy** flyout. Next, go to the **Summary** sheet, right-click on the first data cell of column G, and choose **Paste Link** to paste the link of the  $r$  value. For the caption of this statistics, go to the **FitLinear1** sheet, in the **Statistics** table, click on the caption text **Pearson's r**, and right-click and choose **Copy**. Then, switch to **Summary**, right-click the cell in column G, **Parameters** row, and select **Paste Link** flyout to paste the parameter label.
5. **In the similar way, let's add the fitted plot graph to the column H.** First, go back to the **FitLinear1** sheet, right-click the fitting result graph under the **Fitted Curves Plot** branch, right-click on the graph to select **Copy** context menu. Next, switch to the **Summary** sheet, right-click on the first data cell of column H, select **Paste Link** flyout to paste the graph as a link. Give the long name of column H **Fitted Curve**.
6. **Finally, let us save this workbook as an Analysis Template for batch processing.** Choose **File:Save Workbook As Analysis Template** menu, navigate to your **<User Files Folder>**, and enter **Sensor Analysis** for the analysis template name. Click **Save**. You can close Origin - because you have already save the Analysis template, it is not necessary to save this project unless you just want to keep it as a practice record.

#### 4.9.3.3.2 Performing Batch Processing with Multiple Data Files

Once you have made an Analysis Template including a Result Summary Sheet, it is quite easy to perform a batch processing to get the summarized Output from many source data files.

1. In a new project, choose "**File: Batch Processing...**" menu (or, click  button). "**Batch Processing**" dialog appears.
2. At the **Batch Processing Mode**, select the **Load Analysis Template** so that we can use the analysis template we already have made.
3. At the "**Analysis Template**", select the **Sensor Analysis.OGWU** (or **.OGW** in older versions) file in **<User Files Folder>** which we have saved in the previous section. (You can click "..." button to locate your analysis template.) Similarly, at the **Data Source**, select **Import From Files** from the drop-down as we want to import multiple files.
4. At the "**File List**", Click on the "..." button, and select ALL source files **Sensor##.dat** (**##** is the sequence number of the file) from the **<Origin EXE Folder> \Samples \Curve Fitting** folder (use SHIFT or CTRL key to select multiple files).
5. At the **Dataset Identifier**, select **File Name** so that the file name of every imported file will appear in the Result Summary Sheet as the data source.

6. At the **Data Sheet** drop-down, select **Data** to specify the receiving worksheet of import in the Result Summary Sheet.  
Similarly, at the **Result Sheet** drop-down, select **Summary** to specify the output destination of the Result Summary Sheet.
7. The "**Delete Intermediate Workbook**" check box may be either checked not to produce a large number of intermediate workbooks/worksheets, or unchecked to preserve all intermediate outputs in addition to the Result Summary Sheet. (**Note:** In **Origin 2018**, even if you check this check box, you don't have to be worried about losing the intermediate reports because "**Open Book(s)**" button in the Result Summary sheet can regenerate individual full report later.)

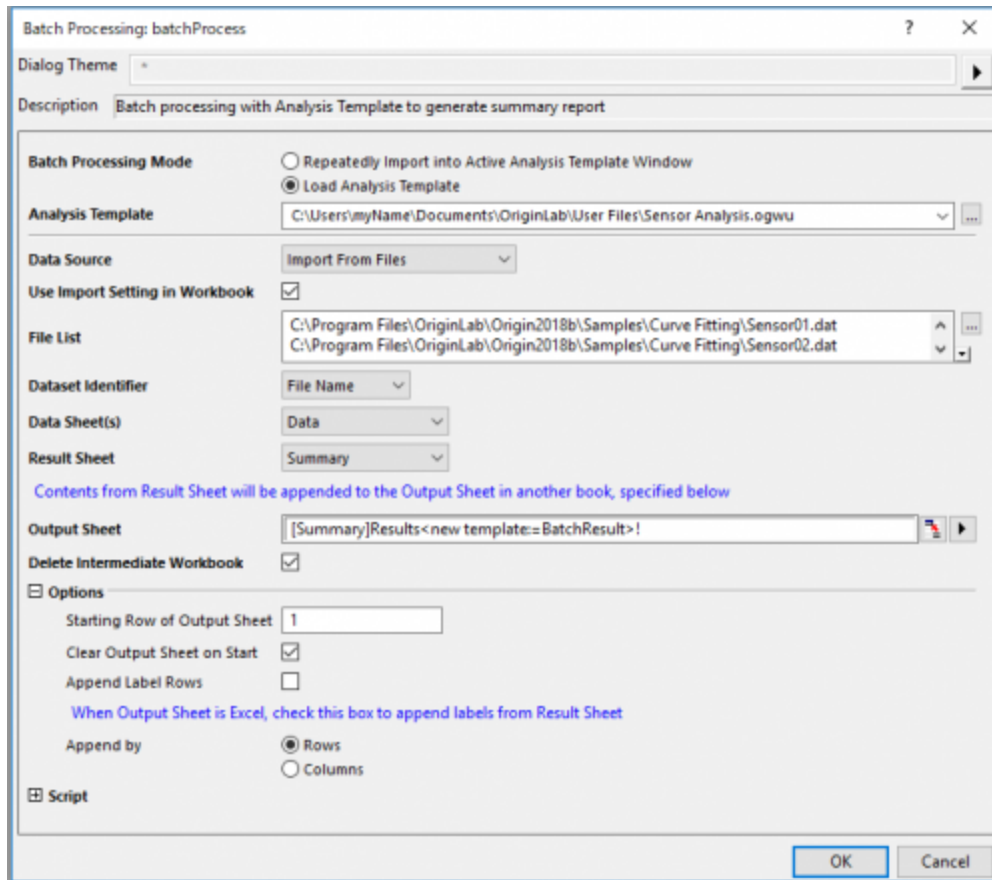

8. Click **OK**. All seven data files will be processed as indicated by the progress bar. A **Summary** workbook is generated, which contains summarized analysis results from the seven **Result** sheets in the analysis template. Put your mouse cursor on any graph cell, the fitted result graph will pop up to let you see the details. In Origin 2018, or later, if you want to extract full analysis reports or their individual graphs, highlight the desired rows, and press the "**Open Book(s)**" button.

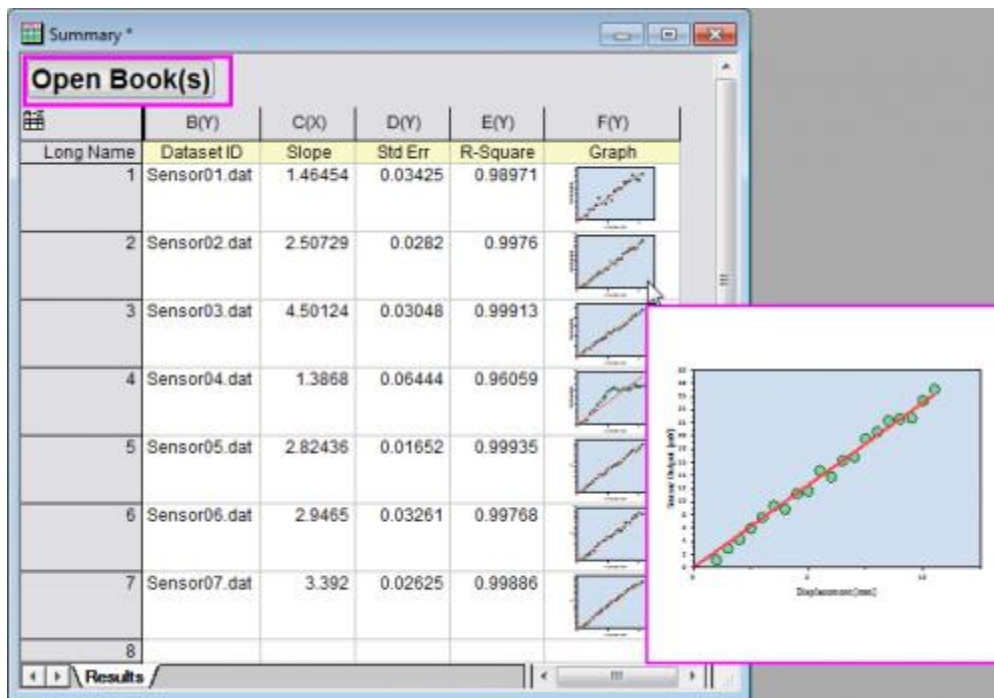

#### 4.9.4 Batch Processing with Summary Report in External Excel File

##### 4.9.4.1 Summary

This tutorial is associated with the Sample Origin Project: \\Samples\Batch Processing\Summary Report in External Excel File.opj

Minimum Origin Version Required: Origin 8.1 SR2

##### 4.9.4.2 What you will learn

- How to perform batch processing of multiple data files
- How to send results to an external Excel file and save that file

##### 4.9.4.3 Steps

1. Make the 'Raw Data' Worksheet in the 'Book1' Workbook active.
2. Select **File : Batch Processing...** from the menu or click the **Batch Processing** button  on the Standard Toolbar.
3. Select the **Repeatedly Import into Active Analysis Template Window** radio.
4. Set **Data Source** as **Import From Files**.
5. Check the **Use Import Setting in Workbook** check box.
6. Click the ... browse button next to **File List**.
7. Select **All Files (\*.\*)** in Files of Type and browse to Origin's \Samples\Batch Processing folder.
8. Select all 10 .csv files in the folder, click **Add File(s)** then click **OK**.



9. **Dataset Identifier** should be set to **None**.
10. **Data Sheet(s)** should be set to 'Raw Data'. Note: 'Raw Data' is the first sheet of 'Analysis Template', it will be renamed as the file name of last import file by default if this template has already been used and re-saved.
11. **Result Sheet** should be set to 'My Results'.
12. Click the button to the right of the "Output Sheet" edit box. *This will minimize the main dialog*. Then click on the title bar of the Excel book (Book2), and press the button to the right of the scrolled up dialog to expand it again.
13. Expand the Options branch and check the **Clear Output Sheet on Start** check box and enter **7** as the **Starting Row of Output Sheet**.
14. Check the **Append Label Rows** check box.
15. Click OK

## 4.9.5 Batch Processing with Word Template for Reporting

### 4.9.5.1 Summary

Origin can perform batch analysis of multiple files and output cell-linked analysis results to an external Word template for reporting.

Minimum Origin Version Required: Origin 2016 SR0

### 4.9.5.2 What you will learn

This tutorial will show you how to:



- Add bookmarks from a Word template to a specific Analysis Template
- Link analysis results to bookmarked cells in Word template and adjust the sizes of graphs to be exported
- Sending one time results to Word template for reporting
- Perform batch analysis of multiple files and export results to Word/PDF files

### 4.9.5.3 Steps

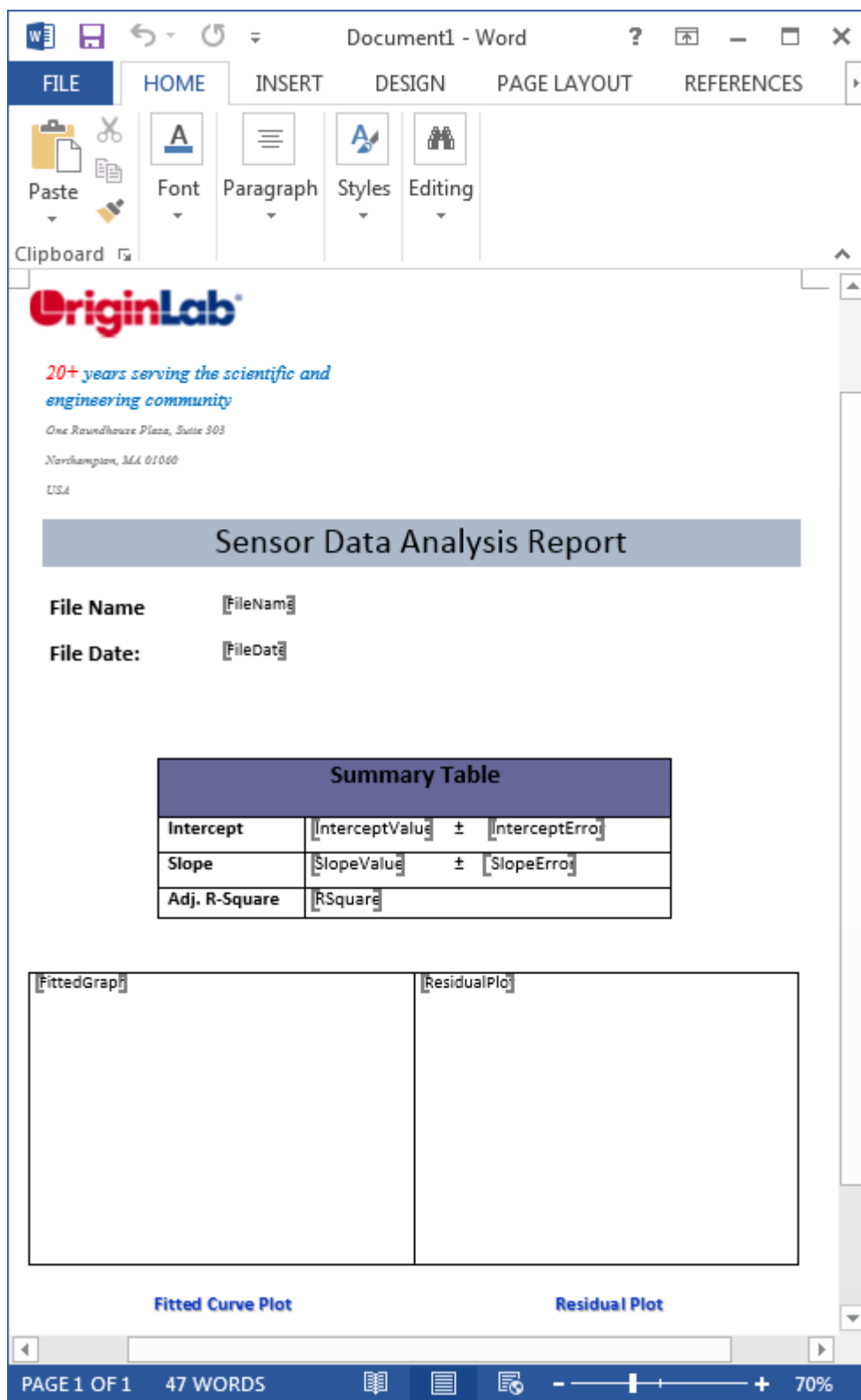
In this tutorial we will use a built-in Word template *Sensor Analysis Report.dotx* which is located at <Origin EXE folder>\Samples\Batch Processing\ folder. To view the bookmark labels on the Word template, with the file open go to **File: Options** to open **Word Options** dialog. Then select **Advanced** on the left panel and scroll down to section **Show document content** on the right panel and check **Show bookmarks** checkbox there.



#### 4.9.5.3.1 Add Bookmarks to Analysis Template

1. Start Origin. Click **File: Open** and browse to <Origin EXE>\Samples\Batch Processing\ folder and select the file **Sensor Analysis.ogw** (NOT "Sensor Analysis.ogwu") and open it.
2. Activate worksheet *Data*, click the button  and browse to <Origin EXE folder>\Samples\Curve Fitting\ folder and select file **Sensor01.dat** to import data for analysis.
3. Go to menu **File: Add Word Bookmarks to Analysis Template...** to open dialog. Click the browse button  to the right of the **Word template** box and browse to <Origin EXE folder>\Samples\Batch Processing\ folder to select **Sensor Analysis Report.dotx**.
4. Click to select all bookmark entries in the **Bookmarks** list under **Select Bookmarks** and click **OK** to add a *Bookmarks* sheet to the active analysis template.

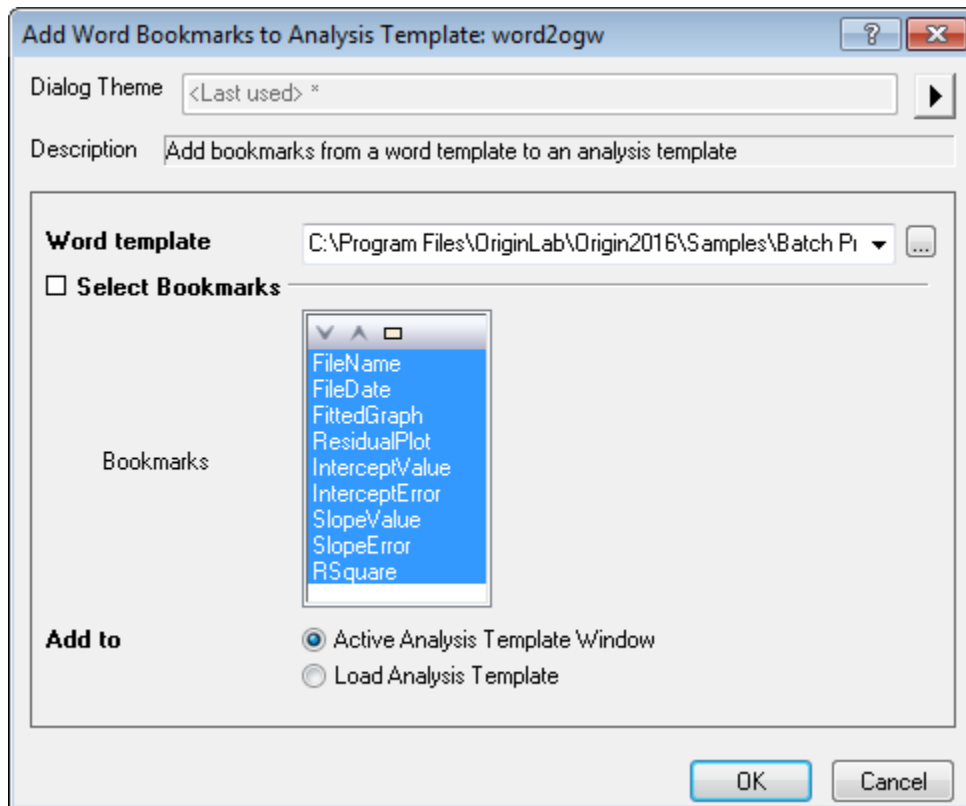

#### 4.9.5.3 Link Analysis Results to Word Template

1. Click on the *Bookmarks* tab.
2. In the *Links* column, right-click the cell to the right of *FileName* and select **Insert Variables**.
3. In the Insert Variables dialog, click the **Info** tab, expand the SYSTEM.IMPORT node and highlight FILENAME. Click the **Insert** button to insert the file name into the worksheet cell.
4. Right-click the cell beside *FileDate* and again choose **Insert Variables**, expand the SYSTEM.IMPORT node, highlight FILEDATE and click the **Insert** button to insert the file date into the worksheet cell. Note that the value that is inserted is a [Julian Day](#) value, the number that Origin uses internally to store date-time data. To display in a more familiar date format, right-click the cell and select **Format Cells**.
5. From the **Format** drop-down list, select *Date* and click **OK** to close the dialog.

- Right-click the cell beside the *FittedGraph* cell and select **Insert Graph**. Click the browse button  to the right of the **Graphs** box to open **Graph Browser** dialog. Check the **Show Embedded Graph** box to display a list of worksheet-embedded graphs. Click to select the *FitLine* graph and add it to panel on the right. Click **OK** twice to insert the graph into **Bookmarks** worksheet. In the *GraphWidth* column to the right, enter 250 (units = point size) to specify the size of the graph that will be exported to Word.

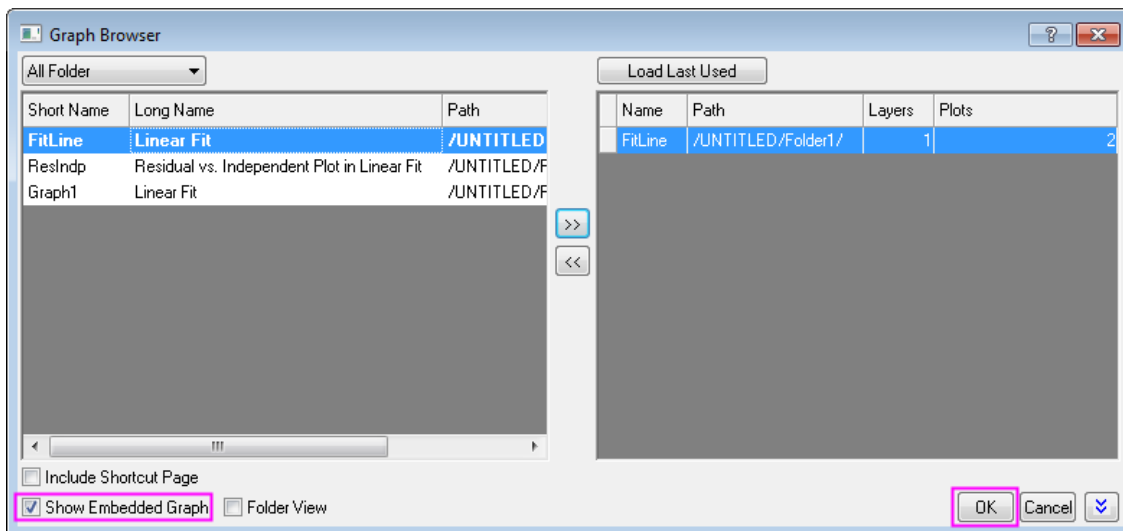

- Repeat the last step for the row *ResidualPlot*.
- For bookmarks related to parameter values, we will copy and paste link values from the report sheet *FitLinear1*. Click the report sheet *FitLinear1* and locate the **Parameters** table. Click on the data cell at the intersection of *Intercept* and *Value*, right-click and select **Copy**. Return to the **Bookmarks** sheet, right-click the cell to the right of *InterceptValue* and select **Paste Link** to create a link between bookmarks in the Word template and values in report sheet.
- Repeat this "Copy and Paste Link" operation to fill in the rest of cells in the *Links* column (you'll find the *RSquare* value beside *Adj. R-Square* in the *Statistics* table). When done, click **File: Save Workbook as**

**Analysis Template...** to save the analysis template as **Sensor Analysis Template.ogw** or **.ogwu** .

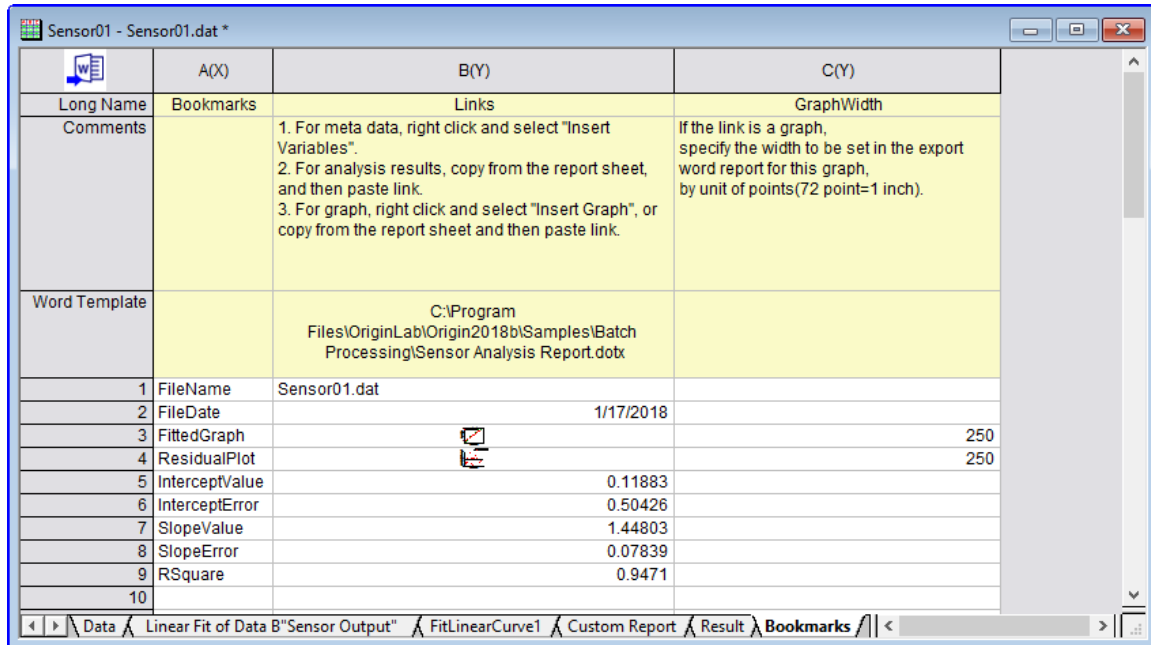

	A(X)	B(Y)	C(Y)
Long Name	Bookmarks	Links	GraphWidth
Comments		1. For meta data, right click and select "Insert Variables". 2. For analysis results, copy from the report sheet, and then paste link. 3. For graph, right click and select "Insert Graph", or copy from the report sheet and then paste link.	If the link is a graph, specify the width to be set in the export word report for this graph, by unit of points(72 point=1 inch).
Word Template		C:\Program Files\OriginLab\Origin2018b\Samples\Batch Processing\Sensor Analysis Report.dotx	
1	FileName	Sensor01.dat	
2	FileDate		1/17/2018
3	FittedGraph		250
4	ResidualPlot		250
5	InterceptValue		0.11883
6	InterceptError		0.50426
7	SlopeValue		1.44803
8	SlopeError		0.07839
9	RSquare		0.9471
10			





You can follow the steps in the previous tutorial "[Creating a Custom Report Sheet](#)" to learn how to copy and paste results as link to desired cell.

#### 4.9.5.3 Sending One Time Results to Word Template to Create Word Report

Sometimes we may just want to analyze one data file and quickly create one Word report. Continue from the example above, suppose we have all results linked to Word bookmarks as shown in *Bookmarks* worksheet, to create an one time Word report for active sheet you can simply click Export to Word button  on the top left corner to create it.

You can further specify where to output the Word report in appeared **Export Path** dialog.

#### 4.9.5.4 Batch Process and Export Results to Word/PDF Files

1. Start with a new project.
2. Click on the **Batch Processing** button .
3. Make sure **Load Analysis Template** is selected as **Batch Processing Mode**. In the **Analysis Template** drop-down, select the **Sensor Analysis Template.ogw(u)** file we created earlier (you may need to click the button to the right of the list and browse to the created file).
4. Select **PDF** from **Export to** drop-down list to export report as PDF file.
5. Click the browse button  to the right of the **Word template** box and browse to *<Origin EXE folder>\Samples\Batch Processing\* folder to select **Sensor Analysis Report.dotx**.
6. Optionally you can click browse button  on the right of **Export Path** to specify another path for export.

7. Click on the browse button  to the right of **File List**, browse to the <Origin EXE Folder>\Samples\Curve Fitting folder and select all sensor files **Sensor0#.dat**.
8. Click **Add File(s)**, then click **OK**.
9. Select **File Name** as **Dataset Identifier**.
10. Make sure the **Data Sheet** drop-down is set as **Data**.
11. Make sure the **Result Sheet** drop-down is set as **Result**.
12. Make sure that **Delete Intermediate Workbook** is cleared.
13. Click **OK** to close the dialog and process the "Sensor" data files.
- 14.

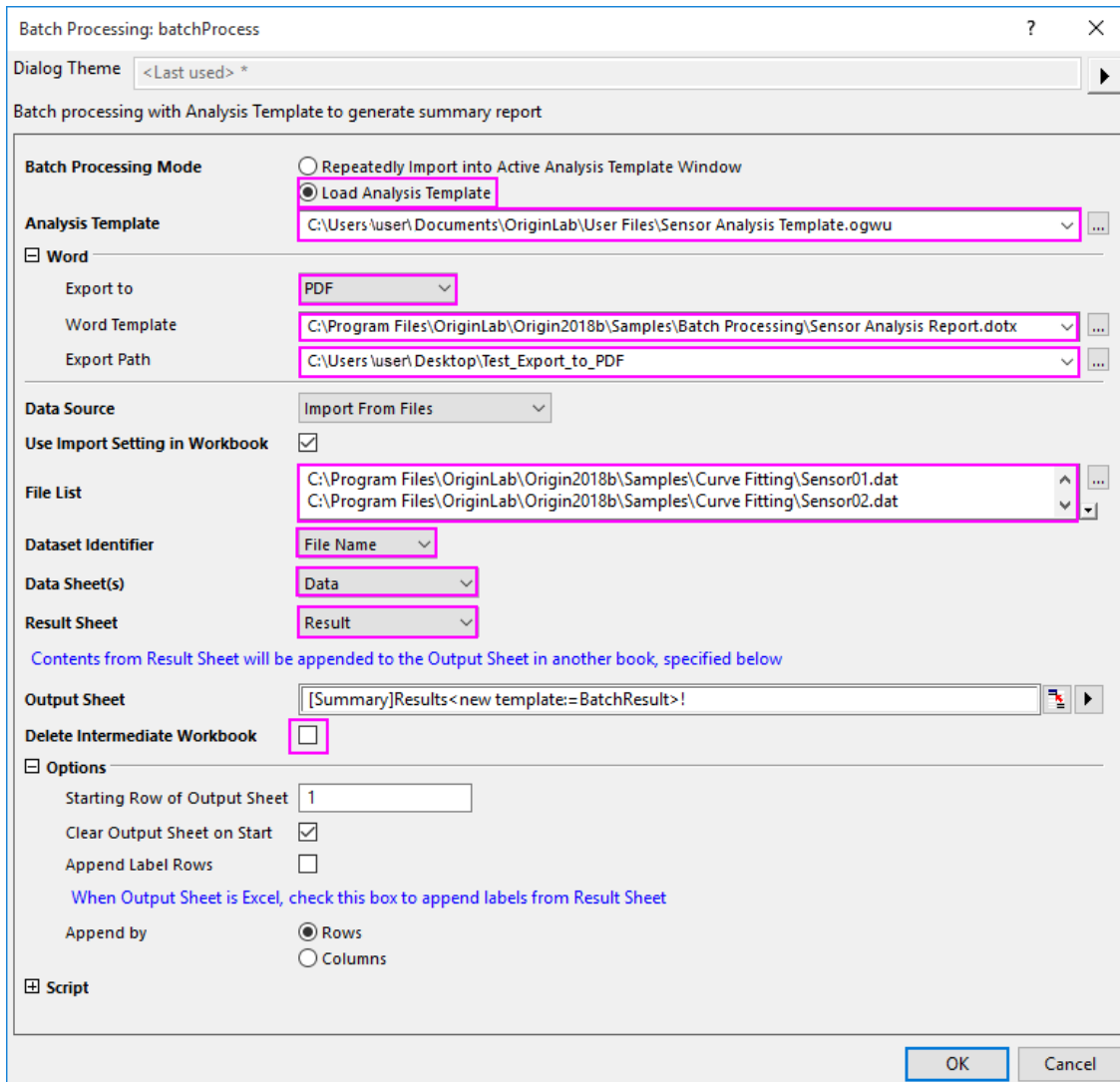

If you forget where to look for your exported PDF files, the location is output to **Messages Log**.

15. A sample of exported PDF version report is as following:

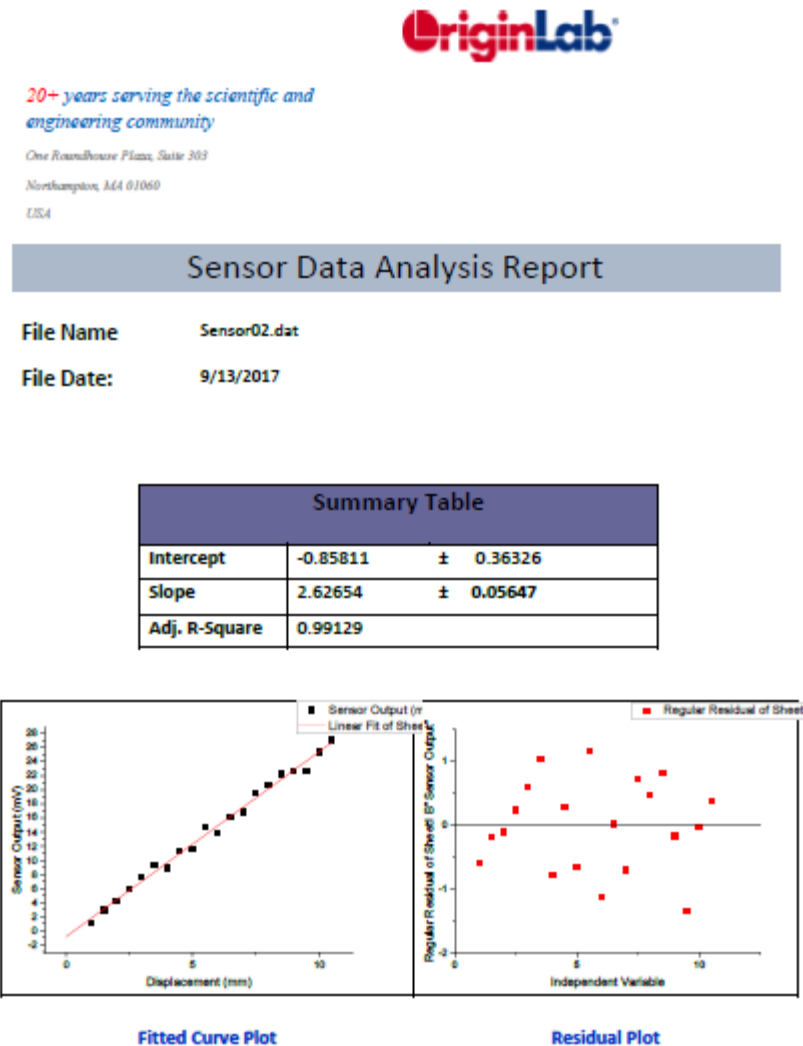

#### 4.9.6 Batch Processing Grouped Datasets Using Analysis Template with Multi-Data Sheets

##### 4.9.6.1 Summary

Origin can perform batch analysis on grouped datasets using an analysis template with multiple data sheets.

Minimum Origin Version Required: 2016 SR0

##### 4.9.6.2 What you will learn

This tutorial will show you how to:

- Create a multi-data sheets analysis template
- Perform batch analysis on grouped datasets using analysis template

#### 4.9.6.3 How the Analysis Template Works

The reference multi-data sheets analysis template **Multi-Data Sheets Analysis.ogw** that we are going to make is located in <Origin EXE Folder>\Samples\Batch Processing folder. This analysis template will process 10 CSV files located in <Origin EXE Folder>\Samples\Batch Processing folder in group of 5. Every 5 data files will be imported into the sequential data sheets in the analysis template and a non-linear fit will be conducted to obtain the peak area and its standard error of each curve. Eventually we will perform linear fit to peak area versus temperature data extracted from file name and output the results.

#### 4.9.6.4 Steps

##### 4.9.6.4.1 Create Multi-Data Sheets Analysis Template

Import CSV Files into Sequential Data Sheets

1. Create a new workbook. Go to menu **Data: Import from File: Comma Delimited (CSV)...** to open **CSV** dialog.
2. Browse to <Origin EXE Folder>\Samples\Batch Processing folder and select the first five data files, make sure **Files of type:** is selected as \*.csv, then click **Add File(s)** and **OK** button to open **Comma Delimited(CSV): impCSV** dialog.
3. Expand **Import Options: Header Lines** node, select **Number of Subheader Lines** as 2, **Long Name** as 1 and **Units** as 2. Click **OK** to finish import.

Perform Nonlinear Fit to Obtain Peak Area

4. Highlight column 2 in sheet *T275k*, hold Ctrl + Y or go to menu **Analysis: Fitting: Nonlinear Curve Fit** to open the **NLFit** dialog.
5. Select **Gauss** as **Function** in **Origin Basic Functions** category.
6. Click **Fit** button to perform the fitting. Click **OK** in the prompt to close it.
7. Repeat steps 4, 5, 6 for data *T285k*, *T295K*, *T305K*, *T315K* to obtain peak areas for all five peaks.

Prepare Data for Linear Fit

8. Right click sheet tab *FitNLCurve5* and select **Add** to add a worksheet. Double click on the name and input *TempData* as sheet name.
9. Hold Ctrl+D to open **Add New Columns** dialog and input 2 in the edit box to add 2 extra columns. Click **OK** button to close dialog.
10. Set the **Long Name** of the 4 columns as *Data File*, *Temperature*, *Area Value*, *Area Error*, respectively.
11. Right click the first data cell in column *Data File* and select **Insert Variable** to open dialog. Right click the node of workbook *T315K* on the right panel and check **Show Sheet Level** item to show sheets under it. Then click *T275K* sheet on the right panel and click **Label** tab on the left panel. Click property **Name** to highlight that row and click **Insert** button to insert sheet name into this cell.
12. Repeat this step for other four sheets to add the sheet name to column *Data File*.



- Next we want to extract the temperature number from sheet name in first column, to do so highlight column *Temperature* and right click to select **Set Column Values....** Input formula below in the edit box to extract the middle 3 numbers from file name and click **OK** to close dialog and apply.

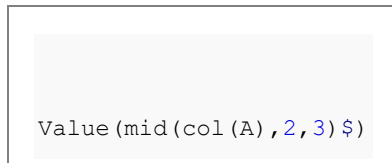

- Go to sheet *FitNL1* and highlight the two value cells under area **A** section in *Summary'* node. Right click to select **Copy** to copy the data. Then go to *TempData* sheet and paste link the data in the first row in column *Area Value* and *Area Error*. Repeat this step for other four data files.
- Set the designation of column *Temperature* as **X**, column *Area Error* as **Y Error**.

#### Perform Linear Fit and Create Result Sheet

- Highlight column *Area Value* and *Area Error* and go to menu **Analysis: Fitting: Linear Fit** to open dialog, select **Recalculate** mode as **Auto**, click **OK** to perform linear fitting and close the dialog. Click **OK** in appeared prompt to close it.
- Right click sheet tab *FitLinearCurve1* and select **Add** to add a new sheet and name it as *Results*.
- Hold Ctrl + D to open **Add New Columns** dialog and input 3 in edit box to add 3 new columns.
- Set the **Long Name** of the 5 columns as *Intercept Value*, *Intercept Error*, *Slope Value*, *Slope Error* and *Adj. R-Square*, respectively.
- Go to sheet *FitLinear1*, copy the 5 value cells under **Summary** node and go back to *Results* sheet and click the first cell in first data row to paste as link.
- Go to menu **File: Save Workbook As Analysis Template...** to save it as an analysis template and name it as *Multi-Data Sheets Analysis*.

#### 4.9.6.4.2 Batch Analyze Files in Groups

In *<Origin EXE Folder>\Samples\Batch Processing* folder, we have 10 CSV data files. Suppose now we want to group the files as two groups and re-order them as: group 1 as *T365K*, *T345K*, *T325K*, *T305K*, *T285K*; group 2 as *T355K*, *T335K*, *T315K*, *T295K*, *T275K*. After we will process those two grouped files using the analysis template we created in section above.

- Go to menu **File: Batch Processing...** to open dialog, click the more options button next to **Analysis Template** edit box to browse to analysis template **Multi-Data Sheets Analysis.ogw**.
- Click the more options button next to **File List** edit box to bring up **Open** dialog. Firstly drag and drop CSV files one by one to re-order them as shown below and click **Add File(s)** button to add the files to list.

Click **OK** button to exit dialog.

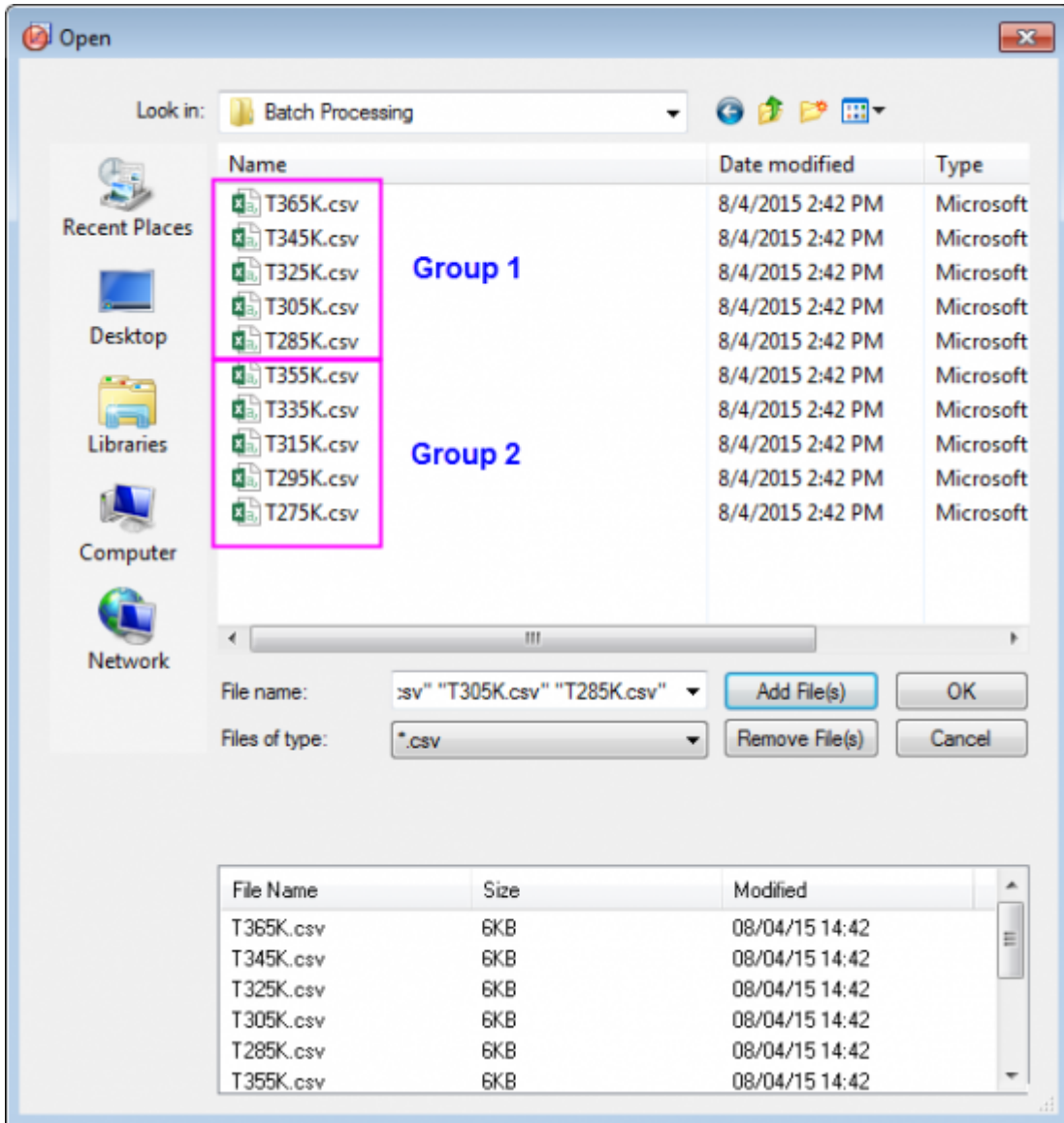

3. Select **File Name** as **Dataset Identifier**, **Results** sheet as **Result Sheet** and uncheck **Delete Intermediate Workbook**.

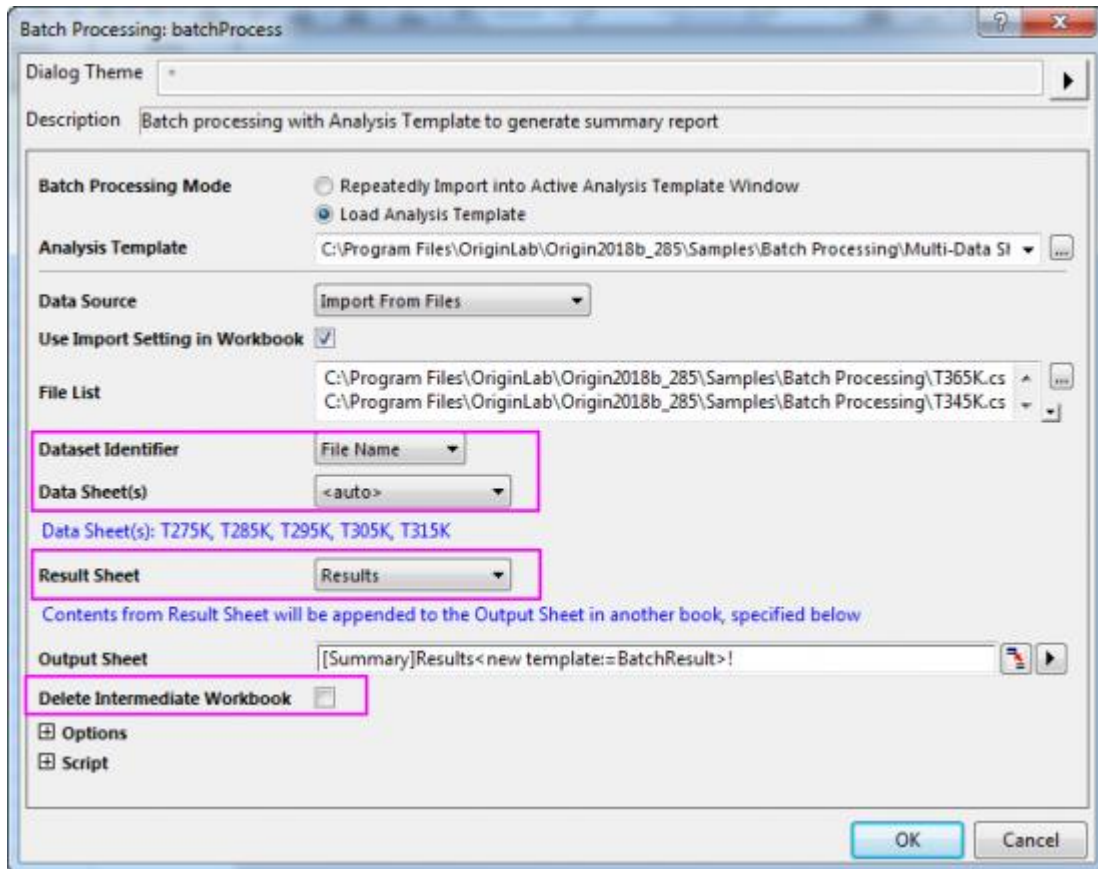

4. Click **OK** button to start processing. And click OK button to save the Batch Processing dialog settings into the analysis template used(only available since Origin 2018b). The results will be outputted to **Summary** workbook as shown below:

Summary \*

Open Book(s)

	B(Y)	C(X)	D(Y)	E(Y)	F(Y)	G(Y)
Long Name	Dataset ID	Intercept Value	Intercept Error	Slope Value	Slope Error	Adj. R-Squ
Units						
Comments						
F(x)=						
1	T365K.csv, T345K.csv, T325K.csv, T305K.csv, T285K.csv	13815.20722	7263.08994	141.51071	22.90197	0.90286
2	T355K.csv, T335K.csv, T315K.csv, T295K.csv, T275K.csv	5799.63634	5098.28296	167.08504	16.51348	0.96204
3						

Results



## 5 Statistics

### 5.1 Statistics

#### 5.1.1 Descriptive Statistics

- [Descriptive Statistics](#)
- [Cross Tabulation](#)
- [2D Binning](#)
- [Distribution Fit](#)
- [Partial Correlation Coefficient](#)

#### 5.1.2 [Hypothesis Tests](#)

#### 5.1.3 ANOVA

- [One Way ANOVA](#)
- [One-Way Repeated Measures ANOVA](#)
- [Two Way ANOVA](#)
- [Two Way Repeated Measures ANOVA](#)
- [Two-Way Mixed-Design ANOVA](#)
- [Three-Way ANOVA](#)

#### 5.1.4 Nonparametric Tests

- [Non-parametric Statistics Overview](#)

#### 5.1.5 Survival Analysis

- [Kaplan-Meier Estimator](#)
- [COX Model Estimator](#)
- [Weibull Fit](#)

#### 5.1.6 Multivariate Analysis

- [Principal Component Analysis](#)
- [Cluster Analysis](#)

- [Discriminant Analysis](#)
- [Partial Least Squares](#)

### 5.1.7 [Power and Sample Size](#)

### 5.1.8 [ROC curve](#)

## 5.2 Descriptive Statistics

### 5.2.1 Descriptive Statistics

- [Descriptive Statistics](#)
- [Cross Tabulation](#)
- [2D Binning](#)
- [Distribution Fit](#)
- [Partial Correlation Coefficient](#)

### 5.2.2 Descriptive Statistics

#### 5.2.2.1 [Summary](#)

Origin provides comprehensive Descriptive Statistics support including basic statistics (mean, median, variance, etc.), frequency counts, and correlation coefficients of your data sets. In addition to strong plotting features, Origin's statistical tools help you summarize and analyze your data.

#### 5.2.2.2 [What You Will Learn](#)

This tutorial will show you how to:

- Use the **Statistics on Column** dialog to calculate descriptive statistics for grouped data.
- Copy statistical results to a new worksheet for further processing.
- Sort worksheet data by the attribute values in a designated column.
- Analyze data sets with the **Correlation Coefficient** Tool.

Minimum Origin Version Required: Origin 2015 SR0

#### 5.2.2.3 [Finding Frequency Information for Groups](#)

We will use the **Discrete Frequency** tool to quickly obtain frequency information for groups of data.

1. Open a new workbook. From the Menu Bar select **Data: Import from File: SingleASCII: Statistics|automobile.dat**.

- Highlight the first two columns in the **automobile** worksheet. From the Menu Bar, select **Statistics: Descriptive Statistics: Discrete Frequency**. Change the **Recalculate** mode to **Auto**. To make operation in the source data worksheet [Controlling the Categorical Values section](#) working, change the **Sort Data By** to **Categorical Order**. Then click **OK**.

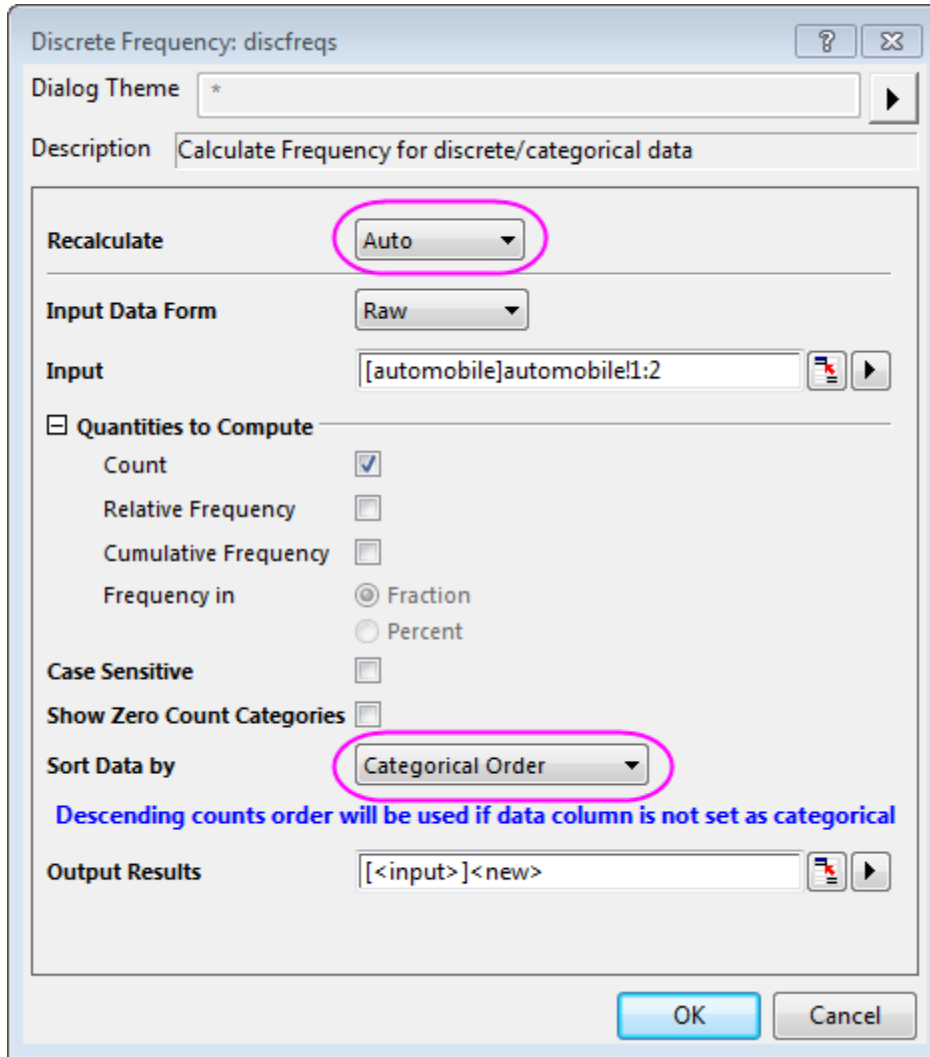

- The resultant worksheet **DiscretFreq1** displays data and its counts for automobile Year and Make, respectively.



In spite of the fact that there are locks on the columns, the worksheet can be rearranged by highlighting the desired column, going to the Menu Bar, selecting **Worksheet:Sort Worksheet**, and selecting **Ascending**, **Descending**, or **Custom** from there.

#### 5.2.2.4 Calculating Descriptive Statistics on Grouped Data

Basic statistical treatments can be performed on the data in individual columns using the **Statistics on Columns** tool.

1. Return to the **automobile** worksheet. From the Menu Bar, select **Statistics: Descriptive Statistics: Statistics on Columns: Open Dialog...**
2. In the **Statistics on Columns** dialog box, in the **Input** tab, expand **Range 1** and click the interactive button  to the right of **Data Range**. Return to the worksheet, select column **C** and drag to column **G**. Click the interactive button again to restore the dialog box. In the dialog box, after adjusting **Input Data** under **Range 1**, click the arrow button at the top-right corner of the Group control box to select **B(Y): Make** as grouping data. Change the **Recalculate** mode to **Auto**.

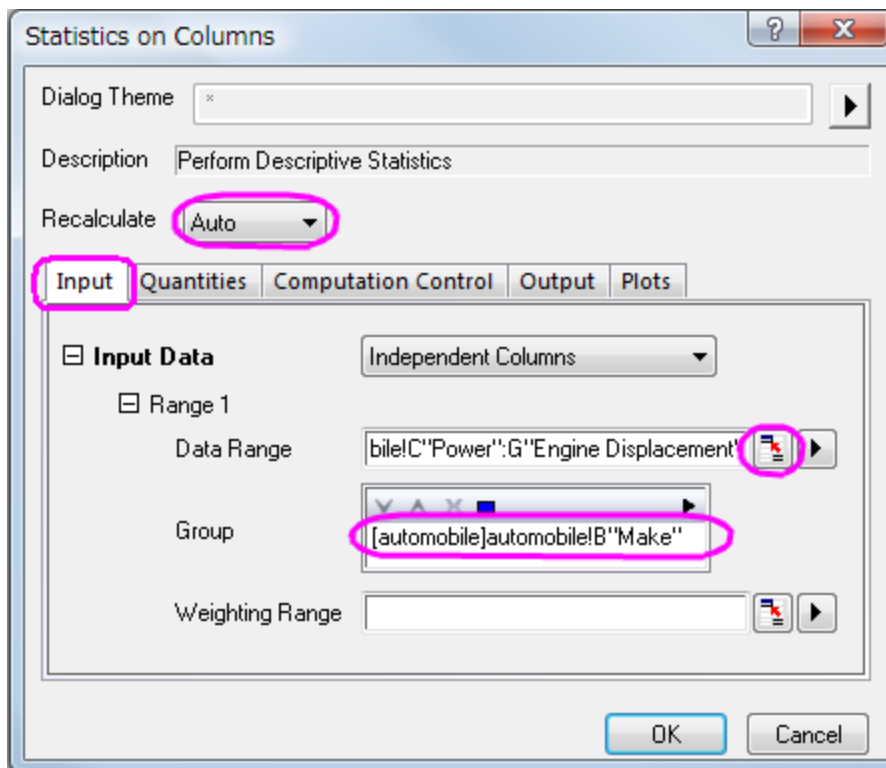

3. In the **Output** tab, under the **Graph** branch, check the **Arrange Plots of Same Type in One Graph** box. Also, in the **Plots** tab, check the **Box Charts** check box.



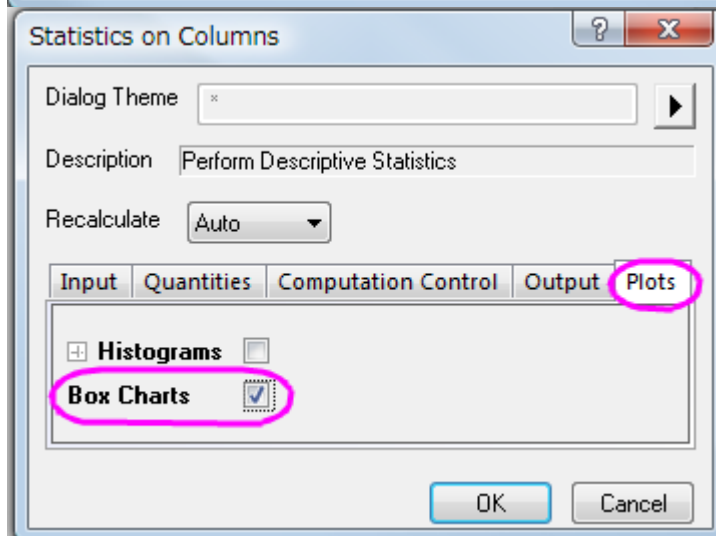
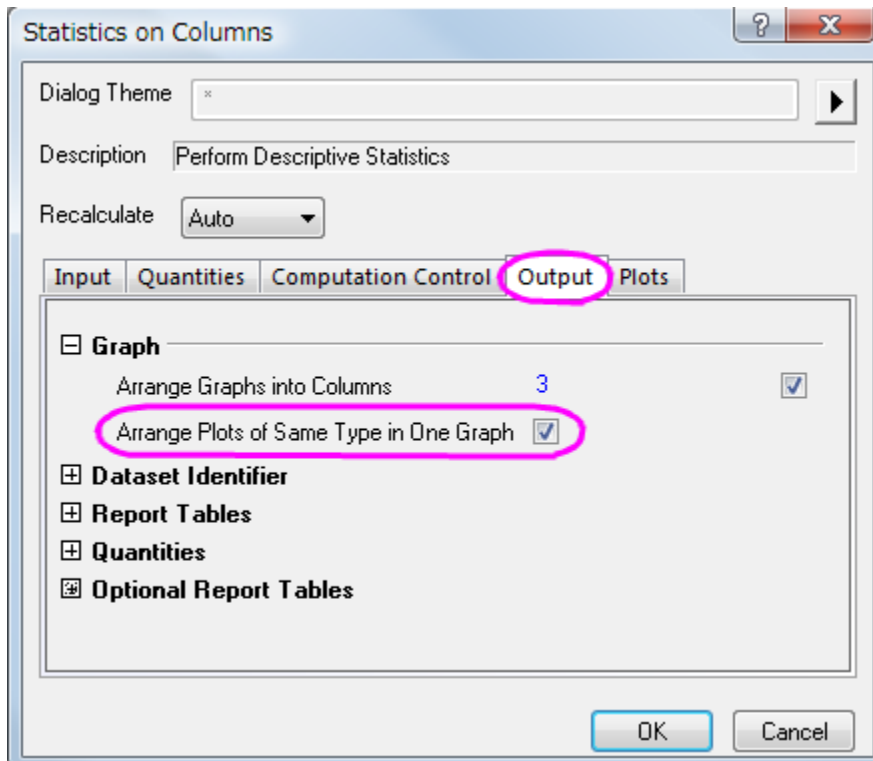

- Click **OK** to get the results in a report sheet.

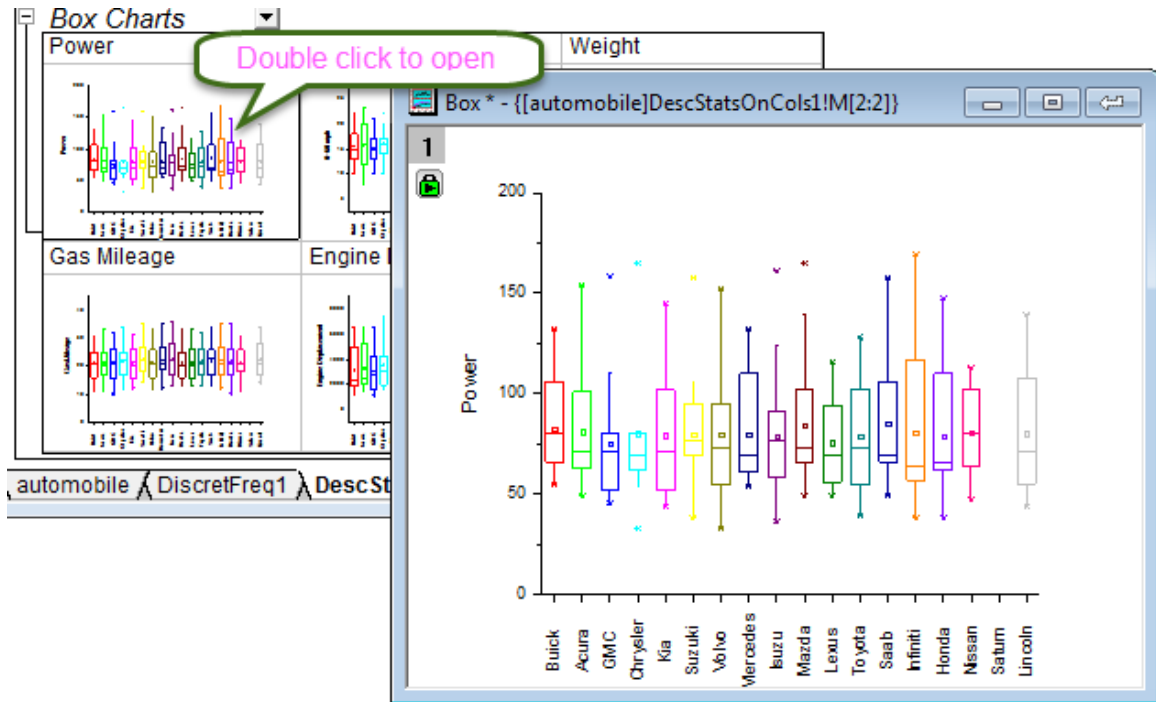



In order to modify any embedded box plot in report sheet, double-click to open it, then customize the graph and click the **Return** button in the top right corner to restore the modified graph back to the report sheet.

#### 5.2.2.5 Using Statistical Results for Further Operations

It is possible to perform further data analysis and to plot the statistical results.

For example, to obtain average attribute values (i.e. horsepower, 0-60 mph time, weight, mileage) by Vehicle Make from 1992 to 2004, perform the following:

- Return to the **automobile - automobile.dat** workbook, and open the **DescStatsQuantities1** worksheet. Highlight the **D(Y2)** and the **E(yEr±)** columns, go to the Menu Bar and select **Worksheet: Unstack Columns: Open Dialog....**
- In the **wunstackcol** dialog box, change the **Recalculate** mode to **Auto**, select **Group Columns** and click the context menu button  and select **A(X1) Data**.
- Expand **Options** and check the **Include Other Columns** box. On **Other Columns**, click the context menu button  and select **A2:(X) Make**. Set **Matching Longest Group** as Extract Rule for Other Columns Values, expand **Output Settings**, and from **Put Grouping Info. to**, select **Long Name**. Click

OK.

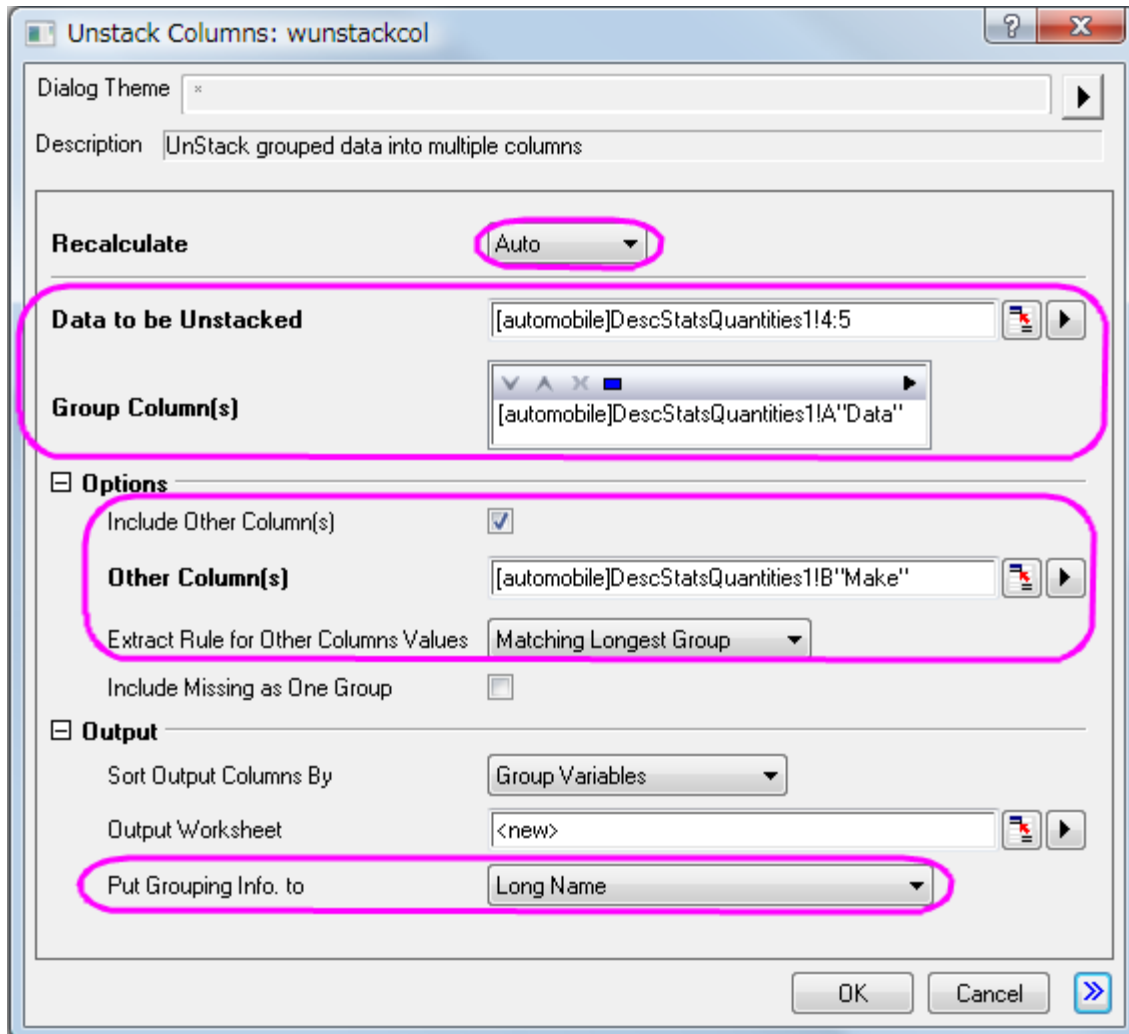

4. To see the results, open worksheet **UnstackCols1**, highlight the worksheet, and from the Menu Bar, select **Plot>2D: Multi-Panel: Stack**.
5. In the **Plotting:plotstack** dialog box, set **Plot Type** to **Scatter**. Click **OK**.
6. Now we are going to rotate the tick labels at top X axis for clarification. Double click on the top X axis tick labels to open the **Axis** dialog, and set the following in **Top** icon. Click **OK**.

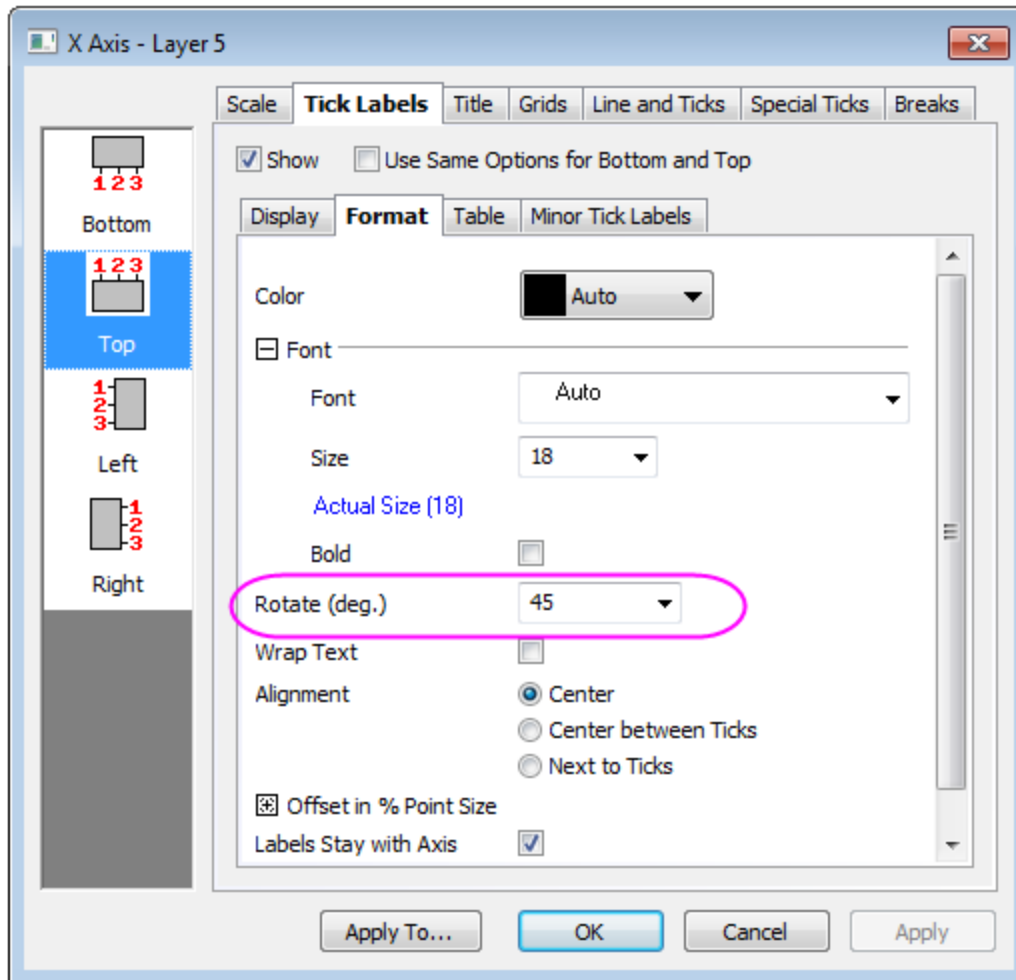

Rotate the Tick Labels for bottom in the same way.

7. The report sheet and the graph will appear as shown below:

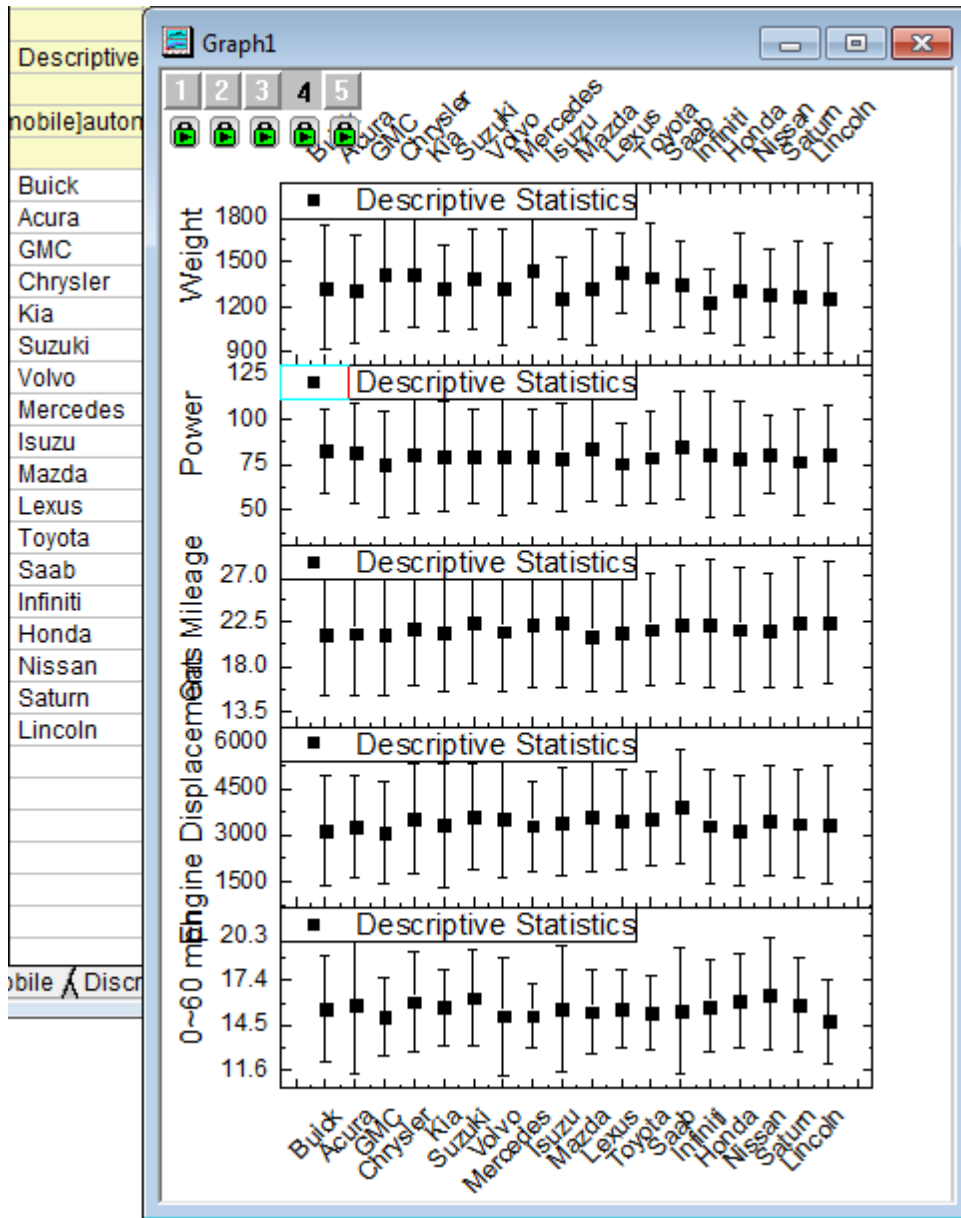

5.2.2.6 Analyzing the Relationship Between Different Indicators

Use a correlation coefficient to explore the relationship between columns of the automobile data. Next, construct scatter plots with confidence ellipses to obtain graphical representations of the correlations.

1. In the **automobile - automobile.dat** workbook, open the **automobile** worksheet, and highlight the last five columns.
2. From the Menu Bar, select **Statistics: Descriptive Statistics: Correlation Coefficient: Open Dialog....** In the corrcoeff dialog box, expand **Correlation Types** and check the **Pearson** box.
3. Expand **Plots** and check the **Add Confidence Ellipse** box. The **Scatter Plot** check box will be automatically selected. Click **OK**.

- The **ScatterMatrix1** and **CorrCoef1** worksheets should appear as below; demonstrating the high positive correlation between **Engine Displacement** and **Power**, and the high negative correlation between **Gas Mileage** and **Engine Displacement**.

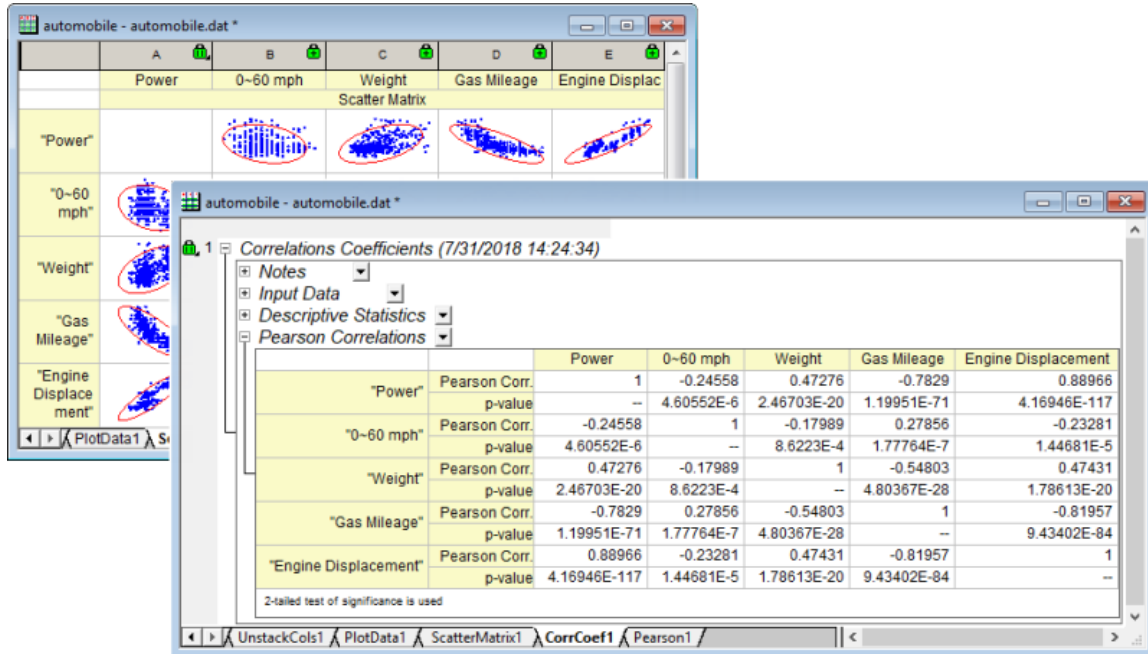

### 5.2.2.7 Controlling the Categorical Values

- In the following steps, we want to customized the order of values shown in the graph but not change the source data. Right click Column **B** in workbook, select **Set As Categorical** in the context menu, double click the **Categories** cell of the column, "Unsorted", to open the **Categories** dialog.

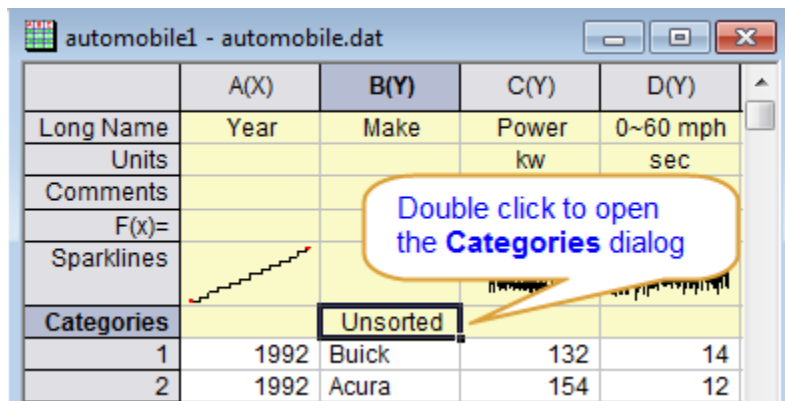

- Check **Customize Categories** checkbox, use  to adjust position of each item to follow the image below, in this way we can sort the items by country of the manufacturers, which is U.S.->Japanese/Korea->Europe. Click **OK** to close the dialog.

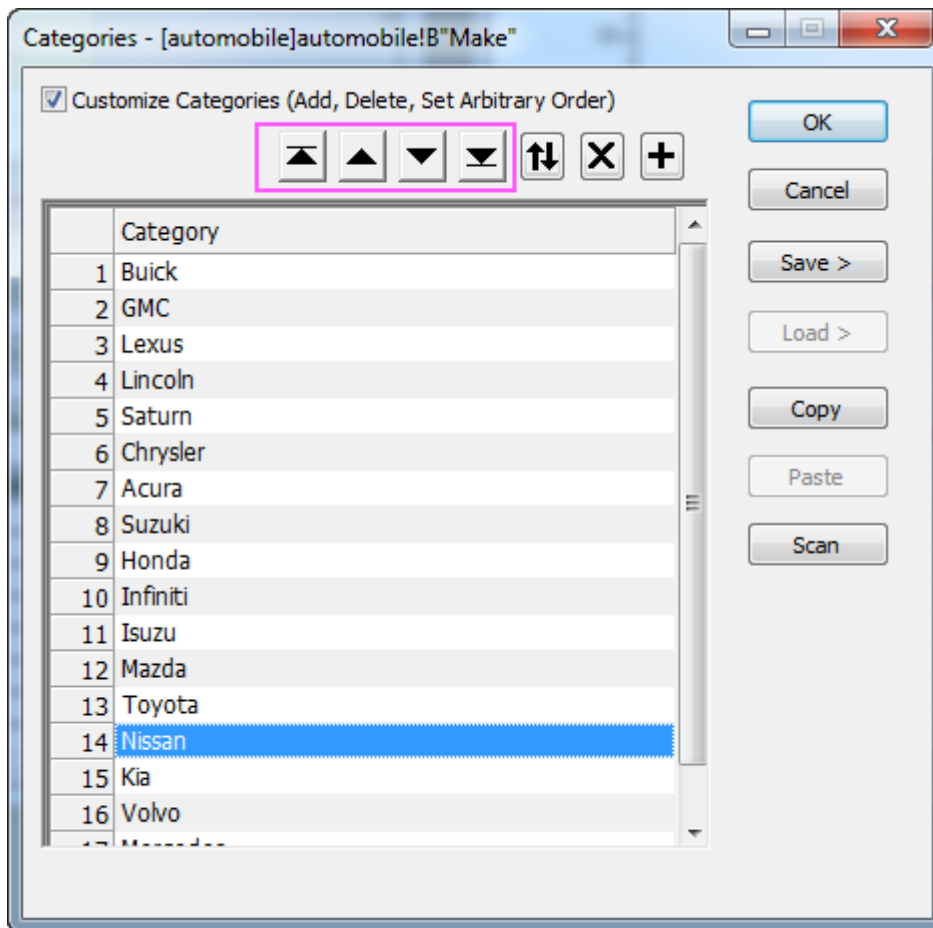

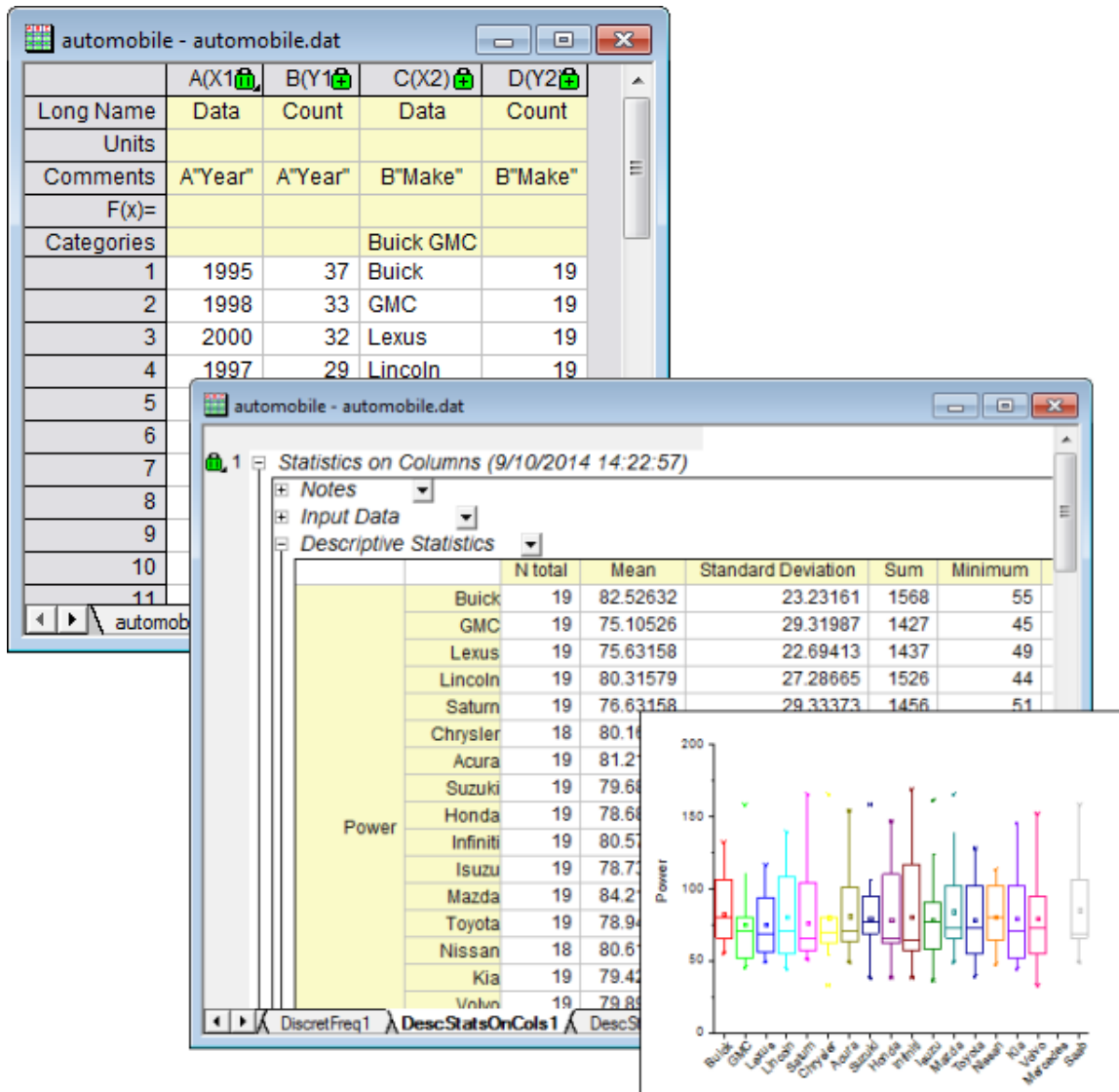

3. You can go to the report sheet created in section above. Because **Auto** mode is used for recalculation, the report sheet of **Discrete Frequencies** and **Statistics on Columns**, including the box charts, are updated automatically with the specified order of the Categorical data.



- The results of **Unstacked Columns** and the stacked graph are updated automatically as well.

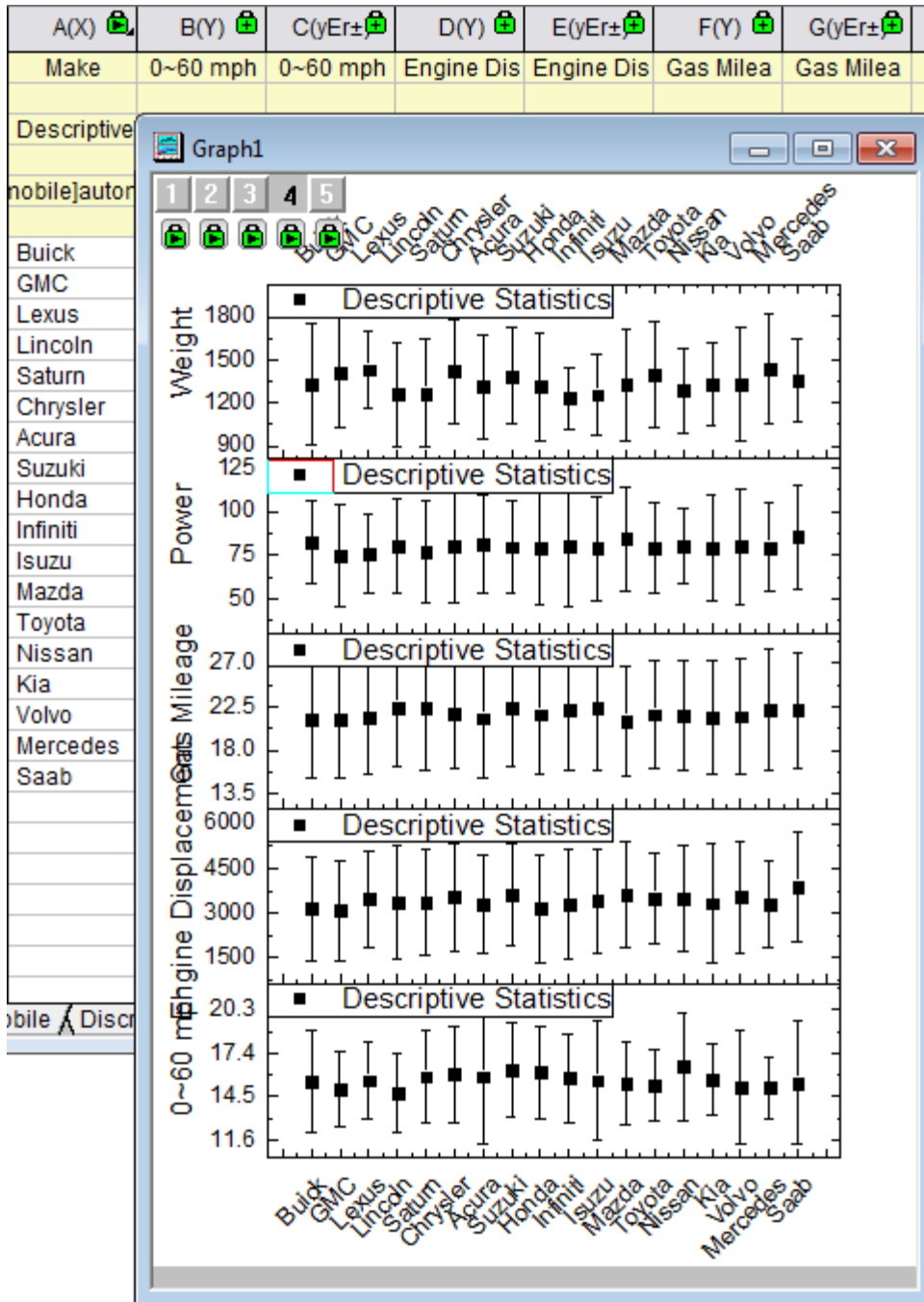



**Note:** If the operation hasn't been auto-updated, you can also manually trigger the operations by clicking the **Recalculate** button  in the **Standard** toolbar. The button will turn green  after recalculation is done

### 5.2.3 Cross Tabulation

### 5.2.3.1 Summary

Cross tabulation is particularly useful for analyzing categorical data. In these analyses, a contingency table is used to display the frequency distribution of two or more variables. Analyses based on the table can determine whether there is a significant relationship between variables, and assess the strength of the relationship between the variables.

Minimum Origin Version Required: Origin 2016 SR0

### 5.2.3.2 What you will learn

This tutorial will show you:





1. How to perform the Cross Tabulation.
2. How to interpret the results.

### 5.2.3.3 User Story

Our data are from the **Montana Economic Outlook Poll** conducted in May 1992, with accompanying demographics for 209 out of 418 poll respondents. We have data on seven variables: **Age**(under 35, 35-54, 55 and over), **Sex**(male, female), **Financial Status**(worse, same, or better than a year ago), etc. With the data, we want to learn:

1. The frequency distribution of financial status in three different age groups, and whether male and female differ in the distribution.
2. Whether there is significant relationship between "Financial status" and "Age" for male and female groups.
3. The strength of the relationship.

### 5.2.3.4 Preparing Data for Analysis

1. Open a new project or a new workbook. Import the data file  
**\Samples\Statistics\MontanacOutlookPoll.dat**
2. We begin by sorting the categorical values.
  - o On the **MontanacOutlookPoll** worksheet, highlight column **B** and right click to select **Set As Categorical**. Double-click on **Unsorted** in the Categories label row to open the **Categories** dialog box. Check **Customize Categories (Add, Delete, Set Arbitrary Order)** box. Then use the Move To Top , Move Up , Move Down  and Move To Bottom buttons  to reorder categories as "under 35", "35-54" and "55 and over":

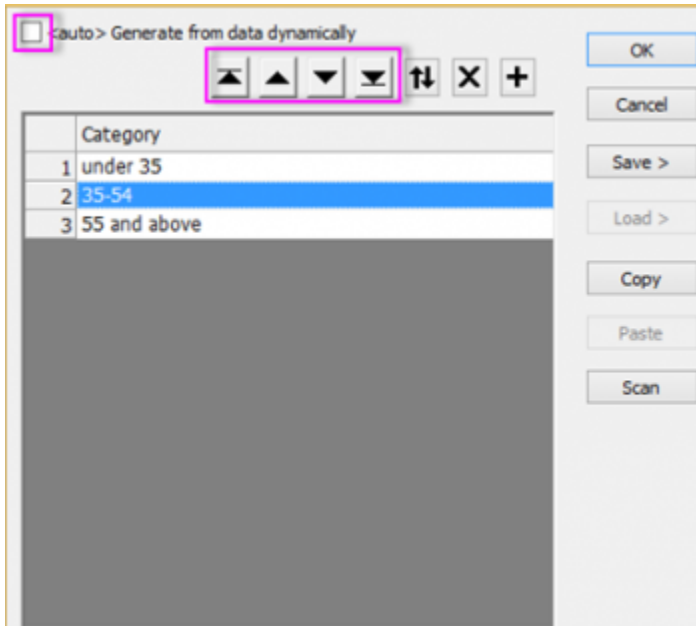

- Repeat the same steps for column **C** so that the categorical mapping is **<Female, Male>**
- Repeat the same steps for column **G** so that the categorical mapping is **<Better, Same, Worse>**



To exclude missing values from analysis, we should [set the columns as categorical](#). Otherwise the missing values will be kept as numeric values.

### 5.2.3.5 Performing Cross Tabulation

1. Open the Cross Tabulation dialog by choosing the menu item **Statistics: Descriptive Statistics: Cross Tabulation**.
2. Click on the **Input** tab. The data is in raw data mode, so select column **B**, **G** and **C** for **Row**, **Column** and **Layer**, respectively.

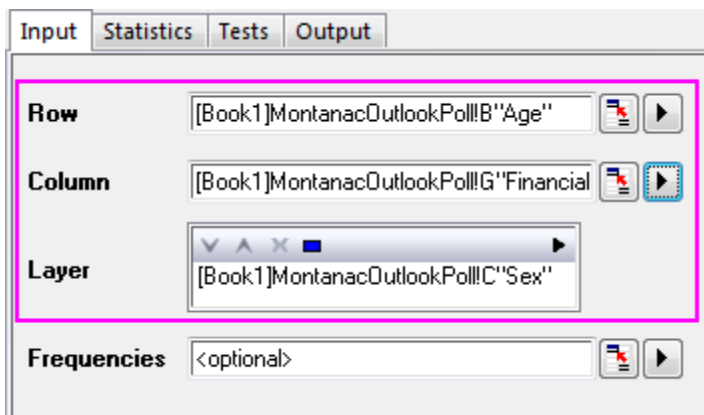

- Click on the **Statistics** tab, uncheck the **Expected Counts**, **Residuals**, **Standardized Residuals** and **Adjusted Residuals** and accept all the other default settings.

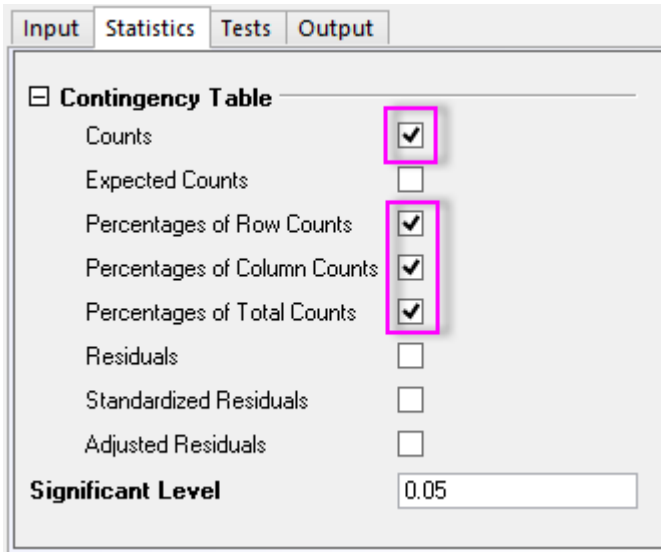

- On the **Tests** tab, select the **Chi-Square Test** check box. Expand the **Measures of Association** branch, and then select the **Contingency Coefficients**, **Phi**, and **Cramer's V** boxes (for measuring nominal association).

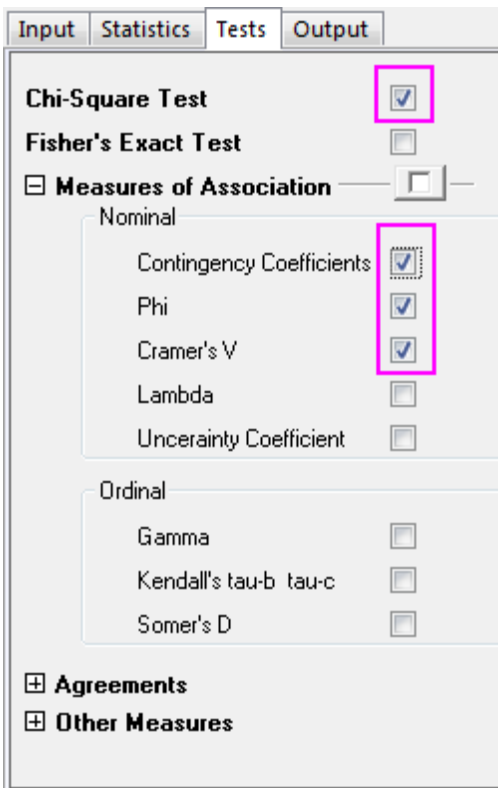

- Click on the **Output** tab and select the **Mosaic Plot** check box. Accept the other default settings and click **OK**.

The screenshot shows a software window with four tabs: 'Input', 'Statistics', 'Tests', and 'Output'. The 'Output' tab is active. It contains the following options:

- Results Log Output**: An unchecked checkbox.
- Mosaic Plot**: A checked checkbox, highlighted with a pink rectangular border.
- Crosstab Report**: An input field containing the text '<input><new>' and a right-pointing arrow button.
- Plot Data**: An input field containing the text '<input><new>' and a right-pointing arrow button.

### 5.2.3.6 Interpreting The Results

Go to sheet **Crosstab1**

#### 5.2.3.6.1 Frequency Distribution

We can get frequency distribution information from the **Mosaic Plot** and the **Contingency Table**. The area of each rectangle in the **Mosaic Plot** is proportional to the percentage of the Y variable for each level of the X variable, so we can visually compare the frequency distribution of "Financial status" and "Age" for female, male and total. From the **Contingency Table** we can get more specific information. Combining the **Mosaic Plot** with **Contingency Table**, we learn:

1. There is a major difference between younger and older women's views.
  - A majority of women under 35, 59.5%, feel they have better financial status. A majority of women 55 and over, 58.3% think their financial status remains the same.
  - Fewer women under 35, 11.9%, think their wealth status remains the same, while fewer women over 55, 11.1% think that they are better off financially.

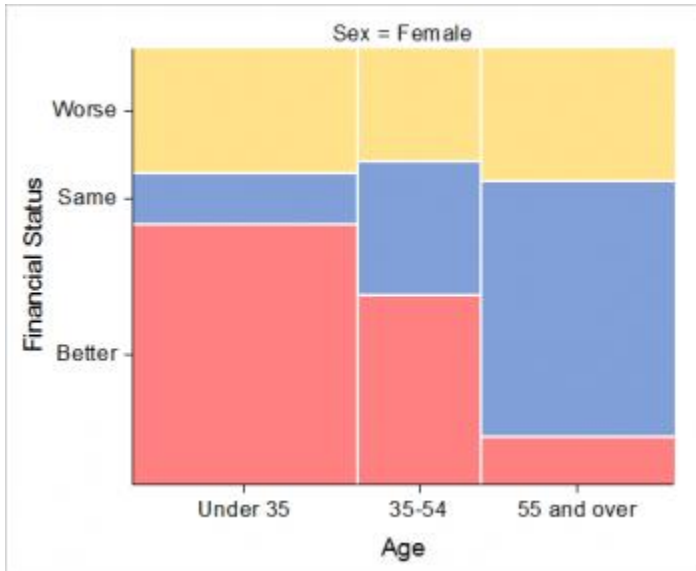

Sex = Female

		"Financial Status"				Total
		Better	Same	Worse		
"Age"	Under 35	Count	25	5	12	42
		Row%	59.52381	11.90476	28.57143	100
		Col%	64.10256	15.15152	41.37931	41.58416
		Total%	24.75248	4.9505	11.88119	41.58416
	35-54	Count	10	7	6	23
		Row%	43.47826	30.43478	26.08696	100
		Col%	25.64103	21.21212	20.68966	22.77228
		Total%	9.90099	6.93069	5.94059	22.77228
	55 and over	Count	4	21	11	36
		Row%	11.11111	58.33333	30.55556	100
		Col%	10.25641	63.63636	37.93103	35.64356
		Total%	3.9604	20.79208	10.89109	35.64356
Total	Count	39	33	29	101	
	Row%	38.61386	32.67327	28.71287	100	
	Col%	100	100	100	100	
	Total%	38.61386	32.67327	28.71287	100	

2. Compared to women, men's feeling for financial status shows another interesting pattern:
  - o Men show no significant difference in financial status between age groups.
  - o Men between 35 - 54 are a little more likely to be confident of their financial status.

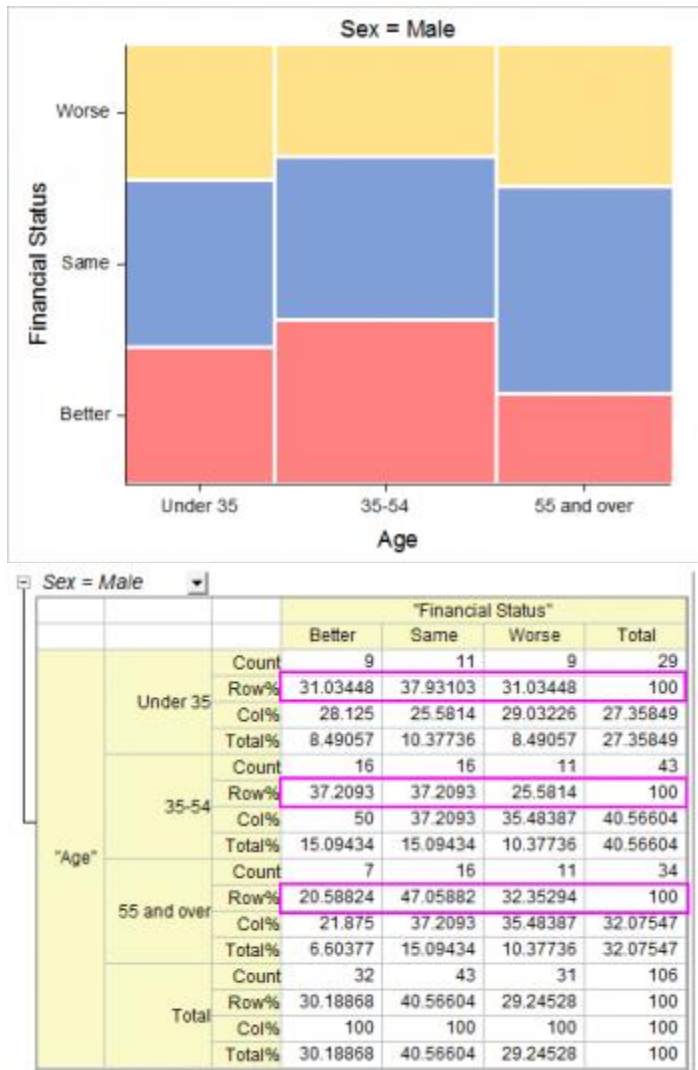

3. Regardless of the sex of respondents, there are some trends by age:
  - People under 55 are more likely to be confident of their financial status
  - People over 55 are more likely to feel that their financial status did not change.

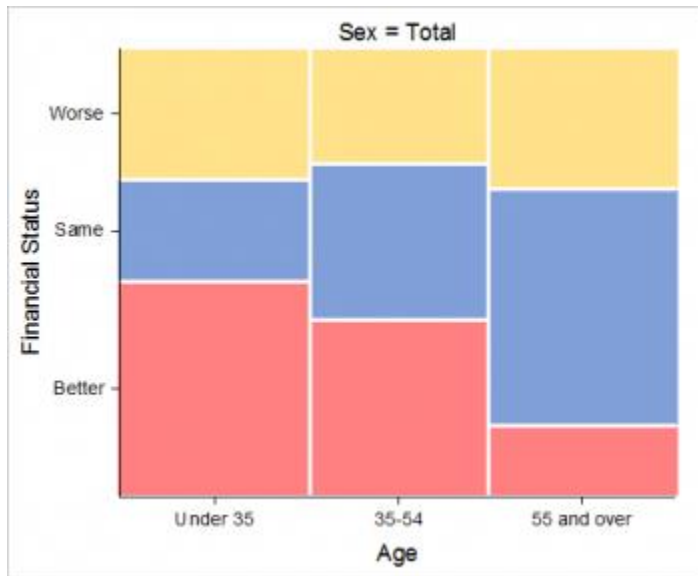

		"Financial Status"					
		Better	Same	Worse	Total		
"Age"	Under 35	Count	34	16	21	71	
		Row%	47.88732	22.53521	29.57746	100	
		Col%	47.88732	21.05263	35	34.29952	
		Total%	16.42512	7.72947	10.14493	34.29952	
	35-54	Count	26	23	17	66	
		Row%	39.39394	34.84848	25.75758	100	
		Col%	36.61972	30.26316	28.33333	31.88406	
		Total%	12.56039	11.11111	8.21256	31.88406	
	55 and over	Count	11	37	22	70	
		Row%	15.71429	52.85714	31.42857	100	
		Col%	15.49296	48.68421	36.66667	33.81643	
		Total%	5.31401	17.8744	10.62802	33.81643	
Total	Count	71	76	60	207		
	Row%	34.29952	36.71498	28.98551	100		
	Col%	100	100	100	100		
	Total%	34.29952	36.71498	28.98551	100		

### 5.2.3.6.2 Detecting Relationships Between Age and Financial Status

The **Chi-Square Tests** Table show test results for the independence of row and column variables. If the **Prob>ChiSq** is less than 0.05, this means the row and column variables, in this case age and financial status, are significantly related. Note the conclusions in the footnotes beneath the table. We conclude that:

- Women of different ages differ in financial status.
- In contrast, there is no evidence to show an association between men's age and their financial status.
- Regardless sex, people of different ages usually differ in financial status.



Chi-Square Tests T

		ChiSquare	df	Prob > ChiSq
Sex = Female	Pearson Chi-Square	24.88134	4	5.31505E-5
	Likelihood Ratio	27.39901	4	1.65075E-5
Sex = Male	Pearson Chi-Square	2.61078	4	0.62491
	Likelihood Ratio	2.68512	4	0.61182
Sex = Total	Pearson Chi-Square	20.67931	4	3.66559E-4
	Likelihood Ratio	22.06371	4	1.94652E-4

Sex = Female:  
According to Pearson Chi-Square test:  
At the 0.05 level, there is significantly evidence of association between two variables.

Sex = Male:  
According to Pearson Chi-Square test:  
At the 0.05 level, there is NOT significantly evidence of association between two variables.

Sex = Total:  
According to Pearson Chi-Square test:  
At the 0.05 level, there is significantly evidence of association between two variables.

### 5.2.3.6.3 Assessing the Strength of the Relationship

The **Measures of Association** table helps in assessing the strength of the relationship between "Financial status" and "Age". As this is a 3\*3 table(three levels for Age and three levels for Financial status), we can choose a **Contingency Coefficient** to compare across layers. (See the [introduction page](#) for the difference of the three statistics). From the table we can see

- Women's financial status shows a stronger association with age than is the case with men. (0.444 v.s. 0.155)

Measures of Associ

		Value
Sex = Female	Phi	0.49634
	Cramer's V	0.35096
	Contingency Coefficient	0.44459
Sex = Male	Phi	0.15694
	Cramer's V	0.11097
	Contingency Coefficient	0.15504
Sex = Total	Phi	0.31607
	Cramer's V	0.2235
	Contingency Coefficient	0.30137

Cramer's V, Contingency Coefficients: Values range from 0 to 1. A larger value indicates the stronger association of two variables.  
Gamma, Kendall, Somer's D: Values range from -1 to 1. A positive value means one ordinal variable increases with the other.  
Lambda, Uncertainty Coefficient: Values range from 0 to 1. A larger value indicates better prediction of Y by X.

## 5.2.4 2D Binning

### 5.2.4.1 Summary

The 2D Frequency Count/Binning operation counts the frequencies for data with two variables. A 3D bar graph and/or an image plot of the results can be generated, giving a graphic representation of data distribution.

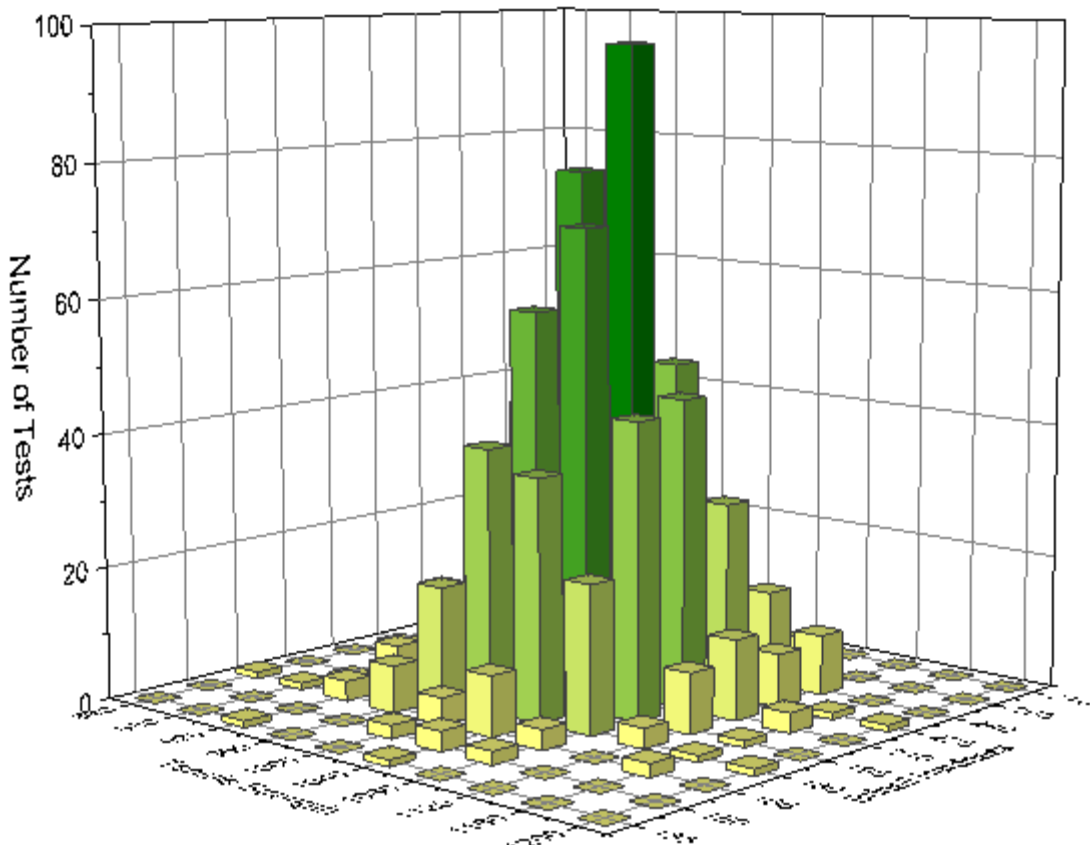

Minimum Origin Version Required: Origin 2015 SR0

#### 5.2.4.2 What you will learn

- How to count the frequencies for data with two variables.
- How to plot 2D binning into 3D Histogram.

#### 5.2.4.3 Steps

This tutorial is associated with <Origin EXE Folder>\Samples\Tutorial Data.opj.

1. Open the **Tutorial Data.opj** and browse to the folder **2D Frequency Count (Binning)**, and activate the **3D Histogram.dat** book.
2. Highlight column A and column B, select menu **Statistics: Descriptive Statistics: 2D Frequency Counts/Binning** to bring up the **TwoDBinning** dialog.
3. Specify the following settings in the dialog box:
  - Uncheck the **Auto** checkbox, set the **Bin Size** for X to 40.
  - Set the **Bin Size** for Y to 15.

Statistics\Descriptive Statistics: twoDBinning

Dialog Theme \*

Description Calculate frequencies on bivariate data

**Recalculate** Manual

**Input** (A" Tensile Strength",B" Brinell Hardness")

**"Tensile Strength"(X) [806.95 , 1191.67]**

Specify Binning Range by Bin Ends

Minimum Bin Beginning 800  Auto

Maximum Bin End 1200  Auto

Step by  Bin Size  Number of Bins

Bin Size 40  Auto

Number of Bins 10

Periodical

**Border Options**

Output Binning Order Ascending

**"Brinell Hardness"(Y) [128.25 , 260.31]**

Specify Binning Range by Bin Ends

Minimum Bin Beginning 120  Auto

Maximum Bin End 270  Auto

Step by  Bin Size  Number of Bins

Bin Size 15  Auto

Number of Bins 10

Periodical

**Border Options**

OK Cancel

- Check on **Output Matrix** checkbox in the end of the dialog and check on **3D Bars** for **Matrix Plot**.

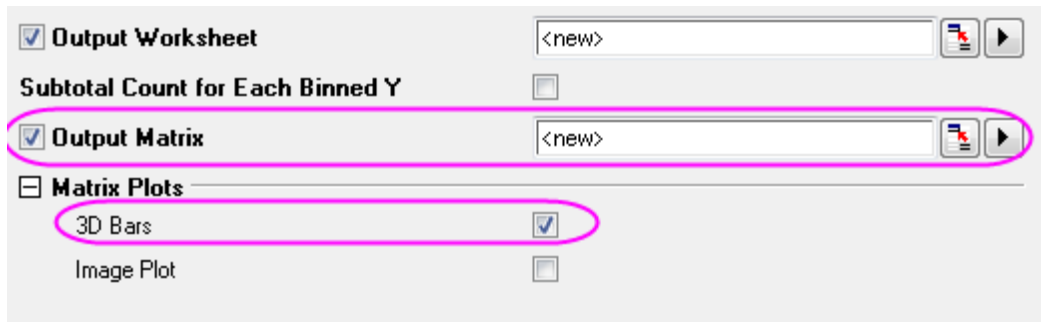

4. Click the **OK** button, then you will get the following outputs:

- **Worksheet**

	A(X)	B(Y)	C(Y)	D(Y)	E(Y)	F(Y)	G(Y)
Long Name	Bin Ends of "Tensile Strength"	Count	Count	Count	Count	Count	Count
Units							
Comments		120 - 135	135 - 150	150 - 165	165 - 180	180 - 195	195 - 210
Bin Begins of "Brinell Hardness"		120	135	150	165	180	195
Bin Centers of "Brinell Hardness"		127.5	142.5	157.5	172.5	187.5	202.5
Bin Ends of "Brinell Hardness"		135	150	165	180	195	210
F(x)=							
1	840	0	0	1	0	0	0
2	880	0	0	1	0	3	1
3	920	1	0	3	2	14	11
4	960	0	0	7	17	32	42
5	1000	0	2	4	39	58	78
6	1040	1	3	9	36	71	97
7	1080	0	2	3	22	44	46

- **Matrix**

	1	2	3	4
1	0	0	1	0
2	0	0	0	0
3	1	1	3	7
4	0	0	2	17
5	0	3	14	32
6	0	1	11	42
7	0	0	10	37
8	0	0	10	17
9	0	0	1	6

- **3D Histogram**

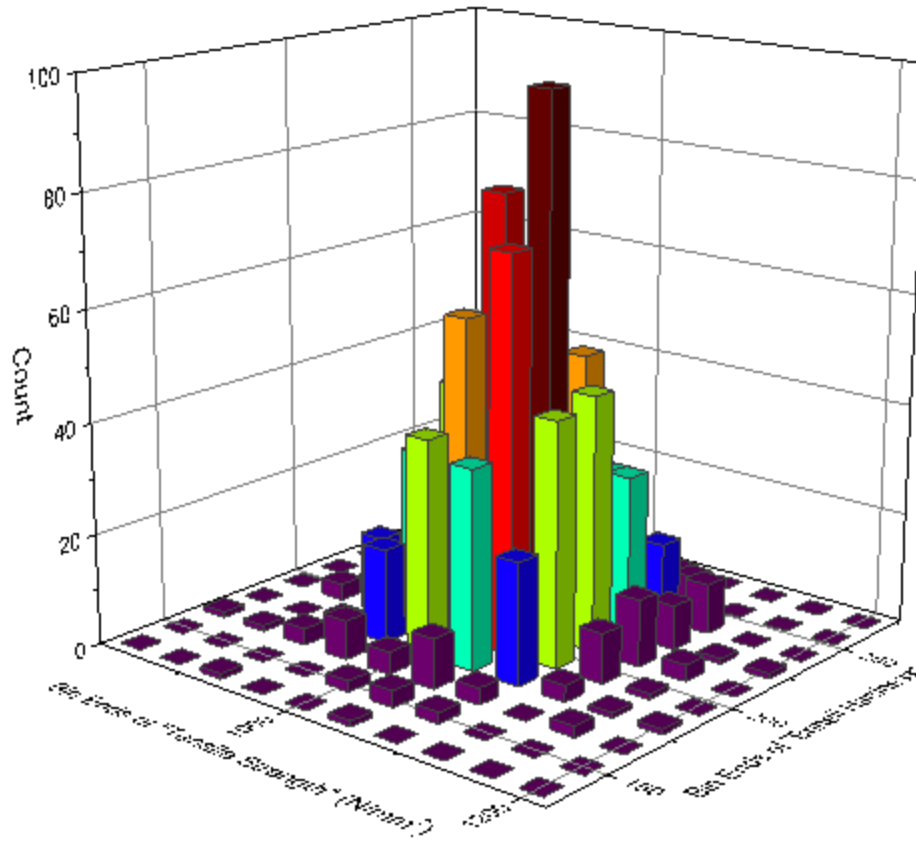

5.2.4.4 Further Customizations

3.

1. Double click the 3D Histogram to go to the **Plot Details** dialog, go to the **Colormap** tab, click the **Fill** button to open the **Fill** tab, specifies the **Fill** tab follows the graph below

2.

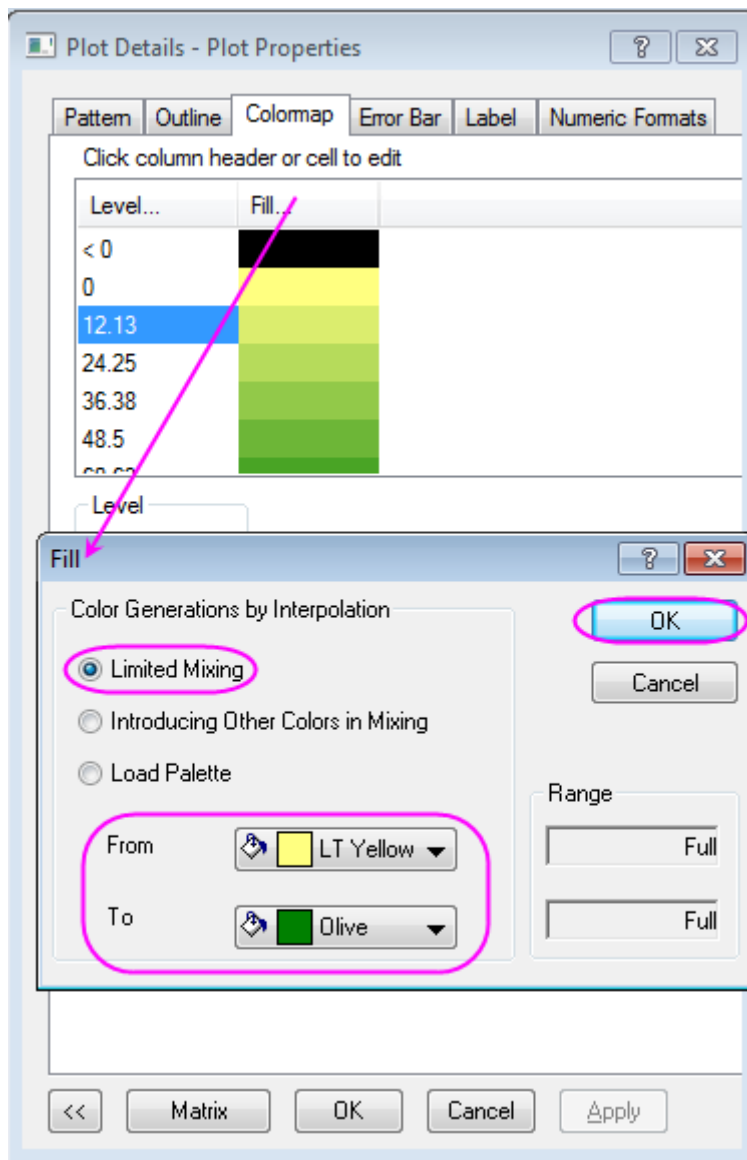

Click **OK** to close the **Fill** tab, and click **OK** in **Plot Details** to close the dialog.

3. Double click the Axis to open the **Axis** dialog and go to **Scale** tab, specifies the **Scale** for XYZ axis follows the graphs below:

4.

- Change the scale for X axis in X icon form 820 to 1220 with *Major Ticks* value 40.

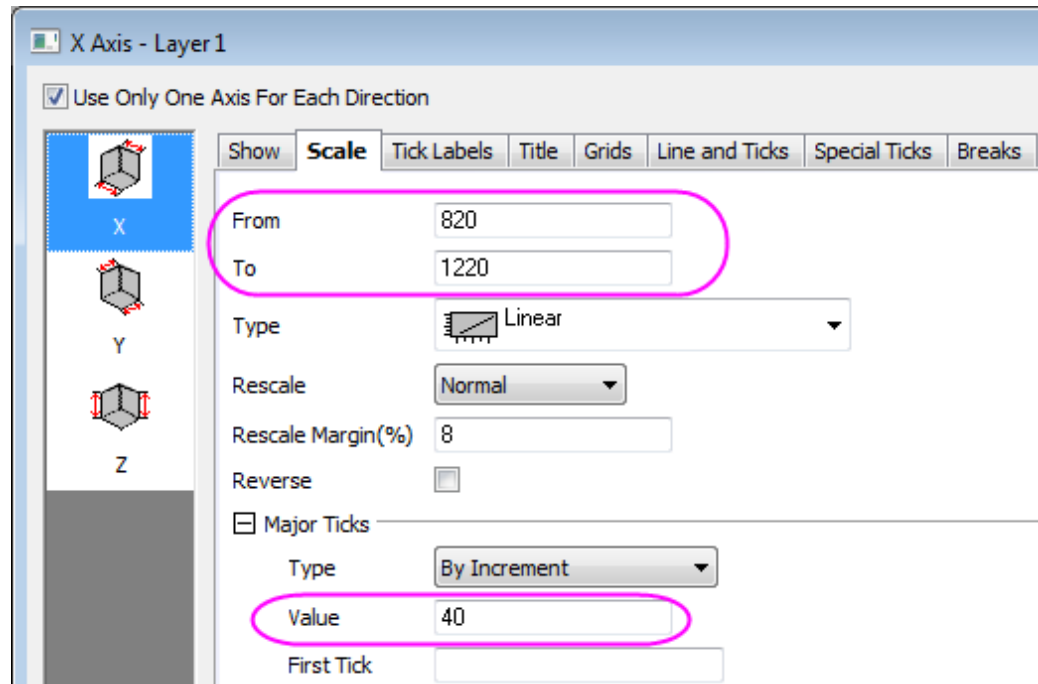

- Change the scale for Y axis in Y icon form 127.5 to 277.5 with *Major Ticks* value 15.
  - Change the scale for Z axis in Z icon form 0 to 100 with *Major Ticks* value 20.
5. Change title for X, Y, Z axis in **Title** tab into *Tensile Strength*, *Brinell Hardness* and *Number of Tests*, respectively. Click **OK** to apply the setting and close the dialog.

## 5.2.5 Distribution Fit

### 5.2.5.1 Summary

Knowing the distribution model of the data helps you to continue with the right analysis. or make estimation of your data. The **Distribution Fit** tool helps users to examine the distribution of their data, and estimate parameters for the distribution.

### 5.2.5.2 What you will learn

This tutorial will show you:

- How to carry out distribution fit for practical data with Origin
- How to interpret the generated results

### 5.2.5.3 User Story

A house builder is trying to decide how many new houses he should build in the next year based on past sales of houses in the surrounding area. He would like to know the following:

- If he is going to build 80 new houses, what is the probability that all of them will be sold?
- The builder believes that he can make a profit if there is at least a 60% probability that he will sell all of his houses. How many houses should he build?

To solve this problem, The house builder needs to:

- Perform a distribution fit to sample data (houses sold in the surrounding area)
- Select the best fitting distribution
- Calculate the probability using the cumulative distribution function of the selected distribution
- If the probability is more than 60%, reconsider the schedule.

#### 5.2.5.4 Choosing Distributions

1. Start with a new project or a new workbook. Import the data file: **\Samples\Statistics\HouseSold.dat**
2. Highlight Column B, select **Plot > 2D : Histogram: Histogram** from Origin menu

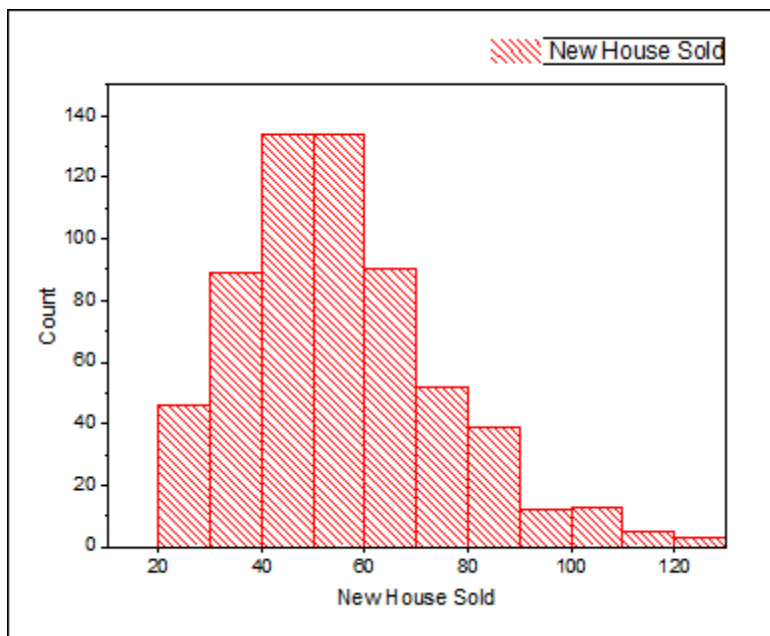

3. Consider the facts as below to choose the distributions:
  - The data are taken on integer values only so we can consider to fit both continuous and discrete distributions. (If there are floating point numbers, only continuous distributions can be considered). However, as usually continuous distributions provide better fit than discrete distributions we want to choose from continuous distributions.
  - Value of new house sold are positive values, we don't need to consider the normal distribution, which can take on negative values
  - Look at the histogram, the data is clustered around a value, we don't need to consider the exponential distribution, which is for data extremely asymmetric



5.2.5.5 Performing Distribution Fit

1. Return to the **HouseSold** worksheet and highlight the column B. From the Menu Bar, select the **Statistics: Descriptive Statistics: Distribution Fit** menu
2. In the dialog that opens, in the **Distributions** tab, clear **Normal** and select the following three distributions based on the conclusions in the [Choosing Distributions](#) section
  - **LogNormal**
  - **Weibull**
  - **Gamma**

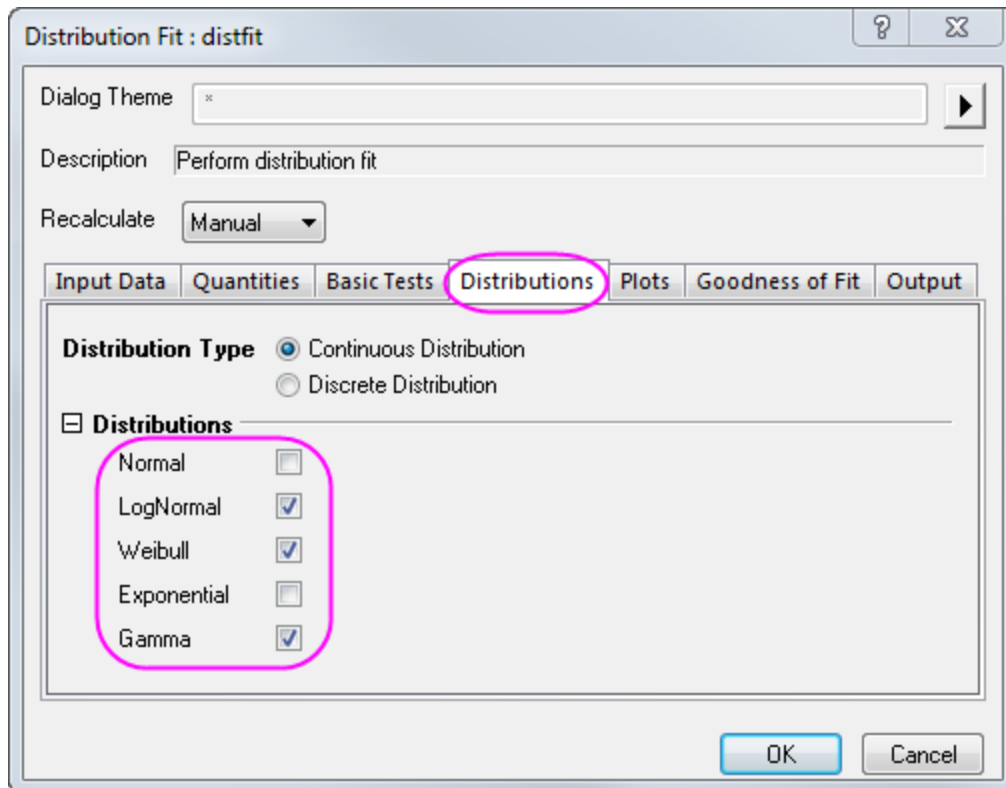

3. In the **Plots** tab, select **Probability Plot**

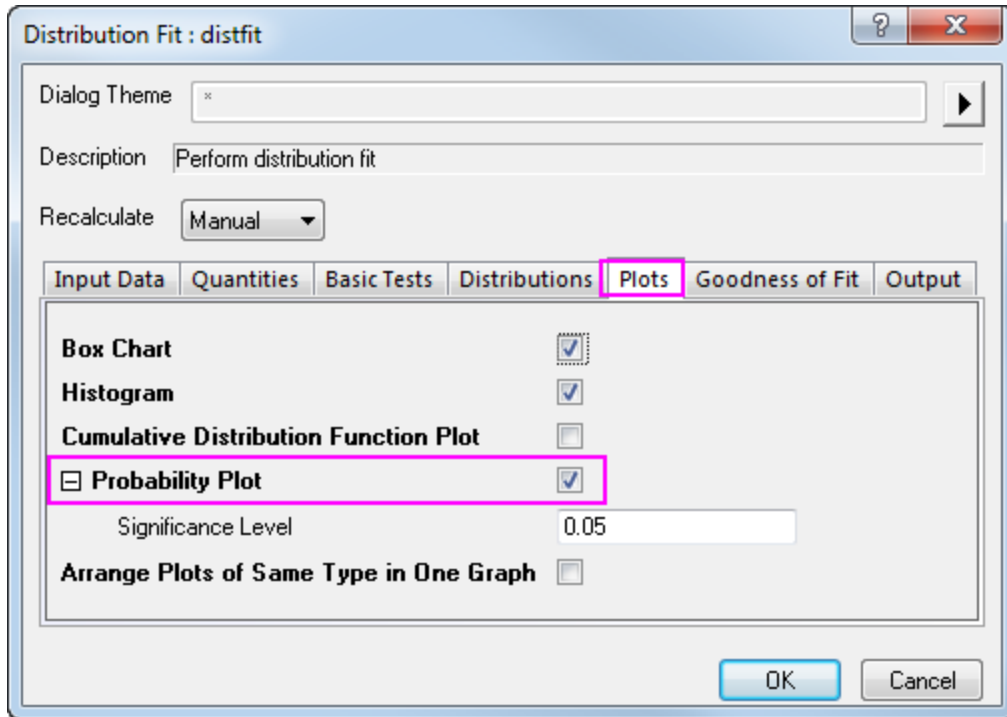

4. In the **Goodness of Fit** tab, check all three methods. Click **OK** to apply the settings and close dialog.

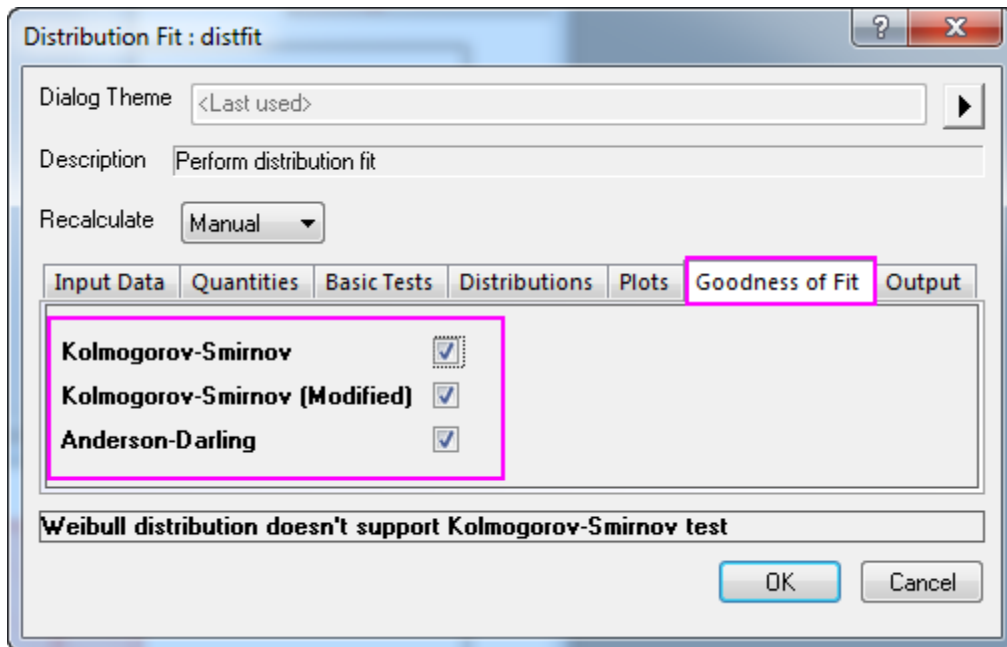

#### 5.2.5.6 Comparing and Selecting Fitting Models

We can compare and select a fitting model based on the following results of distribution fit:

- **Probability (P-P) Plot**

The closer all the scatter points are to the reference line, the better the distribution is for the dataset. From the Probability Plot, both lognormal and gamma distribution can be considered as good models for the data.

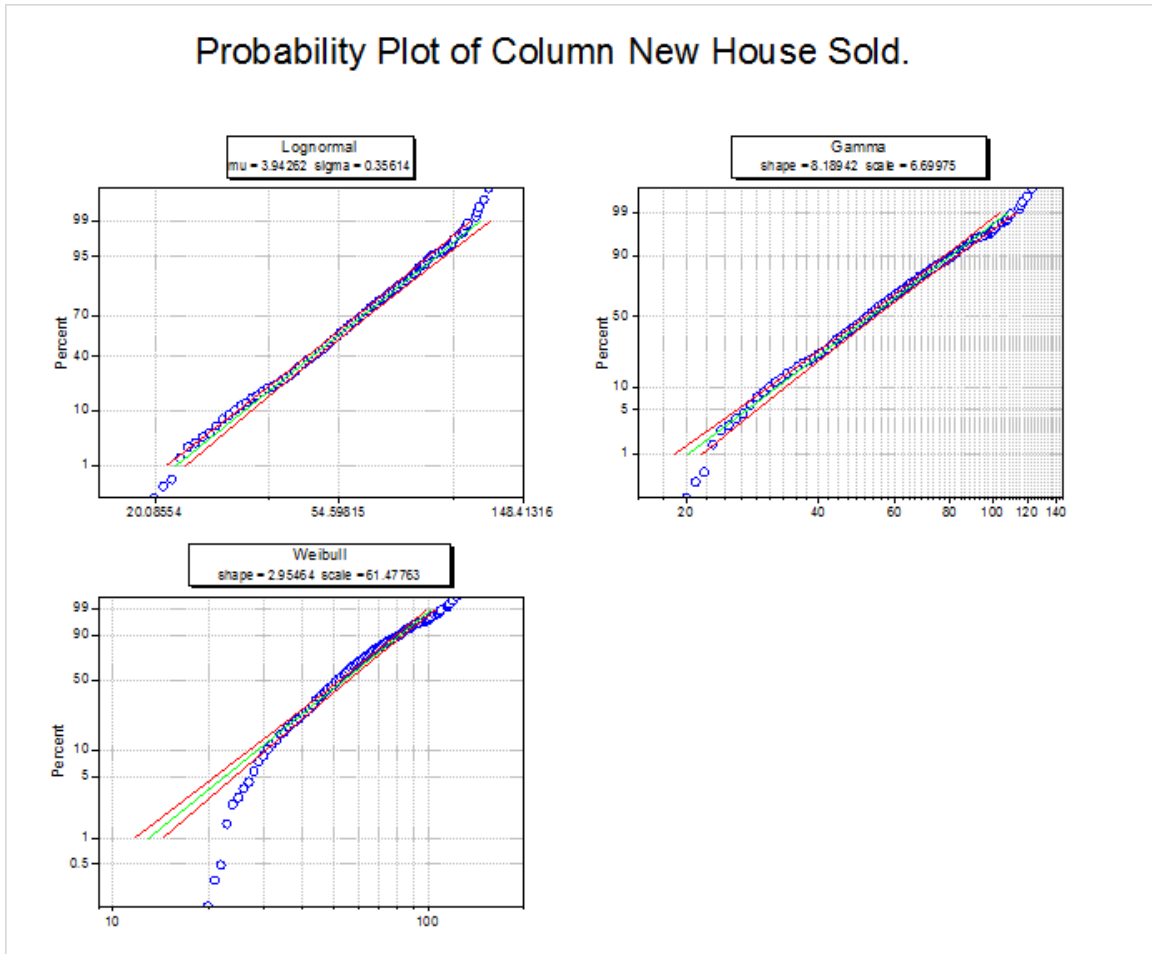

• **Goodness of Fit Tests** table

Look at the P-values in table, if the p-value is less than 0.05, it means we reject the distribution at the 0.05 level. P-value of lognormal and gamma are larger than 0.05, then from the **Goodness of Fit Tests**, we can see that both lognormal and gamma are good models for the data.

☐ **Goodness-of-Fit Tests** ▾

	Distribution	Goodness of Fit tests	Statistics	P-value	Decision at level(5%)
New House Sold	Lognormal	K-S test	0.03457	0.45539	Can't reject Lognormal
		K-S modified test	0.03295	0.0998	Can't reject Lognormal
		A-D test	0.68316	0.07408	Can't reject Lognormal
	Weibull	K-S modified test	0.06783	<=0.01	Reject Weibull
		A-D test	4.90331	<0.01	Reject Weibull
	Gamma	K-S test	0.02828	0.74285	Can't reject Gamma
		K-S modified test	0.02797	>0.25	Can't reject Gamma
		A-D test	0.54291	0.18207	Can't reject Gamma

From the **Probability (P-P) Plot** and **Goodness of Fit Tests** table, we can draw a conclusion that lognormal and gamma are both good choices. Here we choose the lognormal as an example for further analysis.

5.2.5.7 Making Estimations

Once the best distribution model is found, we can use the CDF and INV functions to calculate these probabilities:

- If he is going to build 80 new houses, what is the probability that all of them will be sold?
- How many houses should be built if he hopes to have a 60% chance of selling all of the houses?

1. To answer the first question, open the **Command Window** or the **Script Window** from the **Windows** menu, and type commands as below

```
logncdf(80, 3.94262, 0.35614) =
```

where 3.94262 is mu and 0.35614 is sigma, obtained from the **Parameter Estimates** table in the Report Sheet.

Parameter Estimates					
	Distribution	Parameter	Estimate	Lower 95%	Upper 95%
New House Sold	Lognormal	Location mu	3.94262	3.91452	3.97072
		Scale sigma	0.35614	0.33679	0.37661
	Weibull	Scale alpha	61.47763	59.76193	63.24259
		Shape beta	2.95464	2.78884	3.1303
	Gamma	Shape alpha	8.18942	7.34083	9.13611
		Scale theta	6.69975	5.98501	7.49985

2. You will get

```
logncdf(80, 3.94262, 0.35614) = 0.89136185728793
```

We can conclude that if the house builder builds 80 new houses, there is an 89% probability that he will NOT sell all of those houses.

1. To answer the second question, run the script below in the **Command Window** or the **Script Window**

```
logninv(1-0.6, 3.94262, 0.35614) =
```

2. You will get

```
logninv(1-0.6, 3.94262, 0.35614) = 47.105650533425
```

We can conclude that the house builder is more likely to make a profit if he builds 47 new houses.



We choose the lognormal model in [Choosing Distribution section](#) so we use `logncdf` and `logninv` for the estimation. If we choose gamma, we can use `gamcdf` and `gaminv` for the estimation, which will result in a similar conclusion.

**Notes:** There are also other descriptive statistics and graphs in results of **Distribution Fit** which help you to take a quick look of your data

- **Descriptive Statistics** table
- **Quantiles** table
- **Histogram**
- **Box Chart**
- **CDF** (Cumulative Distribution Function Plot)

## 5.2.6 Partial Correlation Coefficient

### 5.2.6.1 Summary

The Partial Correlation Coefficient is a tool for measuring the the linear relationship between two random variables, after excluding the effects of one or more control variables.

### 5.2.6.2 What you will learn

This tutorial will show you:

- How to carry out partial correlation in Origin, using a practical example.
- How to interpret the generated results.

### 5.2.6.3 User Story

We have some public data from the World Bank that includes 11 indicators (health expenditure, GDP, population, etc.) by country, for years 2000 to 2010. We want to study the relationship between internet use, mobile phone use and health expenditures in the United States.

### 5.2.6.4 Detect Relationship with Pearson's R

This tutorial is associated with <Origin EXE Folder>\Samples\Tutorial Data.opj.

1. Open the **Tutorial Data.opj** and browse to the folder **Partial Correlation Coefficient**, and activate the **Partial Correlation Coefficient** book.
2. Activate **Sheet1** with source data. We have already applied a data filter to get data for the United States between 2000 and 2010.
3. First we will use the **Correlation Coefficient** tool to visually detect the relationship between **Mobile phone subscribers, Total internet users, Health expenditures per capita** and the **GDP per capita**.
  1. Press the **Ctrl** key and highlight **Col(E), Col(U1), Col(H)** and **Col(S)**.
  2. From the menu, select **Statistics: Descriptive Statistics: Correlation Coefficient**.
3. In the opened dialog, select the **Scatter plots** and **Add Confidence Ellipse** check boxes under the **Plots** branch. Clear the **Show Significance in Result Table** check box and select the **Flag Significant Correlations** check box.

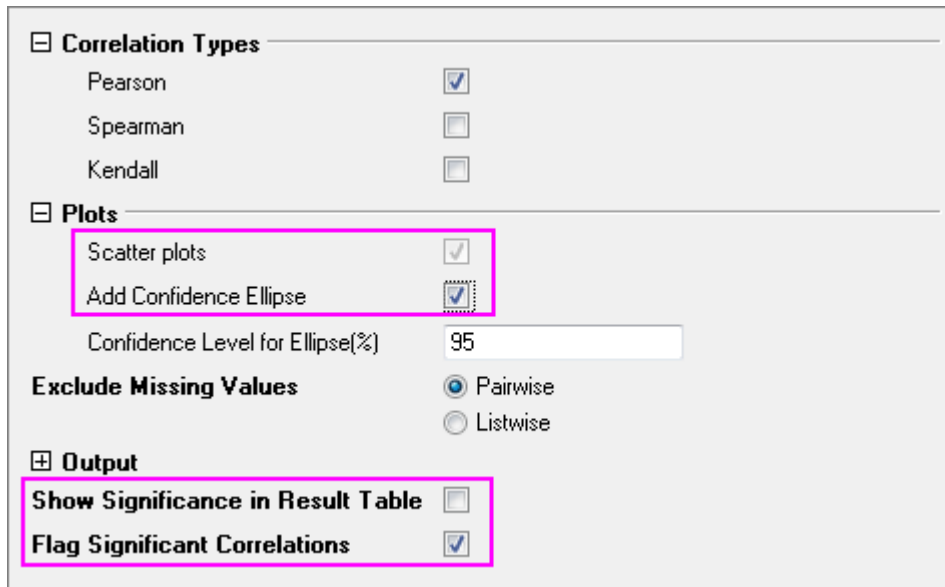

4. From the Pearson's correlation coefficient and the scatter matrix, we can see:
  3.
    - o The scatter data are fairly linear.
    - o The shape of confidence ellipses is narrow.
    - o All Pearson's correlation coefficients are flagged in red.
    - o Each Pearson's correlation coefficient is larger than 0.9.

It appears that there is a strong relationship between **Mobile phone subscribers, Total internet users, Health expenditures per capita** and **GDP per capita**.



5.2.6.5 Revealing the Real Relationship with Partial Correlation Coefficients

Though it appears that **Mobile phone subscribers**, **Total internet user** and **Health expenditure per capita** are strongly related, we know that **GDP per capita** also affects these three indicators. We want to measure the real relationship of the three indicators after excluding the effect of **GDP per capita**.

1. Activate the sheet with source data. Press the **Ctrl** key and highlight **Col(E)**, **Col(U1)** and **Col(H)**.
2. Choose menu **Statistics: Descriptive Statistics: Partial Correlation Coefficient**.
3. In the opened dialog, the three highlighted columns are automatically selected as **Variables**.
4. We want to remove the effect of **GDP per capita**, so we choose **Col(S)** as **Controlling Variables**. Select the **Flag Significant Correlations** check box.

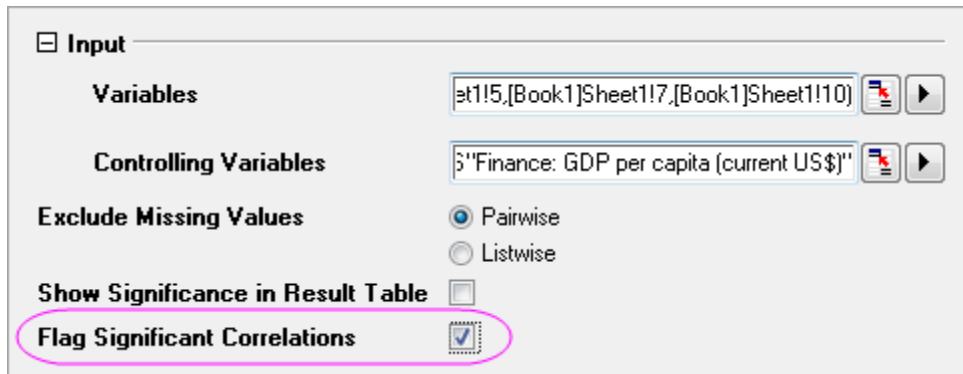

5. Go to sheet **PCorr1**. It contains the partial correlation coefficients after excluding the effect of **GDP per capita**. We can see:
  - Only **Mobile phone subscribers** and **Health expenditures per capita** are significantly related (The Partial Corr value is marked as red). But the real relationship is not as strong as the **Pearson's r** seemed to show previously. (Partial Corr = 0.87307 v.s. Pearson's Corr = 0.99157).

- The Partial correlation coefficient for **Mobile phone subscribers** and **Total internet users** decreased to be 0.26178. They are not significant related.
- There is no evidence to show **Total internet users** and **Health expenditures per capita** are related (Partial Corr = 0.07615), while previously, we obtained a Pearson's  $r = 0.96685$ .

	Business: Mobile phone subscribers	total internet user	Health: Health expenditure per capita (current US\$)
Partial Correlations	Partial Correlations	Partial Correlations	Partial Correlations
Business: Mobile phone subscribers	1	0.26178	0.87307
total internet user	0.26178	1	0.07615
Health: Health expenditure per capita (current US\$)	0.87307	0.07615	1

#### 5.2.6.6 Conclusion

Why such different results? Looking at the Pearson's  $r$  value of **GDP per capita** between the other three indicators, we can see **GDP per capita** influenced the three indicators. Even though there is no relationship between **Total internet users** and **Health expenditures per capita**, **Total internet users** and **Mobile phone subscribers**, the "false relationship" is still shown by the Pearson's  $r$  because of the effect of **GDP per capita**. Partial Correlation Coefficients are useful for examining the true relationship between two factors by eliminating the effects of correlated control variables. The statistic is useful for experiments where various interrelated phenomena are to be studied.

## 5.3 Hypothesis Tests

### 5.3.1 Summary

Hypothesis tests are frequently used to measure the quality of sample parameters or to test whether estimations for two samples on a given parameter are equal .

With parametric methods, assumptions are made about the underlying distribution from where the sample populations are selected. Usually, it requires that the data are independently sampled from a normal distribution.

### 5.3.2 What you will learn

This tutorial will show you:

- How to carry out hypothesis tests for practical data with Origin
- How to interpret the generated results

### 5.3.3 Steps

#### 5.3.3.1 Hypothesis Tests in Origin

Data Type	Goal	Method
-----------	------	--------



One Sample	Compare the mean with a given value	One-Sample t-Test
	Compare the variance with a given value	One-Sample Test for Variance
Two Samples	Test whether the means are equal	Two-Sample t-Test
	Test whether the variance are equal	Two Sample Test for Variances
Paired Samples	Test whether the means are equal	Pair-Sample t-Test

### 5.3.3.2 One-Sample t-Test

#### Perform One-Sample t-Test using Raw data

Suppose a manufacturer produces high-quality screw nuts that must equal 21 millimeters in diameter. The quality control department randomly drew 120 nuts from the finished products, measured the diameters for each and stored the results in `Diameters.dat` file. They want to determine whether the mean diameter of the nuts is equal to 21 or not. Historically, the distribution of the measured diameters is known to be approximately normal, but the standard deviation of the population is unknown. Hence they may use the One-Sample t-Test in Origin following the steps below:

1. Start with a new workbook and import the file `\Samples\Statistics\diameter.dat`.
2. Open the **One-Sample t-Test** dialog by using the menu item **Statistics:Hypothesis Testing:One-Sample t-Test**.
3. Click the **Input** tab, set **Input Data Form** to **Raw**.
4. Click the arrow button to the right of **Input** and select  $A(X):diameter$ .
5. Click the **t-Test for Mean** tab and set **Test Mean** to  $21$ ; Make sure that **Alternate Hypothesis** is set to  $Mean <> 21$  (two-sided test), check **Confidence Interval(s)** and set **Confidence Level(s) in %** to  $95$ .

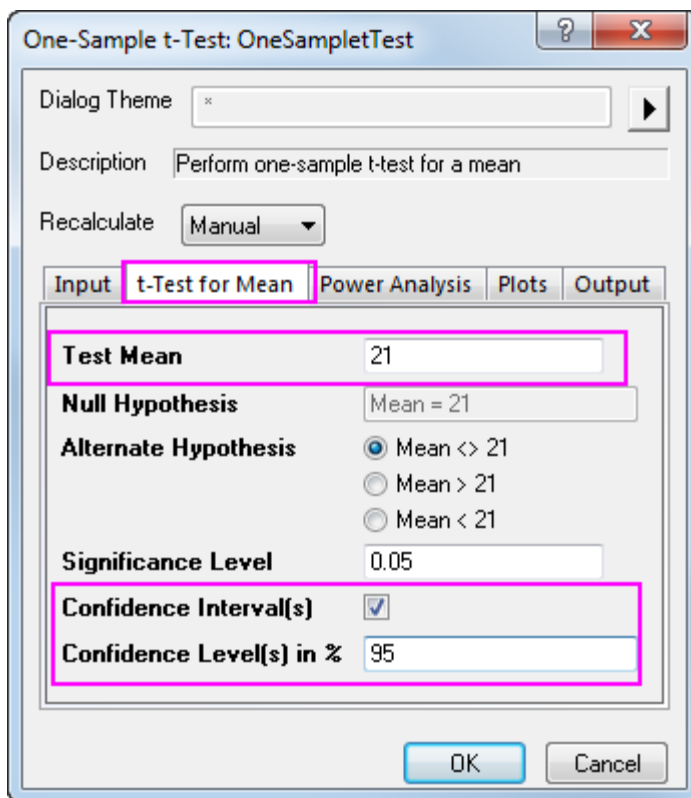
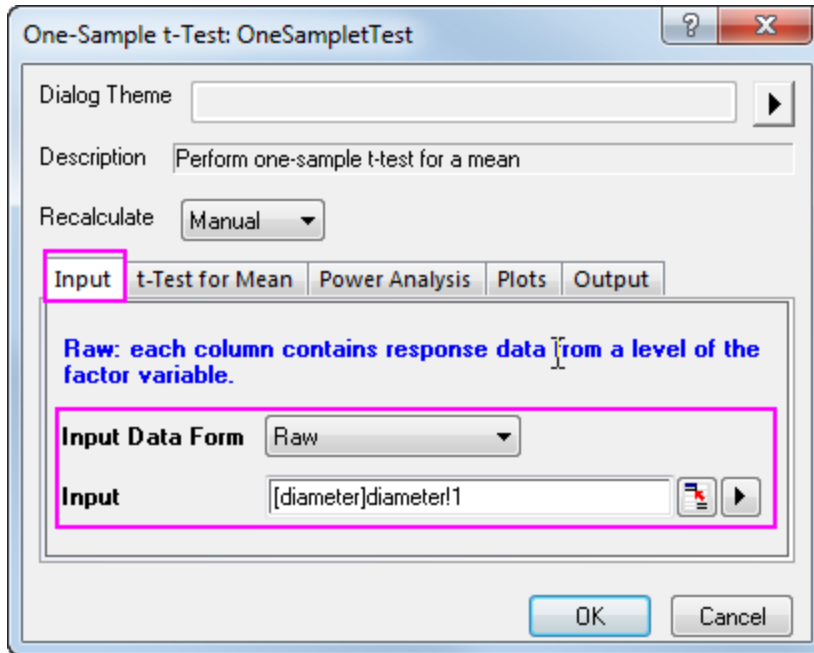

6. Note that by default the test procedure provides descriptive statistics of the variable and the hypothesis test results. Additionally, it is possible to produce a histogram of the data and a confidence interval for the mean.
7. Click the **OK** button to finish the analysis and generate results.

The Descriptive Statistics table shows the sample size, mean, standard deviation, and standard error for the variable. The sample mean, 21.00459, is comparatively little bigger than the hypothesis mean 21, and the standard error of the mean(SEM) is 0.00156.

Descriptive Statistics

	N	Mean	SD	SEM
"diameter"	100	21.005	0.0156	0.00156

From the t-Test table, the t statistic (2.9437) and the associated p-value (0.00404) provide evidence that the average diameter of screw nuts is significantly different with 21 at the  $\alpha = 0.05$  level.

Test Statistics

	t Statistic	DF	Prob> t
"diameter"	2.9437	99	0.00404

Null Hypothesis: Mean = 21  
 Alternative Hypothesis: Mean <> 21  
 "diameter": At the 0.05 level, the population mean is significantly different from the test mean (21).

The confidence interval indicates that it is 95% confident that the true mean of the variable lies within the interval [21.0015, 21.00769].

Confidence Intervals for Mean

	Conf. Levels in %	Lower Limits	Upper Limits
"diameter"	95	21.0015	21.00769

**Perform One-Sample t-Test using Summarized data**

To perform a One-Sample t-Test using summarized data, we need to change the **Input Data From** in **Input** tab into **Summarized data**.

Assume we have measured 70 nuts this time, so the sample size will be 70. After a further calculation, we have got 20.95 for the mean, and 0.218 for the standard deviation. So we enter the mean, standard deviation

and sample size into the **Input** Box below: </br>

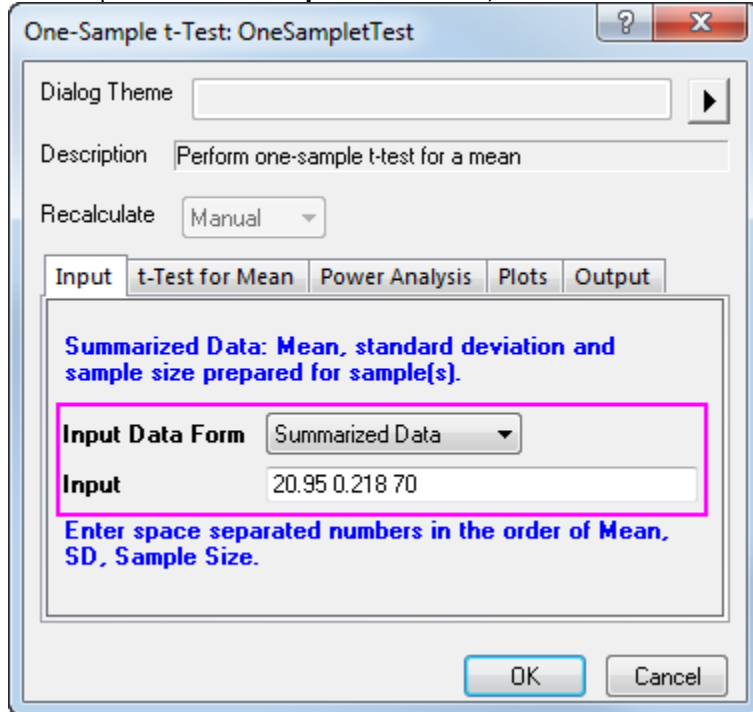

Then, we set 21 as the **Test Mean** in **t-Test for Mean** tab, click **OK** to execute.

We get the summary table shown below, the results indicate that the population mean is NOT significantly different from the test mean in this study.

**Test Statistics**

	t Statistic	DF	Prob> t
Summarized Data	-1.91895	69	0.05913

Null Hypothesis: Mean = 21  
 Alternative Hypothesis: Mean <> 21  
 At the 0.05 level, the population mean is NOT significantly different from the test mean (21).

### 5.3.3.3 Pair-sample t-Test

#### Perform Pair-sample t-Test using Raw data

Suppose you want to compare abrasion resistance between two kinds of tires. You randomly draw from each type of tires respectively and group them into 8 pairs. Make sure each pair consists of two types of tires. Next, equip the paired tires on 8 planes to run the abrasion test and measure the abrasion data to do paired-sample t-test.

1. Start with a new workbook and import the file **\Samples\Statistics\abrasion\_raw.dat**.
2. Open the **Pair-sample t-Test** dialog by using the menu item **Statistics:Hypothesis Testing:Pair-sample t-Test**.
3. On the **Input** tab, set column *tireA* as **1st Data Range** and column *tireB* as **2nd Data Range**.
4. Click the **t-Test for Mean** tab and enter 0 to be **Test Mean**.

Descriptive Statistics

	N	Mean	SD	SEM
"diameter"	100	21.005	0.0156	0.00156

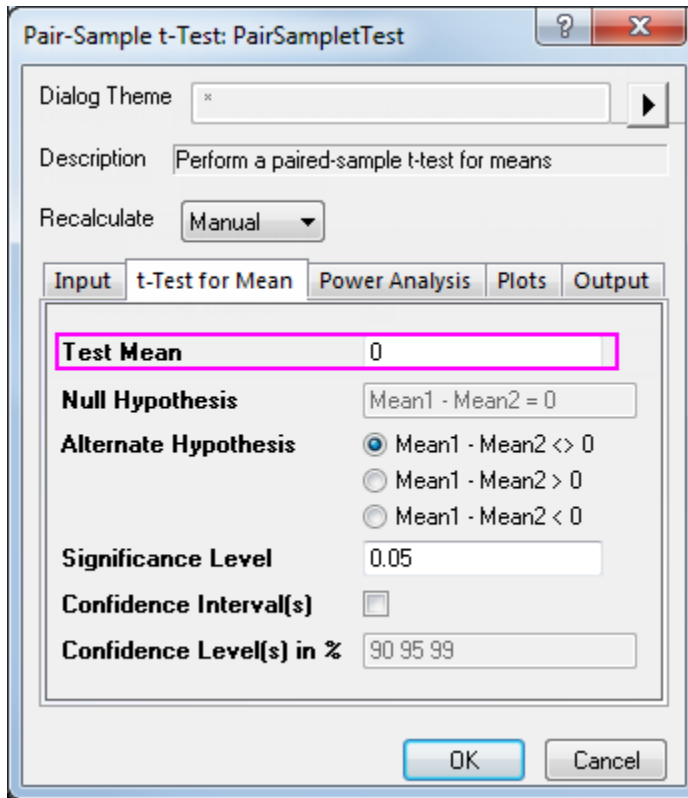

- Accept other settings as default and click the **OK** button to generate results.

Descriptive Statistics

		N	Mean	SD	SEM	Median
"tireA"		8	6145	1366.49709	483.12968	5760
"tireB"		8	5825	1097.46461	388.01233	5420
	Difference	8	320	319.68735	113.02655	320
	Overall	16	5985	1208.63008	302.15752	5600

Test Statistics

	t Statistic	DF	Prob> t
	2.83119	7	0.02536

Null Hypothesis: mean1-mean2 = 0  
 Alternative Hypothesis: mean1-mean2 <> 0  
 At the 0.05 level, the difference of the population means is significantly different from the test difference(0).

From the t-Test table, the t statistic (2.83119) and the associated p-value (0.02536) indicate that the difference between the two means is significant, that is to say, the two types of tires have different abrasion resistance.

Perform Pair-sample t-Test using Summarized data

Perform Pair-Sample t-Test using Summarized data

To perform a Pair-Sample t-Test using summarized data, we need to change the Input Data From in Input tab into Summarized data.

Assume 16 samples has been tested this time, so the sample size will be 16. After a further calculation, we have got 305 for the mean paired difference, and 310 for the standard deviation for the difference between paired data points (please refer to Algorithms: [Pair Sample T-Test](#)). So we enter the mean difference, standard deviation and sample size into the Input Box below:

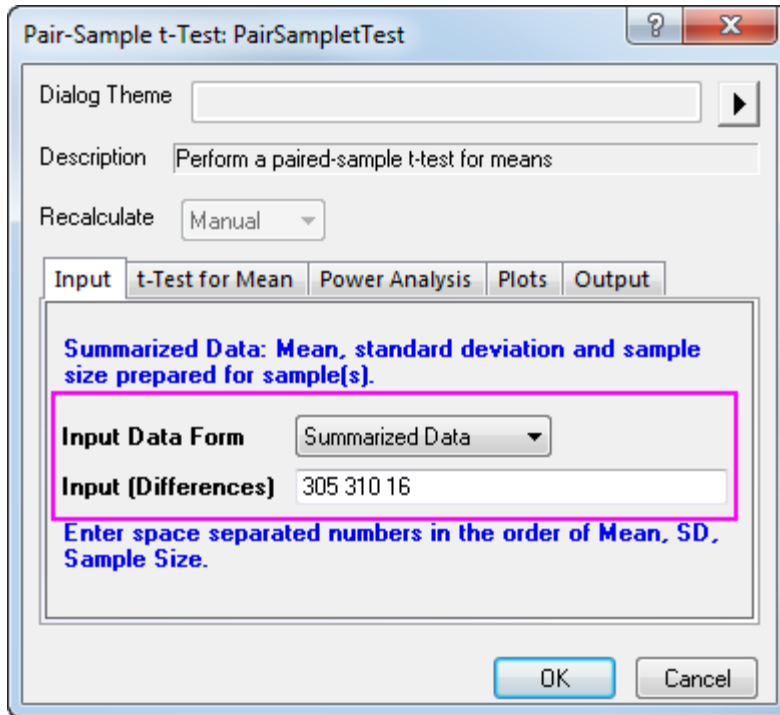

Since our data yielded a p-value of 0.0013, which is less than our 0.05 a-level, we can reject the null hypothesis.

Test Statistics

	t Statistic	DF	Prob> t
Summarized Data	3.93548	15	0.00132

Null Hypothesis: mean1-mean2 = 0  
 Alternative Hypothesis: mean1-mean2 <> 0  
 At the 0.05 level, the difference of the population means is significantly different from the test difference(0).

This study indicates the difference between the two means is significant, thus, the two types of tires have different abrasion resistance.

5.3.3.4 Two-Sample independent t-Test

Perform Two-Sample t-Test using Raw data

A physician is evaluating the effect of two kinds of soporifics. To test the effectiveness of these two medicines, 20 insomniacs patients are randomly selected. Half took medicine A and the other half took medicine B, The extended sleeping time were recorded after each patient took the medicine. The result is saved as the time\_raw.dat file.

To determine whether the two medicine have different effect on patients, we could carry out a two-sample independent t-test with the following steps:

1. Start with a new workbook and import the file `\Samples\Statistics\time_raw.dat`.
2. Open the **Two-Sample t-Test** dialog by using the menu item **Statistics:Hypothesis Testing:Two-Sample t-Test**.
3. On the **Input** tab, select **Raw** for the **Input Data Form**; set *medicineA* as **1st Data Range** and *medicineB* as the **2nd Data Range**.

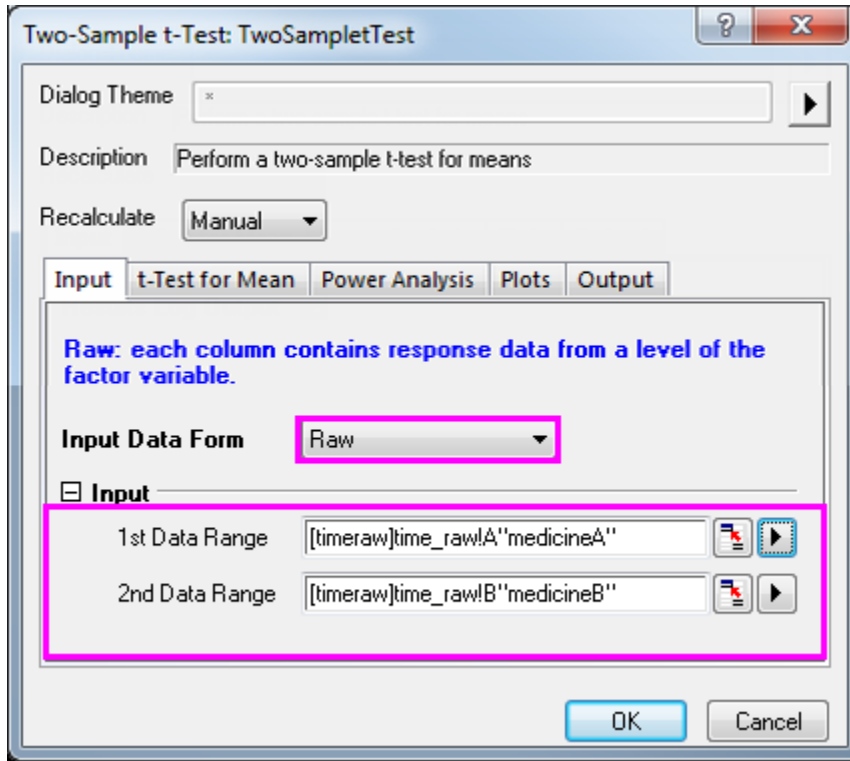

4. Accept other settings as default and click the **OK** button to generate results.

The t-Test procedure automatically provides two tests of the mean difference. One is based on the assumption that the variances of two samples are equal and the other is not. In this example, both tests indicate that there is no significant evidence for a difference in cure effects between medicine A and medicine B. (p-values are 0.0738 and 0.074, both greater than the significance level 0.05.)

**t-Test Statistics**

	t Statistic	DF	Prob> t
Equal Variance Assumed	1.89811	18	0.07384
Equal Variance NOT Assumed (Welch Correction)	1.89811	17.8248	0.074

Null Hypothesis: mean1-mean2 = 0  
 Alternative Hypothesis: mean1-mean2 <> 0  
 At 0.05 level, when equal variance is assumed, Mean1 - Mean2 is NOT significantly different from 0  
 At 0.05 level, when equal variance is NOT assumed, Mean1 - Mean2 is NOT significantly different from 0

Perform Two-Sample t-Test using Summarized data

To perform a Two-Sample t-Test using summarized data, we need to change the **Input Data Form** in **Input** tab into **Summarized data**.

Assume 50 patients has been tested this time, so the sample size will be 50. After a further calculation, we have got 2.33 for the 1st mean, and 1.858 for the 1st standard deviation, and 1.28 for the 2nd mean, and 1.671 for the 2nd standard deviation. So we enter the mean, standard deviation and sample size into the Input Box below.

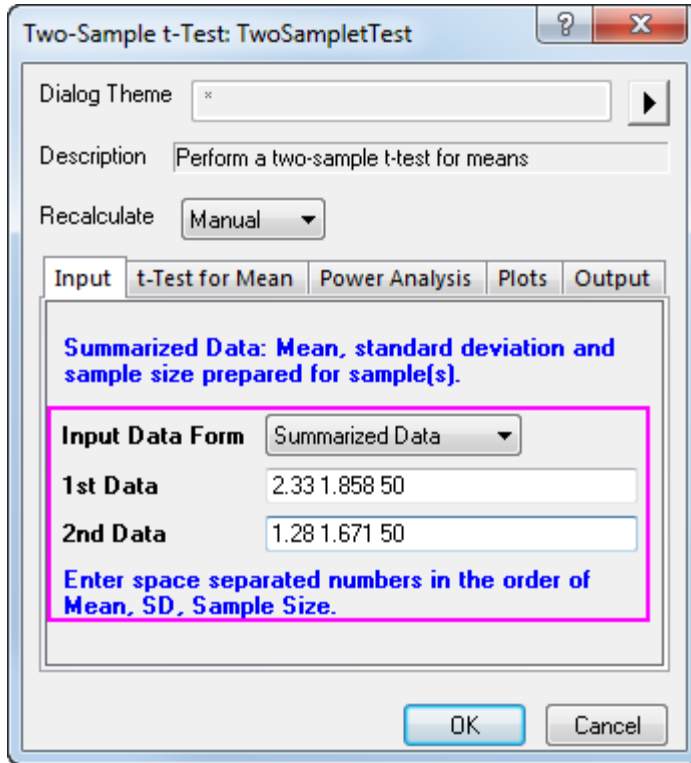

We can also check on the Confidence Intervals (Levels in 95%) in **t-Test for mean** tab, to calculate the difference between test groups. Click **OK** to execute.



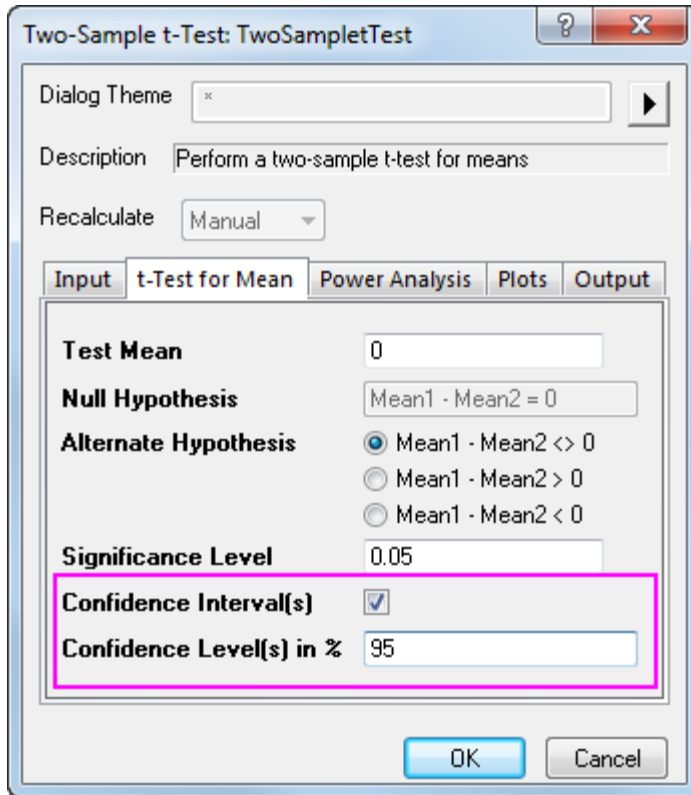

Since our data yielded a p-value of 0.0037, which is less than our 0.05  $\alpha$ -level, we can reject the null hypothesis. This study indicates that the mean extended sleeping of two patients groups are not the same. In fact, we can conclude that 1st soporific has a stronger effect on patients.

The Confidence Intervals show that we can be 95% confident that the mean time difference between two groups is 0.3487~1.7513

**t-Test Statistics**

	t Statistic	DF	Prob> t
Equal Variance Assumed	2.97118	98	0.00373
Equal Variance NOT Assumed (Welch Correction)	2.97118	96.91755	0.00374

Null Hypothesis: mean1-mean2 = 0  
 Alternative Hypothesis: mean1-mean2 <> 0  
 At 0.05 level, when equal variance is assumed, Mean1 - Mean2 is significantly different from 0  
 At 0.05 level, when equal variance is NOT assumed, Mean1 - Mean2 is significantly different from 0

**Confidence Intervals for Mean**

Conf. Levels in %	Lower Limits	Upper Limits
95	0.3487	1.7513



Note that both equal variance and unequal variance assumptions are supported. To determine whether the two samples have equal variances, we may select from top menu **Statistics:Hypothesis Testing:Two-Sample Test for Variance** to use the two-sample test for variance for testing

5.3.3.5 Two-Sample Test for Variance

1. Continue with a new workbook and import the file `\Samples\Statistics\time_raw.dat`.
2. Open the **Two-Sample Test for Variance** dialog by using the menu item **Statistics:Hypothesis Testing:Two-Sample Test for Variance**.
3. Select "Raw" for the **Input Data Form**; set column A and column B as the first and second data range respectively.

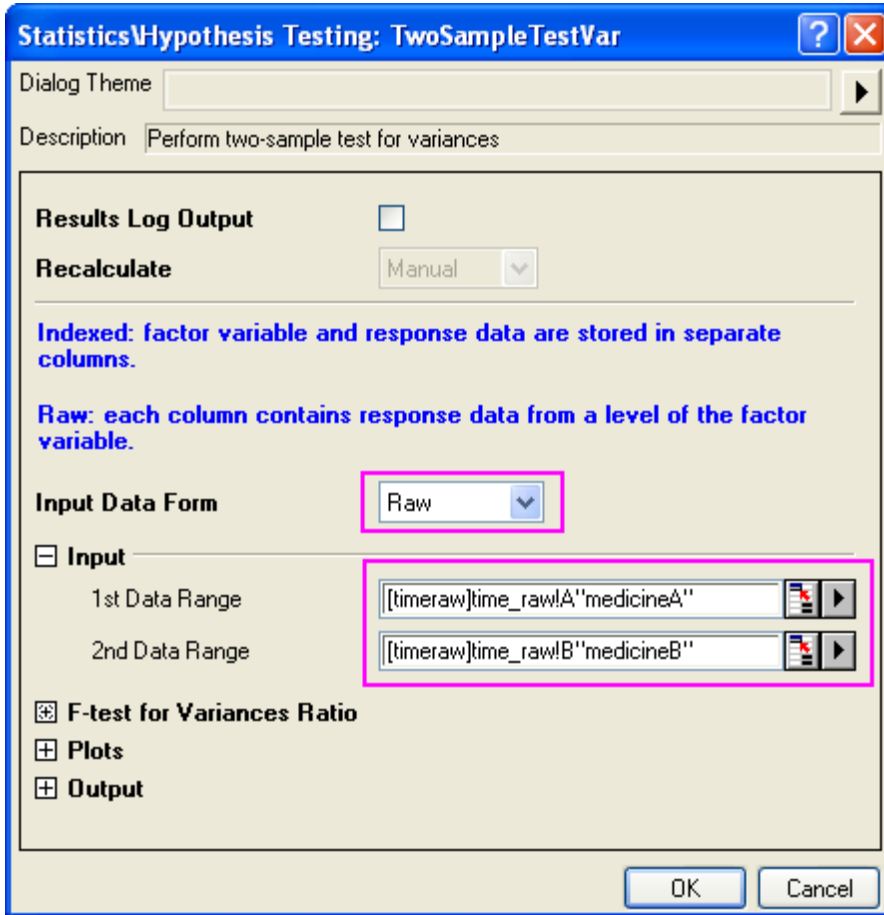

4. Accept other settings as default and click the **OK** button to generate results.

**Descriptive Statistics**

	N	Mean	SD	Variance
"medicineA"	10	2.35	1.97611	3.905
"medicineB"	10	0.75	1.78901	3.20056

**F Statistics**

	F	Numer. DF	Denom. DF	Prob > F
	1.2201	9	9	0.77181

Null Hypothesis: Variance1/Variance2 = 1  
 Alternative Hypothesis: Variance1/Variance2 <> 1  
 At the 0.05 level, the two population variances are NOT significantly different.

According to result ,  $P\_vaule=0.77181 > 0.05$ ,therefore ,it fail to reject null hypothesis, so two population variances are not signification difference.

## 5.4 ANOVA

### 5.4.1 ANOVA

- [One Way ANOVA](#)
- [One-Way Repeated Measures ANOVA](#)
- [Two Way ANOVA](#)
- [Two Way Repeated Measures ANOVA](#)
- [Two-Way Mixed-Design ANOVA](#)
- [Three-Way ANOVA](#)

### 5.4.2 One Way ANOVA

#### 5.4.2.1 [Summary](#)

Statistics has two modes of data input; indexed and raw. When a statistical analysis is performed, there is usually no need to use an entire data set; Origin provides several methods of data selection. For example, the interactive **Regional Data Selector** button can be used in the graphical selection of data, or the **Column Browser** dialog can be employed to make the selection.

In this tutorial, you will learn how to use the two methods of data input so that the Analysis of Variance (ANOVA) statistical test can be performed.

ANOVA is a parametric method for means comparison of several groups, and it is also an extension of two independent sample t-tests. ANOVA is more powerful than multiple t-tests since it controls the chance to commit type I error better when the number of groups is relatively large. For example, when comparing the means among 5 groups using a t-test, ten multiples of the t-test, each with a significance level of 0.05, are performed, resulting in an overall chance to commit type I error of  $1-(1-0.05)^{10}=0.401$ . Under the same circumstances, the chance to commit type I error in ANOVA is 0.05.

ANOVA requires normality and equal variance. If these requirements are not met, non-parametric analysis should be used.

Minimum Origin Version Required: Origin 2016 SR0

#### 5.4.2.2 [What You Will Learn](#)

This tutorial will show you how to:

- Use different input data modes in the statistical analysis dialog
- Do normality tests
- Perform one-way ANOVA

#### 5.4.2.3 [Steps](#)

Origin can perform ANOVA from an indexed data mode, or from a raw data mode.

When an indexed data mode is used, the data needs to be organized in a factor column and a data column.

The screenshot shows a window titled 'Book1 - nitrogen.txt'. The data is organized as follows:

	A(X)	B(Y)
Long Name	plant	nitrogen
Comments	<b>Factor</b>	<b>Data</b>
1	PLANT3	18.15473
2	PLANT3	12.90409
3	PLANT2	18.61197
4	PLANT1	17.7111
5	PLANT4	11.81661
6	PLANT3	11.68327
7	PLANT2	23.43165
8	PLANT2	14.01454

When a raw data mode is used, the data needs to be organized with different levels in different columns.

The screenshot shows a window titled 'Book1 - nitrogen\_raw.txt'. The data is organized as follows:

	A(X)	B(Y)	C(Y)	D(Y)
Long Name	Plant1	Plant2	Plant3	Plant4
Comments	<b>Level1</b>	<b>Level2</b>	<b>Level3</b>	<b>Level4</b>
1	17.7111	18.61197	18.15473	11.81661
2	32.15046	23.43165	12.90409	2.39438
3	17.70871	14.01454	11.68327	1.09914
4	28.07729	12.17685	23.52293	16.00756
5	7.83567	4.86902	16.00594	13.85077
6	2.06008	18.93963	3.04056	9.22245
7	22.81923	29.92086	14.29516	14.86523

#### 5.4.2.3.1 Indexed Data Mode

Nitrogen content, in milligrams, has been recorded for 4 kinds of plants. We are interested to know whether different plants have significantly different nitrogen content. As a result, we will use the index data mode in One-Way ANOVA analysis.

1. Start with a new workbook. From the Menu Bar, click **Data: Import from File: Single ASCII...**, browse to the *Samples\Statistics* folder and double click on **nitrogen.txt**. In the **Import and Export:impASC** dialog box, click the **OK** button.
2. Next, we perform a normality test on each group of data to determine whether it follows a normal distribution. Highlight the first column of the workbook and from the Menu Bar, select **Worksheet: Sort Worksheet: Ascending**.
3. From the Menu Bar, select **Statistics: Descriptive Statistics: Normality Test: Open Dialog**. In the **Normality Test** dialog, in the **Input** tab, expand **Input Data** and **Range 1**. Press the triangle button at the right of **Data Range** and select **B(Y): nitrogen**, then press the triangle button at the right of **Group** and select **A(X): plant**. Click **OK**.

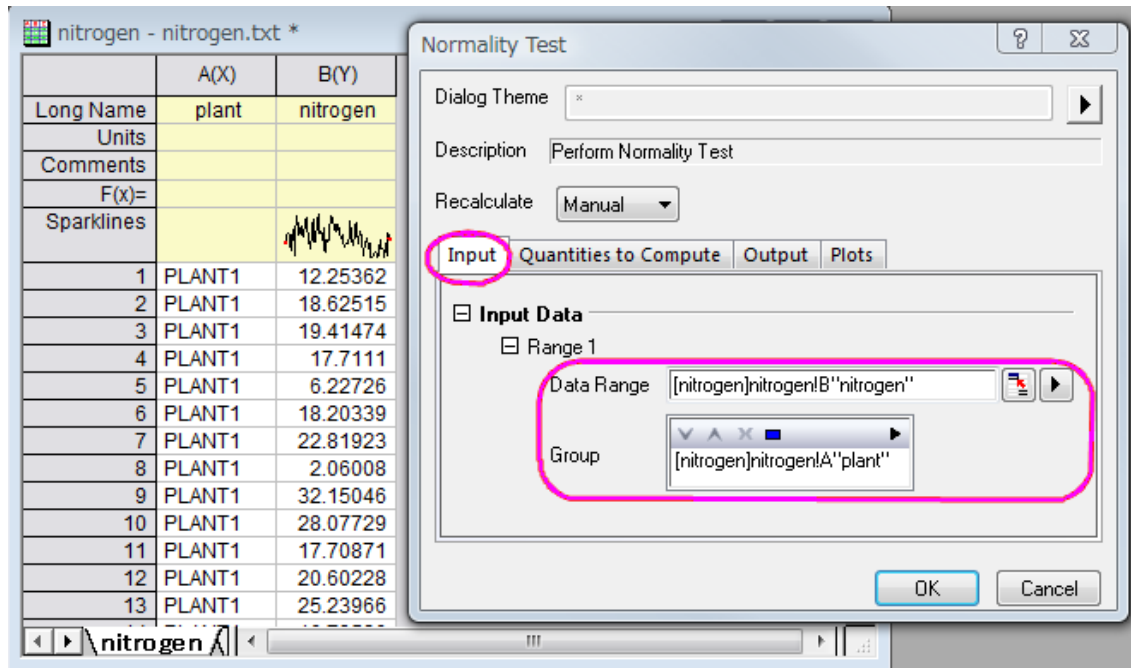

4.

- With the **nitrogen** worksheet active, go to the Menu Bar and open **Statistics: ANOVA: One-Way ANOVA....** In the **ANOVAOneWay** dialog box, in the **Input** tab, set **Input Data** to **Indexed**. Pressing the triangle button at the right of **Factor**, select **A(X): plant** and pressing the triangle button at the right of **Data**, select **B(Y): nitrogen**.

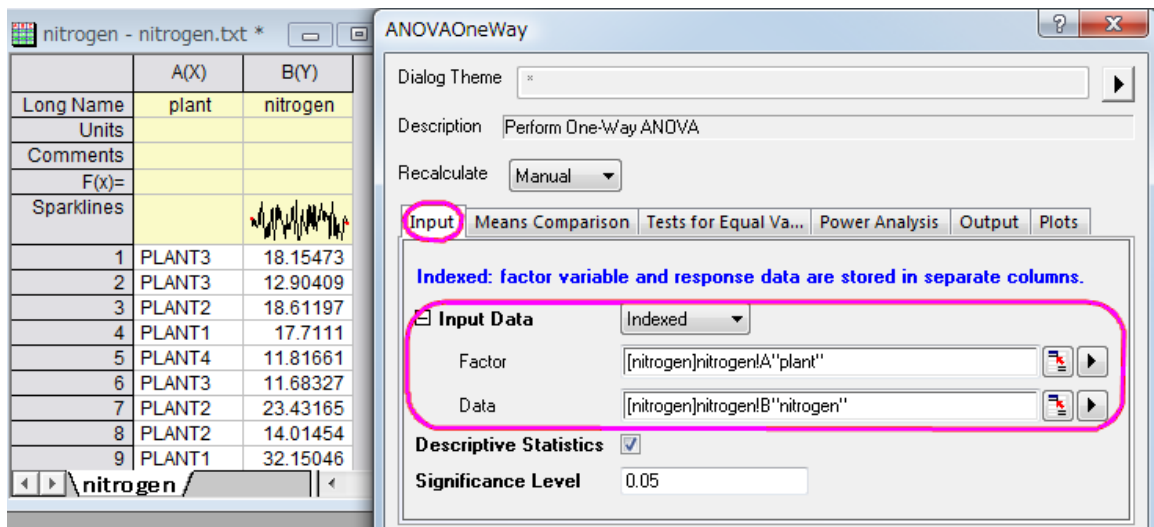

6.

- In the **Means Comparison** tab, check the **Tukey** check box; In the **Tests for Equal Variance** tab, check the **Levene** check box; In **Power Analysis** tab, select **Actual Power** check box; In the **Plots** tab, check the **Means Plot[SE as Error]** and the **Means Comparison Plot** check boxes. Click **OK**.

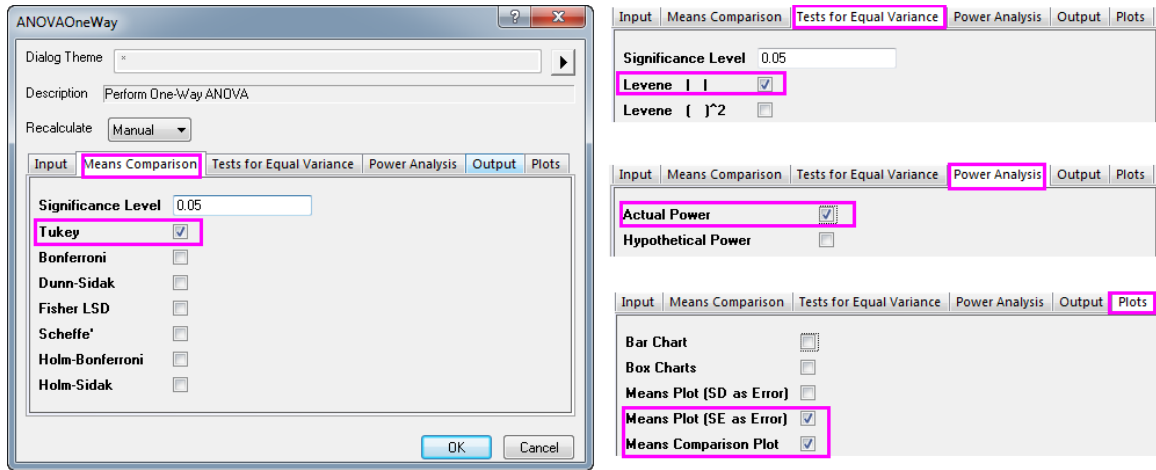

Result Interpretations

- On the ANOVA1Way1 report sheet, you will see a **Homogeneity of Variance Test** node. If results are not visible, click to expand the node. Because the p-value is greater than 0.05, the four groups are considered to have equal variance.

Levene's Test(Absolute Deviations)

	DF	Sum of Squares	Mean Square	F Value	Prob>F
Model	3	18.06843	6.02281	0.34578	0.79229
Error	76	1323.76846	17.41801		

At the 0.05 level, the population variances are not significantly different.

- The ANOVA table (Overall ANOVA) reports a p-value that is smaller than 0.05, hence at least two of the four groups have significantly different means.

Overall ANOVA

	DF	Sum of Squares	Mean Square	F Value	Prob>F
Model	3	1996.36652	665.45551	12.86214	6.99338E-7
Error	76	3932.05317	51.73754		
Total	79	5928.41969			

Null Hypothesis: The means of all levels are equal.

Alternative Hypothesis: The means of one or more levels are different.

At the 0.05 level, the population means are significantly different.

- Expanding the results of "Means Comparisons" reveals further information regarding relationships between groups.

Tukey Test

	MeanDiff	SEM	q Value	Prob	Alpha	Sig	LCL	UCL
PLANT2 PLANT1	2.26308	2.27459	1.40706	0.75274	0.05	0	-3.71181	8.23796
PLANT3 PLANT1	-2.46538	2.27459	1.53284	0.70039	0.05	0	-8.44027	3.5095
PLANT3 PLANT2	-4.72846	2.27459	2.93989	0.16935	0.05	0	-10.70334	1.24643
PLANT4 PLANT1	-10.93833	2.27459	6.80085	4.38499E-5	0.05	1	-16.91322	-4.96345
PLANT4 PLANT2	-13.20141	2.27459	8.20791	8.24355E-7	0.05	1	-19.1763	-7.22653
PLANT4 PLANT3	-8.47295	2.27459	5.26801	0.00207	0.05	1	-14.44784	-2.49807

- Here we see that the mean of PLANT4 differs significantly from the other three groups. Looking at the **Means Plot** and **Means Comparison Plot**, we can see that PLANT4 has the smallest mean and is significantly different from the other three groups.

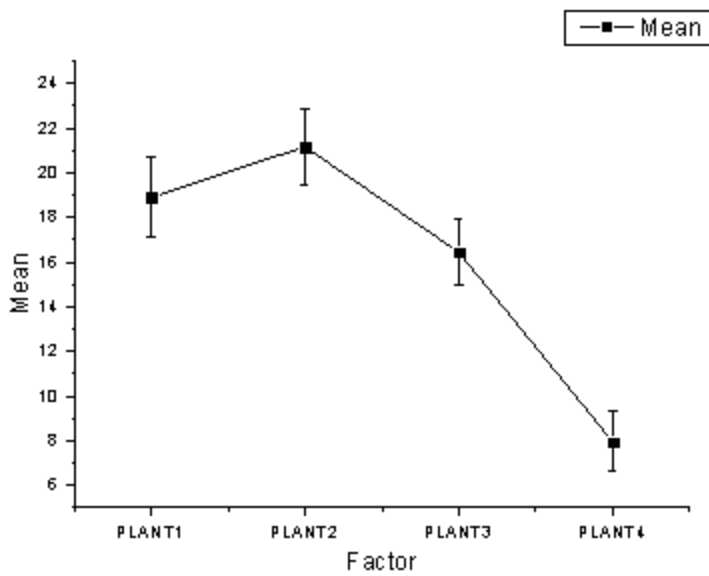

### Means Comparison using Tukey Test

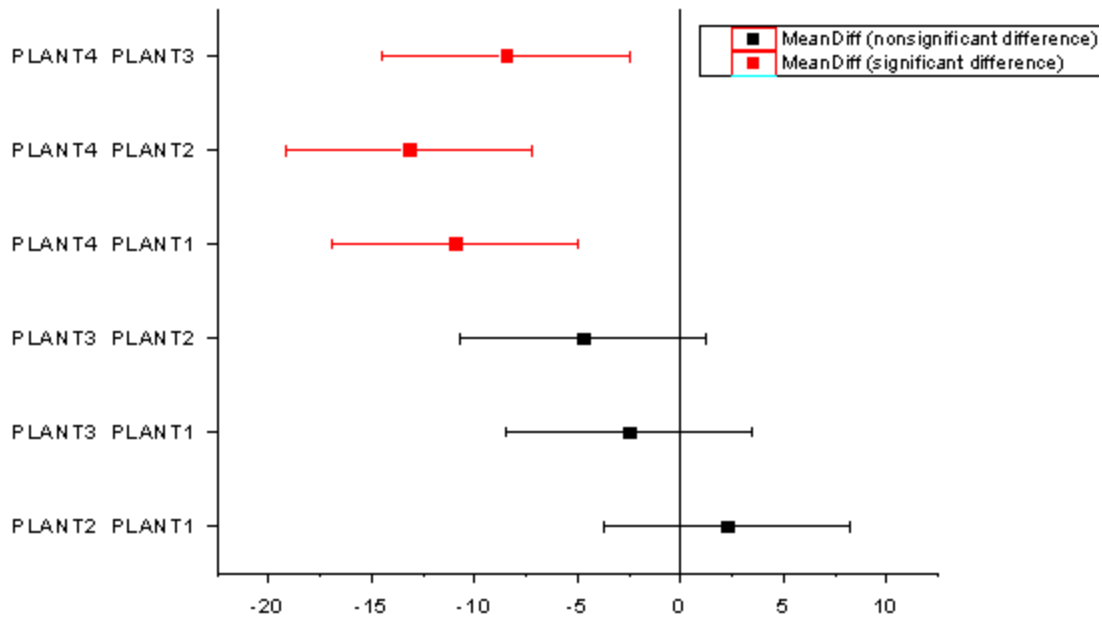

- In the "Powers" table, **Actual Power**=0.99976, that is, the chance of a Type II error occurring is almost equal to zero.

Powers			
	Alpha	Sample Size	Power
Actual Power	0.05	80	0.99976

#### 5.4.2.3.2 Raw Data Mode

1. Start with a new workbook. From the Menu Bar, click **Data: Import from File: Single ASCII...**, and double click on **nitrogen\_raw.txt**. In the **Import and Export:impASC** dialog box, click **OK**.
2. Highlight all columns, and from the Menu Bar, click **Statistics : ANOVA : One-Way ANOVA**. In the **ANOVAOneWay** dialog, in the **Input** tab, set **Input Data** to **Raw**, and click **OK**.
3. Repeat the examination of analysis results and you will see that we reach the same conclusions as we did when using **Indexed data mode**.



	A(X)	B(Y)	C(Y)	D(Y)
Long Name	Plant1	Plant2	Plant3	Plant4
Units				
Comments				
F(x)=				
Sparklines				
1	17.7111	18.61197	18.15473	11.81661
2	32.15046	23.43165	12.90409	2.39438
3	17.70871	14.01454	11.68327	1.09914
4	28.07729	12.17685	23.52293	16.00756
5	7.83567	4.86902	16.00594	13.85077
6	2.06008	18.93963	3.04056	9.22245
7	22.81923	29.92086	14.29516	14.86523
8	6.22726	22.32084	26.2977	8.1437
9	12.25362	20.46398	27.19654	0.89452



If the **Level Name** is set to **Auto**, it will follow the column long name of the selected data.

### 5.4.3 One-Way Repeated Measures ANOVA

#### 5.4.3.1 Summary

One-way repeated measures ANOVA is similar to one-way ANOVA, but deals with a dependent variable subjected to repeated measurements. In this situation, the independence assumption of general one-way ANOVA is not tenable, since there is probably a correlation between levels of the repeated factor.

Similar to one-way ANOVA, one-way repeated measures ANOVA can be employed to test whether the means are equal or not. These means include the mean of different measurements and the mean of different subjects. The results will be shown in the table named *Test of Within-Subjects Effect* and *Test of Between-Subjects Effect* respectively. Note that the repeated measures ANOVA in Origin requires balanced sample data, that is, equal sample size at each level.

Minimum Origin Version Required: Origin 8.6 Pro SR0

#### 5.4.3.2 What you will learn

This tutorial will show you how to:

- Input indexed data into the statistical analysis dialog.
- Perform One-way Repeated Measures ANOVA.
- Interpret results of a One-way Repeated Measures ANOVA analysis.

#### 5.4.3.3 Steps

Origin can perform **One-Way Repeated Measures ANOVA** in both indexed and raw data mode. For **One-Way Repeated Measures ANOVA**, if the indexed mode is used, data should be organized into three columns: **Factor**, **data**, and **Subject**. When the Raw data mode is used, the different levels should be in different columns.

##### 5.4.3.3.1 Indexed data mode

The data contains measurements for 3 different doses on 20 subjects, and we are interested in whether different doses on subjects have different effects. To test this, we will perform a One-Way Repeated Measures ANOVA using the indexed data mode.

1. Click the **Import Single ASCII** button  to import the file **One Way\_RM\_ANOVA\_indexed.dat** in the `\Samples\Statistics\ANOVA` folder.
2. Select **Statistics: ANOVA: One-Way Repeated Measures ANOVA** to open the dialog. In the **Input** tab of this dialog, select **Indexed** from the **Input Data** drop-down list and set column **B(dose)**, **C(Data)**, and **A(Subject)** as the **Factor**, **Data**, and **Subject** respectively.

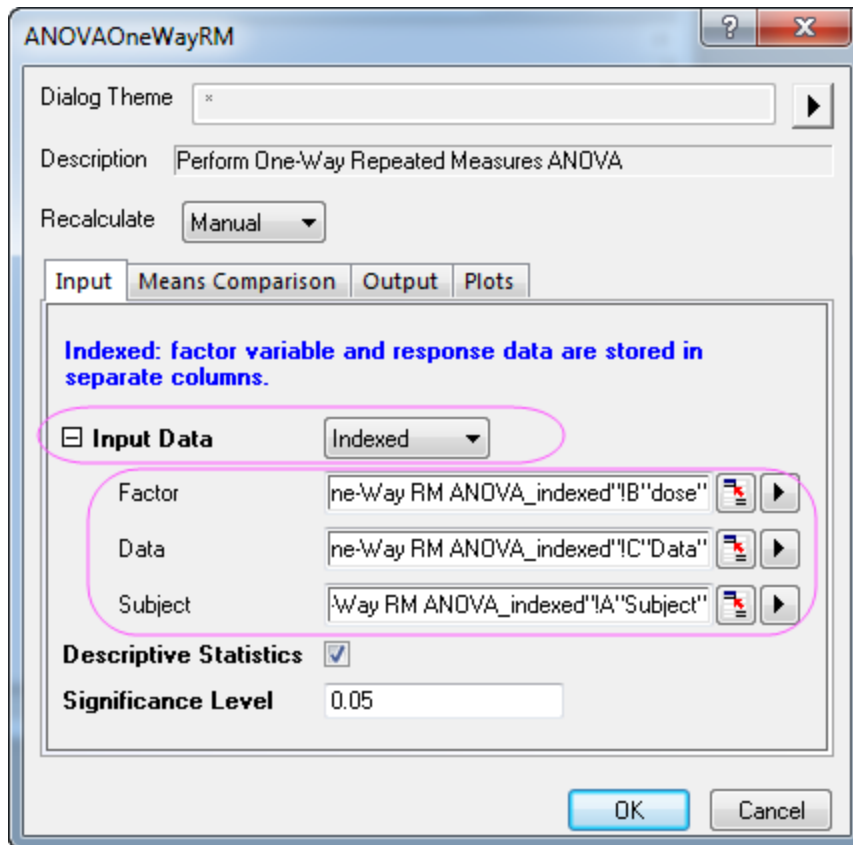

3. Go to **Means Comparison** tab, select the check box after **Bonferroni** to enable the Bonferroni test.

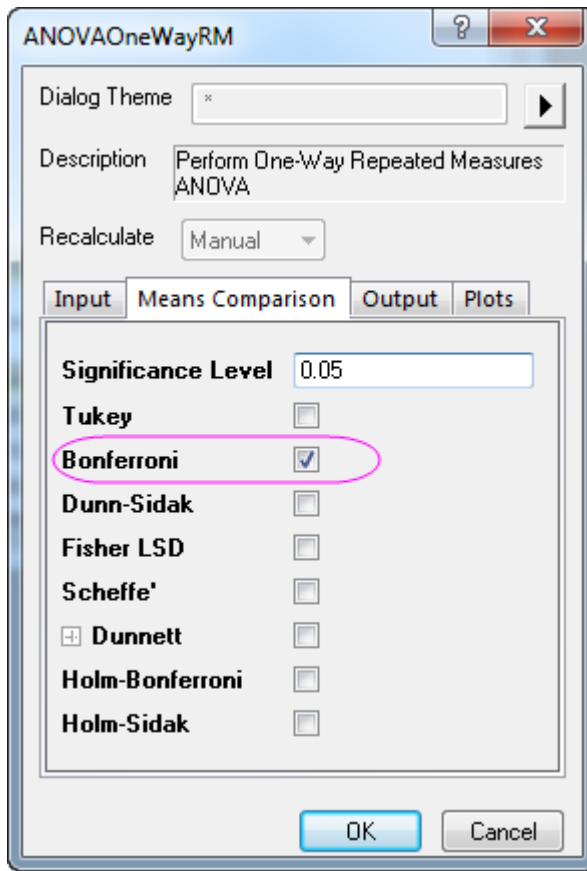

4. Select the **Means Plot(SE as Error)** and **Means comparison Plot** check boxes in the **Plots** tab.

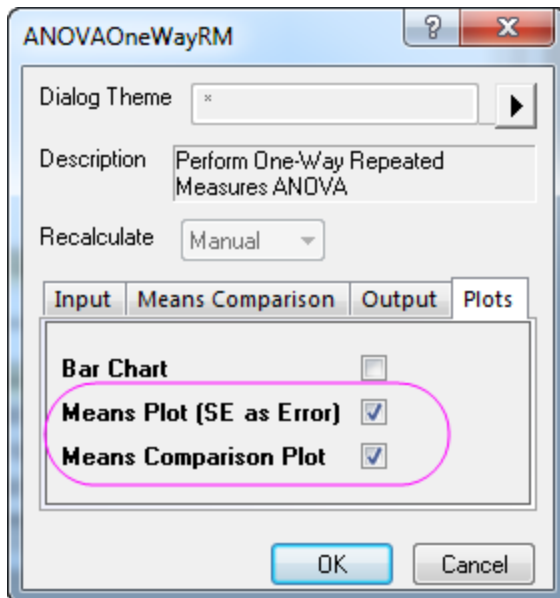

5. Click the **OK** button to perform the analysis.

#### 5.4.3.3.2 Results Interpretation

Go to the worksheet **ANOVAOneWayRM1**, where the analysis results are listed.

You can refer to this [help file](#) for details of interpreting results of repeated measures ANOVA.

Multivariate Tests

		Value	F	Num df	DF	Prob>F
dose	Pillai's Trace	0.17777	3.02689	2	28	0.06455
	Wilks' Lambda	0.82223	3.02689	2	28	0.06455
	Hotelling's Trace	0.21621	3.02689	2	28	0.06455
	Roy's Largest Root	0.21621	3.02689	2	28	0.06455

Origin prints out MANOVA automatically alongside repeated measures to detect repeated-measures effects. Note that the four different methods (Pillai's trace, Wilks' lambda, Hotelling's trace, and Roy's largest root) generate identical F statistics and probabilities, **P=0.06455**, so the means under three levels condition are not statistically different. Compare with the following report in repeated measures ANOVA, we can see that the conclusion is conservative.

Mauchly's Test of Sphericity

	Mauchly's W	Approx. Chi-Square	DF	Prob>ChiSq	Greenhouse-Geisser Epsilon	Huynh-Feldt Epsilon	Lower-bound Epsilon
dose	0.94397	1.61448	2	0.44609	0.94694	1	0.5

This table shows the results of the Mauchly's Test of Sphericity. From the test results we can see that Sphericity holds. We are interested in the value of **Prob > ChiSq**, which is the significance level of the Mauchly's Test, we can see from this example that the significance level (0.44609) is greater than 0.05. Therefore, the assumption of Sphericity has not been violated.

Tests of Within-Subjects Effects

		Sum of Squares	DF	Mean Square	F	Prob>F
dose	Sphericity Assumed	0.4473	2	0.22365	3.43018	0.03908
	Greenhouse-Geisser	0.4473	1.89389	0.23618	3.43018	0.04187
	Huynh-Feldt	0.4473	2	0.22365	3.43018	0.03908
	Lower-bound	0.4473	1	0.4473	3.43018	0.0422
Error(dose)	Sphericity Assumed	3.78162	58	0.0652		
	Greenhouse-Geisser	3.78162	54.92273	0.06885		
	Huynh-Feldt	3.78162	58	0.0652		
	Lower-bound	3.78162	29	0.1304		

P < 0.05

From this table we are able to get the F value for the factor in addition to its associated significance level and effect size. As our data follow the assumption of Sphericity, we can conclude that when using an ANOVA with repeated measures with **Sphericity Assumed**, the means under three levels condition are statistically different ( $P = 0.03908 < 0.05$ ). In other words, dose is a significant factor.

Descriptive Statistics

	Mean	Std. Error	95.00% LCL	95.00% UCL
10	1.1312	0.06875	0.99059	1.27181
20	0.95877	0.05324	0.84988	1.06765
30	1.03693	0.06119	0.91178	1.16207

Pairwise Comparison

Bonferroni Test

	Index	Mean Difference	Std. Error	DF	t value	Prob> t	Alpha	Sig Flag	95.00% LCL	95.00% UCL
10 20	0	0.17243	0.06593	58	2.61543	0.03402	0.05	1	0.00989	0.33498
	1	0.09427	0.06593	58	1.42989	0.47434	0.05	0	-0.06827	0.25681
	2	-0.07816	0.06593	58	1.18554	0.72192	0.05	0	-0.2407	0.08438

The results presented in the previous table showed that there is an overall significant difference among the means but we do not know where those differences came from. This table shows the results of the Bonferroni

test, which allows us to learn which specific means are different. In this case, the means of dose=10 and dose=20 have a significant difference ( $P = 0.03402 < 0.05$  and **Sig Flag = 1**).

From the two plots below, we can also easily come to the same conclusion.

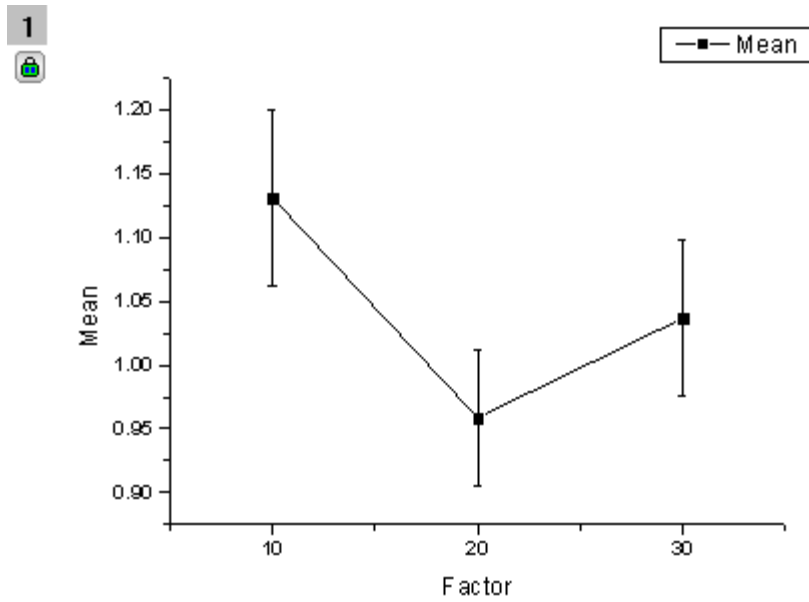

Means Comparison using Bonferroni Test

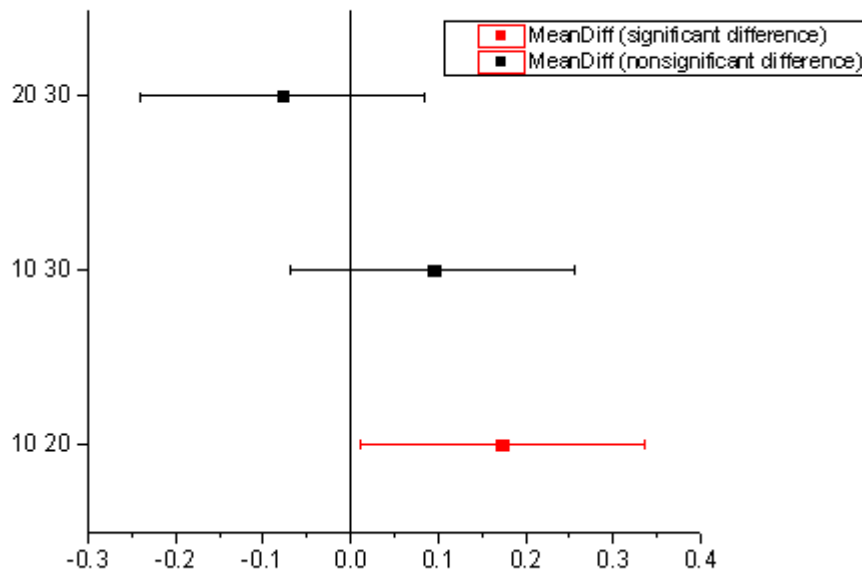

### 5.4.4 Two Way ANOVA

#### 5.4.4.1 Summary

In some cases, we want to examine the relationship between two factors (categorical variables) and a continuous outcome variable. The effects on the outcome of the change in one factor may depend on the level of the other factor, so we need to consider the interactions between two factors. Two way ANOVA is an appropriate method to analyze the main effects of and interactions between two factors.

Minimum Origin Version Required: Origin 2016 SR0

#### 5.4.4.2 What you will learn

This tutorial will show you how to:

- Perform Two-way ANOVA
- Interpret results from Two-Way ANOVA
- Make the Interaction Plot

#### 5.4.4.3 Steps

Researchers are interested in the effects of sex and dietary group on systolic blood pressure (SBP) The "dietary group" factor includes three groups: strict vegetarians (SV) who eat no animal products of any kind; lacto vegetarians (LV) who eat dairy products but no other animal products; and "normal" (NOR) subjects who eat a standard American diet. Sex and dietary group may be independent or they may interact with each other. One approach to solve this problem is to construct a two-way ANOVA model predicting mean SBP level.

##### 5.4.4.3.1 Indexed data mode

###### Perform Two Way ANOVA

1. Start with a new workbook and import the file `\Samples\Statistics\SBP_Index.dat`.
2. Open the **Two-Way ANOVA** dialog by choosing the menu item **Statistics: ANOVA: Two-Way ANOVA**, then in the **Input** tab, set the **Input Data** mode as **Indexed**.
3. Also in the **Input** tab, select column A,B and C for **Factor A,Factor B** and **Data**, respectively. Check the **Interactions** box.

	A(X)	B(Y)	C(Y)
Long Name	Sex	Dietary	SBP
Units			
Comments			
F(x)=			
Sparklines			
26	Male	SV	114.21317
27	Male	SV	152.33456
28	Male	SV	120.50046
29	Male	SV	111.34663
30	Male	SV	120.91393
31	Female	SV	124.13537
32	Female	SV	109.56613
33	Female	SV	118.38661
34	Female	SV	98.85256

**ANOVATwoWay** dialog box settings:

- Dialog Theme: \*
- Description: Perform Two-Way ANOVA
- Recalculate: Manual
- Input tab selected
- Indexed: factor variable and response data are stored in separate columns.
- Input Data: Indexed
- Factor A: [SBPIndex]SBP\_Index!A"Sex"
- Factor B: [SBPIndex]SBP\_Index!B"Dietary"
- Data: [SBPIndex]SBP\_Index!C"SBP"
- Interactions:
- Significance Level: 0.05

- In the **Descriptive statistics** tab, check all boxes.
- In the **Means Comparison** tab, set **Significance Level** to 0.05, and check the box beside **Tukey** to select this test as the means comparison method.

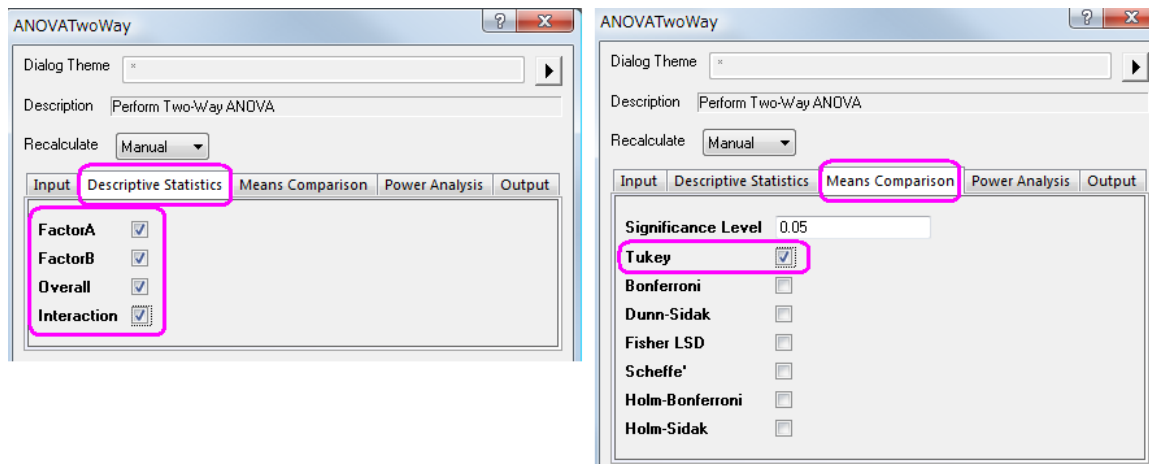

- Click the **OK** button to perform Two-Way ANOVA.

#### Interpreting Results

Overall ANOVA

	DF	Sum of Squares	Mean Square	F Value	P Value
Sex	1	1594.39725	1594.39725	17.64529	4.05551E-5
Dietary	2	1137.86004	568.93002	6.29638	0.00224
Interaction	2	245.48621	122.7431	1.3584	0.2595
Model	5	2794.86329	558.97266	6.18618	2.40633E-5
Error	194	17529.50212	90.35826	--	--
Corrected Total	199	20324.36541	--	--	--

- At the 0.05 level, the population means of **Sex** are **significantly** different.
- At the 0.05 level, the population means of **Dietary** are **significantly** different.
- At the 0.05 level, the interaction between **Sex** and **Dietary** is **not significant**.

From the "Overall ANOVA" table in the Two-Way ANOVA result sheet, we can see that **Dietary** and **Sex** are both significant factors, but the interaction between them is not significant. So we can say that the main effects of both **Dietary** groups and **Sex** are significant, yet the effect on the outcome of the change in **Dietary** doesn't depend on the level of **Sex**.

#### The Interaction Plot

To further detect interaction, we can make an "Interaction Plot" using the following steps.

- Right-click on the title of the "Interaction" table and select **Create Copy as a new sheet** from the context menu.



Interaction				ce	Missing	NonMissing
		N	User Comments...			
Male	SV	30	Copy Table	092	0	30
	LV	25	Create Copy As New Sheet	771	0	25
	Nor	45	Create Transposed Copy As New Sheet	808	0	45
Female	SV	25	Expand	851	0	25
	LV	30	Collapse	319	0	30
	Nor	45		633	0	45

- Go to the new sheet and right-click on column B and select **Set As Categorical** from the fly-out menu.
- Select the first three cells in column D and then press the **Ctrl** key and select the other cells in column D.

A(X1)	B(X2)	C(Y2)	D(Y2)	E(yEr±)	F(yEr±)	G(Y2)	H(Y2)	I(Y2)
		N	Mean	SD	SEM	Variance	Missing	NonMissin
Male	SV	30	117.24744	10.63207	1.94114	113.04092	0	30
Male	LV	25	119.01081	8.49339	1.69868	72.13771	0	25
Male	Nor	45	120.76882	8.82486	1.31553	77.87808	0	45
Female	SV	25	110.93646	10.37779	2.07556	107.69851	0	25
Female	LV	30	110.85397	9.57768	1.74864	91.7319	0	30
Female	Nor	45	117.78078	9.35218	1.39414	87.4633	0	45

- Click the  button on the **2D Graphs** toolbar to create a graph.
- Right-click on the graph legend and select **Properties** from the context menu. In the **Object Properties** dialog box, edit the text as shown below. Click the **OK** button to close the dialog box and update the legend. We now have an **Interaction Plot** which can show the interaction between two factors.

\1(1) Male

\1(2) Female

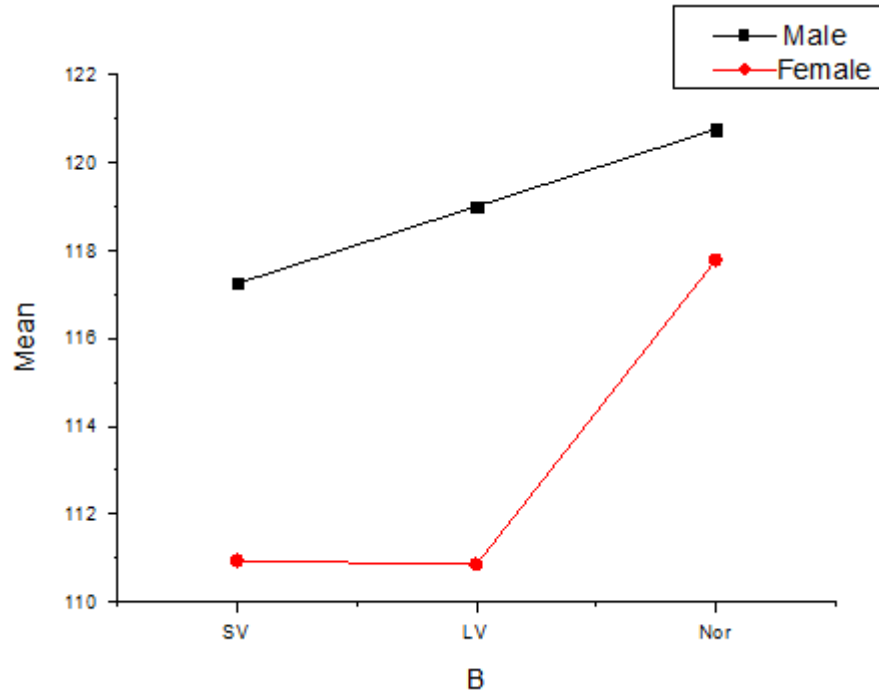

The data plots in the chart above suggest only a weak interaction between **Sex** and **Dietary**, so we should recalculate the effects of the two factors without interaction.

**Recalculate**

1. Click on the green lock in the **ANOVA2Way1** result sheet, and select **Change Parameters** to open the dialog again.

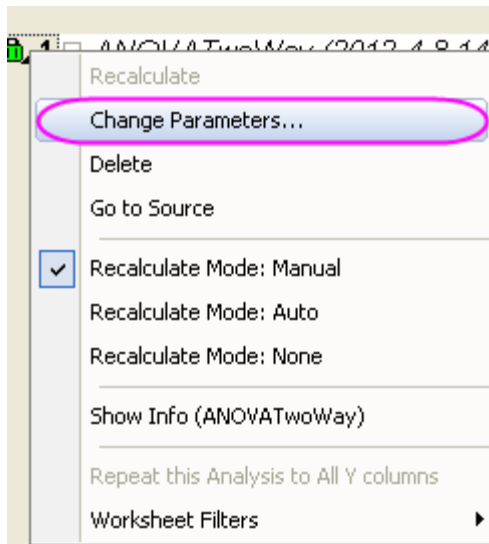

2. In the **Input** tab in the open dialog, clear the **interactions** box and click the **OK** button.

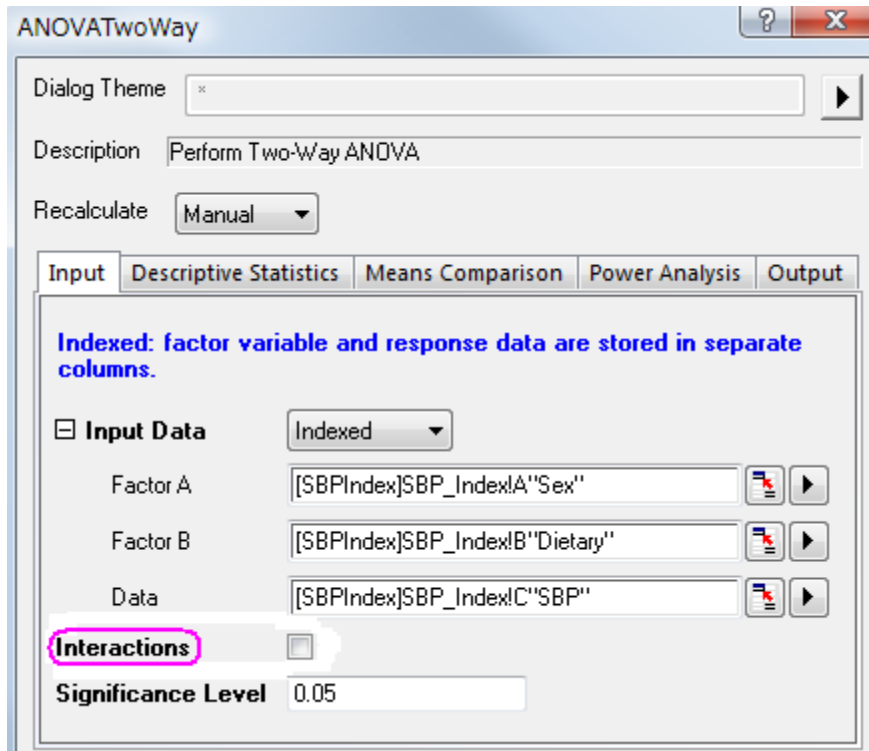

We can see that the **Dietary** and **Sex** are significant factors from the "Overall ANOVA" table. The mean of *Nor* is significantly greater than that of *LV* and *SV* for factor **Dietary**. The mean of Male is significantly greater than that of Female, from the "Dietary" table.

Overall ANOVA

	DF	Sum of Squares	Mean Square	F Value	P Value
Sex	1	1405.79986	1405.79986	15.50138	1.14502E-4
Dietary	2	1154.79872	577.39936	6.36683	0.00209
Model	3	2549.37708	849.79236	9.37043	8.11226E-6
Error	196	17774.98833	90.68872	--	--
Corrected Total	199	20324.36541	--	--	--

At the 0.05 level, the population means of **Sex** are **significantly** different.  
 At the 0.05 level, the population means of **Dietary** are **significantly** different.

Tukey Test

Sex

	MeanDiff	SEM	q Value	Prob	Alpha	Sig	LCL	UCL
Female Male	-5.28125	1.34676	5.54574	1.21684E-4	0.05	1	-7.93726	-2.62524

Dietary

	MeanDiff	SEM	q Value	Prob	Alpha	Sig	LCL	UCL
LV SV	0.18281	1.81598	0.14237	0.99443	0.05	0	-4.1059	4.47152
Nor SV	4.89599	1.62989	4.24812	0.00843	0.05	1	1.04675	8.74522
Nor LV	4.71318	1.62989	4.0895	0.01182	0.05	1	0.86394	8.56241

Sig equals 1 indicates that the difference of the means is significant at the 0.05 level.  
 Sig equals 0 indicates that the difference of the means is not significant at the 0.05 level.

### 5.4.4.3.2 Raw Data Mode

1. Start with a new workbook and import the file `\Samples\Statistics\SBP_Raw.dat`
2. Highlight all columns and select menu item **Statistics : ANOVA : Two-Way ANOVA** to bring up the **ANOVA TwoWay** dialog box. In the **Input** tab, choose **Raw** as the **Input Data** mode.
3. Also in the **Input** tab, set **Number of levels of Factor A** as 2 and type **Sex ,Male** and **Female** for **Name,Level1 Name** and **Level2 Name** in **Factor A** branch ,respectively.
4. Also in the **Input** tab, set **Number of levels of Factor B** as 3, and type **Dietary Group ,SV ,LV** and **Nor** for **Name,Level1 Name, Level2 Name** and **Level3 Name** in **Factor A** branch, respectively.

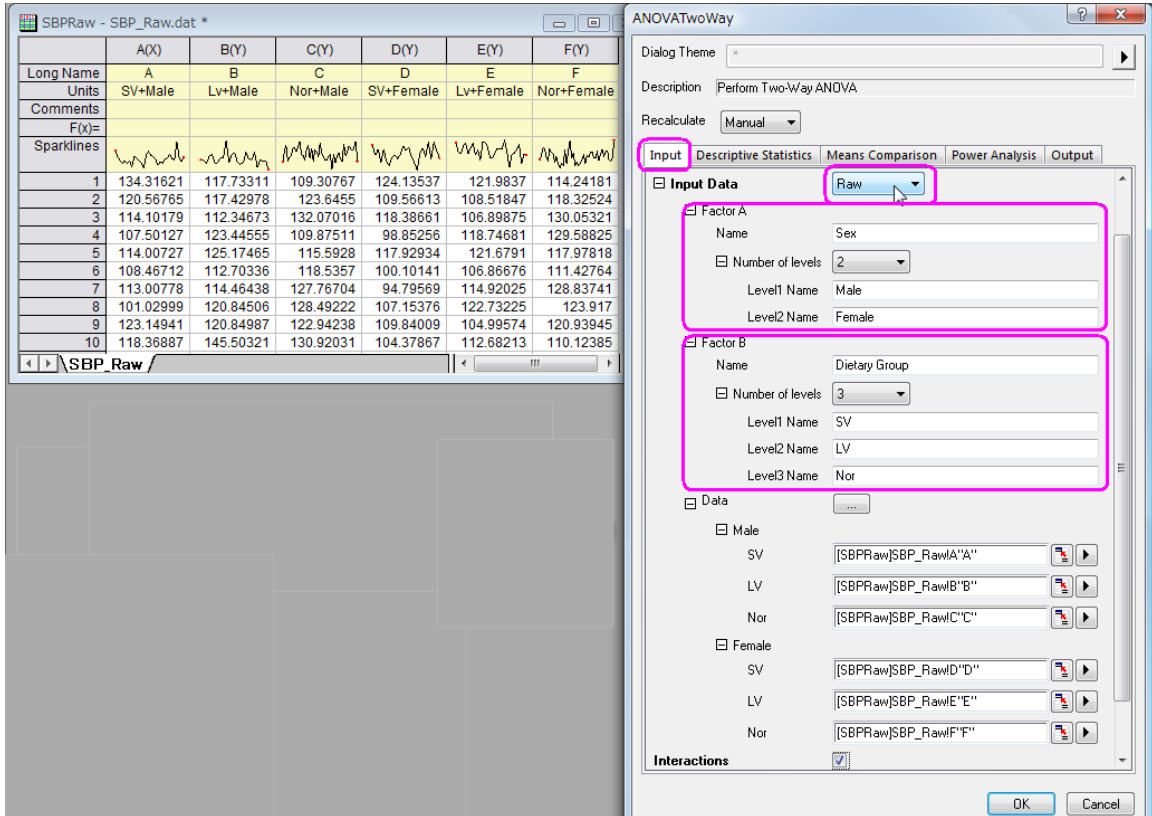

5. In the **Means Comparison** tab, set **Significance Level** to 0.05, and check the box beside **Tukey** to use it as the means comparison method.
6. Click the **OK** button to perform Two-Way ANOVA.

## 5.4.5 Two Way Repeated Measures ANOVA

### 5.4.5.1 Summary

For Two-Way Repeated Measures ANOVA, "Two-way" means that there are two factors in the experiment, for example, different treatments and different conditions. "Repeated-measures" means that the same subject received more than one treatment and/or more than one condition. Similar to two-way ANOVA, two-way repeated measures ANOVA can be employed to test for significant differences between the factor level means within a factor and for interactions between factors. Using a standard ANOVA in this case is not appropriate because it fails to model the correlation between the repeated measures, and the data violates the ANOVA

assumption of independence. Two-Way Repeated Measures ANOVA designs can be two repeated measures factors, or one repeated measures factor and one non-repeated factor. If any repeated factor is present, then the repeated measures ANOVA should be used.

In the following example, the two factors are the repeated measures factors.

Minimum Origin Version Required: Origin 8.6 Pro SR0

#### 5.4.5.2 What you will learn

This tutorial will show you how to:

- Input raw data in the statistical analysis dialog.
- Perform Two-Way Repeated Measures ANOVA.
- Interpret results of a Two-Way Repeated Measures ANOVA

#### 5.4.5.3 Steps

Origin can perform **Two Way Repeated Measures ANOVA** in both indexed and raw data modes. For Two-Way repeated measures ANOVA, if the indexed mode is used, data should be organized into four columns: Factor A, Factor B, Data, and Subject. When the Raw data mode is used, the different factors and levels should be in different columns.

In this example, we are interested in whether different drugs and doses have different effects on subject. We will perform the **Two-Way Repeated Measures ANOVA** to determine whether the drug type and dosage have significant effect on a subject. If there is significant difference, we will perform **pairwise comparison** to determine of which level the effects are different.

##### 5.4.5.3.1 Raw data mode

1. Click the **Import Single ASCII** button  to import the file **Two-Way\_RM\_ANOVA\_raw.dat** in the *Samples\Statistics\ANOVA* folder.
2. Select **Statistics: ANOVA: Two-Way Repeated Measures ANOVA** to open the dialog.
3. In **Input** tab, select **Raw** from the **Input Data** drop-down list.
4. In this example, there are two factors. Set 3 and 2 for Number of Levels in **Factor A** and **Factor B** drop-down list to specify levels of the factor. Set **Name** to **drug** and **dose** respectively.

**Notes:** **Factor A** and **Factor B** are set as repeated measures factor by default (The **Repeated** check box under **Factor** is checked ). If one factor is a non-repeated measures factor, just uncheck the **Repeated** check box.

5. Now under the **Data** branch, there are three subgroups. In the **drug Level1** subgroup, select column **d1d1** as the **dose Level1** input data range.
6. Similarly, select **d1d2**, **d2d1**, **d2d2**, **d3d1**, and **d3d2** for the next 5 input data range.

7. Check the **Interactions** check box to calculate interaction effects.

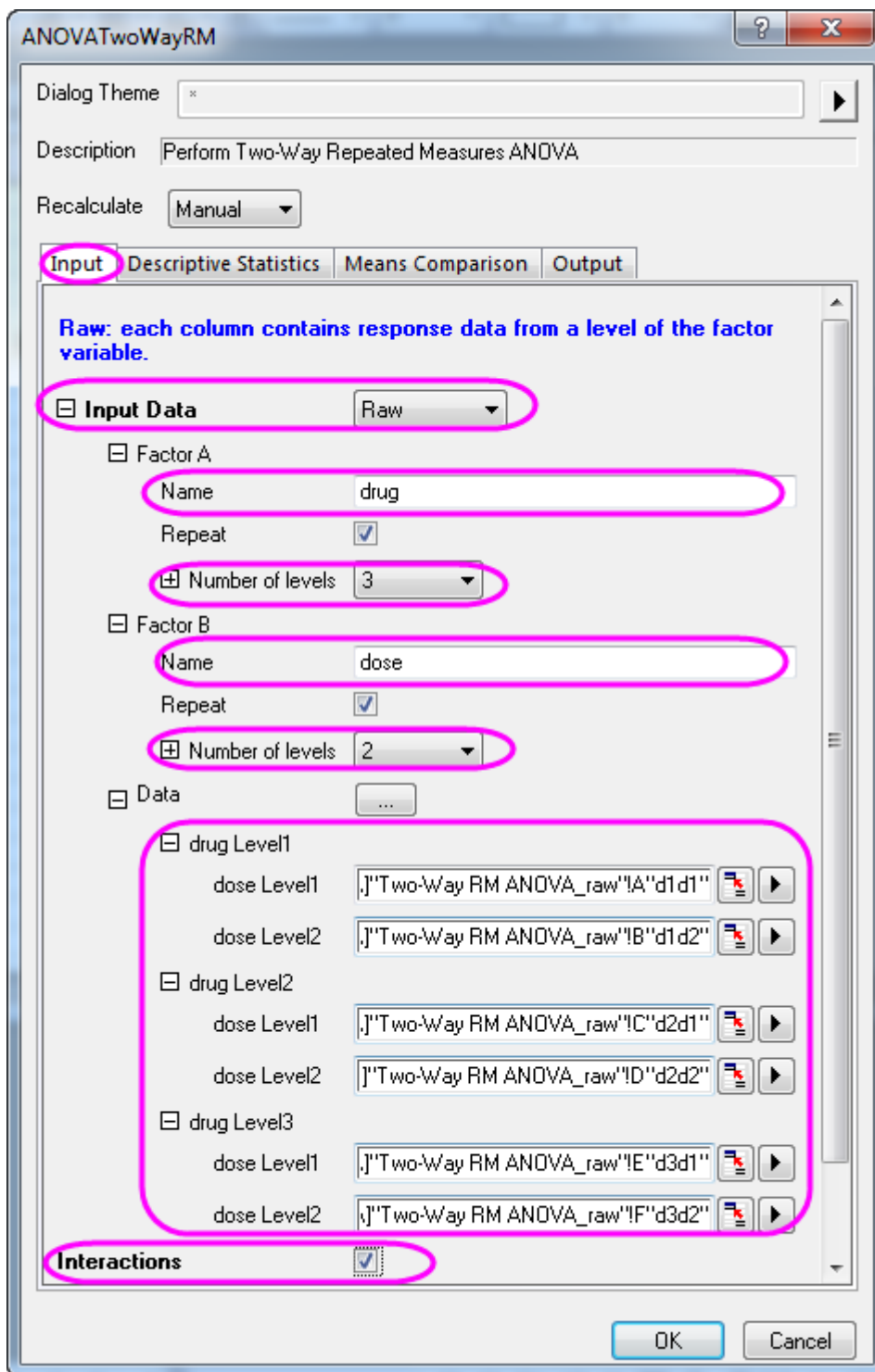

- In the **Descriptive Statistics** tab, select all check boxes to compute the mean, standard error, and 95% confidence interval of all the levels of the factors as well as interactions.

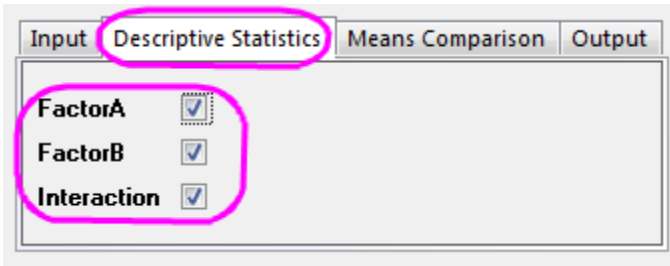

- In the **Means Comparison** tab, select the **Bonferroni** check box to enable the Bonferroni test.

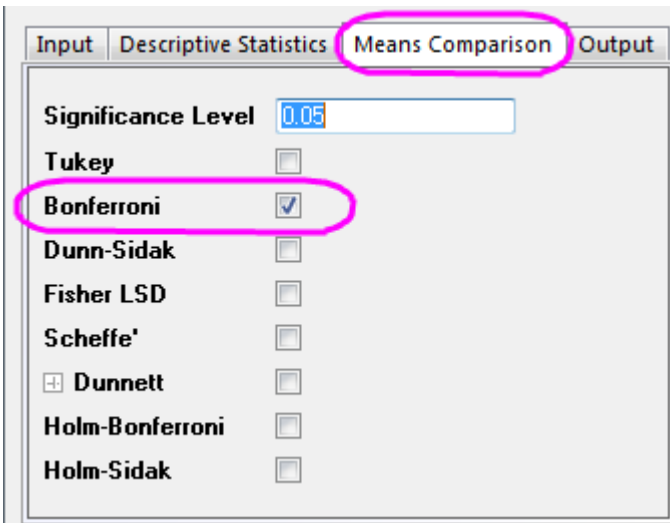

- Click the **OK** button to perform the analysis.

### 5.4.5.3.2 Results Interpretation

Go to the worksheet **ANOVATwoWayRM1**, where the analysis results are listed.

You can refer to this [help file](#) for details of interpreting results of repeated measures ANOVA.

Multivariate Tests

		Value	F	Num df	DF	Prob>F
drug	Pillai's Trace	0.133	1.99423	2	26	0.1564
	Wilks' Lambda	0.867	1.99423	2	26	0.1564
	Hotelling's Trace	0.1534	1.99423	2	26	0.1564
	Roy's Largest Root	0.1534	1.99423	2	26	0.1564
dose	Pillai's Trace	0.19986	6.74428	1	27	0.01504
	Wilks' Lambda	0.80014	6.74428	1	27	0.01504
	Hotelling's Trace	0.24979	6.74428	1	27	0.01504
	Roy's Largest Root	0.24979	6.74428	1	27	0.01504
drug * dose	Pillai's Trace	0.27164	4.8482	2	26	0.01624
	Wilks' Lambda	0.72836	4.8482	2	26	0.01624
	Hotelling's Trace	0.37294	4.8482	2	26	0.01624
	Roy's Largest Root	0.37294	4.8482	2	26	0.01624

Origin uses a multivariate analysis to detect repeated-measures effects. In this example, four different methods (Pillai's trace, Wilks' lambda, Hotelling's trace, and Roy's largest root) generate identical F statistics and probabilities. For **drugs**, P\_value=0.1564, so we can conclude that the effect of **drugs** did not reach conventional levels of statistical significance. Similarly, we can also conclude that **dose** and **drugs\*dose** are significant.

Mauchly's Test of Sphericity

	Mauchly's W	Approx. Chi-Square	DF	Prob>ChiSq	Greenhouse-Geisser Epsilon	Huynh-Feldt Epsilon	Lower-bound Epsilon
drug	0.84441	4.39712	2	0.11096	0.86536	0.9193	0.5
dose	0	0	0	0	1	1	1
drug * dose	0.47007	19.62694	2	5.47097E-5	0.65362	0.6734	0.5

Warning: No Sphericity test performed due to insufficient degrees of freedom.

This table shows the results of Mauchly's Test of Sphericity and evaluation of epsilon. From the column **Prob>ChiSq**, we can learn that the significance level of **drugs** is greater than 0.05 (P\_value=0.11096), and the value of **drugs\*dose** is smaller than 0.05. For **drugs\*dose**, the assumption of sphericity has been violated. Note that **Greenhouse-Geisser Epsilon**=0.65362, which is smaller than 0.75, so we will proceed with the test by using **Greenhouse-Geisser** correction.

Tests of Within-Subjects Effects

		Sum of Squares	DF	Mean Square	F	Prob>F
drug	Sphericity Assumed	0.06038	2	0.03019	2.88316	0.06461
	Greenhouse-Geisser	0.06038	1.73071	0.03489	2.88316	0.07313
	Huynh-Feldt	0.06038	1.8386	0.03284	2.88316	0.0696
	Lower-bound	0.06038	1	0.06038	2.88316	0.10101
Error(drug)	Sphericity Assumed	0.56546	54	0.01047		
	Greenhouse-Geisser	0.56546	46.72928	0.0121		
	Huynh-Feldt	0.56546	49.64207	0.01139		
	Lower-bound	0.56546	27	0.02094		
dose	Sphericity Assumed	0.03982	1	0.03982	6.74428	0.01504
	Greenhouse-Geisser	0.03982	1	0.03982	6.74428	0.01504
	Huynh-Feldt	0.03982	1	0.03982	6.74428	0.01504
	Lower-bound	0.03982	1	0.03982	6.74428	0.01504
Error(dose)	Sphericity Assumed	0.15942	27	0.0059		
	Greenhouse-Geisser	0.15942	27	0.0059		
	Huynh-Feldt	0.15942	27	0.0059		
	Lower-bound	0.15942	27	0.0059		
drug * dose	Sphericity Assumed	0.13506	2	0.06753	4.84575	0.0116
	Greenhouse-Geisser	0.13506	1.30725	0.10332	4.84575	0.02564
	Huynh-Feldt	0.13506	1.3468	0.10028	4.84575	0.0245
Error(drug * dose)	Lower-bound	0.13506	1	0.13506	4.84575	0.03644
	Sphericity Assumed	0.75256	54	0.01394		
	Greenhouse-Geisser	0.75256	35.29564	0.02132		
	Huynh-Feldt	0.75256	36.36348	0.0207		
	Lower-bound	0.75256	27	0.02787		

From this table we are able to find out the F value for the factor, its associated significance level and the effect size. For **drug**, the P\_value is 0.6461 in the **prob>F** column, so **drugs** have no significant effect on subjects, while **dose** have (P\_value=0.01504). For interaction **drugs\*dose**, we can still proceed with the test by using the **Greenhouse-Geisser** correction and conclude that interaction **drugs\*dose** have significant effect (P\_value = 0.02564).



drug

Descriptive Statistics				
	Mean	Std. Error	95.00% LCL	95.00% UCL
drug Level1	1.0833	0.03709	1.00719	1.15941
drug Level2	1.05375	0.03436	0.98324	1.12426
drug Level3	1.0375	0.03383	0.9681	1.1069

Bonferroni Test										
	Index	Mean Difference	Std. Error	DF	t value	Prob> t	Alpha	Sig Flag	95.00% LCL	95.00% UCL
drug Level1 drug Level2	0	0.02955	0.01977	54	1.49462	0.4225	0.05	0	-0.0193	0.0784
drug Level1 drug Level3	1	0.0458	0.01977	54	2.31657	0.07305	0.05	0	-0.00305	0.09465
drug Level2 drug Level3	2	0.01625	0.01977	54	0.82195	1	0.05	0	-0.0326	0.0651

Sig equals 1 indicates that the difference of the means is significant at the 0.05 level.  
 Sig equals 0 indicates that the difference of the means is not significant at the 0.05 level.  
 Sig equals -1 indicates that the difference of the means is not tested.

In general, Bonferroni tests are recommended to determine which specific means differed and determine whether or not the Sphericity assumption is violated. The Bonferroni correction relies on a general probability inequality and therefore isn't dependent on specific ANOVA assumptions. This table presents the results of the Bonferroni test, we can conclude that the means are not significantly different ( $P > 0.05$  and Sig Flag = 0). Of course, we do not need to perform **pairwise comparison** because drugs have no significant effect.

dose

Descriptive Statistics				
	Mean	Std. Error	95.00% LCL	95.00% UCL
dose Level1	1.07358	0.03494	1.00188	1.14527
dose Level2	1.04279	0.03267	0.97575	1.10982

Bonferroni Test										
	Index	Mean Difference	Std. Error	DF	t value	Prob> t	Alpha	Sig Flag	95.00% LCL	95.00% UCL
dose Level1 dose Level2	0	0.03079	0.01614	27	1.90751	0.06714	0.05	0	-0.00233	0.06391

Sig equals 1 indicates that the difference of the means is significant at the 0.05 level.  
 Sig equals 0 indicates that the difference of the means is not significant at the 0.05 level.  
 Sig equals -1 indicates that the difference of the means is not tested.

In this table, we can conclude that means of different dose are not significantly different ( $P\_value = 0.06714$  and Sig Flag = 0).

Bonferroni Test										
dose within drug = drug Level1										
	Index	Mean Difference	Std. Error	DF	t value	Prob> t	Alpha	Sig Flag	95.00% LCL	95.00% UCL
dose Level1 dose Level2	0	0.1063	0.02796	54	3.80208	0.0055	0.05	1	0.02043	0.19218

dose within drug = drug Level2										
	Index	Mean Difference	Std. Error	DF	t value	Prob> t	Alpha	Sig Flag	95.00% LCL	95.00% UCL
dose Level1 dose Level2	0	-0.03036	0.02796	54	1.08577	1	0.05	0	-0.11623	0.05552

dose within drug = drug Level3										
	Index	Mean Difference	Std. Error	DF	t value	Prob> t	Alpha	Sig Flag	95.00% LCL	95.00% UCL
dose Level1 dose Level2	0	0.01643	0.02796	54	0.58759	1	0.05	0	-0.06944	0.1023

drug within dose = dose Level1										
	Index	Mean Difference	Std. Error	DF	t value	Prob> t	Alpha	Sig Flag	95.00% LCL	95.00% UCL
drug Level1 drug Level2	0	0.09788	0.02796	54	3.50078	0.01408	0.05	1	0.01201	0.18375
drug Level1 drug Level3	1	0.09074	0.02796	54	3.24531	0.03025	0.05	1	0.00486	0.17661
drug Level2 drug Level3	2	-0.00714	0.02796	54	0.25548	1	0.05	0	-0.09302	0.07873

drug within dose = dose Level2										
	Index	Mean Difference	Std. Error	DF	t value	Prob> t	Alpha	Sig Flag	95.00% LCL	95.00% UCL
drug Level1 drug Level2	0	-0.03878	0.02796	54	1.38707	1	0.05	0	-0.12465	0.04709
drug Level1 drug Level3	1	8.61787E-4	0.02796	54	0.03082	1	0.05	0	-0.08501	0.08674
drug Level2 drug Level3	2	0.03964	0.02796	54	1.41789	1	0.05	0	-0.04623	0.12552

In this table, we can conclude that dose1 is significantly larger than dose2 within drug1, and drug1 is significantly larger than drug2 and drug3 within dose1.

### 5.4.6 Two-Way Mixed-Design ANOVA

5.4.6.1 Summary

The two-way mixed-design ANOVA is also known as two way split-plot design (SPANOVA). It is ANOVA with one repeated-measures factor and one between-groups factor.

Minimum Origin Version Required: OriginPro 2016 SR0

5.4.6.2 What you will learn

This tutorial will show you how to:

- Perform the two-way mixed design ANOVA.
- Interpret results of the two-way mixed design ANOVA

5.4.6.3 User Story

A researcher wants to know whether a treatment can help people lose weight. 48 participants(24 male) take part in the study. The researcher record their weights every three months during the treatment program.

5.4.6.4 Preparing Analysis Data

To perform two-way mixed-design ANOVA, the data can be arranged as below

	Between-Groups Factor	Repeated Measure Factor		
Subject	Gender	weight1	weight2	weight3
19	male	67.4	68.2	70.2
20	male	88.5	90.1	78.4
21	male	69	70.3	70.6
22	male	75.9	70.5	71.6
23	male	88	80.9	82.6
24	male	100.1	96.2	90.3
25	female	69.3	55.1	60.3
26	female	76.05	47.6	50.05
27	female	108.5	72.3	58.5
28	female	85.5	76.9	55.5
29	female	61.5	68.7	51.5
30	female	76.7	75.9	66.7
31	female	66.2	60.5	60.2

**Notes:** Data can also be arranged in index mode for two-way mixed-design ANOVA. Refer to the sample data, \Samples\Statistics\ANOVA\two-way rm ANOVA1\_indexed.dat, for index mode of data of this tutorial.

5.4.6.5 Performing Two-Way Mixed-Design ANOVA

1. Open a new project or a new workbook. Import the data file \Samples\Statistics\ANOVA\two-way rm ANOVA1\_raw.dat
2. Select **Statistics: ANOVA: Two-Way Repeated Measures ANOVA...** from Origin menu
3. In the opened dialog, choose the **Input** tab,
  - Set **Input Data** as **Raw**

- Expand **Factor A** branch, change the **Name** as **Weight** and set **Number of Levels** = 3. Expand **Factor B** branch, change the **Name** as **Gender** and unselect **Repeat** check box
- In the **Data** branch, set column **C, D** and **E** to be **Weight Level1, Weight Level2** and **Weight Level3**, respectively, and set column **B** as **Gender**
- Select **Interactions** check box

Input	A(X)	B(Y)	C(Y)	D(Y)	E(Y)
Long Name	Subject	Gender	weight1	weight2	weight3
7	7	male	97.7	95.7	67.7
8	8	male	84	85.9	84
9	9	male	95.3	89.1	69.3
10	10	male	73	75.2	73
11	11	male	107	102.1	77
12	12	male	81.85	76.2	65.85
13	13	male	84	75.9	76.1
14	14	male	96.5	80.6	66.5
15	15	male	93	81.2	79
16	16	male	77.7	75.6	57.7
17	17	male	92	80.1	75.9
18	18	male	103	82.3	85.3
19	19	male	67.4	68.2	70.2
20	20	male	88.5	90.1	78.4
21	21	male	69	70.3	70.6
22	22	male	75.9	70.5	71.6
23	23	male	88	80.9	82.6
24	24	male	100.1	96.2	90.3
25	25	female	69.3	55.1	60.3
26	26	female	76.05	47.6	50.05
27	27	female	108.5	72.3	58.5
28	28	female	85.5	76.9	55.5
29	29	female	61.5	68.7	51.5
30	30	female	76.7	75.9	66.7
31	31	female	96.3	68.5	62.3

4. Choose the **Descriptive Statistics** tab. select all check boxes

5. Choose the **Means Comparison** tab, select **Bonferroni** check box.

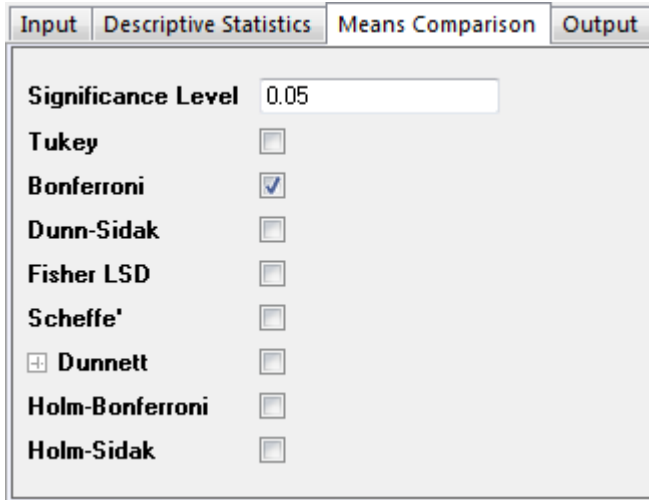

- Click **OK** button to perform the analysis

#### 5.4.6.6 Interpreting the Results

Go to the worksheet **ANOVATwoWayRM1**, where the analysis results are listed.

You can refer to this [interpreting results help page](#) for details of interpreting results of repeated measures ANOVA. .

- From the **Mauchly's Test of Sphericity** table, we can see **Prob>ChiSq**(0.01258) < 0.05. So the repeated measure variable, **Weight**, violates the Sphericity assumption. We should consider the **Greenhouse-Geisser** correction ect. While the Epsilon is larger than 0.75, we will look at the Huynh and Feldt correction in step 2 below

	Mauchly's W	Approx. Chi-Square	DF	Prob>ChiSq	Greenhouse-Geisser Epsilon	Huynh-Feldt Epsilon	Lower-bound Epsilon
Weight	0.82327	8.75143	2	0.01258	0.84981	0.89821	0.5

- From the **Tests of Within-Subject Effects** table, we can see
  - For **Weight**, the p\_vaule is about 0 in the **Prob>F** column, It indicates that the weight is a significant effect, that is, the weights change over time.
  - While the interaction, **Weight\*Gender**, is not significant different(p\_value = 0.14025), we can conclude that there is not a significant interaction effect, **Weight\*Gender**

Tests of Within-Subjects Effects

		Sum of Squares	DF	Mean Square	F	Prob>F
Weight	Sphericity Assumed	6328.11622	2	3164.05811	43	2.16215E-13
	Greenhouse-Geisser	6328.11622	1.69962	3723.25578	43	9.9634E-12
	Huynh-Feldt	6328.11622	1.79641	3522.64301	40.71343	2.89727E-12
	Lower-bound	6328.11622	1	6328.11622	40.71343	7.76453E-8
Weight * Gender	Sphericity Assumed	318.3098	2	159.1549	2.04792	0.13484
	Greenhouse-Geisser	318.3098	1.69962	187.28303	2.04792	0.14282
	Huynh-Feldt	318.3098	1.79641	177.19204	2.04792	0.14025
	Lower-bound	318.3098	1	318.3098	2.04792	0.15917
Error(Weight)	Sphericity Assumed	7149.81058	92	777.15337		
	Greenhouse-Geisser	7149.81058	78.18247	914.50728		
	Huynh-Feldt	7149.81058	82.63493	86.52286		
	Lower-bound	7149.81058	46	155.43066		

- We can further study how the weights change over time during the treatment. Expand the **Weight** branch. From the tables we can see

  - From the **Descriptive Statistics** table we can see that the weights are decreasing
  - In the **Pairwise Comparison** table, the **1** in the **Sig Flag** column indicates the pair of group is significant different. We can draw conclusion that the weights are significantly decreasing

Weight

Descriptive Statistics

	Mean	Std. Error	95% LCL	95% UCL
Weight Level1	83.28479	2.20515	78.84606	87.72352
Weight Level2	74.66625	1.59795	71.44974	77.88276
Weight Level3	67.05729	1.23317	64.57505	69.53953

Pairwise Comparison

Bonferroni Test

	Index	Mean Difference	Std. Error	DF	t value	Prob> t	Alpha	Sig Flag	95% LCL	95% UCL
Weight Level1 Weight Level2	0	8.61854	1.79948	92	4.78945	1.91332E-5	0.05	1	4.23043	13.00666
Weight Level1 Weight Level3	1	16.2275	1.79948	92	9.01787	7.98371E-14	0.05	1	11.83939	20.61561
Weight Level2 Weight Level3	2	7.60896	1.79948	92	4.22841	1.66392E-4	0.05	1	3.22084	11.99707

Sig equals 1 indicates that the difference of the means is significant at the 0.05 level.  
 Sig equals 0 indicates that the difference of the means is not significant at the 0.05 level.  
 Sig equals -1 indicates that the difference of the means is not tested.

- From the **Tests for Between-Subjects Effects** table, we can see **Gender** is a significant effect, that is, Female and Male can be significant different.

Tests of Between-Subjects Effects

	Sum of Squares	DF	Mean Square	F	Prob>F
Intercept	810060.00111	1	810060.00111	2961.43253	2.07173E-43
Gender	8857.94694	1	8857.94694	32.38305	8.40281E-7
Error	12582.68074	46	273.53654		

- Look at the **Gender** branch to see the details.

  - There are only two levels for Gender and we already know they are significant different, so we don't need to look at the **Pairwise Comparison** table
  - From the **Descriptive Statistics** table we can see that average weight of men is more than women.

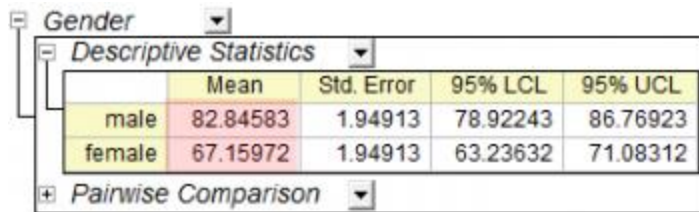

	Mean	Std. Error	95% LCL	95% UCL
male	82.84583	1.94913	78.92243	86.76923
female	67.15972	1.94913	63.23632	71.08312

**Notes:** As there is no serious violation of sphericity assumption, we can ignore the **Multivariate Tests** table. See more details from the [interpreting results help page](#).

## 5.4.7 Three-Way ANOVA

### 5.4.7.1 Summary

Three-way ANOVA tests for main effects, and interaction effects between all combinations of three factors, on a dependent variable.

Minimum Origin Version Required: OriginPro 2016 SR0

### 5.4.7.2 What you will learn

1. How to carry out three-way ANOVA for practical data with Origin
2. How to interpret the generated results

### 5.4.7.3 User Story

We have some public data from the World Bank. It includes three factors: Region(Asia/Europe/Africa, etc.), Developing Index (Developing/Developed Country) and Year (2000/2005/2010). We want to understand how these three factors affect the number of internet users and whether there are any significant differences between the groups.

### 5.4.7.4 Performing Three-Way ANOVA

1. Choose menu **Help: Learning Center** to open Learning Center dialog. Select **Analysis Sample** in the left side and then choose **Statistics - ANOVA** from the **Samples in** drop-down list in the right side.
2. Double-click on third item in the list box to open the folder *Three Way ANOVA*.
3. Click on worksheet **Sheet1** containing the source data.
4. Click **Statistics: ANOVA: Three-Way ANOVA**
5. In the **Input** tab of the opened dialog, set **Input Data** as **Indexed**. Then expand the **Input Data** branch, select column C,D, B and E for **Factor A, Factor B, Factor C** and **Data**, respectively

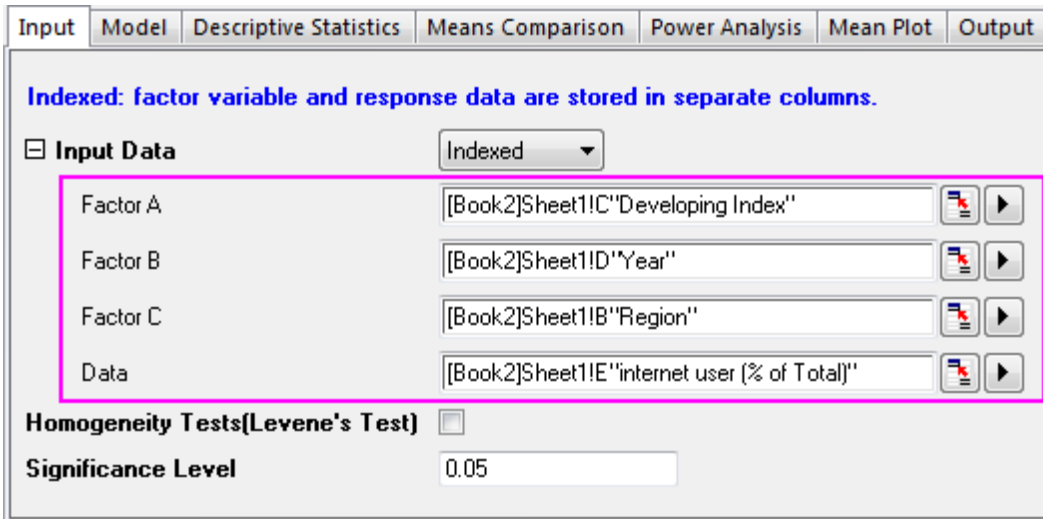

- In the **Model** tab, make sure all boxes are selected. This determines that a full factorial model will be used for the three-way ANOVA.

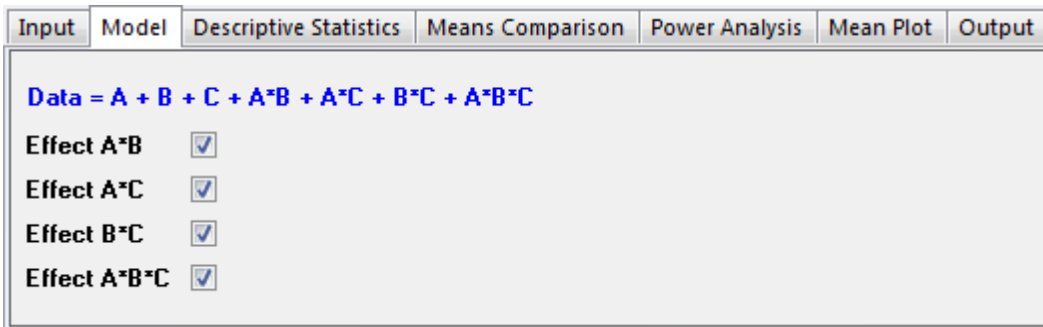

- Click **OK** to apply all setting and close the dialog.
- Go to sheet **ANOVA3Way1**. The **Overall ANOVA** table includes ANOVA test results for the main effects and the interactions. If the **P Value** is less than 0.05, this means the levels in the corresponding factor are significantly different. Note the conclusions in the footnotes beneath the table.



Overall ANOVA					
	DF	Sum of Squares	Mean Square	F Value	P Value
Developing Index	1	23652.65024	23652.65024	132.61578	0
Year	2	15248.13748	7624.06874	42.74666	0
Region	5	15055.32285	3011.06457	16.88245	1.77636E-15
Developing Index*Year	2	511.16006	255.58003	1.43299	0.23954
Developing Index*Region	5	9230.53132	1846.10626	10.35076	1.78556E-9
Year*Region	10	5342.29117	534.22912	2.99532	0.0011
Developing Index*Year*Region	10	896.73603	89.6736	0.50278	0.88834
Model	35	241745.07507	6907.00214	38.72621	0
Error	516	92031.03363	178.35472	0	0
Corrected Total	551	333776.1087	0	0	0

At the 0.05 level, the population means of **Developing Index** are significantly different.  
 At the 0.05 level, the population means of **Year** are significantly different.  
 At the 0.05 level, the population means of **Region** are significantly different.  
 At the 0.05 level, the population means of **Developing Index\*Year** are not significantly different.  
 At the 0.05 level, the population means of **Developing Index\*Region** are significantly different.  
 At the 0.05 level, the population means of **Year\*Region** are significantly different.  
 At the 0.05 level, the population means of **Developing Index\*Year\*Region** are not significantly different.

From the **Overall ANOVA** table above we can see the two-way interaction of factors **Developing Index\*Year** is not significant (p-value = 0.23954). The three-way interaction of factors **Region\*Developing Index\*Year**, is not significant. (p-value = 0.88834).

5.4.7.5 Examining Significant Interactions

In the following, we are going to further examine factors showing a significant interaction.

1. Click the green lock in the sheet **ANOVA3Way1** and choose **Change Parameters** from the context menu

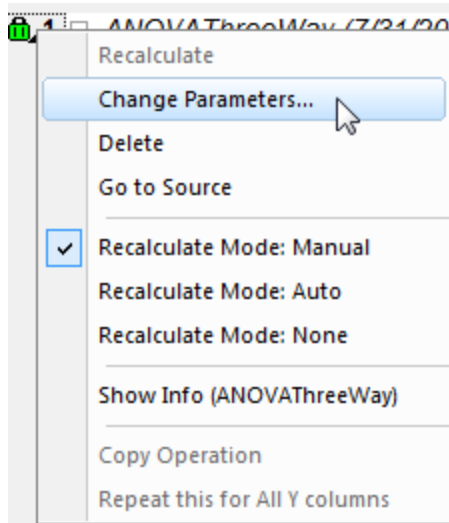

2. In the **Model** tab, clear the **Effect A\*B** and **Effect A\*B\*C** check boxes, where interactions between factors could not be detected.



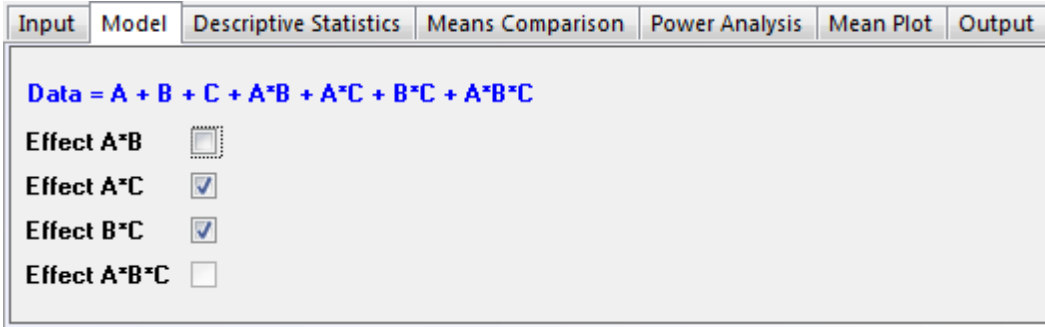

3. In the **Means Comparison** tab, select the **Bonferroni** check box. Bonferroni is the most commonly used post-hoc test. It controls the overall Type I error.
4. In the **Mean Plot** tab, select all available check boxes. (**Effect A\*B** and **Effect A\*B\*C** are disabled because they are not included in the model.)

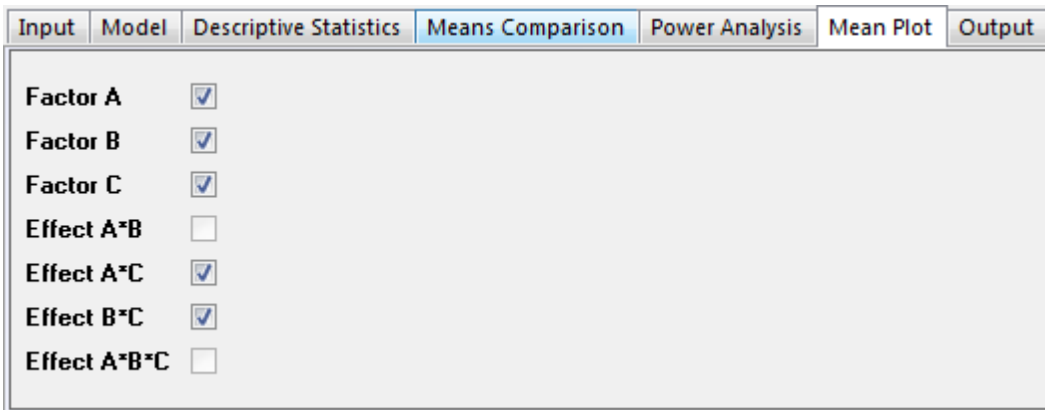

5. Click **OK** to apply all setting and close the dialog.

#### 5.4.7.6 Interpreting Results

The results in the sheet **ANOVA3Way1** are updated using the new calculation parameters.

##### 5.4.7.6.1 Overall ANOVA

Overall ANOVA					
	DF	Sum of Squares	Mean Square	F Value	P Value
Developing Index	1	24445.97236	24445.97236	138.04613	0
Year	2	44473.73843	22236.86921	125.57135	0
Region	5	15019.51175	3003.90235	16.963	1.44329E-15
Developing Index*Region	5	9809.01069	1961.80214	11.07827	3.65762E-10
Year*Region	10	20038.12871	2003.81287	11.31551	0
Model	23	240274.94891	10446.73691	58.99261	0
Error	528	93501.15979	177.08553	0	0
Corrected Total	551	333776.1087	0	0	0

At the 0.05 level, the population means of **Developing Index** are significantly different.  
 At the 0.05 level, the population means of **Year** are significantly different.  
 At the 0.05 level, the population means of **Region** are significantly different.  
 At the 0.05 level, the population means of **Developing Index\*Region** are significantly different.  
 At the 0.05 level, the population means of **Year\*Region** are significantly different.

From the table we can see all remaining effects are significantly different. We can use the **Means Comparisons** results and **Means Plots** to further detect differences between each group.

#### 5.4.7.6.2 Means Comparison and Means Plot of the Three Main Effects

Expanding the branch **ANOVA: Means Comparison: Bonferroni Test**, you can see the means comparison table for each effect. It is useful, along with the **Means Plot** at the bottom of the result sheet, for pairwise comparisons between members of a group.

#### Comparison between Developing and Developed Country

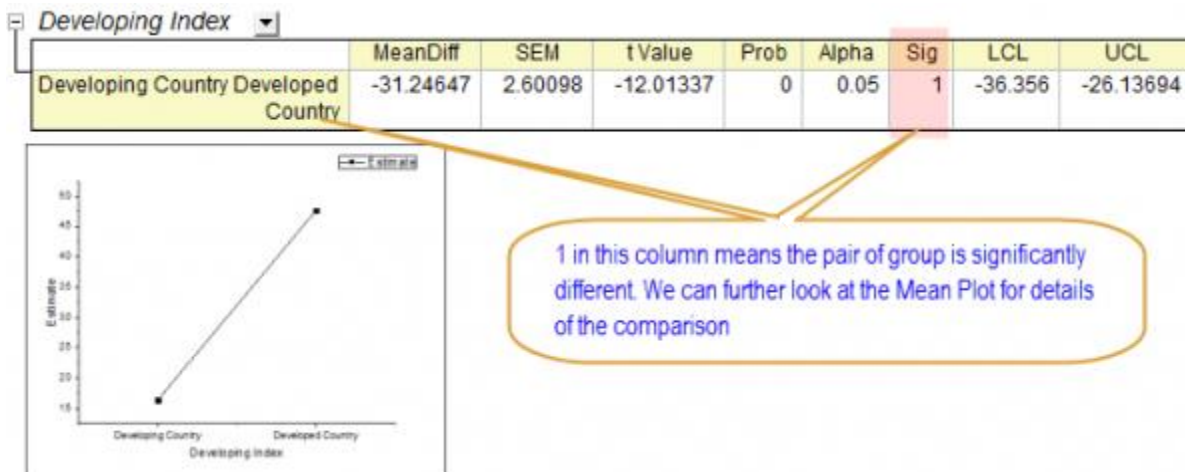

From the result above we can see the number of internet users of developing countries is much fewer than the developed countries.

#### Comparison between Years

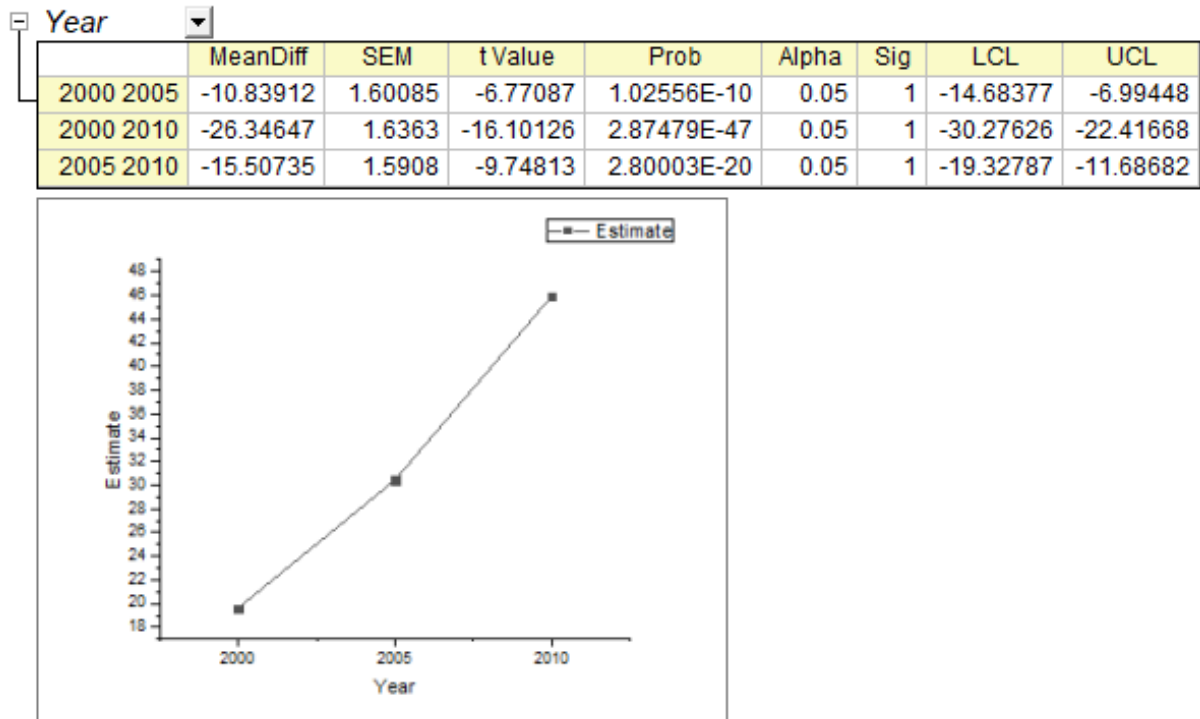

From the result above we can see the number of internet users greatly increased between 2000 and 2010.

**Comparison between Regions**

Region	MeanDiff	SEM	t Value	Prob	Alpha	Sig	LCL	UCL
Asia Europe	-5.46197	3.9887	-1.36936	1	0.05	0	-17.22311	6.29917
Asia Africa	29.83188	5.38213	5.54277	7.06154E-7	0.05	1	13.96204	45.70172
Asia The Americas	-4.9414	4.44103	-1.11267	1	0.05	0	-18.0363	8.15349
Asia Oceania	-0.65636	4.96954	-0.13208	1	0.05	0	-15.30964	13.99693
Asia Middle East	8.50447	5.46795	1.55533	1	0.05	0	-7.61842	24.62736
Europe Africa	35.29385	3.96669	8.89755	1.3668E-16	0.05	1	23.59758	46.99011
Europe The Americas	0.52057	2.54757	0.20434	1	0.05	0	-6.99124	8.03237
Europe Oceania	4.80561	3.38581	1.41934	1	0.05	0	-5.17785	14.78908
Europe Middle East	13.96644	4.08238	3.42115	0.01008	0.05	1	1.92906	26.00382
Africa The Americas	-34.77328	4.42128	-7.86499	3.14391E-13	0.05	1	-47.80994	-21.73662
Africa Oceania	-30.48824	4.9519	-6.15688	2.20497E-8	0.05	1	-45.0895	-15.88697
Africa Middle East	-21.32741	5.45192	-3.91191	0.00155	0.05	1	-37.40304	-5.25178
The Americas Oceania	4.28504	3.90855	1.09633	1	0.05	0	-7.23977	15.80986
The Americas Middle East	-13.44587	4.52536	2.97123	0.04652	0.05	1	0.10232	26.78943
Oceania Middle East	9.16083	5.04504	1.81581	1	0.05	0	-5.71508	24.03674

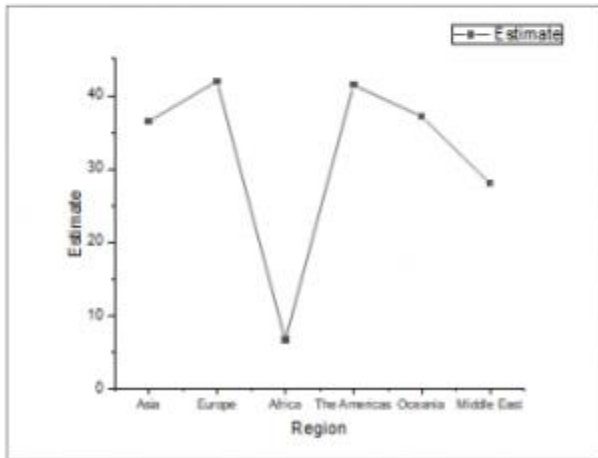

The results above tell us:

- Internet users in Africa are significantly fewer than other continents.
- Internet users in the Middle East are significantly fewer than Europe and the Americas.
- There is no significant difference between other pairs of continents.

#### 5.4.7.6.3 Comparing Same Level Between Different Groups



We can compare the sample level between different groups with **Mean Comparison** results of the interactions. In the following we will show how to use a data filter to quickly view the results we are interested in.

1. In the sheet **ANOVA3Way1**, expand the branch **ANOVA: Means Comparison: Bonferroni Test**.

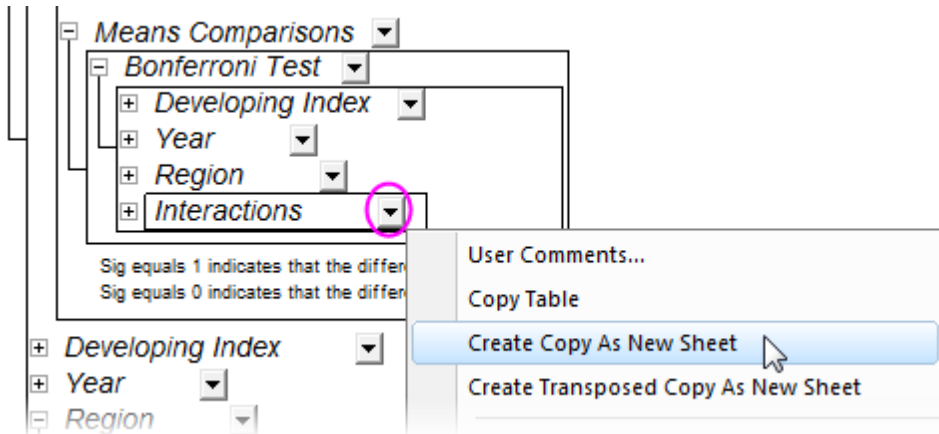
- Click the triangle button next to **Interactions** and choose **Create Copy as New Sheet** from the context menu.



- Go to the generated sheet **Interactions**. Now we are going to compare developing and developed countries in different regions by applying a data filter in the results.

- Highlight column C, click the **Add/Remove Data Filter** button  to add a data filter to the column.
- Click the **Filter** icon  on the column header, choose **Custom Filter**.
- Select the **Advanced** check box in the bottom-right corner of the open dialog. Add following script in the **Condition** box.

```
col(c)$==col(f)$
```

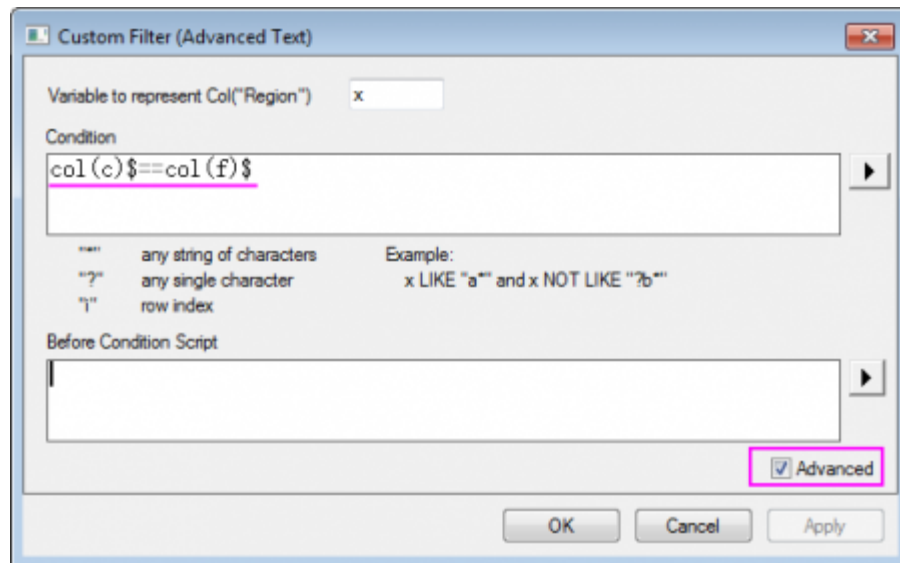

- From the results below we can see:

3.

- The internet users in the developed and developing countries are not significantly different in Africa and Middle East.
- The internet users in the developed countries are significant higher than the developing countries on the following four continents.

1. Asia

2. Europe

3. The Americas

4. Oceania

○

Long Name	A(Y)	B(Y)	C(Y)	D(Y)	E(Y)	F(Y)	G(Y)	H(Y)Er?	I(Y)	J(Y)	K(Y)	L(Y)	M(Y)	N(Y)
Filter	Developing Index	Year	Region	Developing Index	Year	Region	MeanDiff	SEM	TValue	Prob	Alpha	Sig	LCL	UCL
5	Developing Country	--	Asia	Developed Country	--	Asia	-42.92764	7.53444	-5.6229	2.01079E-6	0.05	1	-68.79032	-17.06497
17	Developing Country	--	Europe	Developed Country	--	Europe	-22.4491	2.31388	-9.70162	0	0.05	1	-30.28769	-14.61051
27	Developing Country	--	Africa	Developed Country	--	Africa	-3.25806	7.58844	-0.42935	1	0.05	0	-28.96493	22.4468
36	Developing Country	--	The Americas	Developed Country	--	The Americas	-46.60039	4.53941	-10.26573	0	0.05	1	-61.97825	-31.22253
44	Developing Country	--	Oceania	Developed Country	--	Oceania	-55.64037	6.35642	-8.75342	0	0.05	1	-77.17358	-34.10716
51	Developing Country	--	Middle East	Developed Country	--	Middle East	-16.60325	7.83002	-2.12046	1	0.05	0	-43.12847	9.92197
72	--	2000	Asia	--	2005	Asia	-8.27063	3.25534	-2.54064	1	0.05	0	-20.04479	3.50353
76	--	2000	Asia	--	2010	Asia	-21.84267	3.27985	-6.66028	0	0.05	0	-32.46667	-9.97982

1 in the Sig column means the pair of levels are significant different, while 0 means no significant different

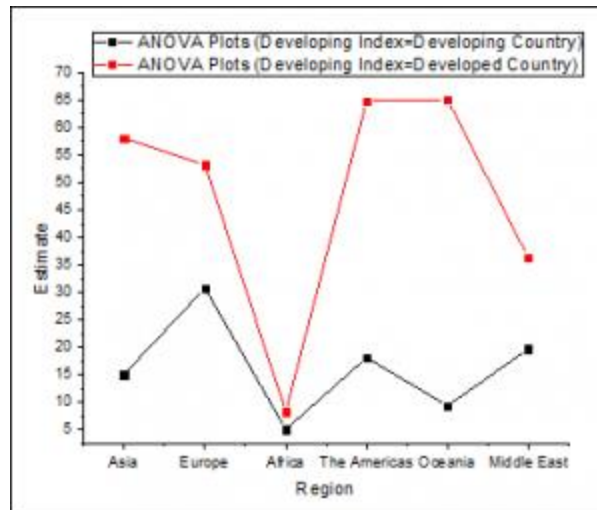

## 5.5 Nonparametric Tests

### 5.5.1 Nonparametric Tests

- [Non-parametric Statistics Overview](#)

### 5.5.2 Non-parametric Statistics Overview

#### 5.5.2.1 Summary

Nonparametric tests are used when you don't know whether your data are normally distributed, or when you have confirmed that your data are not normally distributed.

5.5.2.2 What you will learn

This tutorial will show you:

- An introduction on non-parametric tests in Origin
- How to run the non-parametric tests for different practical situations
- How to calculate correlation coefficient in non-parametric statistics

5.5.2.3 Introduction: Nonparametric Tests in Origin

Nonparametric tests do not require the assumption of normality. They are commonly used in the following situations:

- Small sample size.
- Categorical/Binary/Ordinal data.
- Normal distribution cannot be assumed.

		<b>Nonparametric</b>	<b>Parametric</b>
		<i>Data from any distribution</i>	<i>Data from normal distribution</i>
		<i>Small Samples</i>	<i>Large Samples</i>
<b>One Sample</b>		Wilcoxon Signed Rank Test	One Sample T-Test
<b>Two Samples</b>	Independent Samples	<ul style="list-style-type: none"> <li>• Mann-Whitney test</li> <li>• Kolmogorov-Smirnov test</li> </ul>	Two Sample T-Test
	Paired Samples	<ul style="list-style-type: none"> <li>• Wilcoxon signed rank Test</li> <li>• Sign Test</li> </ul>	Paired Sample T-Test
<b>Multiple Samples</b>	Independent Samples	<ul style="list-style-type: none"> <li>• Kruskal-Wallis ANOVA</li> <li>• Mood's Median Test</li> </ul>	One Way ANOVA
	Related Samples	Friedman ANOVA	One Way Repeated Measure ANOVA

5.5.2.4 Examples

### 5.5.2.4.1 One Sample Independent Tests

The One-Sample Wilcoxon Signed Rank test is designed to examine the population median relative to a specified value. You may choose a one- or two-tailed test. The Wilcoxon signed rank test hypotheses are  $H_0$ : median = hypothesized median versus  $H_1$ : median  $\neq$  hypothesized median.

In this example, a quality engineer in a production shop is interested in whether median (or average) of the weight of product is equal to 166. So select 10 product at random and measured their weight . The data measured as following:

151.5 152.4 153.2 156.3 179.1 180.2 160.5 180.8 149.2 188.0

The engineer perform **Normality Test** to determine if the distribution of the data is normal distribution

1. Open a new worksheet and input the above data in col(A). Select **Statistics: Descriptive Statistics: Normality Test...** to open the **Normality Test** dialog.
2. Select A(X) as **Data range**.

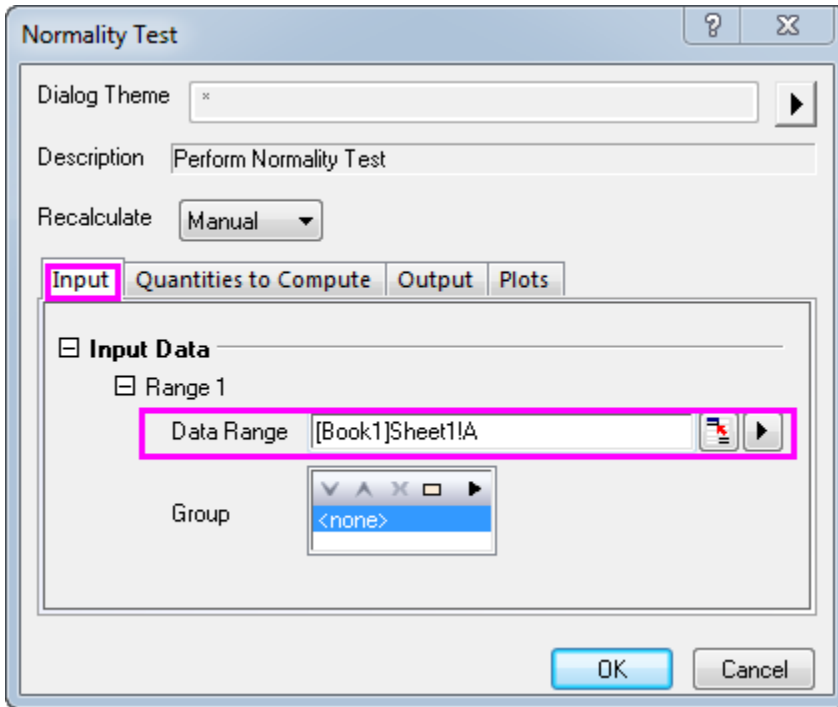

3. Click the **OK** button to generate results.

Shapiro-Wilk				
	DF	Statistic	p-value	Decision at level(5%)
B	10	0.83472	0.03814	Reject normality

B: At the 0.05 level, the data was not significantly drawn from a normally distributed population.

According to result,  $P$ -value=0.03814, the distribution of the data is not normal distribution at the 0.05 level. So, perform One-Sample Wilcoxon Signed Rank test:

1. Select **Statistics: Nonparametric Tests: One-sample Wilcoxon Signed Rank Test...** to open the dialog.
2. Set column A as **Data Range**.



- Input **166** in **Test Median** text box.

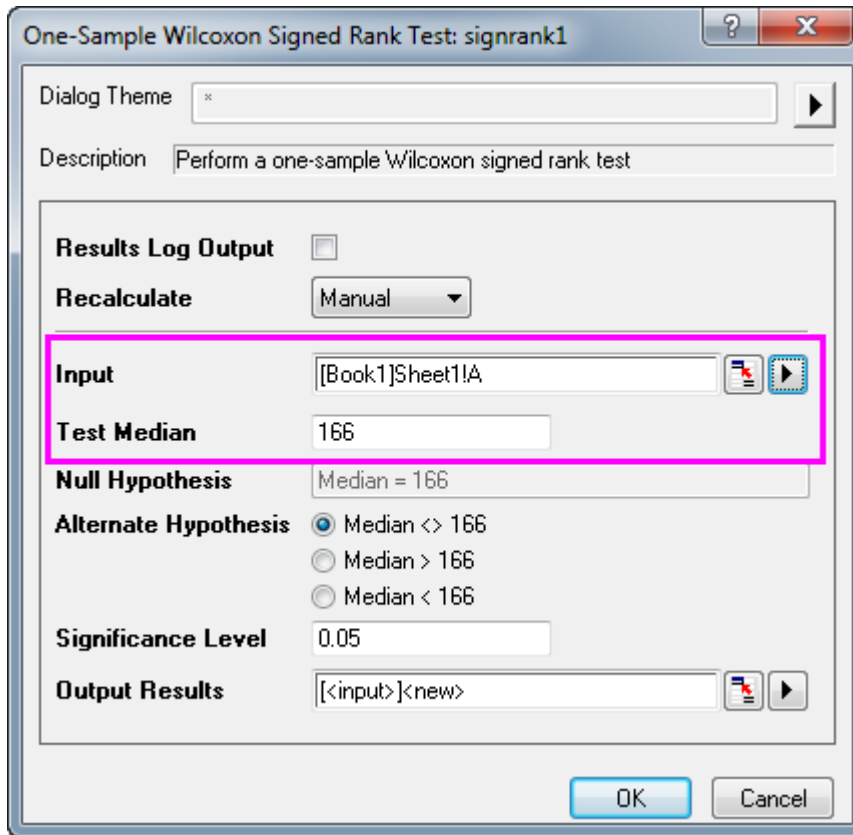

- Click the **OK** button to generate results

Descriptive Statistics

	N	Min	Q1	Median	Q3	Max
A	10	149.2	152.175	158.4	180.35	188

Test Statistics

	W	Z	Exact Prob > W	Asymp. Prob > W
A	28	0	1	1

Null Hypothesis: Median = 166  
 Alternative Hypothesis: Median <> 166  
 A: At the 0.05 level, the population median is NOT significantly different from the test median (166).

According to the result, it fails to reject null hypothesis at the 0.05 level and concludes that the median is equal to 166.

#### 5.5.2.4.2 Two Sample Independent Tests

Origin provides two tests for non-parametric statistics of two sample independent system: the **Mann-Whitney Test** and **Two Sample Kolmogorov-Smirnov Test**.

This following example shows the practical use of **Mann-Whitney Test**. The abrasions(in mg) are measured for two types of tires(A and B), 8 experiments were carried out for each tire type. The data is indexed and stored in abrasion\_indexed.dat file.

1. Import the abrasion\_indexed.dat file from **\Samples\Statistics\**
2. Select **Statistics: Nonparametric Tests: Mann-Whitney Test** to open the dialog.
3. Keep **Input Data Form** as **Index**
4. Set column A as **Group Range**, set column B as **Data Range**.
5. Select the **Exact P Value** check box.

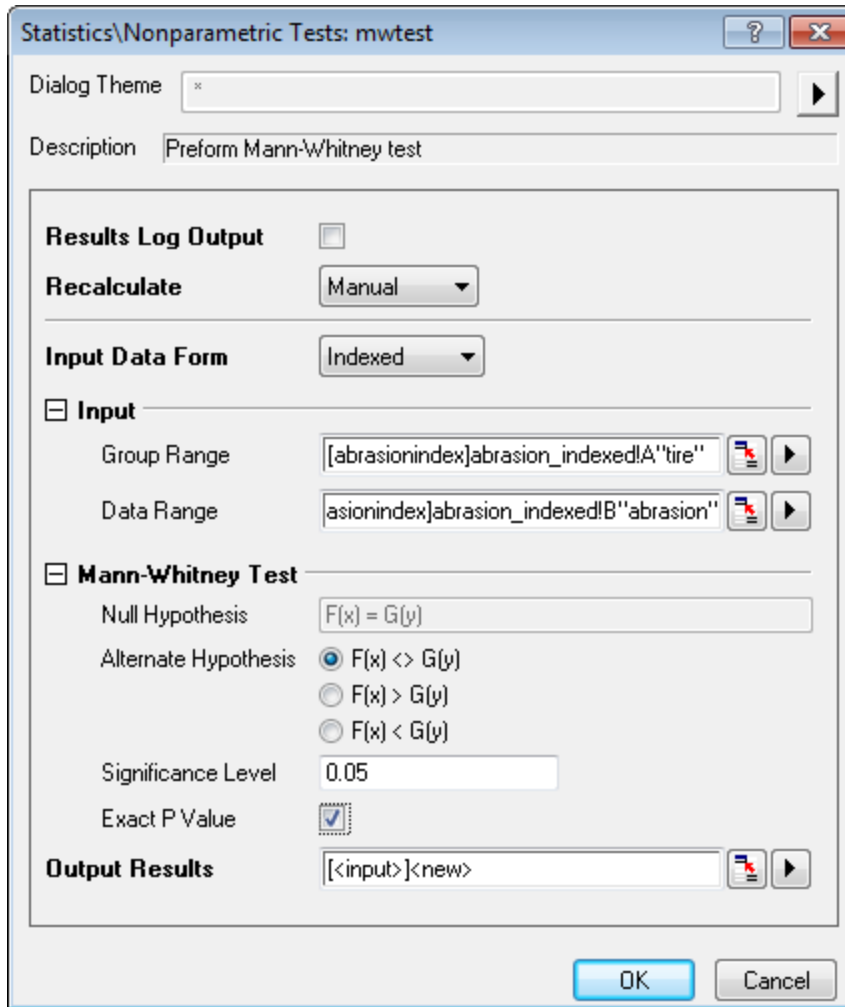

6. Click the **OK** button to generate results, which should be in the **MannWhitney1** sheet

Test Statistics

U	Z	Exact Prob> U	Asymp. Prob> U
34.5	0.2102	0.82191	0.83351

Null Hypothesis:  $F(x) = G(y)$   
 Alternative Hypothesis:  $F(x) \neq G(y)$   
 At the 0.05 level, the two distributions are NOT significantly different.

- **U**: The **U** statistic can be simply calculated from the rank of two groups. It is the number of times a score in the 2nd group is larger than a score in the 1st group.

- **Z:** The approximate Normal test statistic. It provides an excellent approximation as the sample size grows.
- **Exact Prob:** The exact p-value, only available when **Exact P Value** is selected in the dialog. However, it could be very CPU-time consuming for large sample size.
- **Asymp.Prob:** The asymptotic p-value calculated from the approximate Normal test statistic, **Z**

#### 5.5.2.4.3 Non-parametric Measures of Correlation

Correlation coefficient is used as a measure of relationship between two variables. It is possible to calculate the correlation coefficient for non-parametric statistics.

Origin provides two non-parametric methods to measure the correlations between variables:

- **Spearman:** common substitution of Pearson correlation coefficient, Spearman's coefficient can be used when both dependent (variable and independent variable are ordinal numeric, or when one variable is a ordinal numeric and the other is a continuous variable. However, it can also be appropriate to use Spearman's correlation when both variables are continuous.
- **Kendall:** Used with ordinal variables for assessing agreement among raters

The following example shows how to calculate correlation coefficient for non-parametric situations.

1. Import the abrasion\_raw.dat file from **Samples\Statistics**;
2. Highlight Column A and column B. Select **Statistics:Descriptive Statistics:Correlation Coefficient** to open the corrcoef dialog;
3. Check **Spearman** and uncheck **Pearson**;

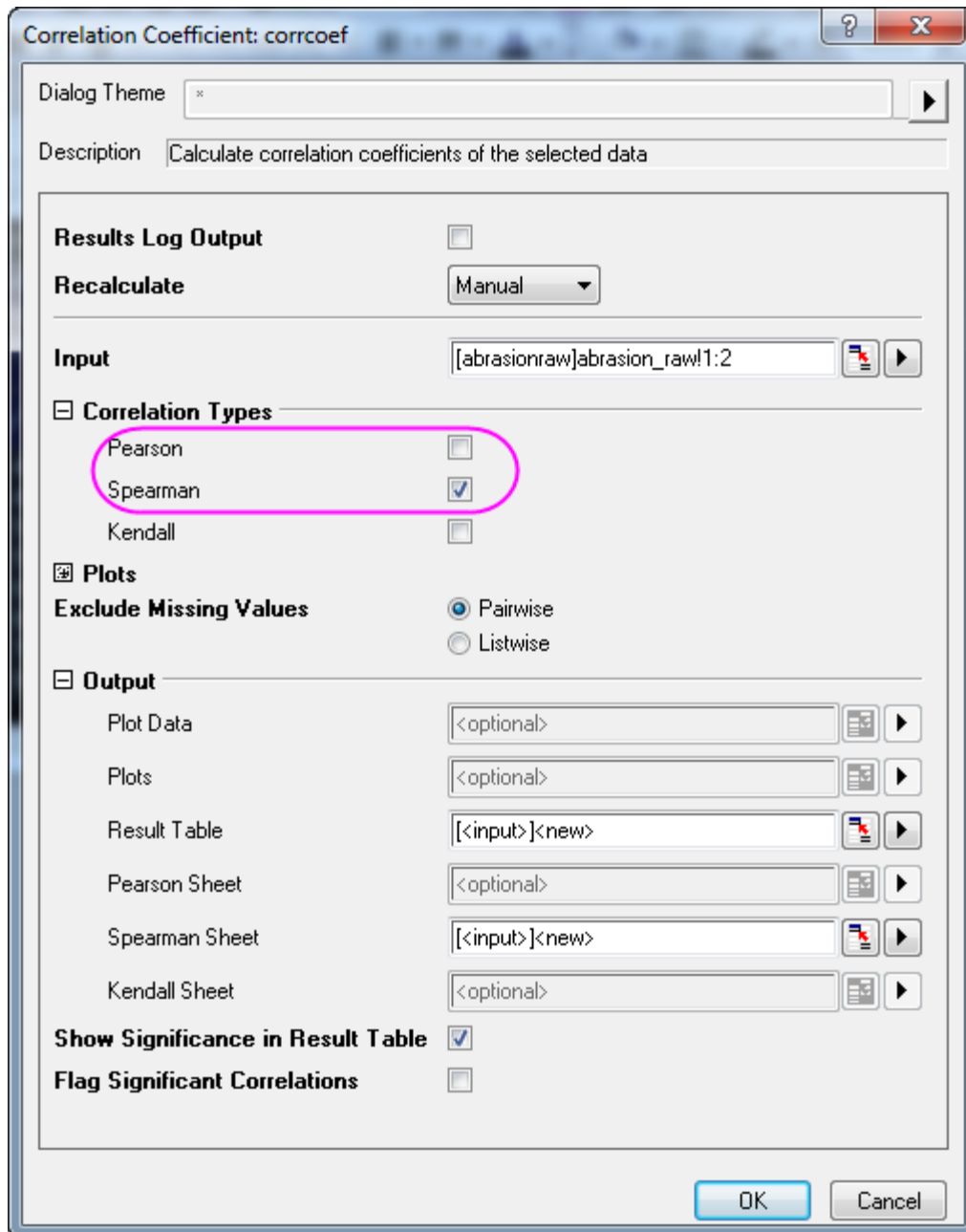

4. Click the **OK** button to generate the results, in the **CorrCoef1** sheet.

From the value of **Spearman Corr.**, it can be concluded that the abrasion between tire A and tire B are strongly related.

▣ Spearman Correlations

		tireA	tireB
"tireA"	Spearman Corr.	1	0.90476
	Sig.	--	0.00201
"tireB"	Spearman Corr.	0.90476	1
	Sig.	0.00201	--

2-tailed test of significance is used

#### 5.5.2.4.4 Paired Sample wilcoxon Signed Rank Tests

We will compare the two medians of *tire A* and *tire B* in above example.

1. Continue with the abrasion\_raw.dat file from **Samples\Statistics**;
2. Select **Statistics: Nonparametric Tests: Paired Sample wilcoxon Signed Rank Tests** to open the dialog;
3. Select Column A as **1st Range Data** and column B as **2nd range Data**;

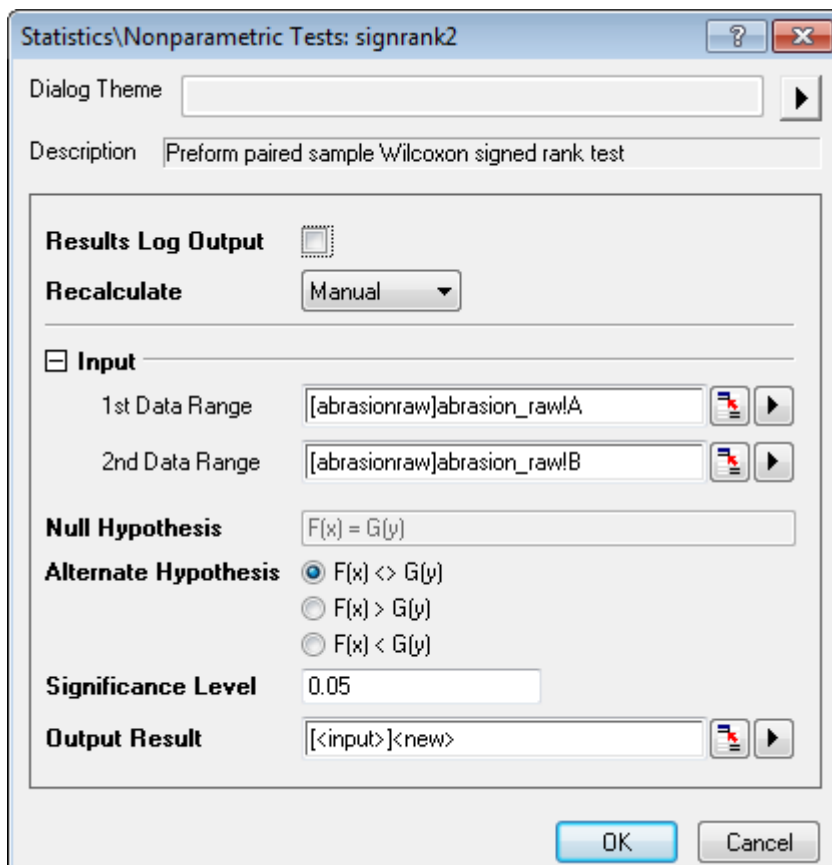

4. Click the **OK** button to generate the results.

Descriptive Statistics						
	N	Min	Q1	Median	Q3	Max
"tireA"	8	4870	4980	5760	7330	8650
"tireB"	8	4900	4950	5420	6687.5	7930

Ranks				
		N	Mean Rank	Sum Rank
"tireB"- "tireA"	Positive Ranks	2	1.5	3
	Negative Ranks	6	5.5	33

Test Statistics				
	W	Z	Exact Prob> W	Asymp. Prob> W
	33	2.0329	0.03906	0.04206

Null Hypothesis:  $F(x) = G(y)$   
 Alternative Hypothesis:  $F(x) \neq G(y)$   
 At the 0.05 level, the two distributions are significantly different.

We can conclude that two medians are significantly different. Obviously, median of group A is larger than that of group B.

#### 5.5.2.4.5 Multiple Independent Samples Test

In this example, the gas mileage of four car makers are measured. Several experiments are carried out for each car makers. The results are listed in the sample data table.

GMC/mpg	Infinity/mpg	Saab/mpg	Kia/mpg
26.1	32.2	24.5	28.4
28.4	34.3	23.5	34.2
24.3	29.5	26.4	29.5
26.2	35.6	27.1	32.2
27.8	32.5	29.9	
30.6	30.2		
28.1			

To evaluate whether the gas mileage of the four car makers are equal, and which one is the most efficient, Kruskal-Wallis ANOVA is chosen as the nonparametric test method.

1. Create a new workbook in Origin, copy the sample data and paste into it;
2. Select **Statistics:Nonparametric Tests:Kruskal-Wallis ANOVA** to open the kwanova dialog;

3. Specify Raw as **Input Data Form**;

4. Click the **triangle button**  next to **Input**, and select **All Columns** in the context menu;

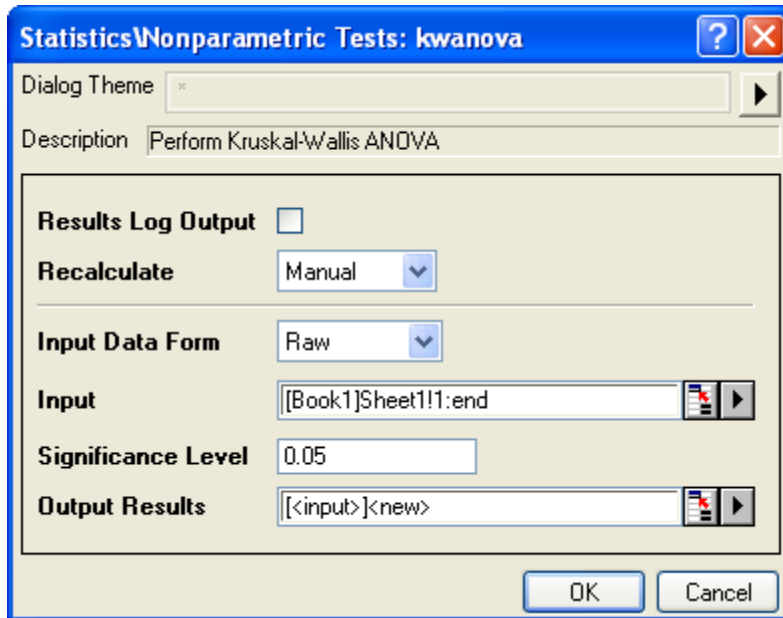

5. Click the **OK** button to generate results, the results are stored in a new worksheet **KWANOVA1**.

From the p-value we can conclude that gas mileage of the four car makers are significant different.

**Test Statistics**

Chi-Square	DF	Prob>Chi-Square
12.59645	3	0.0056

Null Hypothesis: The samples come from the same population.  
 Alternative Hypothesis: The samples come from different populations.  
 : At the 0.05 level, the populations are significantly different.

### 5.5.2.4.6 Multiple Related Samples Test

Ophthalmologists are investigating whether laser He-Ne therapy works for children. They have data from 2 groups, 6-10 Years Old and 11-16 Years Old. Each data set contains study of 5 persons' naked-eye eyesight difference after 3 period of therapy. The results are stored in the eyesight.dat.

Due to the small sample size, non-parametric statistics would be needed in analysis, following the steps below:

1. Import the eyesight.dat file from **\Samples\Statistics\**;
2. Select **Statistics:Nonparametric Tests:Friedman ANOVA** to open the friedman dialog;
3. Select Column A as **Data Range**, Column C as **Factor Range**, and Column D as **Subject Range**;

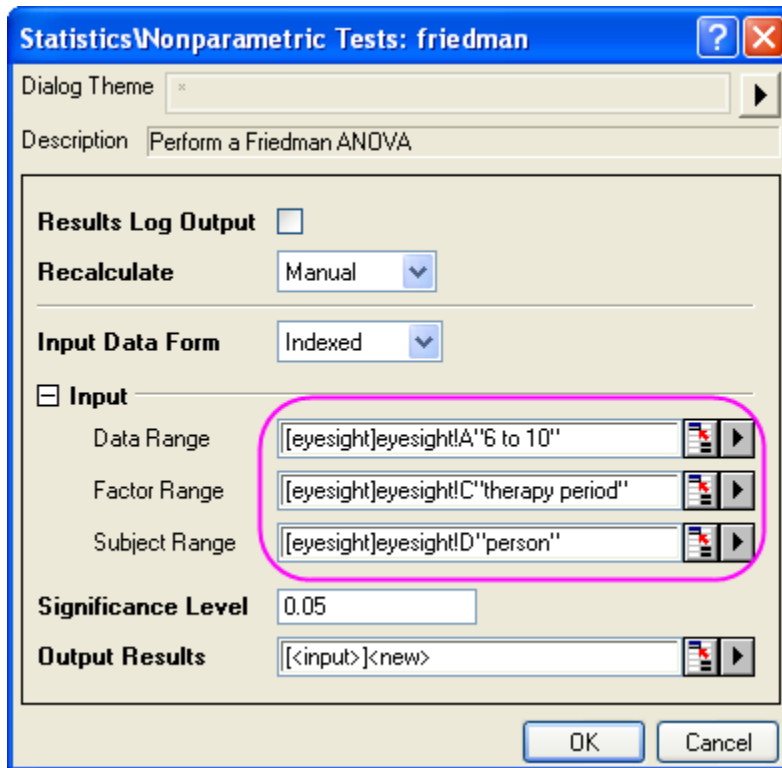

4. Click the **OK** button to generate results.

The p-value of  $\chi^2_{(10)}$  is 0.0067379, which is less than 0.05. The populations are significantly different, indicating that the therapy are effective for the age group 6-10.

**Test Statistics**

Chi-Square	DF	Prob>Chi-Square
10	2	0.00674

Null Hypothesis: The samples come from the same population.  
 Alternative Hypothesis: The samples come from different populations.  
 At the 0.05 level, the populations are significantly different

In a similar way, choose column B as **Data Range** and the rest setting of **Input** are the same with Step 3 previously.



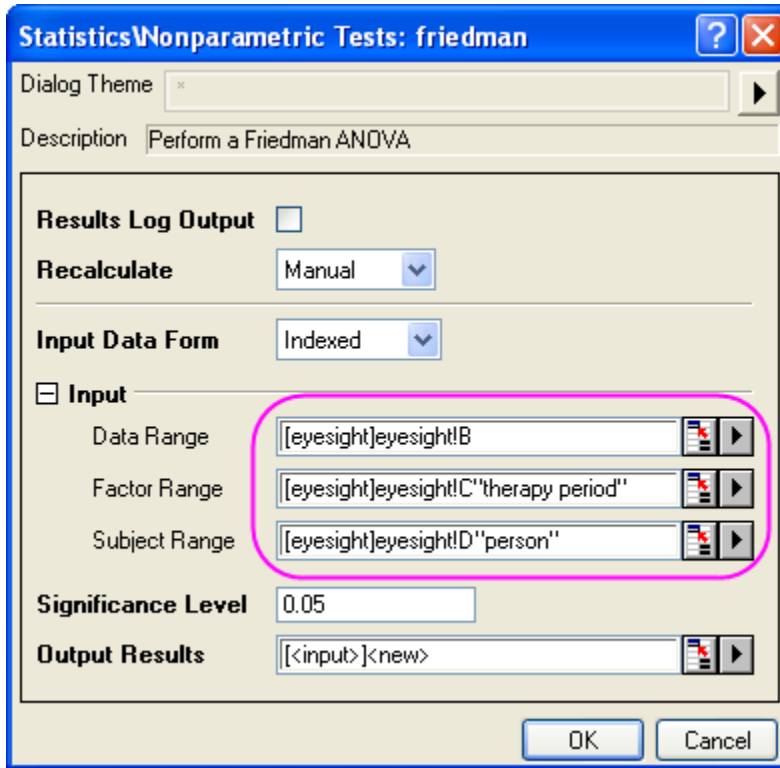

Check the result, we can see that p-value of  $\chi^2_{11-16}$  is 0.02599, less than 0.05 or 0.10. So we can also conclude that eyesight of 11-16 years old kids is better after 3 period of therapy.

Test Statistics

	Chi-Square	DF	Prob>Chi-Square
	7.3	2	0.02599

Null Hypothesis: The samples come from the same population.  
 Alternative Hypothesis: The samples come from different populations.  
 At the 0.05 level, the populations are significantly different

And we can see that  $\chi^2_{6-10} > \chi^2_{11-16}$ , that means, laser He-Ne therapy works better on 6-10 years old kids. The earlier children are to be involved in therapy, the more their eyesight can be improved.

## 5.6 Survival Analysis

### 5.6.1 Survival Analysis

- [Kaplan-Meier Estimator](#)
- [COX Model Estimator](#)
- [Weibull Fit](#)

## 5.6.2 Kaplan-Meier Estimator

### 5.6.2.1 Summary

Survival analysis is the study of the time until a certain event, such as a death or failure in treatment. It also called event history analysis in social science, or reliability analysis in engineering.

Survival function,  $S(t)$ , can describes the survival rate at time  $t$ . And  $S(t)=1-F(f)$ , where  $F(t)$  is the cumulative distribution function of the failure times. While The hazard function  $h(t)$  (also known as the failure rate, hazard rate, or force of mortality) is the ratio of the probability density function  $P(t)$  of  $F(t)$  to the survival function  $S(t)$ .

The Kaplan-Meier also called product-limit estimator provides an estimate of  $S(t)$  and  $h(t)$  from a sample of failure times which may be progressively right-censored.

### 5.6.2.2 What you will learn

This tutorial will show you how to:

- Perform Kaplan-Meier Estimator
- How to interpret the results

### 5.6.2.3 Steps

#### 5.6.2.3.1 Running Kaplan-Meier Estimator

Scientist is looking for a better medicine for cancer resistance. After exposing some rats to a carcinogen DMBA, they apply different medicine to different groups of rats and record their survival status for first 60 hours. In the 1st group, 15 rats survived after being exposed, on which Medicine 1 is applied. Note that on the 30th hours, 1 rat is dead but not for carcinoma. In the 2nd group, 15 rats survived with drug 2 applied. Note that on the 14th hour, the 15th hour and the 25th hour, 1 rat die but not because of carcinoma. And the records of two groups rats are sorted in the file **/Samples/Statistics/SurvivedRats.dat**. Note that in Status, 0 = dead but not because of carcinoma, 1 = dead because of carcinoma, 2 = alive.

1. Click the Import Single ASCII button  to import the file **/Samples/ Statistics/ SurvivedRats.dat**
2. Analyze the dataset using the Kaplan-Meier Estimate tool. Use the menu item **Statistics: Survival Analysis: Kaplan-Meier Estimator** to open the dialog.
3. Set column **A**, **B** and **C** as **Time Range**, **Censor Range** and **Grouping Range** respectively in the **Input** tab.
4. Set 0 and 2 as **Censored Value(s)**

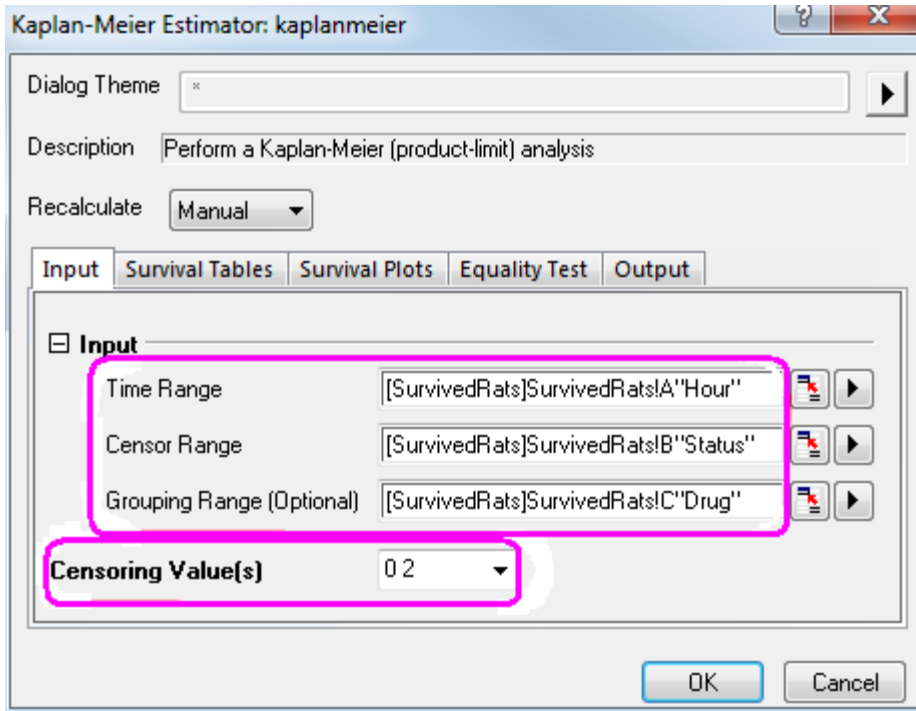

5. In the **Survival Table** tab, select the **Event and censor values Summary** , **Survival Estimates**, **Quartile Estimates** and **Mean Estimates** check boxes.

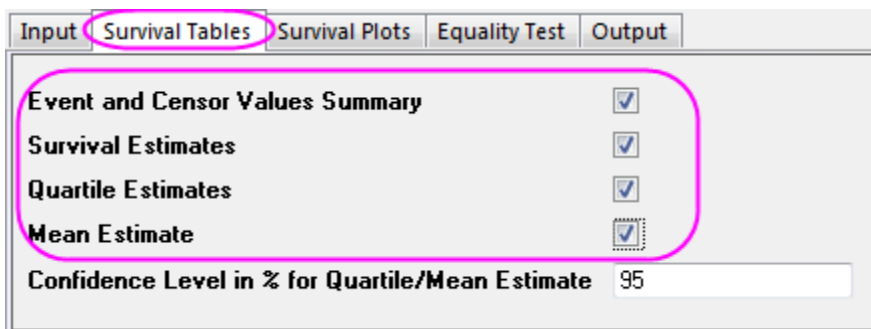

6. Select **Survival** , **One Minus survival** and **Hazard** check box in the **Survival Plots** tab.

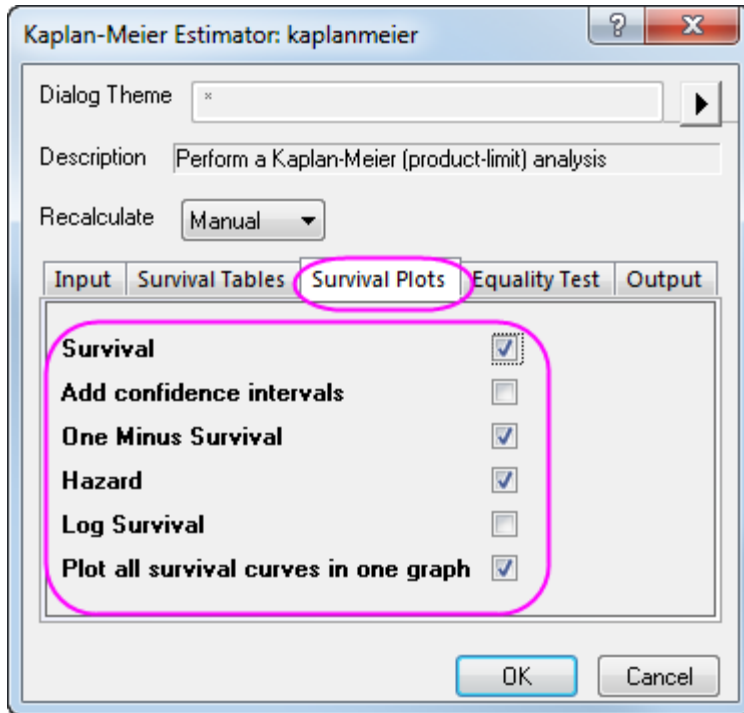

7. Select the **Log-Rank**, **Breslow** and **Tarone-Ware** check box in the **Equality Test** tab.

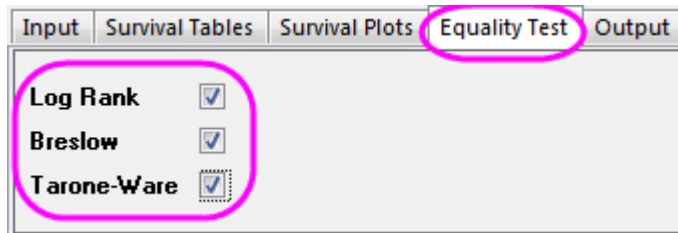

8. Click the **OK** button.

### 5.6.2.3 Interpreting the Results

Go to worksheet **KaplanMeier1** for the analysis report :

1. From the "summary of event and censored values" table, we can see that **Censored=3** and **Percent Censored =0.2** for drug 1 group and **Censored=9** and **Percent Censored=0.6** for drug 2 group.

Summary of Event and Censored Values

	Total	Events	Censored	Percent Censored
drug1	15	12	3	0.2
drug2	15	6	9	0.6

Censored Value(s): 0,2

2. "Kaplan-Meier Survival Estimates " tables display a descriptive procedure for examining the distribution of time-to-event variables. We also can compare the distribution by levels of a factor

variable. **Quartile Estimates** and **Means Estimates** table Provides the estimates and confidence interval of quartile and mean.

**Survival Analysis of Time (drug1)**

**Kaplan-Meier Survival Estimates**

Time	Status	Cumulative Survival	Standard Error	Cumulative Event	Number Remaining
14		0.93333	0.06441	1	14
15	--		--	2	13
15		0.8	0.10328	3	12
17	--		--	4	11
17		0.66667	0.12172	5	10
20		0.6	0.12649	6	9
21		0.53333	0.12881	7	8
23		0.46667	0.12881	8	7
30	+		--	8	6
32		0.38889	0.1287	9	5
38		0.31111	0.12426	10	4
42		0.23333	0.11499	11	3
58		0.15556	0.09955	12	2
60	+		--	12	1
60	+		--	12	0

Observations with status as + are censored ones.

**Quartile Estimates**

Percent Failures	Estimate	95% LCL	95% UCL
25	17	15	23
50	23	17	42
75	42	23	58

**Mean Estimate**

Estimate	Std.Error	95% LCL	95% UCL
32.02222	4.53441	23.13494	40.9095

Estimation is underestimated because the largest observation is censored.

**Survival Analysis of Time (drug2)**

**Kaplan-Meier Survival Estimates**

Time	Status	Cumulative Survival	Standard Error	Cumulative Event	Number Remaining
14	+	--	--	0	14
15	+	--	--	0	13
17		0.92308	0.07391	1	12
23		0.84615	0.10007	2	11
25	+	--	--	2	10
28	--		--	3	9
28		0.67692	0.13366	4	8
36		0.59231	0.14122	5	7
60		0.50769	0.14418	6	6
60	+	--	--	6	5
60	+	--	--	6	4
60	+	--	--	6	3
60	+	--	--	6	2
60	+	--	--	6	1
60	+	--	--	6	0

Observations with status as + are censored ones.

**Quartile Estimates**

Percent Failures	Estimate	95% LCL	95% UCL
25	28	23	60
50	--	--	--
75	--	--	--

**Mean Estimate**

Estimate	Std.Error	95% LCL	95% UCL
46.4	5.26463	36.08152	56.71848

3. The survival curves give a visual representation of the life tables. A plot of the Kaplan-Meier estimate of the survival function is a series of horizontal steps of declining magnitude. In the plot, the survival curve declines more rapidly, the survival rate is smaller. This Survival function plot shows proportion of individuals surviving at each hour for drug 1 group and drug 2 group and the survival curve of drug 1 always declines more rapidly, so we can conclude that drug 2 is one better medicine for cancer resistance.

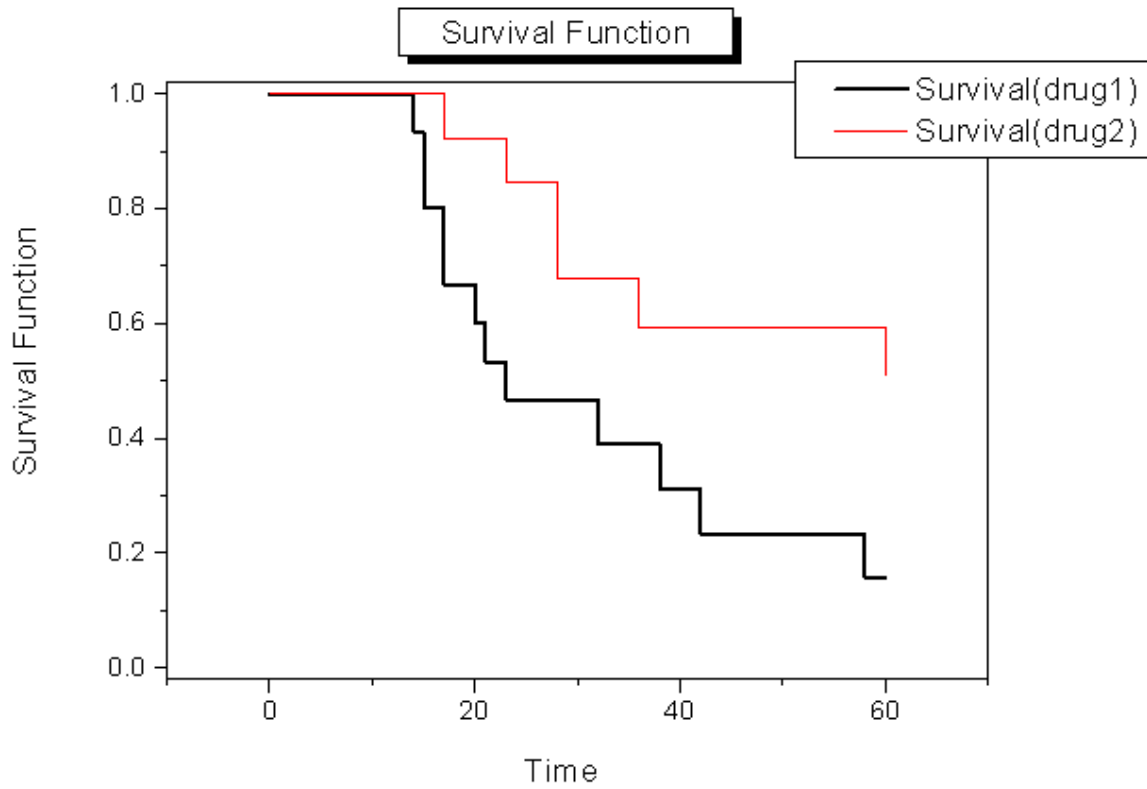

4. Form one minus survival function, we can get the same conclusion as Survival function plot.

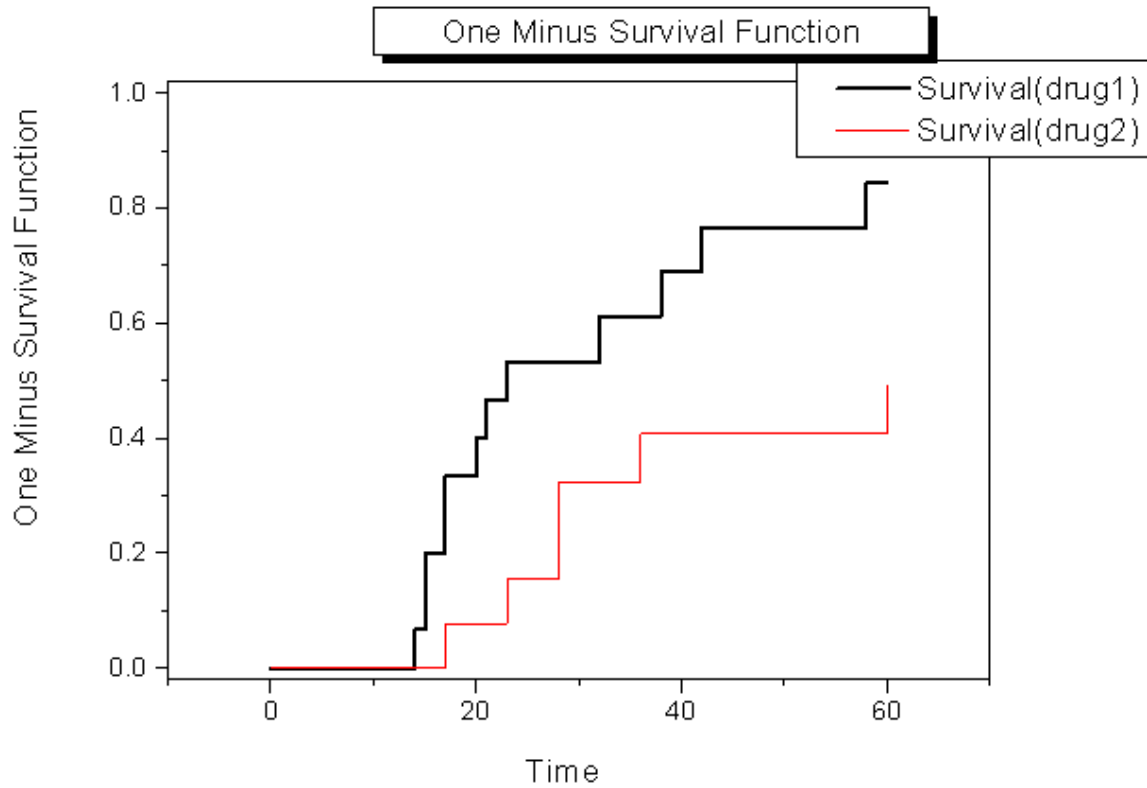

5. Hazard rate is the instantaneous probability of the given event occurring at any point in time. It can be plotted against time on the X axis, forming a graph of the hazard rate over time. And hazard function is the equation that describes this plotted line. From the graph, we can get the hazard rate of drug 1 group is greater than drug 2 group. So we can conclude that drug 2 is one better medicine for cancer resistance.



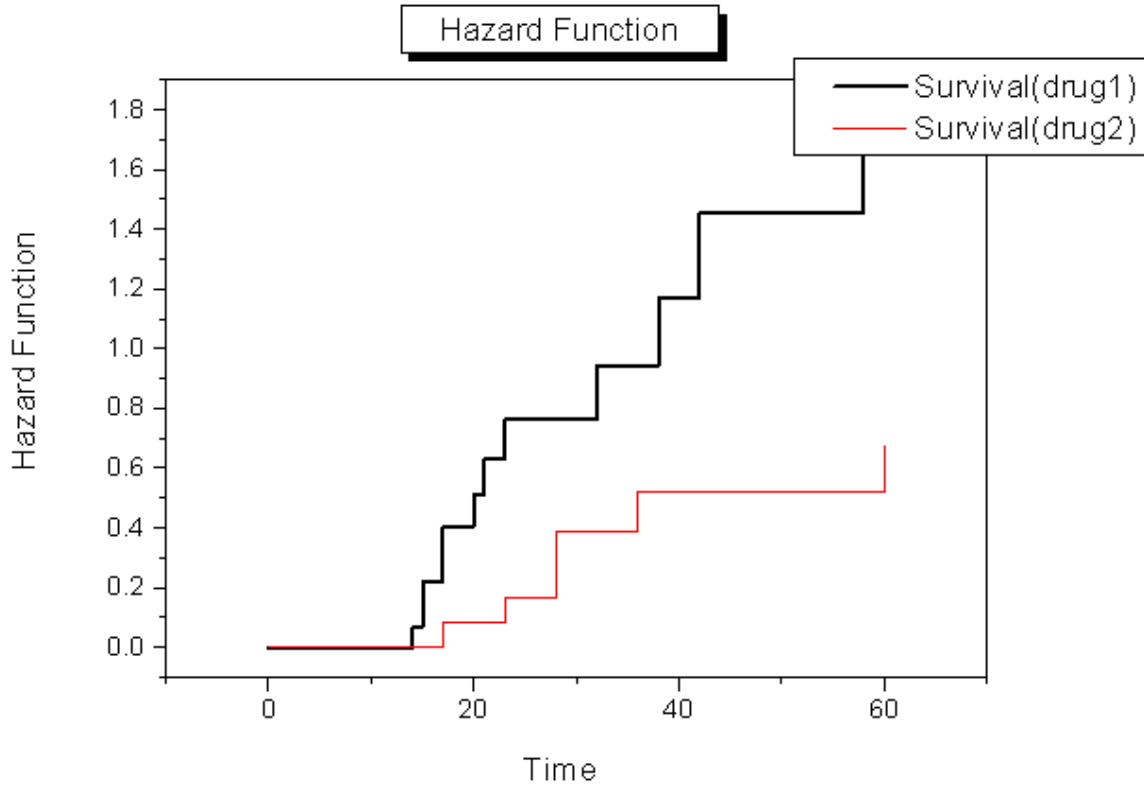

6. For overall tests of the equality of survival times across groups, Origin provides three methods:

- Log rank: Tests equality of survival functions by weighting all time points the same.
- Breslow: Tests equality of survival functions by weighting all time points by the number of cases at risk at each time point.
- Tarone-Ware: Tests equality of survival functions by weighting all time points by the square root of the number of cases at risk at each time point.

Test of Equality over Groups				
	Chi-Square	df	Prob>Chi-Square	Conclusion at level (5%)
Log Rank	4.73554	1	0.02955	There is significant difference
Breslow	4.91804	1	0.02658	There is significant difference
Tarone-Ware	4.89582	1	0.02692	There is significant difference

Since the significance values of the tests are all smaller than 0.05, there is statistically significant difference between two treatments(drug1 and drug2) in survival time.

### 5.6.3 COX Model Estimator

#### 5.6.3.1 Summary

The Cox Model Estimation ,also called the proportional hazard model is a classical semi-parameter method in survival analysis. A Cox model provides an estimate of the effect on survival for variables and the hazard of

death for an individual. Using Cox regression analysis, we will obtain an equation for the hazard as a function of several variables. A positive regression coefficient for an explanatory variable means that the hazard is higher with higher values of that variable. while for negative regression coefficient for an explanatory variable, the hazard is lower with higher values of that variable.

The proportional hazards assumption: Observations should be independent, and the hazard ratio should be constant across time; that is, the proportionality of hazards from one case to another should not vary over time.

### 5.6.3.2 What you will learn

This tutorial will show you how to:

- Perform COX Model Estimator
- How to interpreting the results

### 5.6.3.3 Perform COX Model Estimator

1. Click the Import Single ASCII button  to import **phm\_Cox.dat** located in the **\Samples \Statistics** subfolder.
2. Select **Statistics: Survival Analysis: Cox Model Estimator** to open the dialog.
3. Put the **A(X):month** column into **Time Range**. Similarly, put the **B(Y):status** column into **Censor Range**.
4. Click the interactive data selection button and choose the **Charlson** and **tKt\_v** column into the Covariate Range edit box.
5. Select **0** as the censoring value form censoring value(s) drop-down list.
6. check **Survival** and **Hazard** box in Survival Plots group.
7. Click the **OK** button to perform the Cox Model Estimator analysis.

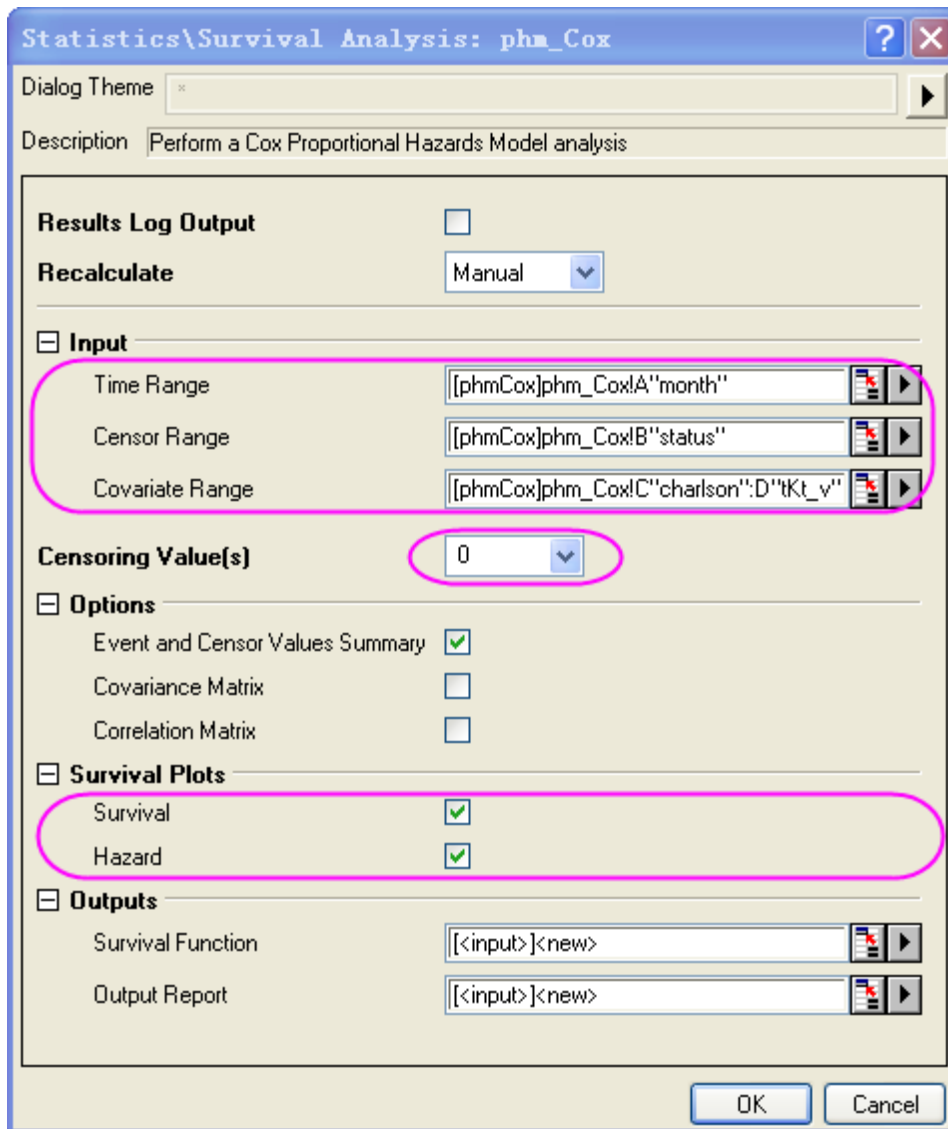

5.6.3.4 Interpreting the Results

Go to worksheet **CoxPHM1** for the analysis report.

1. From the "Summary of event and censored values" table, we can see that **censored** =112 and **percent Censored** =0.8.

Summary of Event and Censored Values

Total	Events	Censored	Percent Censored
140	28	112	0.8

Censored Value(s): 0

2. The following table displays the result of test whether the model is significant or not. Note that the null hypothesis is  $\beta_1 = \beta_2 = 0$ . In this example, **Pr > ChiSq** =4E(-4) <0.05, therefore we reject the null hypothesis; that is, either  $\beta_1$  or  $\beta_2$ , or both,  $\neq 0$ .

Analysis of -2 Log Likelihood Estimates

	-2 Log Likelihood	Chi-Square	DF	Pr > ChiSq
	239.8598	15.5649	2	4E-4

Iteration limit was reached without convergence.  
Validity of the model fit is questionable.

3. In the "Analysis of parameter Estimates" table, the coefficient estimate of variable charlson is 0.2876 and  $Pr > ChiSq = 5E-4 < 0.05$ , so  $\beta_1 = 0.287$  and charlson is a significant variable. The Hazard ratio can be interpreted as the predicted change in the hazard for a unit increase in the predictor. For variable charlson, **Hazard ratio**=1.333, meaning that the hazard becomes 1.333 times when charlson increments one unit. Similarly, **tkt\_v** is a significant variable. The coefficient estimates of **tkt\_v**  $\beta_2 = -0.837$  and hazard ratio=0.433. We know the hazard function:  $h(t,x) = h_0(t) * \exp(0.2876 * charlson - 0.837 * tkt_v)$ .

Analysis of parameter estimates

	DF	Estimate	Standard Error	Chi-Square	Pr > ChiSq	Hazard Ratio
"charlson"	1	0.2876	0.0827	12.0856	5E-4	1.3333
"tkt_v"	1	-0.837	0.3445	5.9032	0.0151	0.433

4. The Survival function plot shows the proportion of individuals surviving at each hour and is a visual display of the model-predicted. The horizontal axis shows the time to event. The vertical axis shows the probability of survival.

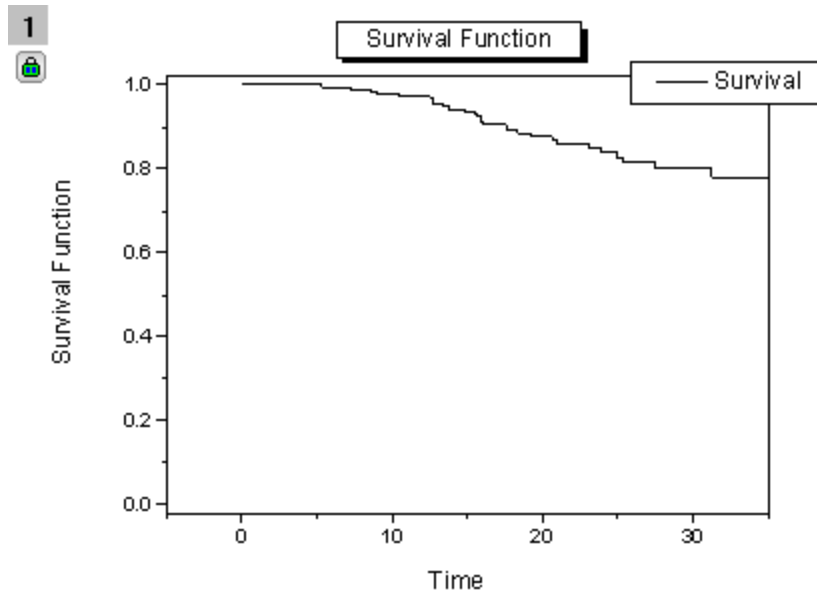

5. The Hazard function plot displays the instantaneous probability of the given event occurring at any point in time.

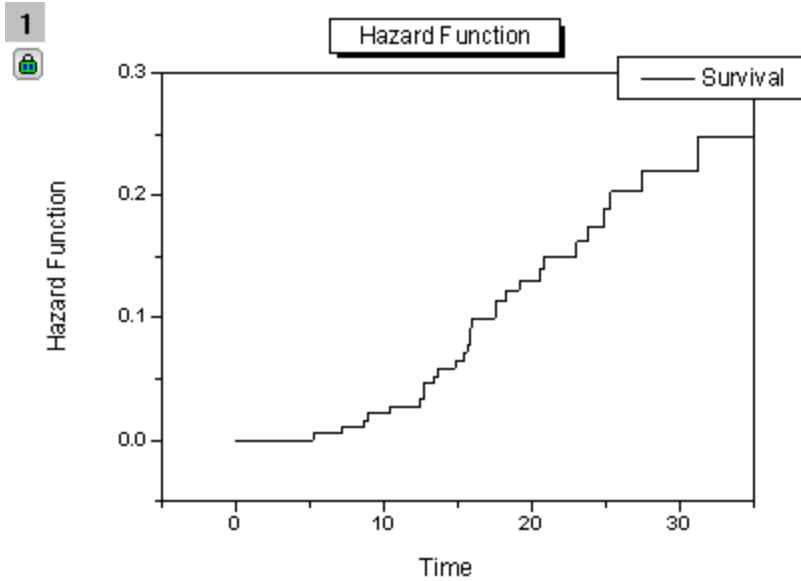

### 5.6.4 Weibull Fit

#### 5.6.4.1 Summary

Weibull fit is a kind of parameter method to analyze the relationship between the survival function and failure time. After analysis, we can get parameter estimates, which can determine survival function and hazard function of Weibull distribution .

Weibull distribution:

$$f(x) = \frac{c}{\sigma} \left( \frac{x - \theta}{\sigma} \right)^{c-1} \exp\left(- \left( \frac{x - \theta}{\sigma} \right)^c\right) \text{ where } x > \theta, \text{ for } c, \sigma > 0$$

Survival function:

$$S(x) = \exp\left(- \left( \frac{x - \theta}{\sigma} \right)^c\right)$$

Hazard function:

$$h(x) = \frac{c}{\sigma} \left( \frac{x - \theta}{\sigma} \right)^{c-1}$$

where  $c$  is the shape parameter,  $\sigma$  is the scale parameter, and  $\theta$  is the location parameter. In Origin, Weibull fit only discusses  $c$  and  $\sigma$ , and assumes  $\theta = 0$ .

If  $c > 1$  the hazard increases , if  $c = 1$  the hazard is constant(exponential model), if  $c < 1$  the hazard decreases.

Minimum Origin Version Required: OriginPro 9.1 SR0

#### 5.6.4.2 What you will learn

This tutorial will show you how to:

- Perform Weibull Fit
- How to explain analysis report

### 5.6.4.3 Perform Weibull Fit

1. Click the Import Single ASCII button  to import **weibull fit.dat** located in the **\Samples \Statistics** subfolder.
2. Select **Statistics: Survival Analysis: weibull fit** to open the dialog.
3. Put the **A(X)** column into **Time Range**. Similarly, put the **B(Y)** column into **Censor Range**.
4. Select **0** as the censoring value form censoring value(s) drop-down list.
5. Expand **Plots** branch and check **Survival Plot** and **Hazard Plot**.

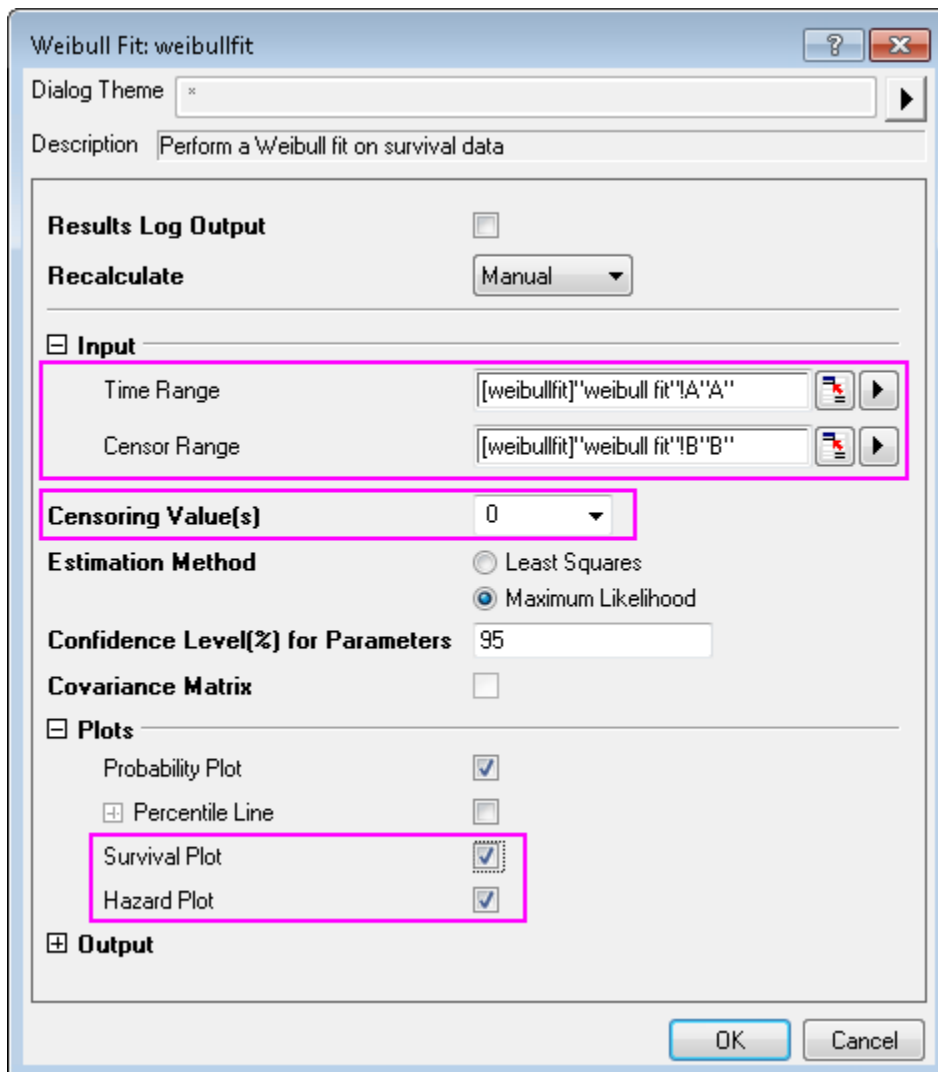

6. Click the **OK** button to perform the Weibull fit analysis.

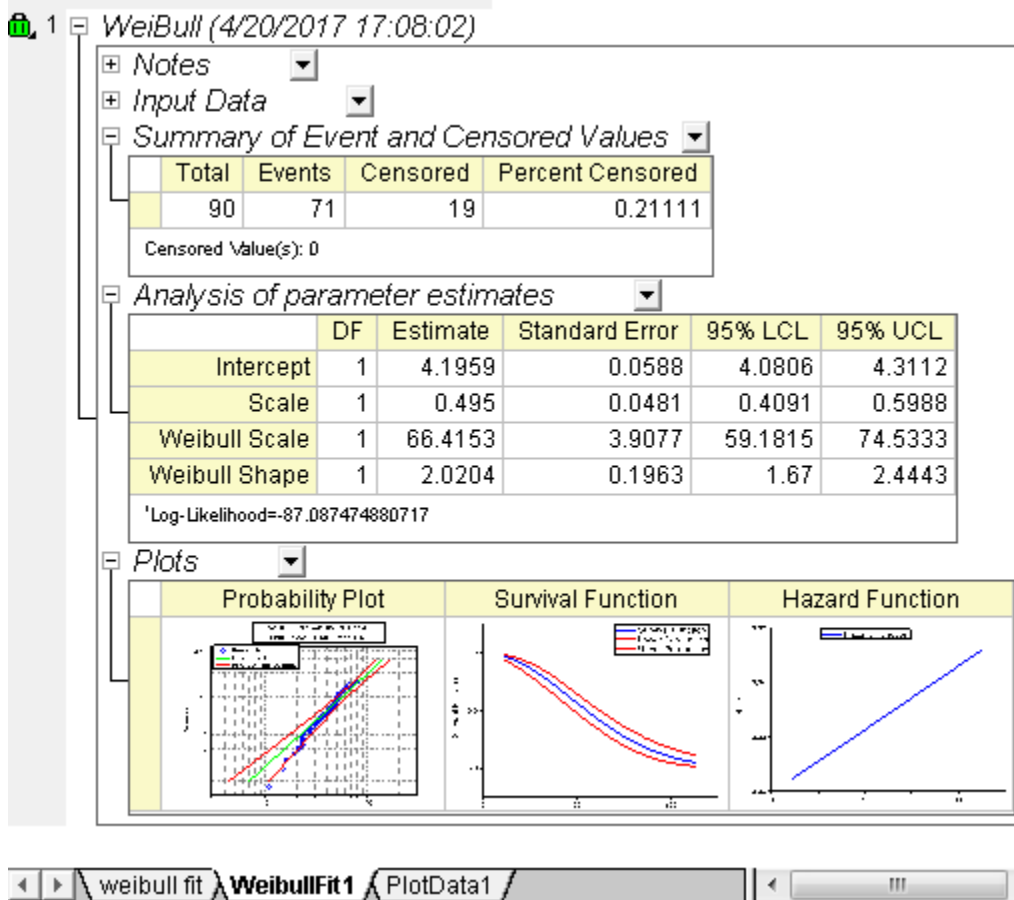

#### 5.6.4.4 Interpreting the Result

Go to worksheet **WeibullFit1** for the analysis report.

- From the "Summary of Event and Censored Values" table , we can see that **censored** =19 and **percent Censored** =0.2111.

Summary of Event and Censored Values

Total	Events	Censored	Percent Censored
90	71	19	0.21111

Censored Value(s): 0

- From the "Analysis of parameter estimates", we can get all parameter estimates for Weibull distribution.  
 Intercept= $\theta$ =4.1959, ( $\theta$  is the intercept of the small extreme distribution,  $\theta = \ln(\text{Weibull Scale})$ )  
 Weibull Scale=  $\sigma$  =66.4153,  
 Weibull Shape= $c$ =2.0204,  
 Scale =0.495 (scale = 1/c).

Analysis of parameter estimates

	DF	Estimate	Standard Error	95% LCL	95% UCL
Intercept	1	4.1959	0.0588	4.0806	4.3112
Scale	1	0.495	0.0481	0.4091	0.5988
Weibull Scale	1	66.4153	3.9077	59.1815	74.5333
Weibull Shape	1	2.0204	0.1963	1.67	2.4443

'Log-Likelihood=-87.087474880717

$c > 1$ , so we can conclude that the hazard increases as time.

- Furthermore, we can get the survival function and hazard function:

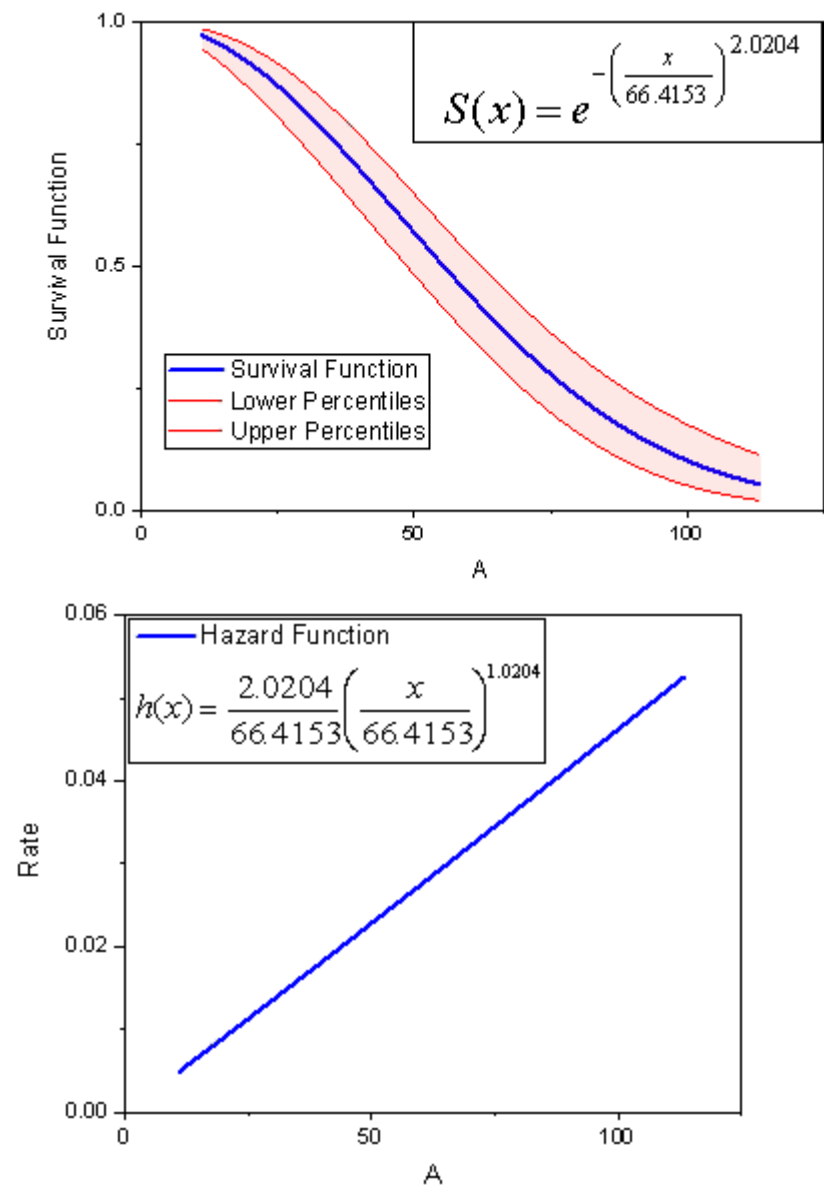



## 5.7 Multivariate Analysis

### 5.7.1 Multivariate Analysis

- [Principal Component Analysis](#)
- [Cluster Analysis](#)
- [Discriminant Analysis](#)
- [Partial Least Squares](#)

### 5.7.2 Principal Component Analysis

#### 5.7.2.1 Summary

Principal Component Analysis is useful for reducing and interpreting large multivariate data sets with underlying linear structures, and for discovering previously unsuspected relationships.

We will start with data measuring protein consumption in twenty-five European countries for nine food groups. Using Principal Component Analysis, we will examine the relationship between protein sources and these European countries.

#### 5.7.2.2 Selecting Principal Methods

To determine the number of principal components to be retained, we should first run Principal Component Analysis and then proceed based on its result:

1. Open a new project or a new workbook. Import the data file `\samples\Statistics\Protein Consumption in Europe.dat`
2. Select the entire worksheet and then select **Statistics: Multivariate Analysis: Principal Component Analysis**.
3. Accept the default settings in the open dialog box and click **OK**.
4. Select sheet **PCA Report**.
5. In the **Eigenvalues of the Correlation Matrix** table, we can see that the first four principal components explain 86% of the variance and the remaining components each contribute 5% or less. We will keep four main components.

Eigenvalues of the Correlation Matrix			
	Eigenvalue	Percentage of Variance	Cumulative
1	4.00644	44.52%	44.52%
2	1.635	18.17%	62.68%
3	1.12792	12.53%	75.22%
4	0.95466	10.61%	85.82%
5	0.46384	5.15%	90.98%
6	0.32513	3.61%	94.59%
7	0.27161	3.02%	97.61%
8	0.11629	1.29%	98.90%
9	0.09911	1.10%	100.00%

- A scree plot can be a useful visual aid for determining the appropriate number of principal components. The number of components depends on the "elbow" point at which the remaining eigenvalues are relatively small and all about the same size. This point is not very evident in the scree plot, but we can still say the fourth point is our "elbow" point.

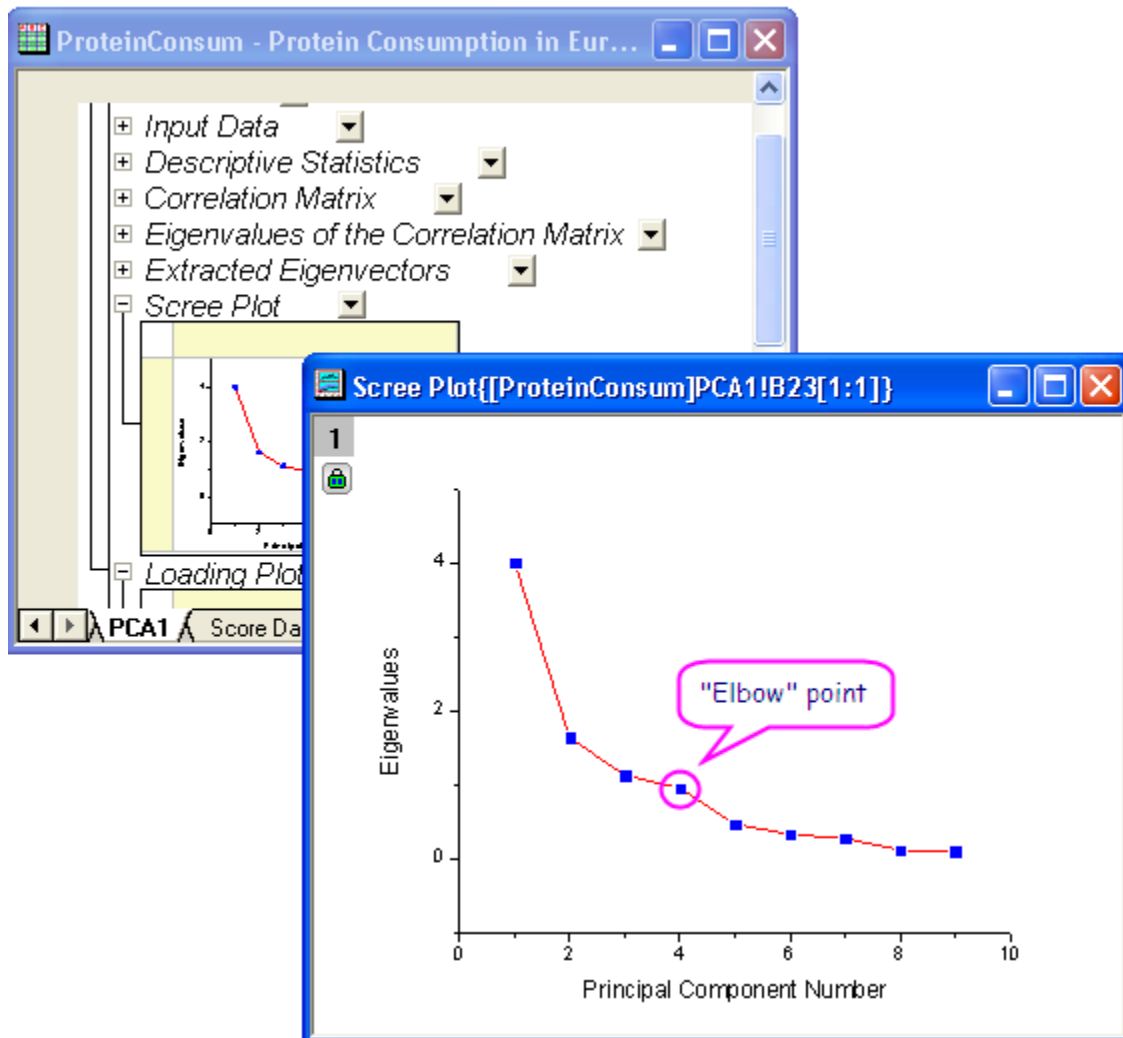

- Click the lock icon  in the results tree and select **Change Parameters** in the context menu. In the **Settings** tab, set **Number of Components to Extract** to **4**. Do not close the dialog; in the next steps, we will retrieve component diagrams.

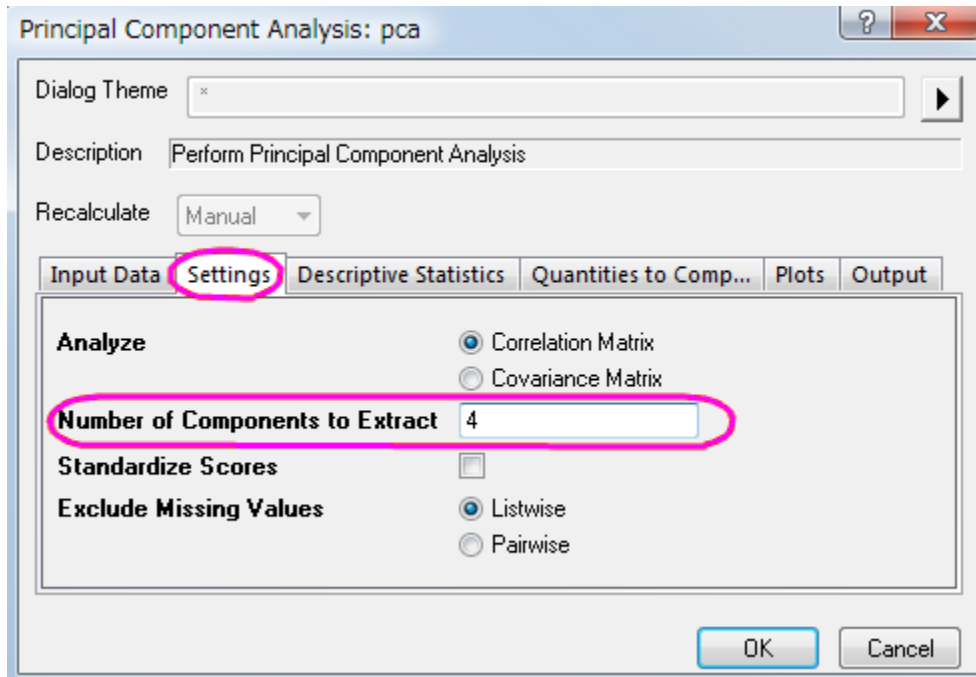

### 5.7.2.3 Request Principal Component Plots

In the **Plots** tab of the dialog, users can choose whether they want to create a scree plot or a component diagram.

- **Scree Plot**

The **scree plot** is a useful visual aid for determining an appropriate number of principal components.

- **Component Plot**

Component plots show the component score of each observation or component loading of each variable for a pair of principal components. In the **Select Principal Components to Plot** group, users can specify which pair of components to plot. The component plots include:

- **Loading Plot**

The **loading plot** is a plot of the relationship between the original variables and the subspace dimension. It is used to interpret relationships between variables.

- **Score Plot**

The **score plot** is a projection of data onto subspace. It is used to interpret relationships between observations.

- **BiPlot**

The **biplot** shows both the loadings and the scores for two selected components in parallel.

1. In the dialog that was opened in the preceding steps, select the **Plots** tab. Make sure **Scree Plot**, **Loading Plot**, and **Biplot** are selected.
2. The first two components are usually responsible for the bulk of the variance. This is why we are going to plot the component plot in the space of the first two principal components. In the **Select Principal Components to Plot** group, set **Principal Component for X Axis** to **1**, and set **Principal Component for Y Axis** to **2**. Click **OK**.

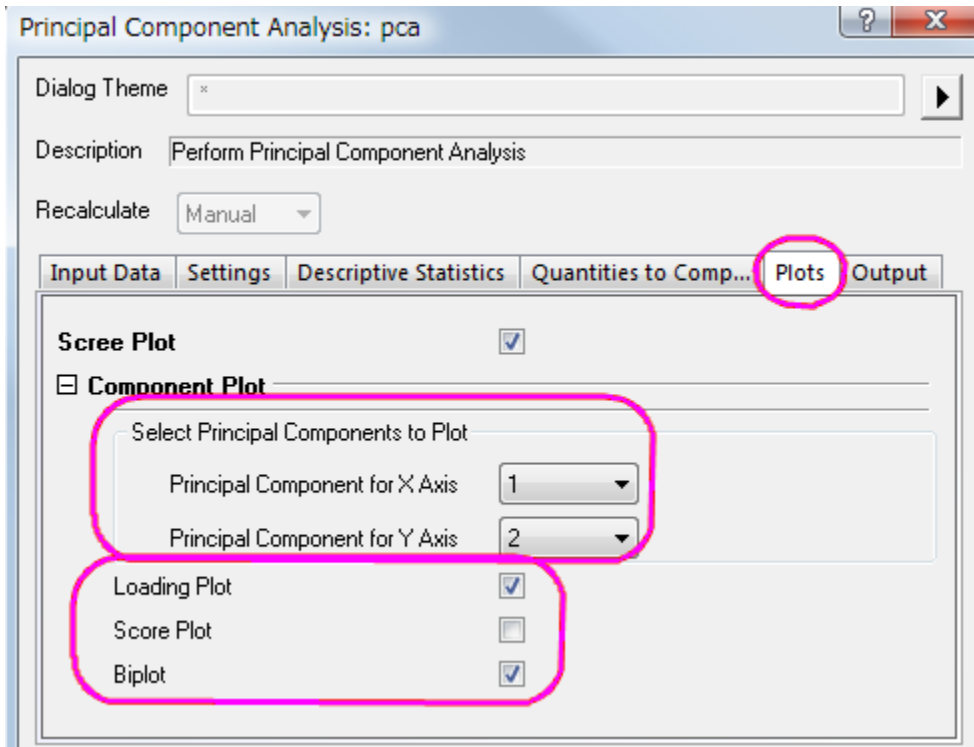

5.7.2.4 Interpreting The Results

1. In the **Correlation Matrix**, we can see that the variables are highly correlated. Many values are greater than **0.3**. Principal Component Analysis is an appropriate tool for removing the collinearity.

Correlation Matrix

	Red Meat	White Meat	Eggs	Milk	Fish	Cereals	Starch	Nuts	Fruits & Vegetables
Red Meat	1	0.153	0.58561	0.50293	0.06096	-0.49988	0.13543	-0.34945	-0.07422
White Meat	0.153	1	0.62041	0.28148	-0.23401	-0.4138	0.31377	-0.63496	-0.06132
Eggs	0.58561	0.62041	1	0.57553	0.06557	-0.71244	0.45223	-0.55978	-0.04552
Milk	0.50293	0.28148	0.57553	1	0.13788	-0.59274	0.22241	-0.62109	-0.40836
Fish	0.06096	-0.23401	0.06557	0.13788	1	-0.52423	0.40385	-0.14715	0.26614
Cereals	-0.49988	-0.4138	-0.71244	-0.59274	-0.52423	1	-0.53326	0.651	0.04655
Starch	0.13543	0.31377	0.45223	0.22241	0.40385	-0.53326	1	-0.47431	0.08441
Nuts	-0.34945	-0.63496	-0.55978	-0.62109	-0.14715	0.651	-0.47431	1	0.37497
Fruits & Vegetables	-0.07422	-0.06132	-0.04552	-0.40836	0.26614	0.04655	0.08441	0.37497	1

2. The main component variables are defined as linear combinations of the original variables. The **Extracted Eigenvectors** table provides coefficients for equations.

Extracted Eigenvectors				
	Coefficients of PC1	Coefficients of PC2	Coefficients of PC3	Coefficients of PC4
Red Meat	0.30261	-0.05625	-0.29758	0.64648
White Meat	0.31056	-0.23685	0.6239	-0.03699
Eggs	0.42668	-0.03534	0.18153	0.31316
Milk	0.37773	-0.18459	-0.38566	-0.00332
Fish	0.13565	0.64682	-0.32127	-0.21596
Cereals	-0.43774	-0.23349	0.09592	-0.0062
Starch	0.29725	0.35283	0.24298	-0.33668
Nuts	-0.42033	0.14331	-0.05439	0.33029
Fruits & Vegetables	-0.11042	0.53619	0.40756	0.46206

$$PC1 = 0.30261 * RedMeat + 0.31056 * WhiteMeat + 0.42668 * Eggs + 0.37773 * Milk + 0.13565 * Fish - 0.43774 * Cereals + 0.29725 * Starch - 0.42033 * Nuts - 0.11042 * FruitsVegetables$$

$$PC2 = -0.05625 * RedMeat - 0.23685 * WhiteMeat - 0.03534 * Eggs - 0.18459 * Milk + 0.64682 * Fish - 0.23349 * Cereals + 0.35283 * Starch + 0.14331 * Nuts + 0.53619 * FruitsVegetables$$

$$PC3 = -0.29758 * RedMeat + 0.6239 * WhiteMeat + 0.18153 * Eggs - 0.38566 * Milk - 0.32127 * Fish + 0.09592 * Cereals + 0.24298 * Starch - 0.05439 * Nuts + 0.40756 * FruitsVegetables$$

$$PC4 = 0.64648 * RedMeat - 0.03699 * WhiteMeat + 0.31316 * Eggs - 0.00332 * Milk - 0.21596 * Fish - 0.0062 * Cereals - 0.33668 * Starch + 0.33029 * Nuts + 0.46206 * FruitsVegetables$$

3. The **Loading Plot** reveals the relationships between variables in the space of the first two components. In the loading plot, we can see that Red Meat, Eggs, Milk, and White Meat have similar heavy loadings for principal component 1. Fish, fruit, and vegetables, however, have similar heavy loadings for principal component 2.

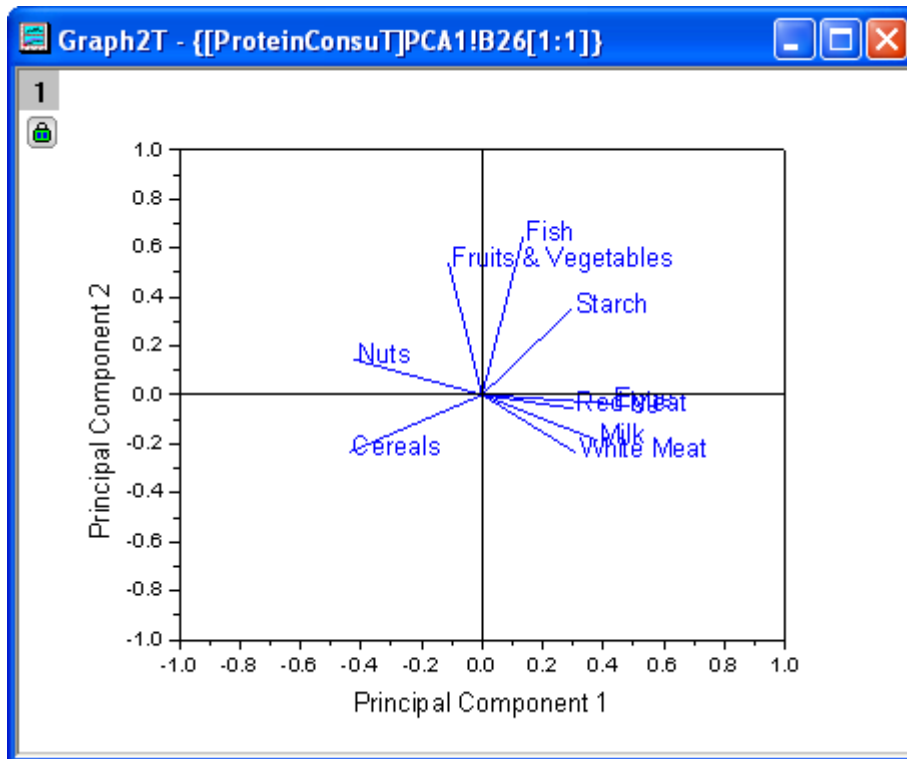

- The **biplot** shows both the loadings and the score for two selected components in parallel. It can reveal the projection of an observation on the subspace with the score points. It can also find the ratio of observations and variables in the subspace of the first two components. (Note: Double-click the graph to open and customize.)

- Use the Data Reader tool  to open the Data Info window and examine the plot in greater detail. We can see that Spain and Portugal's protein sources differ from those of other European countries. Spain and Portugal rely on fruits and vegetables, while eastern European countries such as Albania, Bulgaria, Yugoslavia, and Romania prefer cereals and nuts.

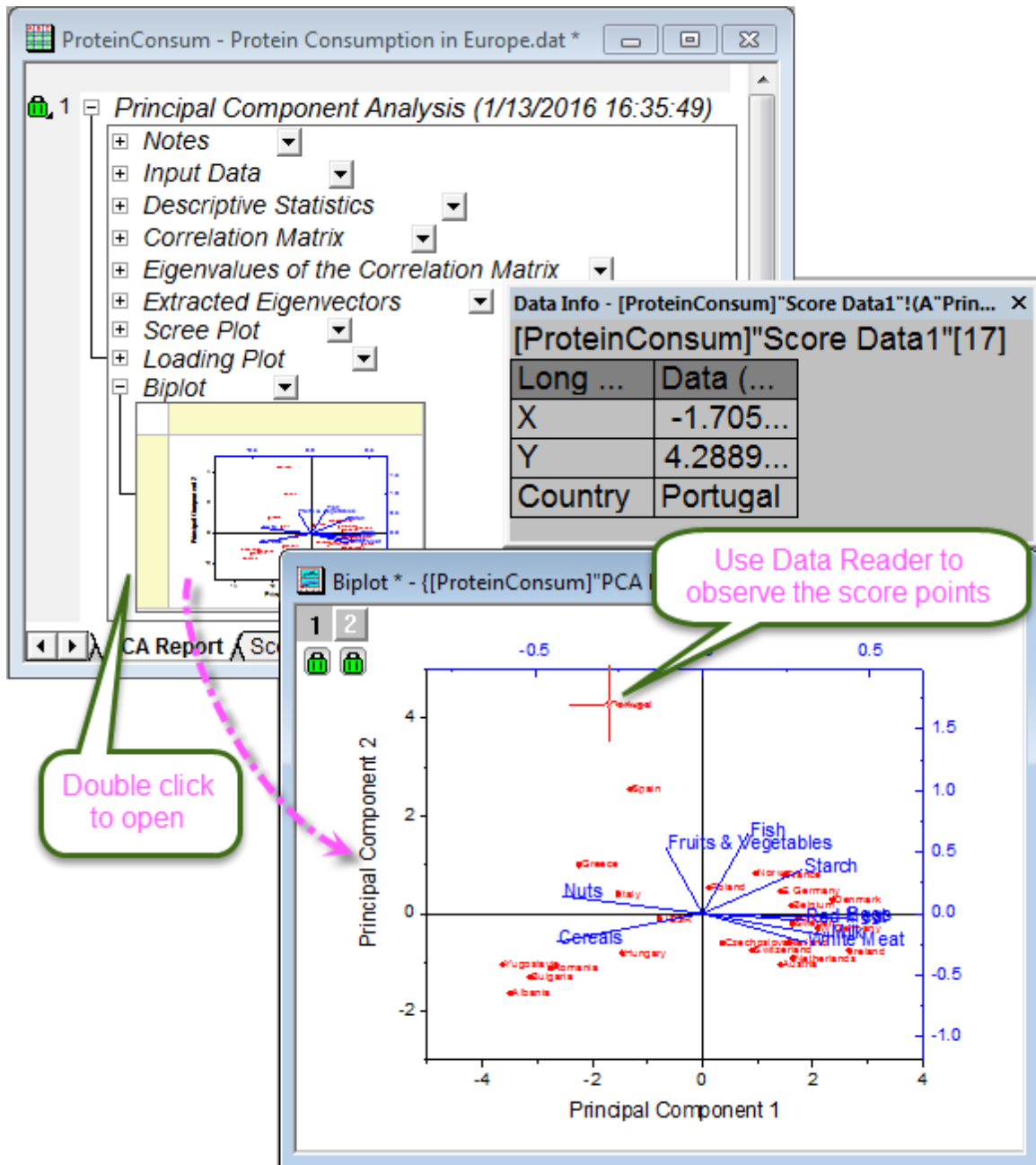

To display country information in the **Data Info** window, as in the image above:

1. Right-click the **Data Info** window and select **Preferences...**
2. In the **Rows** tab, move **Country** from the left panel to the right. Click **OK**.

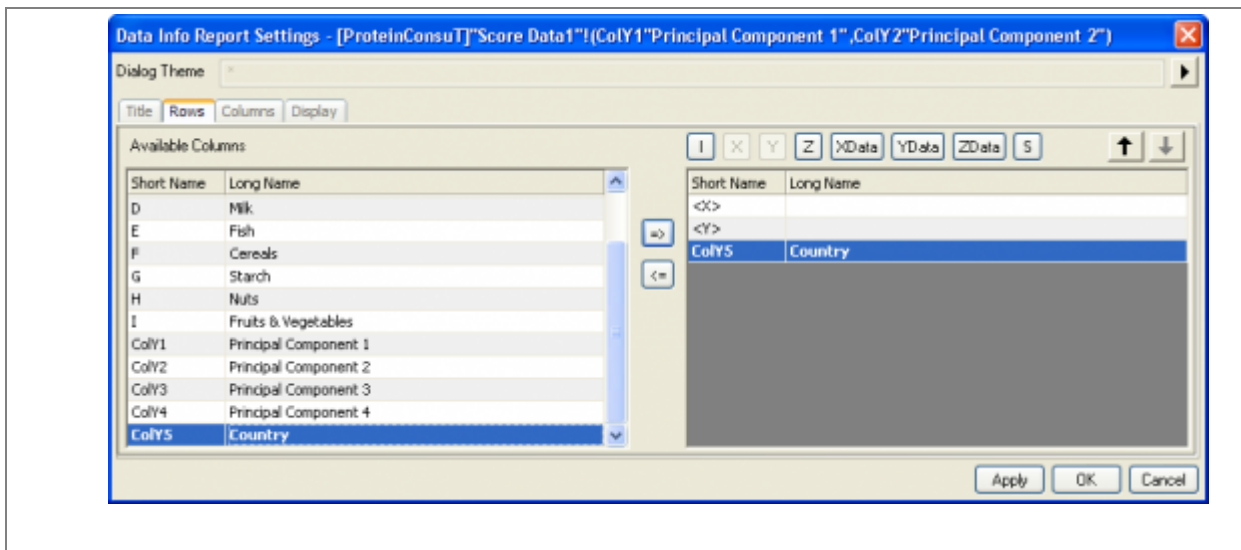

To create an arbitrary 3D loading plot, such as PC1-PC2-PC4 or PC1-PC3-PC5 loading plot:

1. Click the lock icon  in the results tree and select **Change Parameters** in the context menu. In the **Settings** tab, set **Number of Components to Extract** as needed. For example, if you want to do a PC1-PC2-PC4 loading plot, **Number of Components to Extract** should be set as **4**. Click **OK** to close the dialog.
2. The **Extracted Eigenvectors** table now has 4 columns. To duplicate the sheet *PCA Plot Data1*, select the sheet *PCA Plot Data1* tab and right click to select **Duplicate**. Then rename the new sheet as sheet *PCA Plot Data2*.
3. Right click on the Workbook title bar and select **Properties...** from the context menu to open the dialog. In the **Window Properties** dialog, uncheck **Spreadsheet Cell Notation** box. Click **OK** to close the dialog.
4. Suppose you want to plot a PC1-PC2-PC4 loading plot. Activate the sheet *PCA Plot Data2*, highlight **Col (E)** and right click to insert a column ahead of **Col (E)**. Insert a column ahead of **Col (G)**. Highlight two new columns and right click to select **Set as: Z**.
5. Rename the long name of **Col (H1)** and **Col (I1)** as **Principal Component 4**. Set the all the **Eigenvalue** of **Col (H1)** as **0**.
6. Go to sheet *PCA1*, copy the **Coefficients of PC4** in the **Extracted Eigenvectors** table and paste it into **Col (I1)** of sheet *PCA Plot Data2*.
7. Highlight **Col (C)** to **Col (I1)** and select **Plot>3D: Vector: 3D Vector XYZ XYZ**.
8. You can also customize the Plot by changing vector color and adding label. Double click to enter **Plot Detail** dialog and then go to **Original** level. Select **3D Vector** tab, change **Color** as **Blue** and **Width** as **4**; Go to **Label** tab and customize **Label From: Col(G)**, **Position: Right**, **Size: 20** and **Attach to: Arrow Head**. Click **OK** to close the dialog. The 3D loading plot will be created as follow.



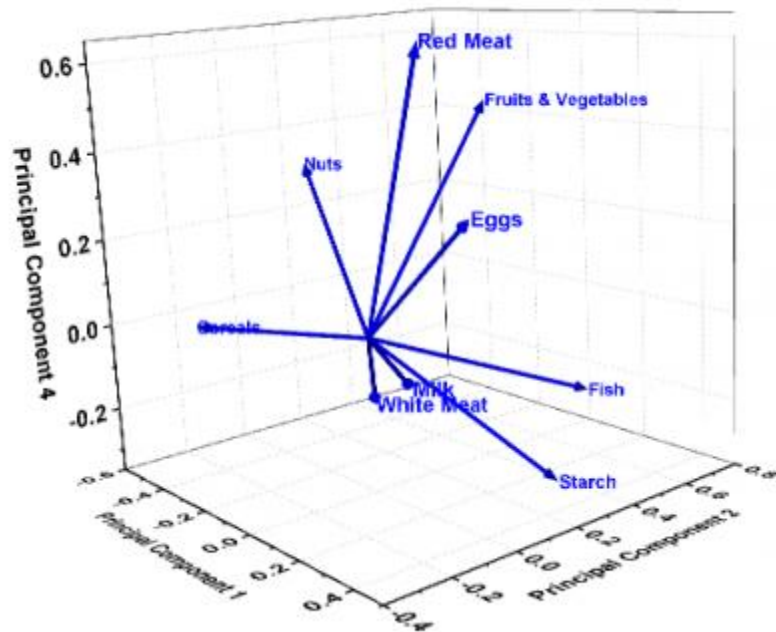

### 5.7.3 Cluster Analysis

#### 5.7.3.1 Summary

We will perform cluster analysis for the mean temperatures of US cities over a 3-year-period.

The starting point is a hierarchical cluster analysis with randomly selected data in order to find the best method for clustering. K-means analysis, a quick cluster method, is then performed on the entire original dataset.

Minimum Origin Version Required: OriginPro 8.6 SR0

#### 5.7.3.2 Hierarchical Cluster Analysis

1. Start with a new project or a new workbook. Import the data file **\Samples\Graphing\US Mean Temperature.dat**.
2. Highlight Column D through Column O.
3. Select **Statistics: Multivariate Analysis: Hierarchical Cluster Analysis**.
4. Select **Input** tab, click the **triangle button**  next to **Variables**, and then click **Select Columns...** in the context menu.

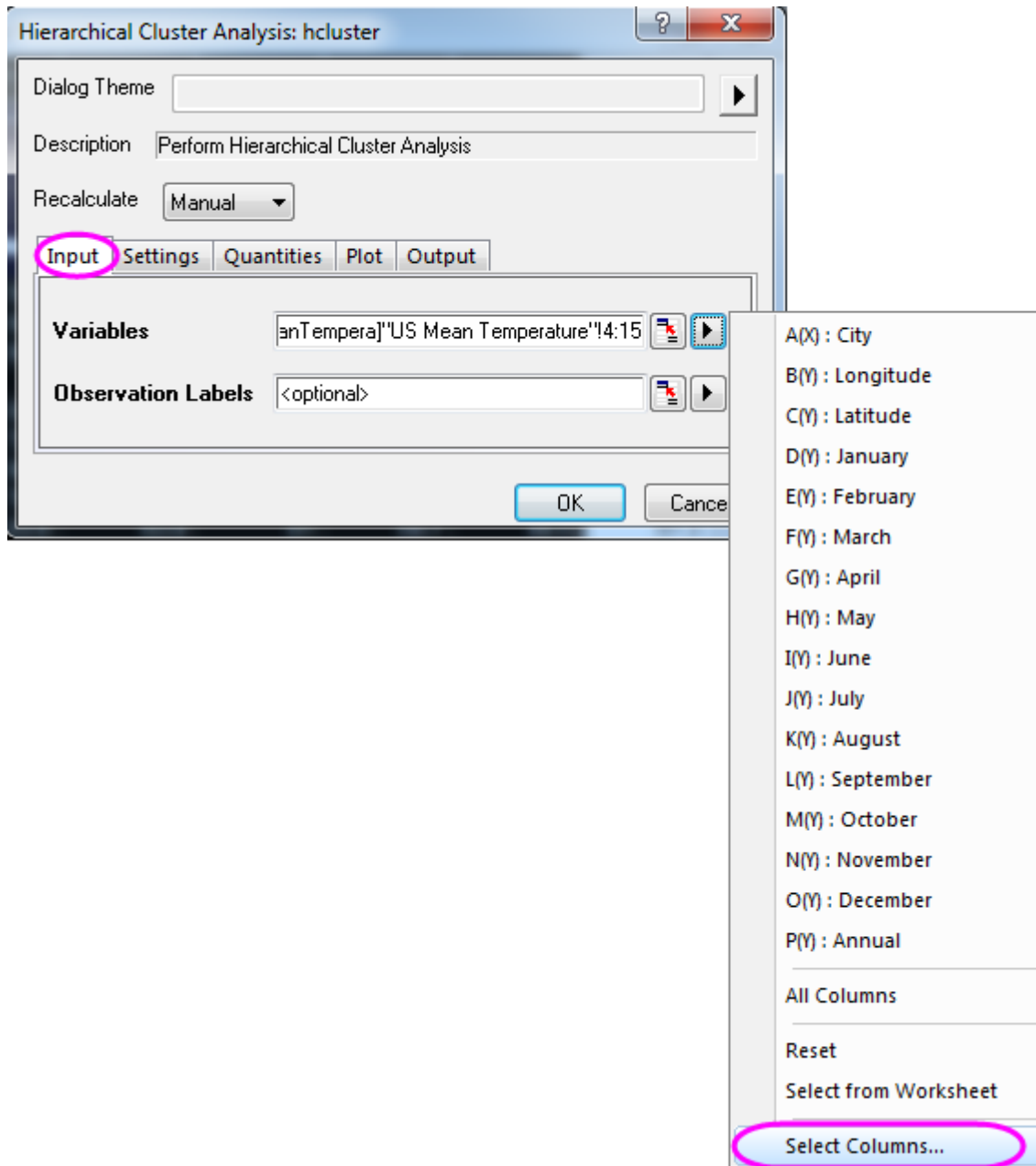

5. In the lower panel of the Column Browser dialog, click the ... button. Set the data range from **1** to **100**. Click **OK**.

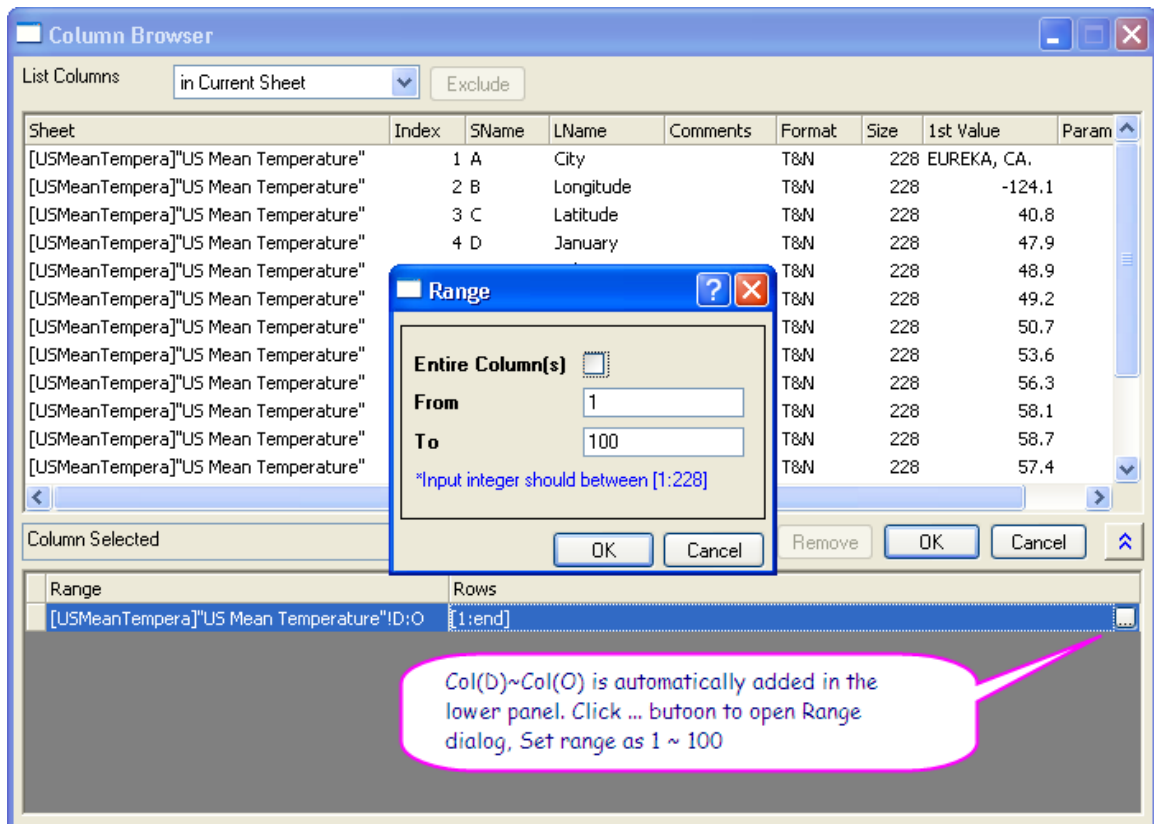

- In the dialog, go to **Settings** tab, make sure **Cluster** is set to **Observations**, and **Number of Clusters** is **1**. Select **Furthest Neighbor** for **Cluster Method** and then click **OK**.

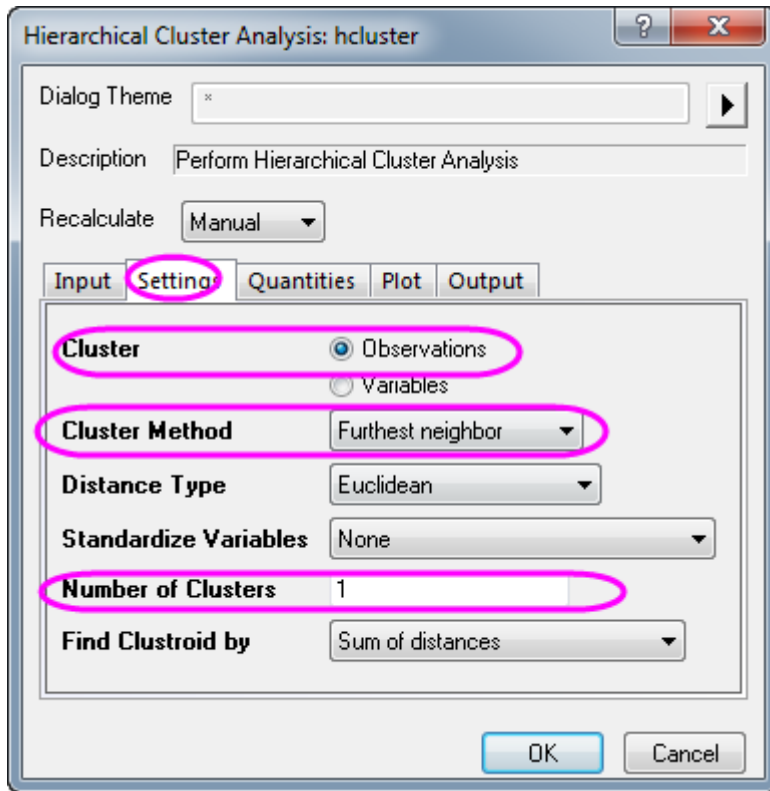

7. Go to the **Cluster 1** sheet. Based on the resulting dendrogram, we choose to cluster data into 5 groups.

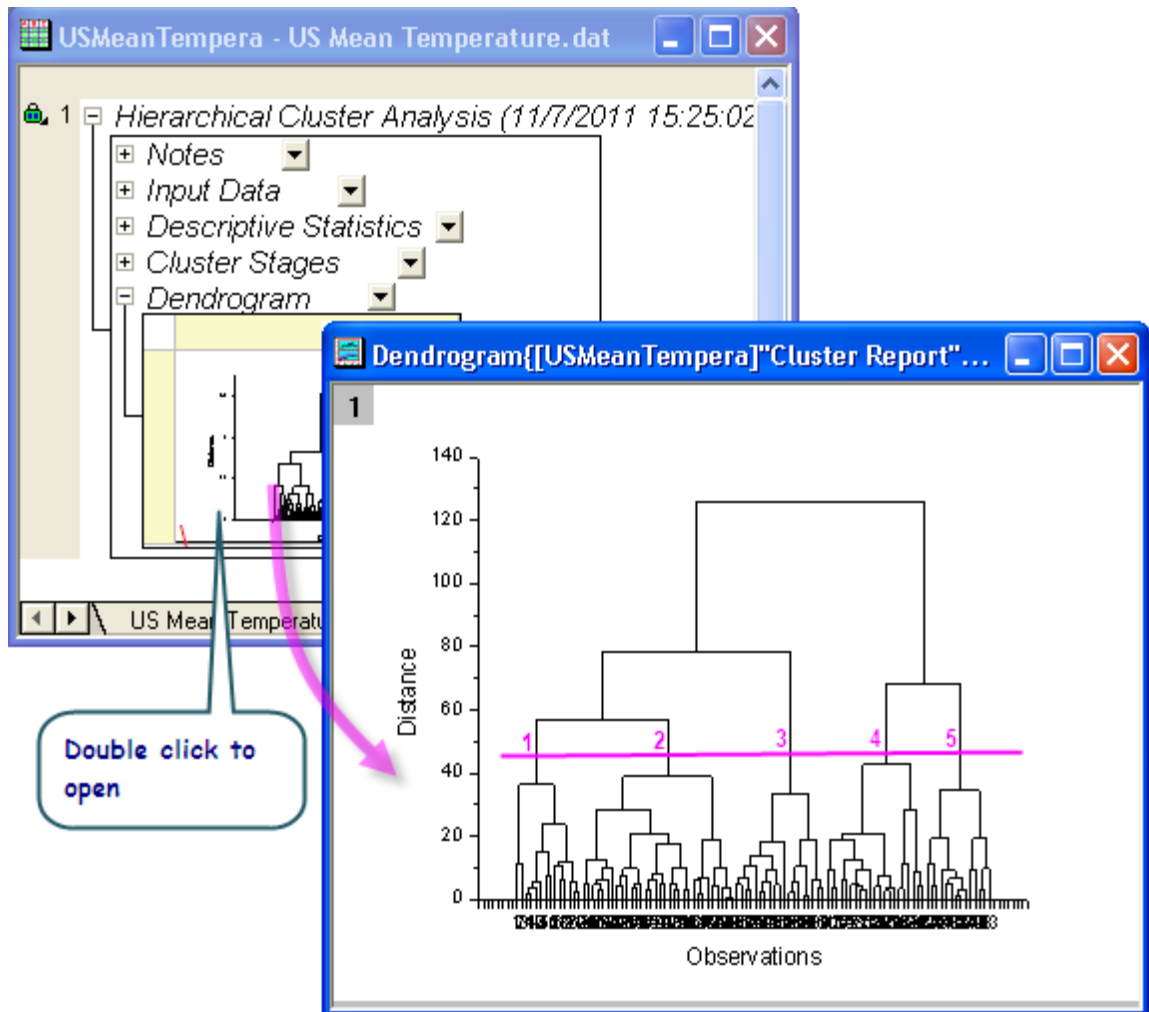

8. Click the lock icon in the dendrogram or the result tree, and then click **Change Parameters** in the context menu.
9. Set **Number of Clusters** to **5** in the **Settings** tab and then select the **Cluster Center** check box in the **Quantities** tab. Click **OK**.

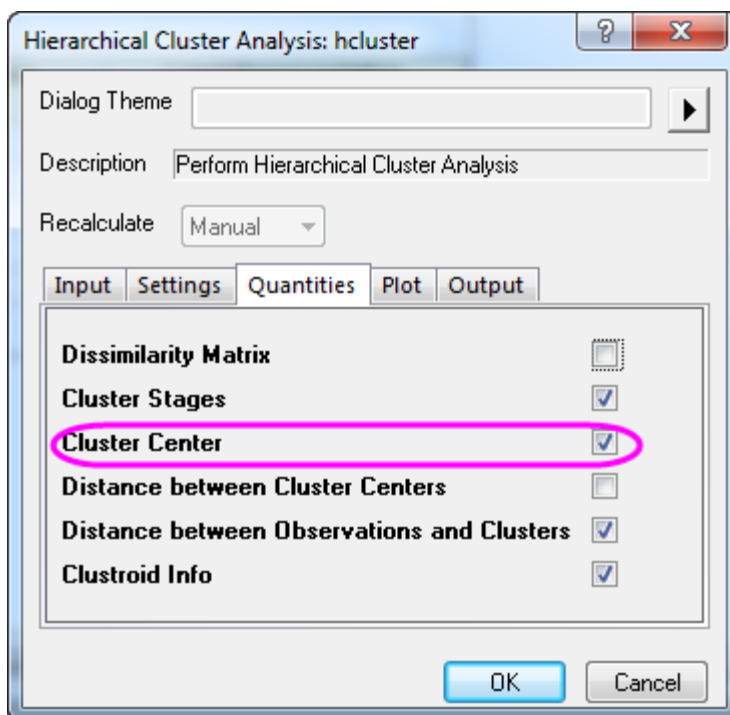
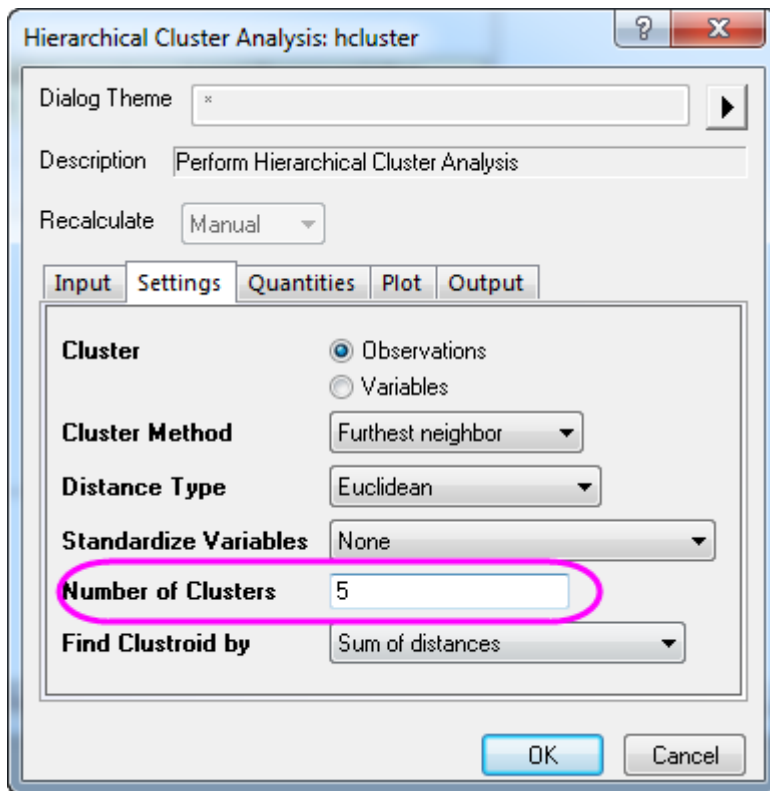

10. In the resulting dendrogram, we can clearly see how observations are clustered. (Note, you can double-click to open and customize the dendrogram.)

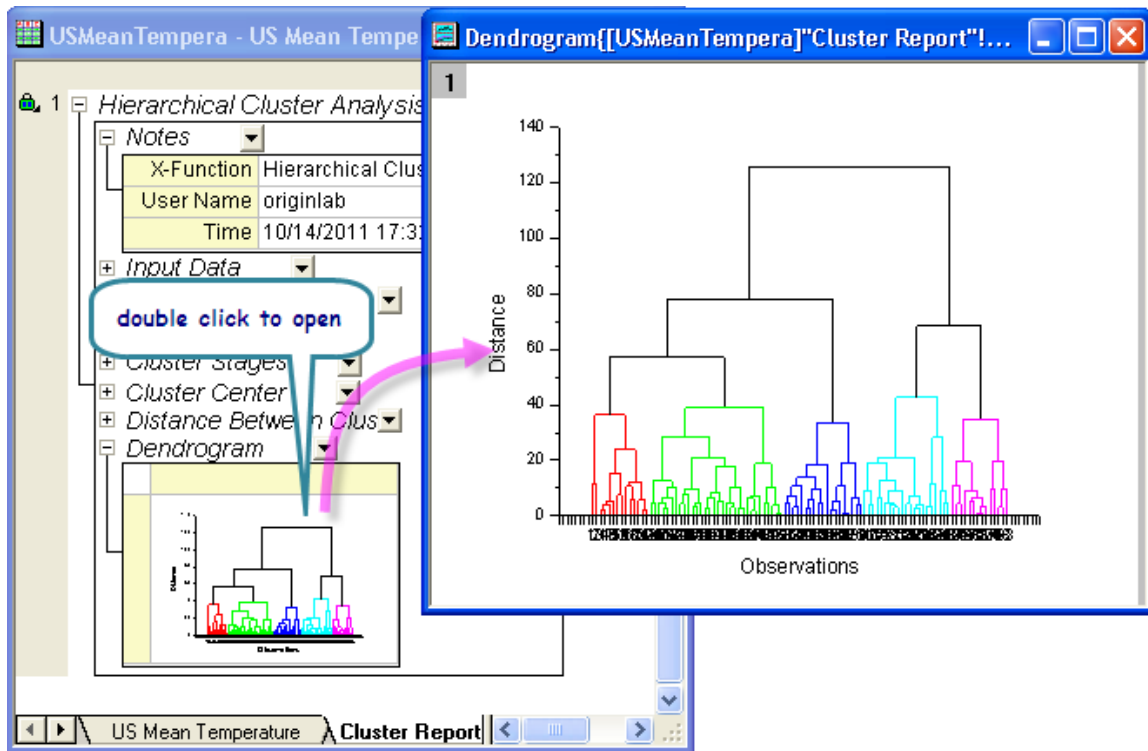

11. Due to the large number of observations, tick labels overlap in this dendrogram. Use the **Scale In**

 tool to select an area to magnify.

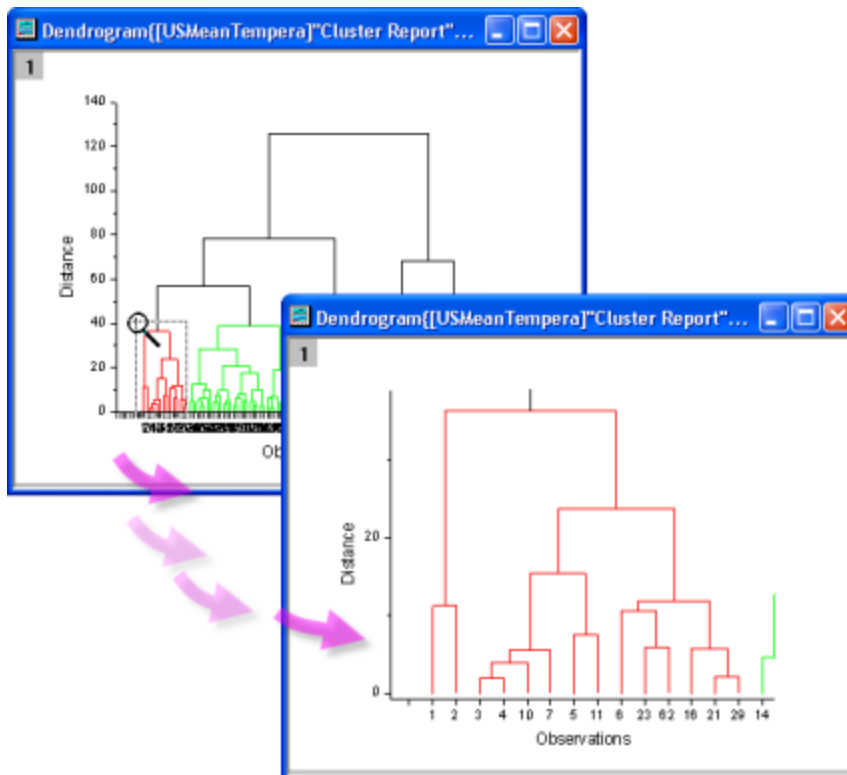





Note that beginning with Origin 2019b you will find, on the **Plot** tab of the **hcluster** dialog, a radio button for displaying **Similarity** on the Y axis of your Dendrogram (**Distance** is still default).

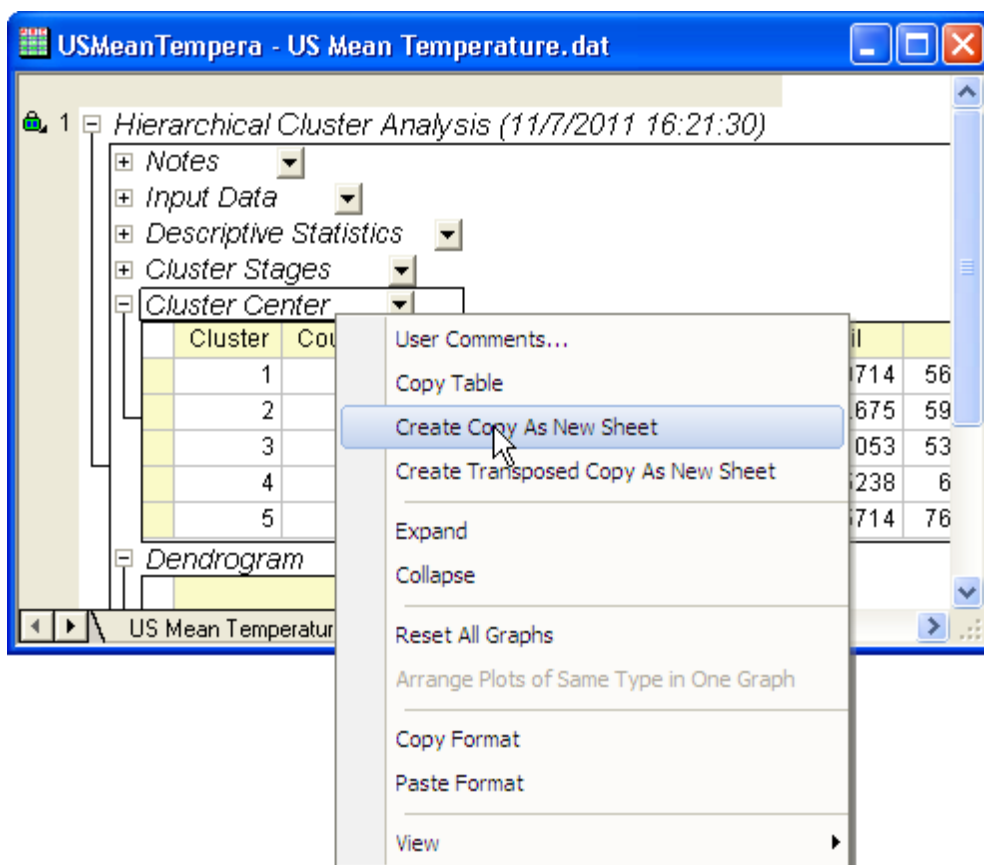

### 5.7.3.3 Analyzing Original Data with K-Means Cluster

1. Right-click on **Cluster Center** and select **Create Copy as New Sheet** in the context menu. We are going to use the newly created **Cluster Center** as the **Initial Cluster Centers** in our k-means cluster analysis.



2. Go back to the worksheet with the source data (US Mean Temperature), and highlight col(D) through col(O). Select **Statistics: Multivariate Analysis: K-Means Cluster Analysis**.
3. Select the **Specify Initial Cluster Centers** check box in the **Options** tab. Click the **interactive button**  next to **Initial Cluster Centers**. The dialog will "roll up".
4. Go to **Cluster Center** and highlight Col(D) through Col(O). Click the button on the rolled-up dialog to restore the dialog.



- In the **Plot** tab, select **Group Graph**. Click the **interactive button**  next to **X Range**. The dialog will "roll up". Go back to the source worksheet **US Mean Temperature**, and highlight **Col(B):Longitude**. Click the button in the rolled up dialog to restore.
- Click the **triangle button**  next to **Y Range**, and then select **C(Y), Latitude**. Click **OK**.

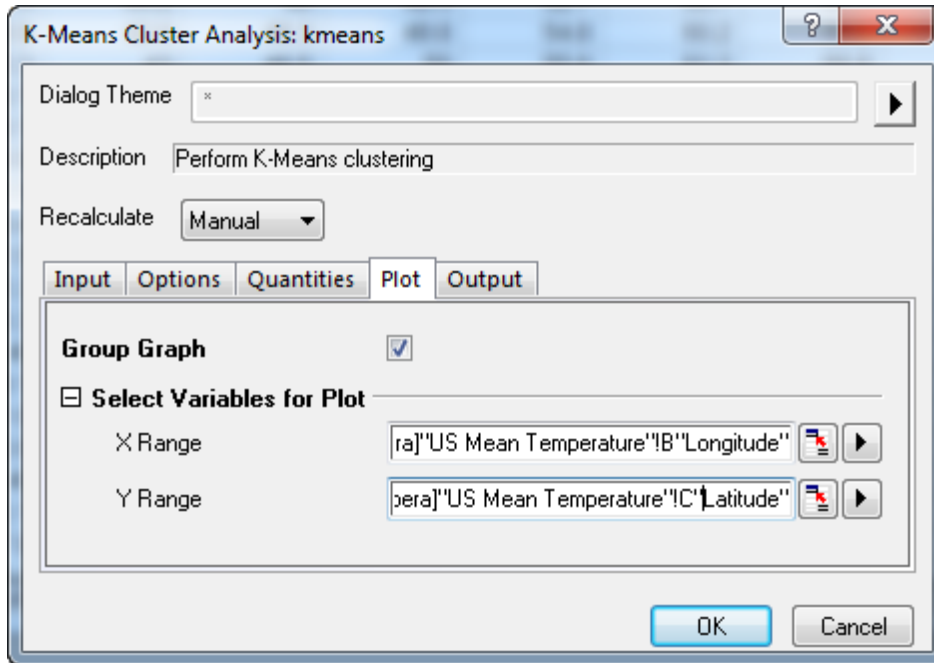

- Activate the worksheet **K-Means Plot Data1**. Observe that data has been clustered into 5 groups corresponding to the latitudes of the cities.

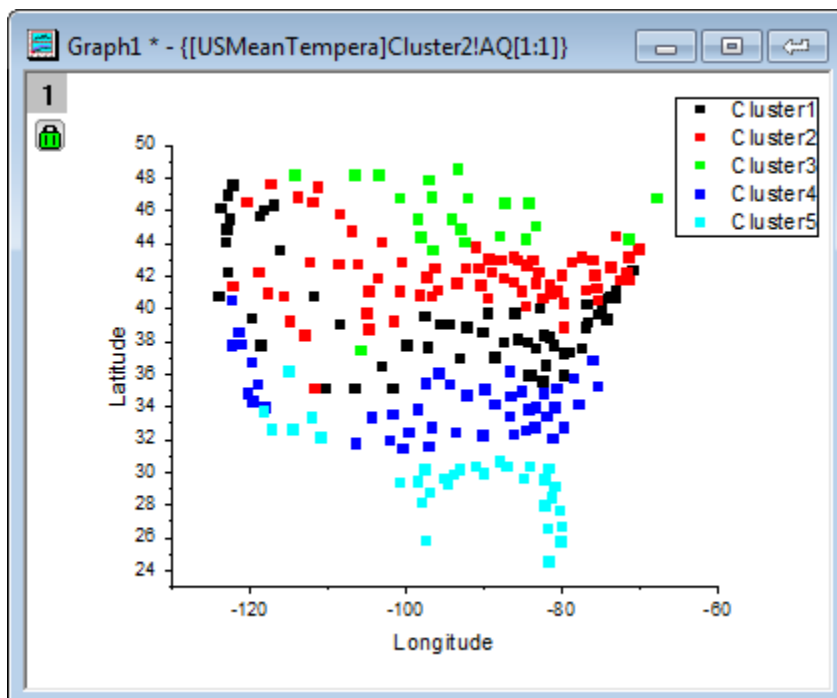



User can also select the output destination of **Cluster Membership** column, such as next to input data, for further operation if needed

The screenshot shows the 'K-Means Cluster Analysis: kmeans' dialog box with the 'Output' tab selected. The 'Cluster Membership' field is highlighted with a pink box and contains the text '[USMeanTemper1]US Mean Temperature!'. A pink arrow points from this field to the 'Membership' column in the spreadsheet behind it. The spreadsheet has columns M(Y2), N(Y2), O(Y2), P(Y2), and Q(X3). The 'Membership' column contains values 3, 3, 3, 3, 3, 3, 1, 1, 3, 1, 3, 1, 3, 1, 3, 1, 3, 1, 3, 1.

## 5.7.4 Discriminant Analysis

### 5.7.4.1 Summary

The Iris flower data set, or Fisher's Iris dataset, is a multivariate dataset introduced by Sir Ronald Aylmer Fisher in 1936. This dataset is often used for illustrative purposes in many classification systems. The dataset consists of fifty samples from each of three species of Irises (iris setosa, iris virginica, and iris versicolor). Four characteristics, the length and width of sepal and petal, are measured in centimeters for each sample. We can use discriminant analysis to identify the species based on these four characteristics.

We will use a random sample of 120 rows of data to create a discriminant analysis model, and then use the remaining 30 rows to verify the accuracy of the model.

Minimum Origin Version Required: OriginPro 8.6 SR0

### 5.7.4.2 Discriminant Analysis

1. Open a new project or a new workbook. Import the data file **\Samples\Statistics\Fisher's Iris Data.dat**
2. Highlight columns A through D. and then select **Statistics: Multivariate Analysis: Discriminant Analysis** to open the **Discriminant Analysis** dialog, **Input Data** tab. Columns A ~ D are automatically added as **Training Data**.

3. Click the **triangle button**  next to **Group for Training Data** and select **E(Y):Species** in the context menu

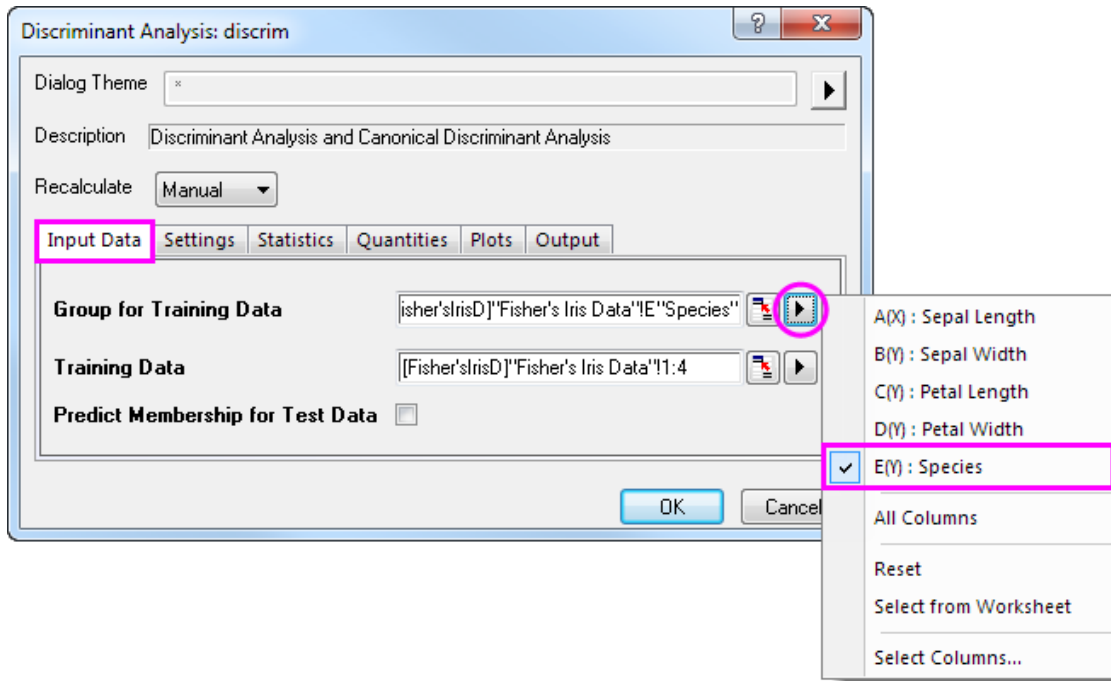

4. Click the **Quantities** tab and select the **Discriminant Function Coefficients** check box. Expand the **Canonical Discriminant Analysis** branch and select the **Canonical Coefficients** check box. Accept all other default settings and click **OK**

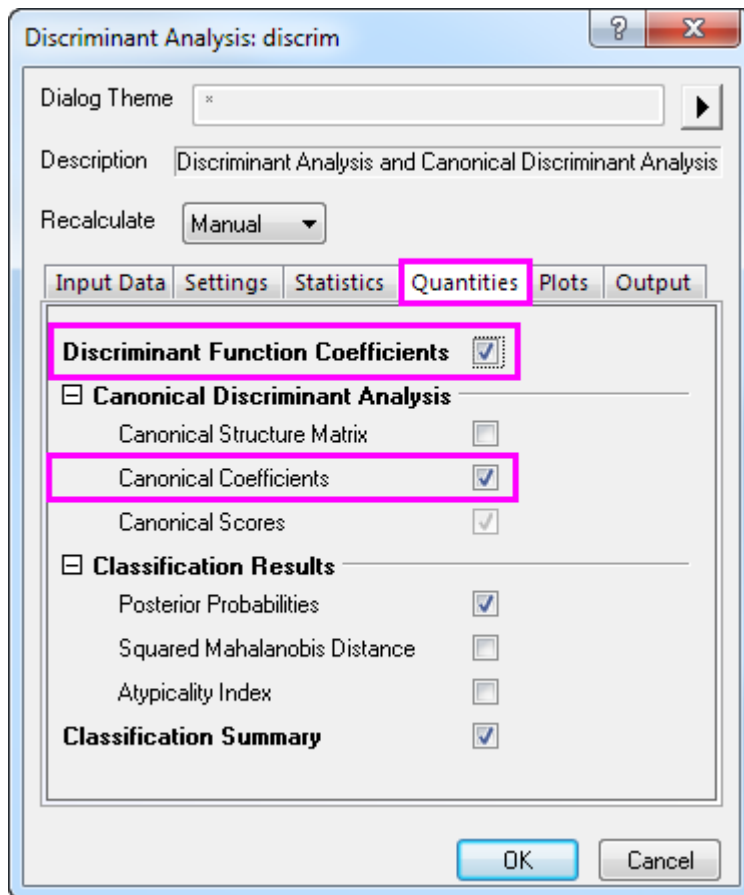

### 5.7.4.3 Interpreting Results

Click on the **Discriminant Analysis Report** tab.

#### 5.7.4.3.1 Canonical Discriminant Analysis

The **Canonical Discriminant Analysis** branch is used to create the discriminant functions for the model.

- Using the **Unstandardized Canonical Coefficient** table we can construct the canonical discriminant functions.

[-] *Unstandardized Canonical Coefficients* ▾

	Canonical Variable 1	Canonical Variable 2
Constant	-2.10511	-6.66147
Sepal Length	-0.82938	0.0241
Sepal Width	-1.53447	2.16452
Petal Length	2.20121	-0.93192
Petal Width	2.81046	2.83919

$$D1 = -2.10511 - 0.82938 * SL - 1.53447 * SW + 2.20121 * PL + 2.81046 * PW$$

$$D2 = -6.66147 + 0.0241 * SL + 2.16452 * SW - 0.93192 * PL + 2.83919 * PW$$

where SL = Sepal Length, SW = Sepal Width, PL = Petal Length, PW = Petal Width

- The Eigenvalues table reveals the importance of the above canonical discriminant functions. The first function can explain 99.12% of the variance, and the second can explain the remaining 0.88%.

Eigenvalues

	Eigenvalue	Percentage of Variance	Cumulative	Canonical Correlation
1	32.19193	99.12%	99.12%	0.98482
2	0.28539	0.88%	100.00%	0.4712

- The Wilk's Lambda Test table shows that the discriminant functions significantly explain the membership of the group. We can see that both values in the **Sig** column are smaller than 0.05. Both values should therefore be included in the discriminant analysis.

Wilks' Lambda Test

	Wilks' Lambda	Chi-square	df	Sig.
1 to 2	0.02344	546.1153	8	8.87078E-113
2 to 2	0.77797	36.52966	3	5.78605E-8

At the 0.05 level, the dimensionality is significantly 2.

### 5.7.4.3.2 Classification

- The **Classification Summary for Training Data** table can be used to evaluate the discriminant model. From the table we can see that the classification in the groups **setosa** is 100% correct. For **versicolor**, only two observations are mistakenly classified as virginica, and for **virginica**, only one is mistakenly classified. The error rate is only 2.00%. This model is good.

Classification Summary for Training Data

Classification Count

	Predicted Group			Total
	setosa	versicolor	virginica	
setosa	50	0	0	50
	100.00%	0.00%	0.00%	100.00%
versicolor	0	48	2	50
	0.00%	96.00%	4.00%	100.00%
virginica	0	1	49	50
	0.00%	2.00%	98.00%	100.00%
Total	50	49	51	150
	33.33%	32.67%	34.00%	100.00%

Error Rate

	setosa	versicolor	virginica	Total
Prior	0.33333	0.33333	0.33333	
Rate	0.00%	4.00%	2.00%	2.00%

Error rate for classification of training data is 2.00%.

2. You can further switch to the **Training Result1** sheet to see which observation is mistakenly classified. In the sheet we can see the post probabilities calculated from the discriminant model and which group the observation is assigned to.

	A(Y)	B(Y)	C(Y)	D(Y)
Long Name	Allocated to Group	Post Probabilities		
Units				
Comments	Classification			
F(x)=				
UserParam1		setosa	versicolor	virginica
79	versicolor	3.77353E-23	0.99252	0.00748
80	versicolor	9.55534E-12	1	1.91062E-8
81	versicolor	1.02211E-17	1	3.00775E-6
82	versicolor	9.64807E-16	1	3.2667E-7
83	versicolor	1.6164E-16	1	3.77844E-6
84	virginica*	4.24195E-32	0.14339	0.85661
85	versicolor	1.72451E-24	0.96356	0.03644
86	versicolor	1.34475E-20	0.99404	0.00596
87	versicolor	3.30487E-21	0.99822	0.00178
88	versicolor	2.03457E-23	0.99946	5.4431E-4
89	versicolor	5.80699E-18	0.99995	5.1371E-5
90	versicolor	5.98119E-21	0.99982	1.81687E-4
91	versicolor	5.87861E-23	0.99939	6.1442E-4
92	versicolor	5.39901E-22	0.99809	0.00191
93	versicolor	3.55951E-18	0.99999	1.12857E-5
94	versicolor	2.10415E-14	1	1.13502E-7

- For the 84-th observation, we can see the post probabilities(virginica) 0.85661 is the maximum value. i.e. the 84-th observation will be assigned to the group **virginica** (at 85.7% probability).
- But in source data, the 84-th observation is in group **versicolor**. So this observation is mistakenly classified by the model.

#### 5.7.4.4 Model Validation

Model validation can be used to ensure the stability of the discriminant analysis classifiers

There are two methods to do the model validation

- **Cross-validation:**

In cross-validation, each training data is treated as the test data, exclude it from training data to judge which group it should be classified as, and then verify whether the classification is correct or not.

- **Subset Validation:**

Usually we will randomly divide the set of observations into subsets, the first of which is used for the estimation of discriminant model (training set) and the second is for testing the reliability of the results (test set).

#### 5.7.4.4.1 Preparing Data for Analysis

We are going to sort the data in random order, and then use the first 120 rows of data as training data and the last 30 as test data.

1. Go back to sheet **Fisher's Iris Data**
2. Add a new column and fill the column with **Normal Random Numbers**.
3. Select the newly added column. Right-click and select **Sort Worksheet: Ascending** from the shortcut menu.

**Notes:** Origin will generate different random data each time, and different data will result in different results.

In order to get the same results as shown in this tutorial, you could open the *Tutorial Data.opj* under the **Samples** folder, browse in the **Project Explorer** and navigate to the **Discriminant Analysis (Pro Only)** subfolder, then use the data from column (F) in the **Fisher's Iris Data** worksheet, which is a previously generated dataset of random numbers.

#### 5.7.4.4.2 Run Discriminant Analysis



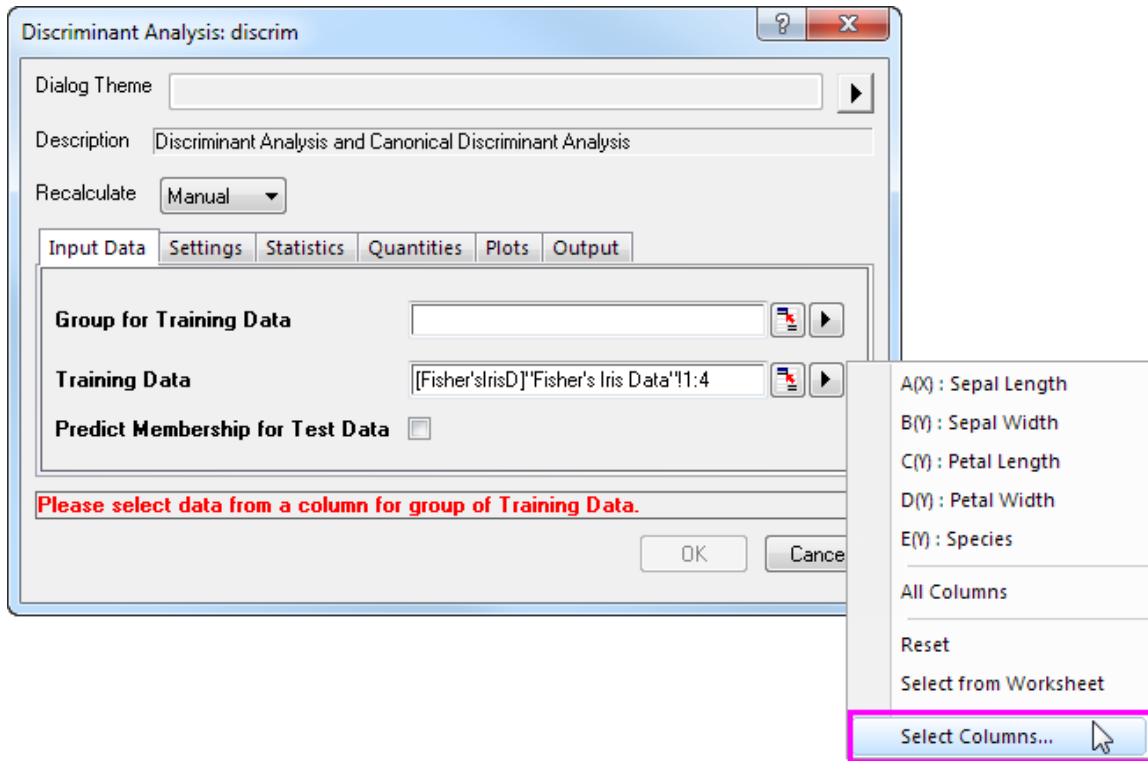

1. Select columns A through D.
2. Select **Statistics: Multivariate Analysis: Discriminant Analysis** to open the **Discriminant Analysis** dialog.
3. To set the first 120 rows of columns A through D as **Training Data**, click the **triangle button**  next to **Training Data**, and then select **Select Columns** in the context menu.

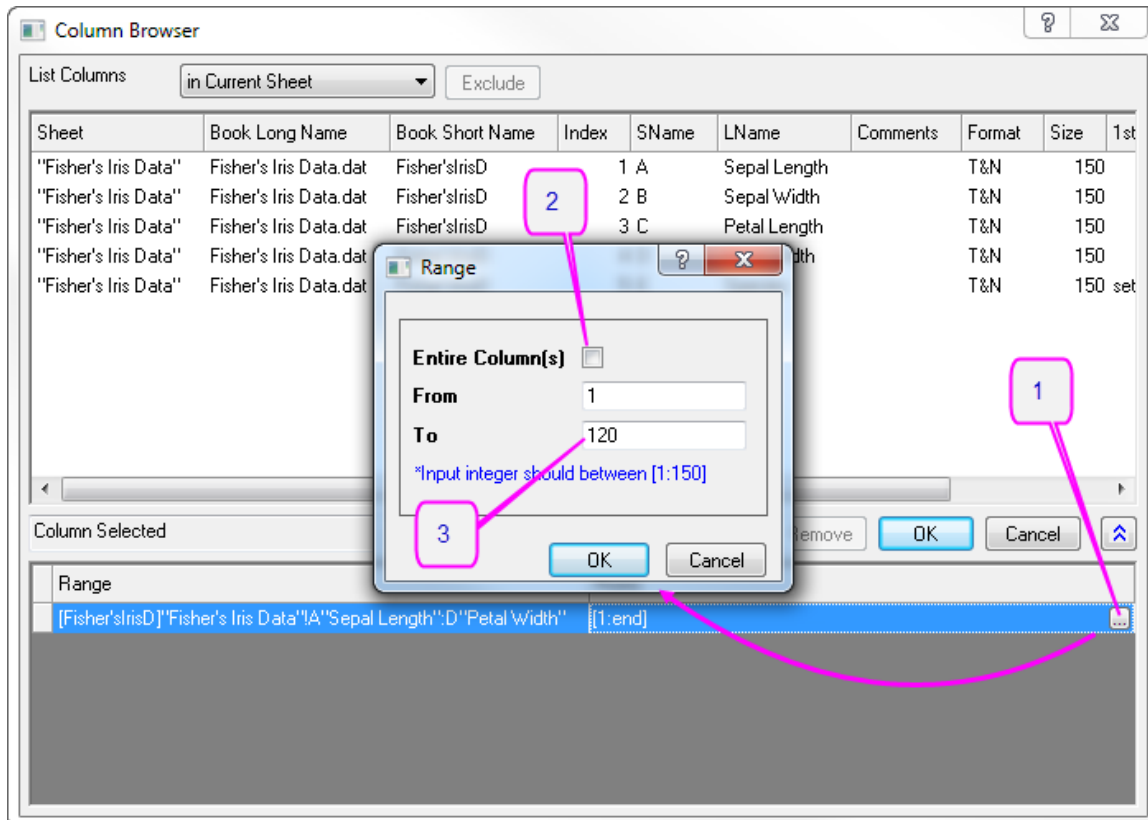

4. In the **Column Browser** dialog, click the ... button in the lower panel. Set data range from **1** to **120**. Click **OK**.





- To set first 120 rows of Col(E) as **Group for Training Data**, click the **triangle button**  next to **Group for Training Data** and select **E(Y): Species** in the context menu. Then click the **Group for Training Data triangle button**  again, select **Select Columns** in the context menu, and set range from **1** to **120** with column browser. Click **OK**.
- Select **Predict Membership of Test Data** check box. Click the **Test Data** interactive button . The dialog will "roll up". Select columns A through D in the worksheet. Click the button in the rolled up dialog to restore the dialog. Then click the **triangle button**  to open **Column Browser** by selecting **Select Columns** in the context menu. Click ... button in lower panel, and set range from **121** through **150**.

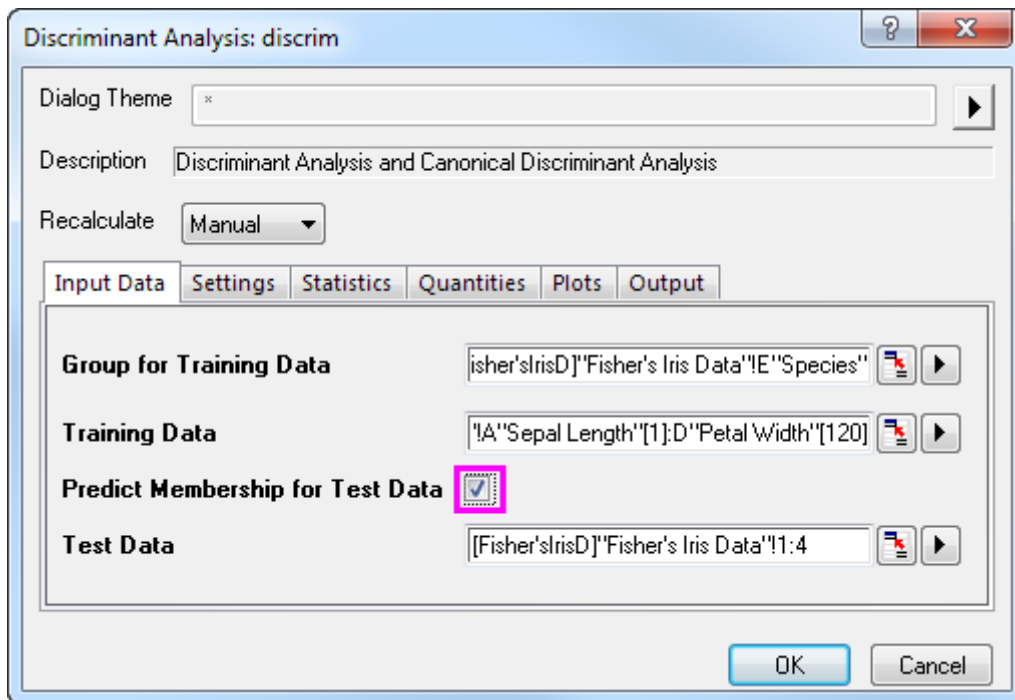

- Click the **Settings** tab and select the **Cross Validation** check box. Click **OK**.

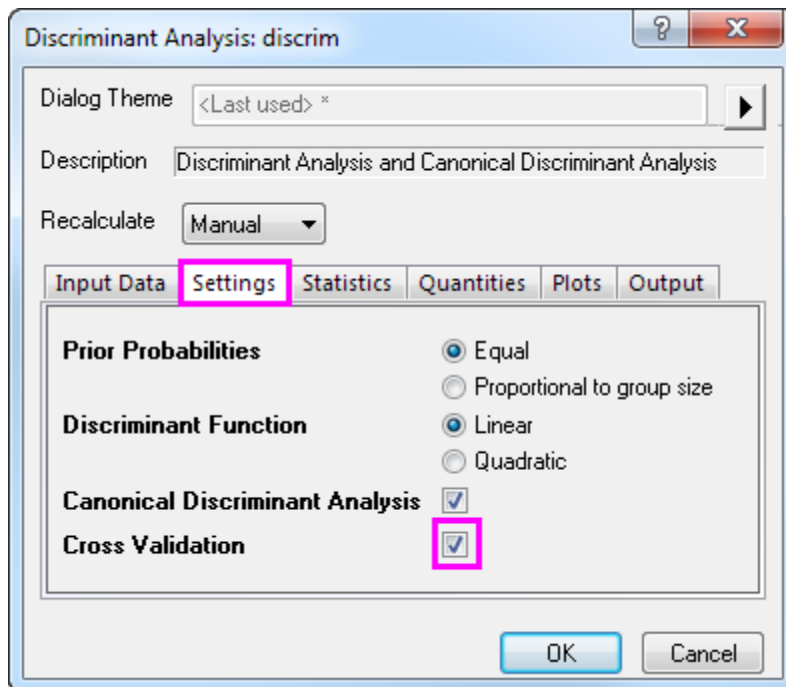

#### 5.7.4.4.3 Cross-validation

Go to sheet **Discriminant Analysis Report1**. The **Cross-validation Summary for Training Data** table provides prediction error rate by classifying each case while leaving it out from the model calculations. However, this method is still more "optimistic" than subset validation.

[-] Cross-validation Summary for Training Data

Classification Count				
	Predicted Group			
	setosa	virginica	versicolor	Total
setosa	44	0	0	44
	100.00%	0.00%	0.00%	100.00%
virginica	0	36	2	38
	0.00%	94.74%	5.26%	100.00%
versicolor	0	2	36	38
	0.00%	5.26%	94.74%	100.00%
Total	44	38	38	120
	36.67%	31.67%	31.67%	100.00%

Error Rate				
	setosa	virginica	versicolor	Total
Prior	0.33333	0.33333	0.33333	
Rate	0.00%	5.26%	5.26%	3.51%

Error rate for Cross-validation of training data is 3.51%.

#### 5.7.4.4.4 Subset Validation

1. The **Classification Summary for Test Data** provide information that how the test data are classified.

	setosa	virginica	versicolor	Total
Count	6	12	12	30
Percent	20.00%	40.00%	40.00%	100.00%

2. On the worksheet **Fisher's Iris Data**, copy the last 30 rows (121 through 150) of **Col(E): Species**.
3. On the worksheet **Test Result**, add one column, **Col(E)**, to the worksheet. Paste the copied values in the new column.
4. Add a new column, **Col(F)** to the worksheet, right click on it and select Set Column Values in the context menu. In the opened dialog, type **Compare(col(A),col(E))** in the pop-up dialog and click OK.

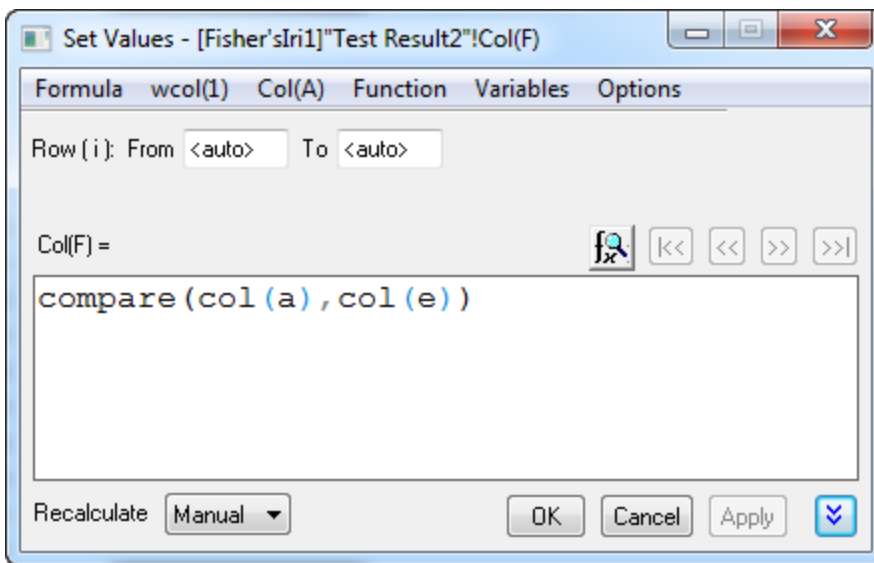

5. None of 30 values is 0, it means the error rate the testing data is 0. Our discriminant model is pretty good.

#### 5.7.4.5 Adjusting Prior Probabilities

Discriminant analysis assumes that prior probabilities of group membership are identifiable. If group population size is unequal, prior probabilities may differ. We can use **Proportional to group size** for the **Prior Probabilities** option in this case.

1. Go to sheet **Discrim2**, **Prior** row of the **Error Rate** table under **Classification Summary for Training Data** branch indicate the prior probabilities for membership in groups. It is assumed that a case is equally likely to be one of the three groups. Adjusting the prior probabilities according to the group size can improve the overall classification rate.

Error Rate

	setosa	virginica	versicolor	Total
Prior	0.33333	0.33333	0.33333	
Rate	0.00%	2.63%	5.26%	2.63%

Error rate for classification of training data is 2.63%.

- Click on the  button and select **Change Parameter** from the context menu. Select **Proportional to group size** for **Prior Probabilities** radio box. Click **OK** button.

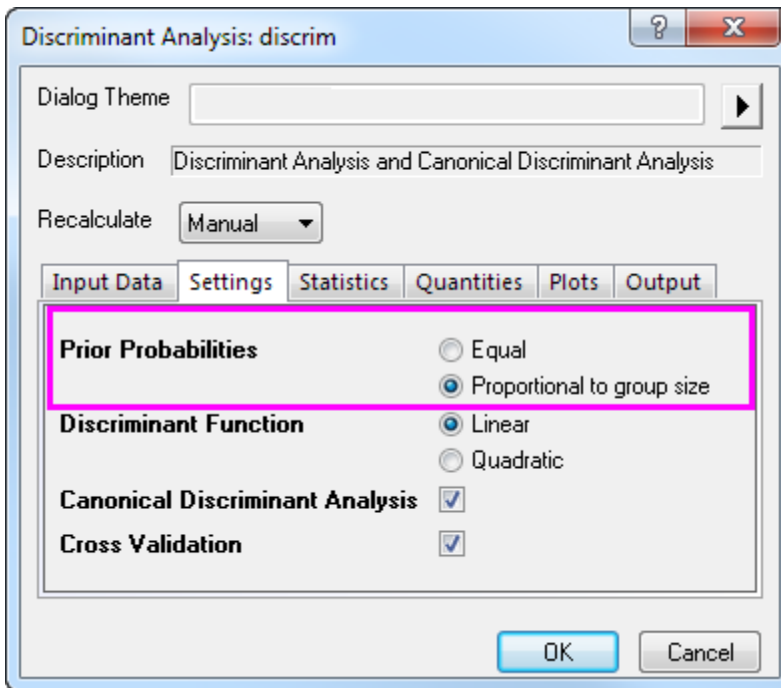

- We can see the classification error rate is 2.50%, it is better than 2.63%, error rate with equal prior probabilities.

Prior Probabilities = Proportional to group

Error Rate

	setosa	virginica	versicolor	Total
Prior	0.36667	0.31667	0.31667	
Rate	0.00%	2.63%	5.26%	2.50%

Prior Probabilities = Equal

Error Rate

	setosa	virginica	versicolor	Total
Prior	0.33333	0.33333	0.33333	
Rate	0.00%	2.63%	5.26%	2.63%

### 5.7.5 Partial Least Squares

### 5.7.5.1 Summary

Partial least squares (PLS) is a method for constructing predictive models when there are many highly collinear factors.

This tutorial will start with the spectral data of some samples to determine the amounts of three compounds present. The data includes:

- Data of the spectra emission intensities at different wavelength (v1 - v43)
- Amount of the three compounds in the sample (comp1, comp2, comp3)

This tutorial will establish a model to predict the amount of the three compounds from v1 - v43

Minimum Origin Version Required: OriginPro 2016 SR0

### 5.7.5.2 Partial Least Squares Regression

1. Start with a new project or a new workbook. Import the data file:  
**\Samples\Statistics\MixtureSpectra.dat**
2. Highlight Column("v1") through Column("v43").
3. Select **Statistics: Multivariate Analysis: Partial Least Squares**. This opens the pls dialog box to the **Input Data** tab.
4. The highlighted columns are automatically added as independent variables. Click the **triangle button**  next to **Independent Variables**, and click **Select Columns...** in the context menu.
5. Ensure the lower panel is expanded by clicking the button with two arrows in the bottom right of the **Column Browser** dialog.
6. In the lower panel click the **...** button. A **Range** dialog box will open. Clear the **Entire Column(s)** box and set the data range from **1** to **20**. Click **OK**, then click **OK** to close the Column Browser.

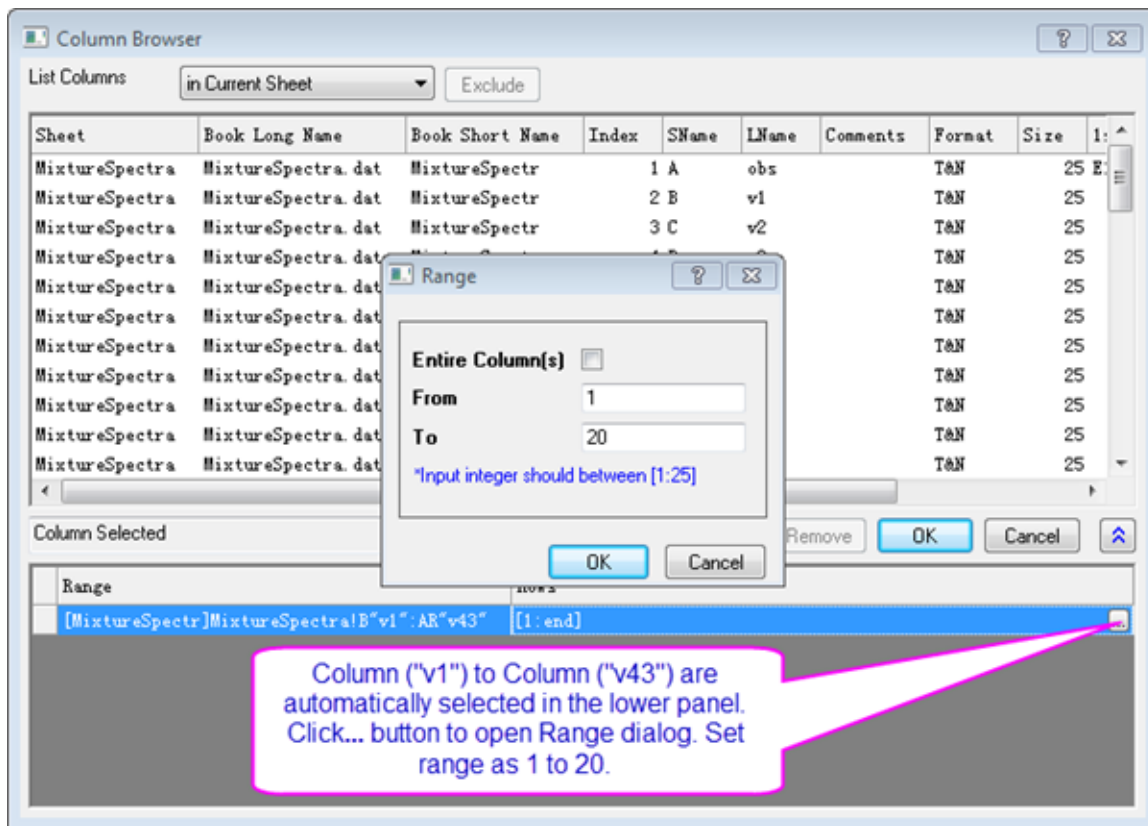

7. Click the interactive button  to the right of **Dependent Variables**. Return to the worksheet, select column("comp1") and drag to column("comp3"). Click the interactive button again to restore the dialog box.

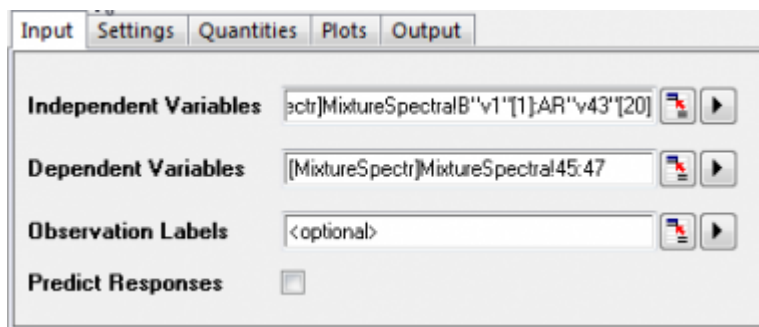

8. Since v1 to v43 are absorbance, there is no need to standardize them. Click on the **Settings** tab, set **Method** to SVD and clear the **Scale Variables** check box.
9. Select the **Cross Validation** check box. It helps find the optimal number of factors in the model.

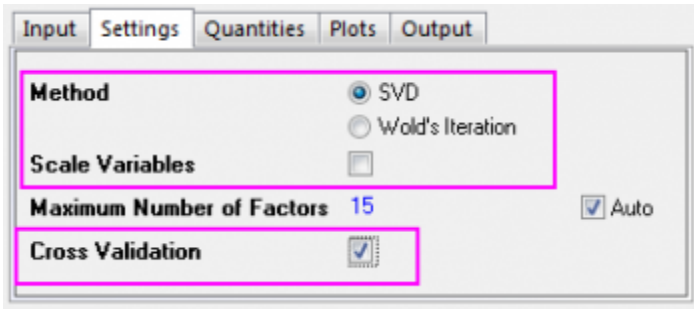

10. Click the **Plots** tab and expand the **Component Plot** branch. Select the following check boxes and click the **OK** button.

- **Variable Importance Plot**
- **X Loadings Plot**
- **Y Loadings Plot**
- **X Scores Plot**
- **Y Scores Plot**
- **Diagnostics Plots**

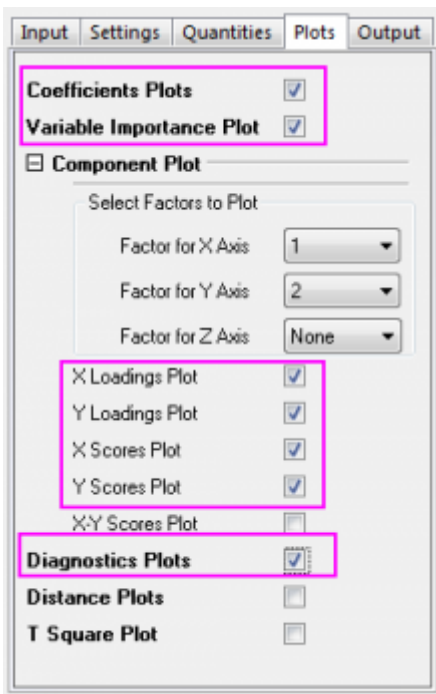

### 5.7.5.3 Developing the Model

In the workbook, select the tab for the **PLS1** sheet:

1. The **Cross Validation** table shows the optimum number of factors to extract. PRESS is the predicted residual sum of squares of the model. The model with minimum Root Mean PRESS has the optimal number of factors:

Cross Validation

Cross Validation Summary

Factors	Root Mean PRESS
0	0.1678
1	0.08999
2	0.03165
3	0.03096
4	0.02836
5	0.02895
6	0.02996
7	0.03051
8	0.03028
9	0.03021
10	0.03151
11	0.03279
12	0.03312
13	0.03397
14	0.03428
15	0.03459

Minimum root mean PRESS: 0.02836  
Optimal number of factors: 4.

Optimum number of factors to be extracted is decided based on the model with minimum Root Mean PRESS

2. The Diagnostics Plots are residual plots of Y and X, which can be used to judge the quality of the model.

Overall we can say that the fitted model is good because:

- Layer 1 - The **Predicted values-Actual values** graph indicates that the model fits well for the first component.
- Layer 2 - In the **Predicted values-Residual** graph, residuals are randomly distributed around zero. This indicates that there is no drift in the process.
- Layer 4 - The P-P plot of residual can be used to check whether the variance is normally distributed. The result falls almost in a line, which means the variance is normally distributed.



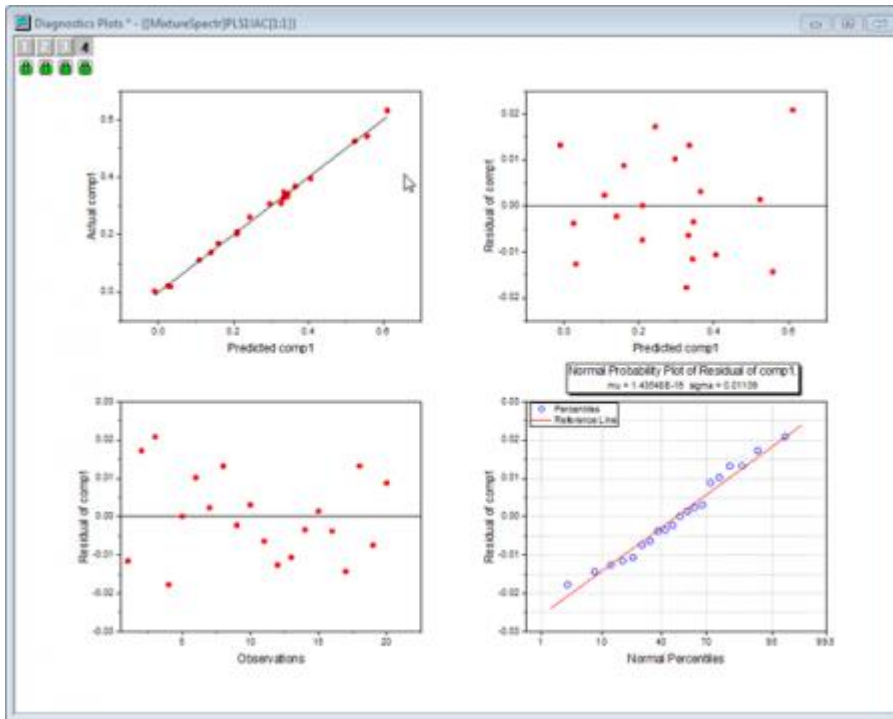

3. A summary of importance of  $v_1 \sim v_{43}$  is given by the VIP plot. If the variable has small regression coefficients and low VIP values, we can consider excluding it in the model. For example

- VIP values of  $v_{41} \sim v_{43}$  in the plot below are low:

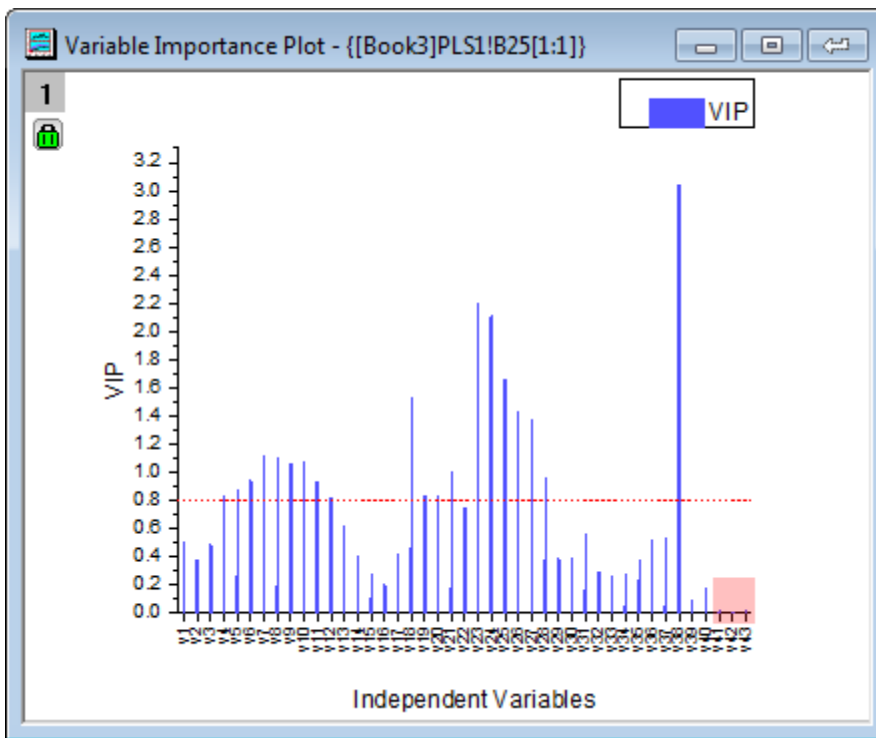

- Coefficients of v41 ~ v43 are also small in the three coefficients below:

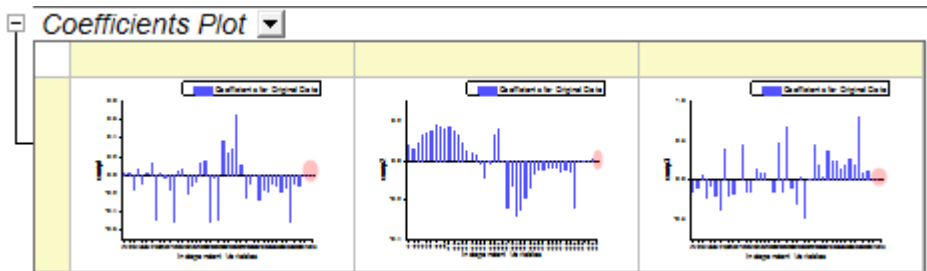

4. However, as in step 2, it appears that the model fits well so it is also acceptable to keep these less important variables.

#### 5.7.5.4 Interpreting the Results

1. The **Variance Explained** table shows the proportion of variance explained by each factor. In the example, Factor 1 explains 71.36% variance for the X effect and 75.6% variance for the Y effect. Factor 2 explains 23.99% variance for the X effect and 22.14% for the Y effect. The **Variance Explained Plot** indicates that more attention should be paid to the first two factors as these two explained more than 95% variance for X and Y effects.

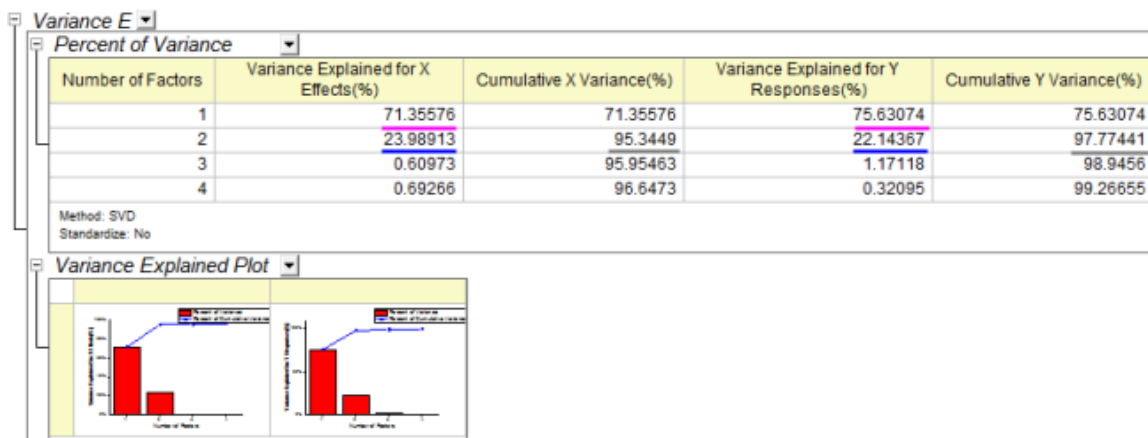

2. The Loading Plot reveals the relationships between X and Y variables in the space of the first two factors.
  - From the Y loading plot we can see that the three compounds have different loading on Factor 1 and Factor 2.

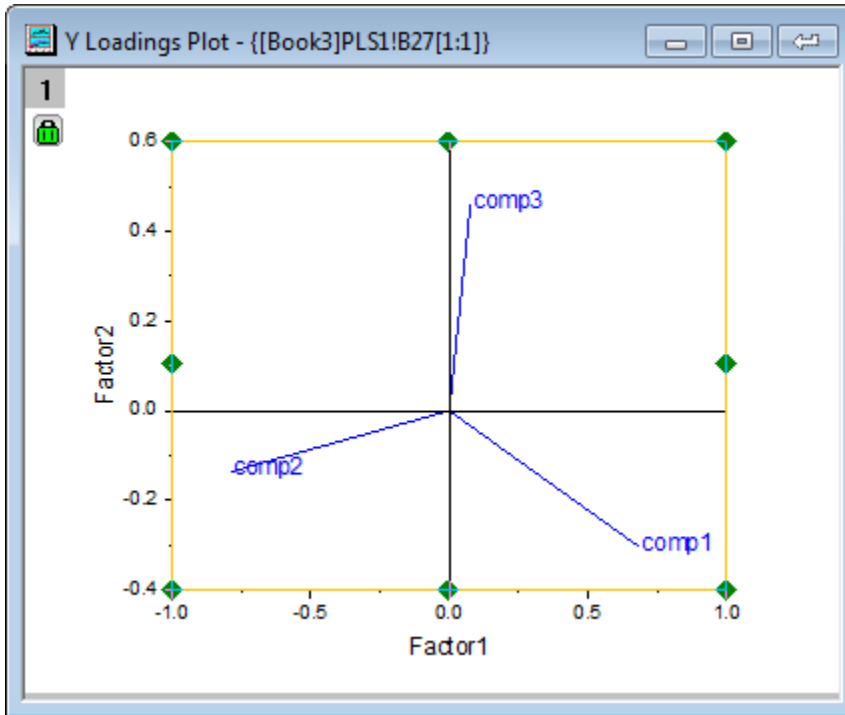

- From the X loading plot it is apparent that v26 ~ v38 have similar heavy loadings for Factor 2, and v17, v18, v19, v23 and v24 have similar light loadings for factor 1 and factor 2.

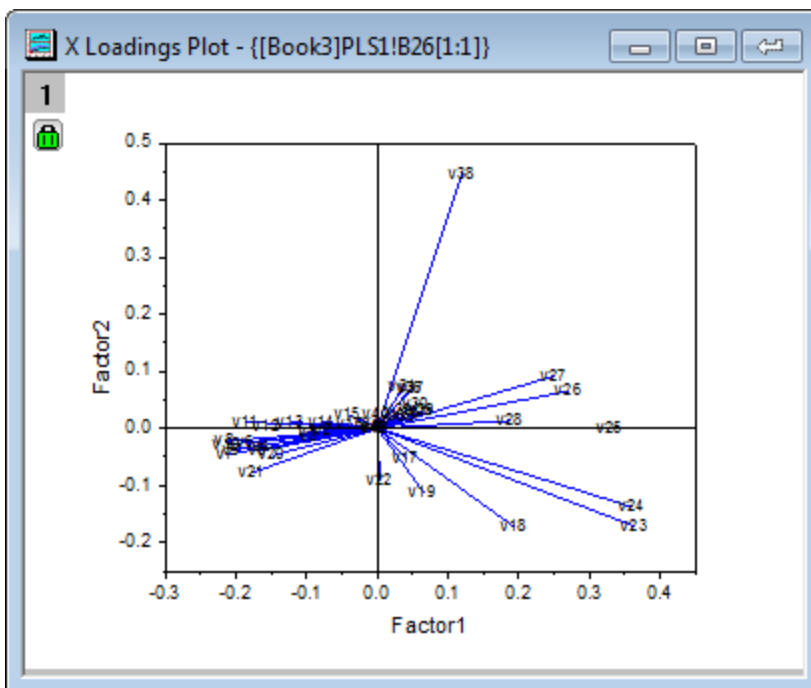



**Notes:** To examine the plot in detail, you can double-click to open the graph containing the loading plot

and [zoom in](#) it with the **Scale In** tool 

5.7.5.5 Using the Model to Predict

After the model is established, we can predict the amounts of the three compounds in new samples from their spectra emission intensities at different wavelengths:

1. Click the green lock on the PLS1 sheet and select **Change Parameter** from the context menu.
2. In the dialog that opens, click on the **Input** tab and select the **Predict Responses** check box.
3. Click the interactive button  to the right of **Independent Variables for Prediction**. Return to the workbook, select the **MixtureSpectra** sheet. Select column("v1") to column("v43"). Click the interactive button again to restore the dialog box.
4. Click the triangle button  next to **Independent Variables for Prediction**, and then click **Select Columns...** in the context menu.
5. In the lower panel of the **Column Browser** dialog, click the ... button. Deselect the **Entire Column(s)** box and set the data range from **21** to **25**. Click **OK** to close the **Range** dialog and **Column Browser** dialog..

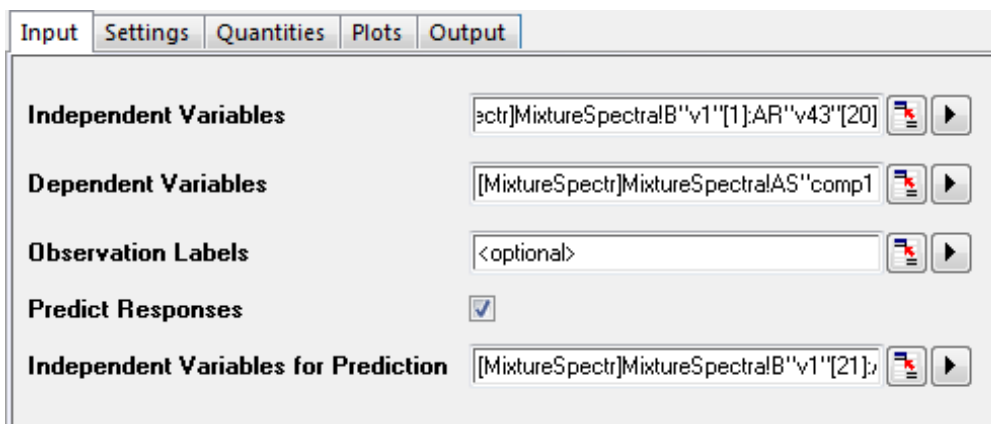

Field	Value
Independent Variables	[MixtureSpectra]MixtureSpectral!B"v1"[1]:AR"v43"[20]
Dependent Variables	[MixtureSpectra]MixtureSpectral!AS"comp1
Observation Labels	<optional>
Predict Responses	<input checked="" type="checkbox"/>
Independent Variables for Prediction	[MixtureSpectra]MixtureSpectral!B"v1"[21];

6. Click the **OK** button to apply the settings and close the dialog.
7. The **PLSResults1** sheet will now contain the predicted amounts of the three compounds in the five new samples:

Long Name	A(X1)	B(Y1)	C(Y1)	D(Y1)	Ir
Observations	comp1	comp2	comp3		
Units					
Comments	Predicted Responses for Test Data				
F(x)=					
1	21	0.03112	0.60104	0.35266	In
2	22	0.45822	0.22111	0.2981	v1
3	23	0.23019	0.43717	0.30898	v2
4	24	0.33108	0.23231	0.40731	v3
5	25	0.37709	0.38007	0.21355	v4
6					v5
7					v6
8					v7
9					v8
10					v9

## 5.8 Power and Sample Size

### 5.8.1 Summary

Power and sample size analysis is useful in design of experiments. Insufficient data translates into a lack of power to reject a false null hypothesis and collecting too much data is a waste of time and resources. Therefore, it is essential to determine the sample size requirements prior to conducting an experiment. The power of the experiment can be computed for a given sample size, and required sample sizes can be computed for given power values.

### 5.8.2 What you will learn

This tutorial will show you how to calculate sample size or estimate power value to design experiments, using some practical examples.

### 5.8.3 (PSS)One-Sample t-Test

#### Background:

A sociologist wants to determine whether the average infant mortality rate in the United States is equal to 8. In experiment design, the difference of rate cannot vary more than 0.5. And it is already known that the standard deviation should be 2.1 from pilot studies.

#### Question:

What would the sample size be, in order to estimate the average infant mortality rate at a confidence level of 95% ( $\alpha=0.05$ ) for power values of 0.7, 0.8 and 0.9?

#### Steps in Origin:

1. Activate an empty worksheet, select **Statistics: Power and Sample Size: (PSS) One-sample t-test**;
2. In the **PSS\_tTest1** dialog box, choose the following settings and click **OK**.

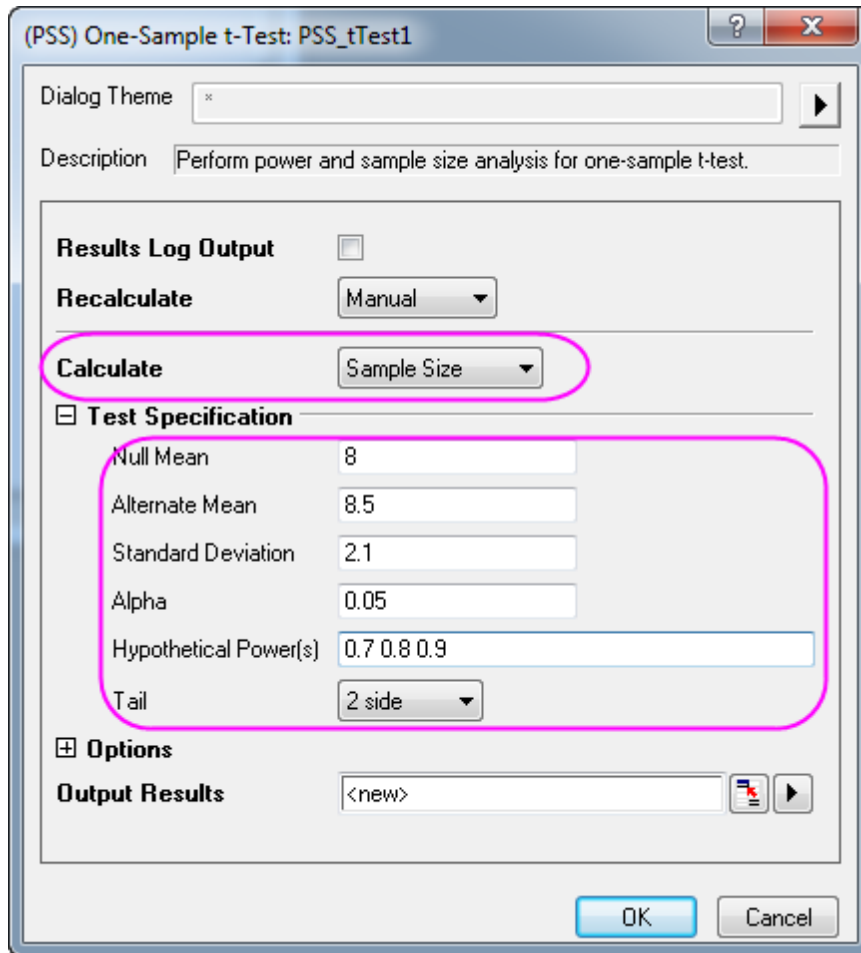

**Origin Output:**

A result sheet will be generated, listing the calculated sample size for hypothetical powers.

[-] *Sample Size(s) for Hypothetical Power(s)* ▾

	Alpha	Power	Sample Size
	0.05	0.7	111
	0.05	0.8	141
	0.05	0.9	188

Null Mean = 8; Alternate Mean = 8.5; SD = 2.1; 2-Sided Test

**Result Interpretation:**

According to results, when designing his experiment the sociologist should conduct a survey of 111 samples for a power value of 0.7; 141 samples for power value of 0.8; and 188 samples for power value of 0.9.

**5.8.4 (PSS)Two-Sample t-Test**

**Background:**

A doctor's office participates in two local insurance plans, Healthwise and Medicare. The purpose is to compare the mean time (in days) until reimbursement of claims for the two plans. Historical data shows that for the Healthwise plan, the average time is 32 days and the standard deviation is 7.5 days. For the Medicare plan, the average reimbursement time is 42 days and the standard deviation is 3.5 days.

**Question:**

If 10 claims from each plan were selected and the corresponding reimbursement times were recorded, what is the power to detect the difference in mean reimbursement times between the 2 plans by 5% or more?

**Steps in Origin:**

1. Compute the pooled standard deviation as:

$$\sqrt{((5 - 1)*7.5^2 + (5 - 1)*3.5^2)/(5 + 5 - 2)} = 5.85235$$

\*Note that this value will be used as the standard deviation later for the power calculation.

2. Sample size of 1st group and 2nd group should be 10 (20 samples total).
3. Activate an empty worksheet and select **Statistics: Power and Sample Size: (PSS) Two-Sample t-Test**,
4. In the **PSS\_tTest2** dialog box, choose the following settings and click **OK**.

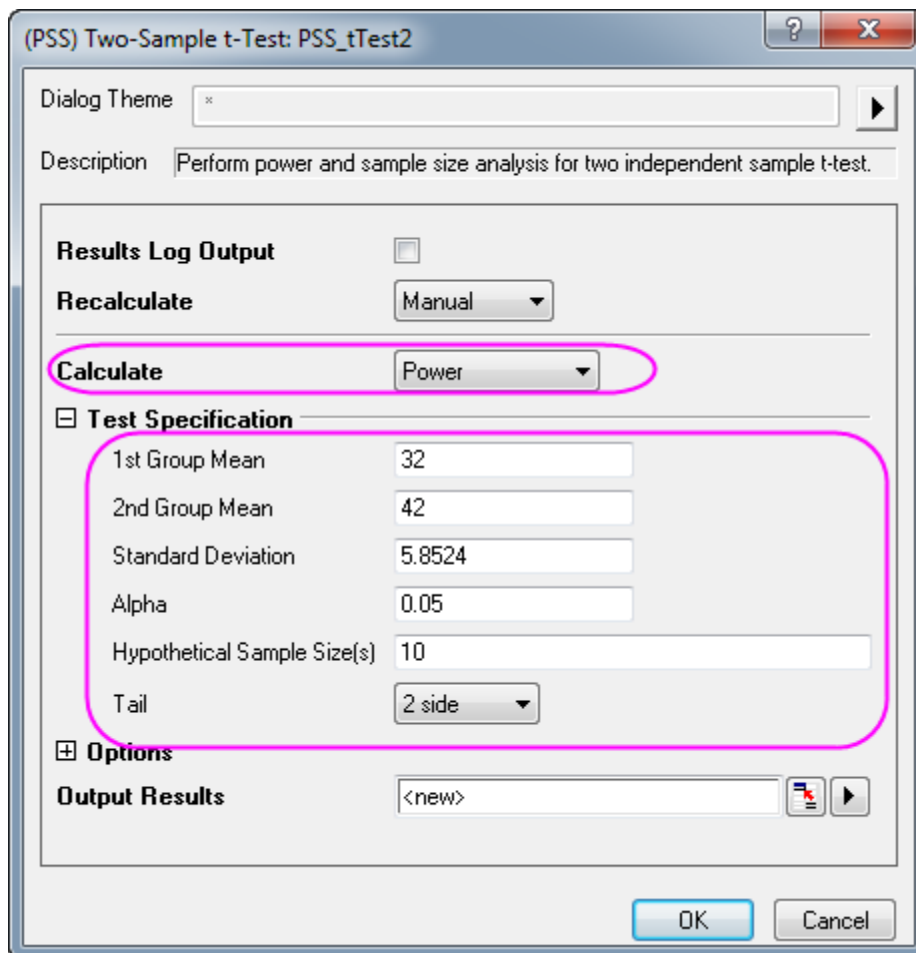

**Origin Output:**

A result sheet will be generated, showing the calculated power.

Power(s) for Hypothetical Sample Size(s) ▼

Alpha	Sample Size	Power
0.05	10	0.95054

Group1 Mean = 32; Group2 Mean = 42; SD = 5.85235; 2-Sided Test

**Interpretation of Results:**

We can conclude that the doctor's office has a 0.95054:1 (or 95%) chance of detecting a difference if it collects 10 claims for each plan. The chance that you will fail to reject the null hypothesis and incorrectly conclude that the two means are not different is 4.946% (1 - 0.95054).

**5.8.5 (PSS) Paired-Sample t-Test****Background:**

Two machines of the same type are used to measure the depth of an amorphous silicon (a-Si) thin film. To determine if there is a difference in the two machines measurements, an engineer plans a study to compare the depth measurements made by the two machines.

In a previous study on depth of the a-Si thin film, the standard deviation of the difference was found to be  $2\mu\text{m}$ . In addition, it is known that the difference in measurement by the two machines should not exceed  $0.5\mu\text{m}$ , and the average depth measured by Machine #1 is  $5000\mu\text{m}$ .

**Question:**

How many samples must be taken at a confidence level of 99% to obtain power values of 0.8, 0.9 and 0.95?

**Steps in Origin:**

From the information above, it is concluded that the mean of the 1st group is  $5000\mu\text{m}$  and the mean of the 2nd group is  $5000.5\mu\text{m}$ .

1. Activate an empty worksheet and select **Statistics: Power and Sample Size: (PSS) Paired t-Test**
2. In the **PSS\_tTestPair** dialog box, set controls as in the following image and click **OK**.



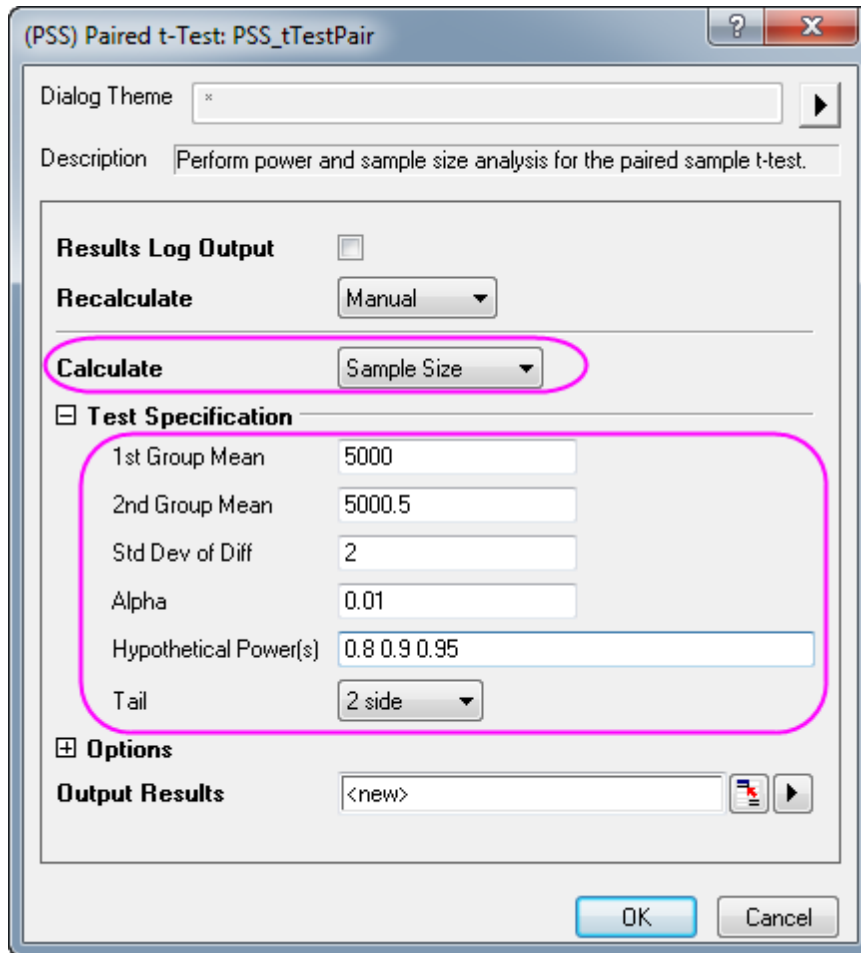

**Origin Output:**

A result sheet will be generated, listing the required sample size at different power values.

Sample Size(s) for Hypothetical Power(s)

Alpha	Power	Sample Size
0.01	0.8	191
0.01	0.9	242
0.01	0.95	289

Group1 Mean = 5000; Group2 Mean = 5000.5; SD = 2; 2-Sided Test

**Interpretation of Results:**

We conclude that the engineer has an 80% chance of detecting a difference if 191 thin film samples are measured; a 90% chance if 242 thin film samples are measured; and a 95% chance if 289 thin film samples are measured by each machine.

**5.8.6 (PSS)One-Way ANOVA**

**Background:**

Researchers are interested in whether different plants have different nitrogen contents. They planned to record nitrogen contents in milligrams for 4 species of plants (80 observations per species). Previous research suggests that the square root of MSE (Mean Squared Error) is 60 and the CSS (corrected sum of squares) of the means is 400.

**Question:**

Is the plan feasible? (i.e. will the calculated power be acceptable?)

**Steps in Origin:**

1. The sample size for each group is 80.
2. Activate an empty worksheet and select **Statistics: Power and Sample Size: (PSS)One Way ANOVA**
3. In the **PSS\_ANOVA1** dialog box, choose the following settings and click **OK**.

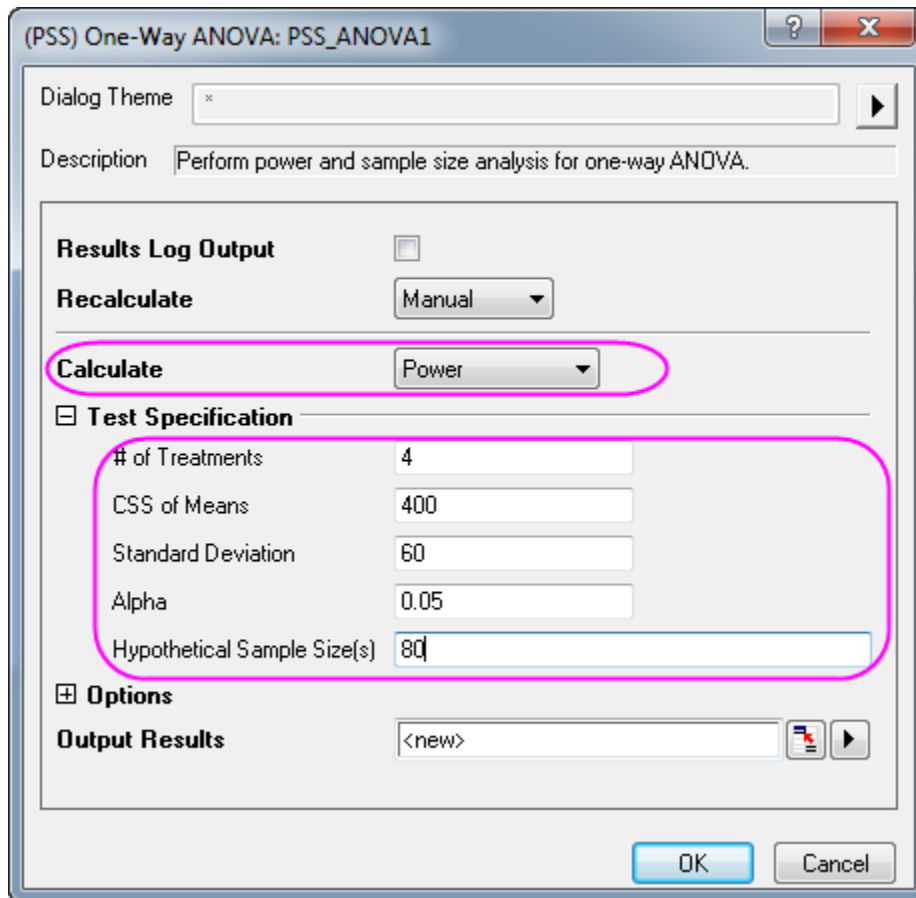

**Origin Output:**

A result sheet is generated, and the power value is calculated from the known condition.

Power(s) for Hypothetical Sample Size(s) ▾

Alpha	Sample Size	Power
0.05	80	0.6993

# Treatments = 4; CSS of Means = 400; SD = 60

**Interpretation of Results:**

It appears that the original research plan is deficient. There is only a 69% chance of detecting a difference from each group. To get more reliable results, researchers must collect more samples per species of plant.

**5.9 ROC curve**

### 5.9.1 Summary

The Receiver Operating Characteristic (ROC) analysis curve is mainly used for diagnostic studies in Clinical Chemistry, Pharmacology, and Physiology. It has been widely accepted as the standard method used for describing and comparing the accuracy of diagnostic tests.

Please refer to the [Origin help file](#) for details on how to use the ROC curve.

### 5.9.2 What you will learn

This tutorial will show you how to:

- Carry out ROC curve analysis.
- Interpret the analysis of results.

### 5.9.3 Steps

In this example, we perform a study to determine whether serum sodium can help to diagnose Rocky Mountain Spotted Fever (RMSF).

The data is retrieved from people with or without RMSF, the sodium level for each person is measured by 2 screening techniques. ROC curve analysis is carried out for data from both methods, used to check the relationship between serum sodium and RMSF, and helped to judge which diagnostic method is better.

1. Click the **Import Single ASCII** button  to import the **sodium.dat** file into Origin, the file is under the `\Samples\Statistics` folder.
2. Select **Statistics: ROC Curve...** to open the ROC curve dialog.
3. Under the **Input Data** branch, select column **B(Method1)** and **C(Method2)** for **Data**, and column **A(Sickness)** for **State**, respectively.
4. Set **RMSF** as **Positive State Value** and select the **Positive v.s. Low** button for Test Direction under the Computation Control branch.
5. Accept all other default settings and click the **OK** button to carry out the analysis.

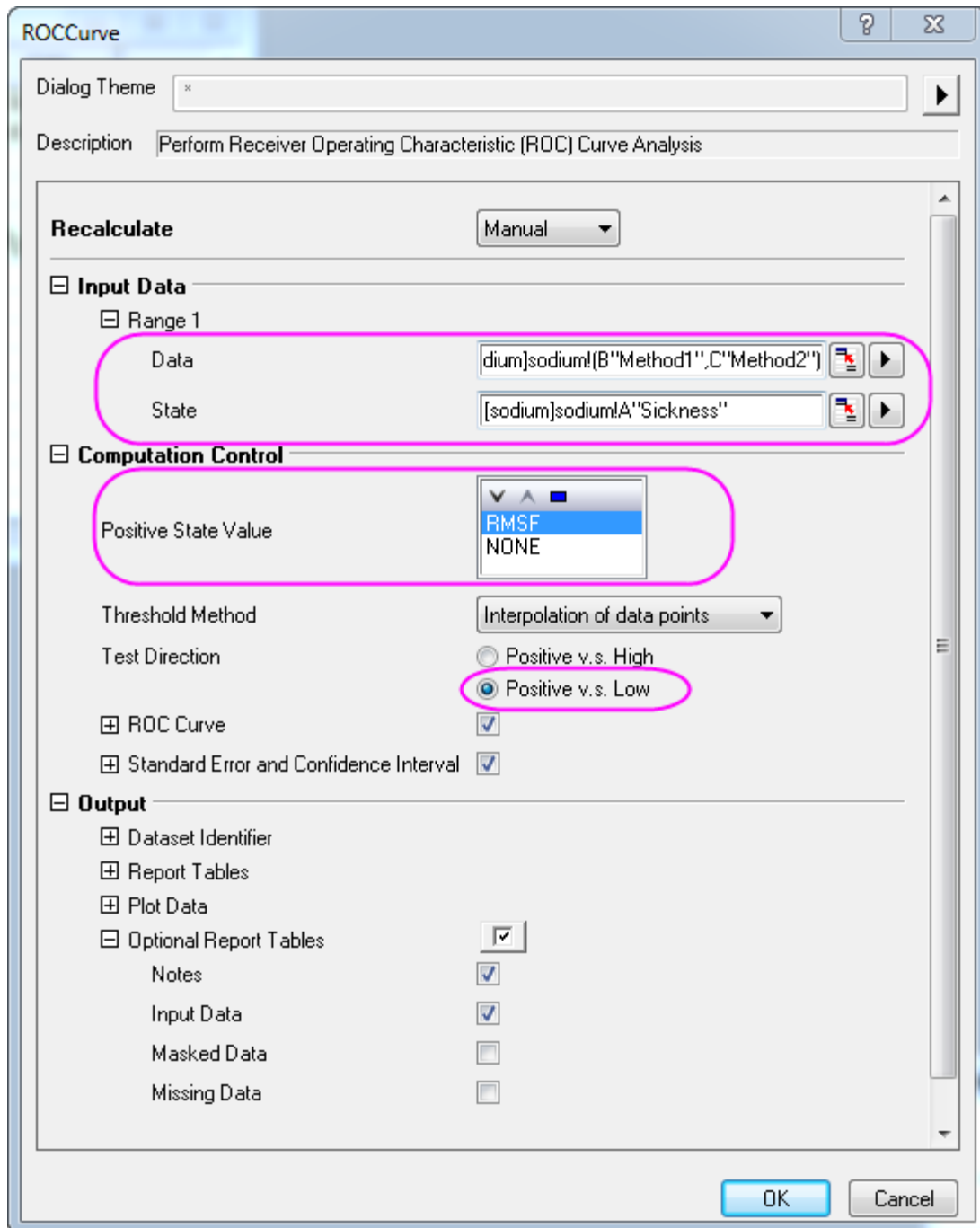

**Results Interpretation:** Go to worksheet ROC Curve1, where the analysis results are listed.

Area Under the Curve

	Area	Std. Error	Asymptotic Prob	95% LCL	95% UCL
Method1	0.88862	0.04577	2.48984E-6	0.79892	0.97833
Method2	0.79407	0.06344	3.66257E-4	0.66972	0.91842

From the table, we can see that the **Asymptotic Prob** of both methods are much smaller than 0.05, hence we can conclude that both methods are effective.

In ROC analysis, the closer the area is to 1.0, the better the test is, while the closer the area is to 0.5, the worse the test is. In this analysis, the area of method 1 and method 2 are 0.88862 and 0.79407, respectively. Both these results are much larger than 0.5. However, the area of method 1 is closer to 1.0, so we can conclude that method 1 is better than method 2.

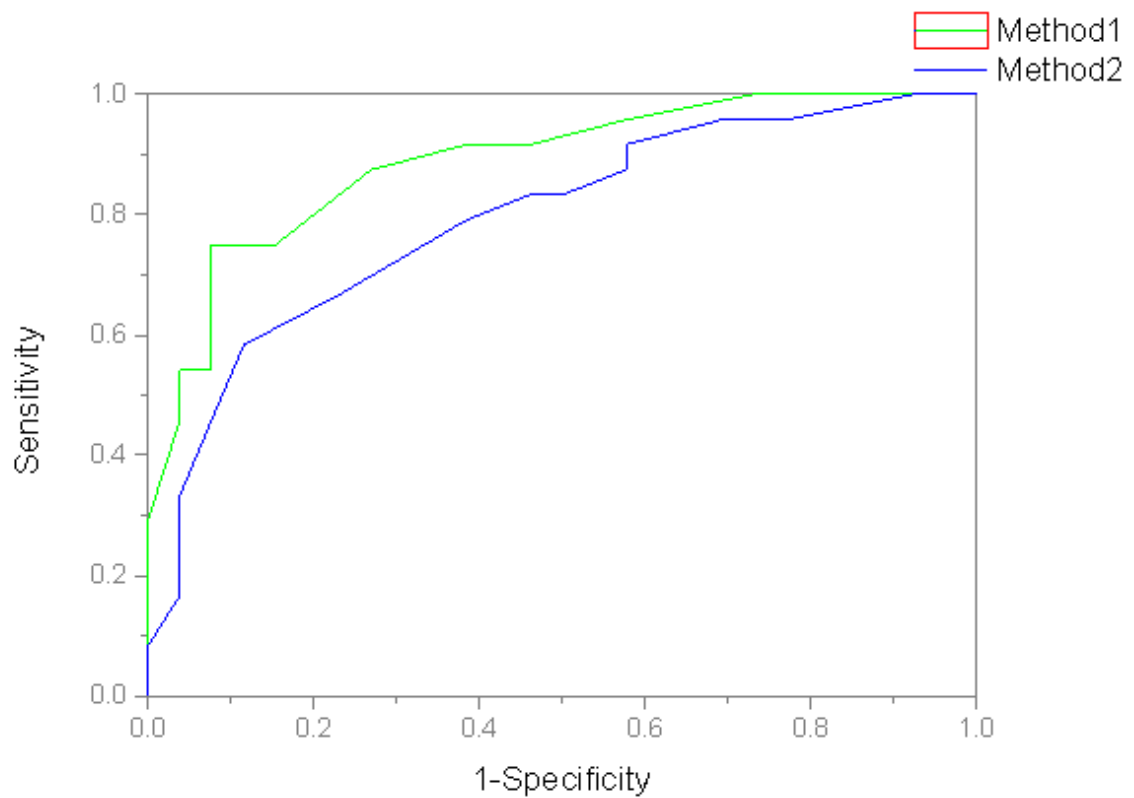

In addition, we can examine the shape of ROC curve, which is also included in the report sheet. Since method 1 appears to have greater sensitivity than method 2, we can roughly conclude that method 1 is better than method 2.



## 6 Graphing

### 6.1 Graphing

#### 6.1.1 Plotting

- [3D Bar with Labels](#)
- [Creating a Graph](#)
- [Basic 2D Plotting](#)
- [Basic 3D Plotting](#)
- [Plot from User Defined Graph Template](#)
- [Adding a Data Plot to Existing Graph](#)
- [Smart Peak Labels with Leader Line](#)
- [Error Bars with Fill Area](#)
- [Mark out a segment of plot with different plot style](#)
- [Overview of Customization](#)
- [Plotting Overlapping Data and Setting Transparency](#)
- [Plotting using Plot Setup](#)

#### 6.1.2 Axis

- [Multiple Axis Breaks](#)
- [User-Defined Arbitrary Tick Positions](#)
- [Plot and Customize Date Time Data on Graph](#)

#### 6.1.3 [Compare Graphs Dynamically by Changing Data Filters](#)

#### 6.1.4 Layers

- [Merging and Arranging Graphs](#)
- [Multiple Layers with Linked Axis](#)
- [Multi Layer Graph Customization](#)

#### 6.1.5 Graph Template and Theme

- [Copy and Apply a Plot Format to Another Plot](#)

### 6.1.6 Line Symbol

- [Complicated Fill Area](#)
- [Fill Partial Area between Function Curves](#)
- [Line Graph with Recession Bars](#)
- [Scatter Plot of Decay and Recovery Curves](#)
- [Micro-Raman spectroscopy of complex nanostructured mineral systems](#)
- [Multi-line-plot with Special Position Annotation Line](#)
- [Scatter Central Plot](#)
- [Line Graph with Masked Data](#)
- [Symbol Plot with Color Transparency](#)
- [Symbol Plot with Size and Colormap from Other Columns](#)

### 6.1.7 Column Bar Pie

- [2D Pie Chart of a Population Study](#)
- [Bar Graph of African Population](#)
- [Bar and Scatter Plot with Error Bar](#)
- [Column Graph with Error Bars](#)
- [Stack Column With Labels](#)
- [Clustered-Stacked Column Chart](#)
- [Grouped Column with Error Bars and Data Labels](#)
- [Grouped Stacked Column](#)
- [Stack Column Plot with Different Positive and Negative Y Scale](#)
- [Variable Column Width](#)
- [Stack Column and Bar Charts of Rechargeable Battery Statistics](#)

### 6.1.8 Multi-Axis Multi-Panel

- [Double Y](#)
- [3Ys Y-YY](#)
- [Stack Lines by Y Offsets](#)
- [Vertical 2 Panel Line](#)
- [Multiple Axis Plot](#)
- [Energy-Level Structure of the Er<sup>3+</sup> Ion in A YAG Crystal](#)



- [Create an 8 layer multi-panel plot template](#)
- [Panel Graph with Inset Plots of High-resolution Electron Energy-loss Spectra](#)

### 6.1.9 Contour

- [XYZ Contour](#)
- [Contour Plots and Color Mapping](#)
- [Ternary Contour](#)
- [Combining Line and Contour Plots](#)
- [Contour Graph with XY Data Points and Z Labels](#)
- [Contour Plot with Vector Overlay](#)
- [Create Heatmap with Virtual Matrix and Colormap Bar Plot](#)

### 6.1.10 Statistics

- [Box Plot](#)
- [Grouped Box Chart with Color Indexed Data Points](#)
- [I Shaped Box Plot](#)
- [Marginal Distribution Curve](#)
- [Overlapping Box Chart](#)
- [Two-Level Grouped Box Chart](#)
- [Unbalanced Grouped Box Chart](#)
- [Grouped Box Plot](#)
- [Notched Boxes with Variable Width Control](#)
- [Simple Dot Chart](#)
- [Multi-Data Dot Chart](#)
- [Add multiple fitted curves in a Histogram](#)
- [Weibull Probability Plot](#)
- [Q-Q Plot](#)
- [Scatter Matrix](#)
- [Histogram with Distribution Curve overlay](#)

### 6.1.11 Polar

- [Polar Contour](#)
- [Polar Plot with Error Bar](#)
- [Polar Crop](#)

- [Polar Graph with Custom Radial Axes](#)
- [Polar Graph with Multiple Layers](#)
- [Polar Graph with Columns and Stack Columns](#)
- [Polar Graph with Custom Angular Scale](#)

### **6.1.123D Graphs**

- [3D Pie Chart](#)
- [3D Vector](#)
- [3D Scatter Plot with Line Projections of Core Drilling Locations](#)
- [3D Bar and Symbol](#)
- [Surface with Missing Values](#)
- [Creating Intersecting Surface Plots from Worksheets](#)
- [Intersecting Color Surfaces](#)
- [Surface with Symbols and Droplines](#)
- [Colormap from Second Matrix](#)
- [Color Map Surface Graph](#)
- [Parametric Surface with Colormap from Data](#)
- [Stacked 3D Surface Plots](#)
- [Multiple Surfaces in Same Layer](#)
- [3D Scatter with Colormap](#)
- [3D Scatter with Droplines](#)
- [Surface With Transparent Plane](#)
- [3D Bar on Flatten Surface](#)
- [3D Bar with Labels](#)
- [3D Surface with Point Label](#)
- [Transparent Parametric Surfaces combined with Scatter Plot](#)
- [Convert Data from Spherical Coordinate to XYZ and Make a 3D Plot](#)
- [Flattened Colormap Surfaces with Increasing Z Offset](#)
- [3D Ternary Colormap Surface with Contour Lines Projection](#)

### **6.1.13 [Plot Functions with Parameters Defined in a Worksheet](#)**

### **6.1.14 [Wind Rose](#)**

### **6.1.15 [2D Function Plot](#)**

### **6.1.16 [2D Vector](#)**

### **6.1.17 [Piper Diagram](#)**

### **6.1.18 Waterfall**

- [2D Waterfall](#)
- [3D Waterfall](#)

### **6.1.19 [Open-High-Low-Close Stock Chart](#)**

## **6.2 Plotting**

### **6.2.1 Plotting**

- [3D Bar with Labels](#)
- [Creating a Graph](#)
- [Basic 2D Plotting](#)
- [Basic 3D Plotting](#)
- [Plot from User Defined Graph Template](#)
- [Adding a Data Plot to Existing Graph](#)
- [Smart Peak Labels with Leader Line](#)
- [Error Bars with Fill Area](#)
- [Mark out a segment of plot with different plot style](#)
- [Overview of Customization](#)
- [Plotting Overlapping Data and Setting Transparency](#)
- [Plotting using Plot Setup](#)

### **6.2.2 3D Bar with Labels**

#### 6.2.2.1 [Summary](#)

This tutorial will show you how to create the following graph:

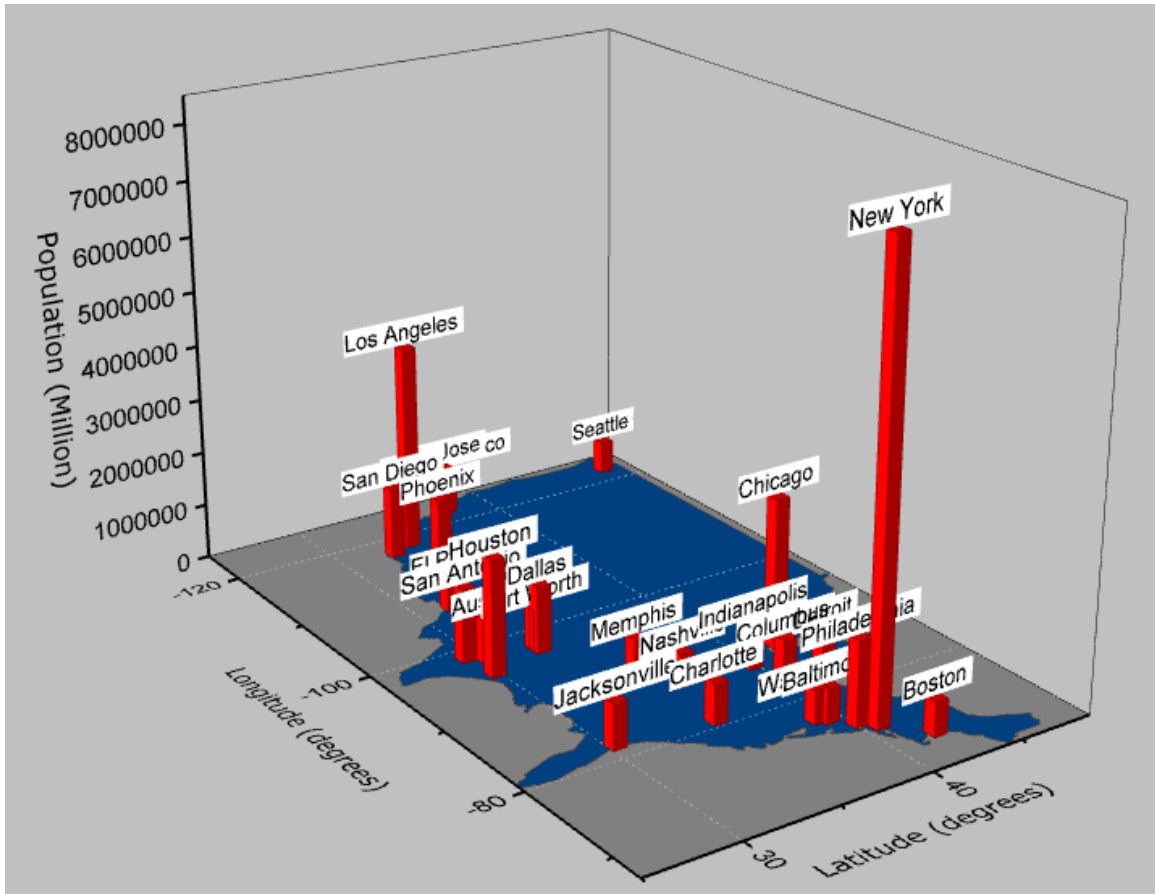

Minimum Origin Version Required: 2015 SR0

### 6.2.2.2 What You will learn

This tutorial will demonstrate how to:

- Create and customize a flat Color Fill surface.
- Use Plot Setup to add a 3D bar plot to the original graph.
- Add and customize labels on the 3D bars.

### 6.2.2.3 Steps

This tutorial is associated with <Origin EXE Folder>\Samples\Tutorial Data.opj.

#### 6.2.2.3.1 **Creating a Flat Color Fill Surface from a Matrix**

Open Tutorial Data.opj and browse to the folder *3D Bar with Labels*.

1. Activate the Matrix *MBook1B*.

- From the Origin menu select **Plot > 3D: 3D Color Fill Surface** to create a 3D plot that will have **Speed Mode** turned on:

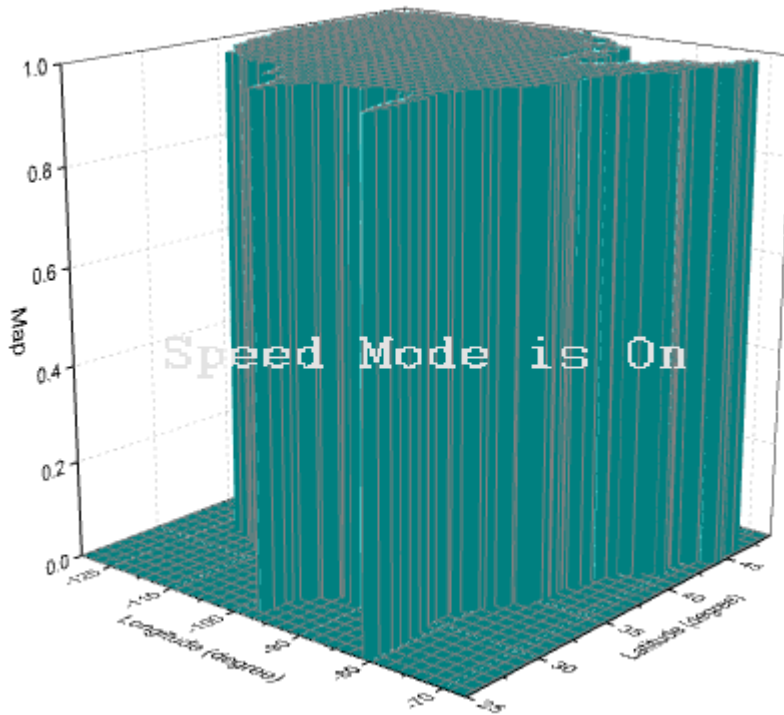

- On the Origin menu, click **Format: Layer**.
- On the **Size/Speed** tab, clear **Matrix data, maximum points per dimension**. This turns off **Speed Mode** allowing for full display of the dataset. Click **Apply**.

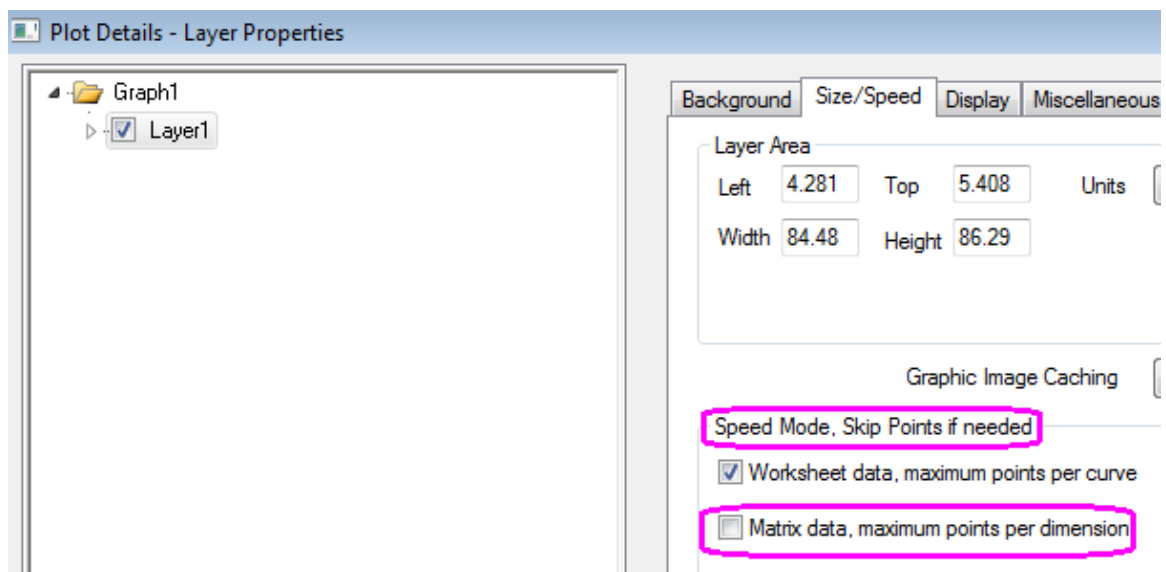

- Expand **Layer1** and select the plot under it.

- To flatten the plot of the US, click on the **Surface** tab and enable the **Flat** option.

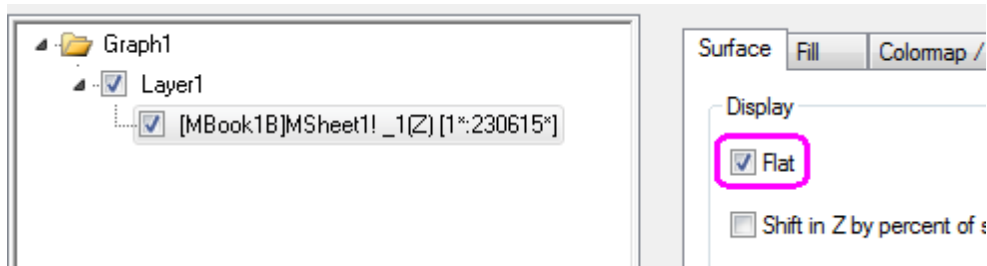

- On the **Fill** tab, click the **Contour fill from matrix** radio button to set the colors according to the matrix information. Deselect the **Fill back surface** check box as well.
- Next click the **Colormap/Contours** tab to set the matrix colors and click **Level...**
- In the **Set levels** dialog that opens, select the **#Major Levels** radio button and set it to **2**. Set the **Total # of Levels** to **2** and click **OK** to close the dialog.

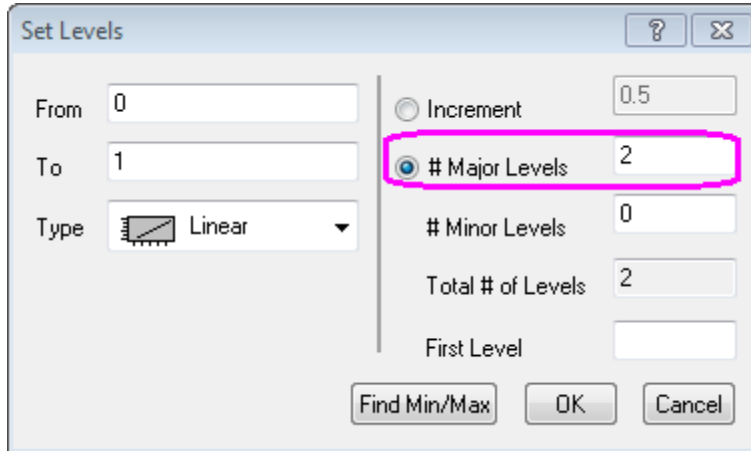

- Click on each color level under the **Fill...** heading to open the **Fill** dialog and choose the color. Set the three colors to **Black**, **Gray** and a customized blue with an RGB of **0, 64, 128** as shown below:

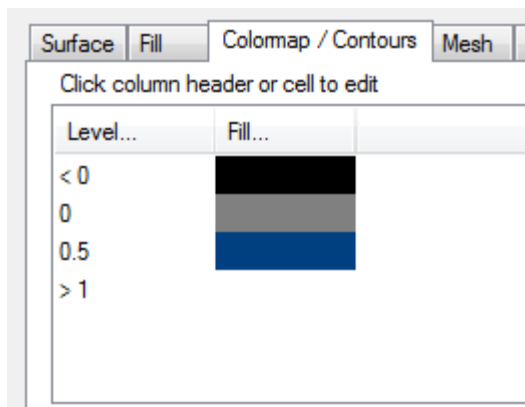

- On the **Mesh** tab, clear the Enable box and click **OK** to close the dialog box.

12. The graph will resemble the image below:

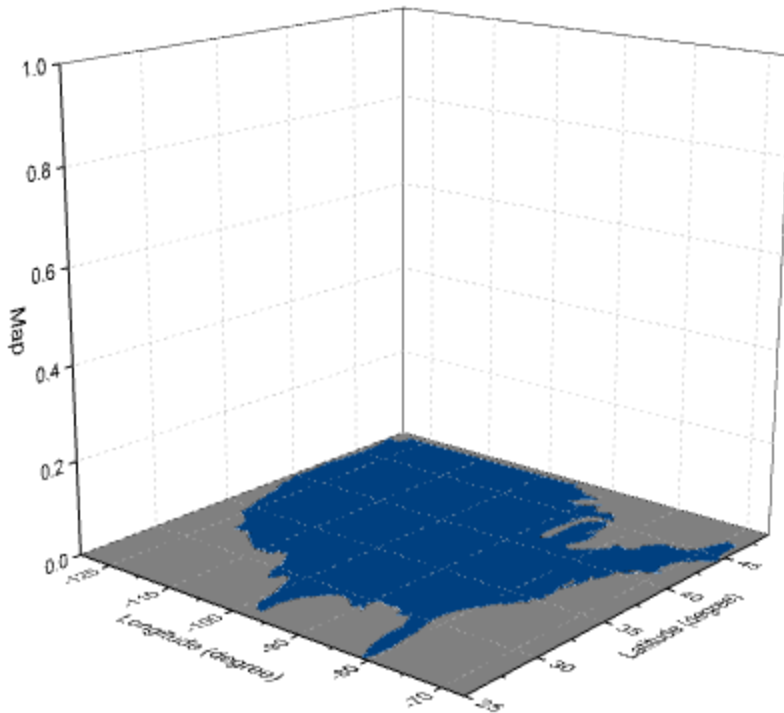

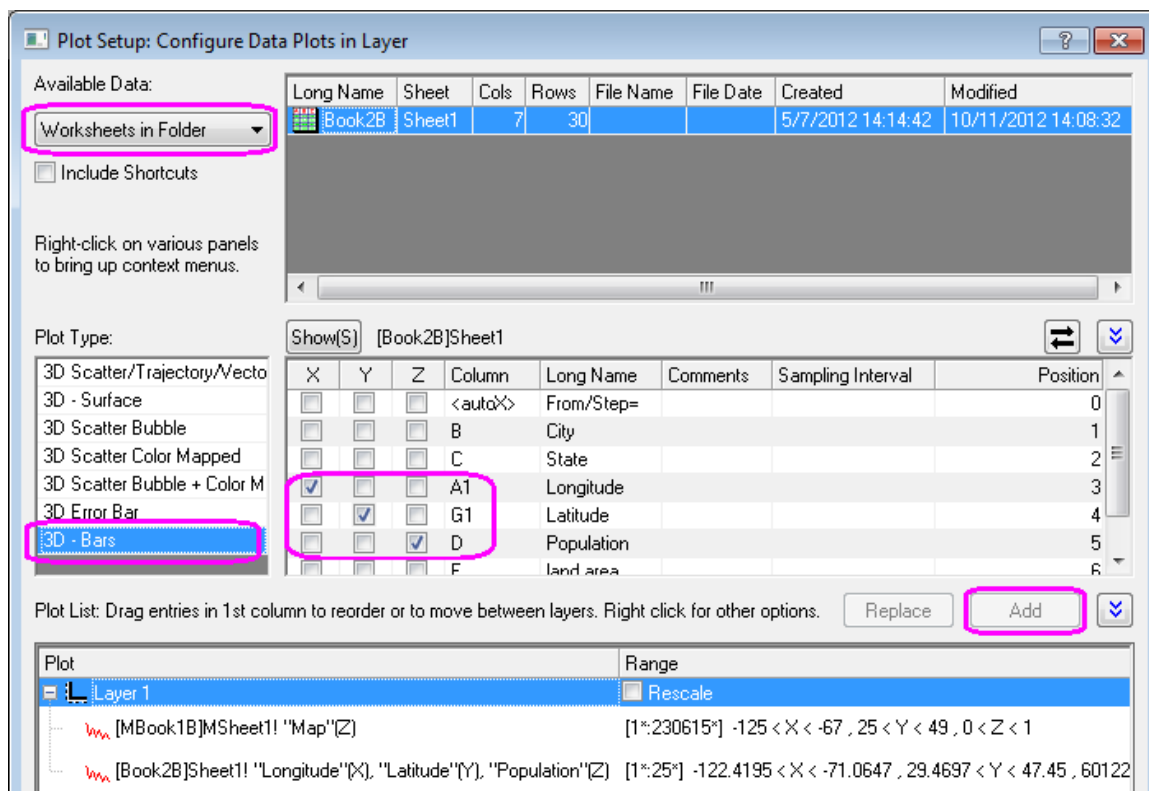

#### 6.2.2.3 Adding and Customizing 3D bars and labels

1. With the graph active select **Graph: Plot Setup** on the Origin menu. This opens the **Plot Setup** dialog box.
2. In the upper-left corner set **Available Data** to **Worksheets in Folder**. This will make the data in *Book2B* available for plotting on the same graph.
3. Select *Book2B*, set **Plot Type** to **3D - Bars**. In the middle panel set X, Y and Z as columns A1, G1 and D, respectively. Click **Add** to add the plot to the current layer:



Click **OK** to exit the dialog box.



In order to show all three panels in **Plot Setup** dialog, please expand **Plot Type** panel by clicking  and expand **Available Data** panel by clicking  again.

Please refer to [Plotting using Plot Setup](#) for more information.

- To customize the 3-D bars, double-click on them to open the **Plot Details** dialog box. On the **Pattern** tab, set the border color to **Wine** and the fill color to **Red**. On the **Outline** tab set the **Width (in %)** to **10**. Click **Apply**
- Next, select the **Label** tab and check the **Enable** box.
- Set the **Label Form** as **Col(B):"City"** so that labels display the city name located in Col(B) of the worksheet.





7. Set the **Position** in **Z** as **Top Outside** with an Offset of **10** and set the **Orientation** in the **YZ** plane. Set the other controls as shown below and click **OK** to close dialog.

8. At this point the labels will not show as the axes scale is too small for them to be in the graph range. Double-click the vertical axis (Z Axis) and go to the **Scale** tab, set **From** to 0 and , **To** to 8000000. Click **OK** to exit.

9. Double-click on the graph again and in the **Plot Details** dialog box, select the **Graph1** option in the left panel. On the **Display** tab set the **Color** to **LT Gray**. Click **OK** to close dialog.
10. Double-click the Z axis title and change it to **Population (Million)**.

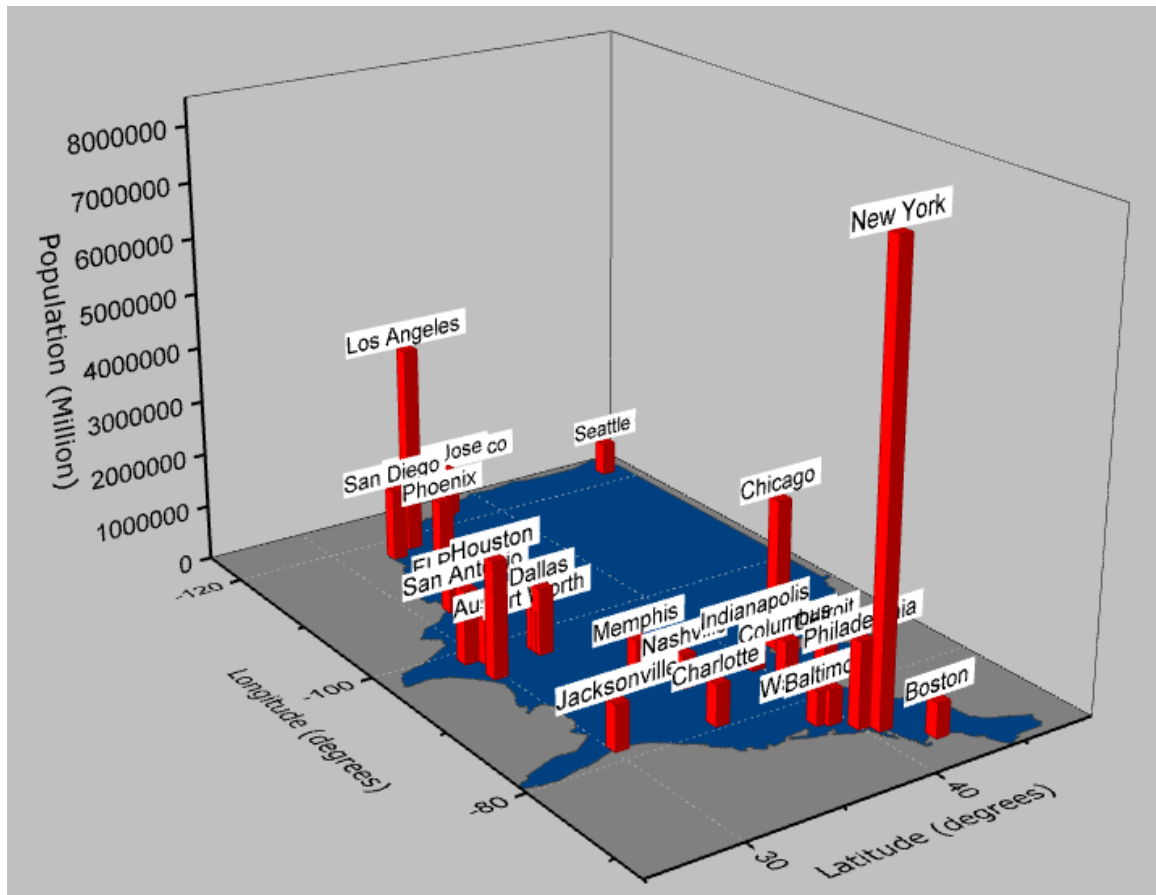
11. The final graph should resemble the one shown below:



12. Since this is a 3D OpenGL Graph, use the  **Rotate Tool** button on the **Tools** toolbar or hold down the **R** key and use the mouse, to rotate. You can also click the graph and select the  button to enter

rotation mode as shown below, or use the controls in the **3D Rotation** toolbar:

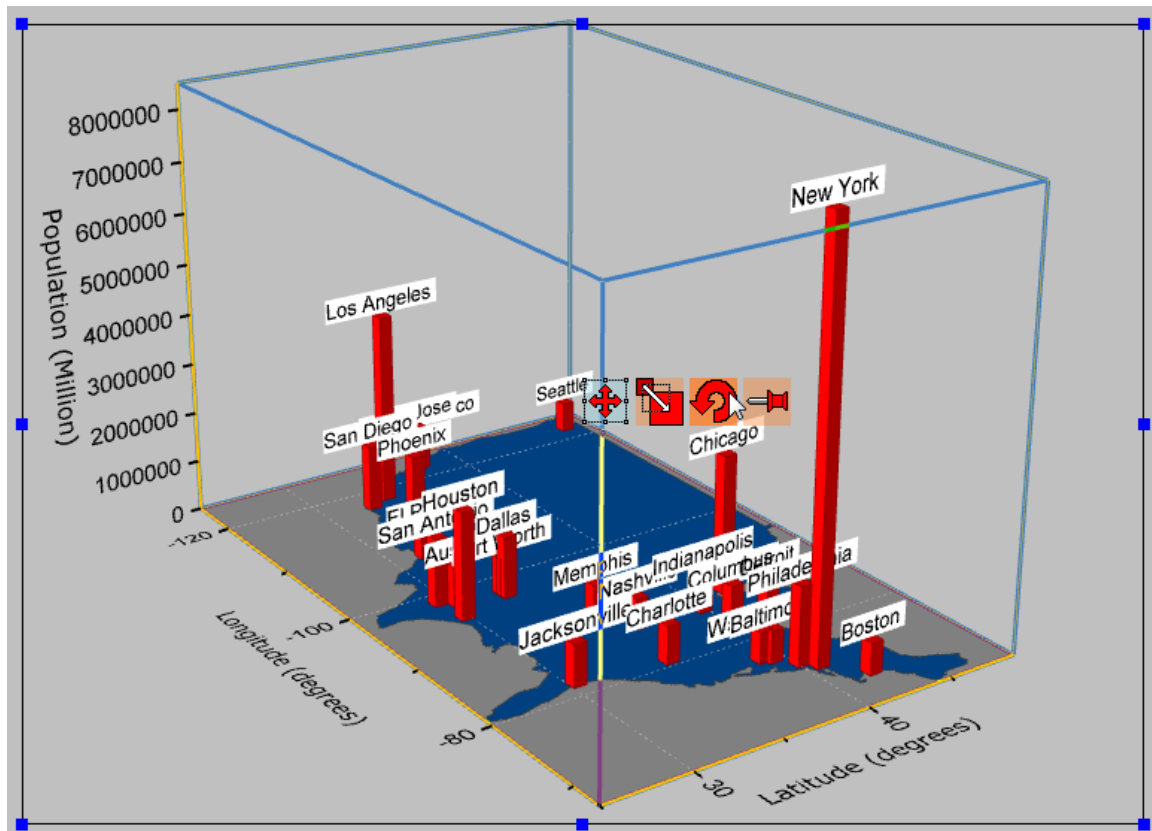

## 6.2.3 Creating a Graph

### 6.2.3.1 Summary

Origin provides templates library. You can create and modify templates by your own and add to the collection. Creating a graph in Origin is as simple as selecting the desired data and then selecting a template from a menu or from the graphing toolbars. The **Plot Setup** dialog offers more flexibility in creating plots, such as plotting data from multiple books or sheets.

Starting with Origin 2016, a more powerful "cloneable" template has been added. These templates are designed for "smart plotting", meaning you can clone a graph with a complicated layer hierarchy or with source data that cannot be specified by simple selection. See [this tutorial on plotting from user-defined graph templates](#) to learn how to save and use both standard and cloneable templates.

This tutorial will show you how to:

- Select data in a worksheet and quickly create a plot
- Change X/Y input of the data plot with context menu
- Add data to or remove it from an existing graph
- Use Plot Setup to plot data from multiple sheets
- Plot groups of plots by label

Minimum Origin Version Required: Origin 2016 SR0

### 6.2.3.2 Create a Plot Quickly by Selecting Data

1. Click the **Import Multiple ASCII** button  to open the dialog for import multiple ASCII, select the files **S15-125-03.dat**, **S21-235-07.dat** and **S32-014-04.dat** from `\Samples\Import and Export\` and click **Add File(s)** to add three files to the lower panel.
2. Make sure **Show Options Dialog** is checked, click the **File Name** column header to sort the files, click **OK**.
3. In the **Import and Export: impASC** dialog Change **Import Options: Import Mode** to **Start New Sheets**. Expand the **(Re)Naming Worksheet and Workbook** node and change settings so that only the sheet gets renamed.

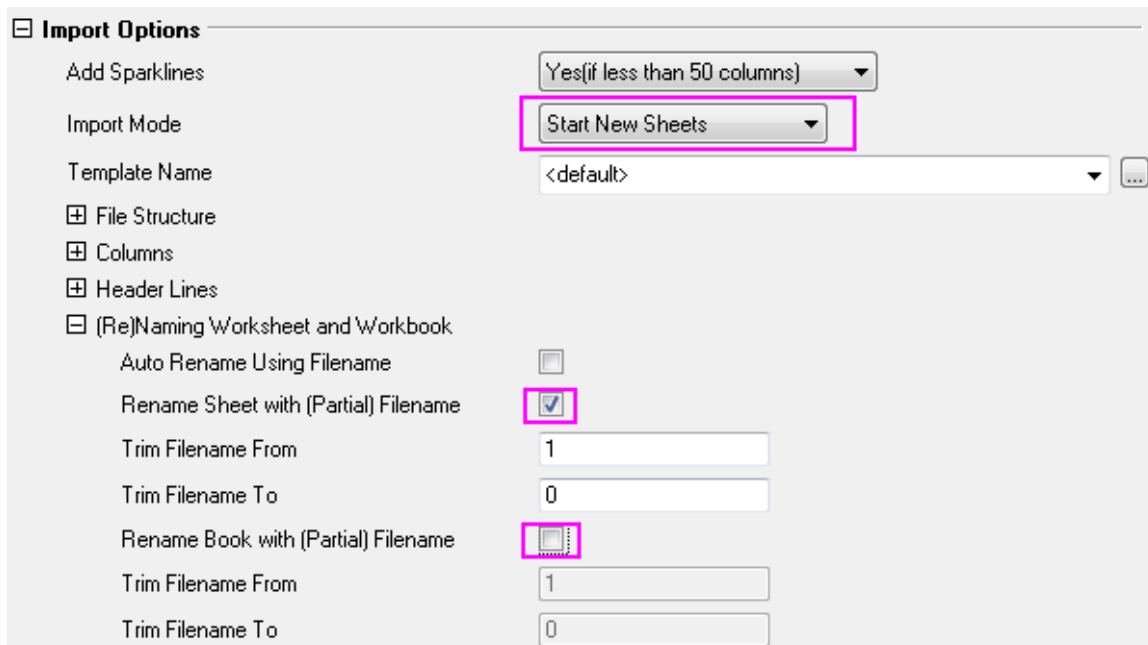

4. Click **OK**. The imported results should appear as below:

4	0.04	39.6	112.5	100.6
5	0.05	40.5	113.1	101.7
6	0.06			101.3
7	0.07			100.4
8	0.08			101.1
9	0.09	39.3	115.4	101

File name as worksheet name

5. Make the third worksheet, S32-014-4, active. To create a three layer graph, highlight the three Y columns, Delta Temperature, Magnetic Field, and Position, and then select **Plot > Basic 2D: 3Ys Y-YY**. Note: There is no need to highlight the Time column, as Origin will automatically plot the Y columns against the associated X column in the worksheet.

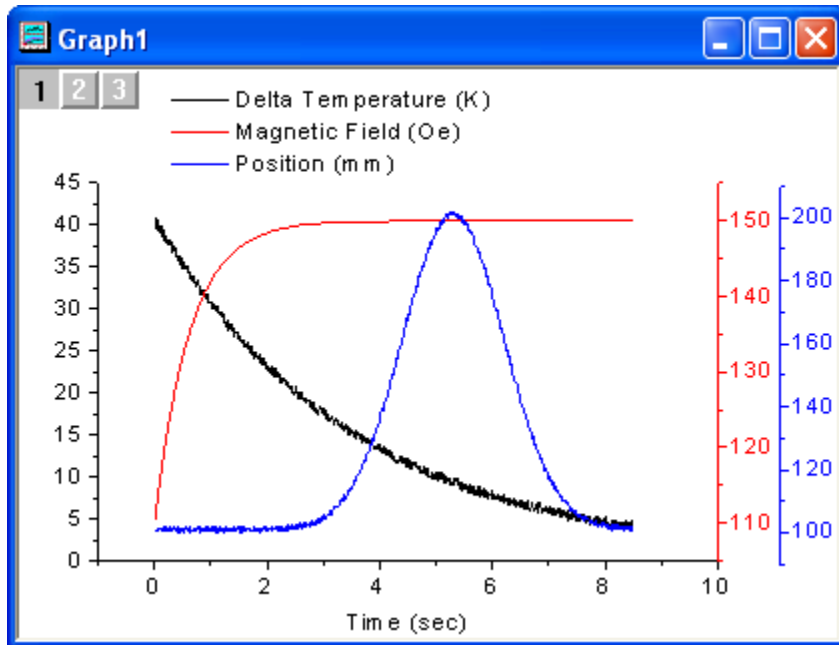

### 6.2.3.3 Change X/Y Data of the Plot

Use the same worksheet from the previous example.

1. Highlight column B and click the **Line** button  to generate a line plot.

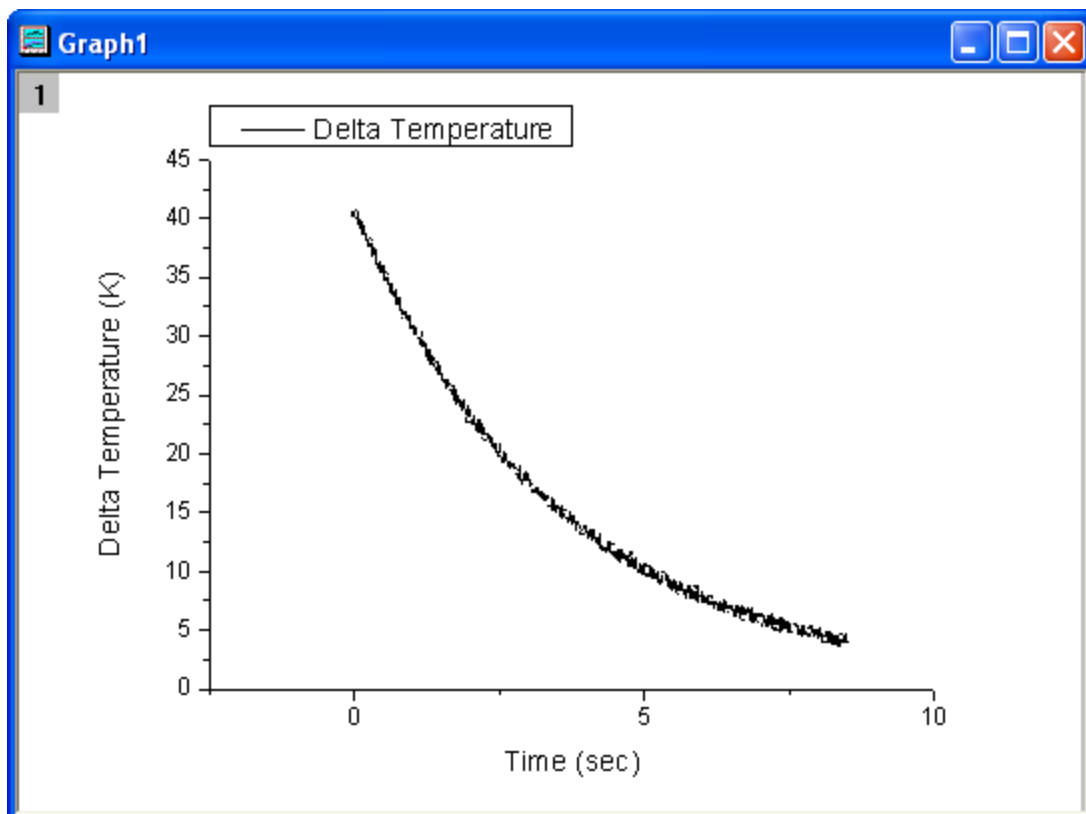

- Right click on the data plot and point to the **Change Y** context menu, then select column C (Magnetic Field) in the fly-out.

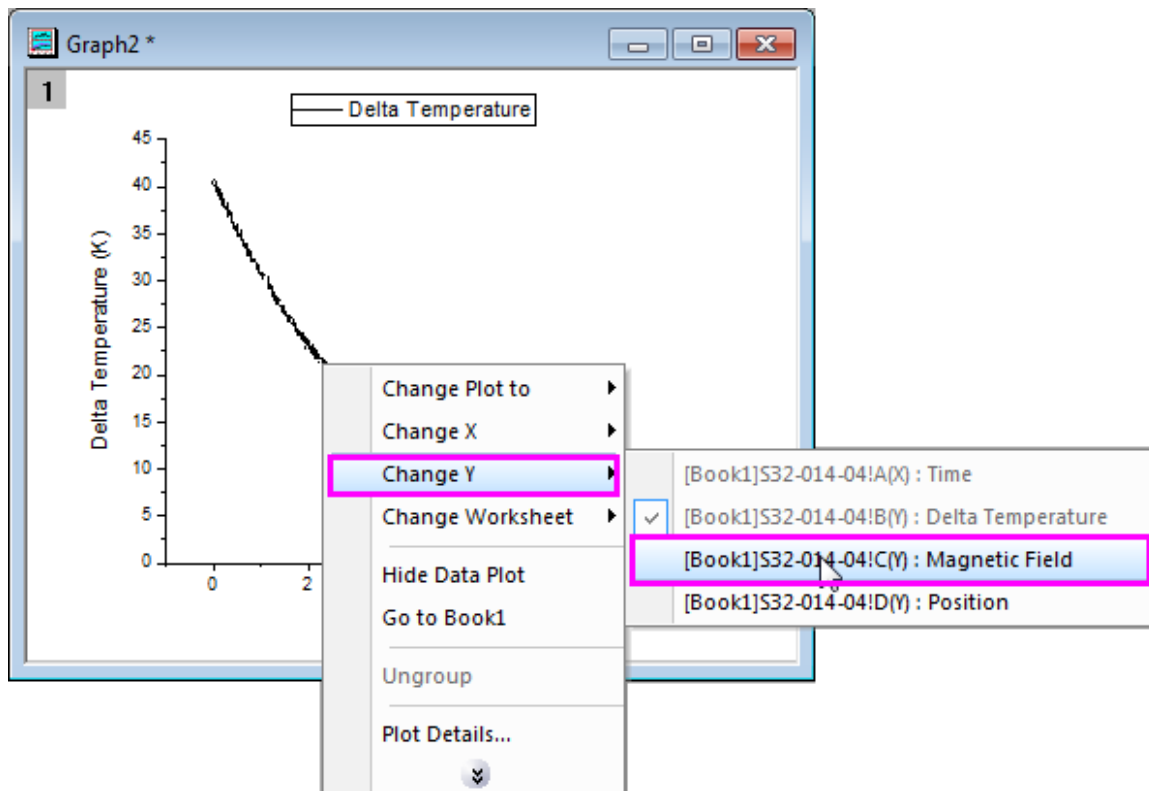

- You may see a reminder message about rescaling the graph to show all data. Choose **Yes** and click **OK** so that the updated plot will be auto-rescaled.

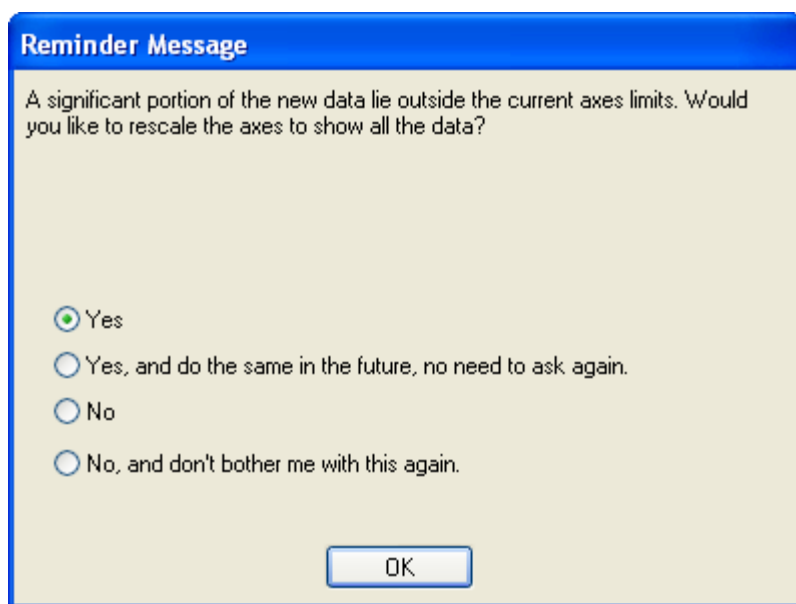

- The plot will update as shown below:

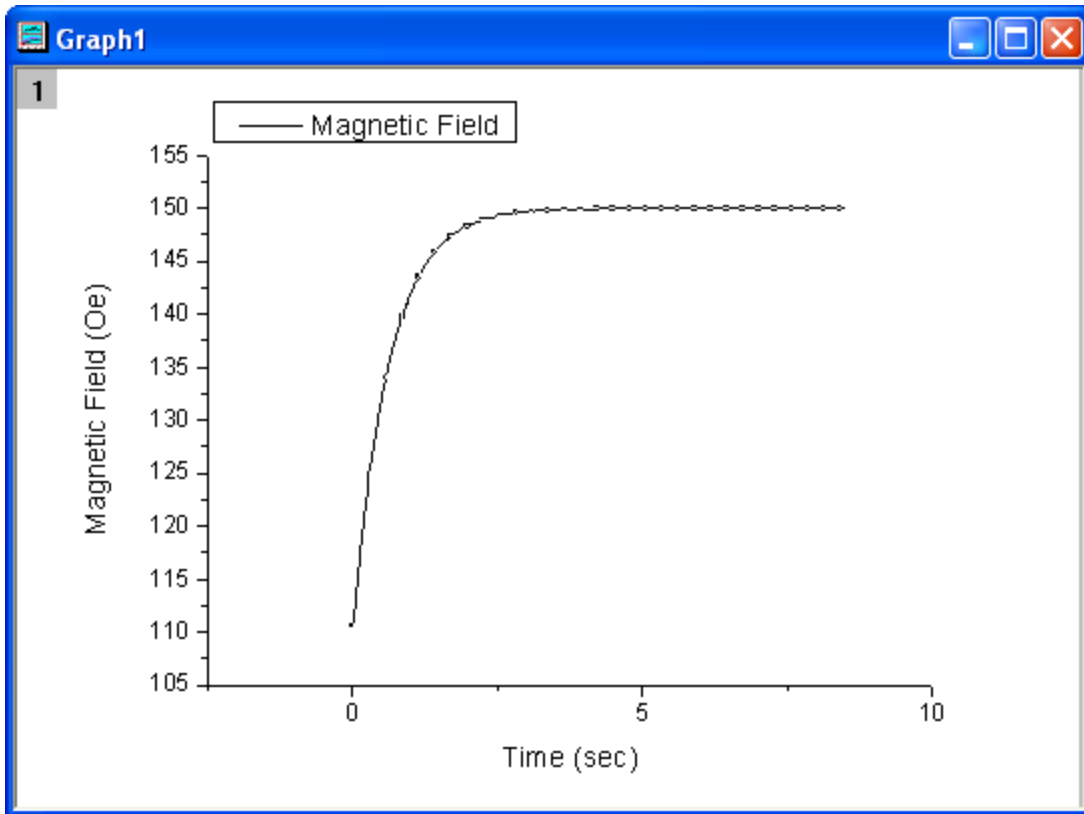

With this context menu, you can change the X or Y data of the current plot to be another column in current sheet. This column will be any column other than the current X or Y data column from the same worksheet, regardless of column designation.

You are also allowed to use the **Change Worksheet** context menu to change the current X and Y data to be the columns with same column index in another worksheet of current workbook, regardless of column designation and column short name.

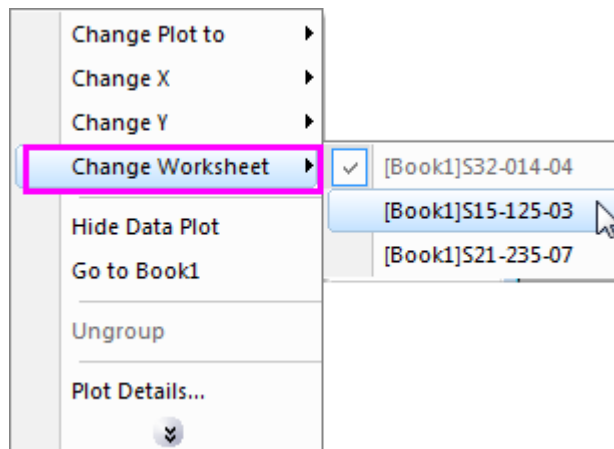

**Note:** You can also use the **Layer Contents** or **Plot Setup** dialog to change the input data.

#### 6.2.3.4 Add Data to an Existing Graph and Update Legend

### 6.2.3.4.1 By Drag and Drop

1. Go back to the book with the three sheets of data from the above example.
2. Highlight the **Delta Temperature** column (Column B) from the first sheet and then select **Plot > Basic 2D: Line** to create a line plot.
3. Go back to the workbook. For each of the remaining two sheets, select the **Delta Temperature**

column and position the cursor at the edge of the column until you see the cursor change to .

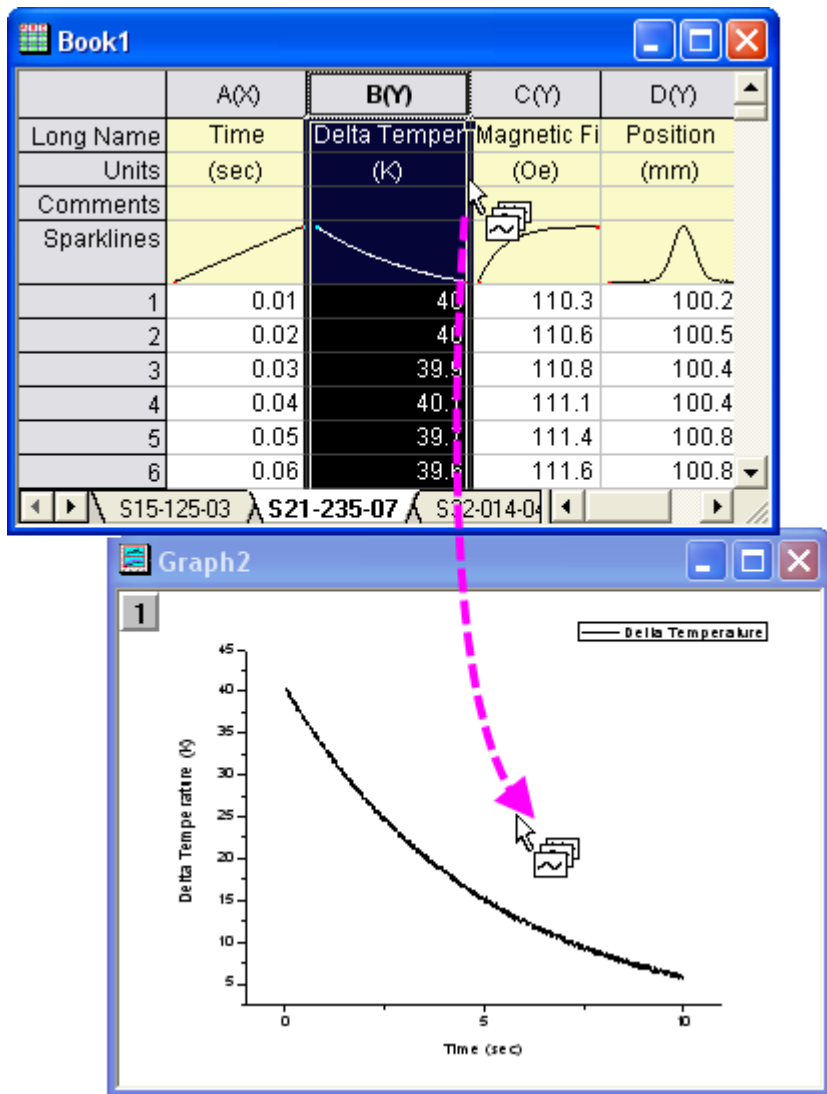

4. Then you can drag-and-drop the column into the graph page. Another curve will be added to the current layer.



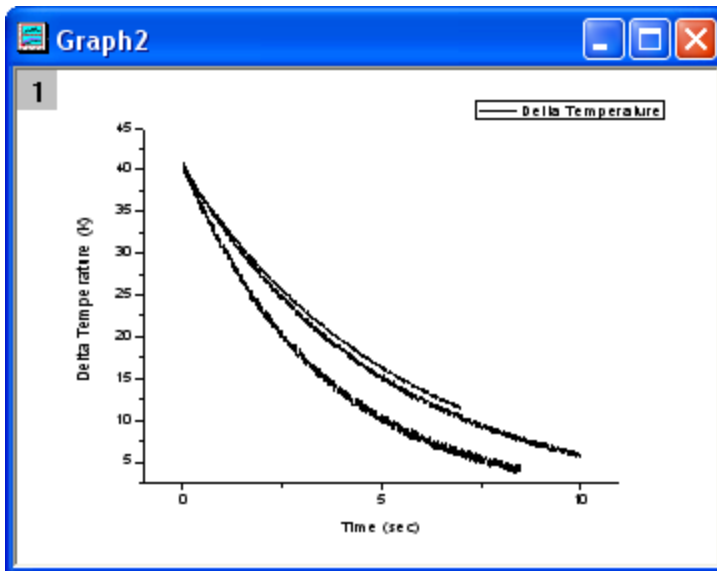

5. After adding the other curves, double-click on the layer icon **1** to open the **Layer Contents** dialog. You need make sure that the **Double click to open Plot Setup** option doesn't been selected in the Context menu(expanded by right-clicking on Layer icon) firstly.

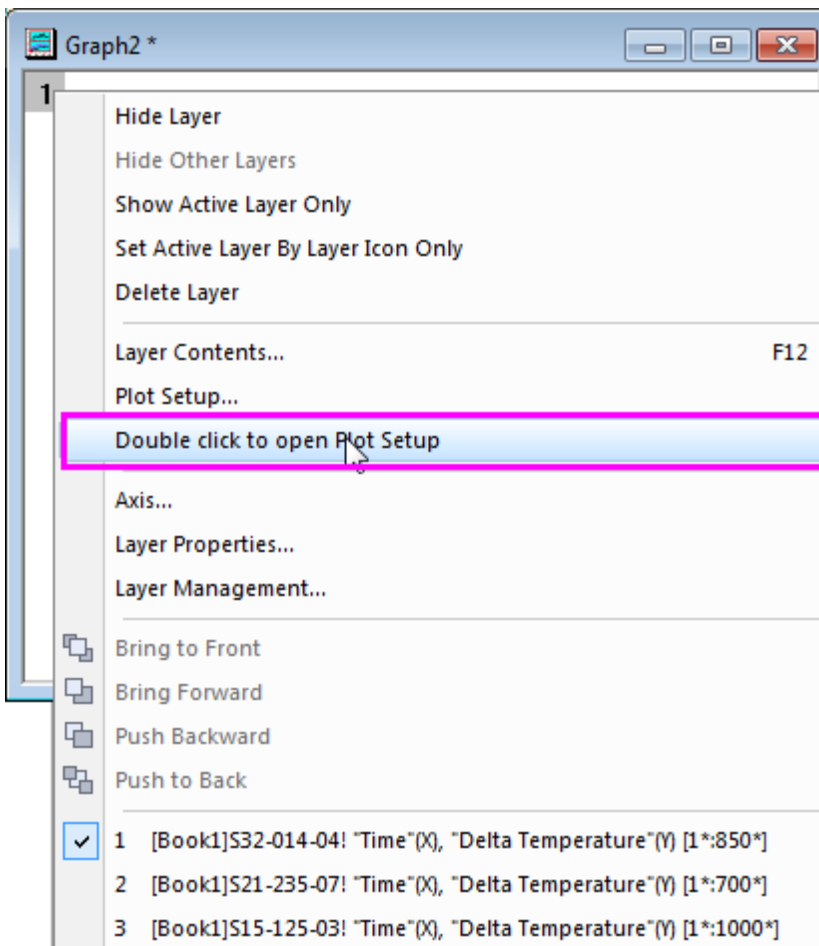

- In the **Layer Contents** dialog, hold **Ctrl** key to select the three items listed in the right panel, then click **Group** button to group the three plots.

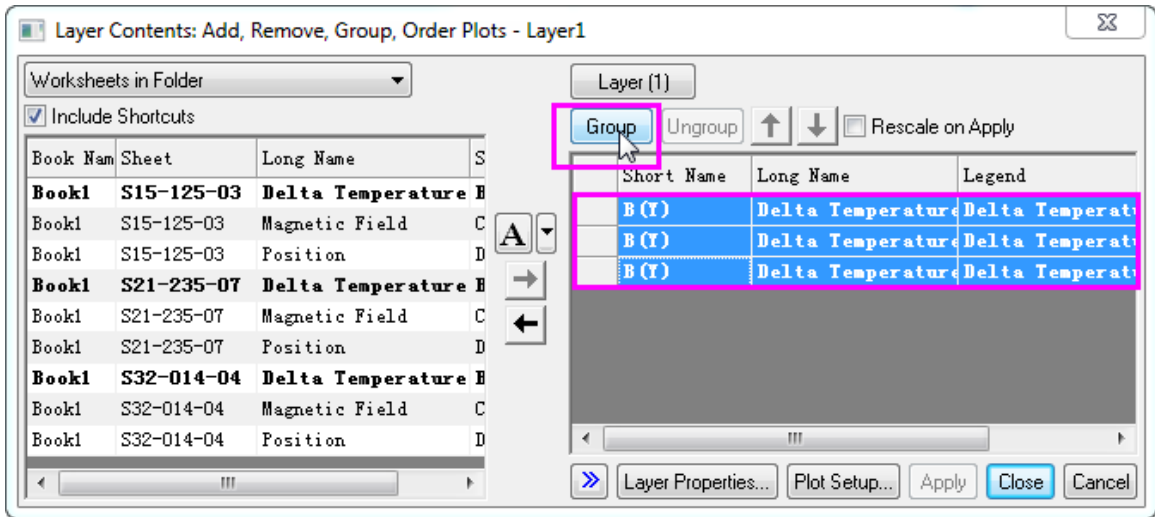

You can also use the **Plot Setup** dialog which can be opened by selecting **Plot Setup...** from the context menu above to do the same setting,

Please refer to [Plotting using Plot Setup](#) for more information.

- Click Ok button to close the dialog. Grouping the plots allows for quick creation of presentation-ready graphs, because each selection in the group is assigned a differentiating set of plot attributes (line color = black, red, green; symbol shape = square, circle, triangle; etc...).

8. Select **Graph: Legend: Update Legend...** to open the *legendupdate* X-Function dialog. Set the **Auto Legend Translation Mode** to *Custom*. Enter *@WS* for **Legend Custom Format**.

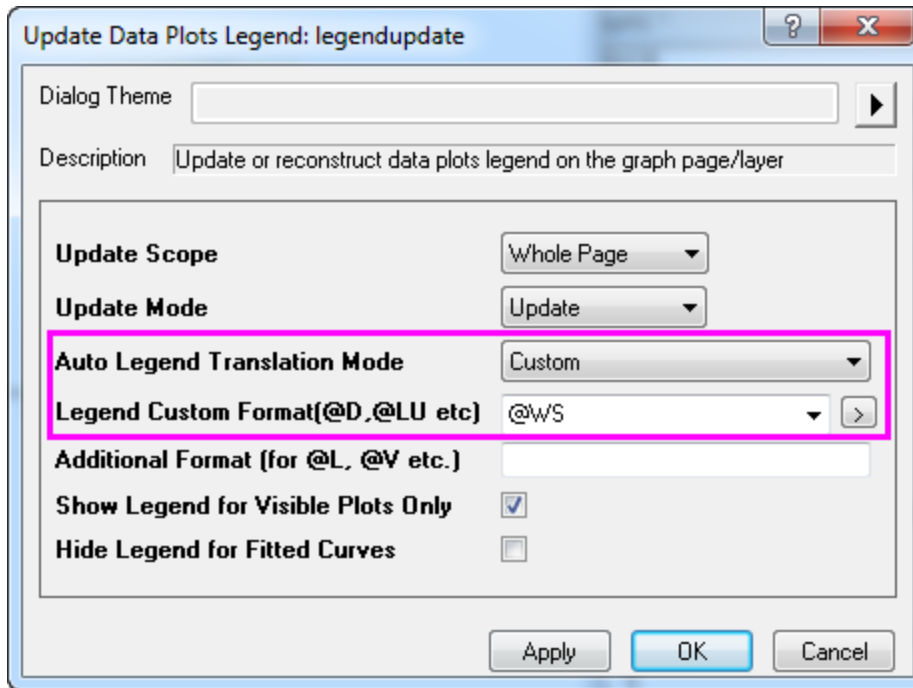

9. Click **OK** and the legend will now contain the worksheet name for each data plot.

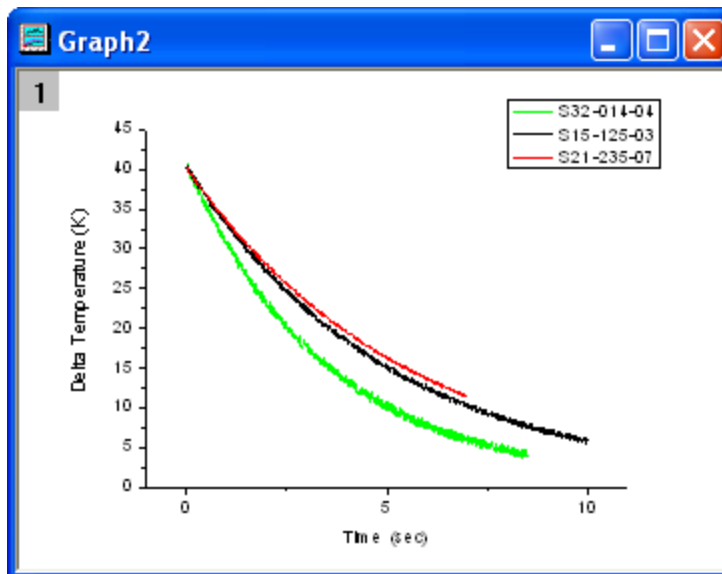

- 10.



The default plot type of the drag and drop plot is **Current**, which is the same as the current active plot. However you could change the default option. To do this, click **Preference: Options** and go to [the Graph tab](#), and change the setting of **Drag and drop plot** drop-down menu.

#### 6.2.3.4.2 By Layer Contents Dialog

The **Layer Contents** dialog box is useful primarily for adding or removing data plots from the graph layer. Starting with Origin 2016, you can switch layers without closing the dialog box, making it easier to add plots to, or remove plots from, a multi-layer graph. To demonstrate, we will return to the 3-layer graph that we created in the first exercise in this tutorial:

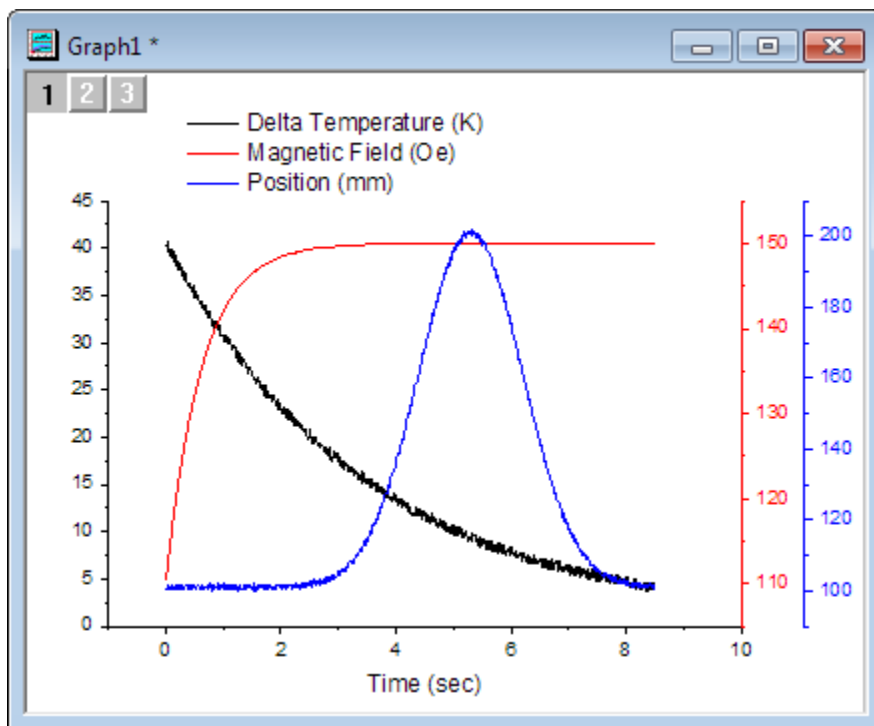

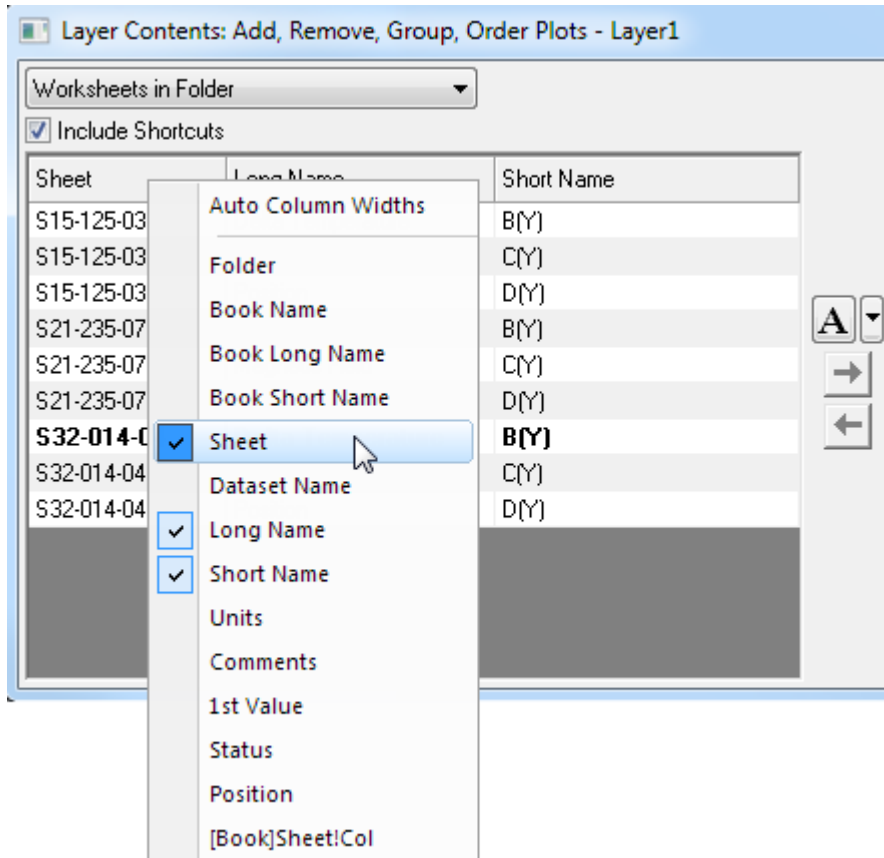

In the first exercise, we plotted data from sheet S32-014-04. In this exercise, we will swap the data from sheet S32-014-04 with data from sheet S21-235-07.

1. Right-click on the layer **1** icon in the upper-left corner of the graph window and choose **Layer Contents**.
2. In the dialog box that opens, click the drop-down list in the upper-left corner and select **Worksheets in Folder**.
3. Right-click on the left-panel headings, clear **Book Name** and select **Sheet** (if not already displaying) so that you can see which worksheets contain which workbook datasets, then click on the Sheet heading to sort datasets by sheet name.

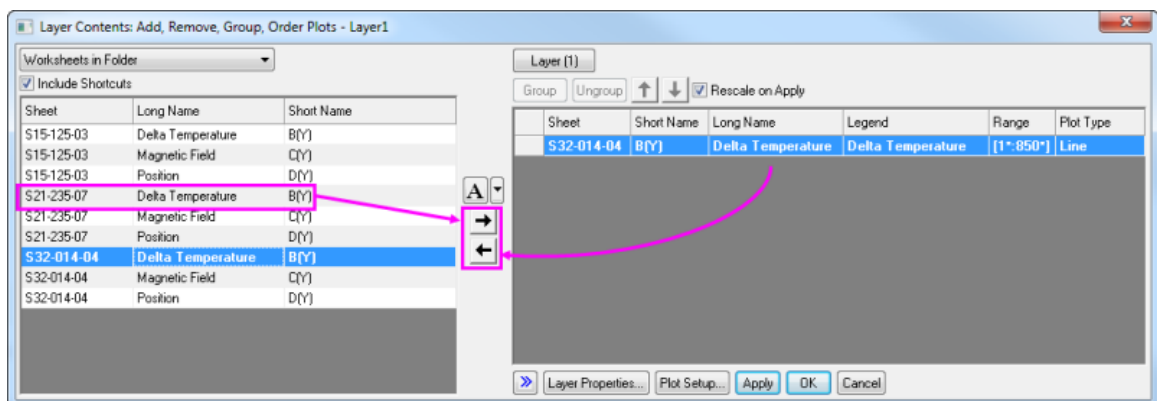

4. In the right-hand panel of Layer Contents, select **Delta Temperature** from sheet S32-014-04 and click the **Remove Plot** button  to remove the plot from graph layer 1.



5. In the left-hand panel, select **Delta Temperature** from sheet S21-235-07 and click the **Add Plot** button , then click **Apply** to add the new plot to layer 1. You have now swapped one dataset for another.
6. Click the **Layer(1)** button at the top of the dialog and choose **Switch Layer > 2. Layer 2**.
7. Repeat the process of removing the existing **Magnetic Field** dataset from layer 2 and replacing it with the **Magnetic Field** dataset from sheet S21-235-07, then click **Apply**.

- Click the **Layer (2)** button and choose **Switch Layer > 3.Layer 3** and repeat the process of swapping the **Position** dataset in sheet S32-014-04 with the Position dataset in sheet S21-235-07, then click **Apply** and close the dialog box.

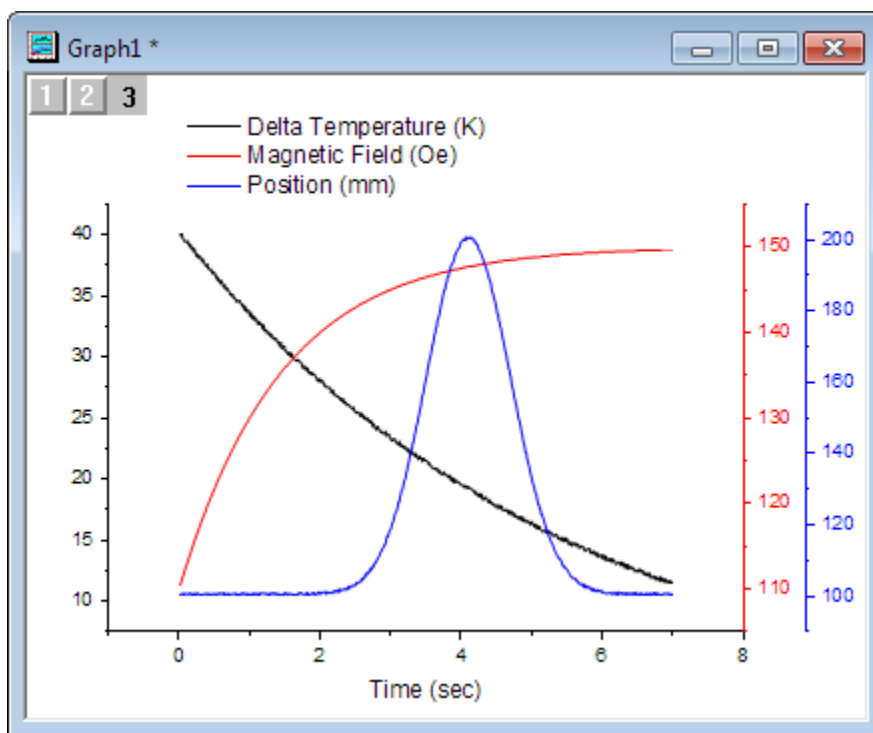

### 6.2.3.5 Create a Plot using Plot Setup

The Plot Setup dialog box is useful for a variety of plotting tasks, including creating graphs, modifying the plot type, adding plots to or removing plots from the graph, grouping or ungrouping plots, and editing the plot range.

- Return to your workbook and ensure that no data are selected. It doesn't matter which worksheet is active; what is important is that no columns are highlighted.
- Select **Plot > Basic 2D: 4 Panel** from the menu. When no data are selected, Origin opens the **Plot Setup** dialog, allowing you to choose the data you wish to plot.
- Expand the top panel by clicking the  button. Hold down **Ctrl** key to highlight the three worksheets. Alternatively, you can just click and drag your selection so that all three worksheets are highlighted.

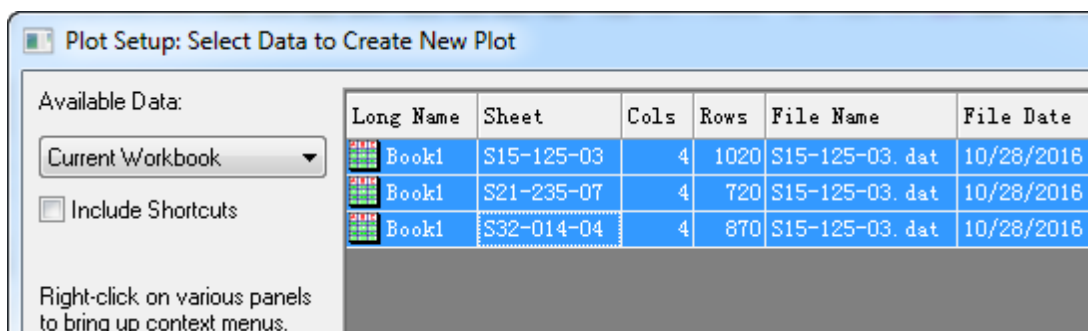

4. In the middle panel, common columns in all three sheets are displayed. In this case, all three sheets have similar data with matching column names. Click the button  at top-right of this panel to show the available plot columns listed with similar column long name. This mode is easier because you don't have to check the X and Y designation check boxes.

X	Y	yEr	L	Column	Long Name	Comments
<input type="checkbox"/>	<input type="checkbox"/>	<input type="checkbox"/>	<input type="checkbox"/>	<autoX>	From/Step=	
<input type="checkbox"/>	<input type="checkbox"/>	<input type="checkbox"/>	<input type="checkbox"/>	A	Time	
<input type="checkbox"/>	<input type="checkbox"/>	<input type="checkbox"/>	<input type="checkbox"/>	B	Delta Temperature	
<input type="checkbox"/>	<input type="checkbox"/>	<input type="checkbox"/>	<input type="checkbox"/>	C	Magnetic Field	
<input type="checkbox"/>	<input type="checkbox"/>	<input type="checkbox"/>	<input type="checkbox"/>	D	Position	



Column	Long Name	Comments	Sampling Interval
B(Y)	Delta Temperature		
C(Y)	Magnetic Field		
D(Y)	Position		

5. Open the bottom panel of the dialog, the Plot List, if it is not already visible. **Layer 1** is highlighted. Select **Delta Temperature** in the middle panel, and then click the **Add** button. Since you already selected the three worksheets in Step 3, this will add all **Delta Temperature** columns from the selected worksheets to

layer 1.

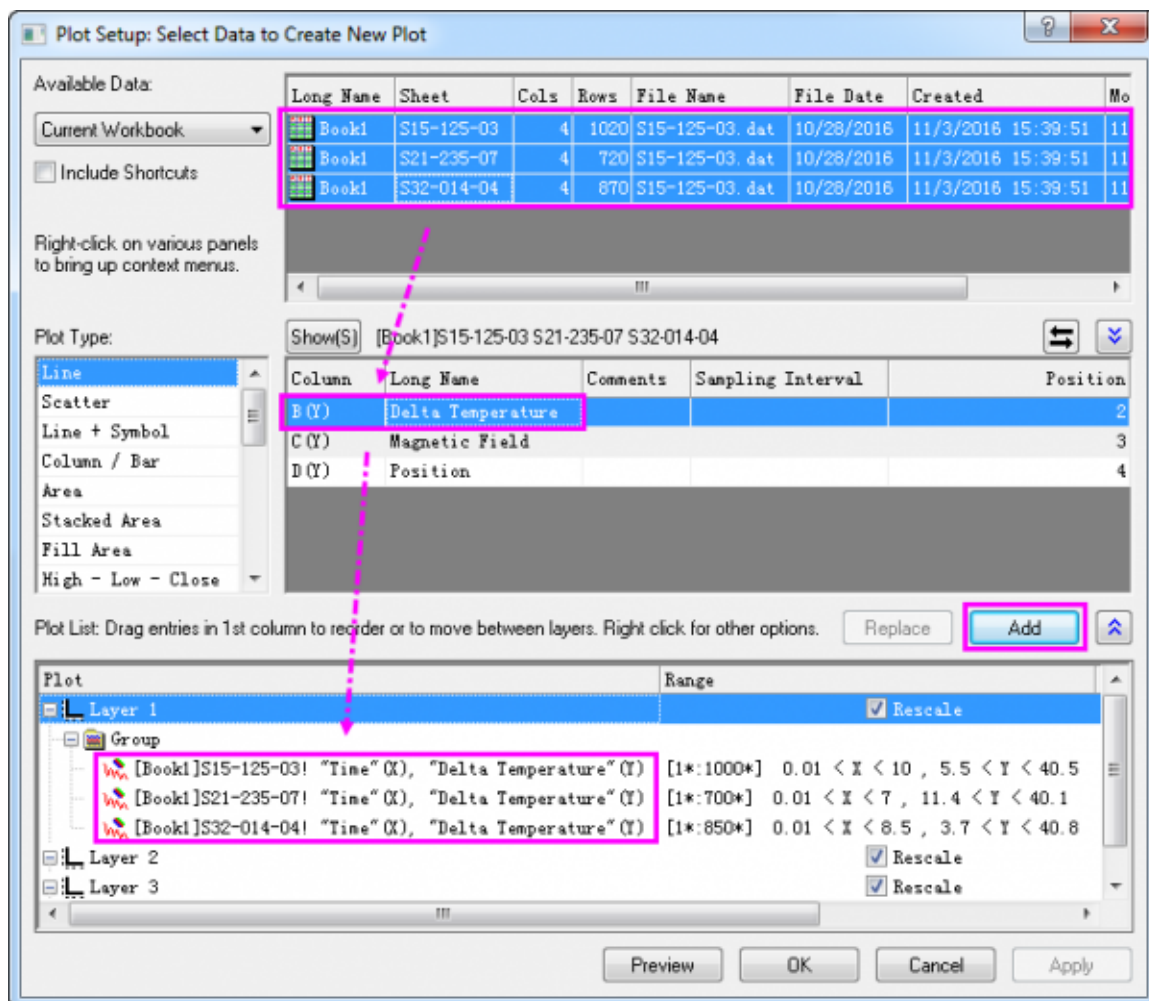

- Repeat these steps to add all **Magnetic Field** columns and all **Position** columns into Layer 2 and Layer 3, respectively.



Plot	Range	Show	Plot Type
Layer 1	<input checked="" type="checkbox"/> Rescale	<input checked="" type="checkbox"/>	
Group			
[Book1]S15-125-03! "Time"(X), "Delta Temperature"(Y) [1*:1000"]	<input checked="" type="checkbox"/>	<input checked="" type="checkbox"/>	Line
[Book1]S21-235-07! "Time"(X), "Delta Temperature"(Y) [1*:700"]	<input checked="" type="checkbox"/>	<input checked="" type="checkbox"/>	Line
[Book1]S32-014-04! "Time"(X), "Delta Temperature"(Y) [1*:850"]	<input checked="" type="checkbox"/>	<input checked="" type="checkbox"/>	Line
Layer 2	<input checked="" type="checkbox"/> Rescale	<input checked="" type="checkbox"/>	
Group			
[Book1]S15-125-03! "Time"(X), "Magnetic Field"(Y) [1*:1000"]	<input checked="" type="checkbox"/>	<input checked="" type="checkbox"/>	Line
[Book1]S21-235-07! "Time"(X), "Magnetic Field"(Y) [1*:700"]	<input checked="" type="checkbox"/>	<input checked="" type="checkbox"/>	Line
[Book1]S32-014-04! "Time"(X), "Magnetic Field"(Y) [1*:850"]	<input checked="" type="checkbox"/>	<input checked="" type="checkbox"/>	Line
Layer 3	<input checked="" type="checkbox"/> Rescale	<input checked="" type="checkbox"/>	
Group			
[Book1]S15-125-03! "Time"(X), "Position"(Y) [1*:1000"]	<input checked="" type="checkbox"/>	<input checked="" type="checkbox"/>	Line
[Book1]S21-235-07! "Time"(X), "Position"(Y) [1*:700"]	<input checked="" type="checkbox"/>	<input checked="" type="checkbox"/>	Line
[Book1]S32-014-04! "Time"(X), "Position"(Y) [1*:850"]	<input checked="" type="checkbox"/>	<input checked="" type="checkbox"/>	Line
Layer 4	<input type="checkbox"/> Rescale	<input checked="" type="checkbox"/>	

Note that in each layer, the three data plots are automatically grouped.

- Click the **OK** button to create the graph.

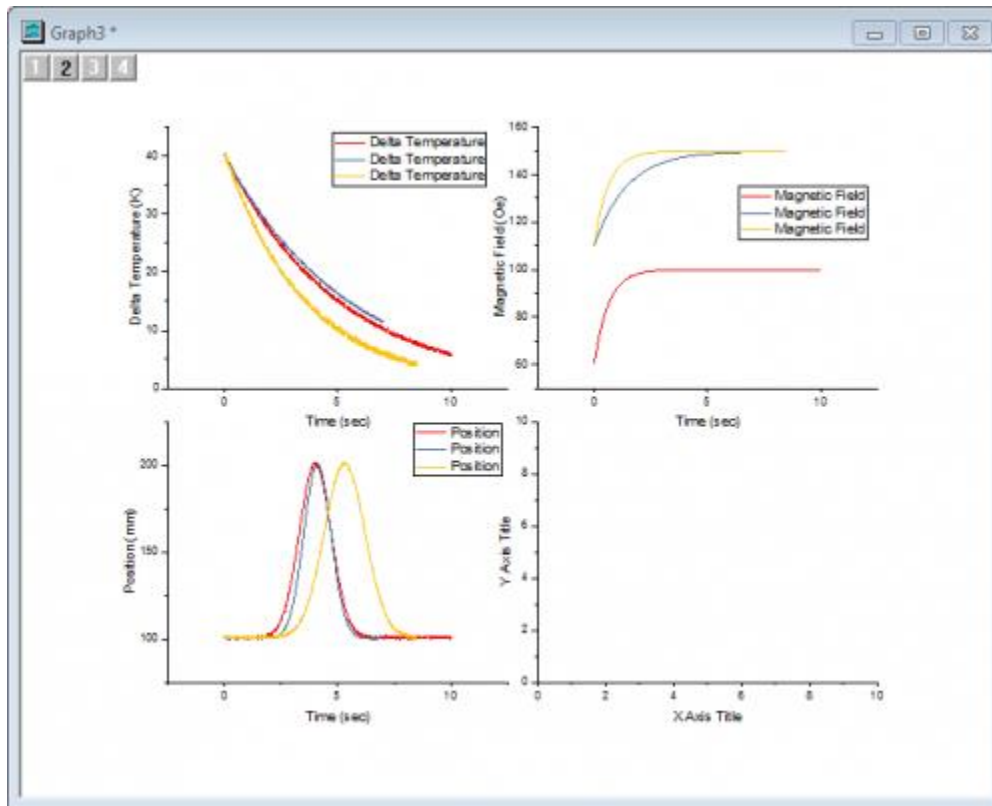

- You'll note that the default legend that is created for each layer is not particularly helpful. The Origin graph legend object is highly customizable, so before we go further, we will modify the default legend. Right-click on any of the legend objects and select **Legend: Update Legend** from the shortcut menu.

9. In the dialog box that opens, do the same settings at step 8 of the section [By Drag and Drop](#). Note that the **Legend Custom Format** syntax **@WS** is [LabTalk Substitution Notation](#) for the name of the worksheet containing the data for each line plot.
10. We have one extra (empty) layer on the graph page. To delete that layer, click on it once to select it then press the **Delete** key on the keyboard. Take care not to delete the graph window as we will use it in the next section of this tutorial.

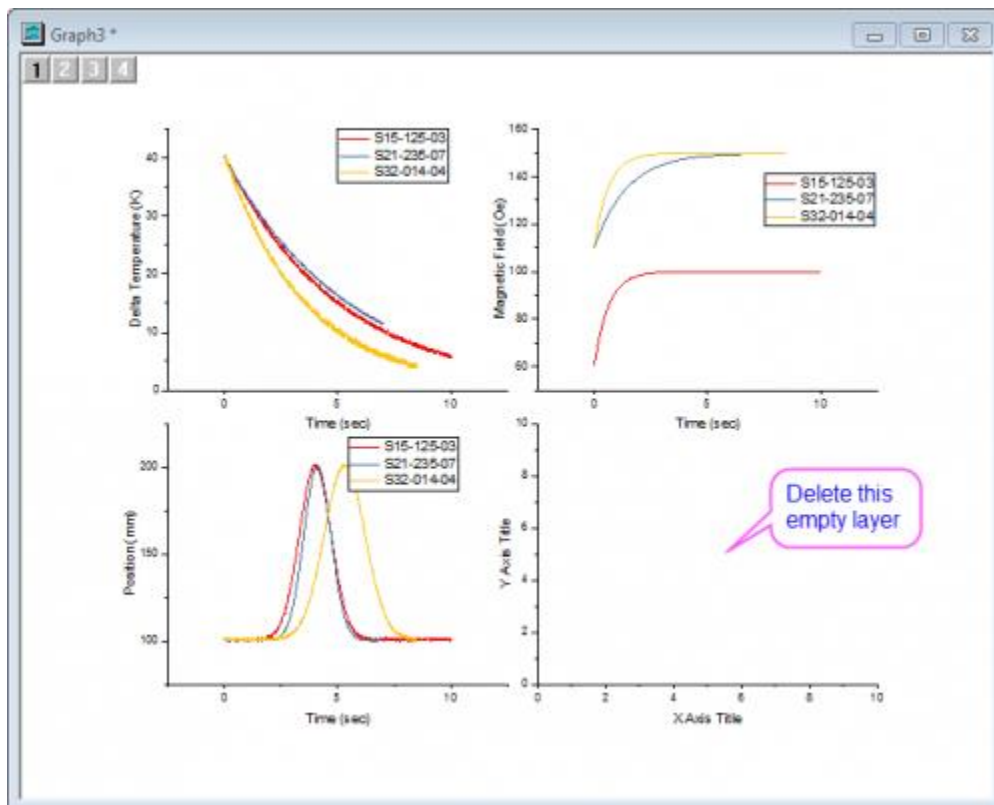

In the graph above, the legend for each layer is same with each other. You can delete two of them. Or do settings below in [the Legend Update dialog](#), to just show one legend for whole graph window.

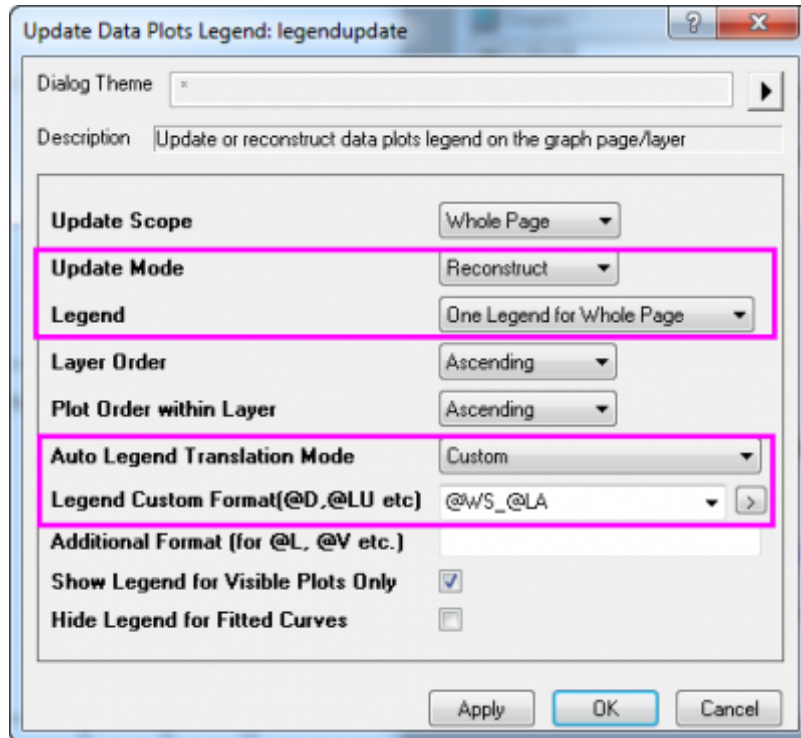

Once the settings are applied, you can press Ctrl + double-click on the legend text to do further in-place edits; or you can right-click on the legend box to select **Properties...** from context menu and do further advanced editing in the [Text Object](#) dialog.

#### 6.2.3.6 Plot Grouped Data As

When your data includes a column of categorical data, or multiple columns characterizing some sort of nested sub-grouping of data, just as the data below

备注	A(X)	B(Y)	C(Y)	D(Y)	E(Y)
Long Name	name	age	gender	height	weight
Units		Years		cm	kg
Comments		<b>Categorical Data</b>		<b>Data to plot</b>	
F(x)=					
1	Kate	12	F	146	42.2
2	Lose	12	F	150	55.4
3	Jane	12	F	136	33.2
4	Sophia	12	F	163	65
5	Grace	12	F	128	28.7
6	Tom	12	M	148	38
7	James	12	M	150	58
8	Sun	12	M	126	35.9
9	Barb	13	F	148	50.6
10	Alice	13	F	150	47.9
11	Susan	13	F	138	30.1
12	John	13	M	160	44.5
13	Joe	13	M	155	46.9
14	Mike	13	M	143	42.6
15	David	13	M	146	35.2
16	Judy	14	F	150	36.8
17	Kitty	14	F	153	40.7
18	Leslie	14	F	160	64.1
19	Carol	14	F	155	37.7
20	Patty	14	F	153	38.5
21	Fred	14	M	155	42.2
22	Alfred	14	M	158	44
23	Henry	14	M	160	53.6
24	Lewis	14	M	158	41.3
25	Edward	14	M	168	49.8

then you might want to plot your data as:

### 6.2.3.6.1 Trellis Plot

Beginning with Origin 2017, you have introduced the [Trellis Plot](#) which has one layer but with  $M \times N$  panels.

1. New a workbook. Click the button  to import the file <Origin program folder>/\Samples\Statistics\2010.dat into the active worksheet.
2. Highlight col(H)~col(J) to select **Plot> Categorical : Trellis Plot** menu. The dialog [plot\\_group](#) will pop up. Select col("City") as horizontal group variable and col("Gender") as vertical group variable for the

panels.

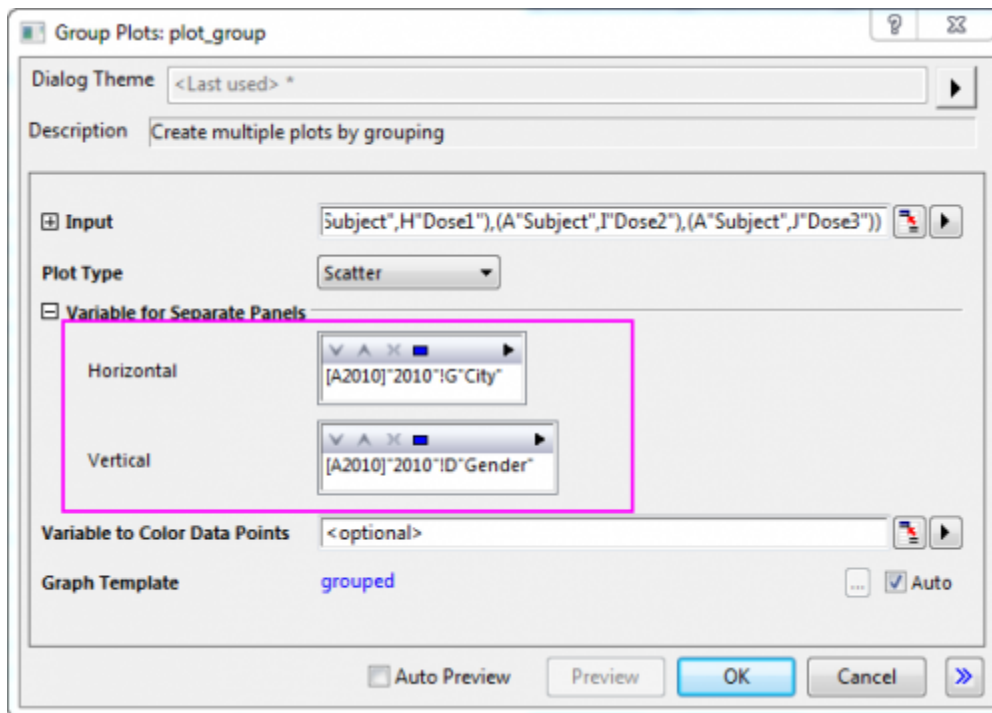

3. Click OK button to plot the graph. Double-click on the X axis to open the **Axis** dialog, set **From** and **To** for horizontal axis to -10 and 90 in the **Scale** tab. You will get the graph as below:

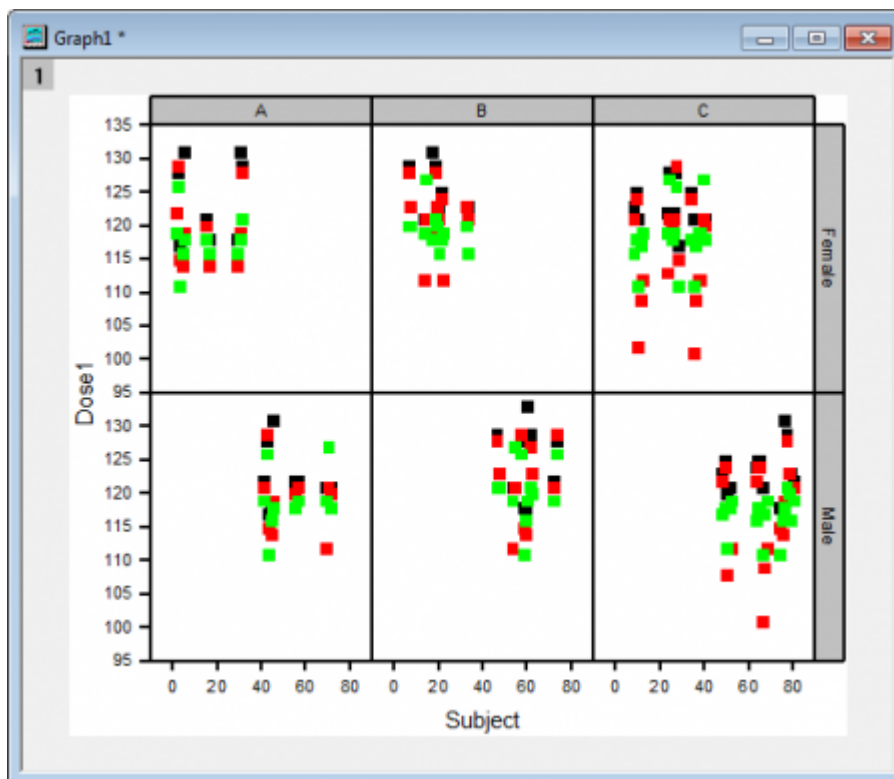

4. Just as you can see, this trellis plot has only one layer but with six panels(**2x3**): 2 rows represent the variable "Gender", *Female* and *Male*; three columns represent the variable "City", *A*, *B*, and *C*.

### 6.2.3.6.2 Grouped Box Plot

Besides the trellis plot, you can also plot these kind of data as a grouped box/column plot.

1. Active the source worksheet above again. Highlight col("Salary") to select **Plot > Categorical : Grouped Box Charts - Indexed Data** menu to open the dialog [plot\\_gdoxindexed](#). Select col("Gender") and col("City") as **Group Columns**.

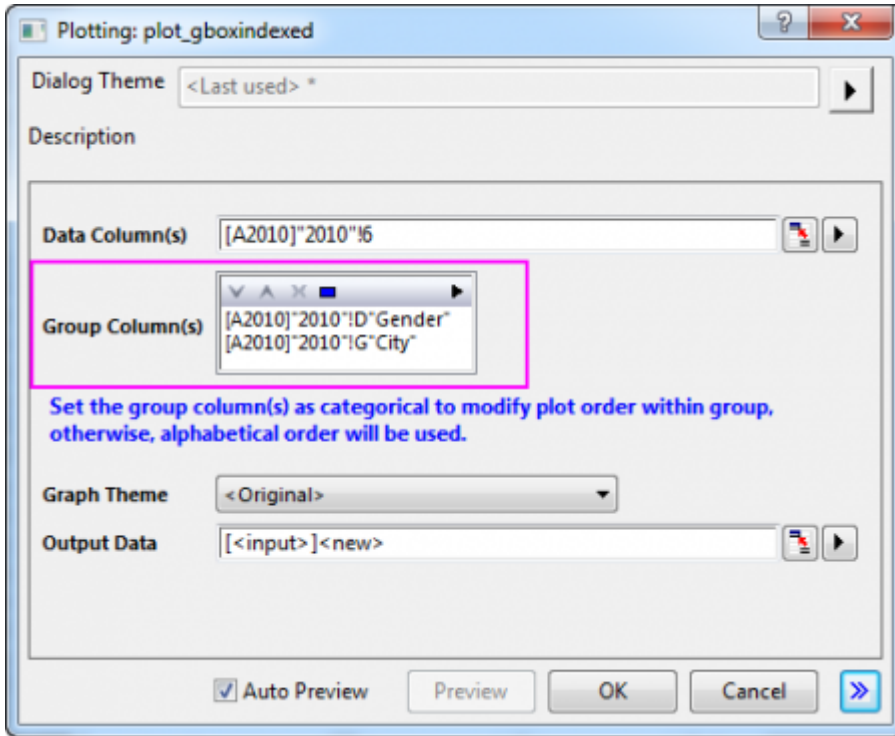

2. Click OK button to plot the graph.

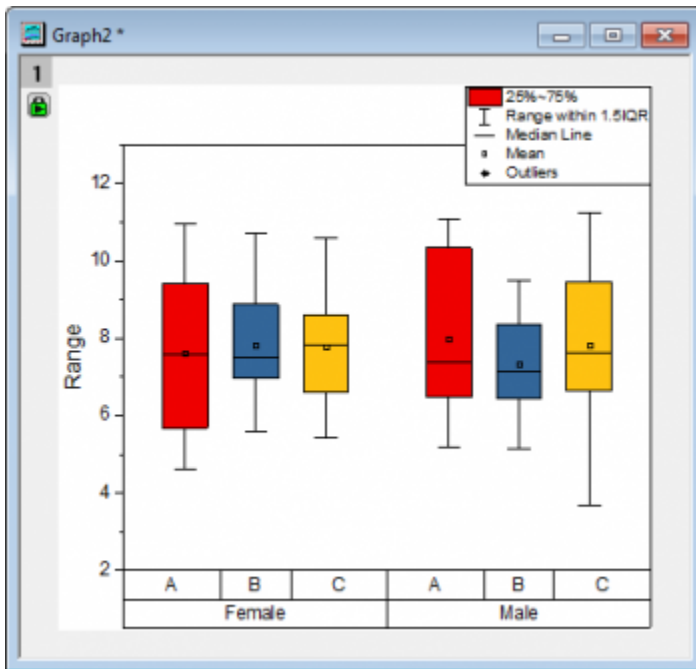

- Just as you can see, the data col("Salary") has been plotted as a grouped box charts: Two groups by "Gender", *Female* and *Male*; within these two groups, three subgroups by "City" , *A*, *B*, and *C*.

### 6.2.3.7 Plot Graphs by Label

Origin offers a plotting option, **Multiple Panels by Label**, that allows you to create a multilayer graph, each layer of which contains multiple plots, identified by the same label.

- Open the file **Samples\Graphing\Automobile Data.ogw** (Hint: Make sure that your Open files filter is set to **Workbooks(\*.ogw)**).

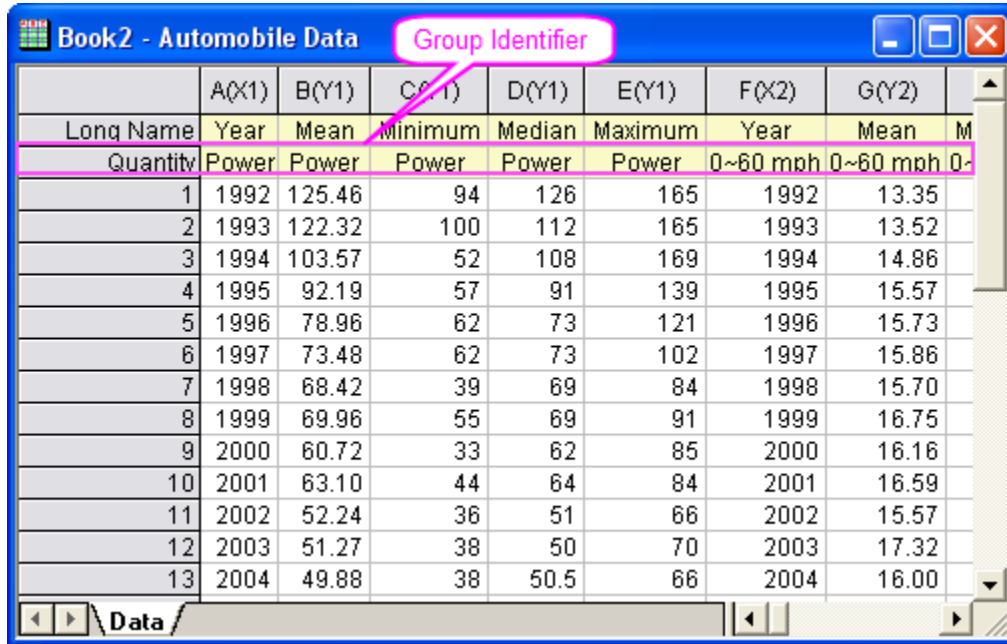

	A(X1)	B(Y1)	C(Y1)	D(Y1)	E(Y1)	F(X2)	G(Y2)	
Long Name	Year	Mean	Minimum	Median	Maximum	Year	Mean	M
Quantity	Power	Power	Power	Power	Power	0~60 mph	0~60 mph	0~
1	1992	125.46	94	126	165	1992	13.35	
2	1993	122.32	100	112	165	1993	13.52	
3	1994	103.57	52	108	169	1994	14.86	
4	1995	92.19	57	91	139	1995	15.57	
5	1996	78.96	62	73	121	1996	15.73	
6	1997	73.48	62	73	102	1997	15.86	
7	1998	68.42	39	69	84	1998	15.70	
8	1999	69.96	55	69	91	1999	16.75	
9	2000	60.72	33	62	85	2000	16.16	
10	2001	63.10	44	64	84	2001	16.59	
11	2002	52.24	36	51	66	2002	15.57	
12	2003	51.27	38	50	70	2003	17.32	
13	2004	49.88	38	50.5	66	2004	16.00	

- Click on top left corner of the worksheet to select the entire sheet. Select **Plot > Basic 2D: Multiple Panels by Label** to open the **plotbylabel** dialog.

- Set the dialog options as following, and click the **OK** button to create the graph.

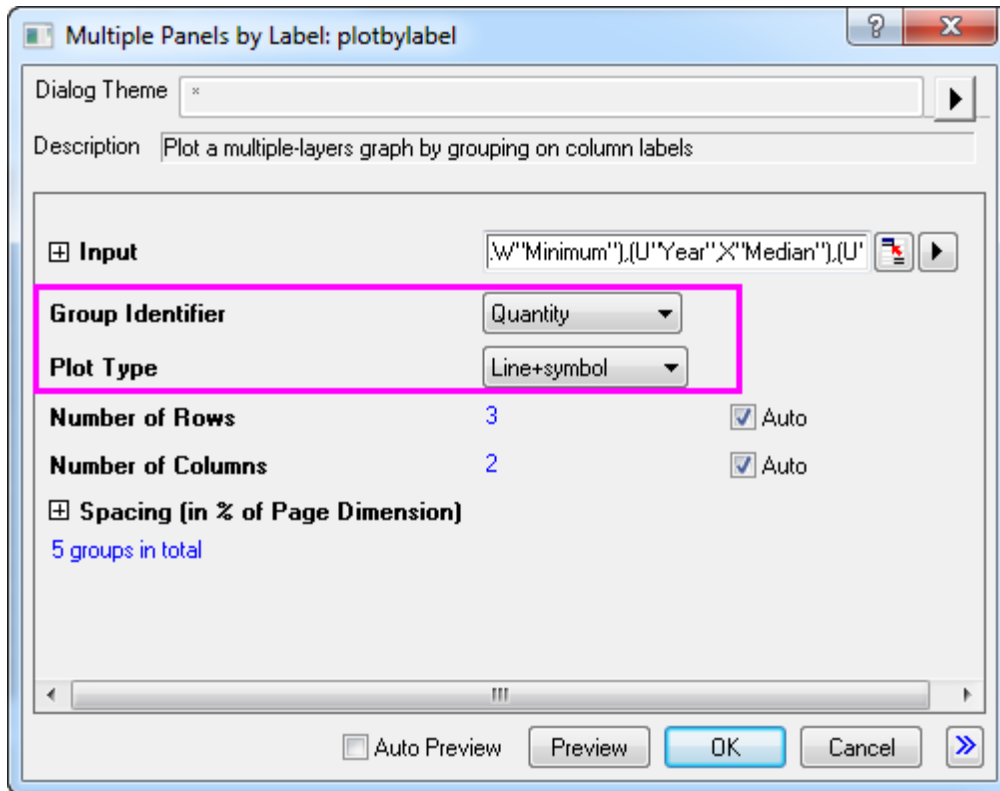

The graph should look like this:

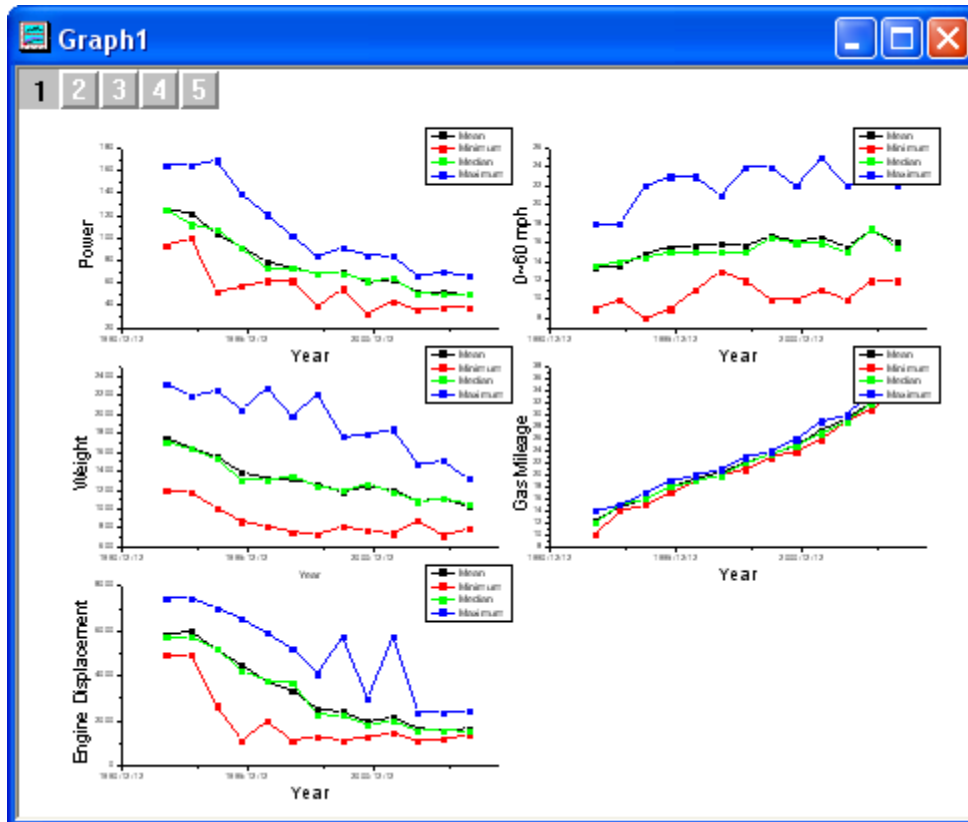



## 6.2.4 Basic 2D Plotting

### 6.2.4.1 Summary

Origin's 2D plots are highly customizable. You can easily modify plot attributes, arrange layers, and select different datasets for each layer. This tutorial will teach you the basic plotting skills.

Minimum Origin Version Required: Origin 2015 SR0

### 6.2.4.2 What you will learn

This tutorial will show you how to:

- Perform simple row statistics
- Create a graph and save as a template
- Plot into your template
- Use the Plot Setup dialog

### 6.2.4.3 Steps

#### 6.2.4.3.1 Simple row statistics

1. Start with an empty worksheet, select **Data: Import from File: Single ASCII...** to open the *Import Single ASCII* dialog, browse to the *\Samples\Curve Fitting* subfolder of the Origin program folder, and import the file *Dose Response - No Inhibitor.dat*.
2. Highlight columns 2 through 4 and select **Statistics: Descriptive Statistics: Statistics on Rows**. Make sure to check the **Mean** and **Standard Deviation** check boxes on the *Quantities* tab to output these results.

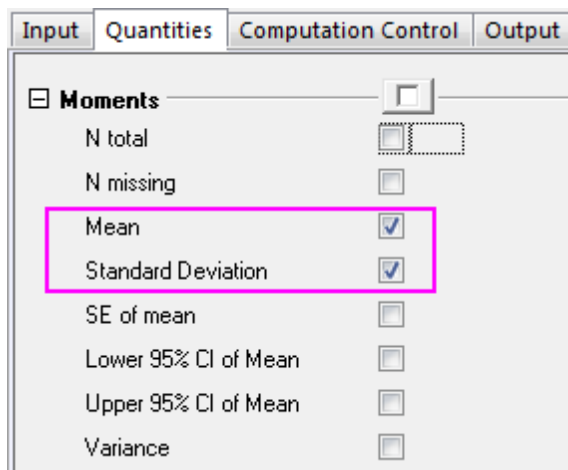

3. After you click the **OK** button, two new columns, **Mean(Y)** and **SD(yErr)** are added to the source worksheet. Here, **yErr** means that this is an error column and the data in this column can be used to plot

error bars.

**Note:** To simplify plotting, each column in an Origin worksheet has a plotting designation. To change a column's plotting designation, select the column and click on the **Column** menu. Alternatively, right-click on the column and choose **Set As** from the shortcut menu.

#### 6.2.4.3.2 Create a graph and save as a template

1. Highlight the Mean(Y) and SD(yEr-) columns and select **Plot > Basic 2D: Line+Symbol** to create the plot:

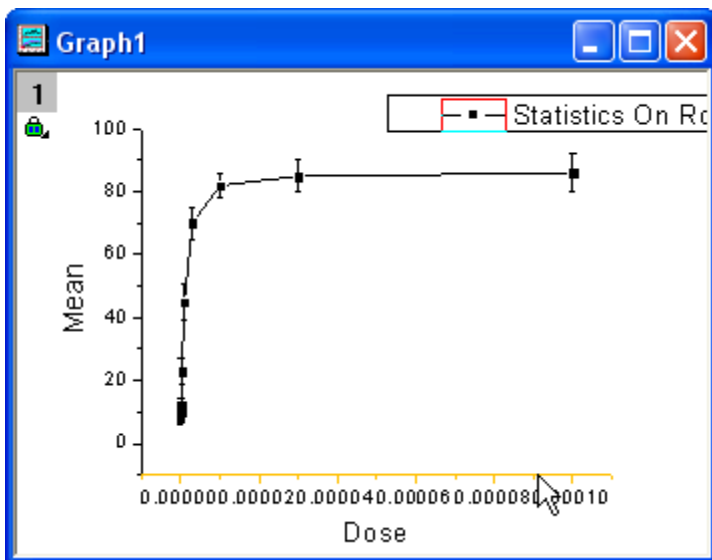

2. Change the X scale to Log. To do this, double-click on the **X** axis to bring up the **Axis** dialog. On the **Scale** tab, change the axis **Type** to **Log10**:

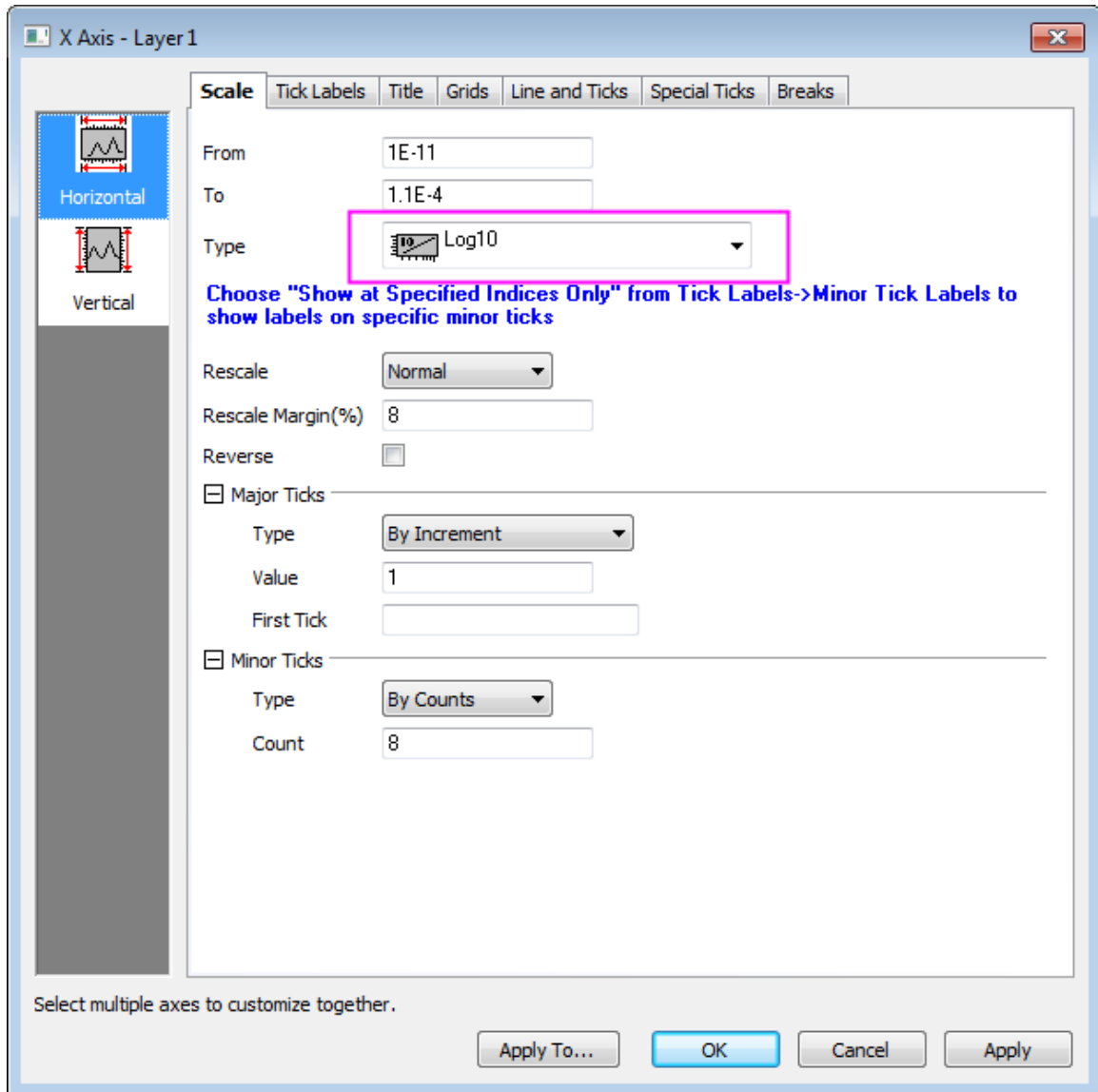

Click the **OK** button to close the dialog.

3. Select **Graph: Rescale to Show All** from the menu, which will rescale the X and Y axes of the graph. :

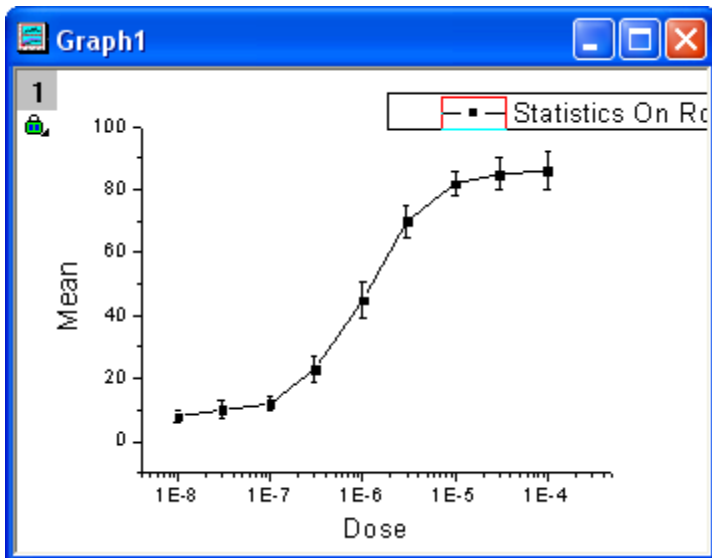

4. To edit the curve, double-click on any plot symbol to bring up the **Plot Details** dialog. Alternatively, right-click inside the graph and choose **Plot Details** from the shortcut menu. On the **Line** tab of right panel, select **B-Spline** as the connecting line type to get a smoother curve.

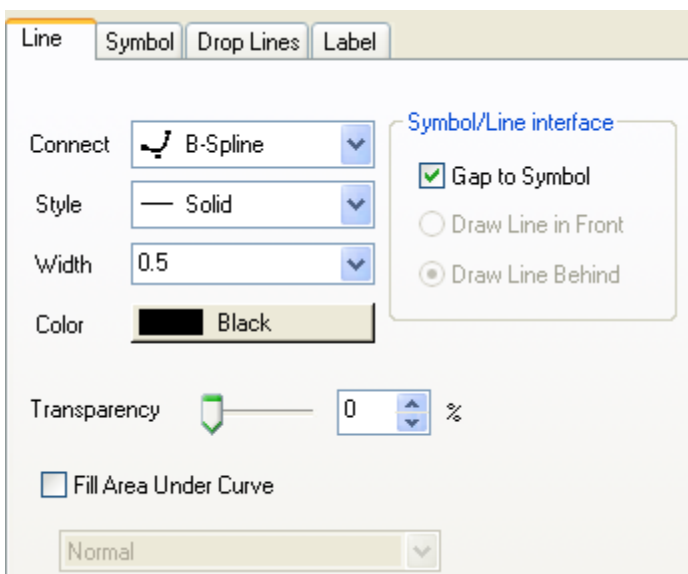

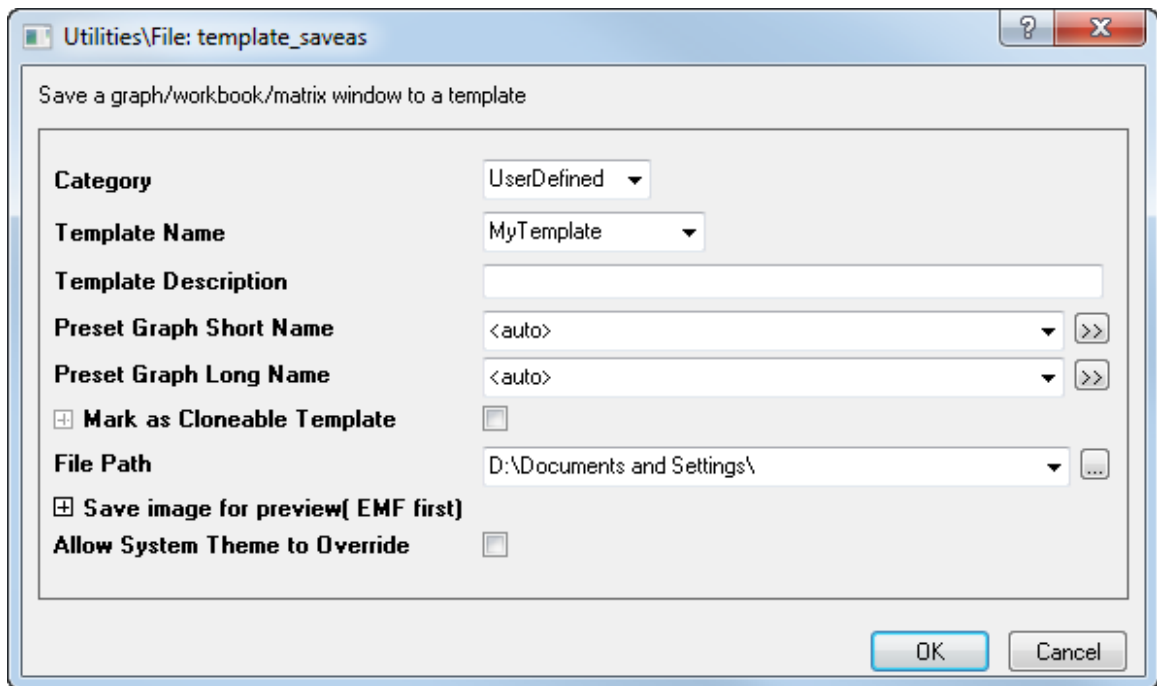

Click the **OK** button to close the dialog.

5. When all modifications have been made and the graph looks the way you want it, you can use this graph to create a template, to be used in the future with similar data. Select **File: Save Template as** to open the *Save Template* dialog. In the **Category** drop-down list, select *UserDefined*; and then type a proper **Template Name**. In this example, we use *MyTemplate*. Click **OK** to save the template.



#### 6.2.4.3.3 Plot into graph template with the Plot Setup dialog

1. Click the **New Workbook**  button and import the file `\Samples\Curve Fitting\Dose Response - Inhibitor.dat` as above. Perform **Statistics on Rows**, calculating the Mean and SD of this worksheet as you did above, following the same steps.
2. Select **Plot: Templates: Template Library: MyTemplate**
3. In the *Plot Setup* dialog, you can choose which columns are to be plotted. (There are three panels in *Plot Setup* dialog, click the  or  button to expand/collapse them.) To finish creating the plot from your template, please follow the steps a - e outlined on the picture below.

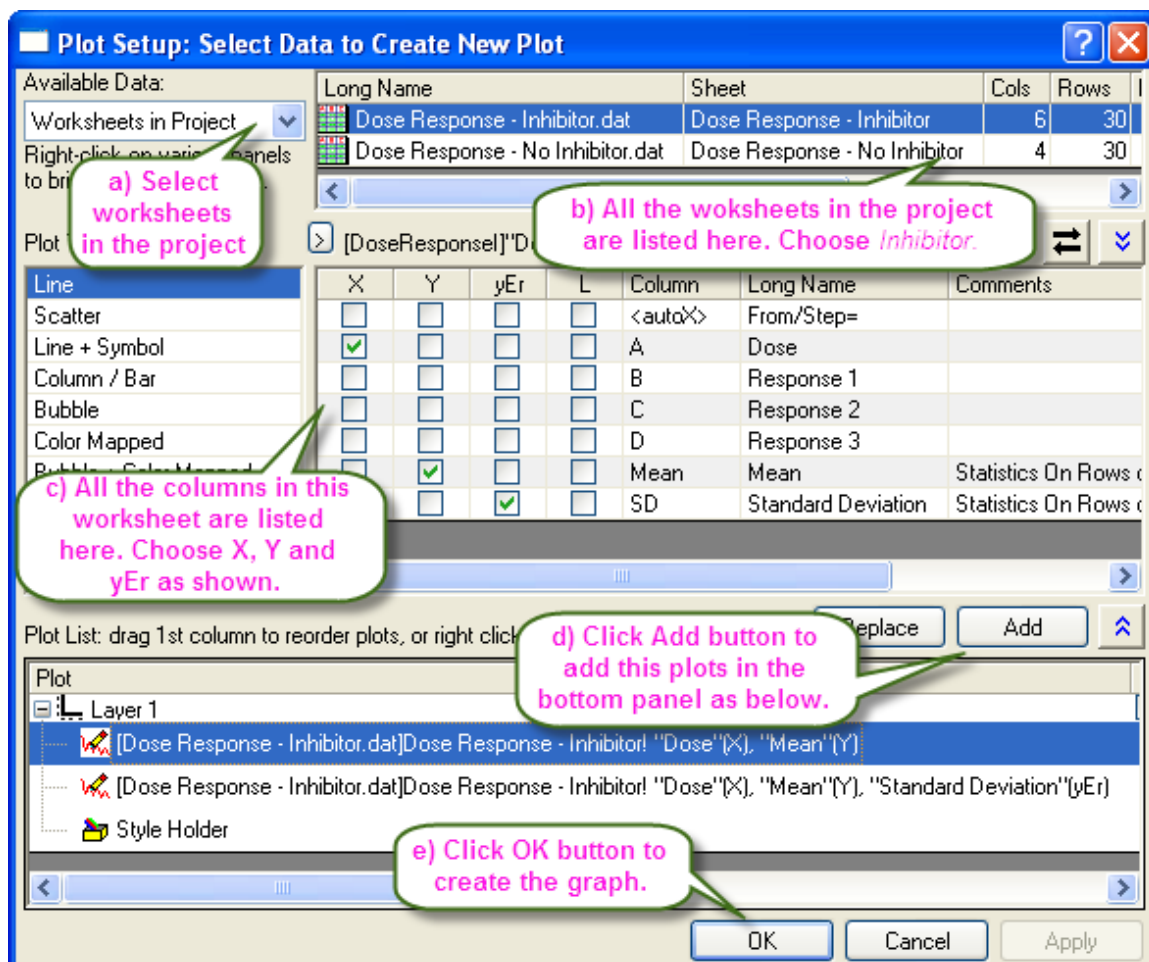

And then you will have:

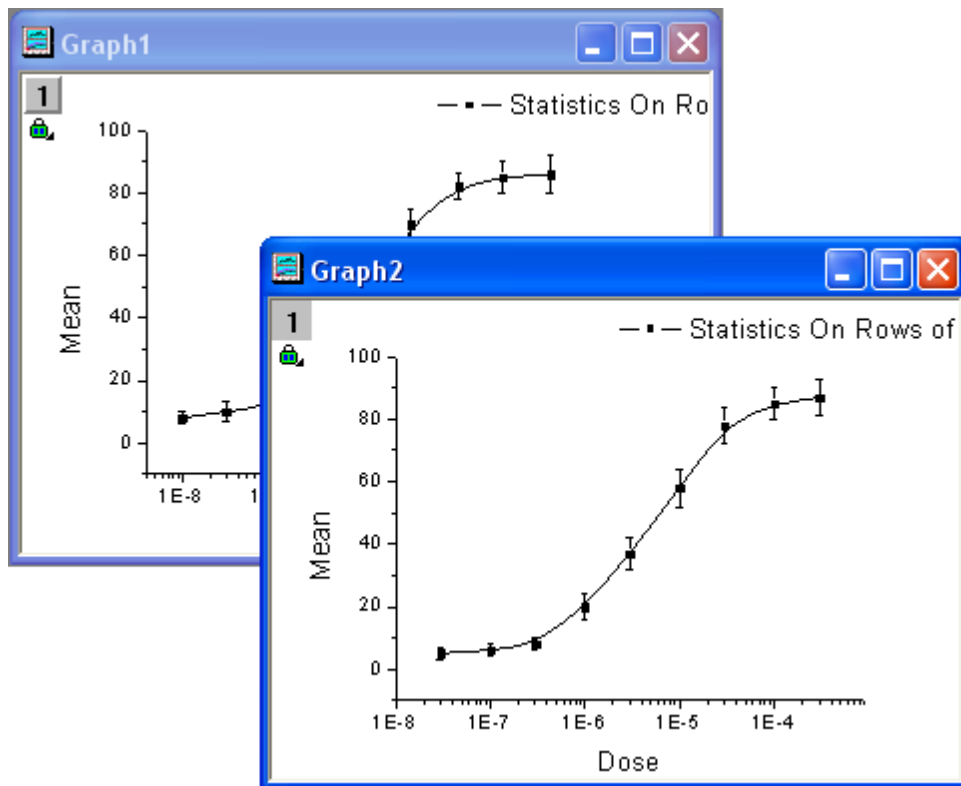

## 6.2.5 Basic 3D Plotting

### 6.2.5.1 Summary

In Origin, Contour plots and 3D plots, such as Color Map Surface plots, can be created directly from XYZ data.

But, if you want to plot a smoother 3D surface, you are strongly advised to use one of Origin's built-in gridding routines to convert the XYZ data into a matrix.

Minimum Origin Version Required: Origin 9.0 SR1

### 6.2.5.2 What you will learn

This tutorial will show you how to:

- Create a 3D graph from XYZ data
- Use the **Layer Contents** dialog to add/remove a data plot
- Convert XYZ data into a Matrix
- Use the **Plot Details** dialog to customize a graph

### 6.2.5.3 Create a 3D Surface and Scatter Plot

1. Import the file `\Samples\Matrix Conversion and Gridding\XYZ Random Gaussian.dat`.

- Highlight column C and right click. Select **Set As: Z** from the fly-out menu.
- Select **Plot > 3D : 3D ColorMap Surface** to create a 3D Colormap Surface plot (Graph1 by default).

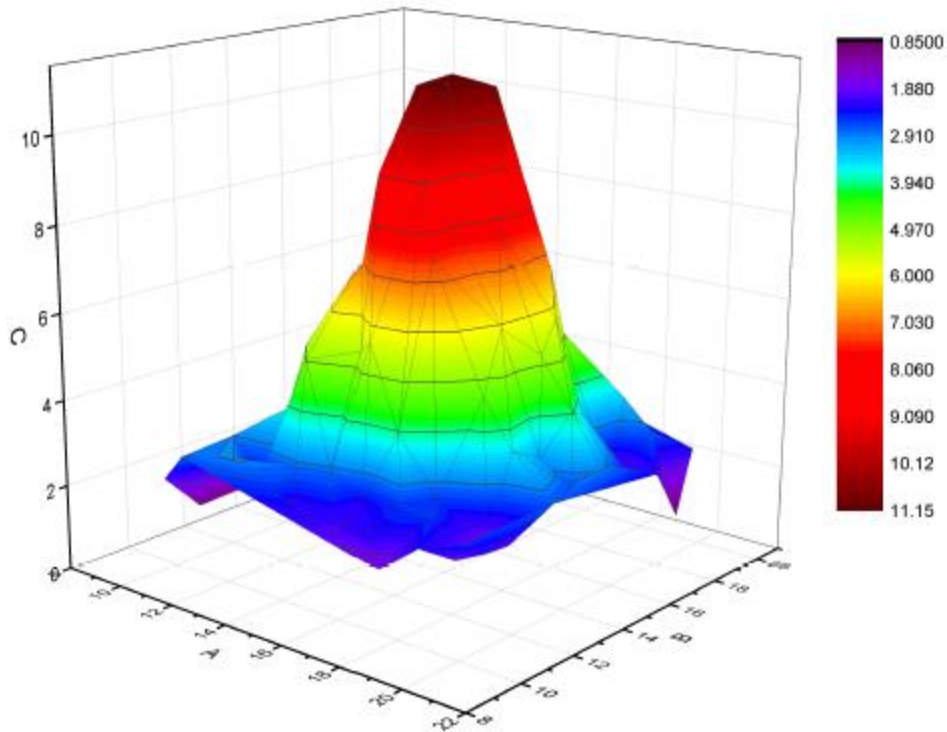

- Right click the layer icon on the left-top of the graph to open the **Layer Contents** dialog. In this dialog, click on the **A** button and select **3D Scatter/Trajectory/Vector** from the fly-out menu.

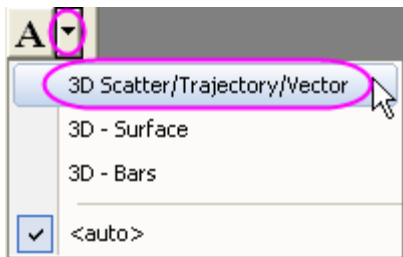



5. Select column C from the left panel and click on the **Add Plot**  button to add the 3D scatter plot to the graph. Click **OK** to close the dialog.

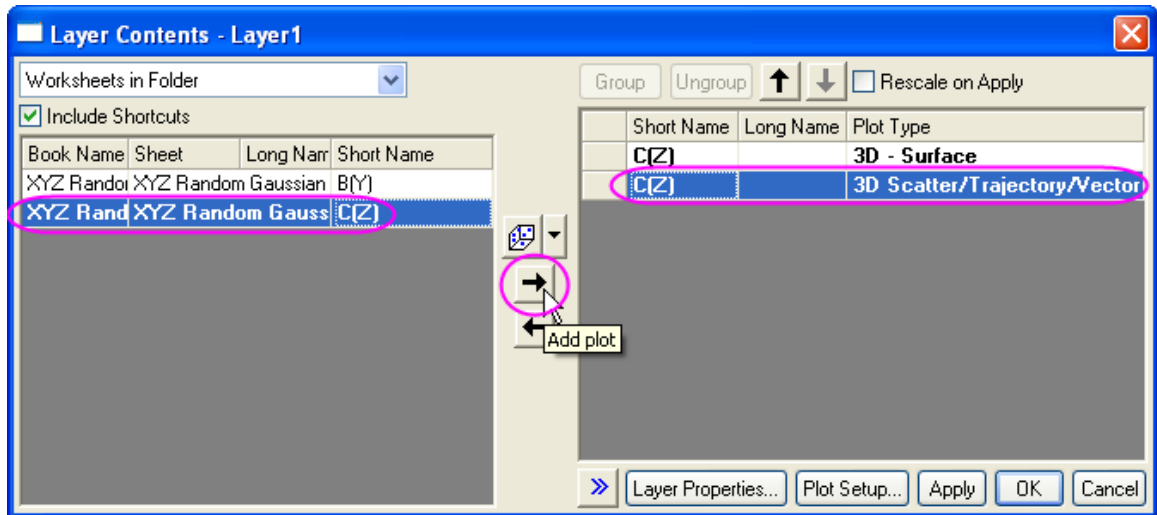

6. Double-click on the scatter plot of Graph1 to open the **Plot Details** dialog. In the **Symbol** tab, set **Shape** to **Ball**, **Size** to **12** and **Color** to **Map: Col(C)** (expand Color Chooser to do settings in the **By Points** sub-tab as shown below).

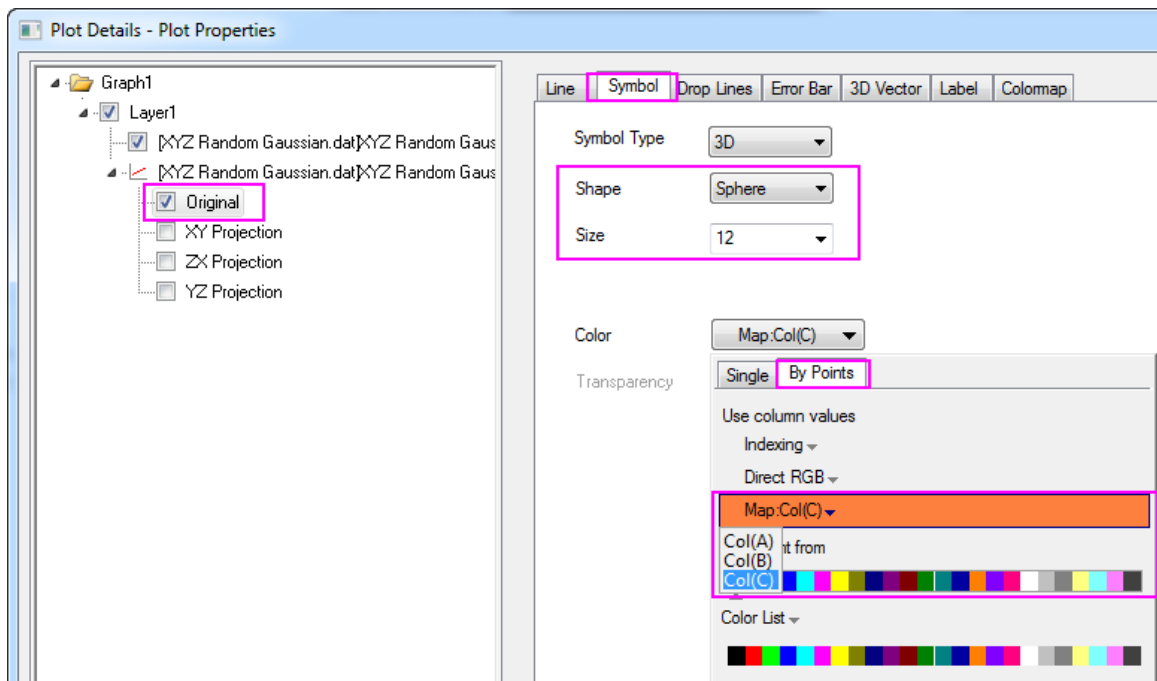

- In the **Drop Lines** tab, uncheck the **Parallel to Z Axis** checkbox.

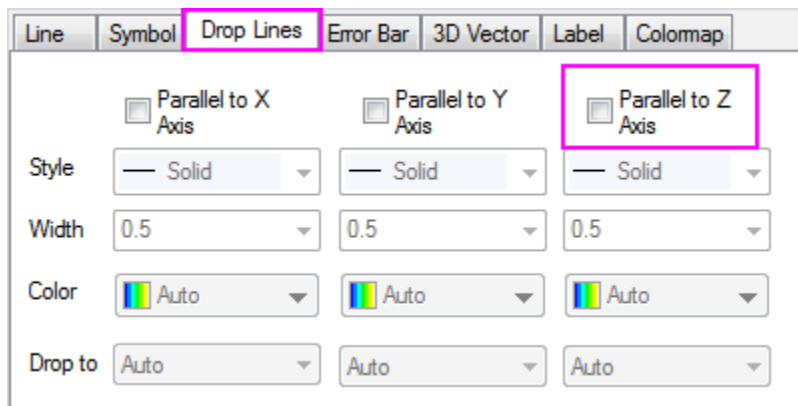

- In the **Colormap** tab, click on the column header *Fill...* to open the dialog. In the **Fill** dialog, choose **Load Palette**, click on **Select Palette**, and select **Rainbow** from the list.

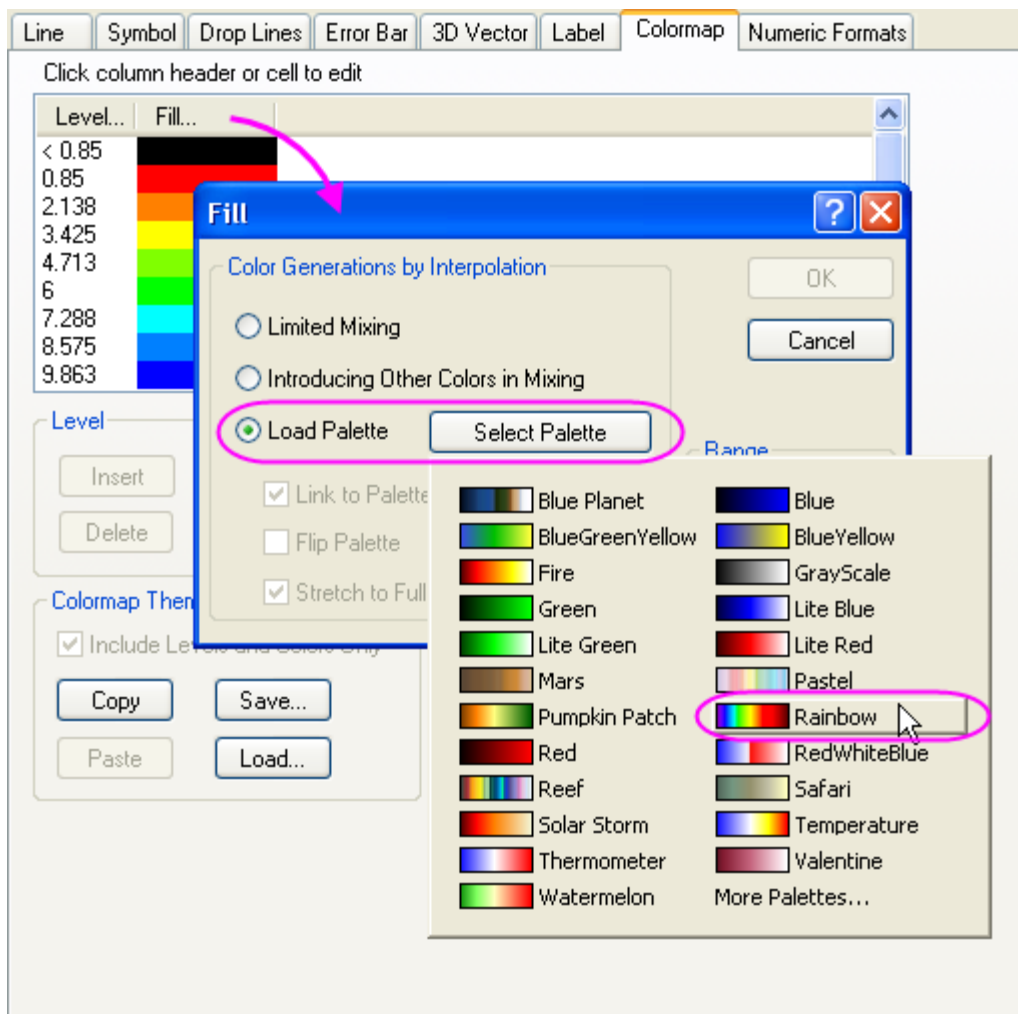

- Select **Layer1** from the left panel of the **Plot Details** dialog. In the **Lighting** tab, select **Directional** as **Mode** and do the settings under *Light Color* just as the image below showing. Click **OK** to close the dialog.

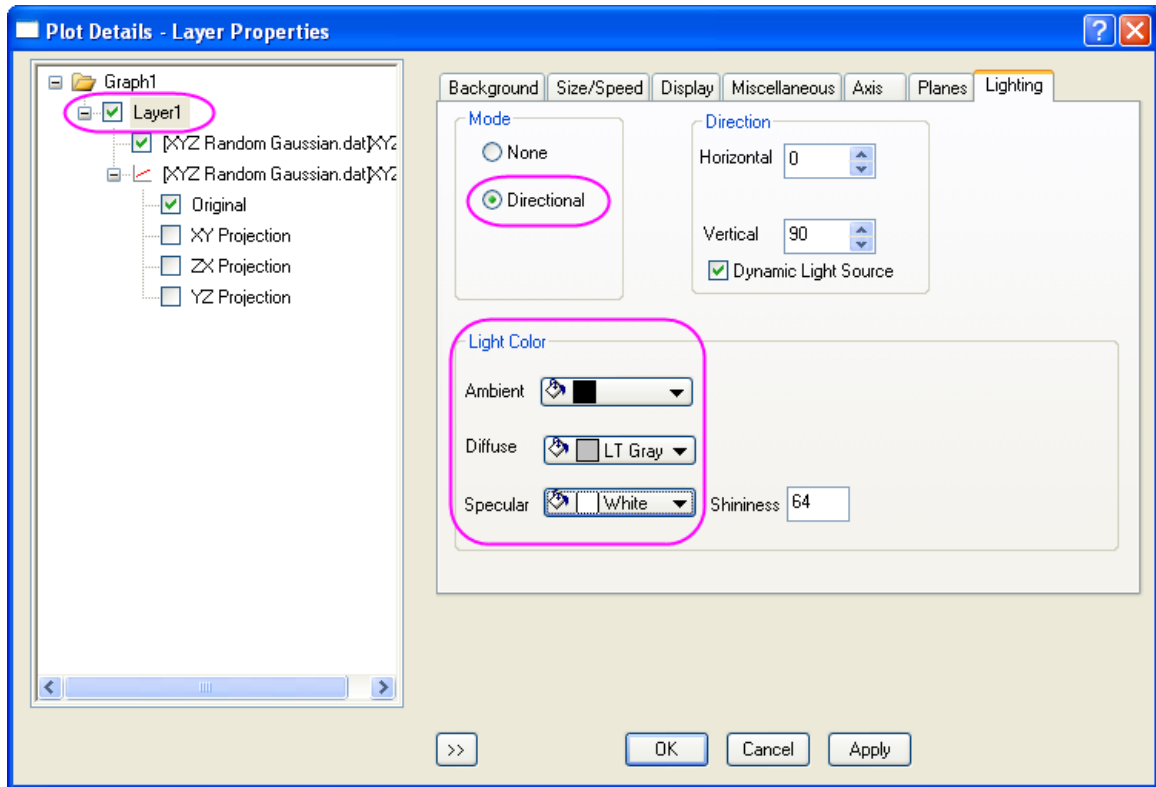

The graph should look as below:

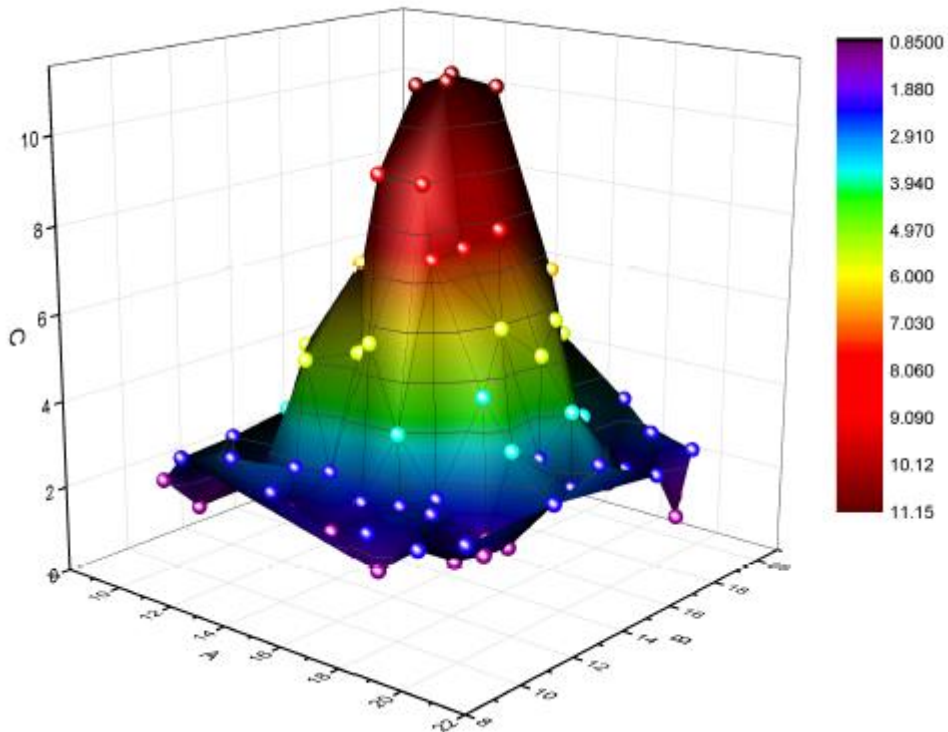



Press the "S" key while hovering on a 3D OpenGL graph. The cursor will change modes. Drag with your mouse or use arrow keys to change lighting source direction.

#### 6.2.5.4 Smooth the 3D surface plot

If you want to create a 3D surface that is smoother than the surface plot above(created from XYZ data), you can firstly convert the XYZ data into a matrix using the **XYZ Gridding** tool. And then, use the result Matrix data to create the 3D surface.

1. Activate the workbook **XYZ Random Gaussian** again.
2. Select **Worksheet: Convert to Matrix: XYZ Gridding** to open the dialog. Expand the **Gridding Settings** branch, select **Random (Thin Plate Spline)** from the **Gridding Method and Parameters** drop-down list, and set both the **Columns** and **Rows** to **30**. Click **OK** to convert the XYZ data into a matrix.

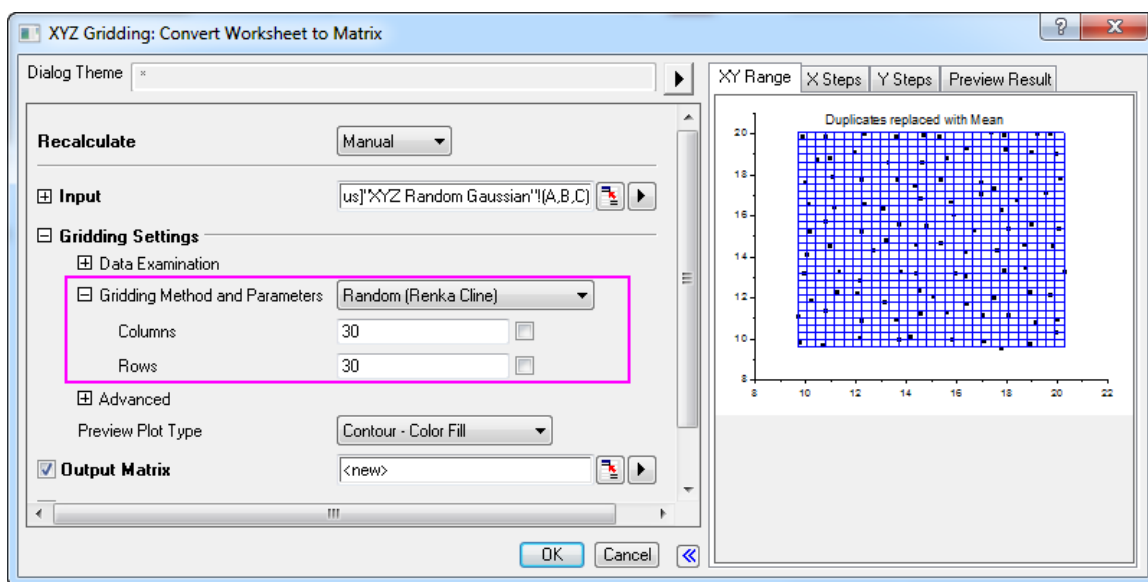

3. Activate the matrix, and select **Plot > 3D: 3D Colormap Surface** to create another 3D graph, says **Graph2**.

- Go back to **Graph1**, right-click on any white space in Layer frame to select **Copy Format: All Style Formats** in the context menu.

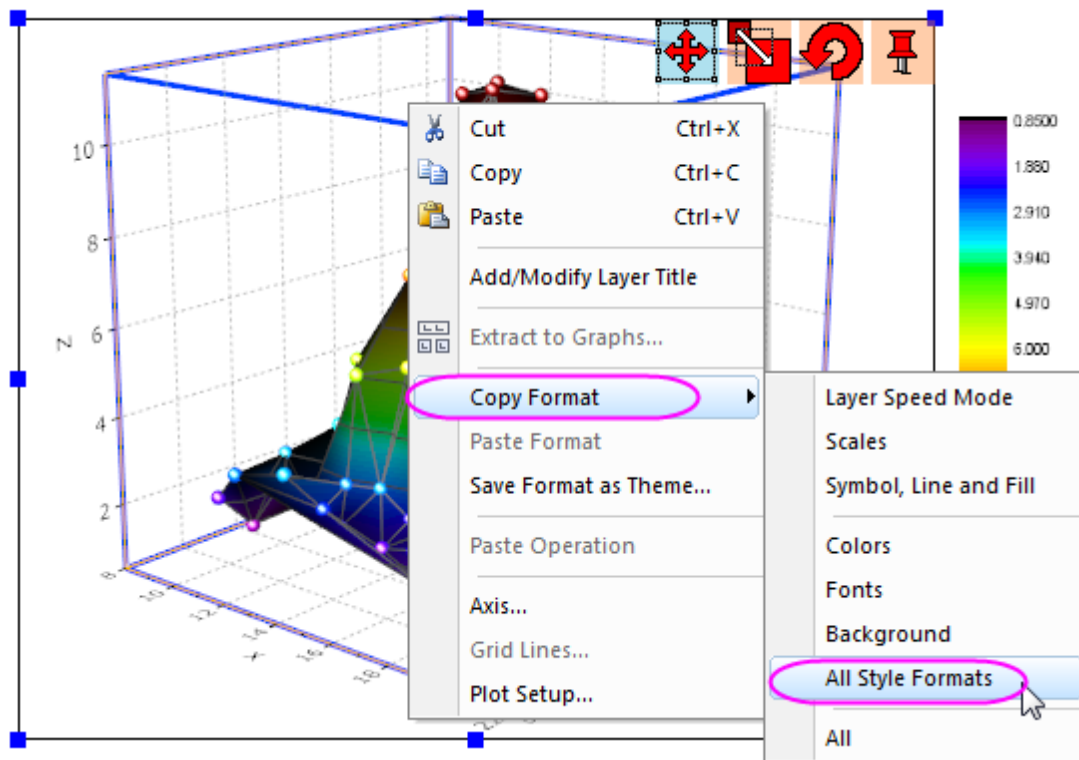

- Switch to **Graph2** again, right-click on the Layer frame, select **Paste Format** in the context menu.
- Select **Format: Plot...** from main menu to open the **Plot Details** dialog. Go to **Colormap/Contours** tab, clear **Enable Contours** check box:

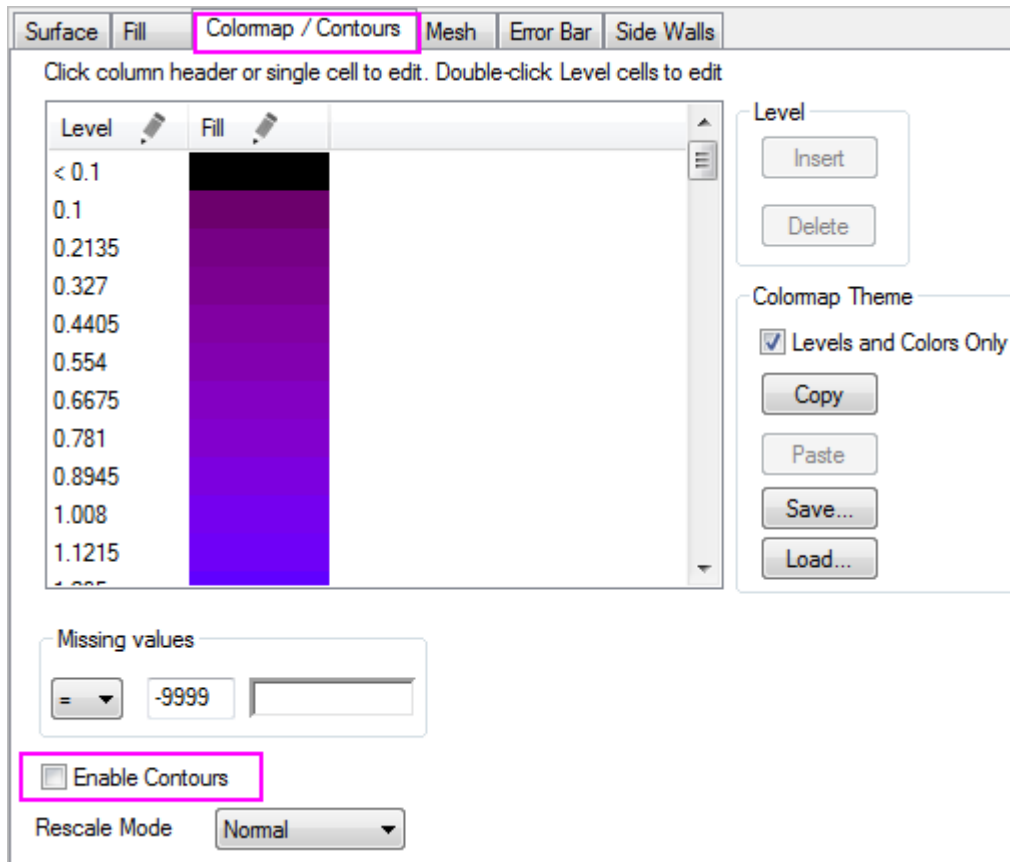

**Graph2** should look as below:

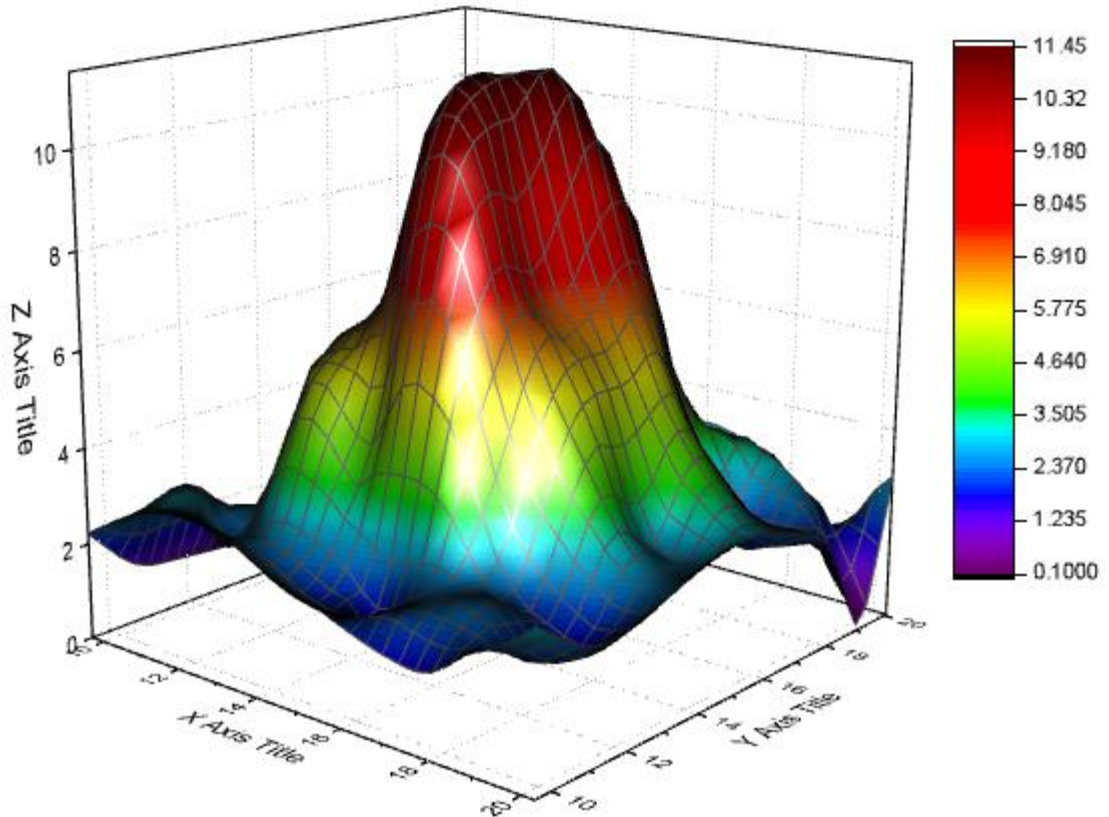

## 6.2.6 Plot from User Defined Graph Template

### 6.2.6.1 Summary

In this tutorial, we will show you how to save a graph as an user-defined template and plot new data into the saved custom template. There are two types of graph templates available in Origin: standard template and cloneable template. Cloneable template can be easily used to clone a graph from a new workbook/worksheet, in spite of the complexity of data composition in target graph, but with one prerequisite that new data should share same data structure with the data in target graph. In comparison, standard template has more freedom over data source but lacks of the ability to duplicate a graph with complicated layer hierarchy or data structure.

This tutorial will show you how to:

- Create and save a graph as standard template
- Plot new data into a standard template
- Save a graph as cloneable template
- Plot data with same data structure into a cloneable template

### 6.2.6.2 Standard Template

#### 6.2.6.2.1 Create and Save a Standard Graph Template

This tutorial is associated with <Origin EXE Folder>\Samples\Tutorial Data.opj.

1. Open the **Tutorial Data.opj** and browse to the folder **Custom Axis Scale to Show Different Scale Range**.
2. Highlight column **B Exothermic Energy** and **C Energy-SD**, click scatter button  on **2D Graphs** toolbar to make a scatter plot with Y error bar.
3. Next we want to customize the symbol to be solid circle with blue color, to do so double-click on any data point on the graph to bring up **Plot Details - Plot Properties** dialog.
4. Make sure first plot under **Layer1** branch is selected on the left panel. Go to **Symbol** tab. Select solid circle from the down-sided triangle button under **Preview** and set **Symbol Color** to be **Blue** in the **Single** tab of **Color Chooser**. Click OK.

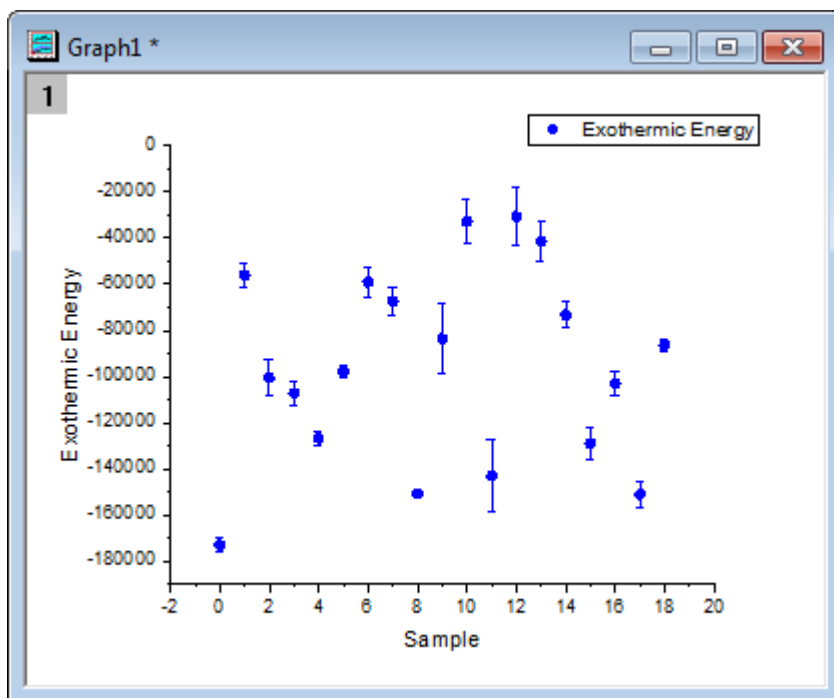

5. To save it as standard template, right click on *Graph1* window title bar and select **Save Template As...** to open dialog.
6. Input *BlueCircle* as **Template Name** and add some descriptions *Blue solid circle* in **Template Description** edit box.
7. If you want preset the long name of newly created graphs to be the first plot's long name, click the more options button next to **Preset Graph Long Name** edit box and select **@LL: Long Name**. *%(1,@LL)* will show as **Preset Graph Long Name**.
8. Make sure **Mark as Cloneable Template** box is unchecked, click **OK** button to save it as standard template.

#### 6.2.6.2 Plot New Data into Standard Template

1. Go back to workbook, highlight columns *Temperature* and *Temperature-SD* and go to menu **Plot: Templates: User: BlueCircle (UserDefined)** to make the graph. The graph window long name is **Temperature**.



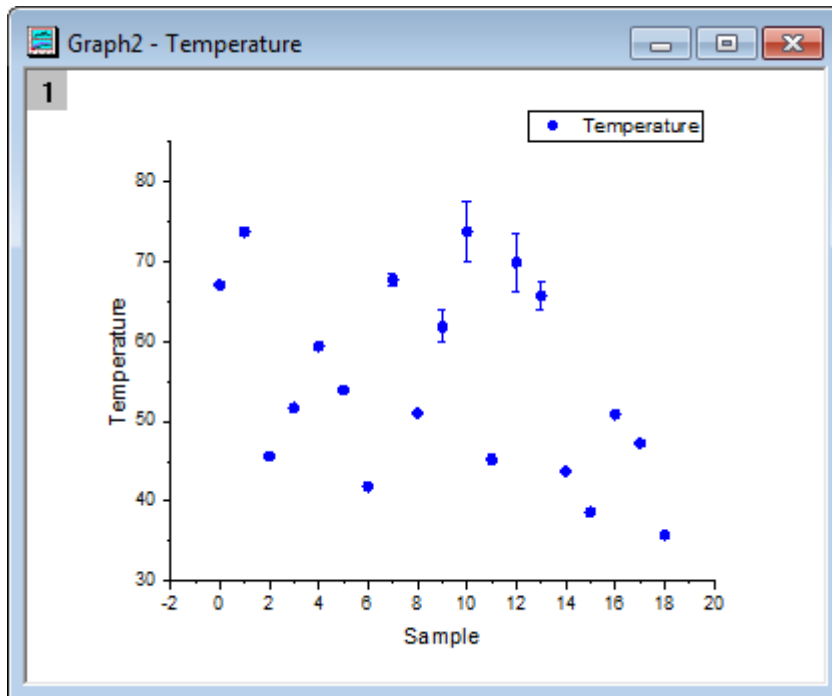

### 6.2.6.3 Cloneable Template

#### 6.2.6.3.1 Save Graph as a Cloneable Template

1. Press **F11** key or select **Help: Learning Center** to open the **Learning Center** dialog. Select **Graph Sample** in the left-side panel, and search for **Raman**.
2. Double-click on the graph that is returned to open the **Raman Spectrum** subfolder.
3. Graph **Raman Spectrum** is plotted from data in different worksheets of workbook *Peak1* also with data labeling. It's hard to plot new data like this with one click using standard graph template. So let's save this graph as a cloneable template and clone this graph using data in workbook *Peak2*.

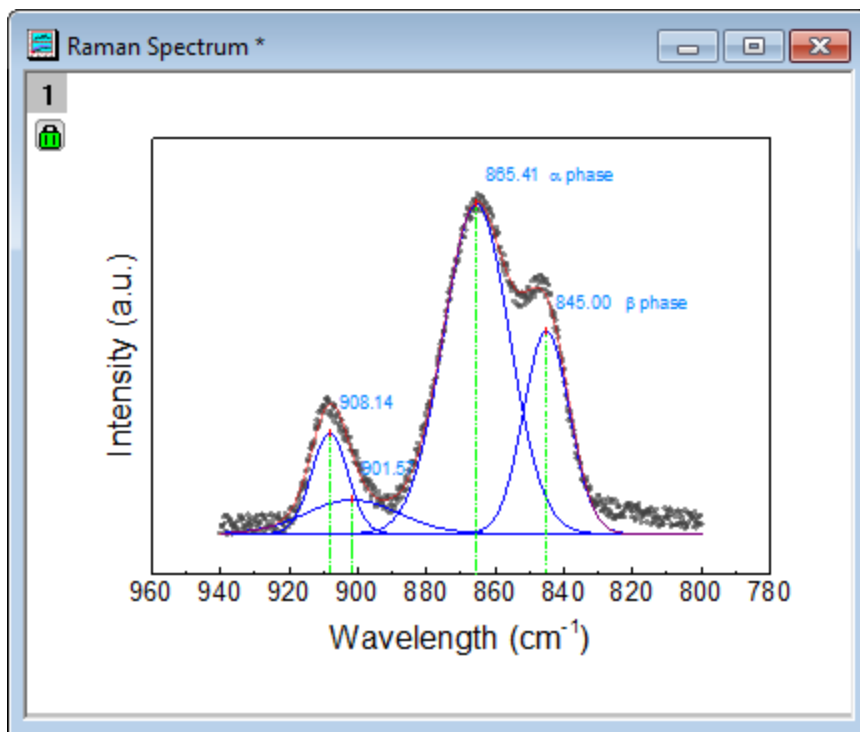

4. To do so, right click on graph **Raman Spectrum** window title bar and select **Save Template As...** to open **Utilities\File: template\_saveas** dialog.
5. Input *MyPeakTemplate* as **Template Name**. Now we want to use **Raman Spectrum + Workbook Long Name** as graph Long Name. To do so, click more options button next to **Preset Graph Long Name** edit box and select **@WL: Book Long Name** to insert the right part first. Then input *Raman Spectrum* in front of added *%(1, @WL)*.
6. Make sure **Mark as Cloneable Template** box is checked, expand this node and match up the columns and worksheets by setting **Match Column by** and **Match Sheet by** to **Index**.
7. Click **OK** button to exit the dialog and save the template.

Utilities\File: template\_saveas

Save a graph, workbook or matrix window as a template

Category: UserDefined

Template Name: MyPeakTemplate

File Type: OTPU

Template Description:

Preset Graph Short Name: < auto >

Preset Graph Long Name: Raman Spectrum %(1, @WL)

Mark as Cloneable Template

Match Plot Columns by: Index

Match Sheet by: Index

Note that plotting into such a template will ignore any data selection in the sheet.

Match Modifiers by: < Offset >

File Path: C:\Users\mike\Documents\OriginLab\User Files\

Preview Image (Optional):

Allow System Theme & System Increment Lists to Override:

Template settings may be overridden by the system theme and system increment lists upon loading if check box is checked. To keep template settings please uncheck the check box.

OK Cancel

### 6.2.6.3.2 Clone a Graph Using Cloneable Template

1. Activate workbook with title **Peak2**, click template library button  to bring up the dialog.

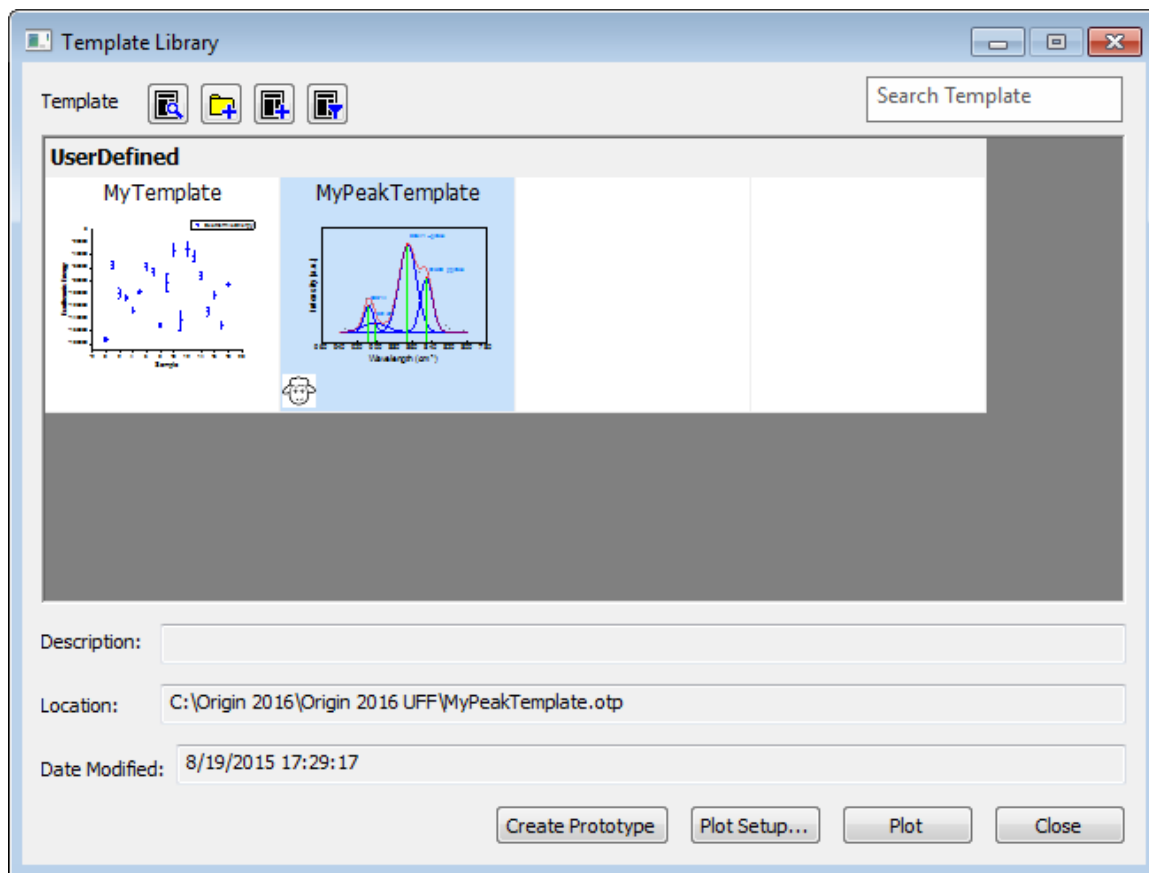

2. Click to select the cloneable template (indicated by Dolly icon) **MyPeakTemplate** and click **Plot** button to clone the graph.

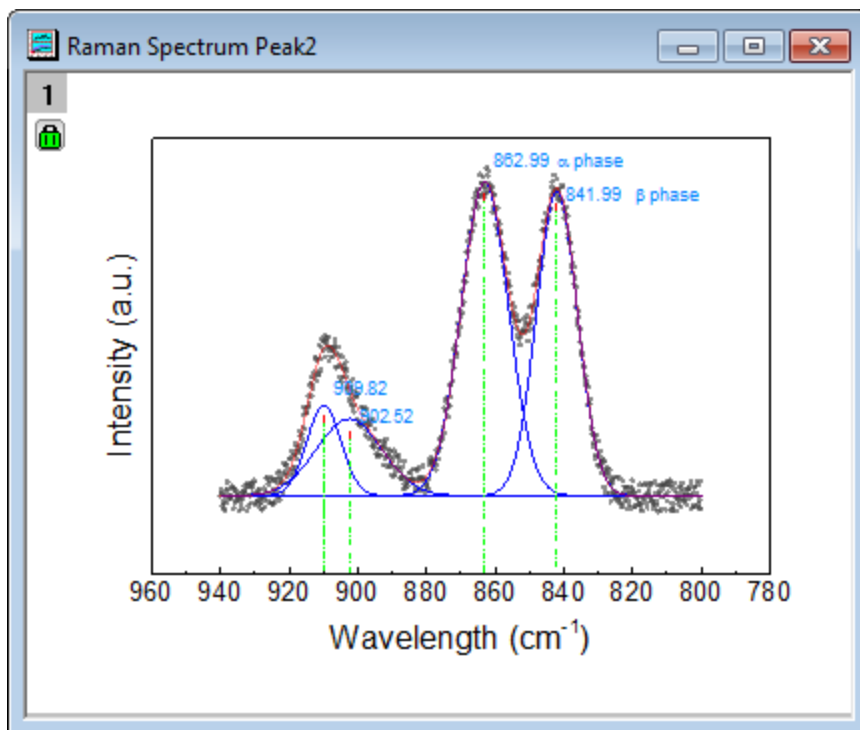

- Alternatively you can activate workbook **Peak2** and go to menu **Plot: Templates: User: MyPeakTemplate (UserDefined)** to directly clone the graph.

## 6.2.7 Adding a Data Plot to Existing Graph

### 6.2.7.1 Summary

The Plot Setup dialog can be used to add/reorder/arrange data plots in an exiting graph. This dialog provides flexibility in selecting the source data sheet and in specifying how data are to be plotted.

### 6.2.7.2 What you will learn

This tutorial will show you how to:

- Use the **Plot Setup** dialog to add data to a graph layer
- Use the **Plot Setup** dialog to group data plots in the layer
- Use the **Legend Update** dialog to modify the graph legend

### 6.2.7.3 Steps

#### 6.2.7.3.1 Choosing the Data Source

1. Click the **New Project** button on the Standard toolbar, to begin with a new project.
2. Click the **Import Wizard** button on the Standard toolbar. The Import Wizard opens. (Note that if this is the first time that you have started the Import Wizard, you will experience a slight delay as Origin compiles the necessary files.)

3. Verify that the **ASCII** radio button is selected in the **Data Type** group.
4. Click the browse button to the right of the File text box. Navigate to the Origin folder; browse to the **Samples** folder and then the **Import and Export** folder.
5. Press CTRL and select files *S15-125-03.dat*, *S21-235-07.dat*, and *S32-014-04.dat*, then click **Add Files**.
6. Click **OK**.
7. Leave the **Import Filters for current Data Type** as **Data Folder: VarsFromFileNameAndHeader**. (This filter has the settings to use when importing the file.)
8. Set the **Import Mode** as **Start New Sheets**.
9. Click the **Finish** button. The three data files import into the workbook, each as a new sheet. You will have a book with three sheets: **Trial Run 1**, **Trial Run 2**, and **Trial Run 3**.



### 6.2.7.3.2 Plotting the Data

1. Select the **Trial Run 1** sheet.
2. Highlight the D(Y) column.
3. Click the **Line** button on the **2D Graphs** toolbar. A new graph is created.

### 6.2.7.3.3 Adding Data to the Graph using Plot Setup

1. Right-click on the layer 1 icon in the upper-left hand corner of the graph and choose **Plot Setup**.
- 2.



There are three panels in the **Plot Setup** dialog. Expand the **Plot Type** panel by clicking  then expand the **Available Data** panel by clicking the second  button.

Please refer to [Plotting using Plot Setup](#) for more information.

3. Select **Layer 1** in the Plot List.
4. Select **Trial Run 2** from the Available Data list (the top-most of the three panels).
5. Select **Time** as X and **Position** as Y.
6. Click **Add**.
7. Repeat steps 2 - 5, but add **Trial Run 3** to Available Data, and again set **Time** as X and **Position** as Y, then **Add** the plot to Layer 1.
8. Highlight all three plots under **Layer 1**, then right-click and choose **Group**.
9. Click **OK**. You should now have a graph with three differently-colored line plots.

For information on "grouping" plots, see [Grouping Data Plots](#) in the OriginLab User Guide.

### 6.2.7.3.4 Updating the Graph Legend

The existing graph legend uses the names of the imported data plots. We will modify the legend to show the sheet name.

1. Right-click on the legend object and choose **Legend: Update Legend**.
2. From **Auto Legend Translation Mode**, choose **Custom**.

- For **Legend Custom Format(@D, @LU etc)**, click the arrow to the right and choose **@WS: Sheet Display Name** and click **OK**. The graph legend now reads **Trial Run 1**, etc.

For more information on customizing the default legend, see these topics:

- [Graph Legends](#)
- [Legend Text Customization](#)

## 6.2.8 Smart Peak Labels with Leader Line

### 6.2.8.1 Summary

For the line/symbol plot in 2D Cartesian coordinate system, Origin supports smart labels which can be auto-repositioned to avoid overlapping. Leader lines (both straight lines and oblique lines) can be added to connect the data points and their labels.

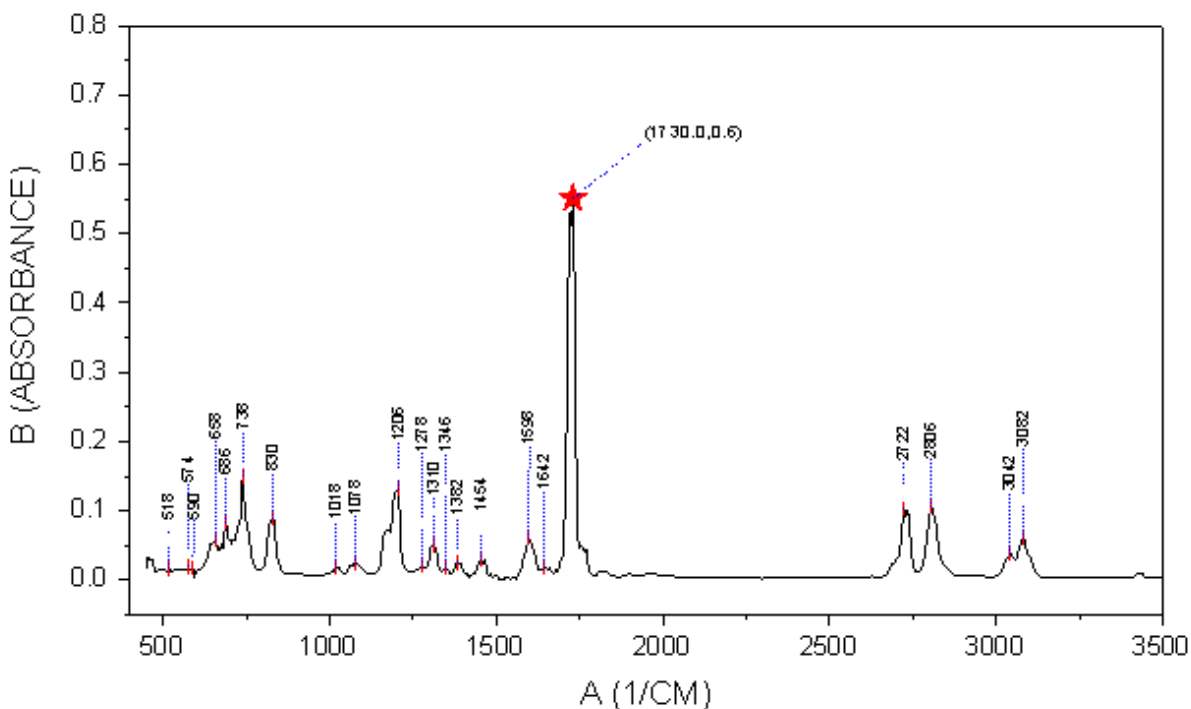

Minimum Origin Version Required: Origin 2016 SR0

### 6.2.8.2 What you will learn

This tutorial will show you how to:

- Add smart labels with leader lines
- Add a special data point and customize its label

### 6.2.8.3 Steps to Add Smart labels

This tutorial is associated with <Origin EXE Folder>\Samples\Tutorial Data.opj.

1. Open the **Tutorial Data.opj** and browse to the *Smart Peak Labels with Leader Line* folder in the **Project Explorer**.
2. There are two sheets in **A100527IR** workbook. *100-52-7-IR* is an IR absorbance data and *Peak\_Centers1* are peak center result found by Origin's **Peak Analyzer** tool.
3. Highlight Col(B) in sheet *100-52-7-IR* to plot a line graph by selecting **Plot > Basic 2D : Line** menu.
4. Double click on layer 1 icon to open the **Layer Contents** dialog. Select col(pcy) in left panel. Click the dropdown list next to **A** button in the middle and select **Scatter** as plot type. Click **->** button to add the data into the graph.

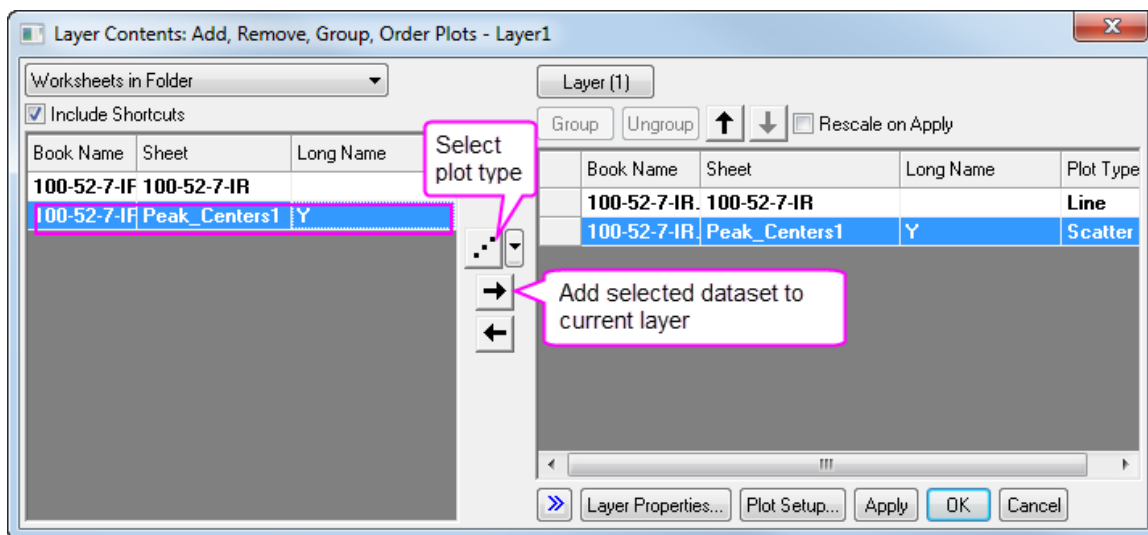

5. In the **Plot Details** dialog, select second plot in the left panel, go to **Symbol** tab, do following settings:

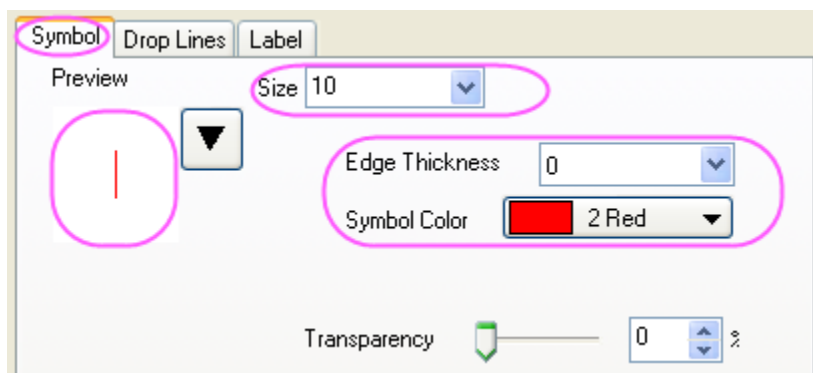

6. Go to **Label** tab, check the **Enable** check box, do settings as below:



Symbol Drop Lines **Label**

Enable  Show at Specified Indices Only

Indices from dataset or space separated numbers (0=Last)

Font  Size  Rotate (deg)

Color   White Out Horizontal Offset

Frame    **B** *I* U Vertical Offset

Margin (% Font Height)  Position

Label Form

Numeric Display Format

7. Click on the **Apply** button, you will see the some labels are overlapped.

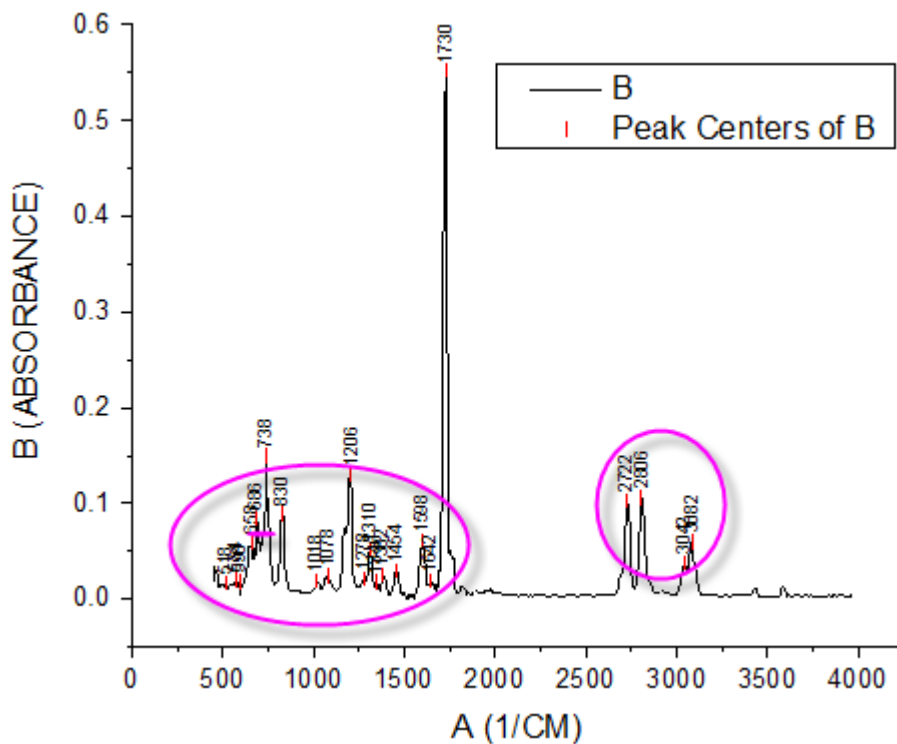

8. Go back to **Label** tab, check the **Auto Reposition to Avoid Overlapping** check box, select **Y** for the **Reposition Direction** drop-down box and set the **Leader Lines** group as below. Also set **Vertical Offset** to be **170** so the leader lines are more obvious.

Symbol Drop Lines Label

Enable  Show at Specified Indices Only  
 Indices from dataset or space separated numbers (0=Last)

Font  Size  Rotate (deg)   
 Color   White Out Horizontal Offset   
 Frame    **B** **I** **U** Vertical Offset   
 Margin (% Font Height)  Position   
 Label Form   
 Numeric Display Format

Attach to   
 X/Y Value   
 LabTalk X1 X2 Y1 Y2 etc. can be used

Auto Reposition to Avoid Overlapping  
 Reposition Direction

Leader Line  
 Show Leader Line if Offset Exceeds (%)   
 Connect    
 Style   
 Width   
 Color

9. Click OK button to close the dialog. You will see the labels are repositioned smartly.

#### 6.2.8.4 Steps to Customize a Single Point and its Label

1. The highest peak's label can't be seen. Double-click on the Y axis to open the **Axis** dialog, go to **Vertical** icon in **Scale** tab, change **From** and **To** to  $-0.05$  and  $0.8$ , then click OK to apply the setting.

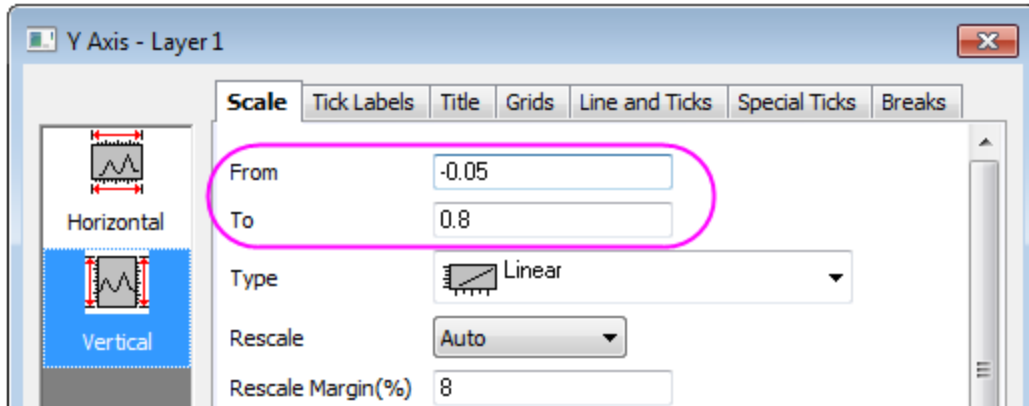

- Press CTRL key down and double click the highest peak's label **1730** to open **Plot Details** dialog. A node **18** shows on left panel. It's the row indexing of the special point.
- Go to **Label** tab of this point and customize the further.

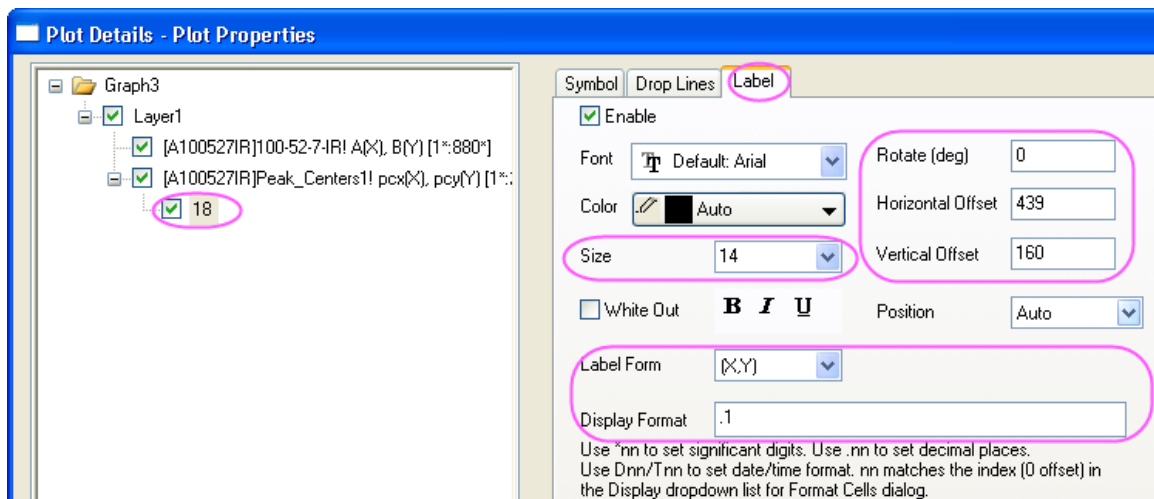

- Go to **Symbol** tab to change the symbol shape and size.

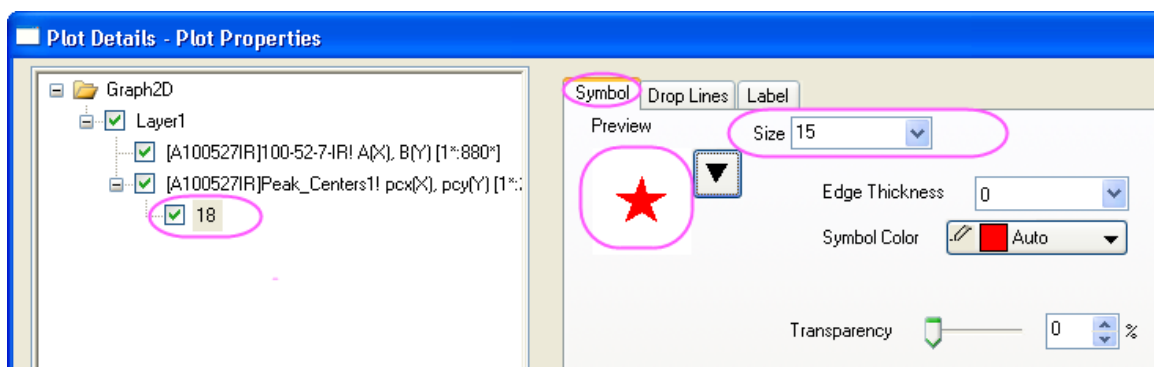

#### 6.2.8.5 More Customization Steps

The following steps can further customize the graph to be exactly the same as the image in **Summary**.

1. Double click X axis to open **Axis** dialog. set **From** and **To** for X axis to be 400 and 3500.
2. To show top and right frames around the graph, select **Grids** tab in **Axis** dialog. Check **Opposite** check box under the **Additional Lines** branch for both **Horizontal** and **Vertical**.
3. To change the layer size, select **Format: Layer...** from main menu to open the **Plot Details** dialog. On **Size/Speed** tab, change the layer size in the **Layer Area** group as below:

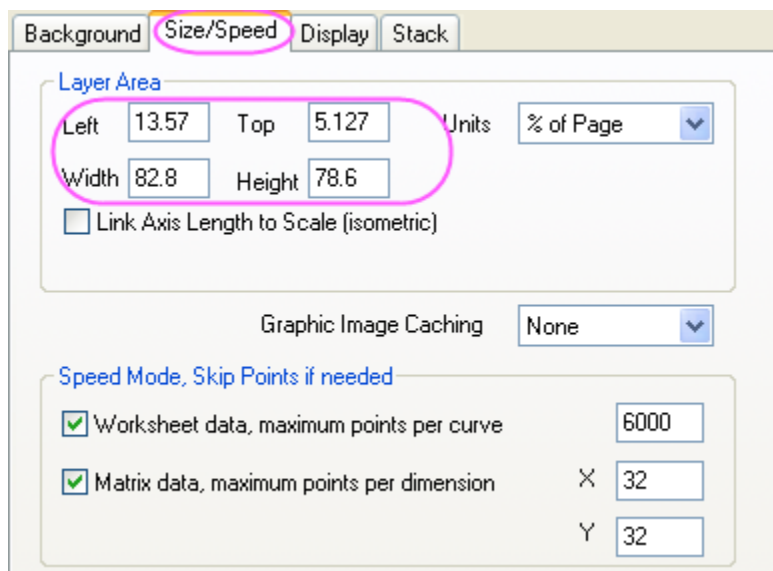

4. Select legend and press **Delete** key to delete the legend.

## 6.2.9 Error Bars with Fill Area

### 6.2.9.1 Summary

This graph displays three datasets with error bars. The error bars have been set to draw as lines with fill areas. Transparency has been set for all three curves so that data in overlapping regions can be clearly seen.

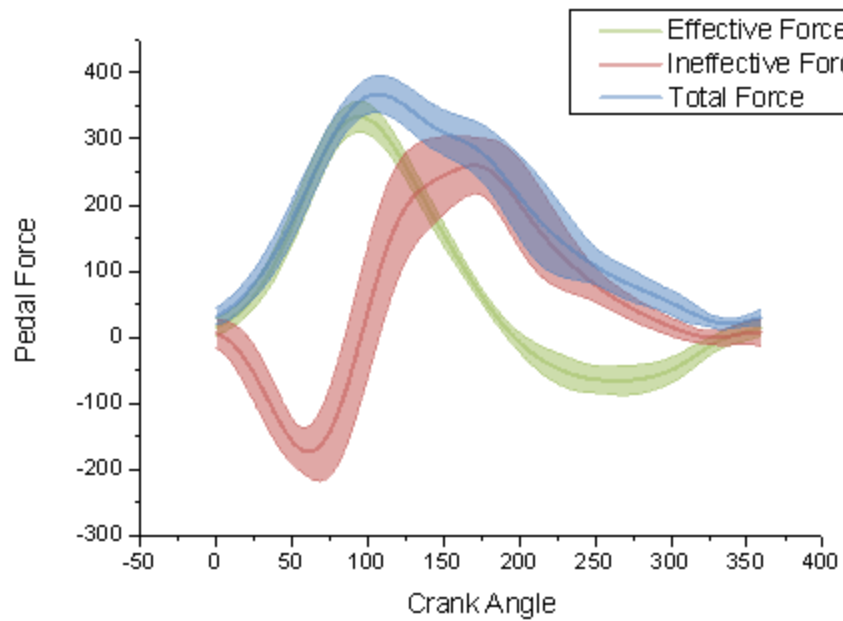

Minimum Origin Version Required: Origin 8.5.1 SR0

#### 6.2.9.2 What you will learn

- Plot the error bar with fill area
- Set transparency for error bar
- Set and save custom color

#### 6.2.9.3 Steps

This tutorial is associated with <Origin EXE Folder>\Samples\Tutorial Data.opj.

Also, you can refer to this graph in Learning Center. (Select **Help: Learning Center** menu or press **F11** key , and then open **Line and Symbol**)

1. Open **Tutorial Data.opj** and browse to the **Error Bars with Fill Area** folder in **Project Explorer** (PE).
2. Highlight all columns in the worksheet. In the main menu, select **Plot > Basic 2D : Line**.

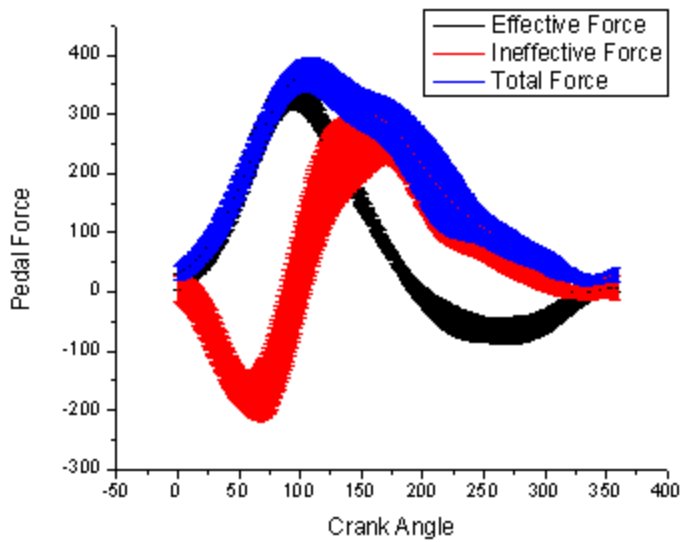

3. Double-click on the plot to open the **Plot Details** dialog. Select the first plot node under Layer1 in the left panel. In the right panel activate the **Group** tab. Choose **Independent** in **Edit Mode**.

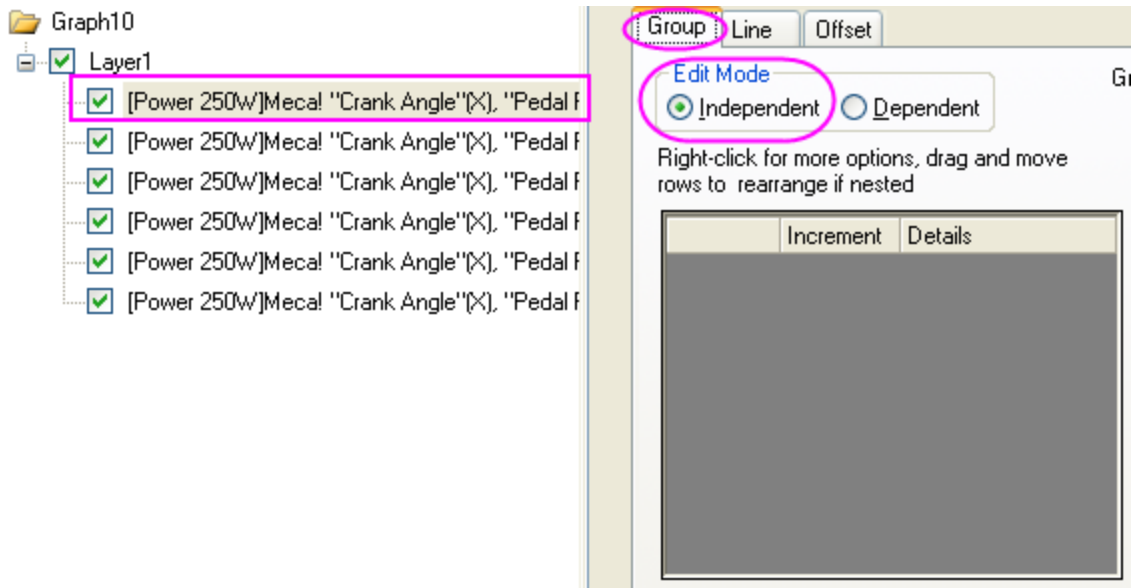

4. On the **Line** tab set **Width** as **3**. To set a custom color click on the button right to **Color** and select **Custom** from the drop list.

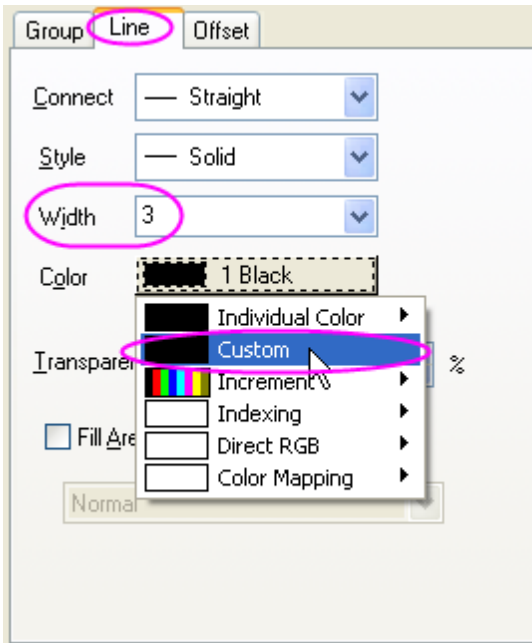

Right-click on the **Custom** button to bring up **Color** dialog. Click on **Define Custom Colors** to expand the right panel. For further use save the custom color in the **Custom colors:** palette:

1. Select an blank box under the **Custom colors:** palette.
2. Set **Red, Green, Blue** as **155, 187, 89** respectively in the right panel.
3. Click **Add to Custom Colors** to save this color to the **Custom colors** palette.

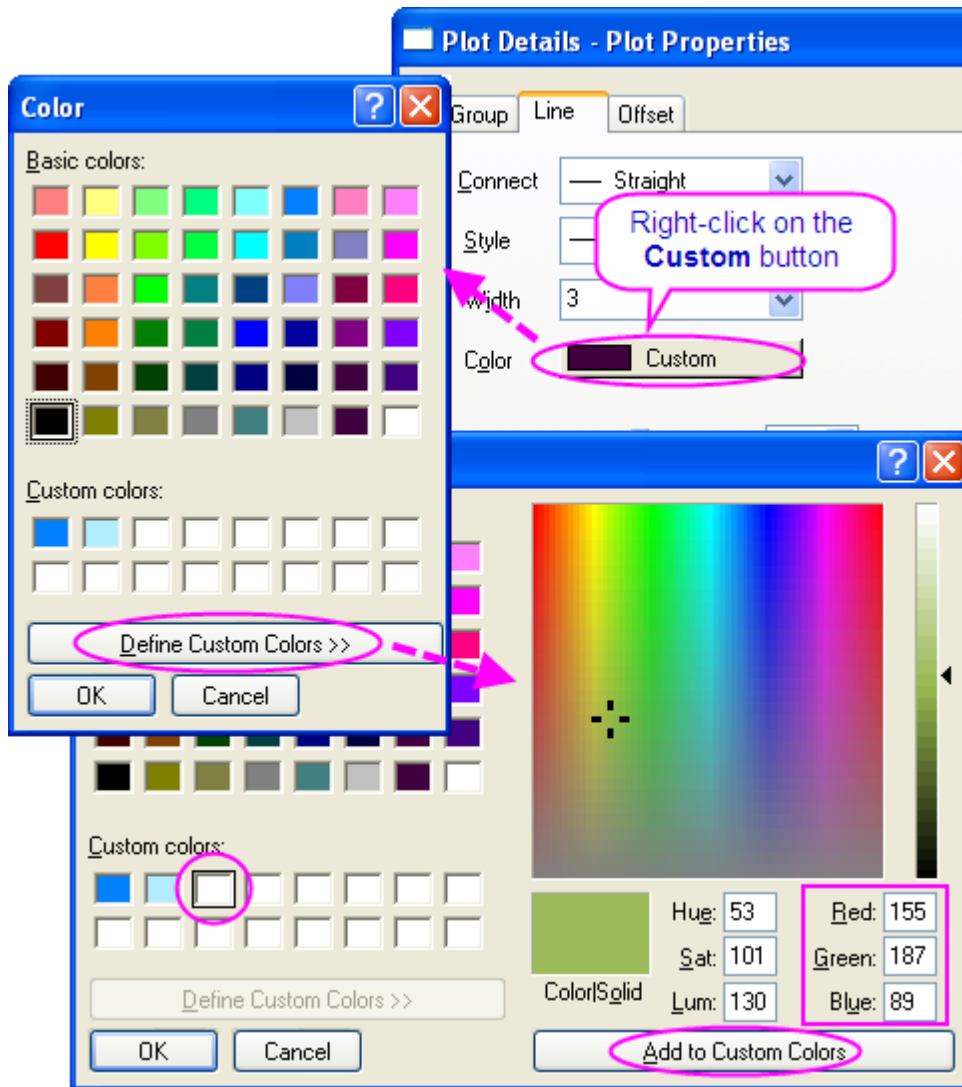

Click **OK** to close the dialog. Set **Transparency** as **50**

5. Repeat the step 3 for the other two plots. Except, set the colors of the second plot and the third plot as **RGB(192, 80, 77)**, **RGB(79, 129, 189)** respectively.
6. In the left panel, select the first of the three error plots. On the **Error Bar** tab, set **Connect** as **Straight**, then the **Fill Area Under Curve** option will show up in **Style** section. Check the box before it and the **Pattern** tab should now be available.



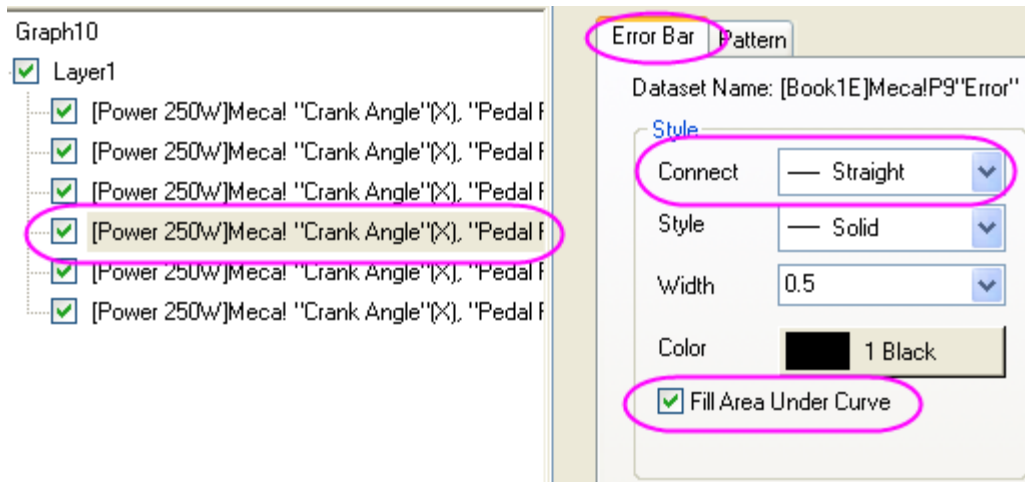

Set **Color** as **Automatic**.

- On the **Pattern** tab, change the fill color to the custom color saved before to match the line color, and set Transparency to 50.

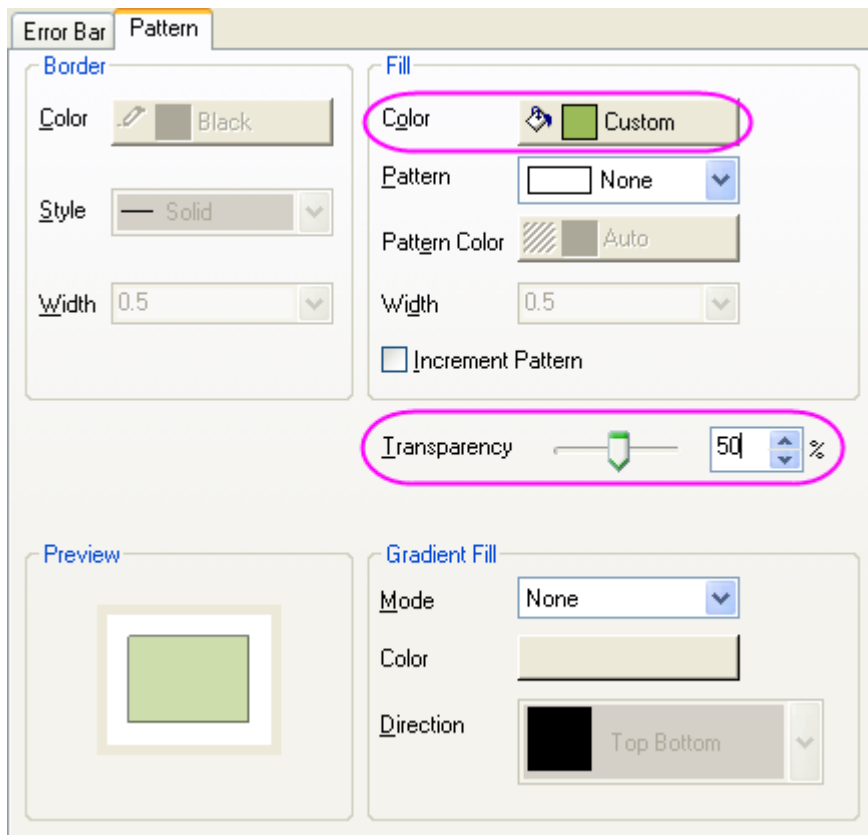

- Repeat the last two steps for the other two error plots. Click **OK** to complete the graph.

### 6.2.10 Mark out a segment of plot with different plot style

### 6.2.10.1 Summary

In Origin, you can mark out a segment of plot with different plot style, such as a segment of dashed in a solid line plot.

Minimum Origin Version Required: Origin 8.0 SR6

### 6.2.10.2 What you will learn



- Use the **Plot Setup** dialog to create a graph
- Mark out the special segment of a plot

### 6.2.10.3 Steps

1. Start with an empty worksheet. Select **Data: Import from File: Single ASCII...** from the Origin menu to open the **Import Single ASCII** dialog. Browse to the `\Samples\Graphing` subfolder of the Origin program folder, and import the file `AXES.DAT`.
2. Click the  button on the **Standard** toolbar to create a new graph window and then select **Graph: Plot Setup** from the main menu to bring up the **Plot Setup** dialog.
3. Show all of the three panels of the **Plot Setup** dialog. Select the **AXES** worksheet in the top panel. Then go to the middle panel to select **A** as X and **B** as Y. After that, click **Add** to add this data plot to the

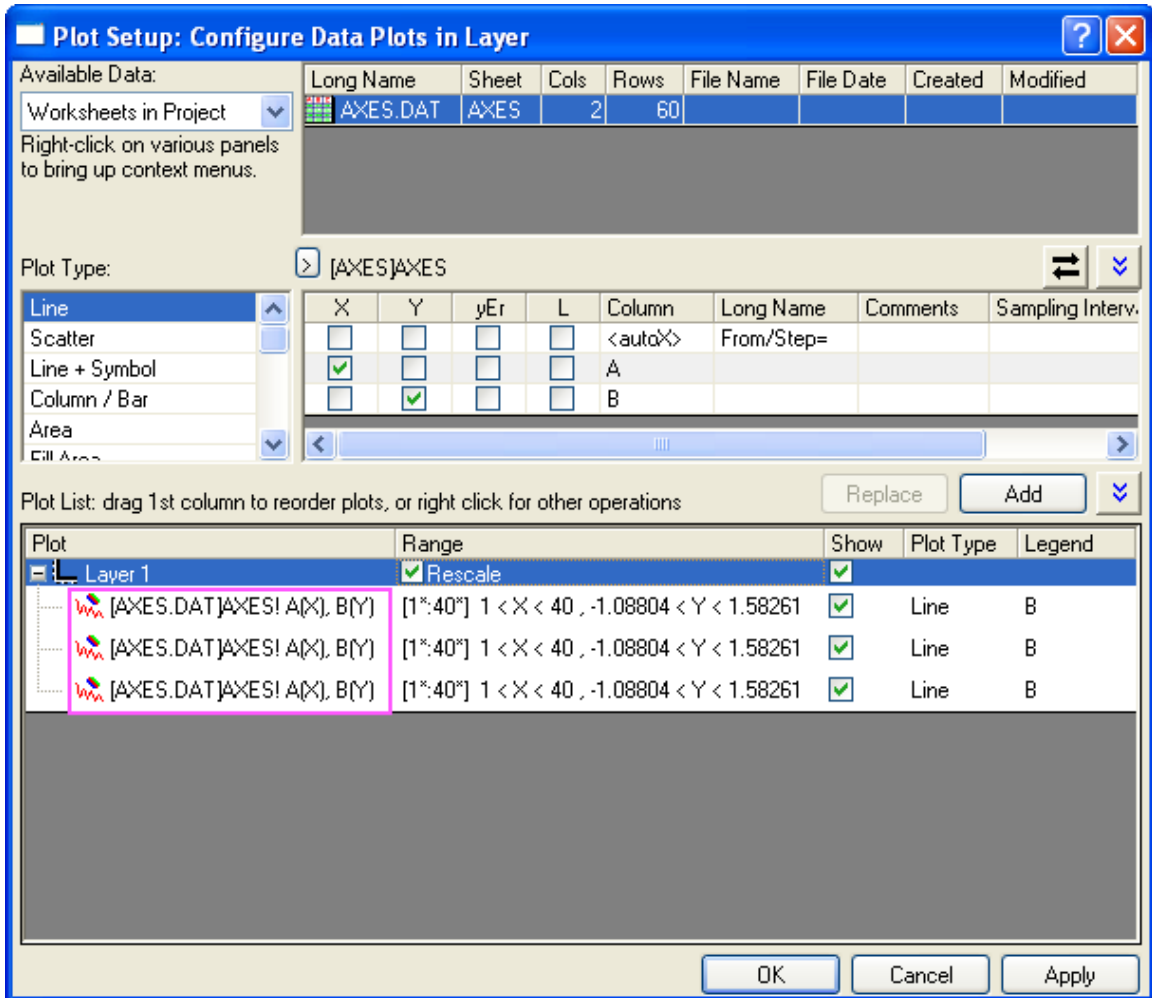
bottom panel. Repeat this step three times. Three data plots should be listed in the bottom panel.



In order to show all three panels in **Plot Setup** dialog, please expand **Plot Type** panel by clicking  and expand **Available Data** panel by clicking  again.

Please refer to [Plotting using Plot Setup](#) for more information.

- In the lower panel, click in the **Range** column that corresponds to the first data plot. The  button should be activated. Then click this button to open the **Range** dialog box.

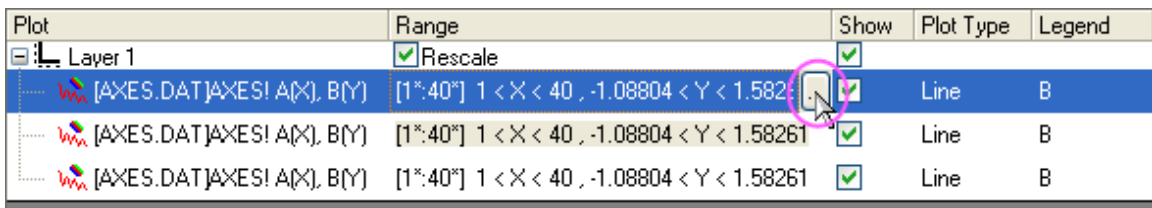

- Clear the **Auto** check boxes (if they are selected) and then set **From** to **1** and **To** to **20**. Click **OK** to close the dialog.

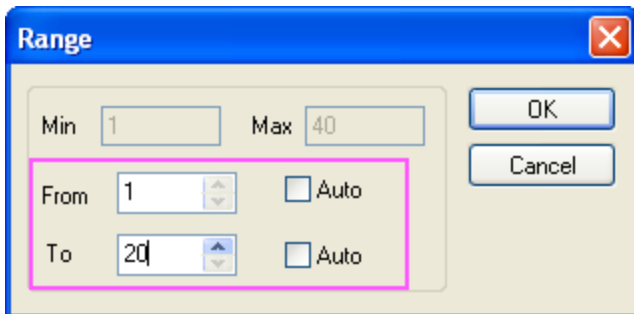

- Similarly, set the ranges for other two data plots to "20 to 30" and "30 to 40" respectively.

Plot	Range	Show	Plot Type	Legend
Layer 1	<input checked="" type="checkbox"/> Rescale	<input checked="" type="checkbox"/>		
[AXES.DAT]AXES! A(X), B(Y)	[1:20] $< X < 20, -0.96201 < Y < 0.3638$	<input checked="" type="checkbox"/>	Line	B
[AXES.DAT]AXES! A(X), B(Y)	[20:30] $20 < X < 30, -0.96201 < Y < 1.35909$	<input checked="" type="checkbox"/>	Line	B
[AXES.DAT]AXES! A(X), B(Y)	[30:40] $30 < X < 40, -1.08804 < Y < 1.58261$	<input checked="" type="checkbox"/>	Line	B

- Click the **OK** button to close the **Plot Setup** dialog. You should get a graph like this:

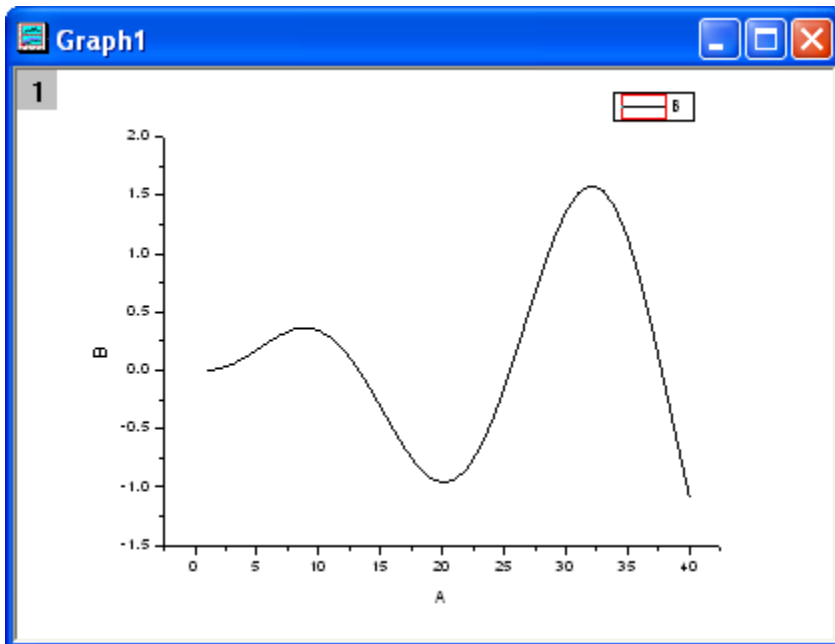

- Double-click on the curve in the graph window to open the **Plot Details** dialog. Select the second data plot from the left panel. In the right panel, change the **Style** to **Short Dash**, and then click the **Ok**

button.

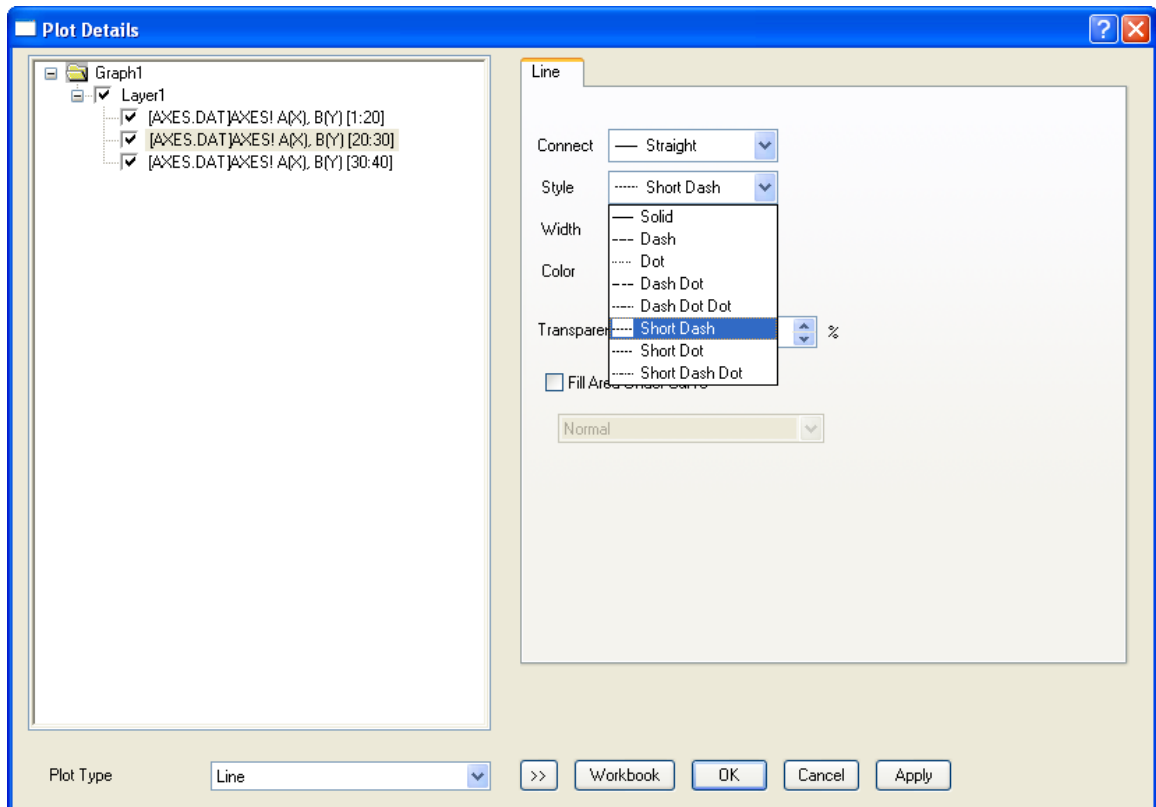

9. Finally, we get the plot with a range marked out.

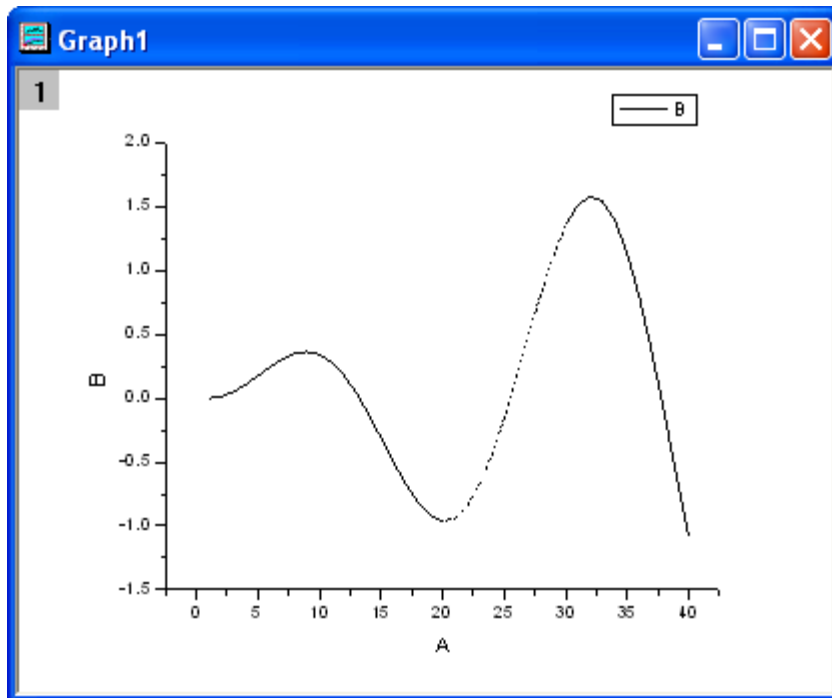

### 6.2.11 Overview of Customization

### 6.2.11.1 Summary

Editing your Origin graph is very easy. Any graph element can be selected and with its associated dialog, the properties can be modified. In fact, you can customize your graph right down to a single data point.

This tutorial will show you how to:

- Resize a Layer
- Add a Layer Title
- Customize and Save a Template
- Customize Axes
- Apply a Graph Theme
- Change Plotting Order in a Layer
- Customize a Point
- Customize a Grouped Plot
- Create a Color-mapped Waterfall Plot

### 6.2.11.2 Re-sizing Layer

1. Open **Customizing Graphs.OPJ** from the **\Samples\Graphing** folder and select the **Resize Graph and Customize Symbol** folder from the **Project Explorer** window.
2. Make **Graph2** active and right-click inside the layer, above the data points to select **Add/Modify Layer Title** from the context menu that opens. Add a title, as shown in the graph below:

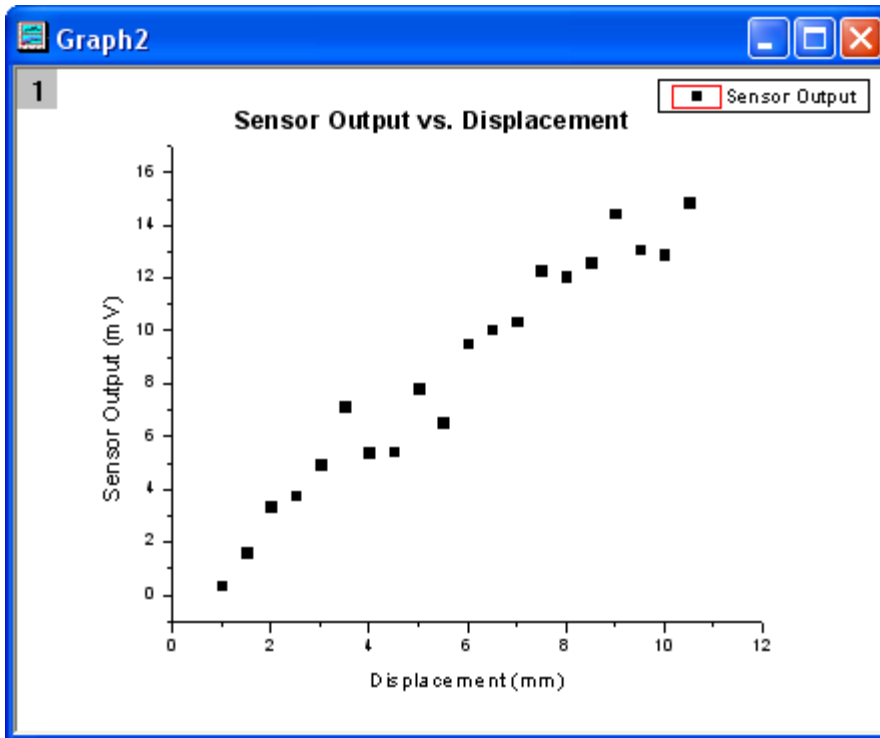

3. The layer can easily be resized graphically by dragging the sizing handles. To resize it, single click inside the layer, but not on a data point. The layer will become selected as seen below, and then you can drag

one of the 8 anchor points to resize the layer. Note: If you hold the CTRL key down while dragging, the aspect ratio will be maintained.

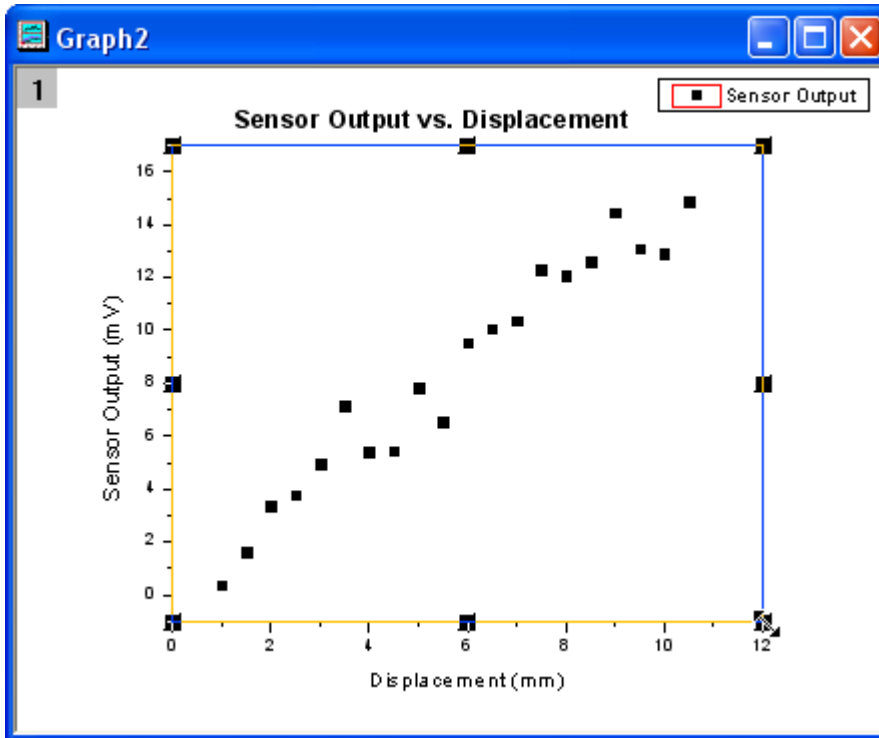

4. You can also use the **Plot Details** dialog by specifying exact numbers to dictate the layer size more precisely. Double-click inside the layer to open the **Plot Details** dialog. On the **Size/Speed** tab, set the layer area to the values shown in the image below:

Layer Area				Units
Left	1.895	Top	0.94	inch
Width	6.785	Height	5.97	
<input checked="" type="checkbox"/> Link Axis Length to Scale with X:Y Ratio				1

Note: Check the [Link Axis Length to Scale with X:Y Ratio](#) check box to set the length ratio of X and Y axes (the Width and Height of the layer frame) to maintain the aspect ratio of the actual X and Y scales when the layer size is changed. You can set your own ratio value in the following box.

### 6.2.11.3 Customize Data Plot and Axes

In this section, we will show you how to change the color of a data plot, and customize the axes.

- Click on one of the data points of **Graph2** to select the entire data plot, and change the color of the data points to **red** by using the **Line/Border Color** button  in the **Style** toolbar.
- Next use the **Axis** dialog to customize the axes. Double-click on the X-axis to open the dialog and set the controls as follows:

- Select the **Horizontal** icon in the **Scale** tab, select the **Type** under *Major Ticks* as **By Counts** and input 5 as the Count.
- Select the **Vertical** icon in the **Scale** tab, set the **From** as **0**, **To** as **16**, **Type** for *Major Ticks* as **By Counts** and enter **11** for **Counts**.
- Go to the **Line and Ticks** tab and select both Top and Right page with CTRL button pressing down. Check the **Show Line and Ticks** box to show the line and ticks for the top X and the right Y axis. Click **OK** to apply the settings and close the dialog. The graph should appear as shown below:

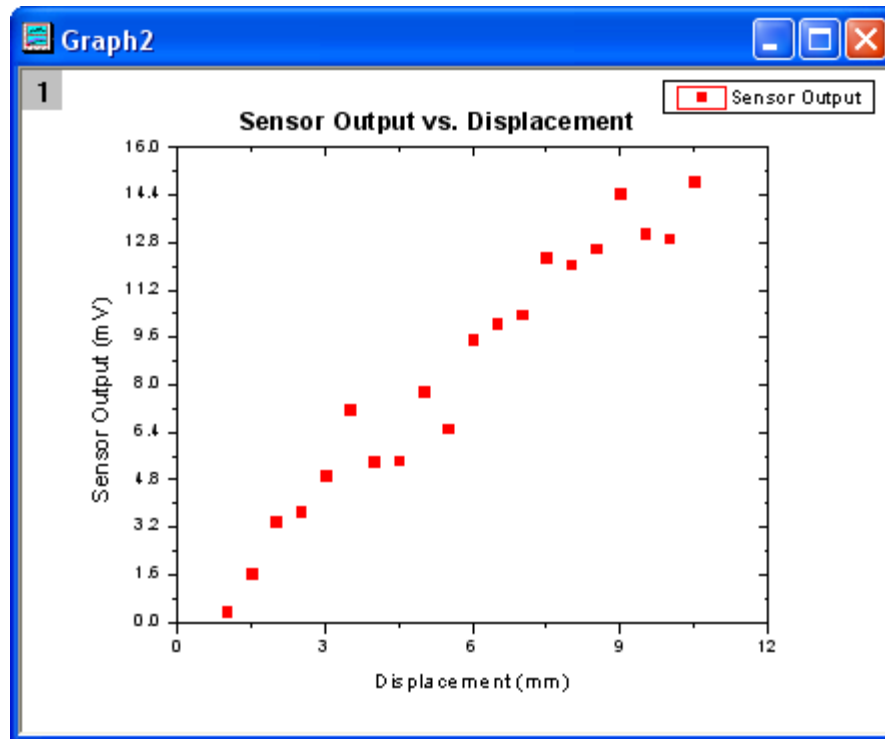

#### 6.2.11.4 Save and Reuse a Template

In this section, we will show you how to save the graph above as a template and reuse it.

1. In the menu, select **File: Save Template As** (alternatively, right-click on the graph window title bar and choose **Save Template As** from the context menu) and rename the template as **MyGraphTemplate**.



Then click the **OK** button to save it.

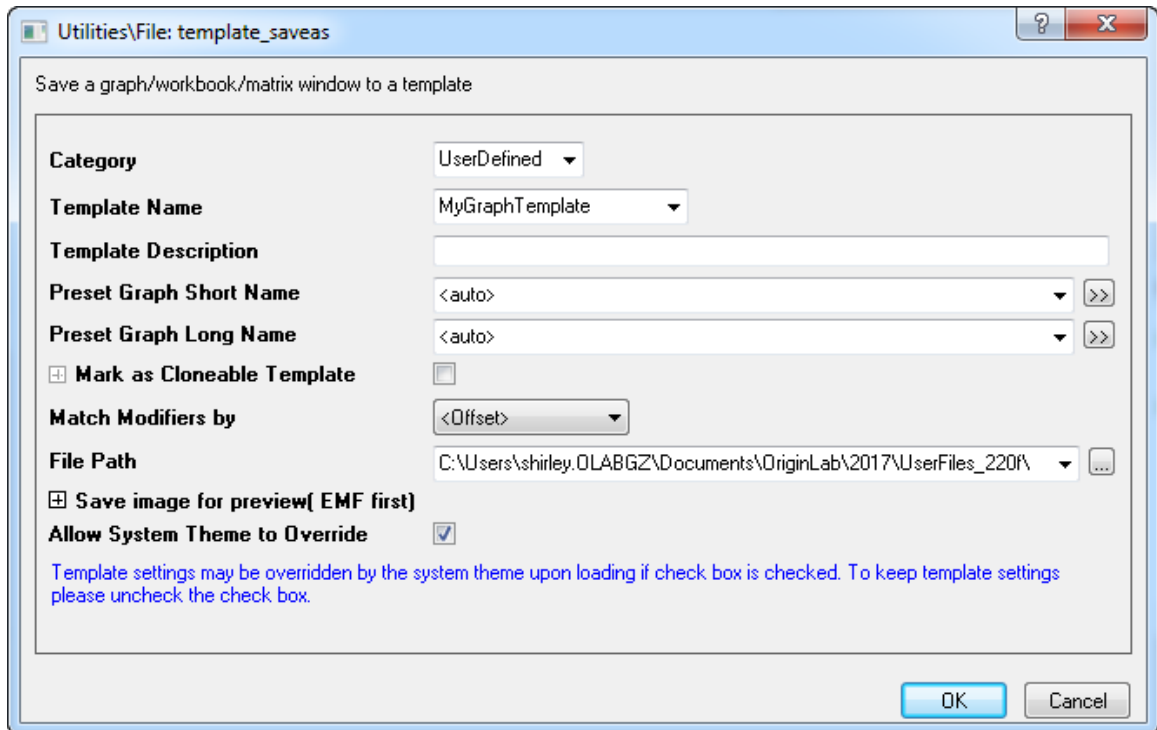

2. Create a new workbook and import the data file `\Samples\Curve Fitting\Sensor2.dat`, by using **Data: Import from File: Single ASCII**. Highlight column B and select **Plot: Templates: User: Template library**. Then select **MyGraphTemplate** and click the **Plot** button to create a graph.

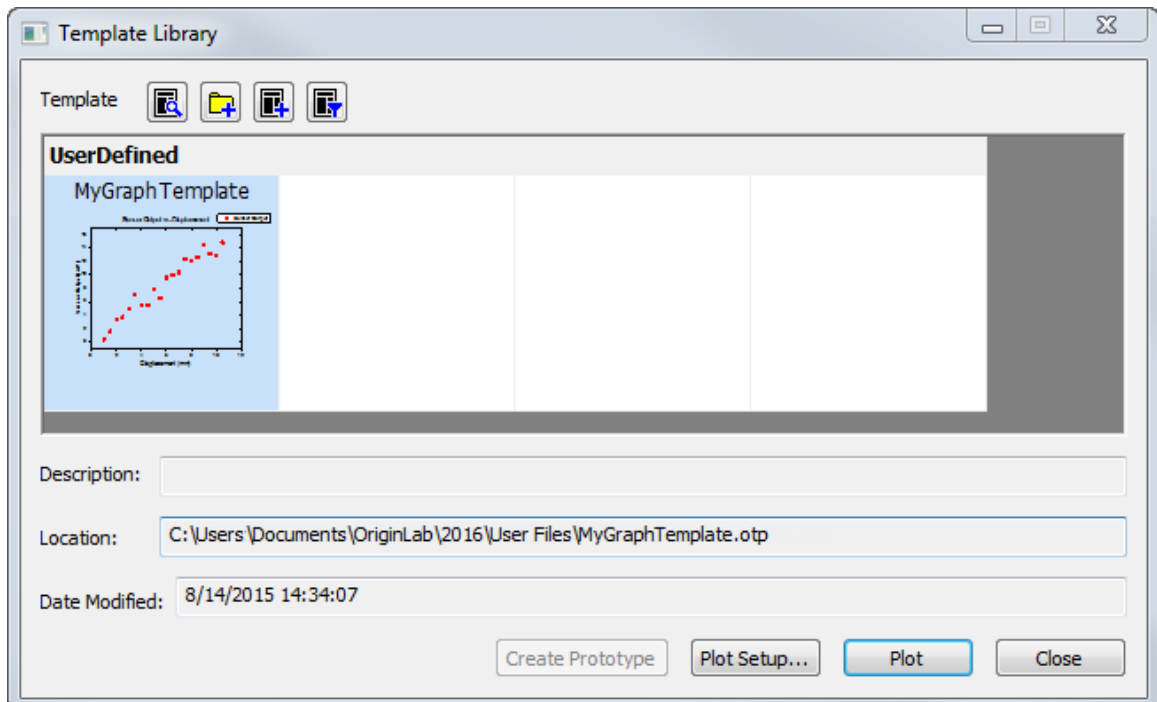

The graph should look like:

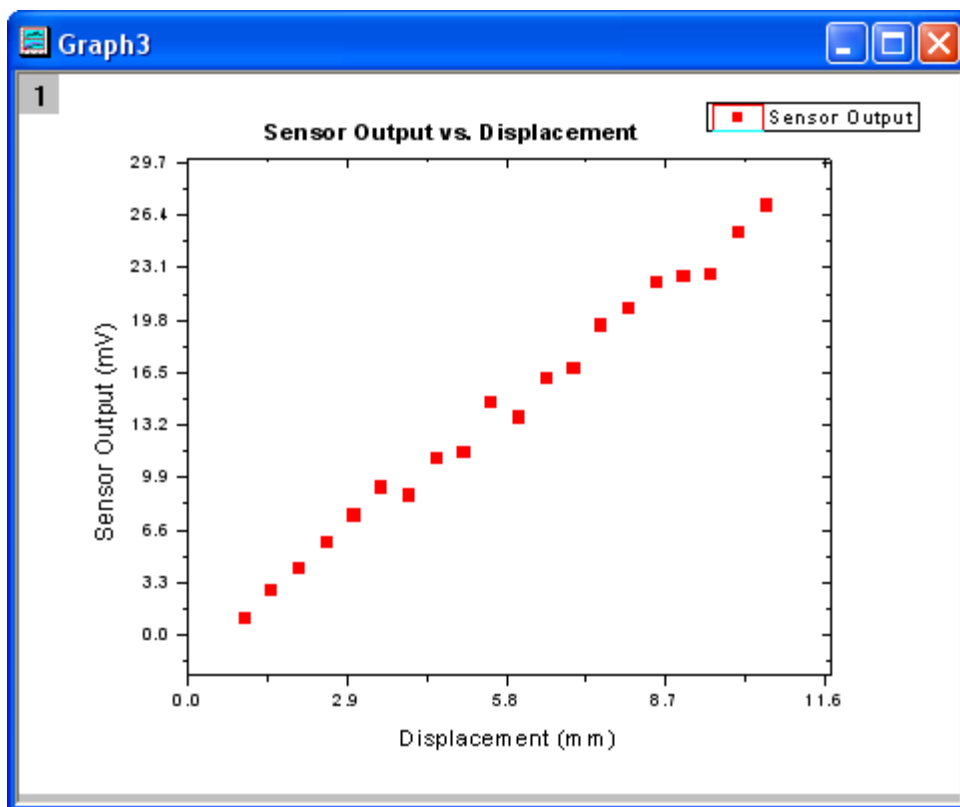

Note, you can also use the batch plotting tool to create multiple graphs at once from different worksheets/workbooks with same data structure. You can learn how this tool work from [this tutorial](#).

#### 6.2.11.5 Changing graph using theme

Origin stores the properties of a graph in a theme file. In this section we will show you how to customize a graph by using a theme.

1. With **Graph3** active, select **Preferences: Theme Organizer** to open a dialog. Select the **Times New Roman Font** theme and click **Apply Now**. Select **Ticks All In** and click **Apply Now**, then click the **Close**

button to close the dialog. The graph should resemble the following graph:

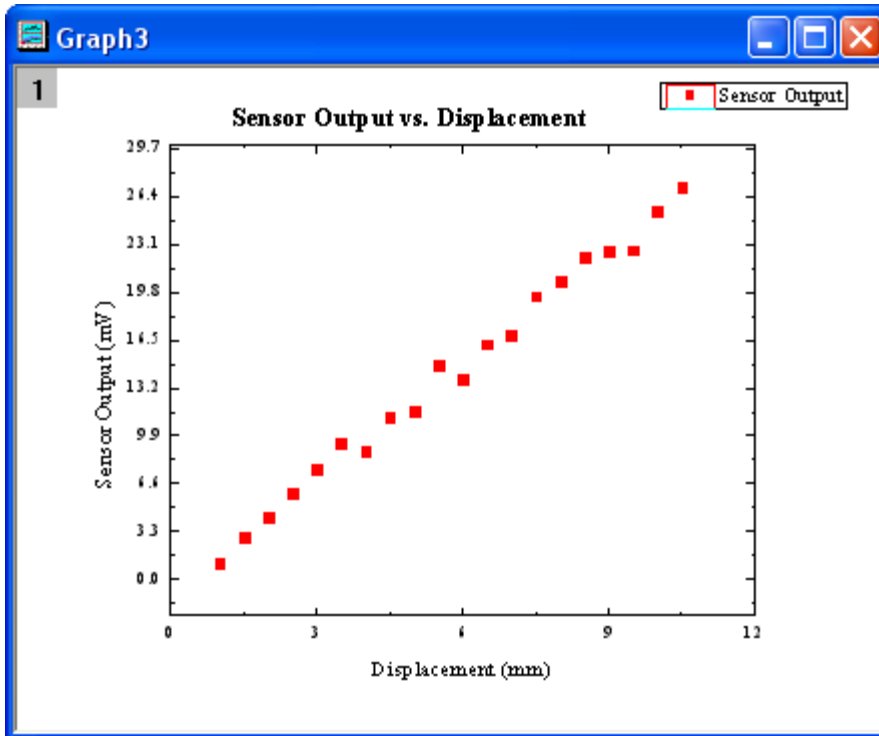

- The next step is to copy the formatting of the current graph and paste it to **Graph2**. Right-click to the right of the layer, anywhere on an empty white or grey space and select **Copy Format: All Style Formats**. Activate **Graph2**, right-click in a similar spot and select **Paste Format**. **Graph2** should look like the image below:

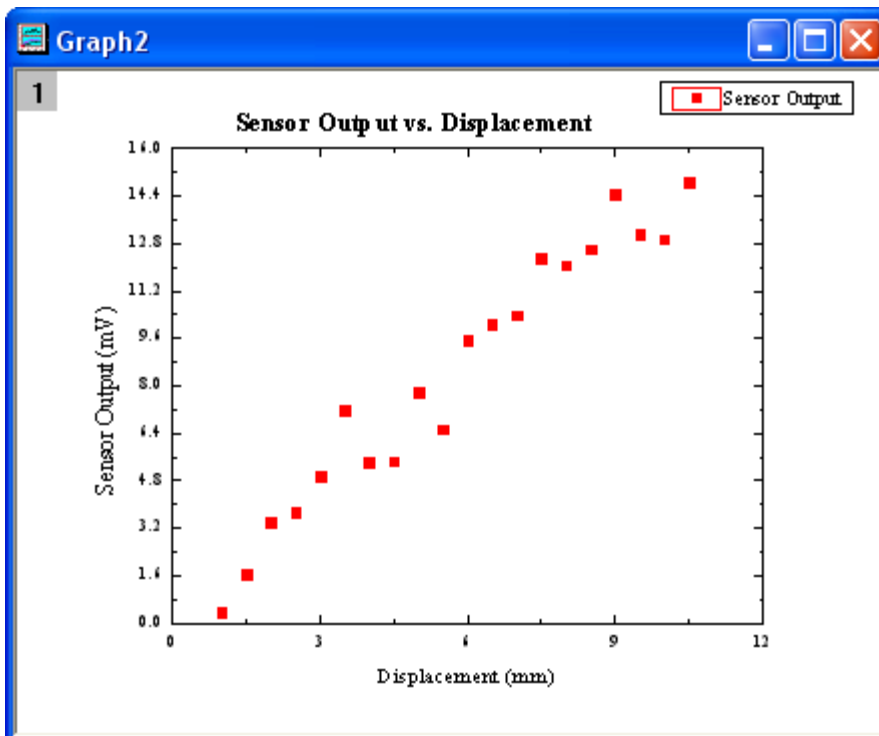

### 6.2.11.6 Plotting Order

You can reorder the data plots either by the the **Layer Contents** dialog, **Object Manager** or the **Plot Setup** dialog.

Open **Customizing Graphs.OPJ** from the \Samples\Graphing folder and select the **Plotting Order** folder from the **Project Explorer** window.

#### 6.2.11.6.1 By Layer Contents Dialog

1. Activate Graph 1 window. Double-click on the Layer 1 icon on the top left corner of the graph to open the **Layer Content** dialog.

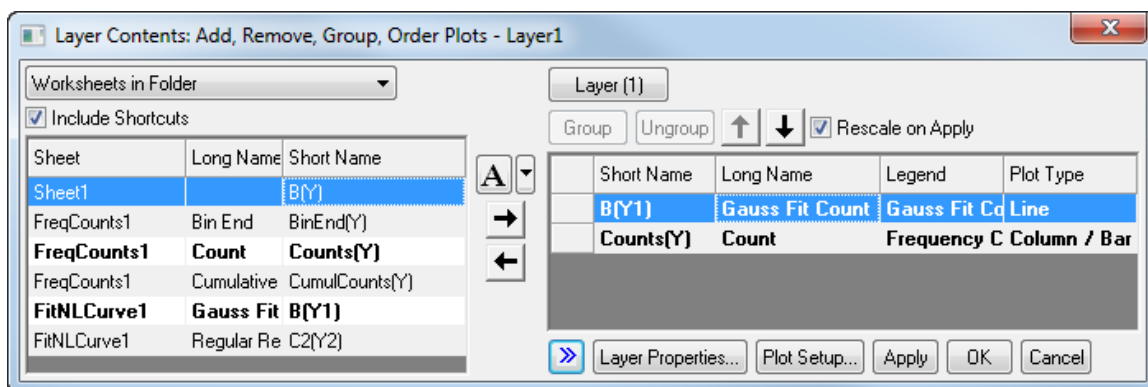

2. Click the >> button to hide the left panel. In the right panel, select the Gauss Fit Count line plot. Click the downward pointing arrow button to move the line plot down in the plotting order.

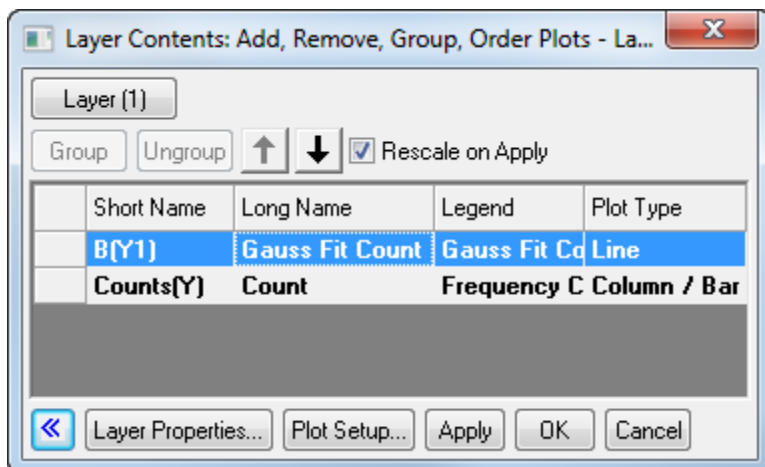

3. Click the **Apply** button. The Gauss Fit Count line plot is now on top of the column plot. Click the **Close** button to close the dialog.

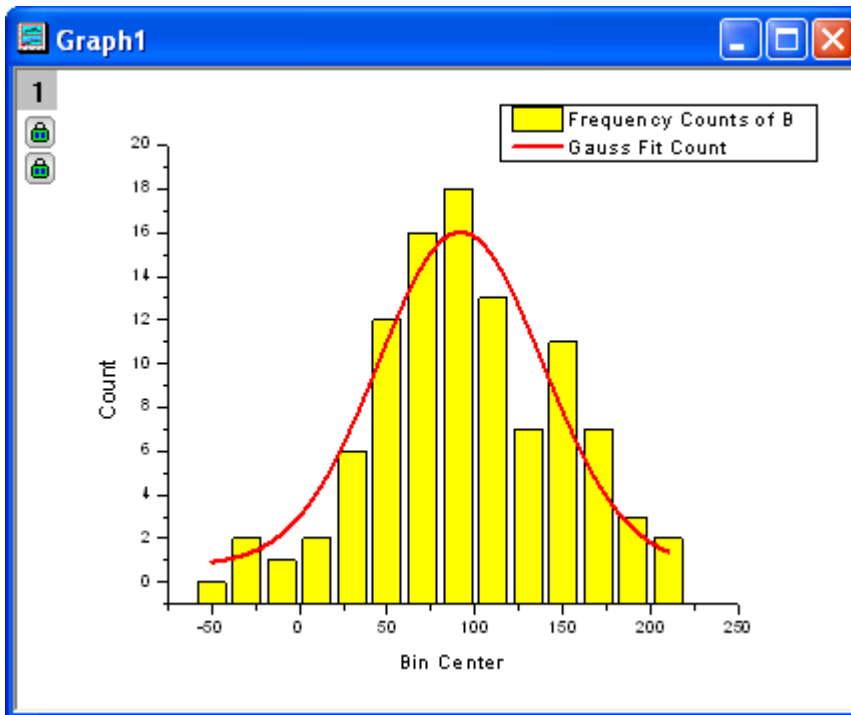

#### 6.2.11.6.2 By Object Manager

1. Activate Graph 1 again. Expand the **Object Manager**, which should be docked to the right edge of Origin workspace by default, by moving your mouse over to the **Object Manager** bar.
2. Right-click on the Gauss Fit Count line to select Move Up from context menu to move this plot upward.

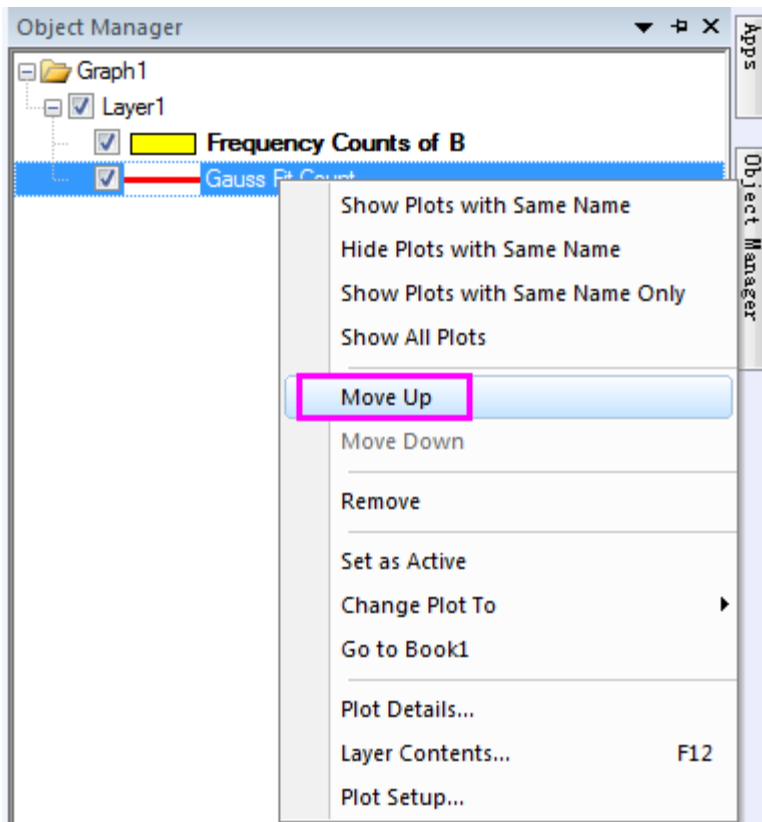

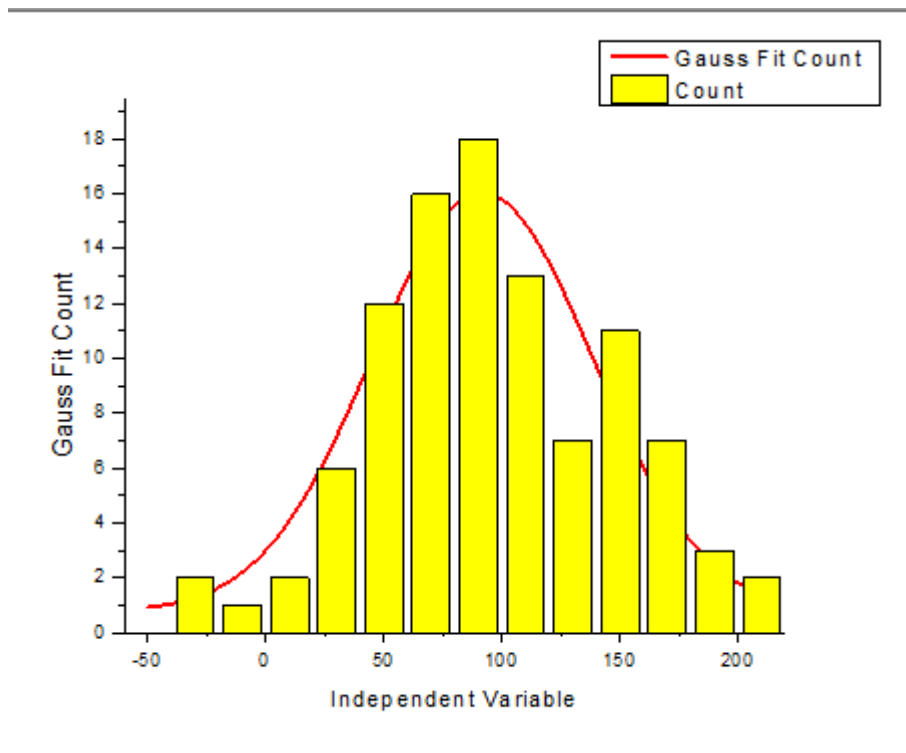

- Then, you will see the red line will be back of the histogram plot.



### 6.2.11.6.3 By Plot Setup Dialog

1. Use the same data as the previous example. In the **Plotting Order** folder activate **Graph 1**. Select **Graph: Plot Setup** from the main menu to open the **Plot Setup** dialog (You can also right-click on layer 1 and select **Plot Setup...**).



In order to show all three panels in **Plot Setup** dialog, please expand **Plot Type** panel by clicking  and expand **Available Data** panel by clicking  again.

Please refer to [Plotting using Plot Setup](#) for more information.

2. In the **Plot List** panel, drag the line plot and drop it beneath Column/Bar Plot Type.

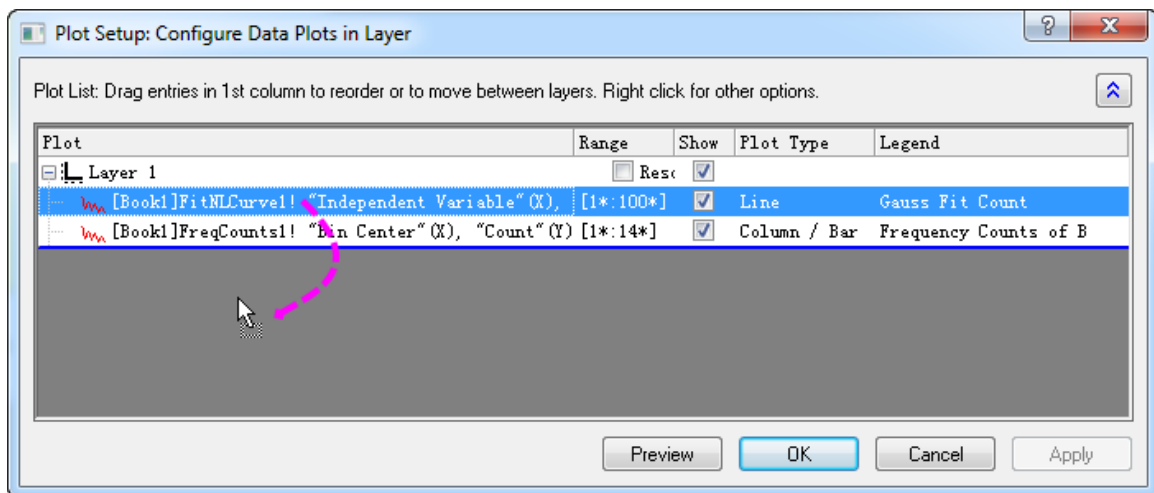

- Click the **OK** button and you will see that the red curve is now drawn on top. Notice the legend reflects the new plotting order as well.

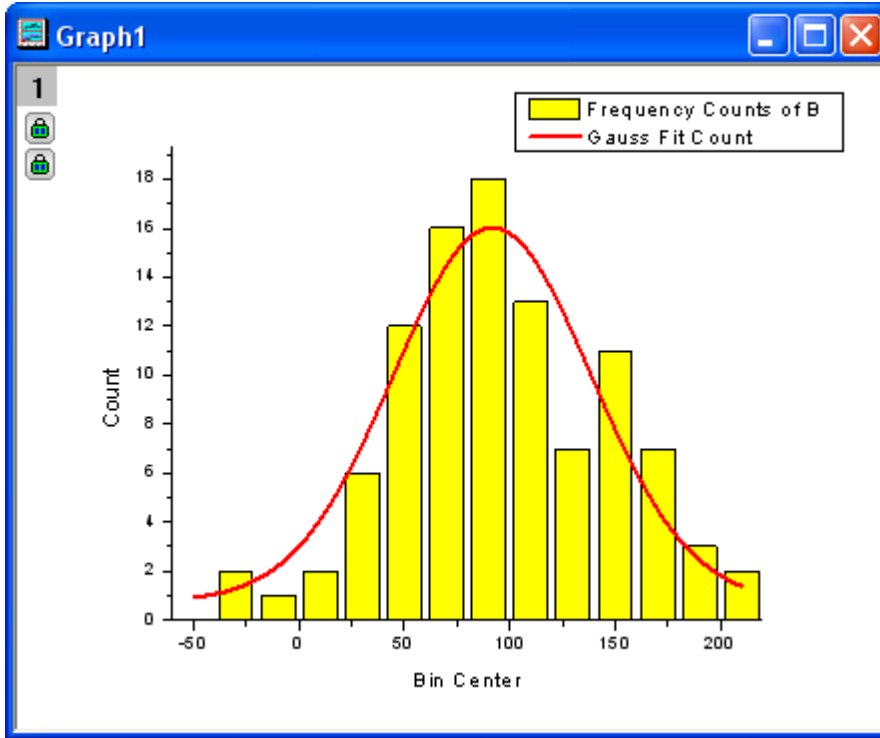

#### 6.2.11.7 Customize points

In this section, we will show you how to customize a single data point.

- We will continue to work in the **Plotting Order** folder. Make sure **Graph 1** is active. Note that if you click to select one of the columns, all columns are selected. Click again to select just that one column. Change the color to **green** using the **Fill Color** button  on the **Style** toolbar.
- You can also use the **Plot Details** dialog to customize single columns separately from the rest. Hold down the CTRL key while double-clicking on the columns to open the **Plot Details** dialog. The settings in this dialog will edit the properties of just that single data point. Note that the index number for that selected data point is highlighted in the left panel of the Plot Details dialog. Set the **Gradient Fill** group as follows, to fill the column with a yellow to red color gradient.



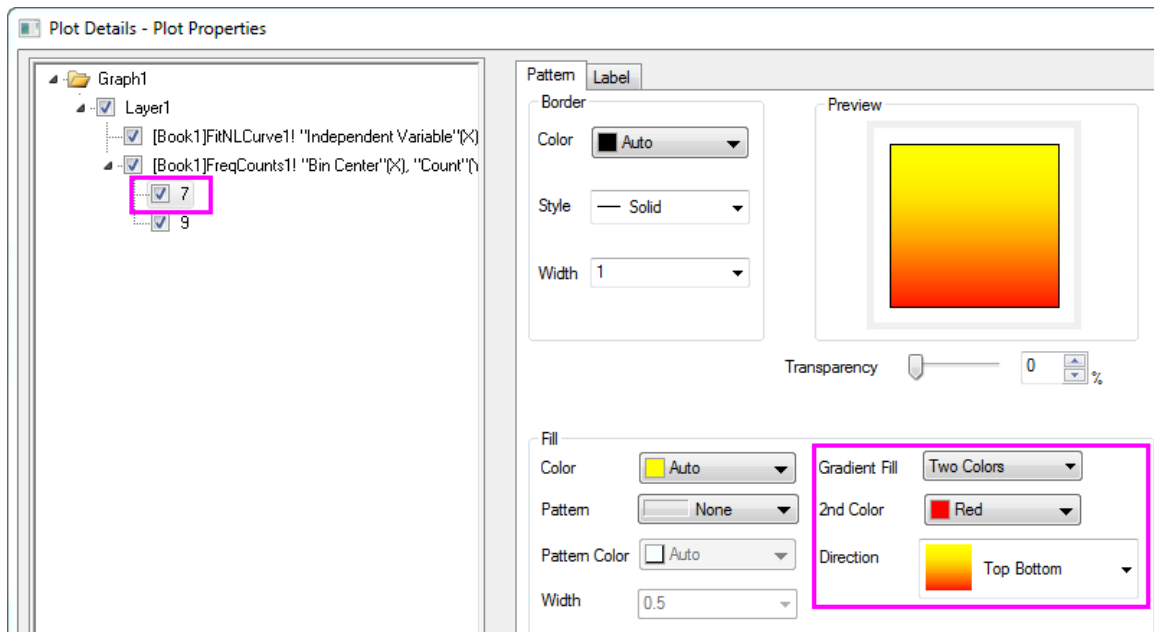

Your graph should resemble the following image:

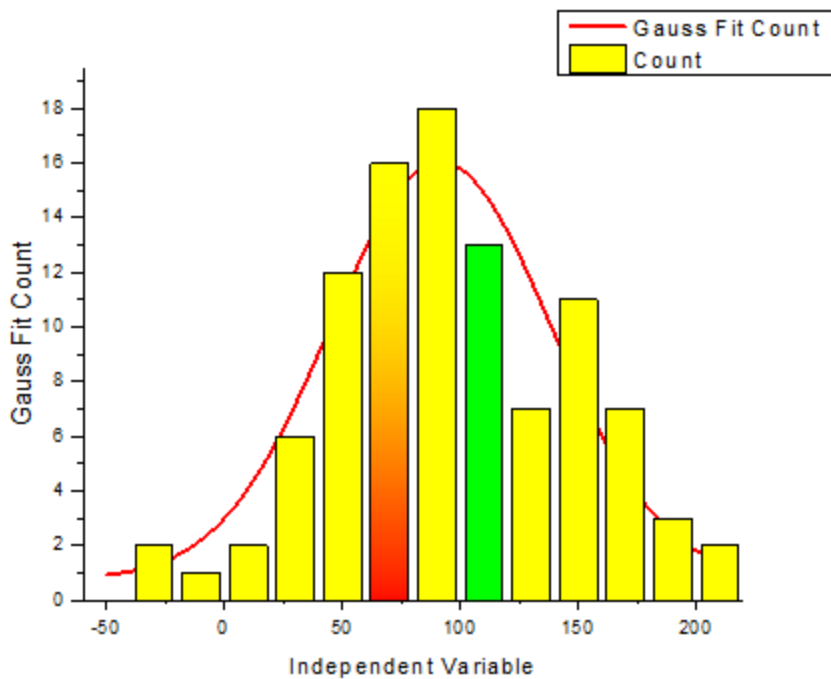

3. You can customize a pie chart segment in the same way. In the **Edit Single Data Point** folder, activate the pie graph. Hold down the CTRL key and double-click on one of the slices to open the **Plot Details** dialog. Under the **Pattern** tab, set the **Fill Pattern** to **Dense**, and set **Pattern Color** to **Red**. (Alternatively, you could have clicked once and then clicked again on a slice to select just that one point,

and then used the Style toolbar to customize that point.) The graph should appear as the image below:

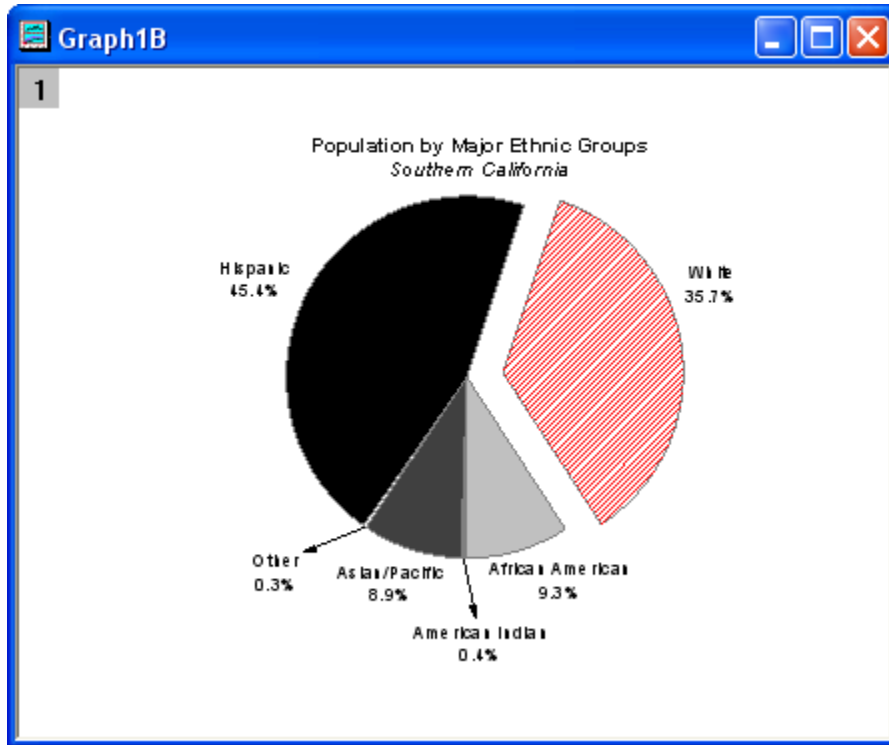

4. You can customize a single data point and label it. Go back to the **Resize Graph and Customize Symbol** folder. Hold down the CTRL key and double-click on one of the scatter points to open the **Plot Details** dialog. Under the **Symbol** tab, click the triangular **Preview** button to open the symbol gallery, and select **Sphere** for the symbol type. Increase the **Size** to **18**, and click the **OK** button to close the dialog.
5. Use the annotation tool to add the X and Y values that correspond to the customized data point. Select the **Annotation** button from the **Tools** toolbar (Hint: The Data Reader, Annotation and Data Cursor tools are grouped. If you don't see the Annotation tool, click the arrow to the lower-right of whichever tool is visible on the toolbar).

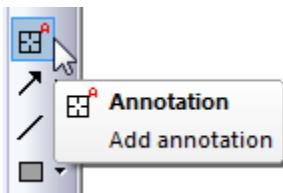

Move the annotation cursor to the customized data point and double-click on it. Origin will automatically add a text object. Hit the ESC key or click on the Pointer button to exit annotation mode. Single-click and drag to position the text object. A line will automatically be drawn connecting the point and the label.

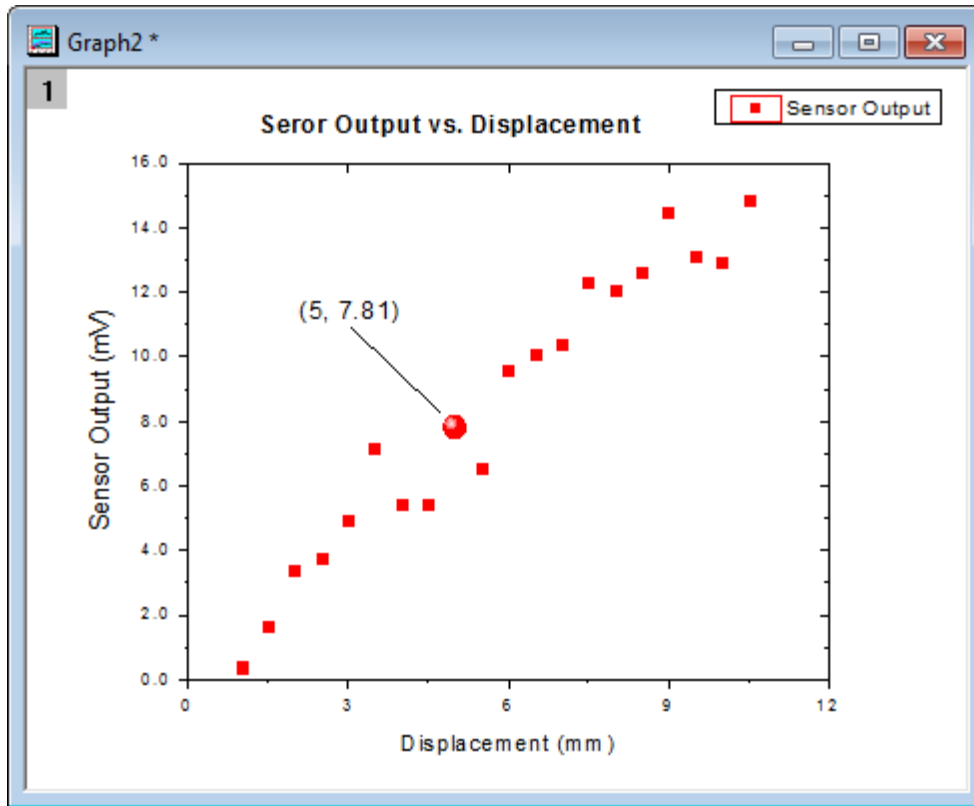

Right-click on the text object and select the **Properties...** to open the **Annotation-Text** dialog. Then you can customize the text label format in the this dialog. In the **Text** tab enter

`%(1,@LL)=$(Y,.2) %(1,@LU)` in the edit box. And the button  to the right of the edit box provides

some [frequently used notations](#) and example syntax.

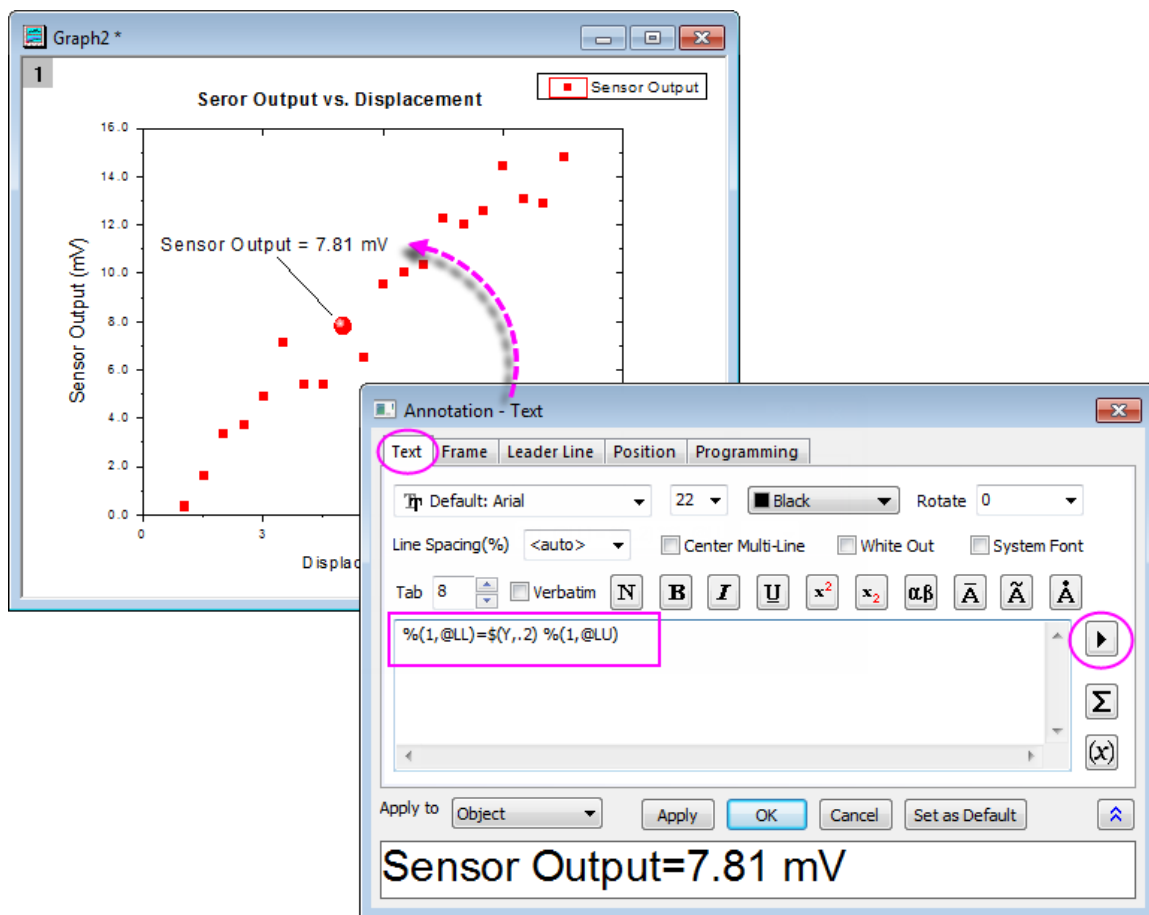

Beginning with Origin 2017, you can drag annotation labels from point to point. Click the **Pointer**  button, press the ALT key and use the cross-hairs to drag the label to another data point.

#### 6.2.11.8 Group plots

So far, we have been customizing data points in a single data plot. In this section, we will show you how to customize a grouped data plot.

1. Select the **Grouped Data** folder. **Book3** will be active. Highlight the entire worksheet and click the line button  on the **2D Graphs** toolbar to create a line graph.
2. Double-click on the X-axis to open the **Axes** dialog box. Set **From** as **0.5** and **To** as **3.0**. Select **Fixed** from the **Rescale** drop-down list (you will need to scroll up in the list). This prevents the **From** and **To** values from changing while rescaling. Click **OK** to apply these settings.
3. Double-click on a blank place above the line plots, to open the **Plot Details** dialog. On the **Stack** tab, select **Auto** in the **Offset** group. Click **OK** to close the dialog.

4. Select **Graph: Rescale to Show All**. The Y scale of the graph automatically rescales, while the X scale doesn't change because the option was set to Fixed. Resize the layer and drag the legend to the desired spot.

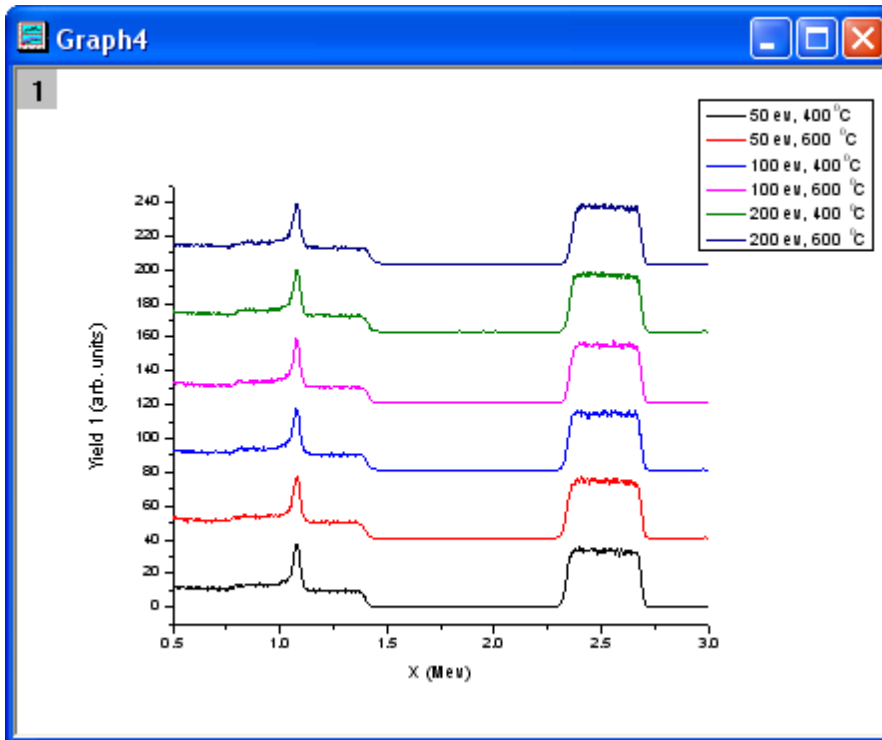

5. Click on one of the data plots to select the entire group, and then use the **Line/Border Color** button  on the **Style** toolbar to change the colors. Click on **By Plots** tab, select **Q03 Rainbow7** from the

**Increment List** as below.

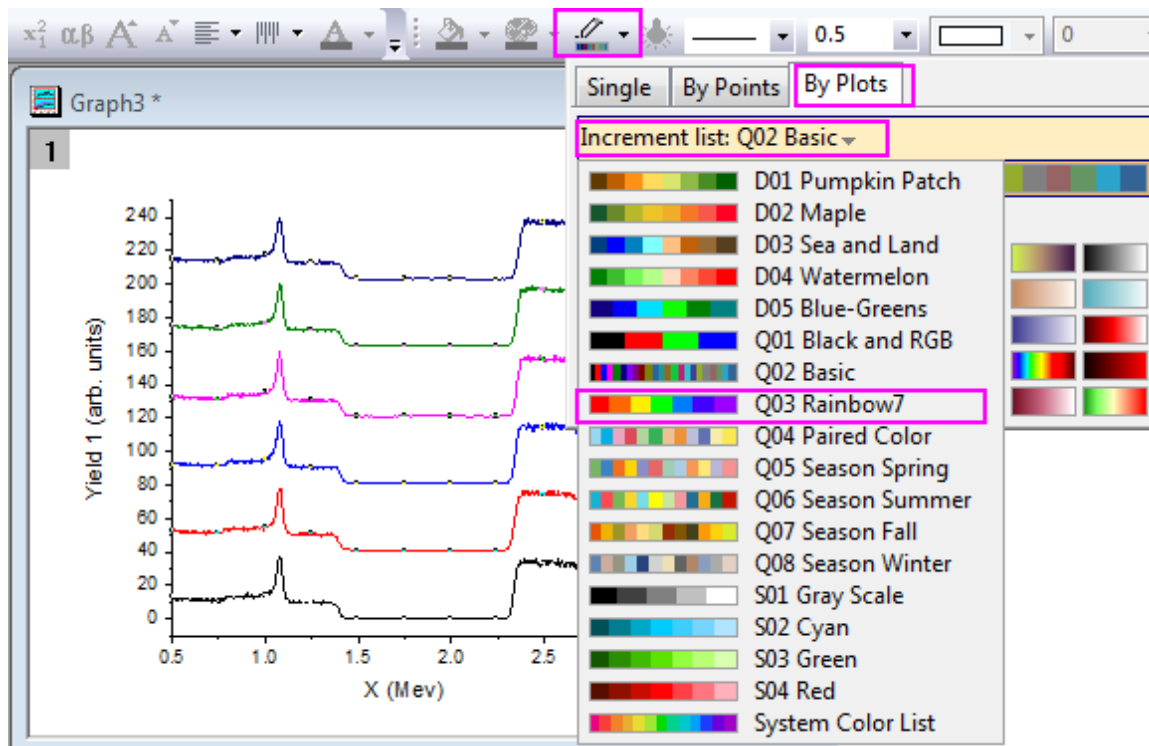

6. Then select the first increment list. The graph should look like this:

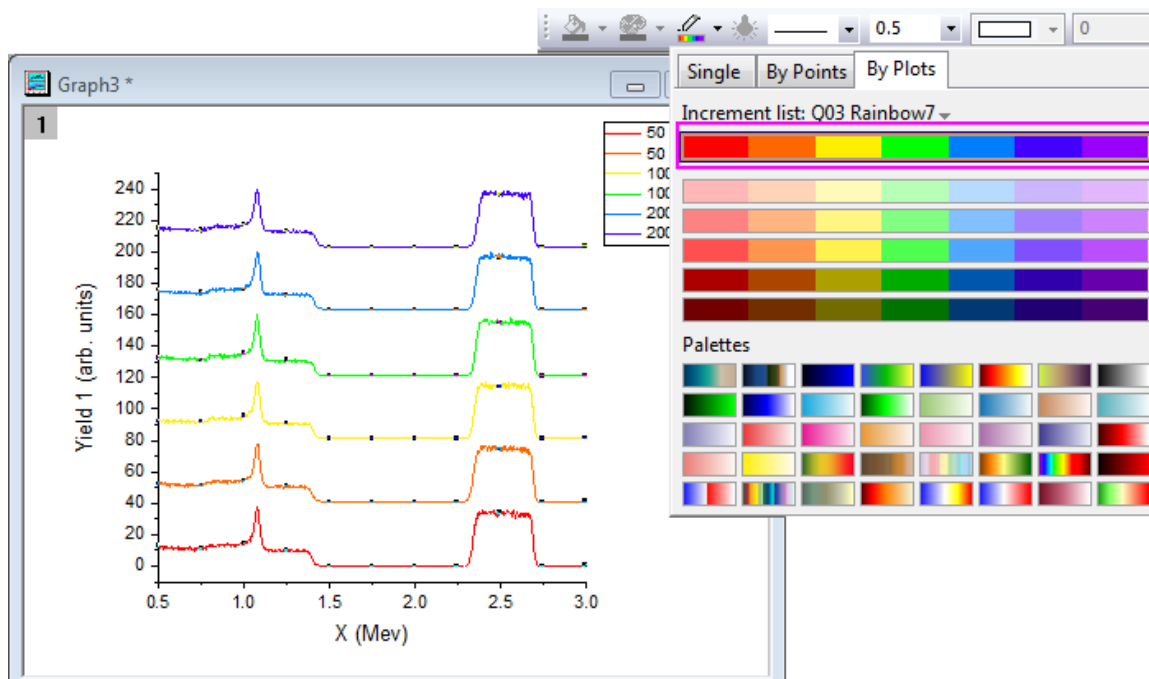

7. Though these data plots have been grouped, you can also customize each of them individually by clicking on the data plot twice. For example, clicking the yellow data plot twice (click once, pause and click again)

and then clicking the **Line/Border Color** button  on the **Style** toolbar will change the color to another color, such as **Olive**.

8. You can also customize the graph by double-clicking on one of the data plots to open the **Plot Details** dialog. Under the **Group** tab, you can click the browse button...



...to open the **Increment Editor** dialog. In this dialog, customize the graph as shown in the following image. Note that you can also drag the index of a row and move it to change the order of the color list.

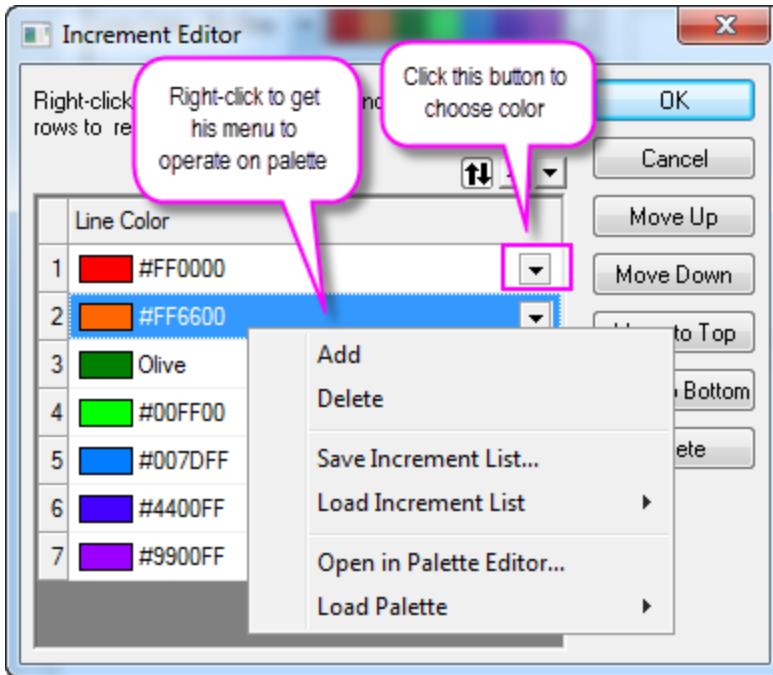

9. Right-click on the inner position of this dialog and select **Save Increment List** to save it as **MyPalette** for future use. Right-click to get the context menu and select the **Load Increment List** option. You will

find that **MyPalette** appears as the first entry in the fly-out menu, as the following image shows:

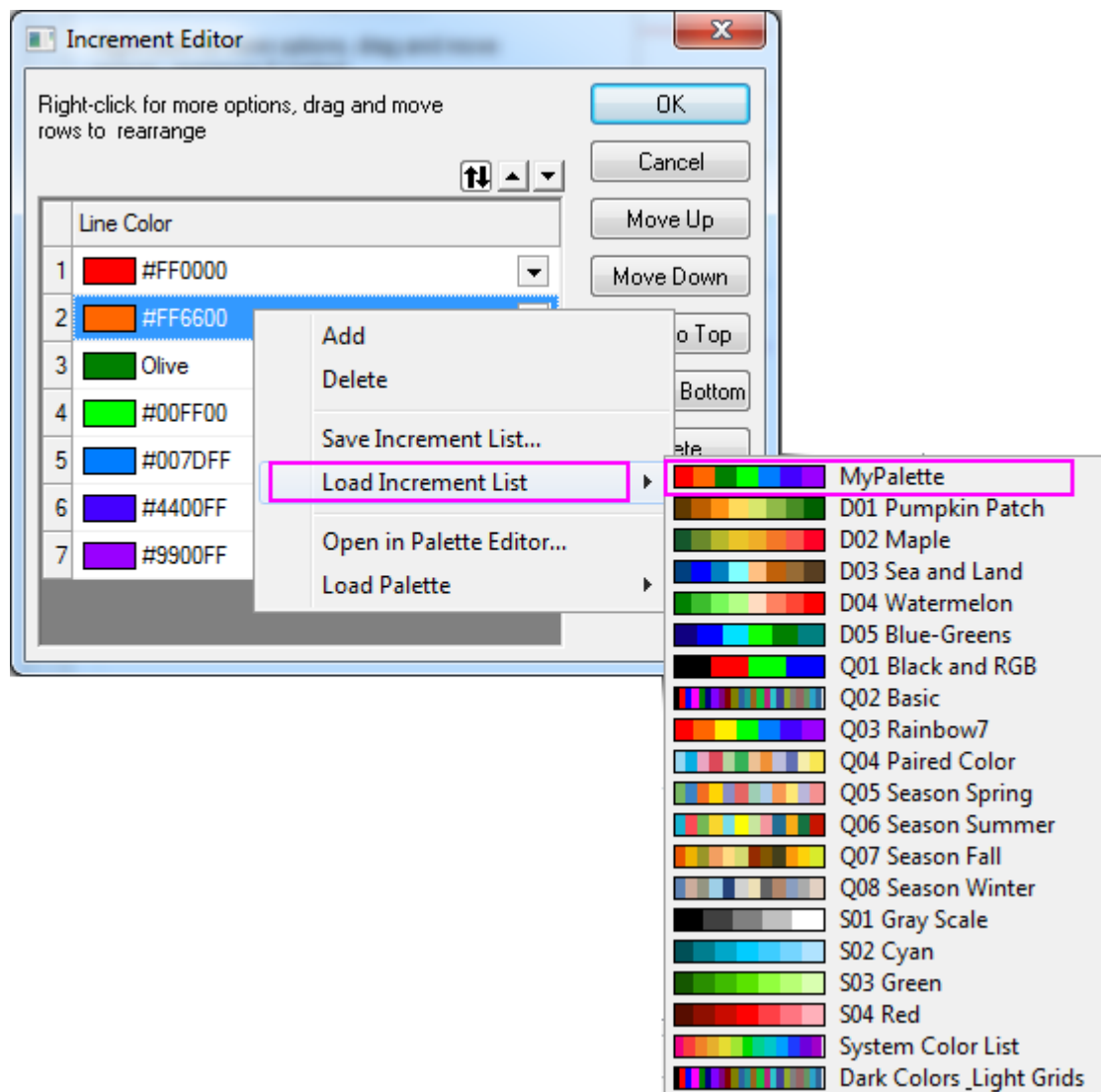



In the following section, we will show you how to use **Palettes** to set colors for a group of data plots.

1. Activate **Book3** and highlight all the columns. Select **Plot: 3D: Waterfall: Waterfall** to create a graph. Double-click on the X-axis to open the **Axis** dialog, and set **From** as **0.5** and **To** as **3** in **Scale** tab. Select **Y** icon from the **Selection** list, and set the **From**, **To**, and **Increment** of **Major ticks** option to **-10**, **100**

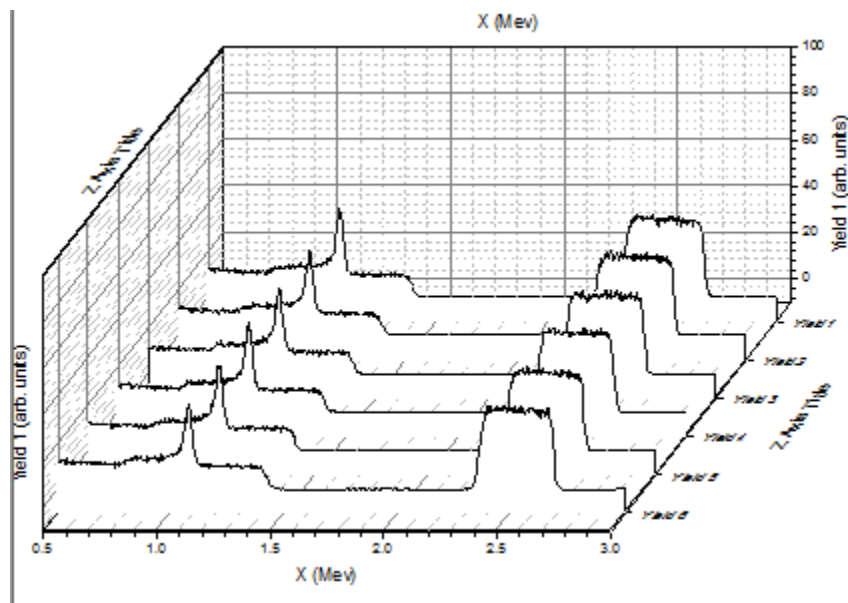

and **20**, respectively in the **Scale** tab.



- Click on one of the data plots and use the **Line/Border Color** button  on the **Style** toolbar to change the colors. You can select the **Rainbow** palette  under **Palettes** list in the **By Plots** tab. The graph should resemble the image below:

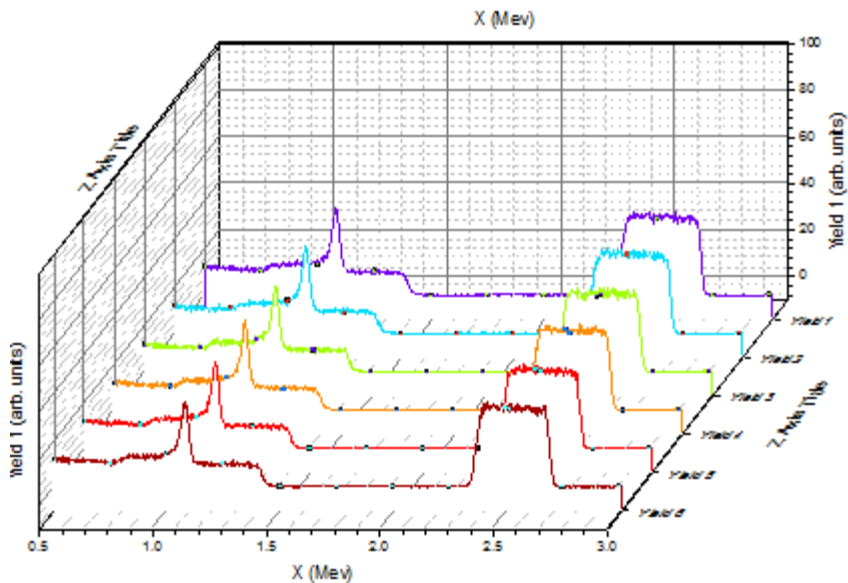

3. You can double-click on one of the plots to get the color list, as the following image shows:

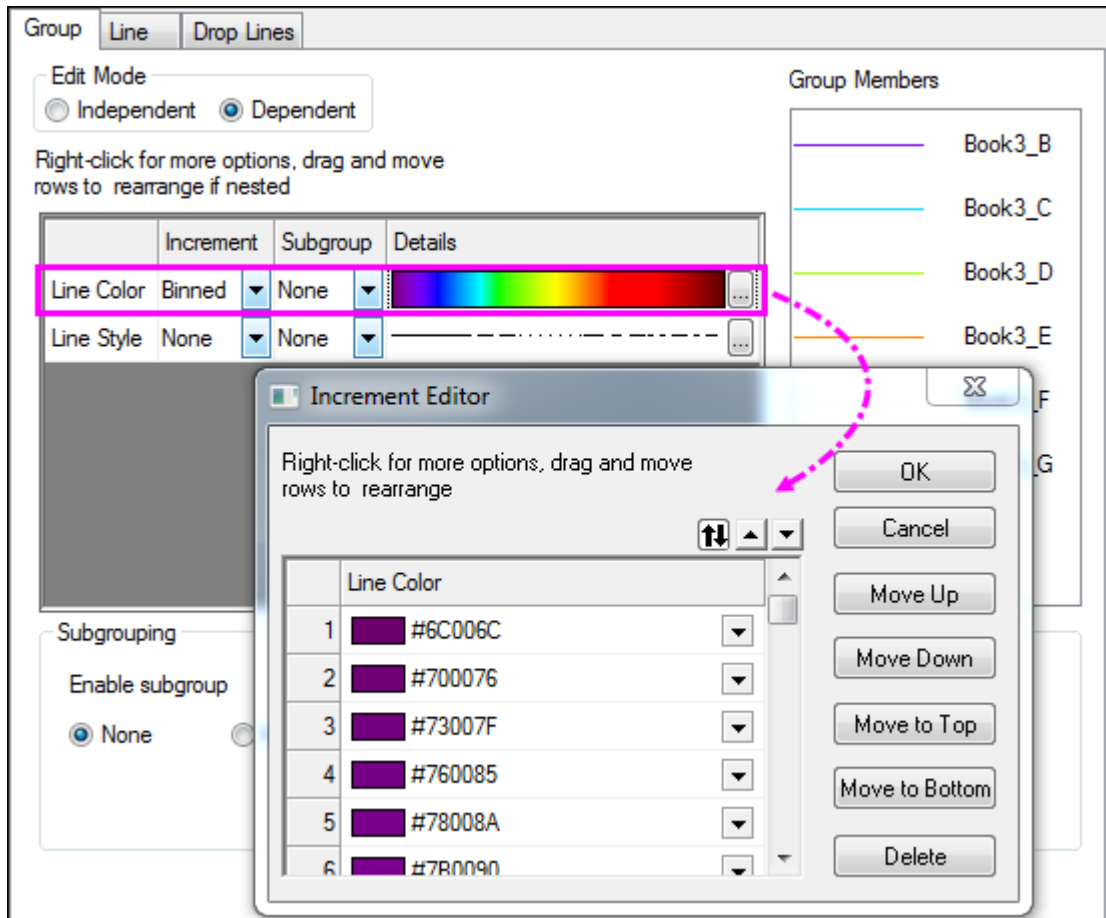

You can find that the **Increment** has been set to **Binned**, so colors are picked from the 256 available in the **Rainbow** palette.

4. We will change the palette to **Reef** by clicking on the browse button to open the **Increment Editor** dialog. Then right-click on the inner portion of this dialog and select **Load Palette : Reef**, then click **OK**. The color list in the **Plot Details** dialog should be set as shown below:

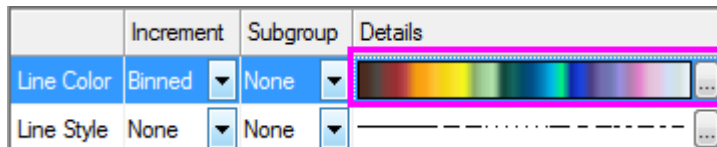

Click on Ok button to close the **Plot Details** dialog. The graph should appear as shown below:

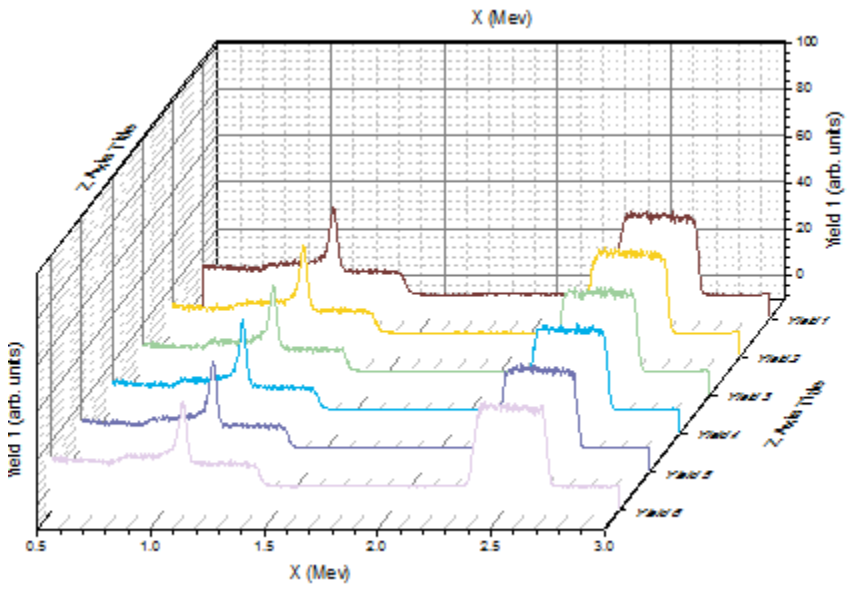

## 6.2.12 Plotting Overlapping Data and Setting Transparency

### 6.2.12.1 Summary

In this tutorial, we will show you how to create overlapping column plots, and then set transparency to make the overlapping parts visible.

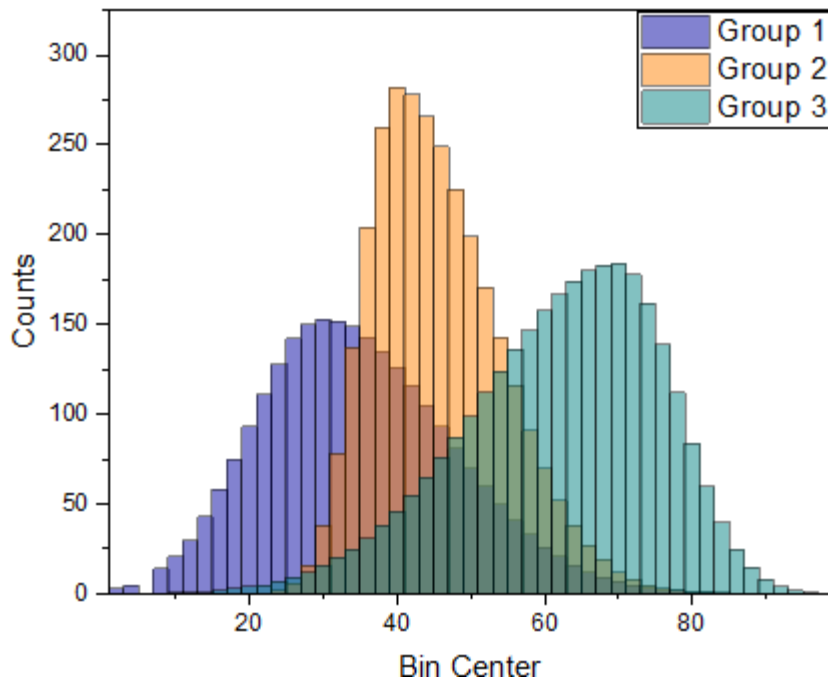

### 6.2.12.2 What you will learn

This tutorial will show you how to:

- Customize the grouped column plots
- Set Transparency

### 6.2.12.3 Steps

1. Select **Help:Learning Center** menu to open **Learning Center** dialog. Select **Graph Sample** item in the left panel and then select **Column and Bar** for **Samples in** drop-down list.
2. Double-click on the last thumbnail to open the folder *Overlapped Bars*.
3. Highlight all columns in the worksheet **[Counts]Sheet1** (The source data *Counts.dat* can also be imported from the folder *<Origin Installation Directory>\Samples\Graphing\*), and then from the menu, select **Plot>Basic 2D: Column** to create a column graph.

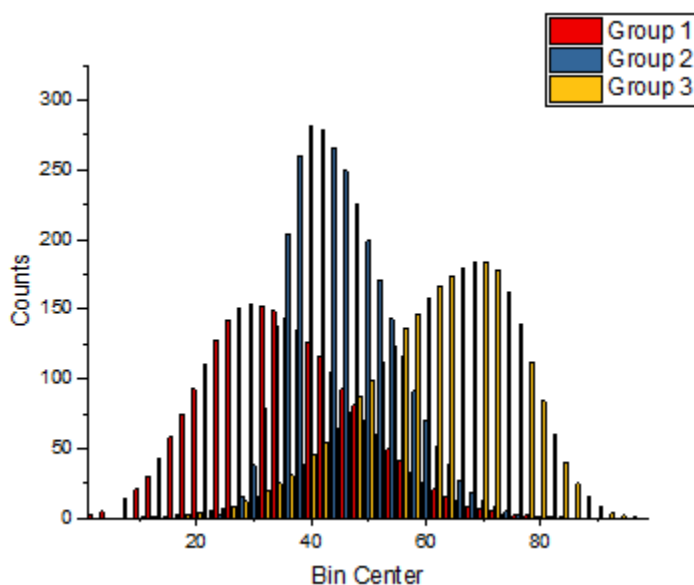

4. Double-click on the plot to open the **Plot Details** dialog. In the dialog, choose the **Group** tab. Click on the color bar under **Details** and click in the **Fill Color** row. Then click on the button that appears to open the **Increment Editor** dialog. In this dialog, you can set the first three colors to be some specific colors such

as Royal Blue, Orange, and Dark Cyan. Click OK to close the dialog.

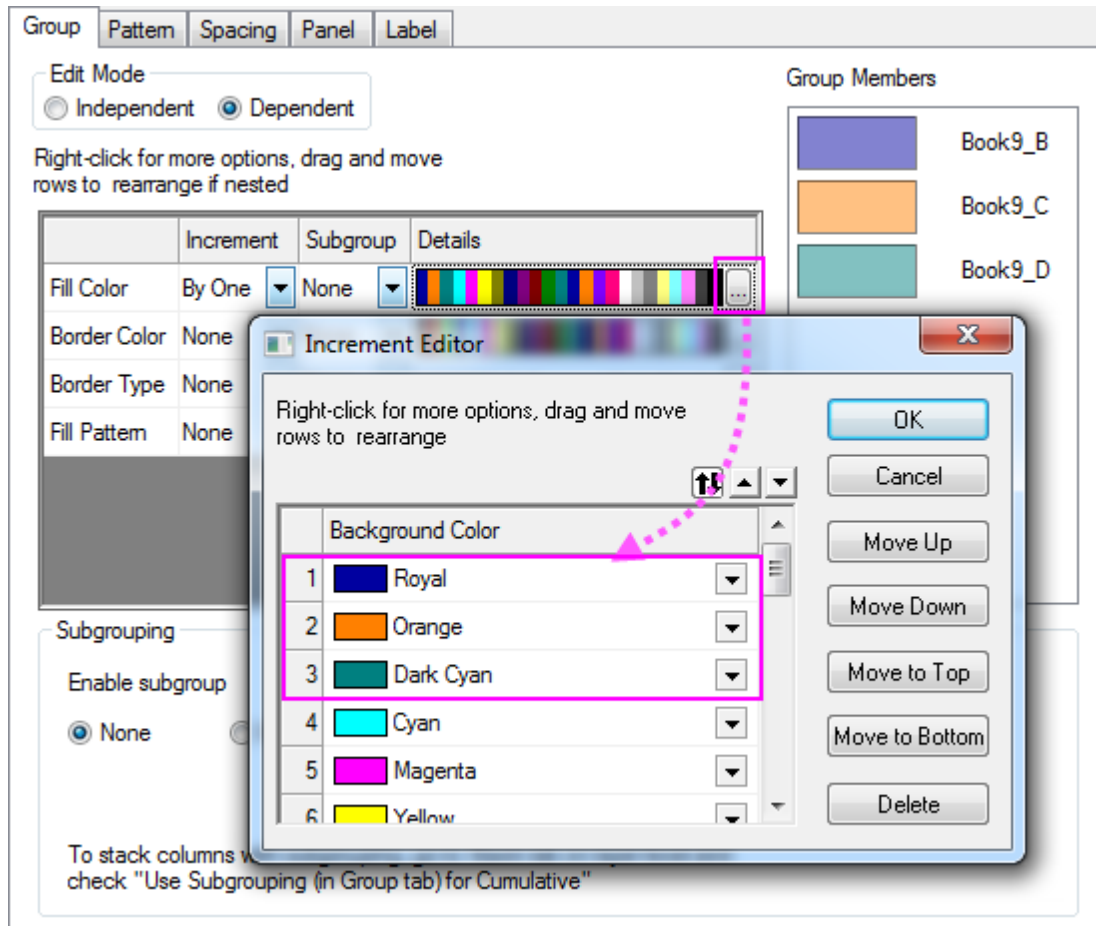

5. Select the **Pattern** tab in Plot Details, and set the **Transparency** control to 51%.

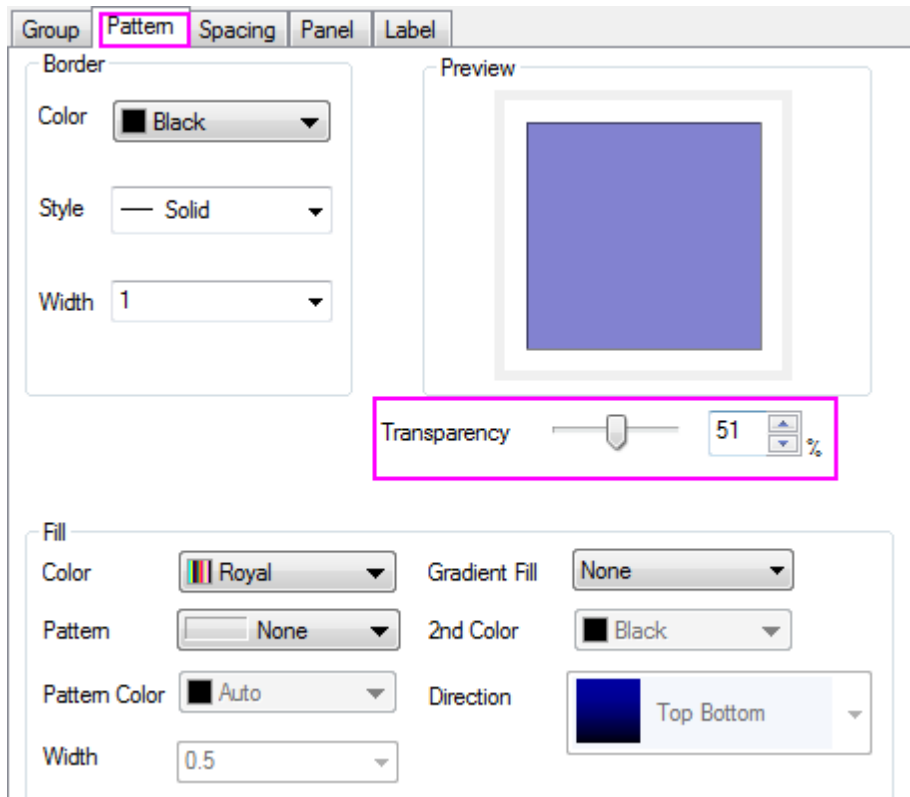

6. Select the **Spacing** tab, and set **Gas Between Bars** to zero and **Overlap** to 100.



- Click the **OK** button to close the Plot Details dialog. Select **View: Show: Frame** to add the frame. The resulting graph should look like the image below:

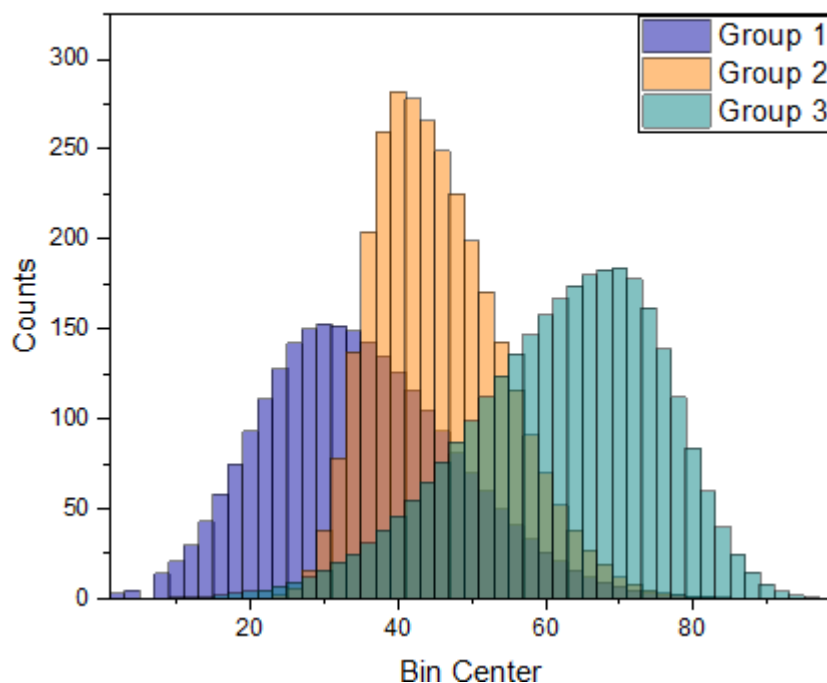

## 6.2.13 Plotting using Plot Setup

### 6.2.13.1 Summary

In this tutorial, we will show you how to implement various plotting tasks including creating graphs, modifying the plot type, adding plots to or removing plots from the graph, grouping or ungrouping plots, and editing the plot range, using *Plot Setup* dialog.

This tutorial will show you how to:

- Create line plot with Plot Setup
- Group or ungroup plots with Plot Setup
- Add or remove plots with Plot Setup
- Change plot type and display range with Plot Setup
- Change plot order with Plot Setup
- Create multi-Panel Plots with Plot Setup

### 6.2.13.2 Create Line Plot with Plot Setup

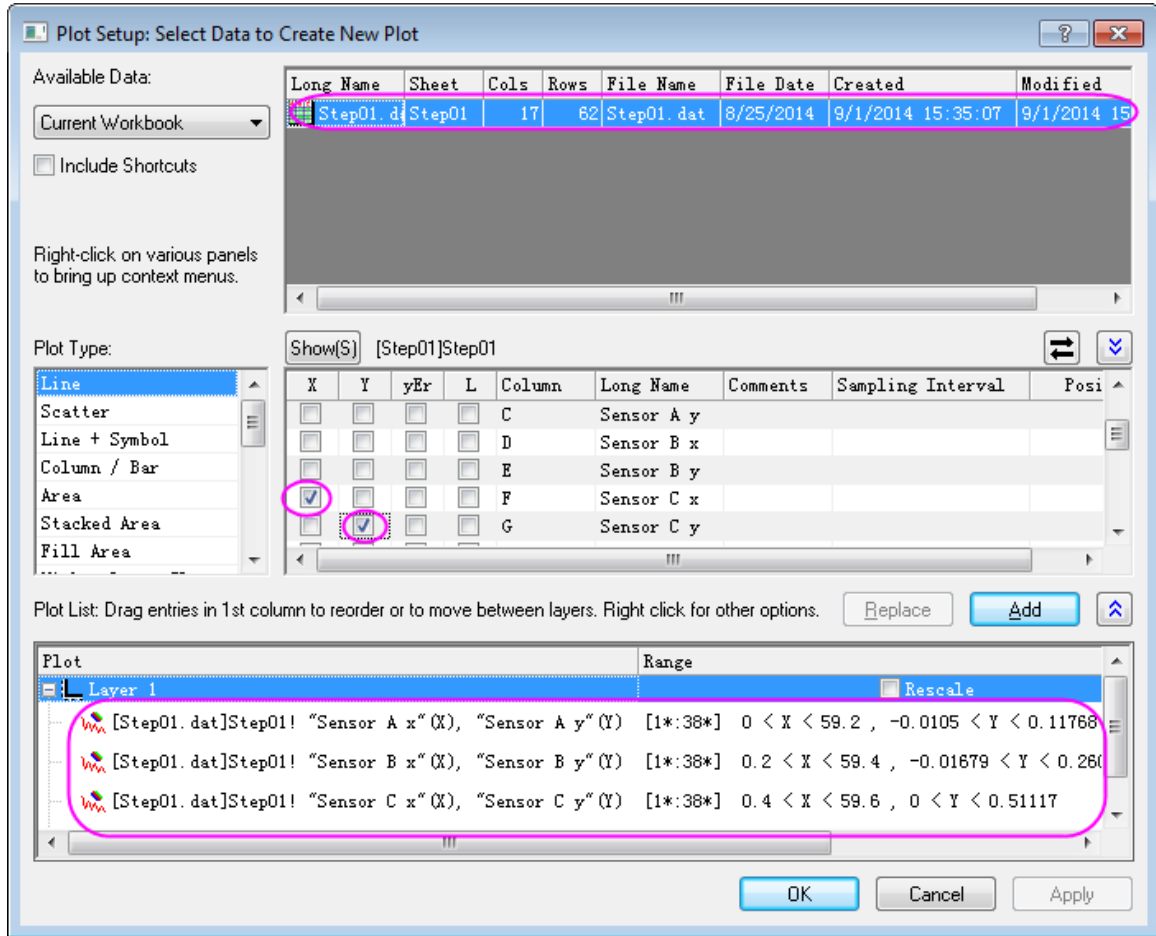

- Start with a an empty worksheet and from the menu, select **Data: Import from File: Single ASCII** or click the **Import Single ASCII** button  to open the file browser.
- Choose the file `<Origin Installation Directory>\Samples\Curve Fitting\Step01.dat`, check the **Show Options Dialog** check box, and click the **Open** button to bring up the **impASC** dialog.

3. Click the **OK** button to import the data into the worksheet.
4. Return to your workbook and ensure that no data is highlighted.
5. Select **Plot > Basic 2D : Line**, the **Plot Setup** Dialog will pop up. In the middle panel, you can see the *Long Name* is displayed by default. Select *Column B (Sensor A x)* as X, and *Column C (Sensor A y)* as Y. Click **Add** to add the plot into the bottom panel, which will automatically be added to *Layer 1*. Repeat this operation for *Sensor B*, and *Sensor C*.



6.



In order to show all three panels in **Plot Setup** dialog, please expand **Plot Type** panel by clicking  and expand **Available Data** panel by clicking  again.

### 6.2.13.3 Group/Ungroup plots with Plot Setup

Next we want to group this three plots together. Use the same graph from the previous example.



1. Press CTRL then select all three plots at the bottom panel, right click and select **Group**. Then these plots would be under the **Group** node.

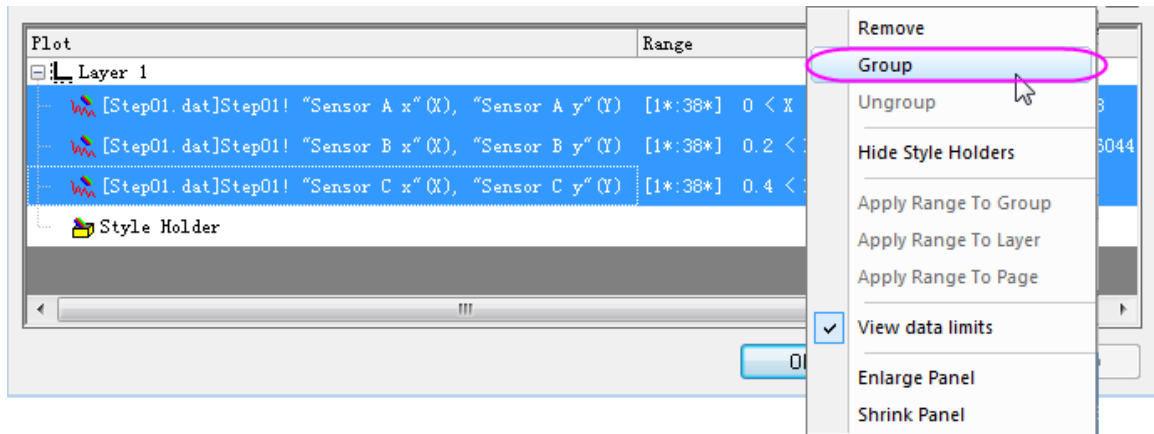

2. Click **OK** to close the dialog. The graph would appear as follow:

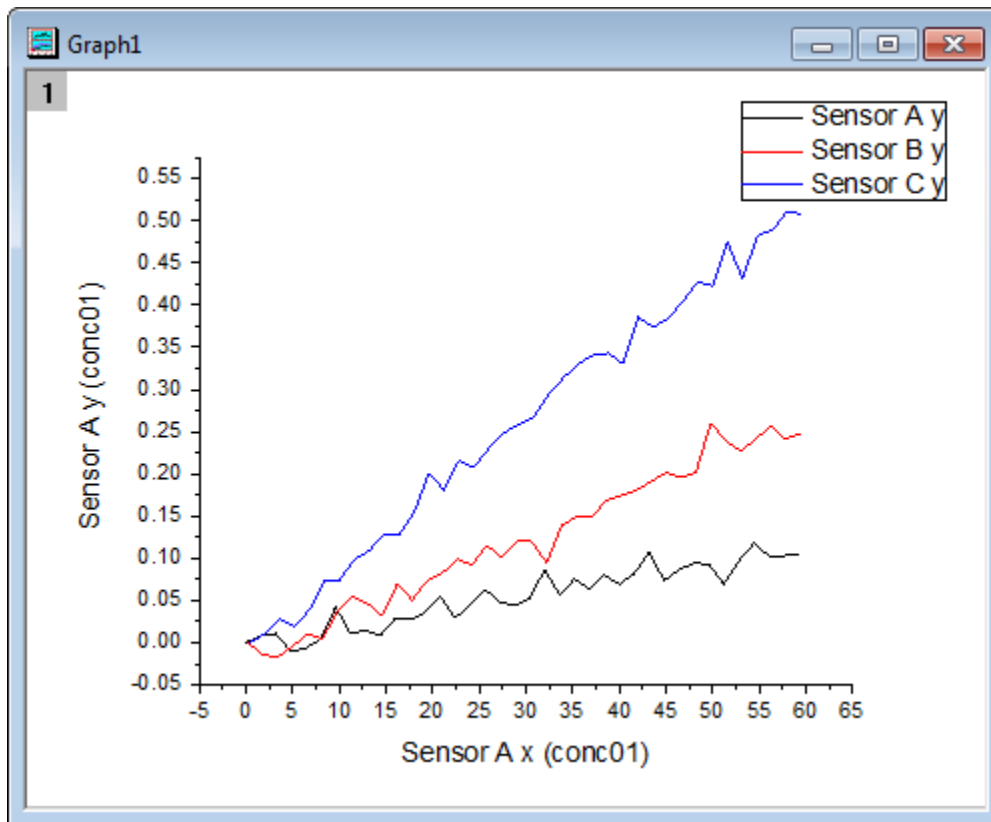

- 3.

**Note:**

1. The plot grouping operation enable you to customize the appearance of these grouped data plots in **Group Tab** of *Plot Details* dialog.
2. To ungroup data plots, you can go back to the bottom panel of *Plot Setup* dialog then click

the **Group** node, right click select **Ungroup**.

#### 6.2.13.4 Add or Remove Plots with Plot Setup

Next we are going to remove the data plot of *Sensor C* then add the data plot of *Sensor D* into the graph. Use the same graph from the previous example.

1. Activate the graph, then click **Graph: Plot Setup** to go back to the **Plot Setup** dialog. At the bottom panel, highlight the plot of *Sensor C*, then right click to select **Remove**. Click Apply then OK to close the dialog. The *Sensor C* plot would be removed from the graph.

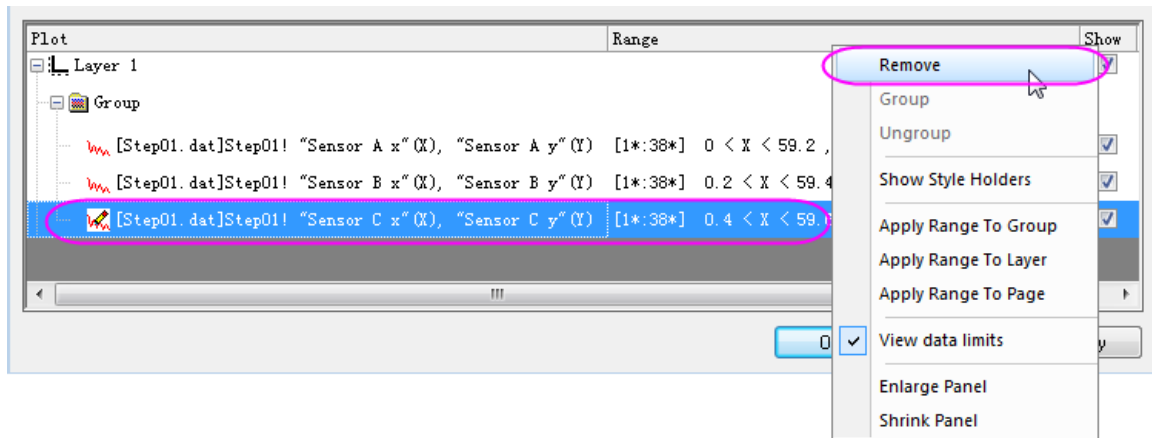

2. To add the data plot of *Sensor D*, select the **Group** node in lower panel and go to the upper panel by clicking on the double up-sided blue arrow icon on top right corner, select *Column H (Sensor D x)* as X, and *Column I (Sensor D y)* as Y. Click **Add**. Click **Apply** then OK to close the dialog.
3. Next we are going to customize the style of the grouped plot. Double click the plot to enter **Plot Details** dialog. At the plot level, select **Line** tab, set **Width** as 3. Click **Apply** then **OK** to close the dialog. The

graph would appear as follow:

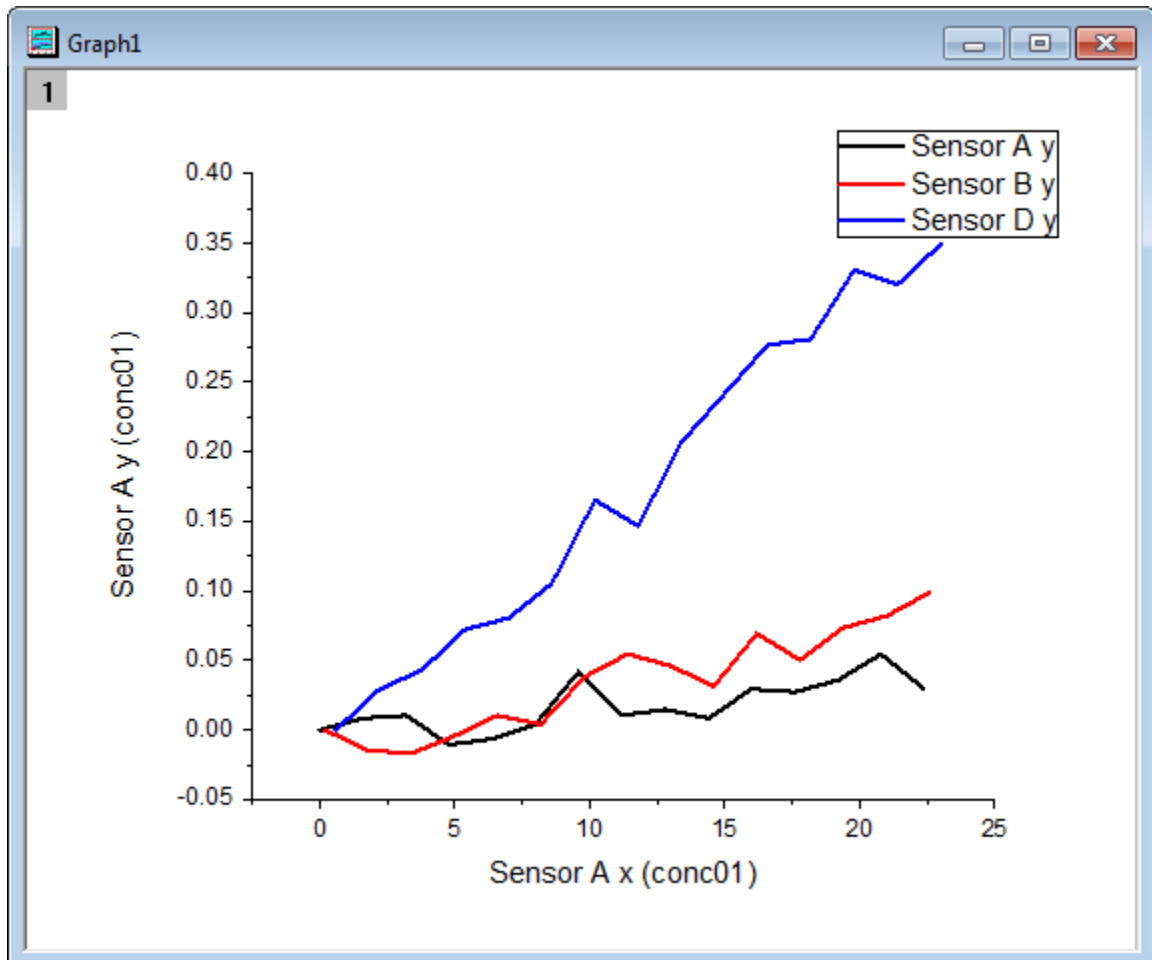

#### 6.2.13.5 Change Plot Display Range with Plot Setup

1. Next we are going to modify the data plot display range.
2. Activate the graph, then click **Graph: Plot Setup** to go back to the **Plot Setup** dialog. Select the data plot of *Sensor A* in the bottom panel. Click the cell of *Range* column, a rectangle button would appear at the end of the cell.

- Click this button. The **Range** dialog would pop up. Uncheck the **Auto** of **From** and **To**. Then Customize it as **From 1 To 15** and click **OK** to close the dialog.

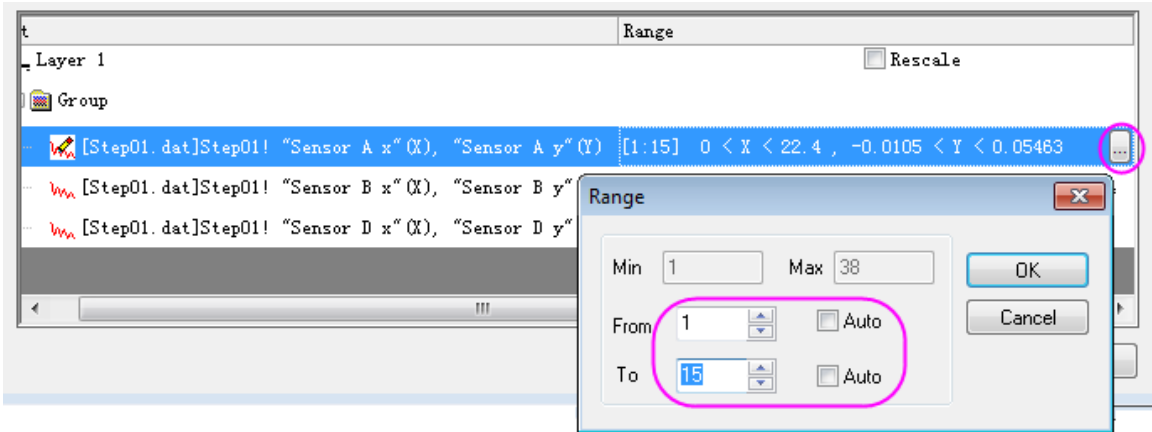

- To apply this display range for other plots, right click the the data plot of *Sensor A* again and select **Apply Range To Group**.
- To rescale the plot, click the checkbox of **Rescale** on the Layer 1 row of the Range Column. Click **Apply** then **OK** to close the dialog.

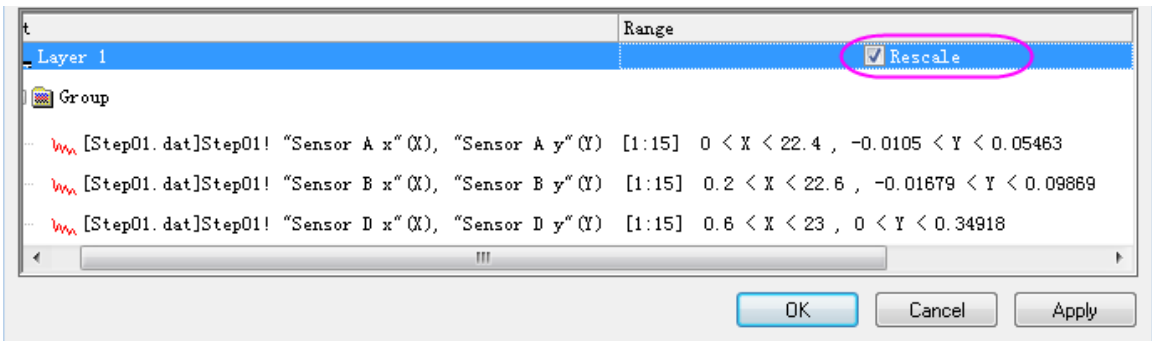

### 6.2.13.6 Change Plot Order with Plot Setup

Next we want to change the plot order of these three plots. Use the same graph from the previous example.

- Activate the graph, then click **Graph: Plot Setup** back to the **Plot Setup** dialog.
- At the bottom panel, keep pressing the mouse on the plot of *Sensor B* then drag the plot above *Sensor A*.

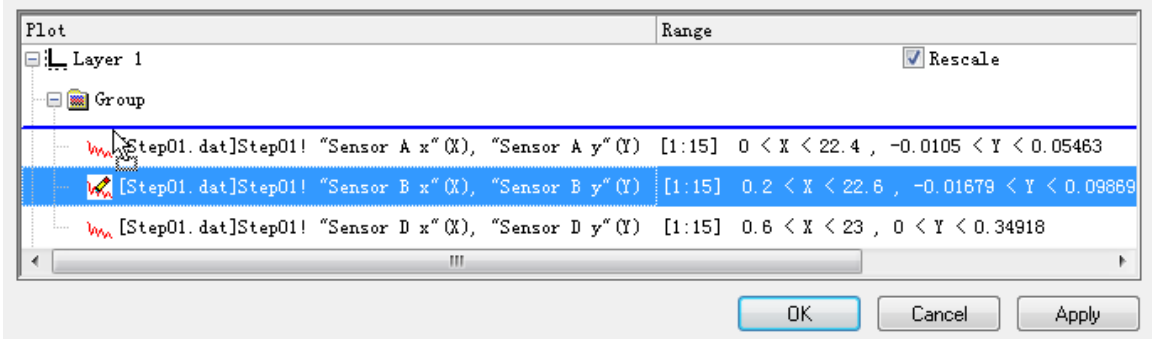

- Click **Apply** then **OK** to close the dialog. The graph would appear as follow. You can see that the data plot of *Sensor A* is on top of that of *Sensor B*.

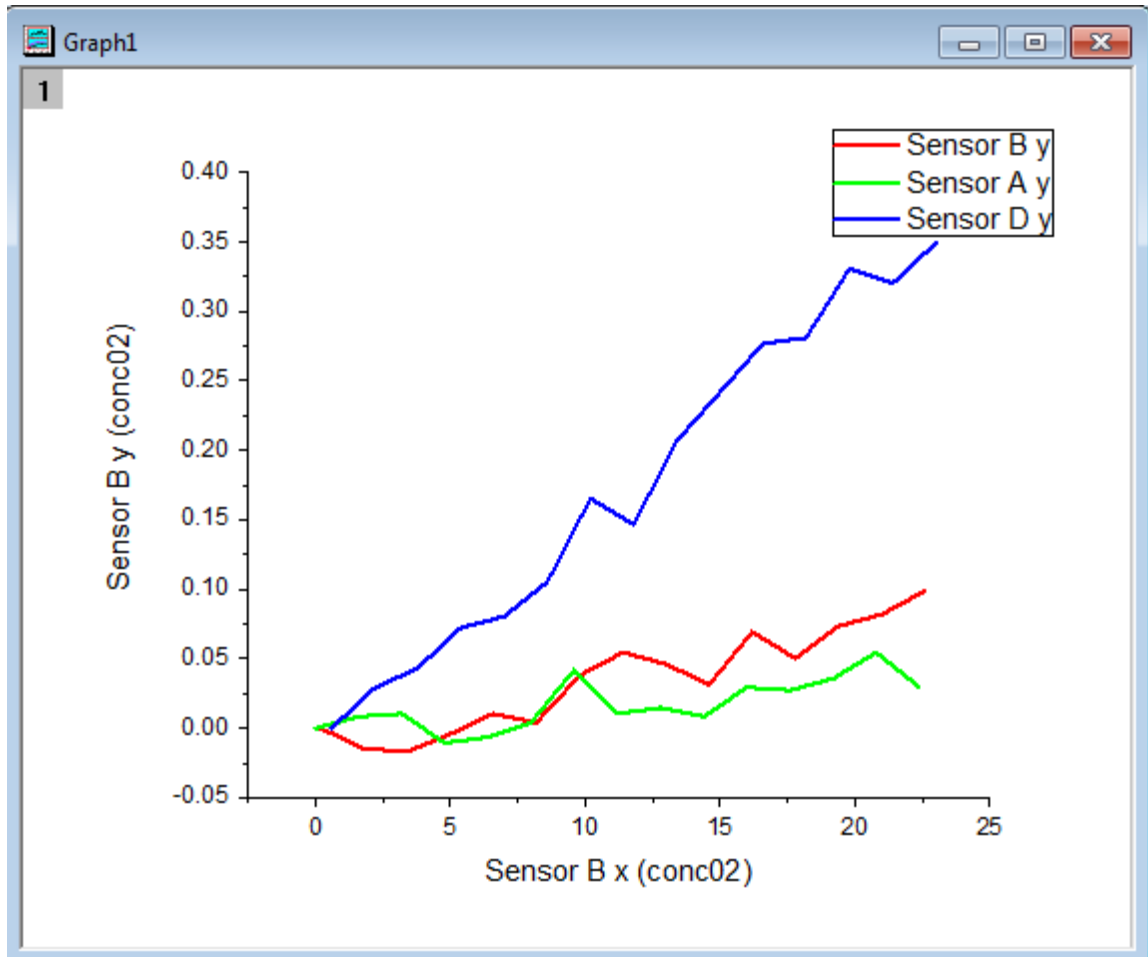

#### 6.2.13.7 Change Plot Type with Plot Setup

Next we want to change these three line plots into scatter plots and modify the data plot range. Use the same graph from the previous example.

- Activate the graph, right click at the Layer index icon **1** on the graph upper left corner, then select **Plot Setup** to go back to the **Plot Setup** dialog.
- Select the data plot of *Sensor B* in the bottom panel, then select **Scatter** in the **Plot Type** panel. Click **Replace** to replace the original line plot. Other plots in the same group will automatically be replaced by

scatter plot. Click OK to close the dialog.

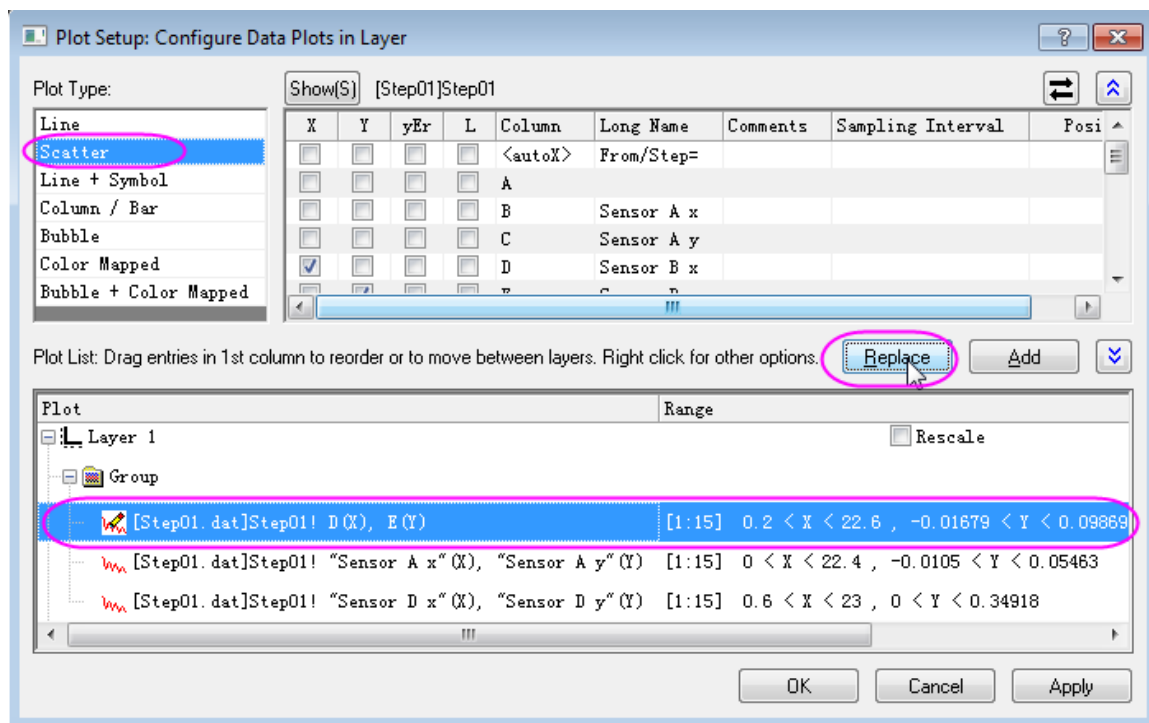

### 6.2.13.8 Create Multi-Panel Plot with Plot Setup

Multi-Panel plot with several plots in each layer can be created conveniently using *Plot Setup* dialog.

1. Create a new project, start with a an empty worksheet and from the menu, select **Data: Import from File: Multiple ASCII** or click the **Import Multiple ASCII** button  to open the file browser.
2. Press CTRL and choose the file *Step01.dat*, *Step02.dat*, *Step03.dat*, and *Step04.dat* from the folder *<Origin Installation Directory>\Samples\Curve Fitting\...* Click **Add File(s)**. Check the **Show Options Dialog** check box, and click **OK** to bring up the **impASC** dialog.
3. Under *Import Options*, set **Import Mode** as **Start New Books**. Accept other default settings and click **OK** to close the dialog. Four workbooks *Step01.dat*, *Step02.dat*, *Step03.dat*, and *Step04.dat* will be created.
4. Do not activate any workbook and click **Plot > Basic 2D: 4 Panel** to go to the **Plot Setup** dialog.
5. Click the double up-sided blue arrow icon on top right corner to open top panel, then select **Worksheets in Project in Available Data** drop-down list. All four workbooks would appear in the upper panel.
6. Use Ctrl key to select all four workbooks in the upper panel, then select *Column B (Sensor A x)* as X, and *Column C (Sensor A y)* as Y in the middle panel.

7. Select **Plot Type** as **Line** and select *Layer1* in their bottom panel. Click **Add**. All data plots of *Sensor A* in these four workbooks would be added to *Layer1*.

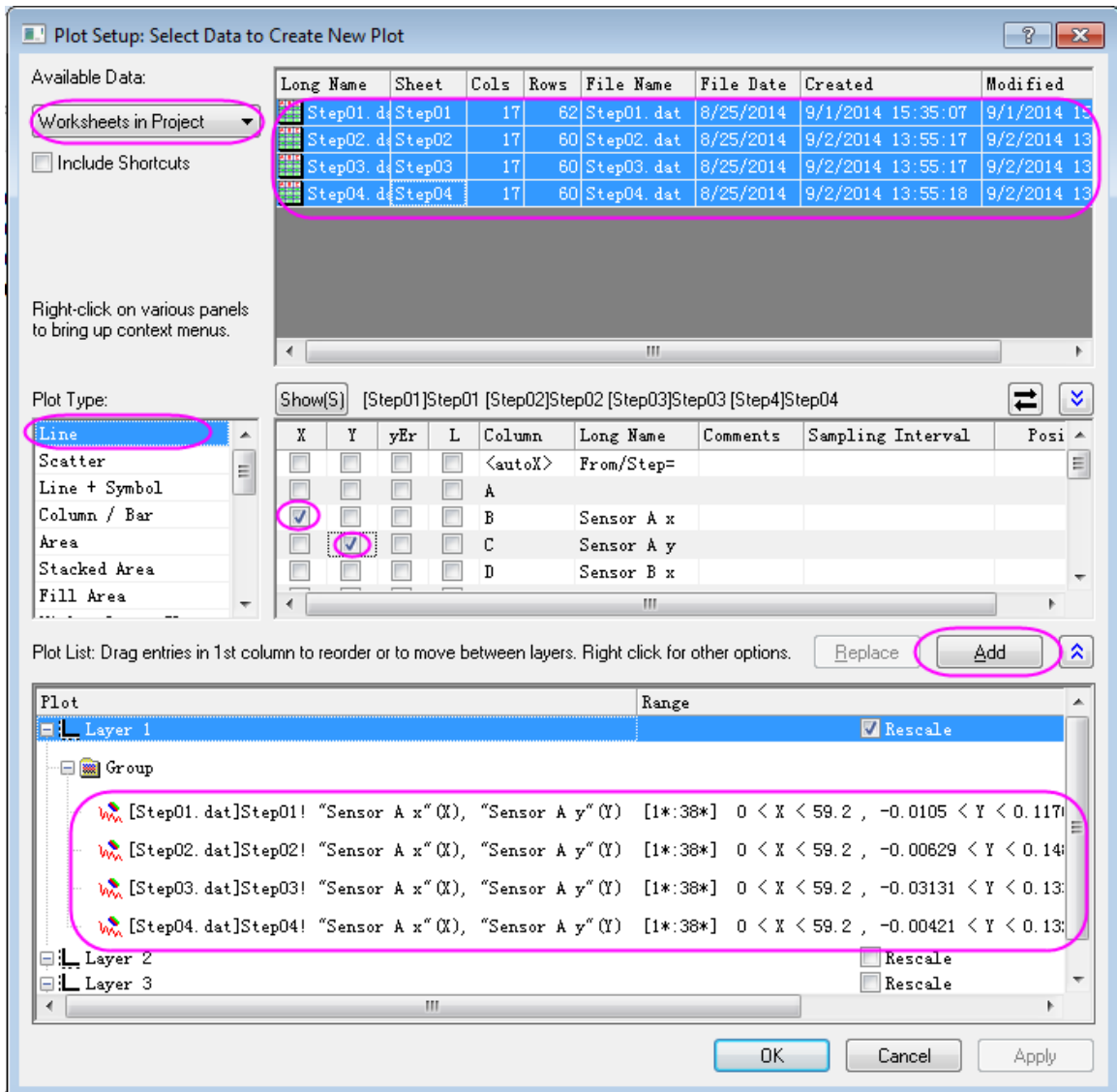

8. Repeat the previous step to add *Sensor B*, *Sensor C*, and *Sensor D* to *Layer2*, *Layer3*, and *Layer4* respectively. Click **OK** to close the dialog. The graph would appear as follow:

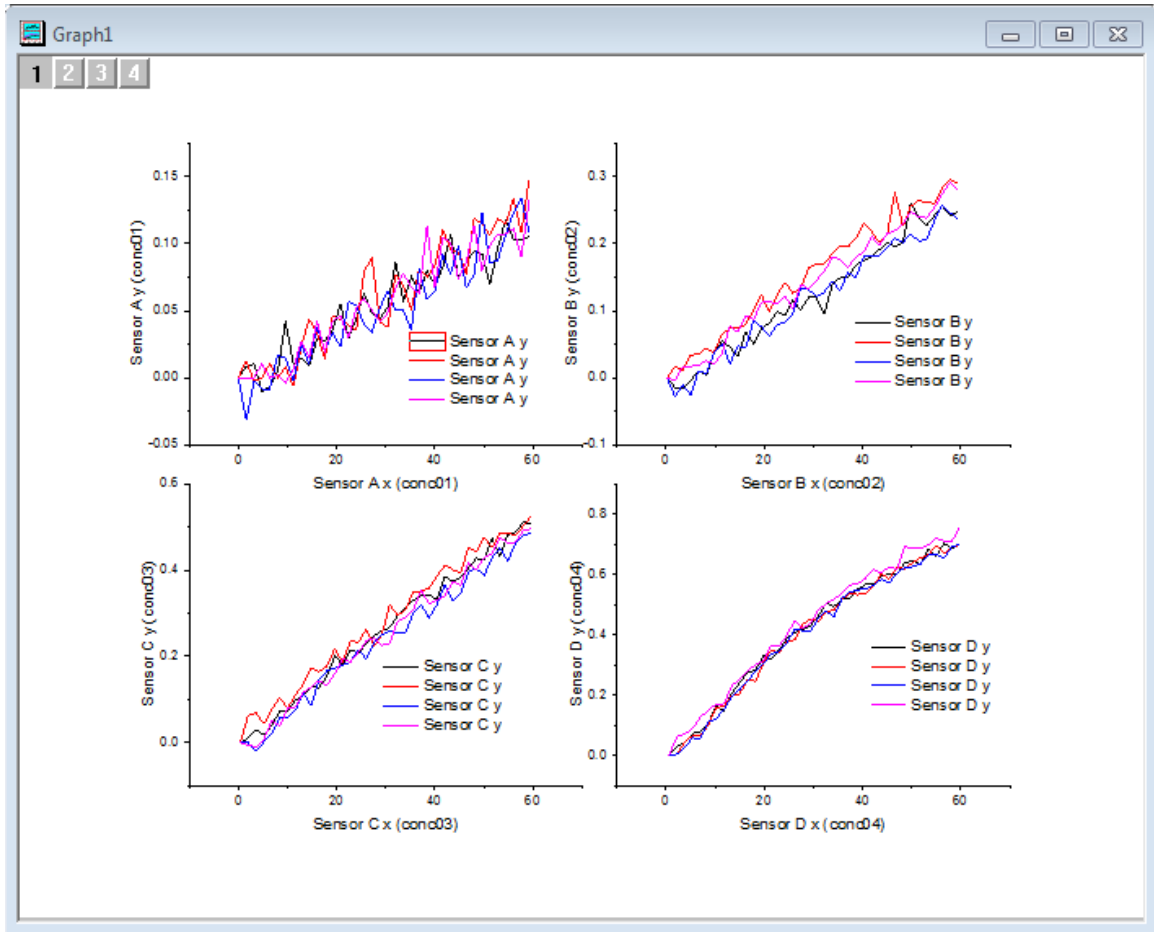

## 6.3 Axis

### 6.3.1 Axis

- [Multiple Axis Breaks](#)
- [User-Defined Arbitrary Tick Positions](#)
- [Plot and Customize Date Time Data on Graph](#)

### 6.3.2 Multiple Axis Breaks

#### 6.3.2.1 Summary



Origin supports multiple breaks on an axis as shown below. The number of breaks and the break positions can be customized in the **Axis** dialog box. Furthermore, you can add recession bars( the "vertical bars" shown as below) by adding multiple reference lines on the X axis and fill the gaps between them.

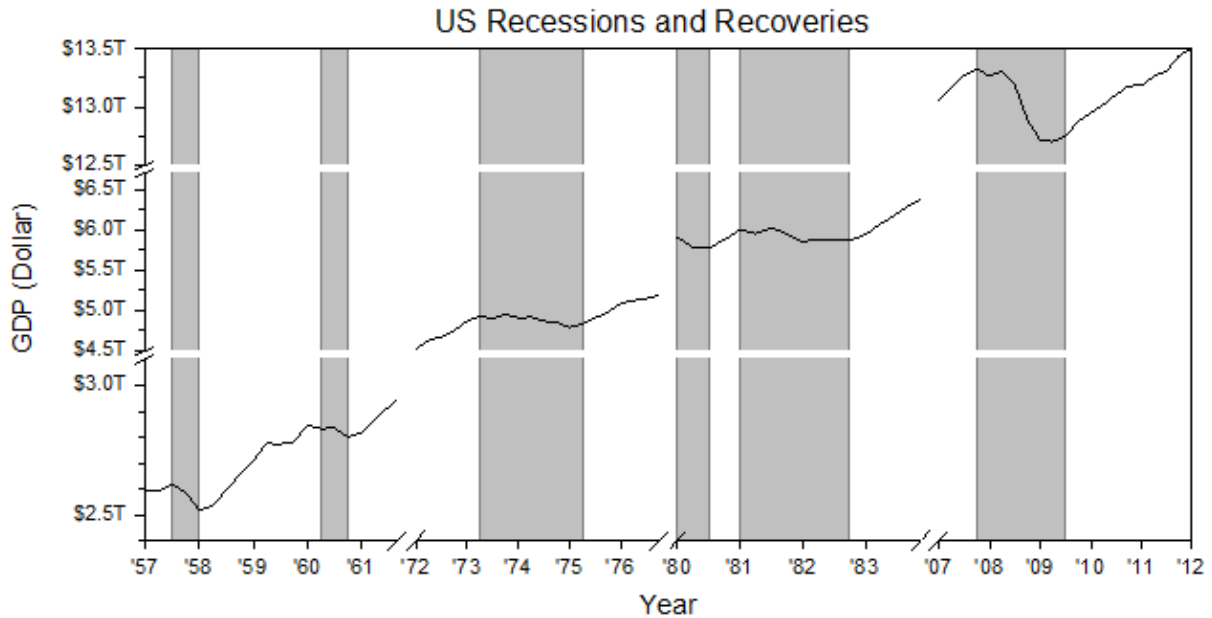

Minimum Origin Version Required: 2017 SR0

#### 6.3.2.2 What you will learn

This tutorial will show you how to:

- Add multiple breaks to both X and Y axes
- Customize axis tick label format
- Fill spans that are broken by missing values vertically

#### 6.3.2.3 Steps to Customize Label Display and Add Axis Breaks

This tutorial is associated with the *Multiple Axis Breaks* folder of the sample project <Origin EXE Folder>\Samples\TutorialData.opj.

Also, you can see this graph in **Learning Center**(Select *Help: Learning Center* menu or press **F11** key). It is listed under the **Line and Symbol** sample graph table. Double-clicking on the thumbnail will open the target folder.

1. Activate the workbook. Highlight Col(A) and Col(B) and select **Plot > Basic 2D: Line** from the main menu to plot a line graph. Select and delete the legend.
2. To customize the graph axes double click on an axis to open the Axis dialog box. Click the **Horizontal** icon in **Scale** tab and set the X axis scale as graph below:

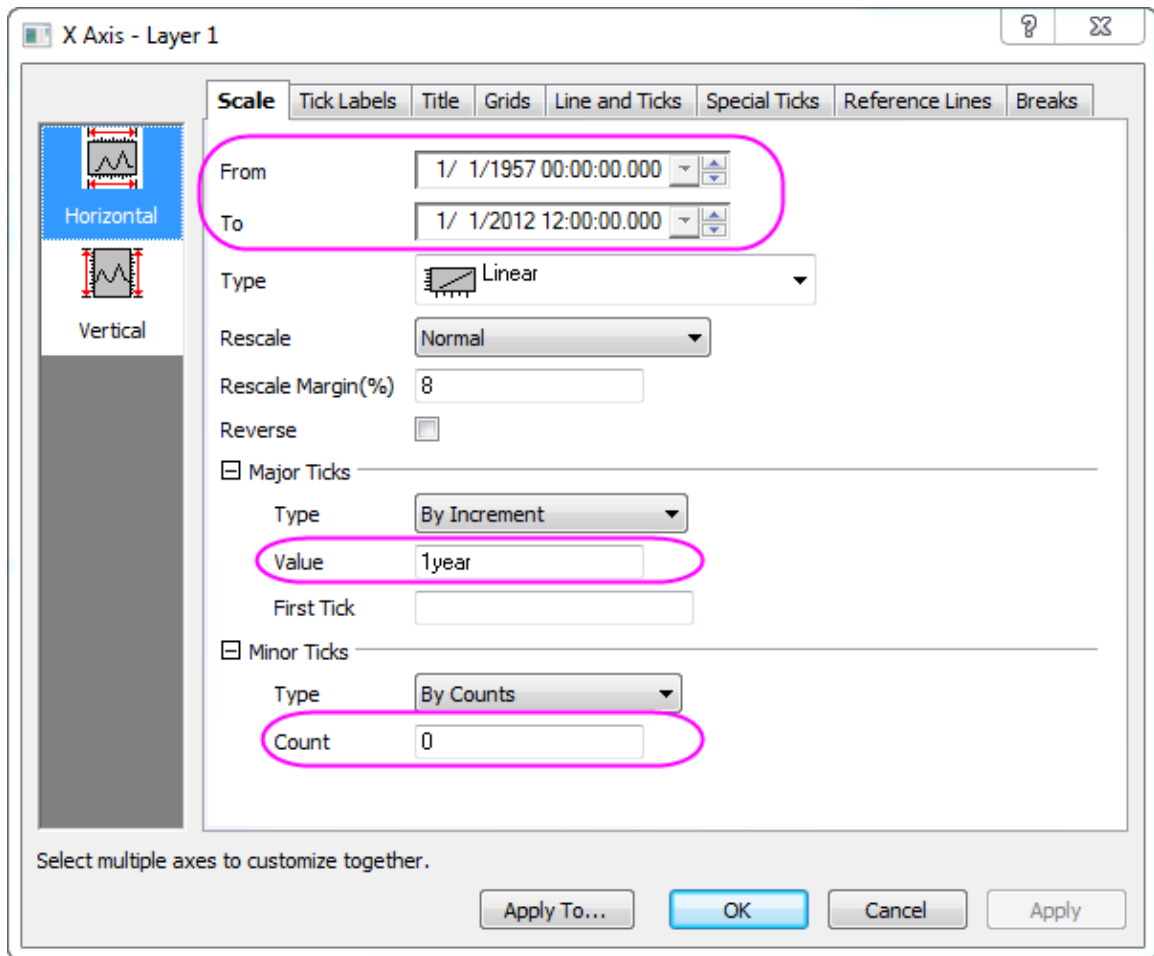

3. Go to **Bottom** icon in **Tick Labels** tab, change the display format of tick labels to 16(means year as yy) and add a prefix '.

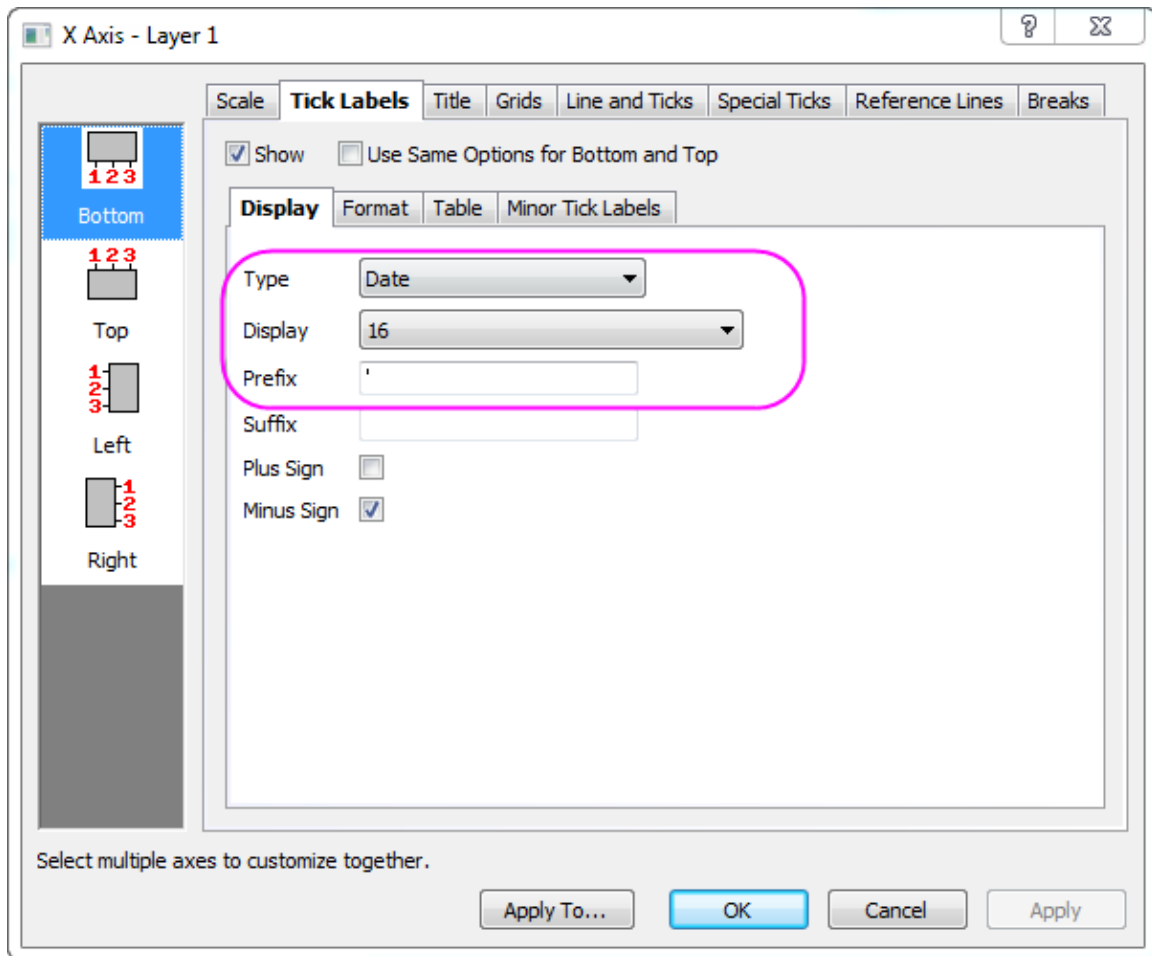

4. In order to add several breaks to the X axis select the **Horizontal** icon in **Breaks** tab . Check the **Enable** box and set 3 axis breaks.

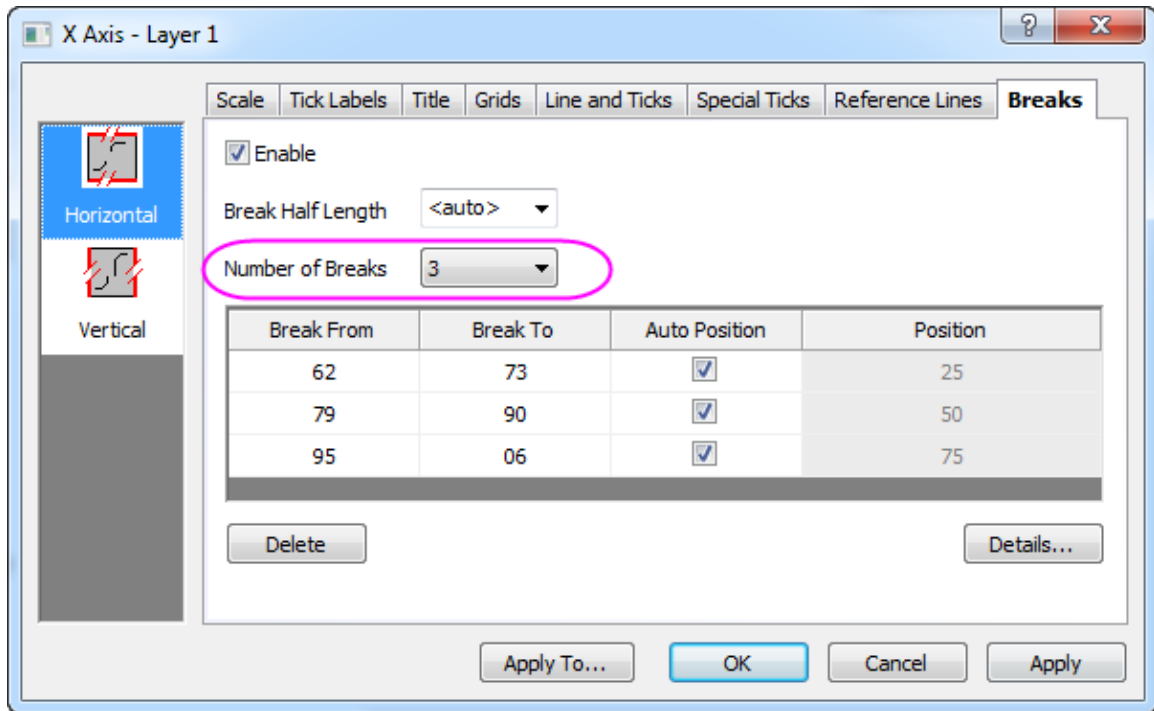

- Click the **Details...** button to open the **Breaks Details** dialog, set **Break1** from **12/1/1961** to **9/1/1972**:

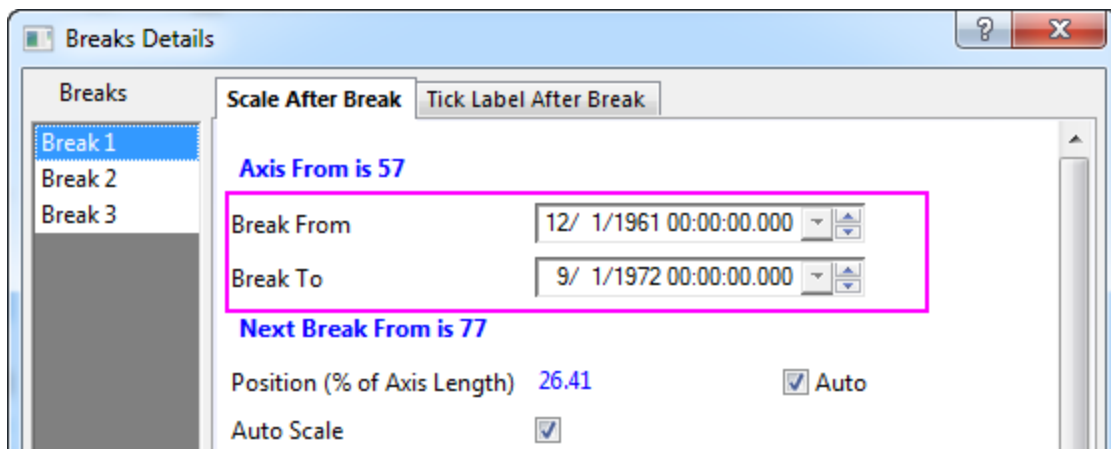

- Select the **Break 2** node in the left panel, change it to be from **3/31/1977** to **8/29/1980**. Switch to **Break 3** node, change it to be from **7/27/1984** to **3/1/2007**. Click the **OK** button to apply and exit the **Break Details** dialog and in the **Axis** dialog, click the **Apply** button to view the changes.
- To customize the Y axis, select the **Left** icon under the **Tick Labels** tab and use the format **Engineering:1k** as the tick label display. Set the prefix as "\$". Click **Apply** to view the changes in the graph.

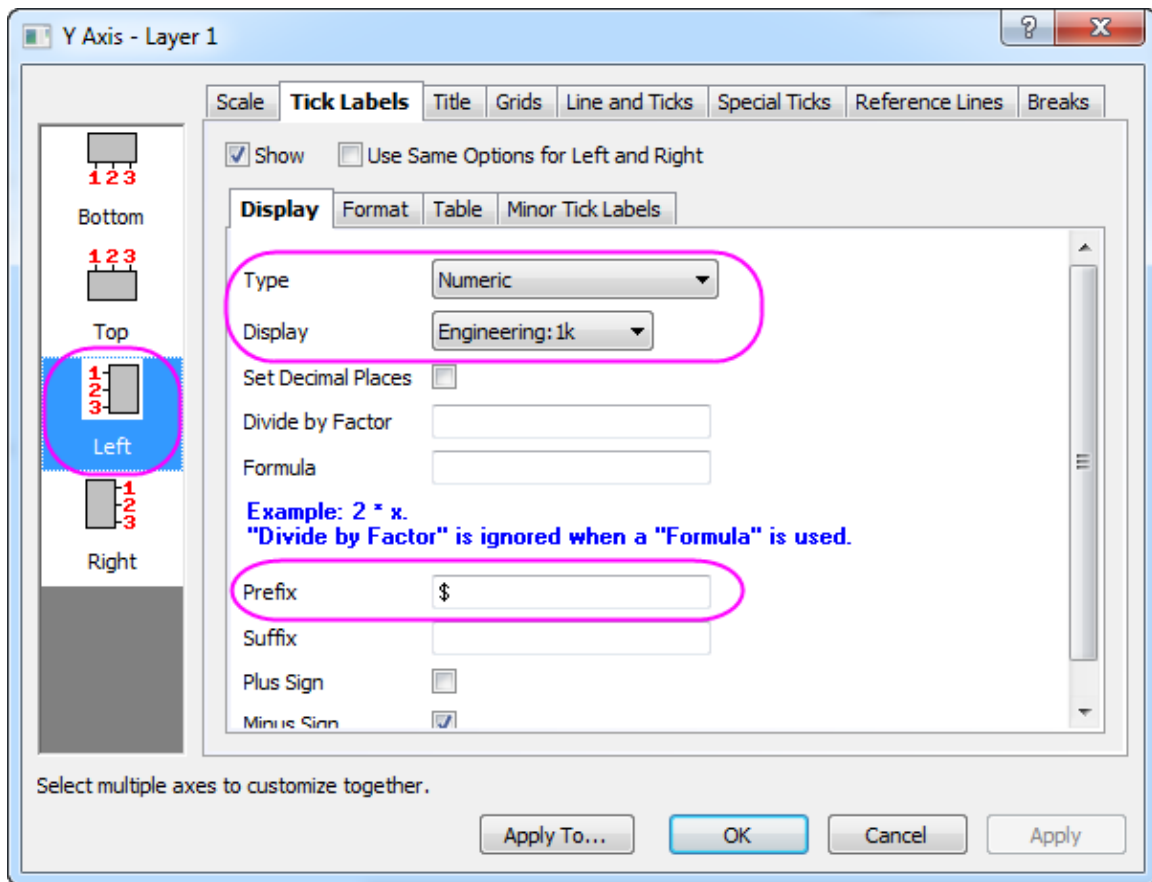

8. Go to the **Breaks** tab again and with the **Vertical** tab selected, enable 2 axis breaks at scale value **3.1 T** to **4.5T** and **6.7T** to **12.5T**, as we had done for the X axis in Step 4 to 6.
9. Click **OK** to apply the settings and get the graph similar as follows:

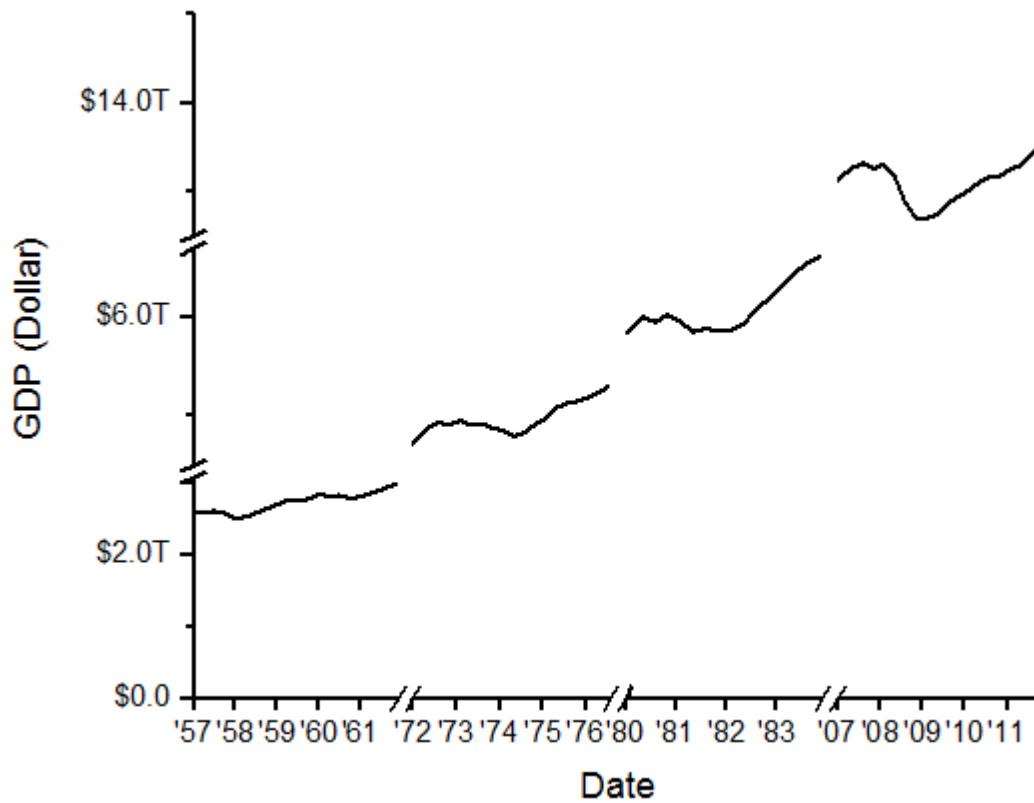

6.3.2.4 Steps to Add Recession Bars

1. Double-click on X axis to open the Axis dialog. Go to **Reference Lines** tab, click the interactive button  beside the **Reference Lines at Value** text box to select col(C) from worksheet. The x coordinates of all recession periods will be listed in the display table as reference lines. Then check **Alternate Fill** box to fill each period.

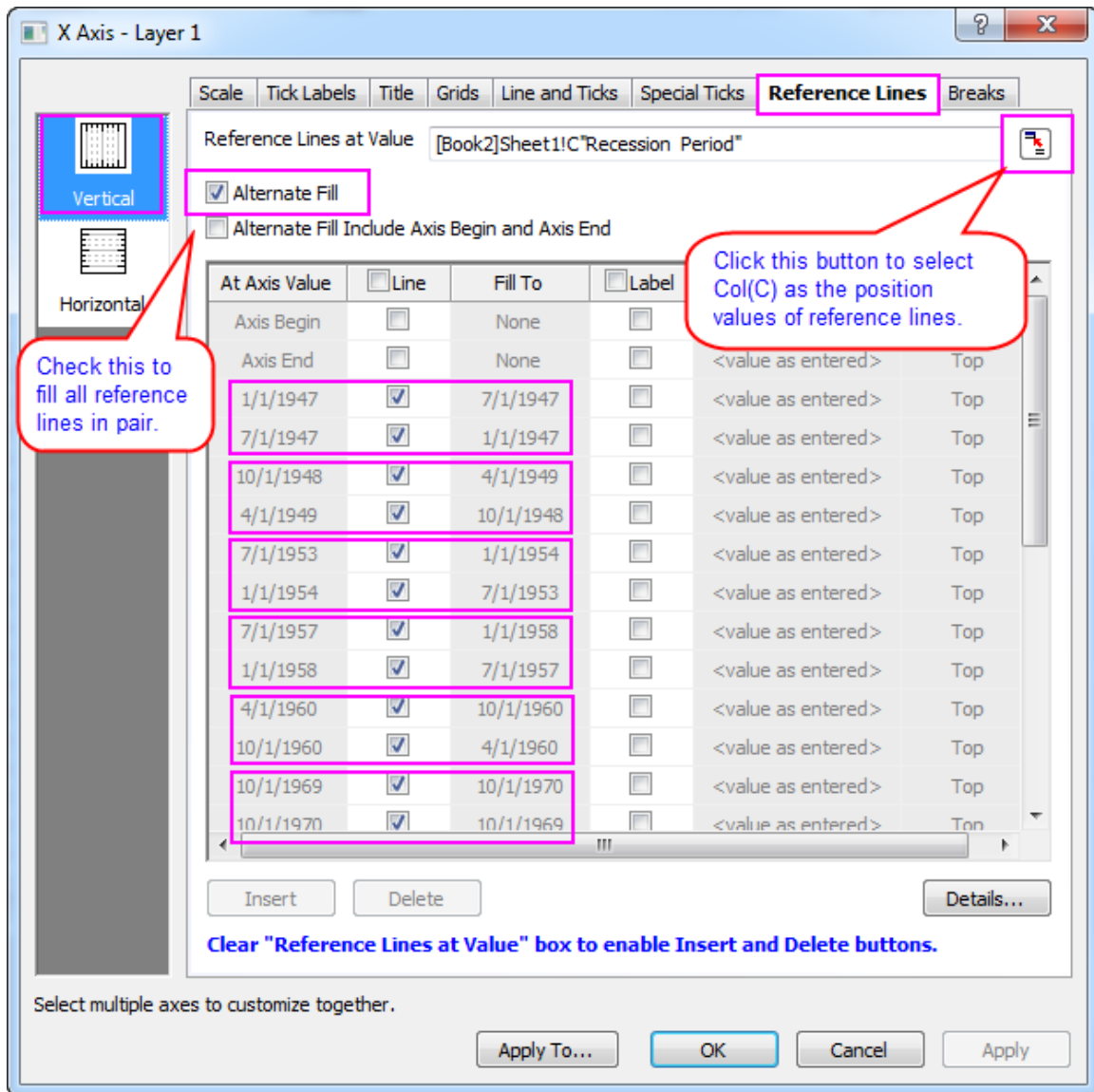

2. Click **OK** to apply the settings.

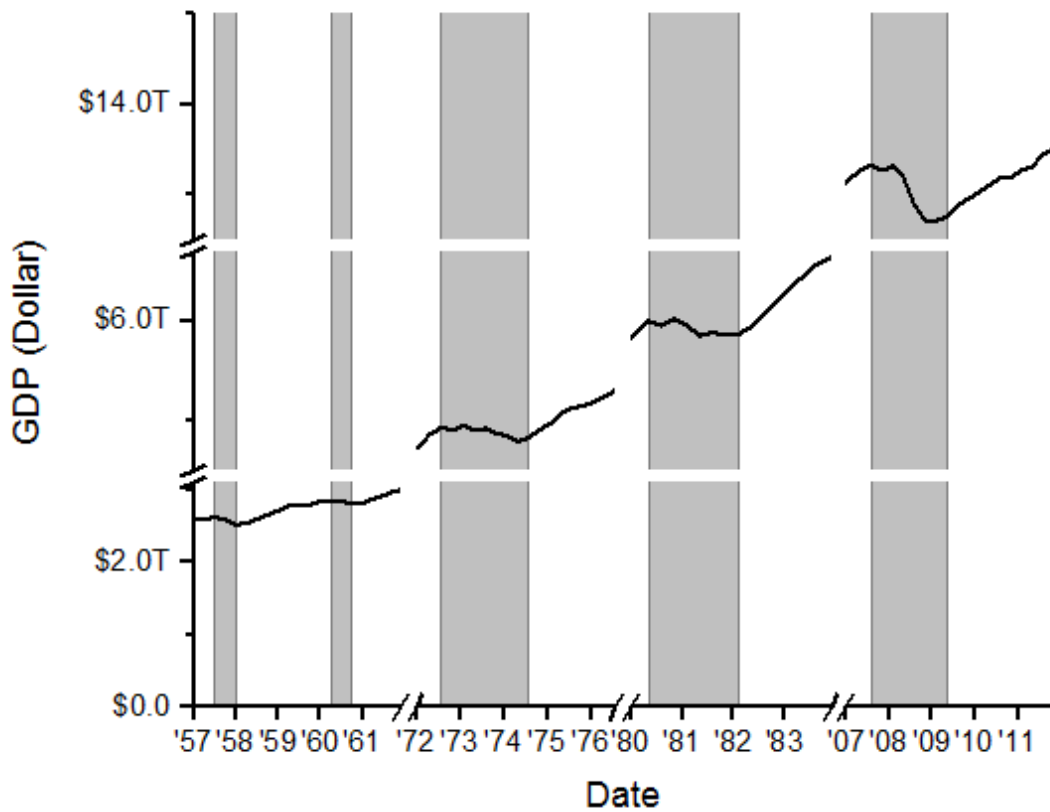

#### 6.3.2.5 More Customization Steps

The following steps can further customize the graph to be exactly the same as the image in Summary.

1. Double click X axis title **Date** in the graph and rename it as **Year**.
2. To change Y axis range, double click on Y axis to open the **Axis** dialog. Go to the **Scale** tab with **Vertical** icon selected, set From, To, Major and Minor ticks as below.



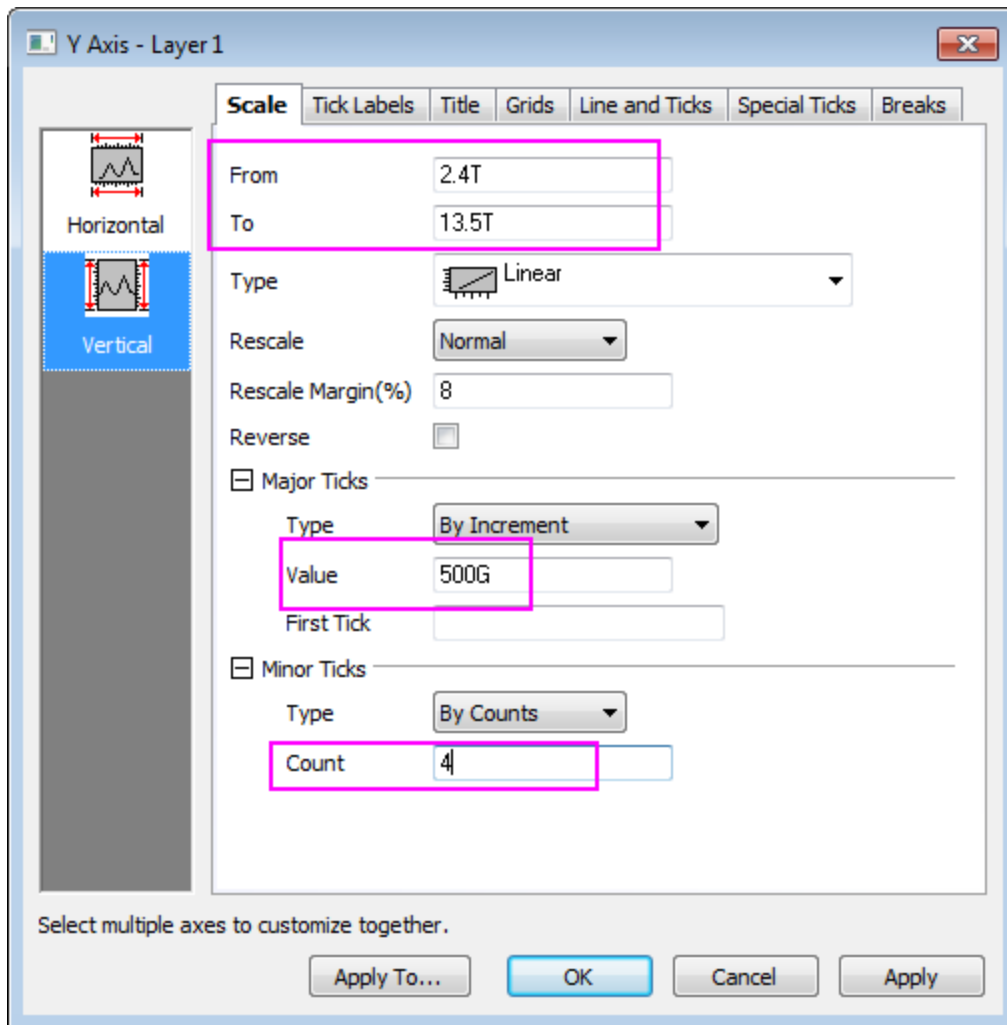

- Go to the **Breaks** tab again, select the first axis break and click **Details** to open the **Break Details** dialog with the **Break 1** node selected. Clear the **Auto** check box next to the break position option and change it to **38%**. Clear the **Auto Scale** check box and then change the tick settings as below:

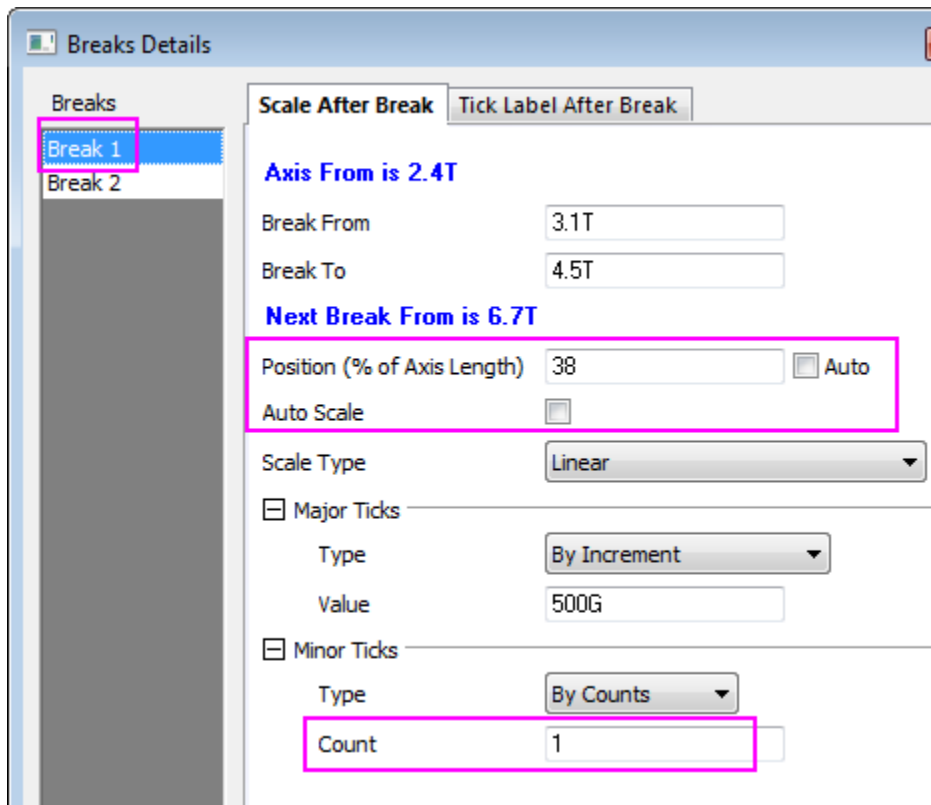

4. Select **Break 2** node, set break position, Major Ticks and minor ticks as below:

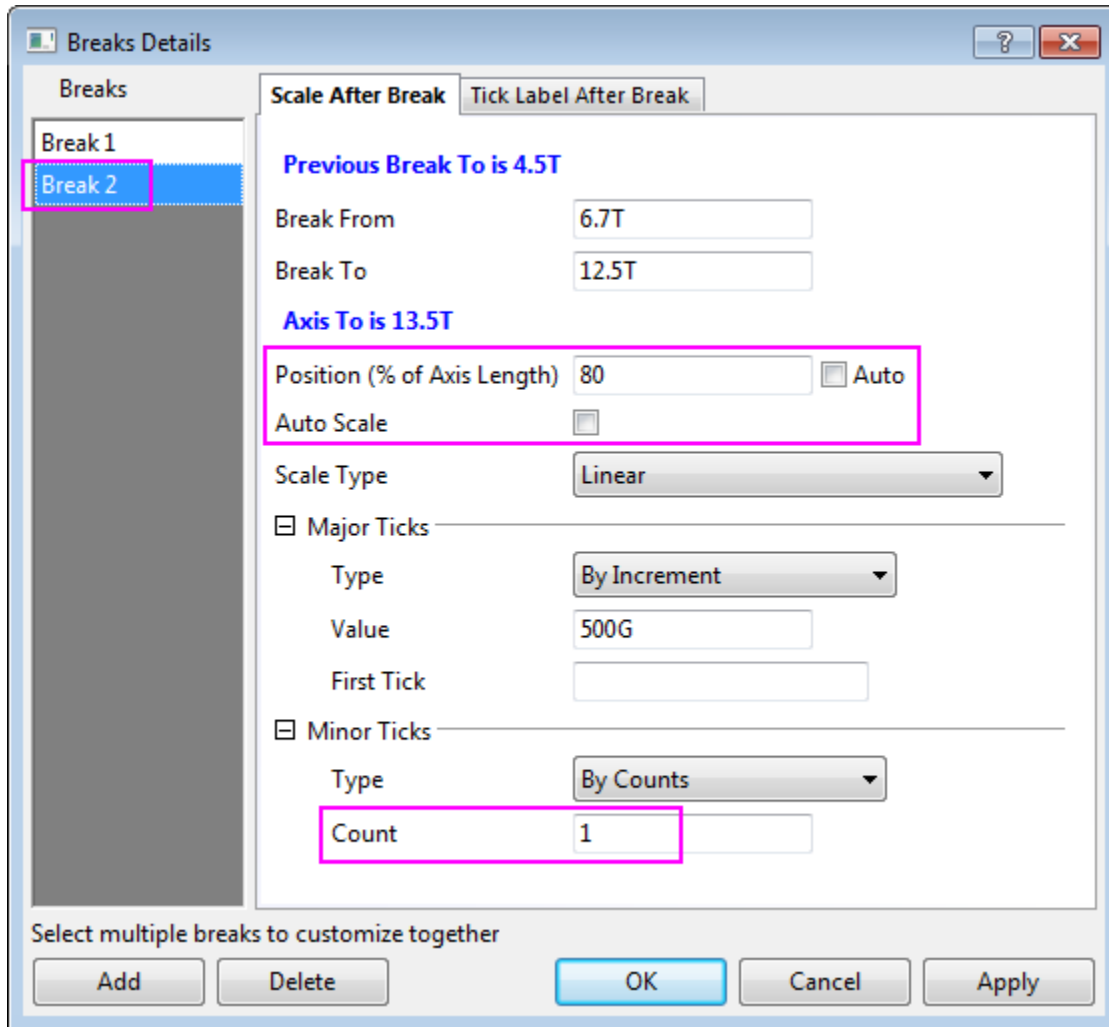

5. Click **OK** to apply and exit the **Breaks Details** dialog. Click **Apply** in the **Axis** dialog to apply settings.
6. Select **Grids** tab. Select both **Vertical** and **Horizontal** icons on the left panel, check **Opposite** to show a frame around top and right axes.
7. Right click in a blank area inside graph layer 1 and select **Add/Modify Layer Title** from the context menu. Enter *US Recessions and Recoveries* as the layer title.
8. Adjust the page dimension with Graph node selected in **Plot Details** dialog.

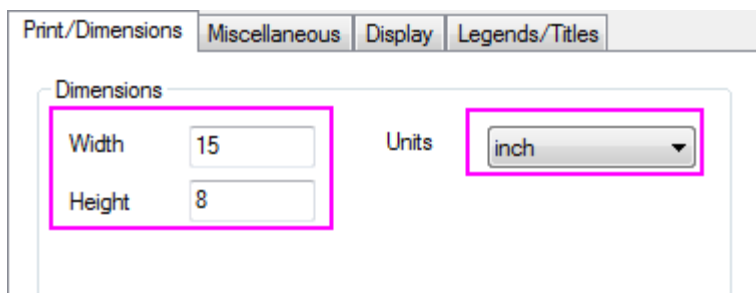

### 6.3.3 User-Defined Arbitrary Tick Positions

#### 6.3.3.1 Summary

This graph will show you how to specify tick locations using a dataset and show customized tick labels at those locations.

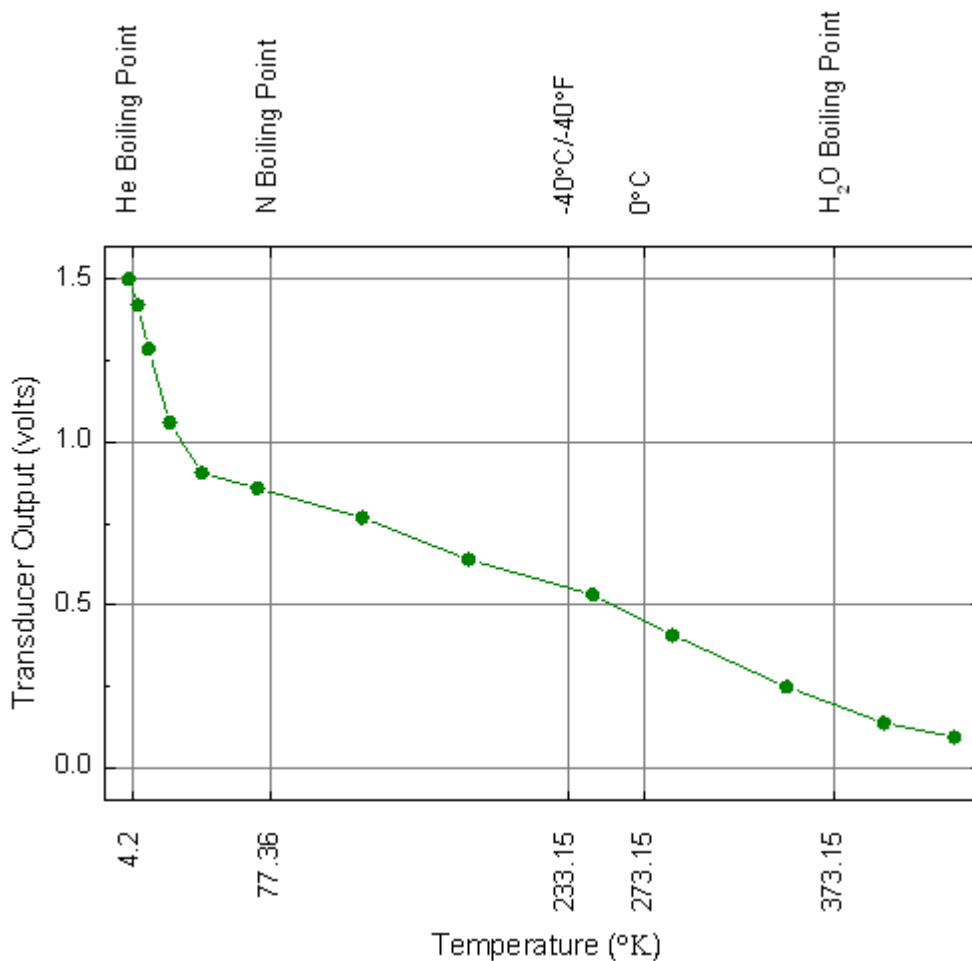

Minimum Origin Version Required: Origin 2015 SR0

#### 6.3.3.2 What you will learn

- How to specify the tick location using dataset
- How to show the customized tick labels

#### 6.3.3.3 Steps

1. Copy the [sample data](#), and paste it into row 1 of column A in Origin worksheet. Set the first row as Long Name and the second row as Units.

	A(X)	B(Y)	C(Y)	D(Y)
Long Name	Temperature	Transducer Output	Custom Temperature	Custom Label
Units	°K			
Comments				
F(x)				
1	2.5	1.5	4.2	He Boiling Point
2	2.5	1.5	4.2	He Boiling Point
3	7.3	1.42048	77.36	N Boiling Point
4	13	1.28681	233.15	-40°C/-40°F
5	24	1.06011	273.15	0°C
6	41	0.90549	373.15	H2O Boiling Point
7	70	0.85831		
8	125	0.7679		
9	181	0.63948		
10	246	0.53202		
11	288	0.40753		
12	348	0.24898		
13	399	0.13759		
14	436	0.09435		
15				
16				

- Highlight columns A and B. Select **Plot > Basic 2D :Line + Symbol** from the main menu. Alternatively, you can simply click the Line + Symbol button on the **2D Graphs** toolbar.
- Double-click the graph to open the **Plot Details** dialog. On the **Symbol** tab, change the symbol to a solid circle, and the color to **Olive**. On the **Line** tab, change the line color to Olive and click **OK** to close the dialog and apply the changes.

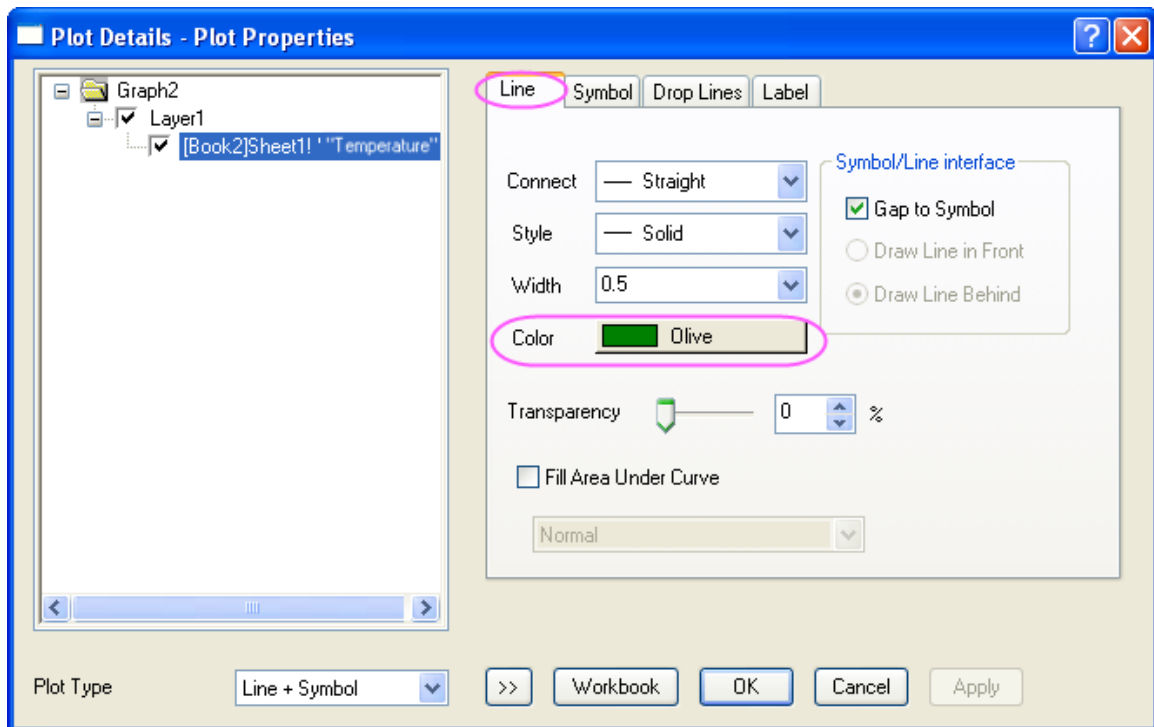
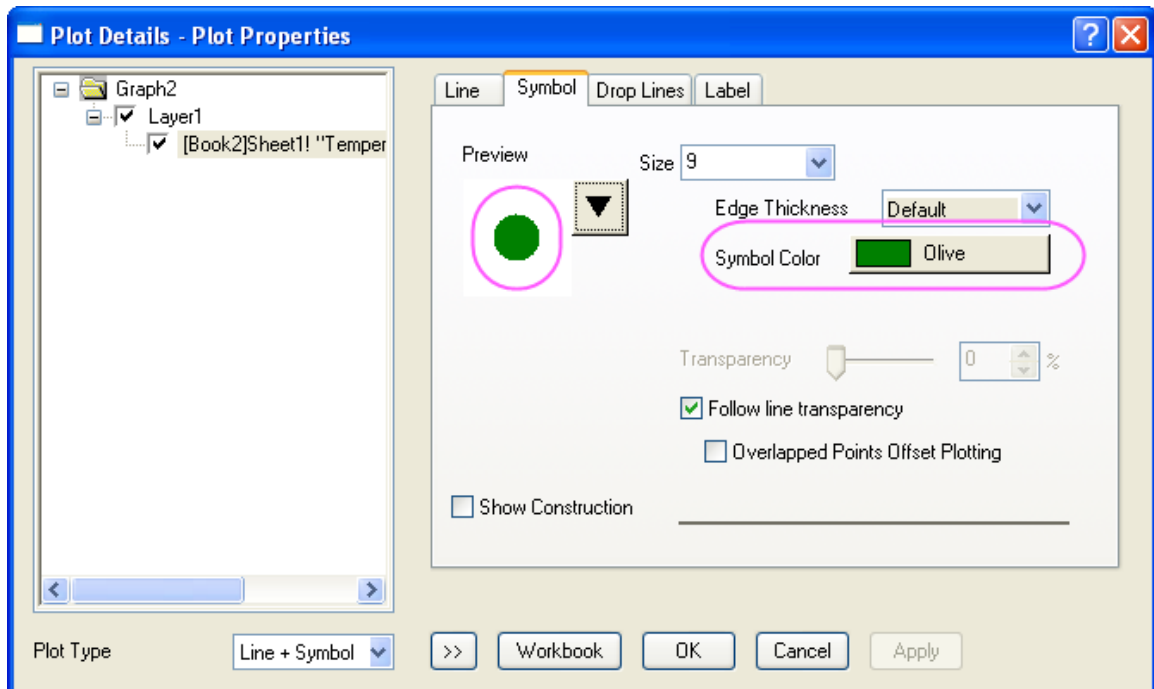

4. Double-click the X axis to open the **Axis** dialog. For both **Horizontal** and **Vertical** icon in **Scale** tab, enter these settings for the X and Y axes:

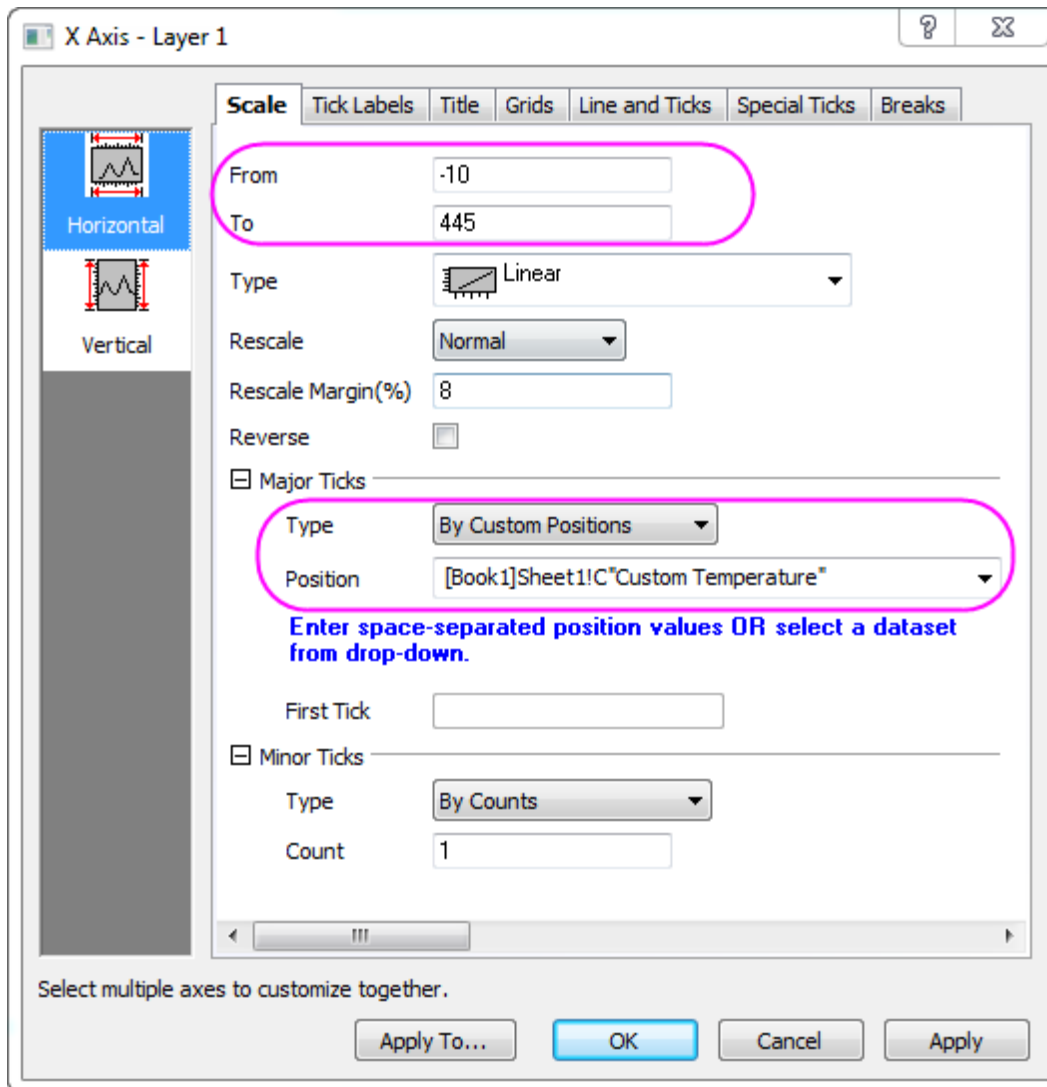

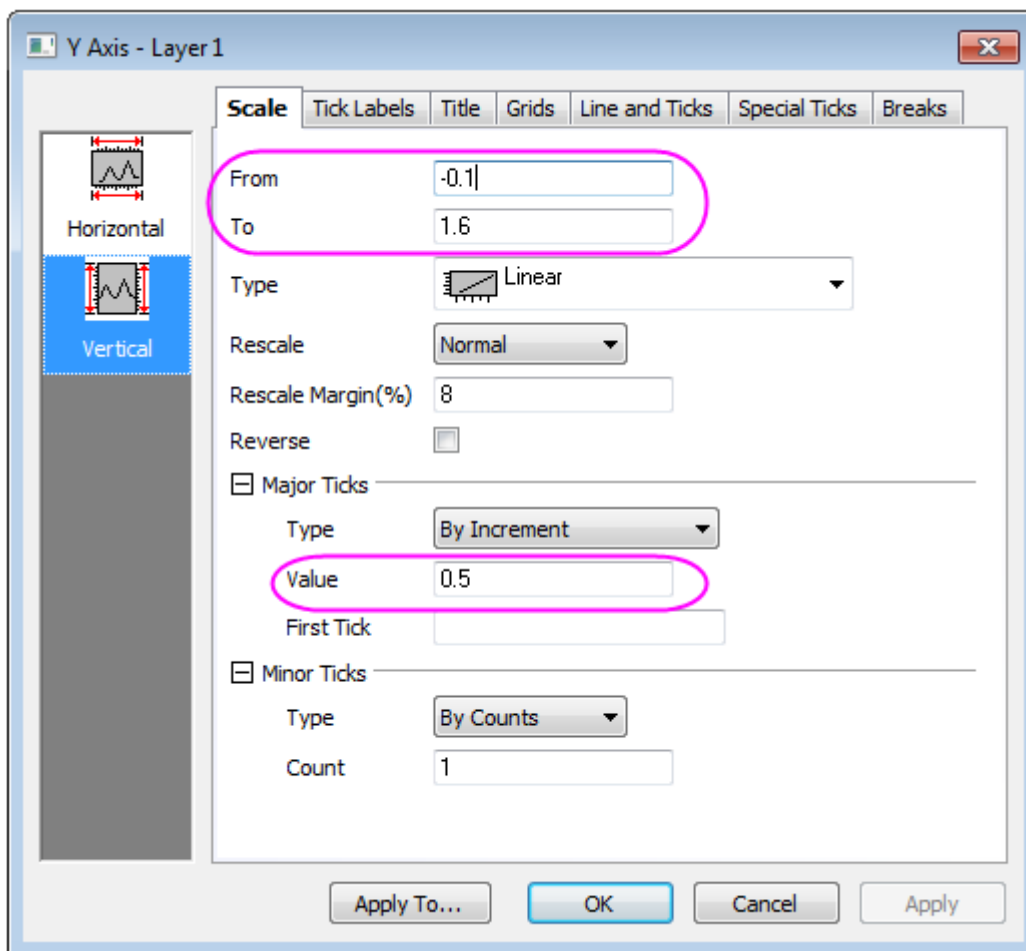

5. On **Line and Ticks** tab, go to **Top** and **Right** page, and check on **Show** to show the axis on top (right), Set the ticks style follows the graph below:



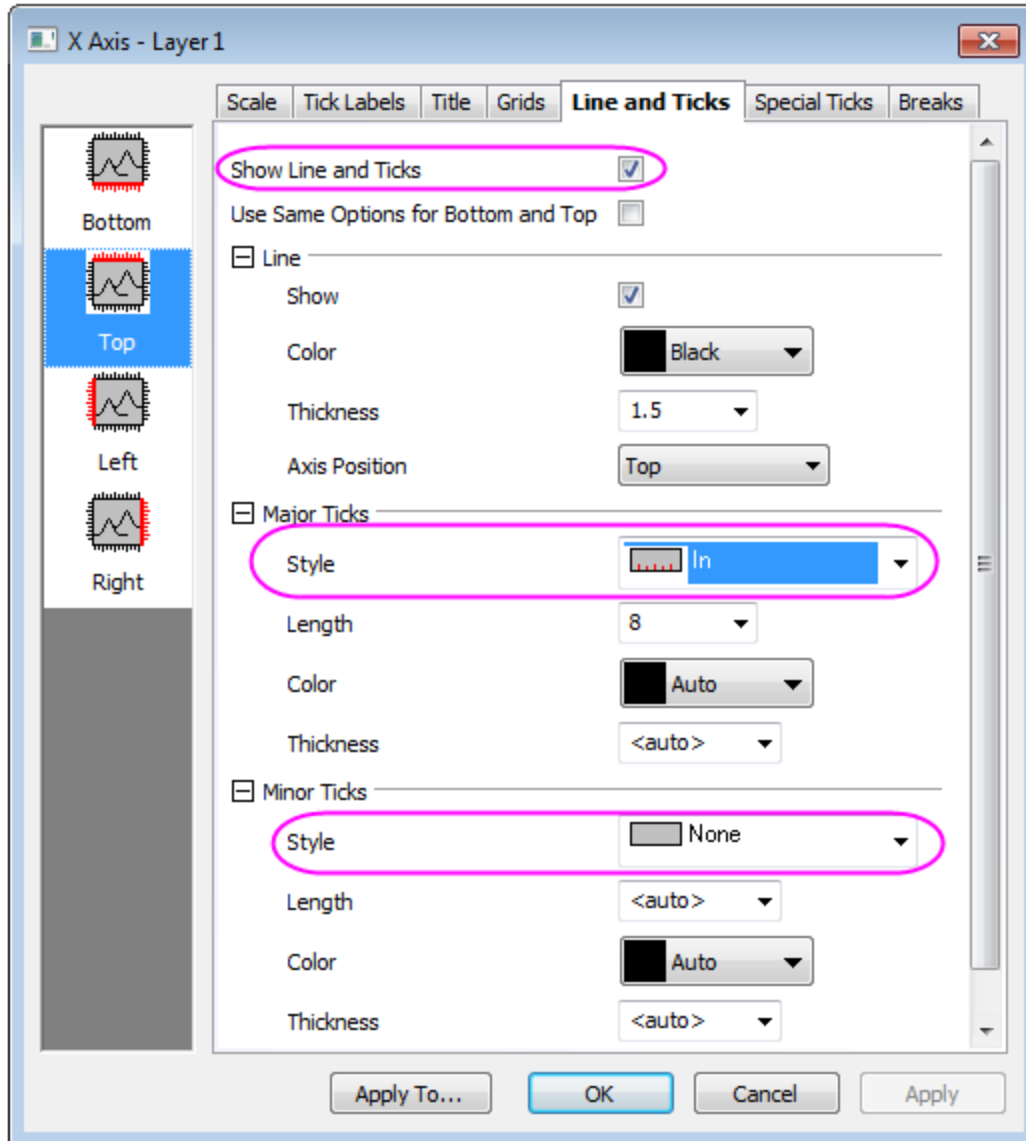

- Then, click the **Apply To...** button and go to the **Apply to Others** dialog, set the following:

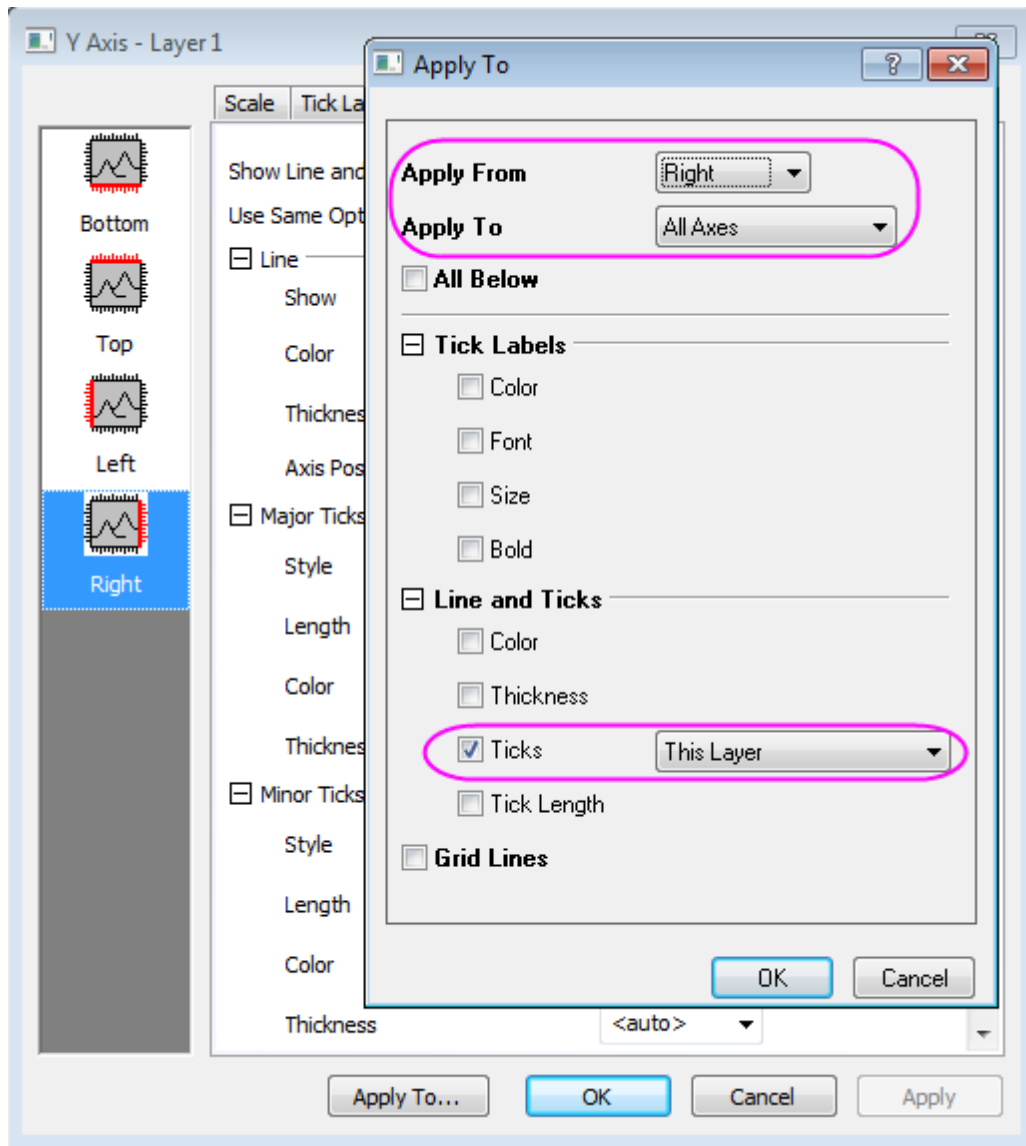

7. Click **OK** to close the **Apply to Others** dialog and return to the **Axis** dialog.
8. Go to **Display** tab in **Tick Labels** tab, and set the ticks Labels for bottom follows the graph below. In addition, you need to rotate the tick labels by 90 degree in **Format** tab for both top and bottom (which can be done in **Bottom** page) axis.

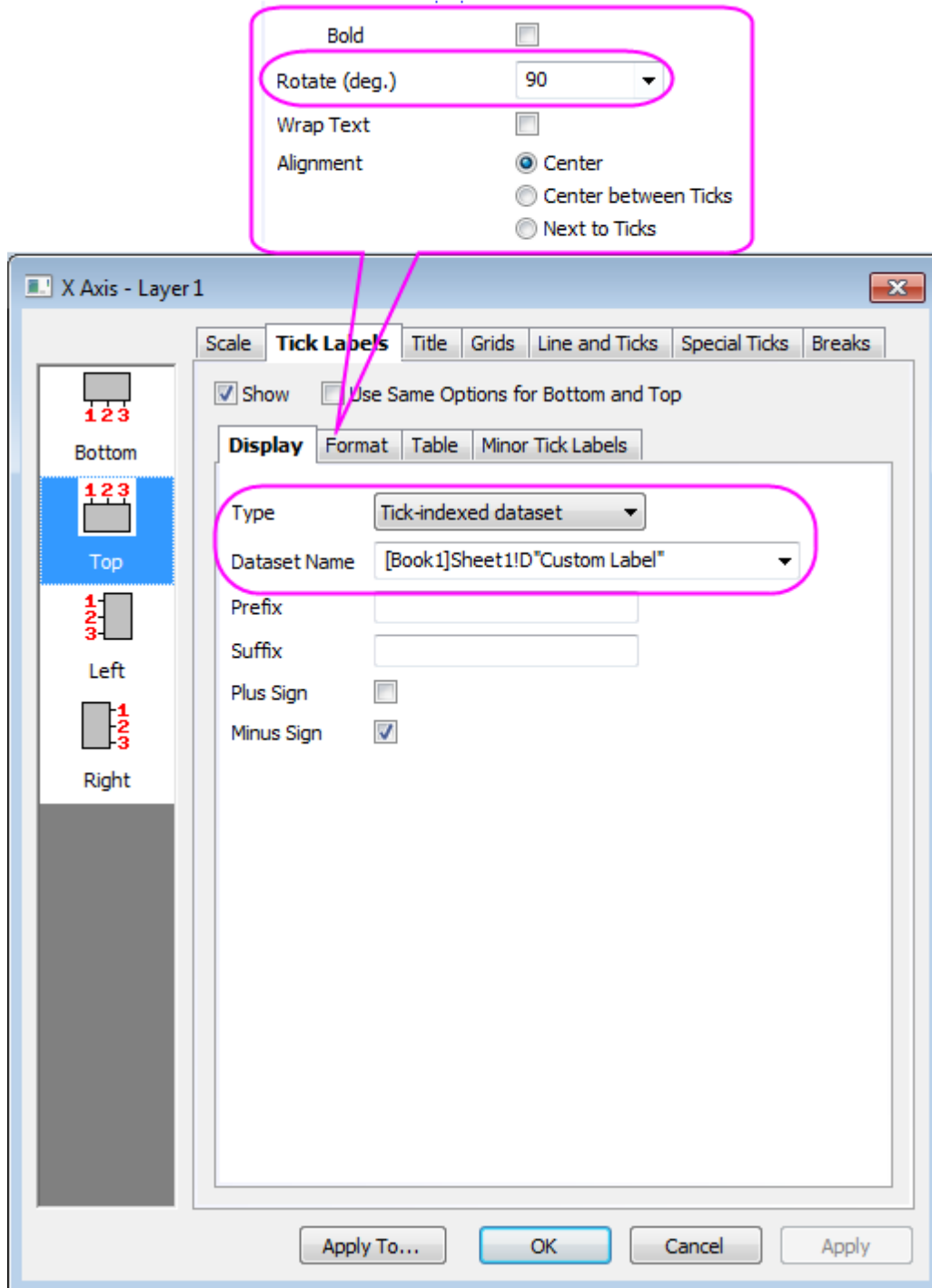

9. On the **Bottom** page under **Tick Labels** of **X Axis**, set the **Rotate(deg.)** to **90** similarly.
10. Select the **Grids** tab in Axis dialog axis. Check on **Show** in *Major Grid Lines* group for both **Vertical** and **Horizontal**:

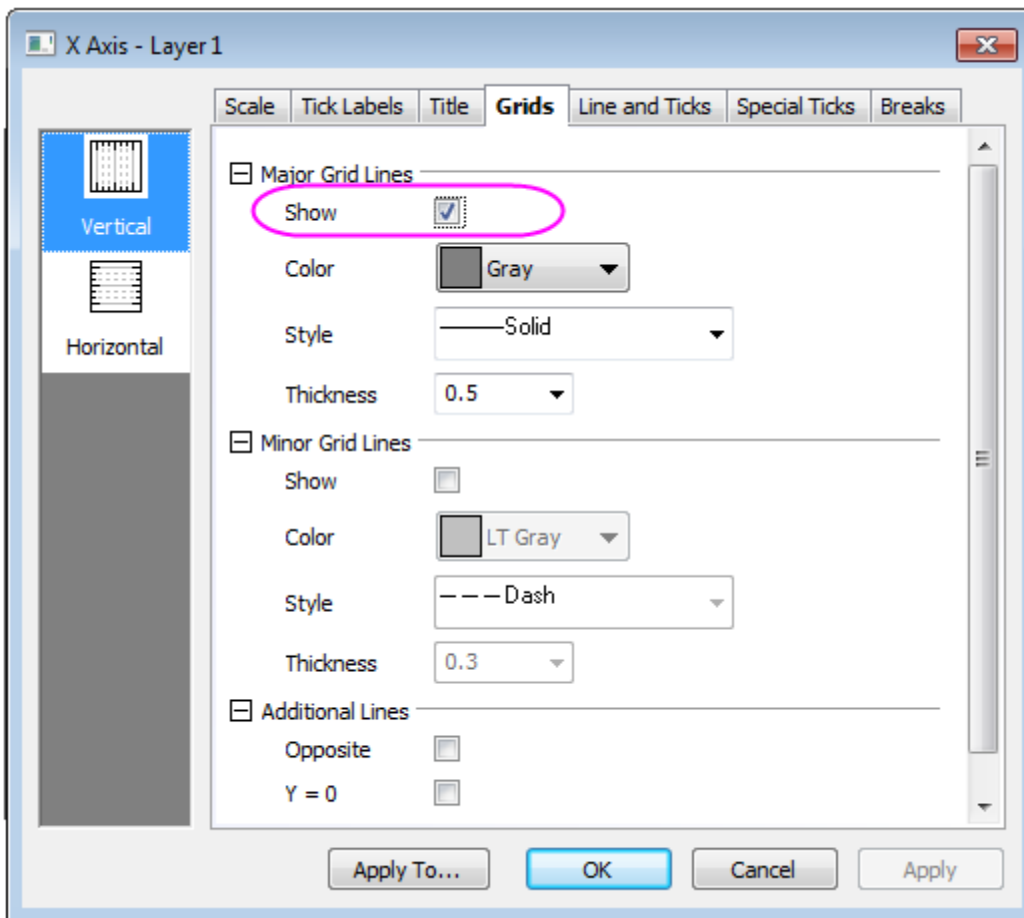

11. Click **OK** to close the **Axis** dialog. Adjust the Layer Area in **Format: Layer: Size/ Speed** tab. Your final graph should look like this:

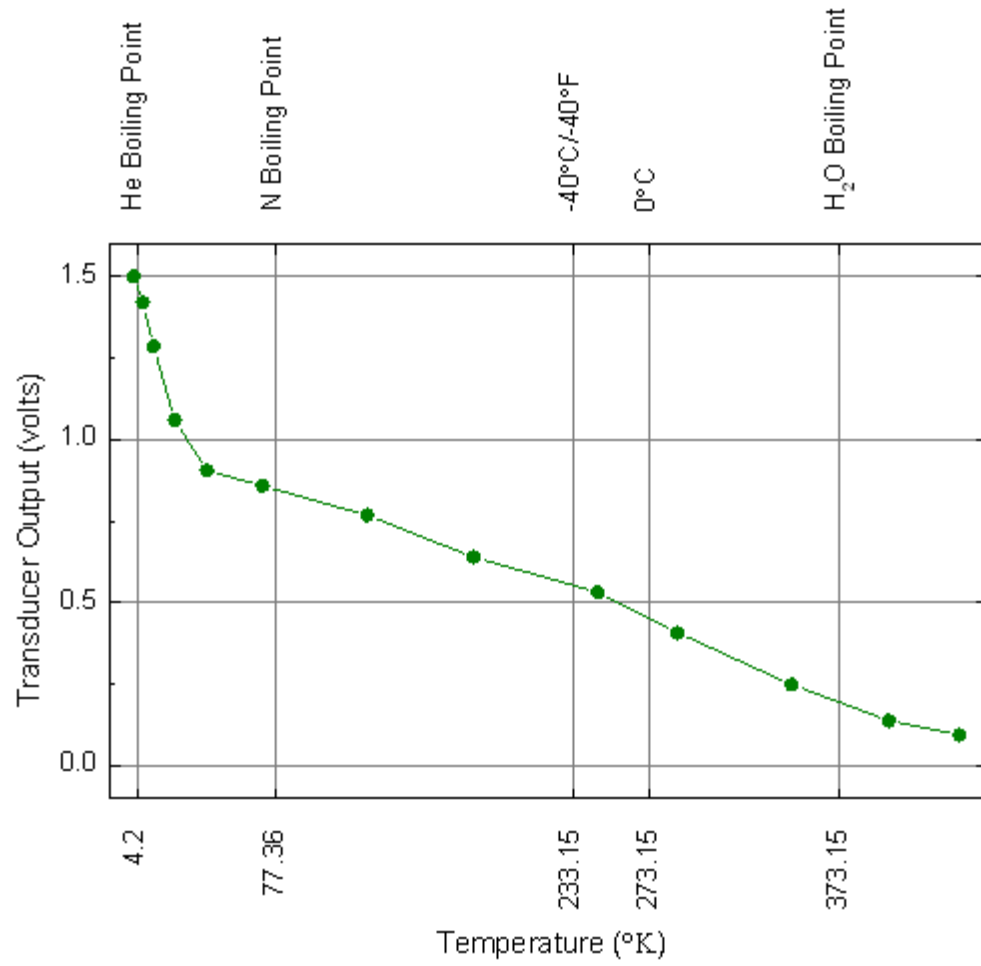

6.3.3.4 Sample Data

Temperature	Transducer Output	Custom Temperature	Custom Label
°K	volts		
2.5	1.5	4.2	He Boiling Point
2.5	1.5	4.2	He Boiling Point
7.3	1.42048	77.36	N Boiling Point
13	1.28681	233.15	-40°C/-40°F
24	1.06011	273.15	0°C

41	0.90549	373.15	H <sub>2</sub> O Boiling Point
70	0.85831		
125	0.7679		
181	0.63948		
246	0.53202		
288	0.40753		
348	0.24898		
399	0.13759		
436	0.09435		

### 6.3.4 Plot and Customize Date Time Data on Graph

#### 6.3.4.1 Summary

This tutorial will show you how to manipulate the date and time data, and customize the date and time data on the graph.

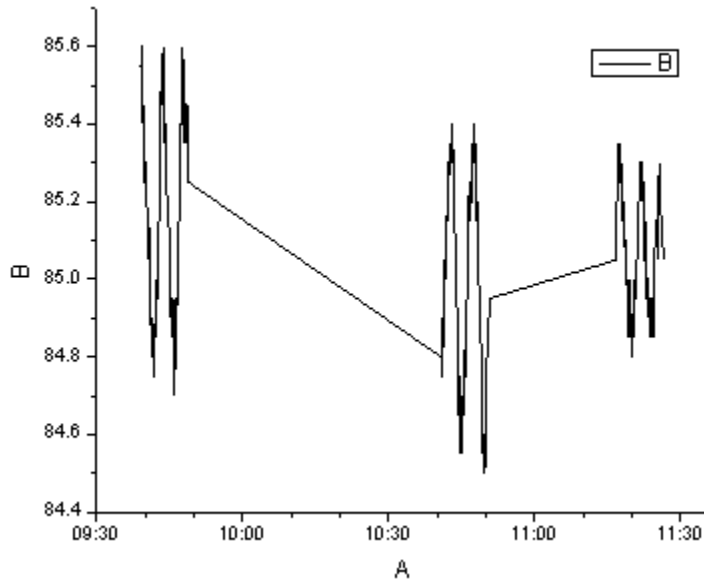

Minimum Origin Version Required: Origin 2015 SR0

#### 6.3.4.2 What you will learn

- How to plot the date and time data on the graph.
- How to customize the date and time tick labels.

#### 6.3.4.3 Steps

1. Start with a new project and import the data file *Sample\Import and Export\Custom Date and Time.dat* under Origin's program folder.
2. Double-click on A(X) to open the **Column Properties** dialog; set **Format** as *Date*, **Display** as *Custom Display*, and input *dd'.MM'.yyyy hh':mm':ss'.##* in the **Custom Display** box as shown below.

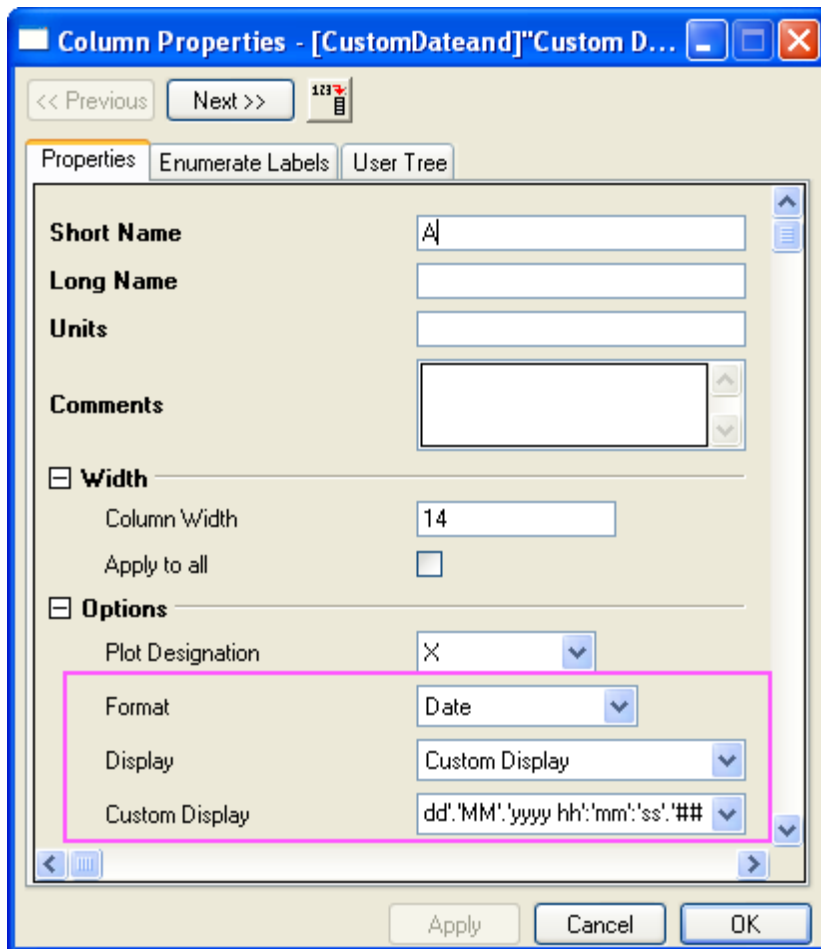

3. Click **OK** button to go back to the worksheet. Highlight col(B) and select **Plot > Basic 2D: Line** from the main menu to plot it as a line graph. You will see that the tick labels of X axis are all the same. This is because the tick labels are showing the date information only, but the X data are all in the same day. So we need to change the tick label format to display time.



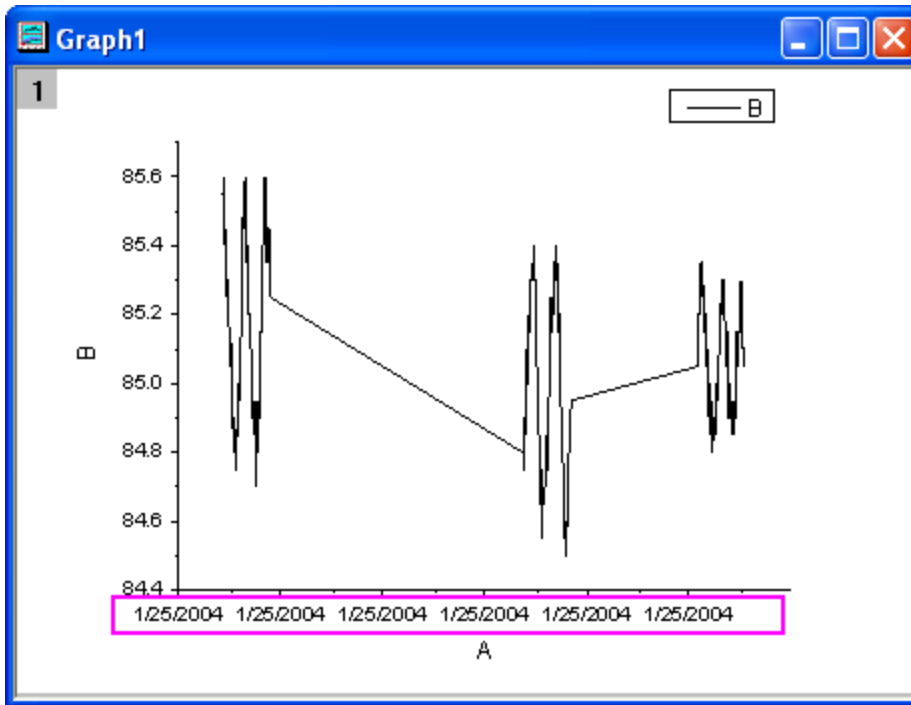

4. Double-click on the X axis (or select **Format : Axes : X Axis** from the main menu) to open the **Axis** dialog. Select **Horizontal** icon in the **Scale** tab, set the following first:

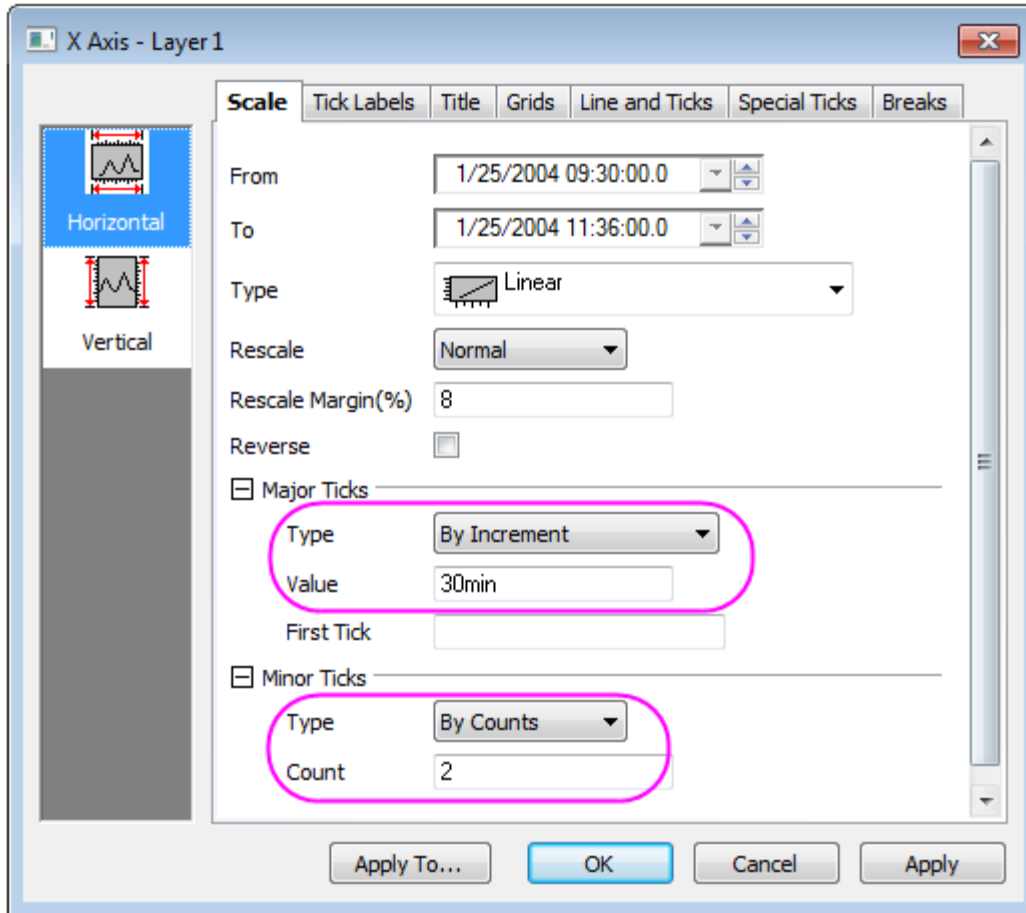

5. Go to the **Bottom** icon in **Tick Labels** tab, change **Type** to *Time* and select **Display** to *HH:mm* as shown below.

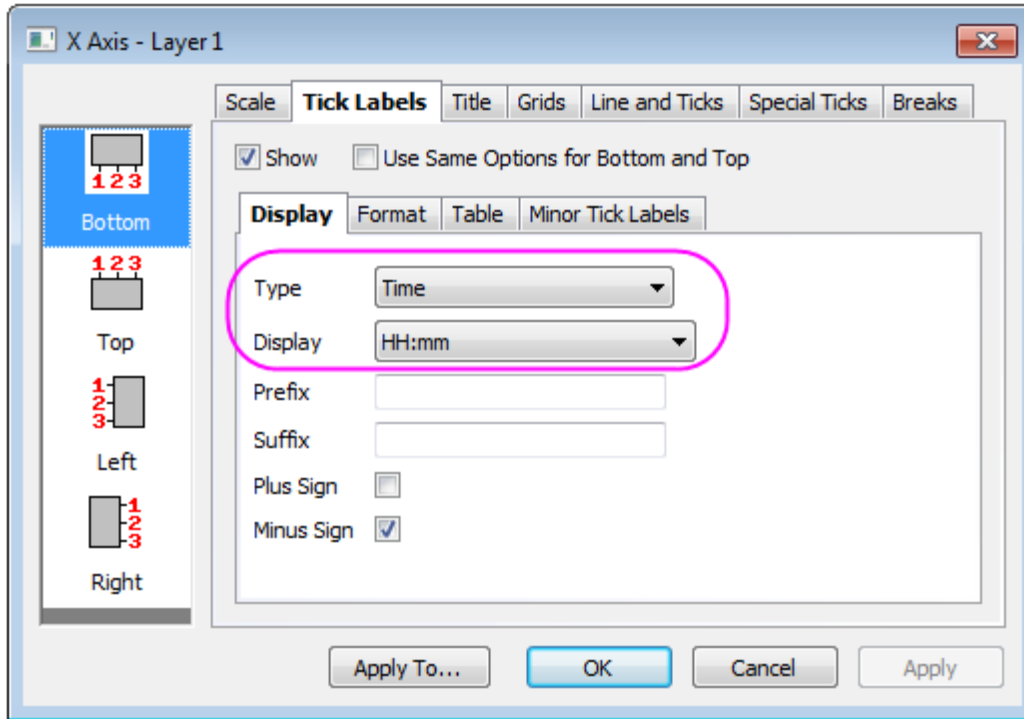

6. Click the **OK** button. The tick labels will now show as the corresponding time as in the graph below:

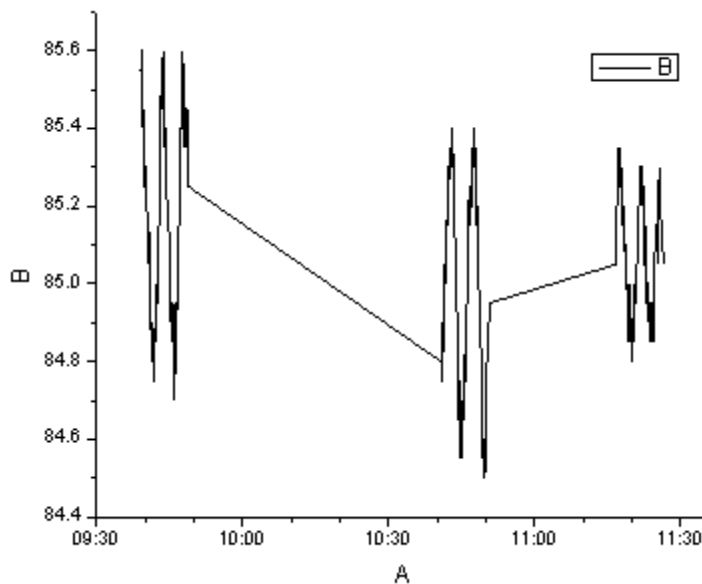

## 6.4 Compare Graphs Dynamically by Changing Data Filters

### 6.4.1 Summary

The **Copy Columns To..** feature allows you to copy columns from a worksheet to a new worksheet while keeping the two sheets linked. Using this feature you can set multiple Filter conditions on one columns by

creating a corresponding number of worksheets. For example to set two Filter conditions on the Column **Gas Type** we created two sheets *Type1* and *Type2* that were linked to worksheet *Raw*. We also used various features to create a dynamic Graph that would update to reflect the changes in Filter conditions in real time. You can watch the video tutorial explaining these concepts here: <https://www.youtube.com/watch?v=N0Pud-91qCM>

Minimum Origin Version Required: Origin 2015 SR0

### 6.4.2 What you will learn

This tutorial will show you how to:

- Dynamically compare data with different filter conditions
- Add multiple filter conditions on the same columns using different worksheets
- Add a dynamic filter label in a graph that updates with changes in the filter condition

### 6.4.3 Steps

This tutorial is associated with the Tutorial Data.opj file under <Origin EXE Folder>\Samples path.

#### 6.4.3.1 Set Up the Worksheets

Open the Tutorial Data.opj file and browse to the folder **Compare Graphs with Filters Data** and active workbook **Book1**. The worksheet **Raw** contains data for the emission of different green house gases in different countries over a period of years.

1. Highlight the last three columns : *Year, Gas Type, Value*
2. Right click on one of the columns and in the context menu that opens select **Copy Columns To...**

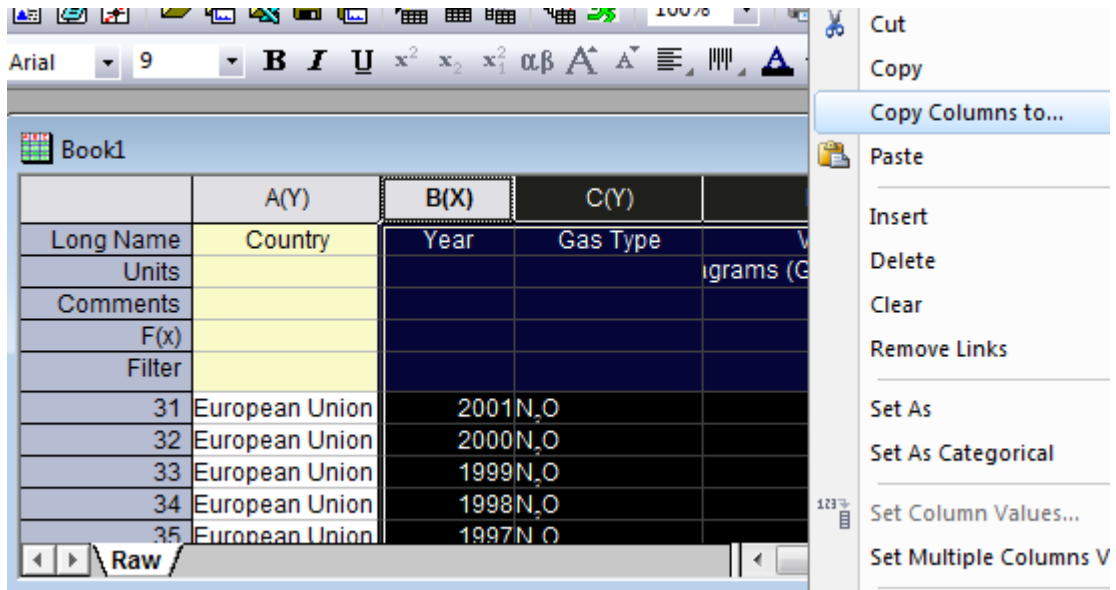

3. In the **Copy Columns to: colcopy** dialog that opens, change the **Recalculate** to **Auto** so later when input data is changed the result will be automatically updated. Also make sure the **DestinationColumn(s)** is set to <new>!<new> meaning a new worksheet is added, and click **OK**

4.

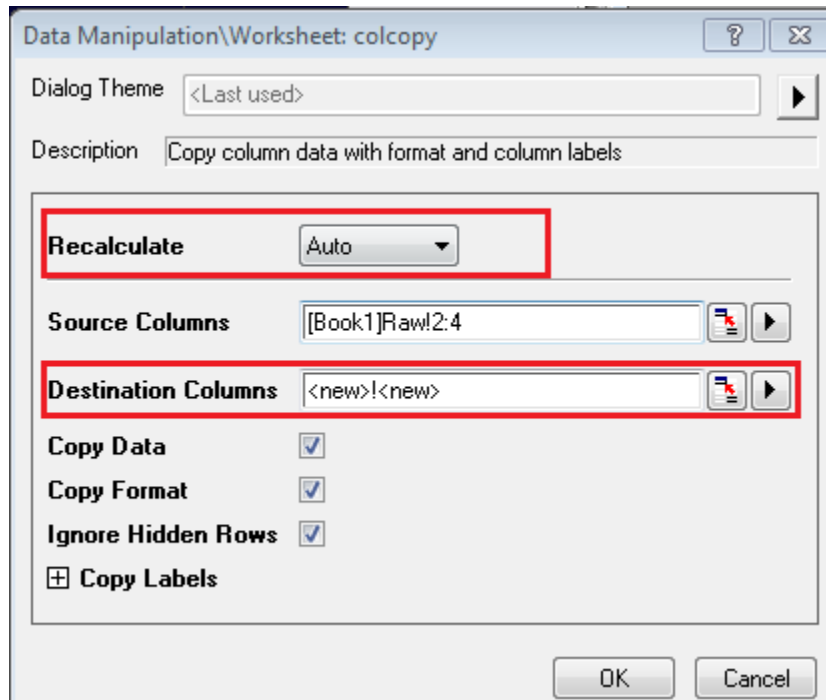
5. Name the new worksheet *Type1*6. Repeat the above procedure and name the second worksheet *Type2*

7.

	A(X)	B(Y)	C(Y)
Long Name	Year	Gas Type	Value
Units			
Comments			
F(x)			
Filter			
1	2010	N,O	47141
2	2009	N,O	47171
3	2008	N,O	51780
4	2007	N,O	49446
5	2006	N,O	48206
6	2005	N,O	50406
7	2004	N,O	51680
8	2003	N,O	48864
9	2002	N,O	46530

6.4.3.2 Set Filters

1. On Sheet *Raw* highlight column **Country** and select the Filter button.
- 2.

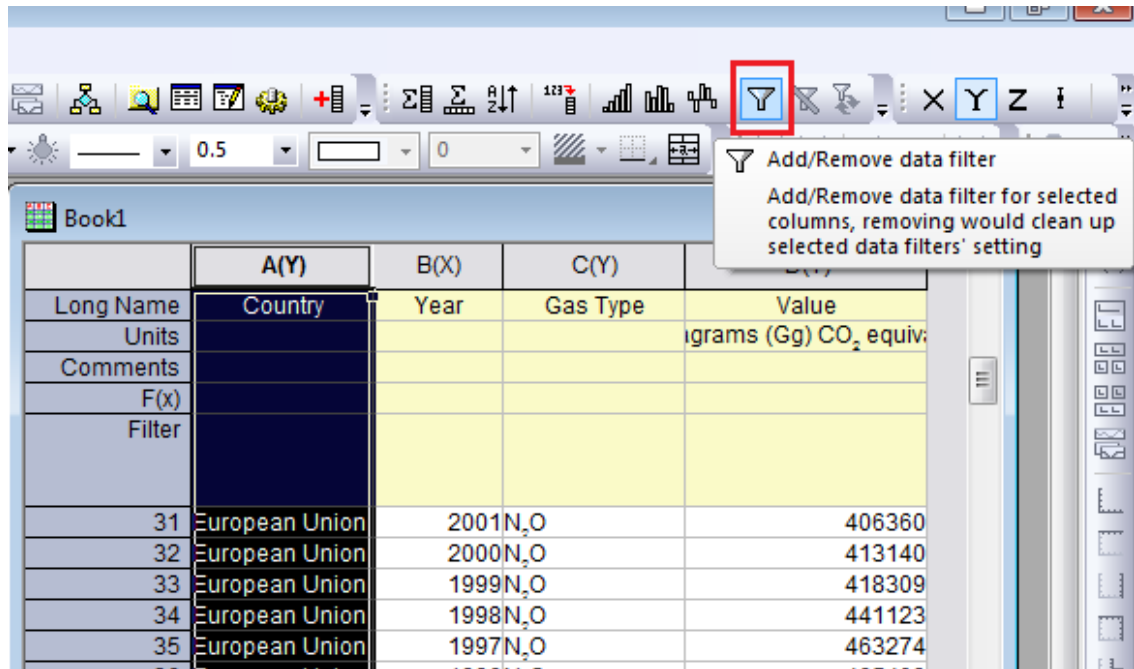

3. This will create a funnel icon on the top left of the **Country** column. Click on this and in the menu that opens deselect the **Select All** check box and check the **France** check box. Click **OK**

4.

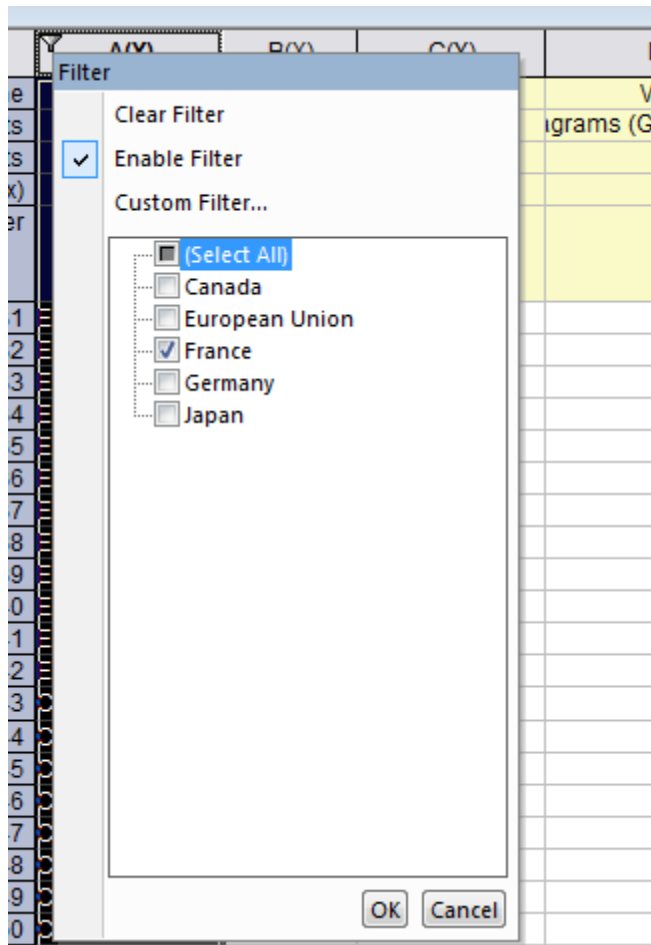

5. The worksheet now only shows information for the country France.

6. In Sheet *Type1* set a Filter on the **Gas Type** column for the gas **HFCs**. Since sheet *Raw* and sheet *Type1* are linked, this worksheet will now show only the HFC emission values for the country France.

7.

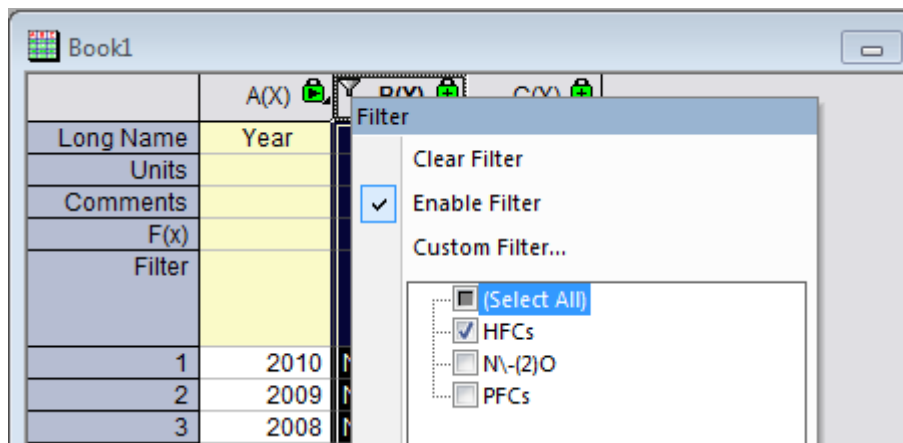

8. In Sheet *Type2* set a Filter for **Gas Type** PFCs. This worksheet now only shows PFC emission values for Country France.

### 6.4.3.3 Creating the Graph and Adding a Linear Fit

1. Without anything highlighted in any of the worksheets go to **Plot > Basic 2D : Stack....**
2. In the dialog that opens, click on the arrow button next to the **Input** box and select **Select Columns...**
- 3.

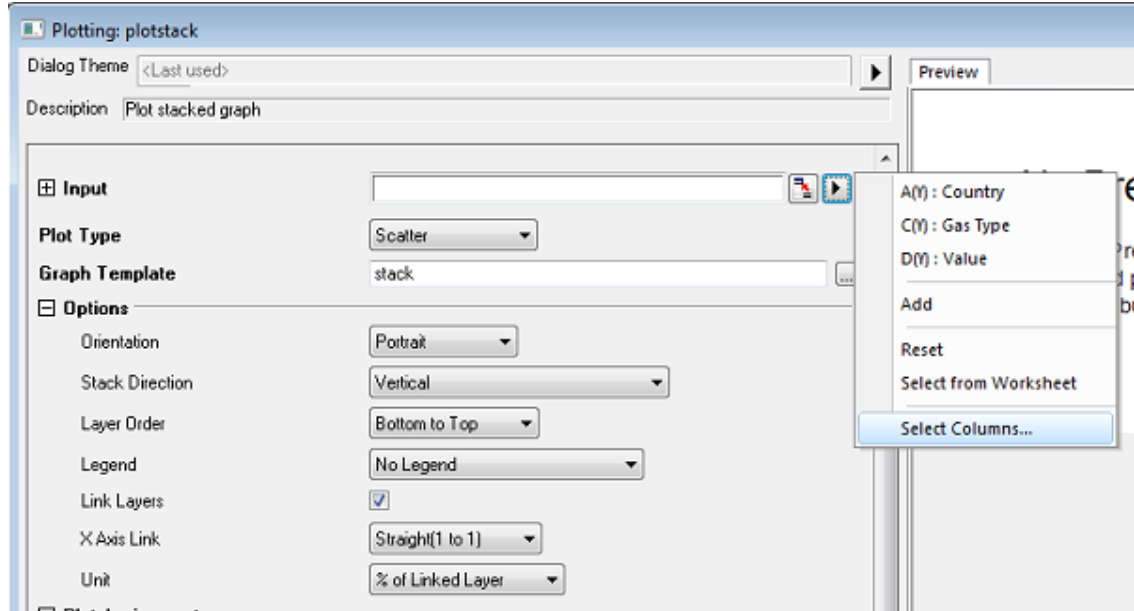

4. In the **Data Browser** dialog, make sure that **List Datasets = in Current Book** and select both the **Value** columns in Sheets *Type1* and *Type2*. Click **Add** and OK out.



5.

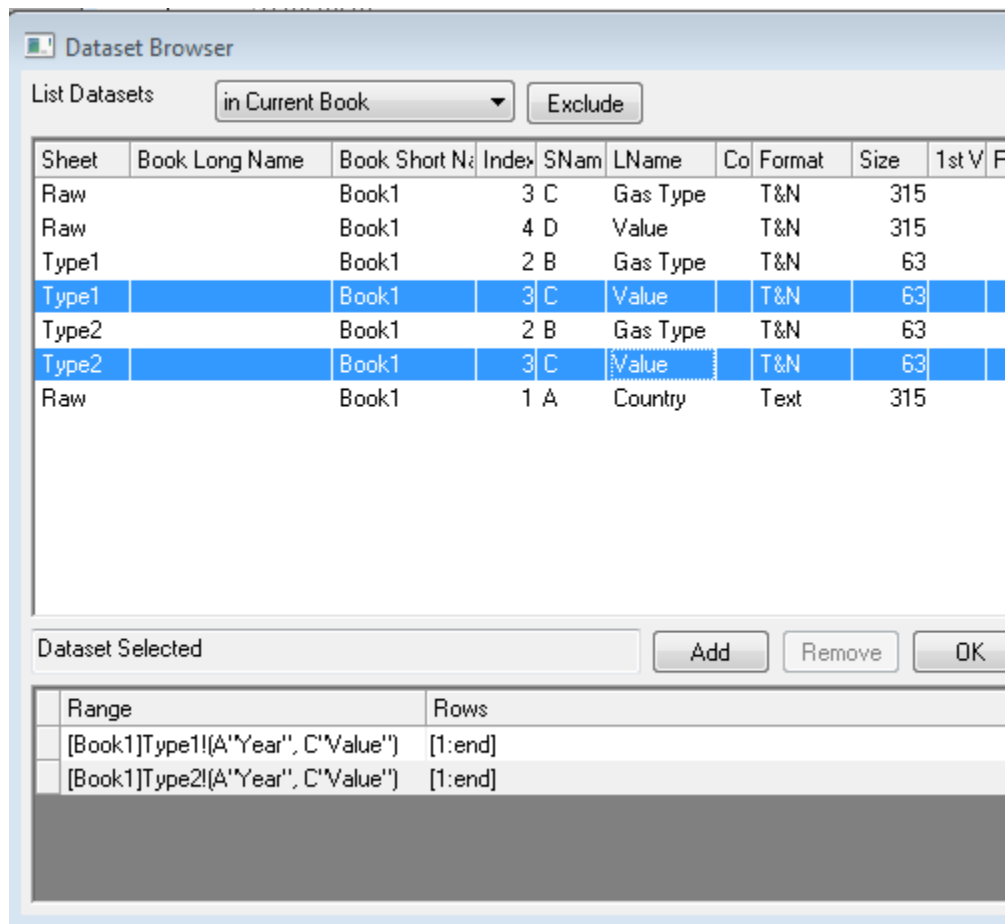

6. In the **Stack: plotstack** dialog, set **Plot Type** to **Scatter** and click OK. This will create the following graph:

7.

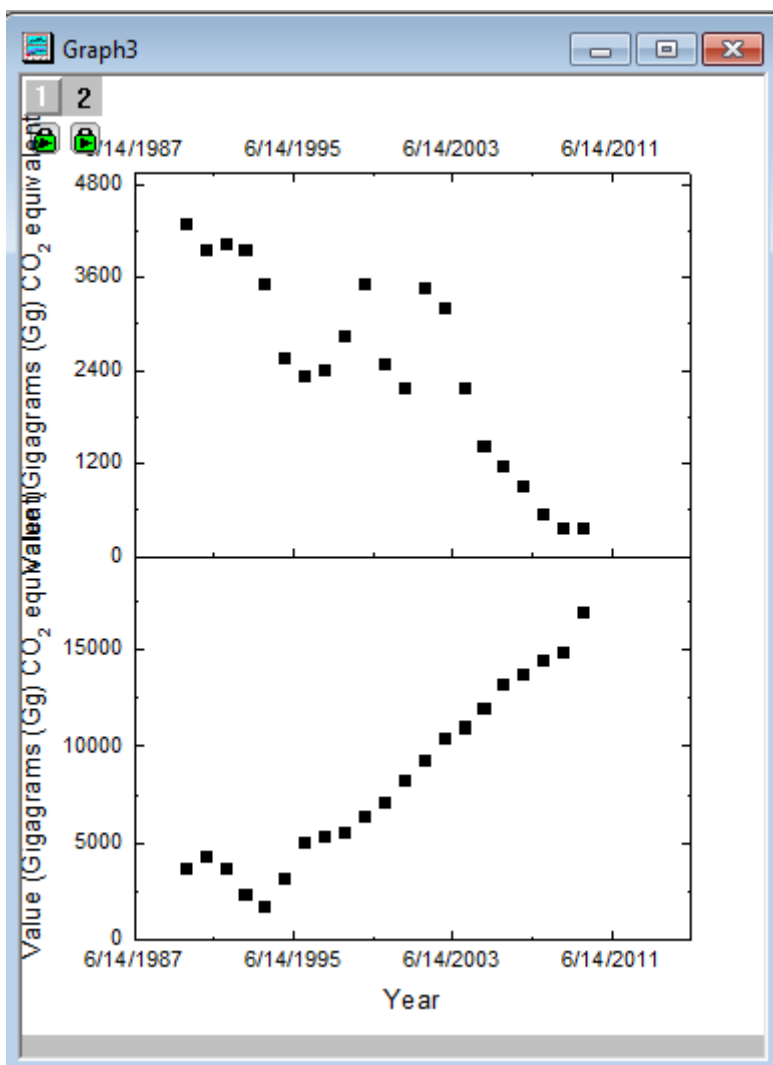

8. In the newly created graph double click on any axes, in the **Scale** tab set the **Rescale** as **Auto**. Do this for every axes on both plots of this graph so when the worksheet filter is changed and the graph data changes, the axes will rescale automatically.

9.

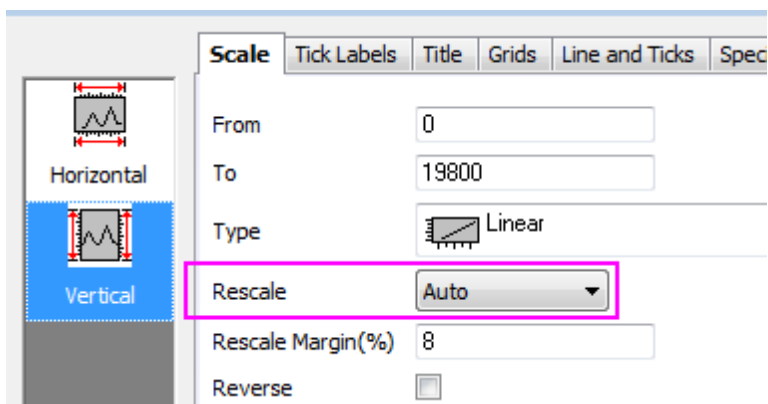

**Note:** By holding the **Ctrl** key and selecting both **Horizontal** and **Vertical** icons, you can change **Rescale** for X and Y axes in the same layer, simultaneously. Use the Layer drop-down at the bottom of the dialog box to apply changes to both graph layers (i.e. Layer 1 and Layer 2).

- Set the Layer drop-down to Layer 1, then click the **Tick Labels** tab. With **Bottom** icon selected, change the **Display** to show just the year.

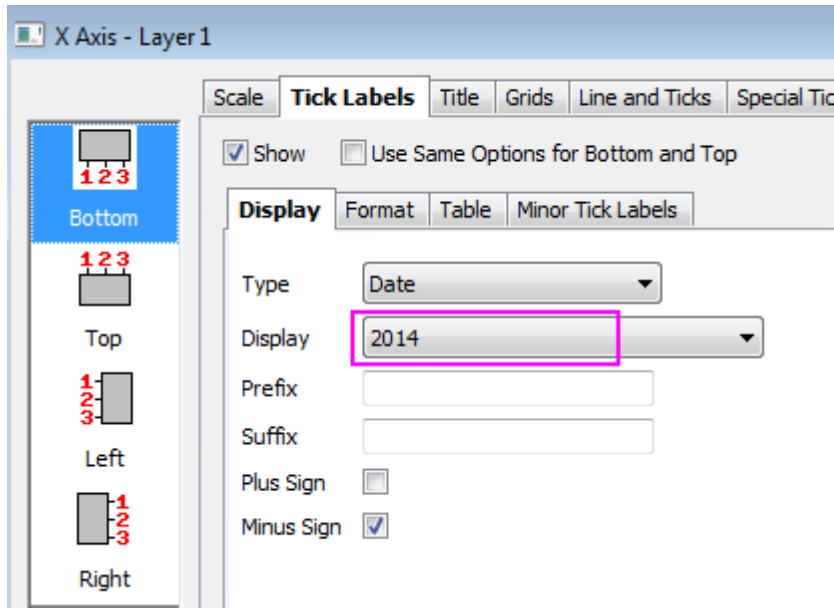

- Click the **Line and Ticks** tab. With the **Right** icon selected, and set **Major** and **Minor Ticks Style** to **None** and Apply.

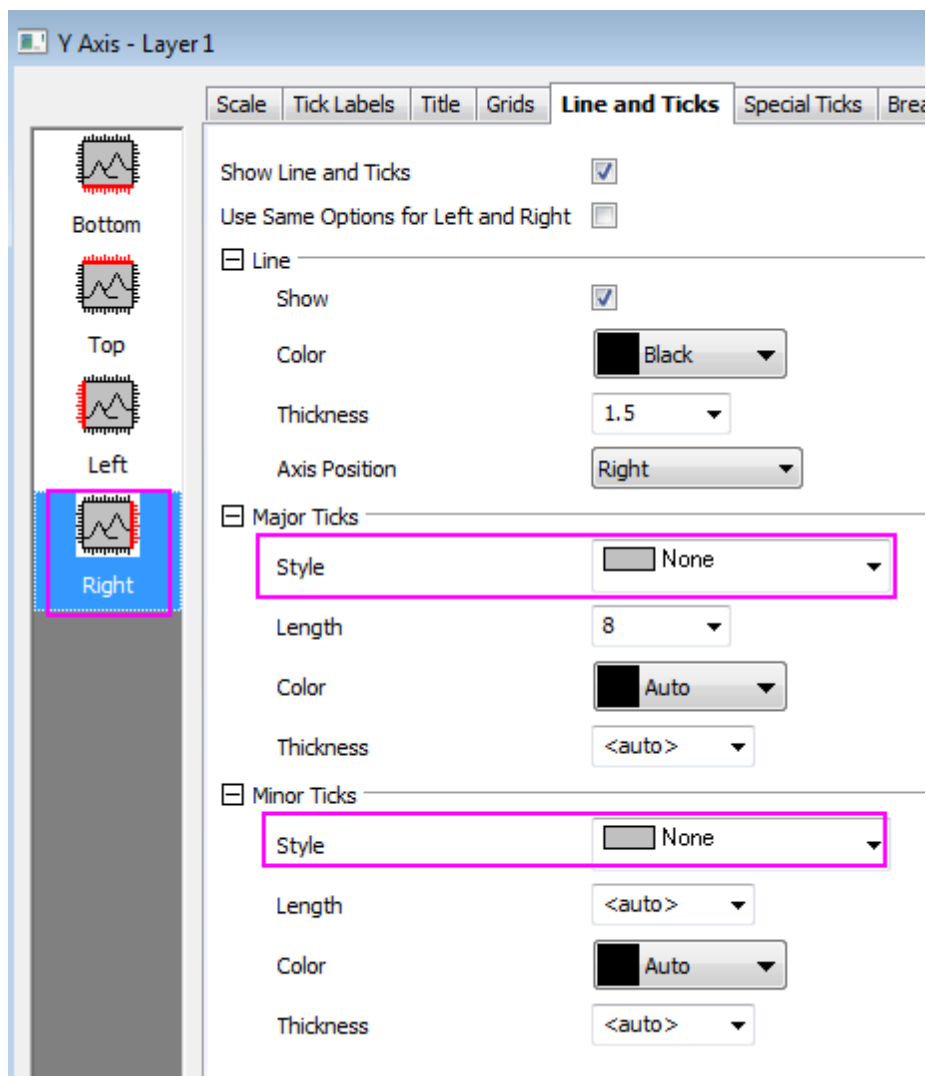

12. Set the **Layer** drop-down list to **Layer 2** and repeat for the Top X axis and Right Y axis in Layer 2 and click **OK**.
13. Delete the two Y axis title objects at the left part of the graph, add a new text label **Value** and rotate it to 90 degrees (right click and select **Properties** to change rotation angle) and use it as the new Y axis title.
14. Next we're going to do a Linear Fit so the emission trends are more apparent.
15. Activate the graph and go to **Analysis:Fitting: Linear Fit....**
16. Set **Recalculate** to **Auto**.
17. Use the arrow button next to the **Input** box to select **Add all plots in active page**. Click OK to close the dialog and perform a linear fit on the two plots.

18.

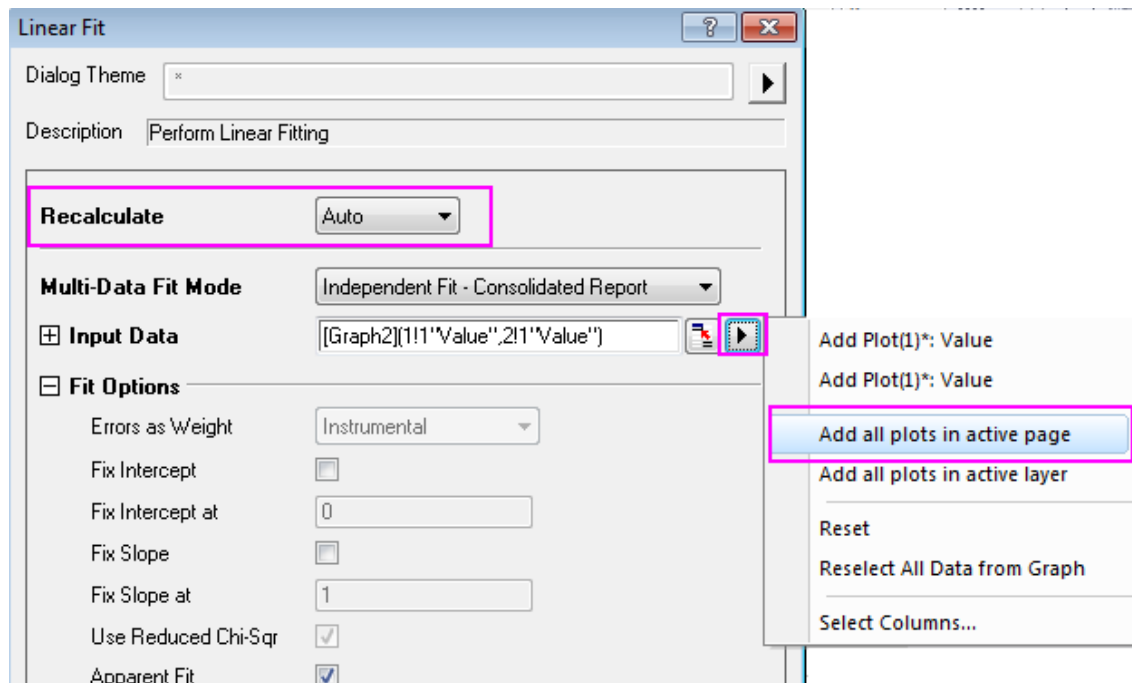

19. Double-click on the linear fit curves and go to the **Plot Details** dialog, in the **Line** tab, set the color as **Red** for each curve. Delete the two legend objects and move away the report table. The resulting graph will look like this:

20.

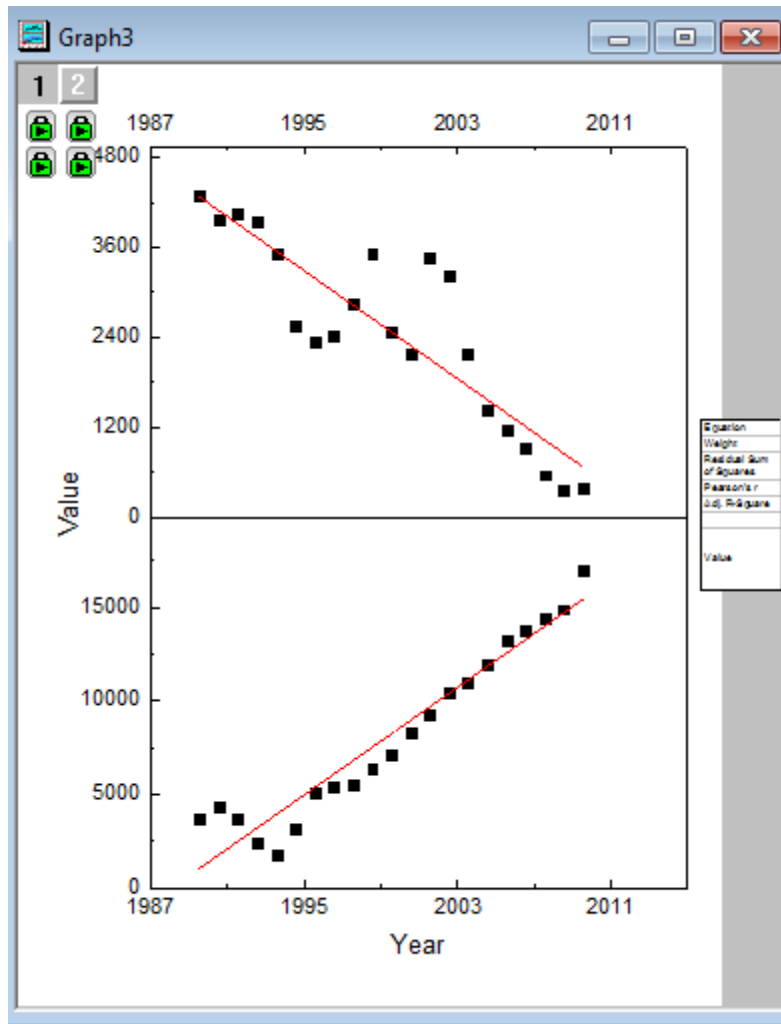

#### 6.4.3.4 Add Dynamically Changing Labels

1. Click on the Sheet *Type1* and select the Filter label row cell in column B.

2. Click **Edit: Copy: Copy**

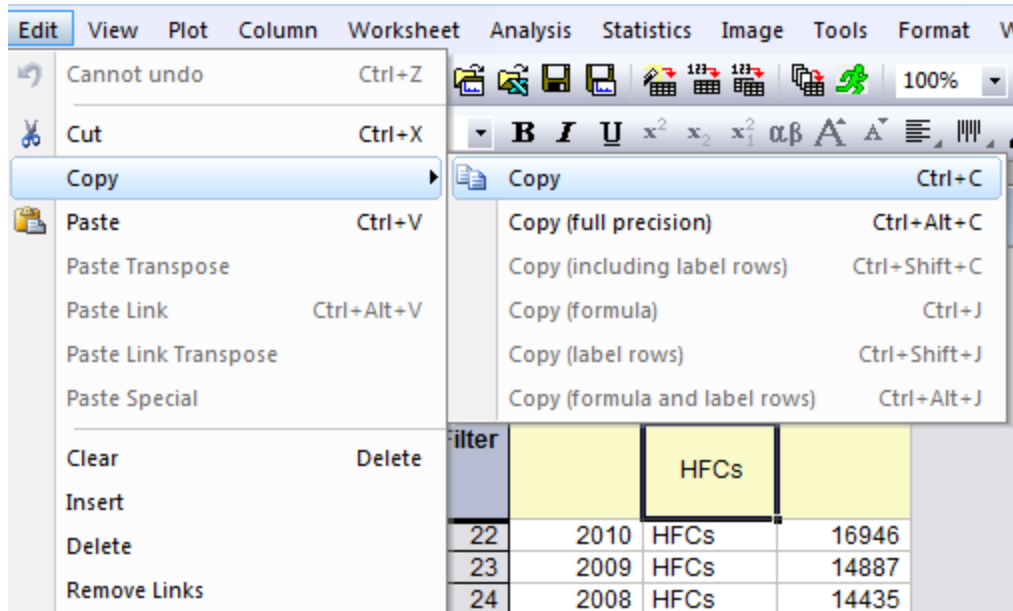

3. Select the Text Tool , and click on the graph upper panel. When the blue text box appears hold down **Ctrl + Alt + V**. This will paste the Data Filter Label as a link into the text box.
4. Click off of the new text label, then right-click and select **Properties**.

5.

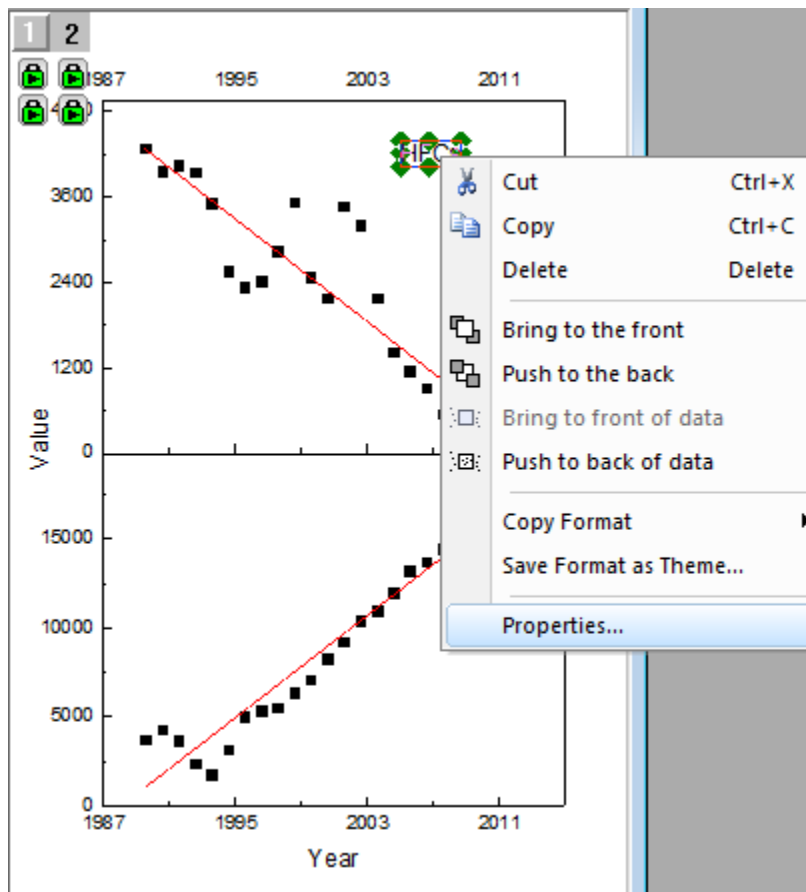

6. In the dialog that opens, click on the **Programming** tab, then check the **Real Time** check box so the label changes every time the data filter is changed.
7. Do this with the Filter Labels in Sheet *Type2* and Sheet *Raw*. Add the words "Gas Type" before the "PFC" and "HFC" labels and "Country" before the Country Data Filter Label. Also Add a Layer Title:



8.

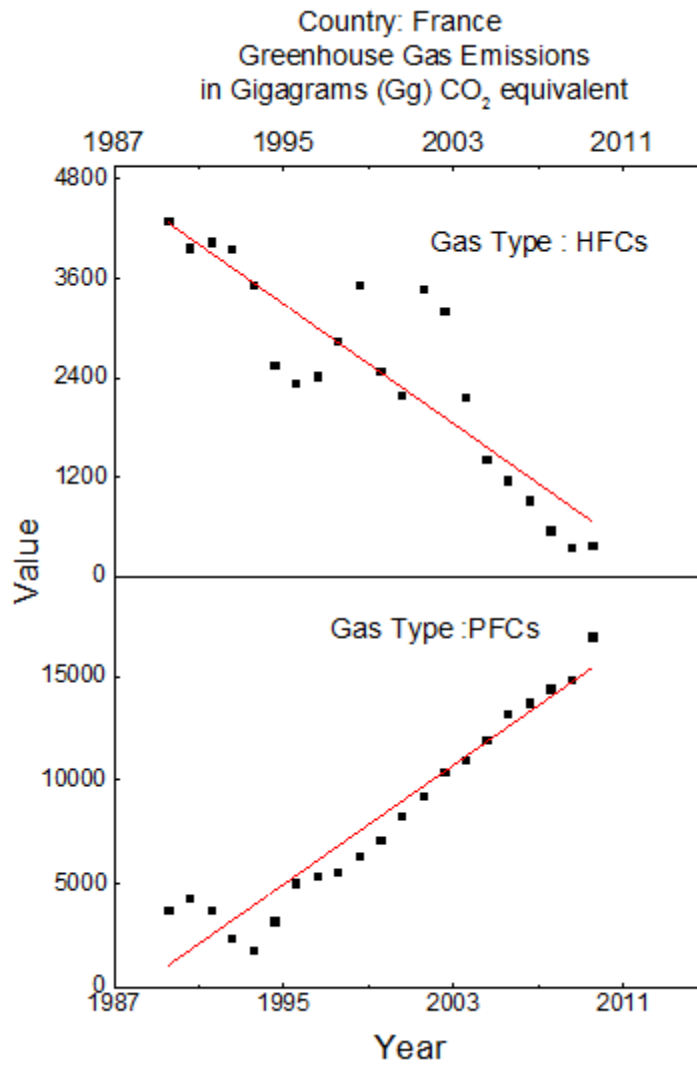

#### 6.4.3.5 Add Floating Graph to the Worksheet

1. To add the graph to the worksheet, activate the worksheet *Raw*
2. Right click on the grey section of the worksheet and in the context menu that opens select **Add Graph..**

3.

The screenshot shows the 'RawData' window in Origin software. The data table is as follows:

	A(Y)	B(X)	C(Y)	D(Y)
Long Name	Country	Year	Gas Type	Value
Units				grams (Gg) CO <sub>2</sub> equiv
Comments				
F(x)=				
Filter	France			
127	France	2010	N <sub>2</sub> O	59833
128	France	2009	N <sub>2</sub> O	61971
129	France	2008	N <sub>2</sub> O	65903
130	France	2007	N <sub>2</sub> O	64881
131	France	2006	N <sub>2</sub> O	65308
132	France	2005	N <sub>2</sub> O	67738
133	France	2004	N <sub>2</sub> O	68231
134	France	2003	N <sub>2</sub> O	70234
135	France	2002	N <sub>2</sub> O	72886
136	France	2001	N <sub>2</sub> O	74903
137	France	2000	N <sub>2</sub> O	77574
138	France	1999	N <sub>2</sub> O	78608
139	France	1998	N <sub>2</sub> O	85477
140	France	1997	N <sub>2</sub> O	92859
141	France	1996	N <sub>2</sub> O	91448
142	France	1995	N <sub>2</sub> O	90020
143	France	1994	N <sub>2</sub> O	88267
144	France	1993	N <sub>2</sub> O	87019
145	France	1992	N <sub>2</sub> O	91240
146	France	1991	N <sub>2</sub> O	90073
147	France	1990	N <sub>2</sub> O	91322
148	France	2010	HFCs	16946

The 'Data Provider' dialog box is open on the right, showing the URL 'http://data.un.'. The 'Add Graph...' option in the 'View' menu is highlighted with a pink box.

- In the **Graph Browser** dialog that opens, select the graph we just created, and then click **OK**
- Enlarge the graph by selecting it and dragging the edges. If you change the Filter Types in the worksheet now, the graph will update accordingly.

## 6.5 Layers

### 6.5.1 Layers

- [Merging and Arranging Graphs](#)
- [Multiple Layers with Linked Axis](#)
- [Multi Layer Graph Customization](#)

### 6.5.2 Adding and Arranging Layers

### 6.5.2.1 Summary

A typical graph page generally includes three elements: a set of X, Y (and Z) coordinate axes, one or more data plots, and associated text and graphic labels. Origin combines these three elements into a movable, resizable unit called a layer. While a page can contain as many as 121 layers, only one layer can be active at any one time.

### 6.5.2.2 What you will learn



- How to tell how many layers a graph has?
- How to tell what data is in what layer?
- How to swap layers

### 6.5.2.3 Steps

#### 6.5.2.3.1 Importing data

1. Click the **Import Single ASCII** button, , on the Standard toolbar. The ASCII dialog opens.
2. In the Origin folder, browse to the Samples folder and then the Graphing folder. Select Wind.dat from the list of files.
3. Click **Open**. The data file imports into the worksheet.

#### 6.5.2.3.2 Plotting the data

1. Highlight the Speed and Power columns.
2. Click the **Line** button, , on the **2D Graphs** toolbar. A line plot is created. It appears that this data would be better plotted on a double-Y graph, a graph with two controlling Y axes.
3. Click the X to **Close** this window. You will be asked if you want to hide or delete the window. Click the **Hide** button. (If you Delete, you will not be able to Undo, and you will need to re-create the graph. Hiding closes the window from view, but you can later make it visible using the Project Explorer window.)
4. The Speed and Power columns should still be highlighted. Click the **Double-Y Axis** button, , on the 2D Graphs toolbar. This new graph contains 2 layers.

#### 6.5.2.3.3 How to tell what data is plotted in a layer?

One way is with the legend:

1. Double-click on Graph1 from the Project Explorer window. The graph opens and becomes the active child window.
2. Select **Format:Page** and go to the **Legends/Titles** tab.
3. Set the **Auto Legend Translation Mode** to *Data Range*.
4. Click **OK**.

A second way is with the status bar:



1. Double-click on Graph2 from the Project Explorer window. Graph2 is now in front and becomes the active child window.
2. Click the Layer 1 icon,  to make layer 1 active.
3. Look in the lower right of Origin's status bar and you'll see [WIND]WIND!Col(Speed)[1:12].
4. Repeat for Layer 2 and you'll see [WIND]WIND!Col(Power)[1:12].

A third way is from the menu:

1. Make Graph2 active.
2. Right-click on the Layer 1 icon. At the bottom of the context menu, you see the data plot list. The one checked is the active data plot.
3. Right-click on Layer 2 to view the list of data that is plotted in it.
4. Note that you can also select the **Data** menu to view the data plot list.

1. A fourth way is with the **Plot Setup** dialog.
2. With Graph2 still active, Right-click on the layer 1 icon to select **Plot Setup**.
3. In the opened **Plot Setup** dialog, expand the Plot List to see also the data in Layer 2. You can see the advantage here is that you can see data in all layers at once.



In order to show all three panels in **Plot Setup** dialog, please expand **Plot Type** panel by clicking  and expand **Available Data** panel by clicking  again.

Please refer to [Plotting using Plot Setup](#) for more information.

4. Uncheck the Show check box for the **Speed** data plot.
5. Click **OK**. This data plot is only hidden which is why the legend still indicates its presence in the layer.

The last way is from the **Plot Details** dialog.

1. Double-click on any of the line+symbol plots in Graph2.
2. Expand the tree so you see contents of both **Layer1** and **Layer2**.
3. Uncheck the **Speed** and **Power** data plots.
4. Click **OK**.

## 6.5.3 Merging and Arranging Graphs

### 6.5.3.1 Summary

The **Merge Graph Windows** dialog allows you to select which graphs you wish to combine, choosing from any graph in the project. It also has controls to specify how you want the individual graphs arranged on the new page.

The **Object Edit** toolbar allows you to quickly align and size multiple layers.

The **Layer Management** dialog lets you add, arrange and link layers on a single graph page.

### 6.5.3.2 What you will learn





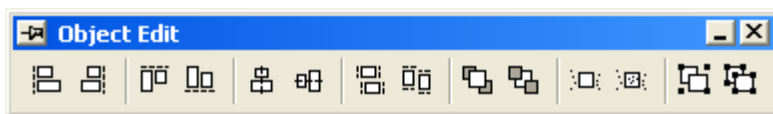

This tutorial will show you how to:

- Resize and align layers quickly
- Add a second axis using a nonlinear relationship with the primary axis
- Use Layer Management for more complex layer positioning and linking
- Merge multiple graphs into one graph

### 6.5.3.3 Aligning Layers using the Object Edit Toolbar

1. Select **File:Open** and open the OPJ **\Samples\Graphing\Layer Management.opj** and go to the subfolder **Arranging Layers**. (If you don't see the subfolders, click **View: Project Explorer** to open the Origin Project Explorer window.)
2. We want to use the **Object Edit** tools to rearrange the graph so make sure that this toolbar is visible. If it is not, you can open it from the **View: Toolbars** dialog box.



3. On the graph, hold the **Shift** key down and click on all four layers to select them as a group. Press the **Uniform Width**  and **Uniform Height**  buttons on the **Object Edit** toolbar to apply a uniform height and width. Then click on the white space in the layer to deselect all graph layers.
4. Hold **Shift** key to click and select the bottom two layers and then click the **Bottom**  button on the Object Edit toolbar to align them. Click on the white space in the layer to deselect all graph layers.
5. Hold **Shift** key to click and select the top two layers, then click the **Top**  button to align them. Click on the white space in the layer to deselect all graph layers.
6. Click and select the top and bottom in the left column, and click the **Left** align . Click on the white space in the layer to deselect all graph layers.
7. Click and select the two in the right column and click the **Right** align  button.
8. Do not save changes to your project, as the same project will be used later to demonstrate the usage of Layer Management.



The Object Edit toolbar provides a quick way to align and resize layers. The first layer you select is the reference layer and all others are adjusted relative to the first-selected layer. The **Layer Management** tool provides additional options such as layer reordering and linking.



Another way to select layers in a multiple layer graph is to press CTRL or SHIFT while clicking on the graph layer icons.

#### 6.5.3.4 Displaying Opposite Axes with a Nonlinear Formula

An Origin 2D graph layer is a set of X, Y axes, and opposite axes can be turned on for both X and Y. In addition, the opposite axes can also display labels using any user-specified nonlinear formula with respect to the primary axis.

1. Using the Project Explorer window, switch to the subfolder named **Nonlinear Axis**.
2. With the graph active, bring up the Layer Management tool by selecting **Graph: Layer Management**.
3. Switch to the **Axes** tab and expand the **Top** branch and check the **Axis**, **Title**, and **Tick Label** check boxes.
4. We want to display the labels on the top axis in units of Energy and the relationship between wavelength and energy is:

$$\text{Energy (eV)} = 1240/\text{Wavelength (nm)}$$

So in the **Formula** box, enter: 1240/x and click **Apply**, then click **OK** to close the dialog.

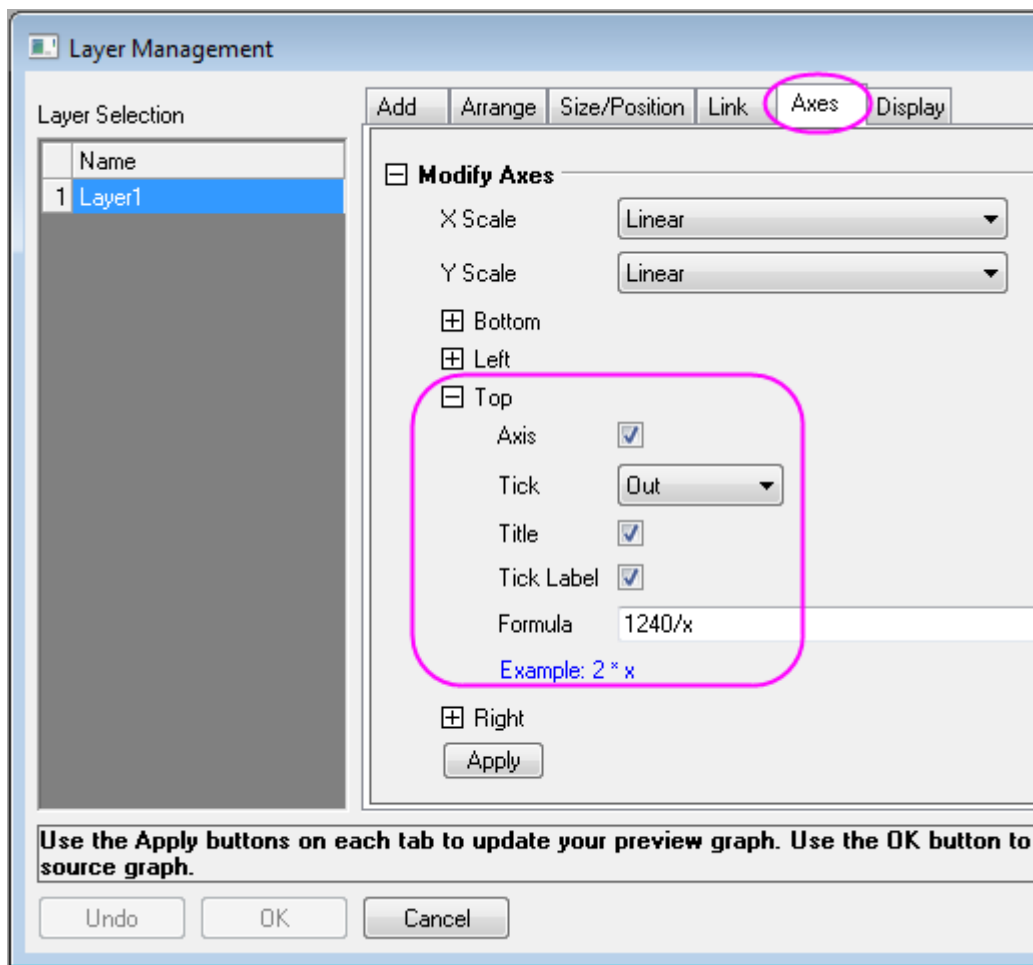



- If you are setting up a nonlinear relationship for the right Y-axis, in the **Formula** you still need to use **x** instead of **y**.
- You can also do similar settings in the **Axis** dialog to add such opposite axis:

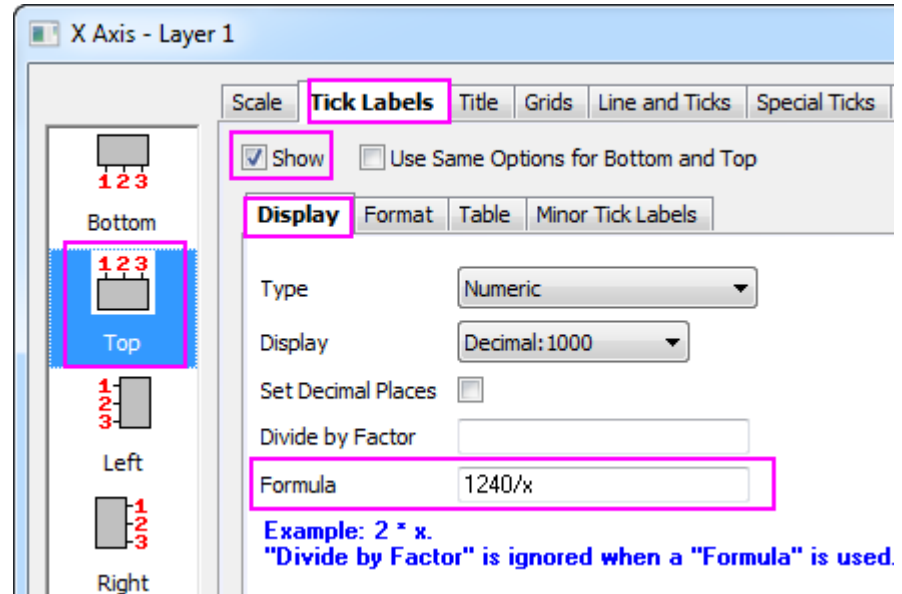

5. Double-click and edit the top X-axis title and change it to: Energy (eV)

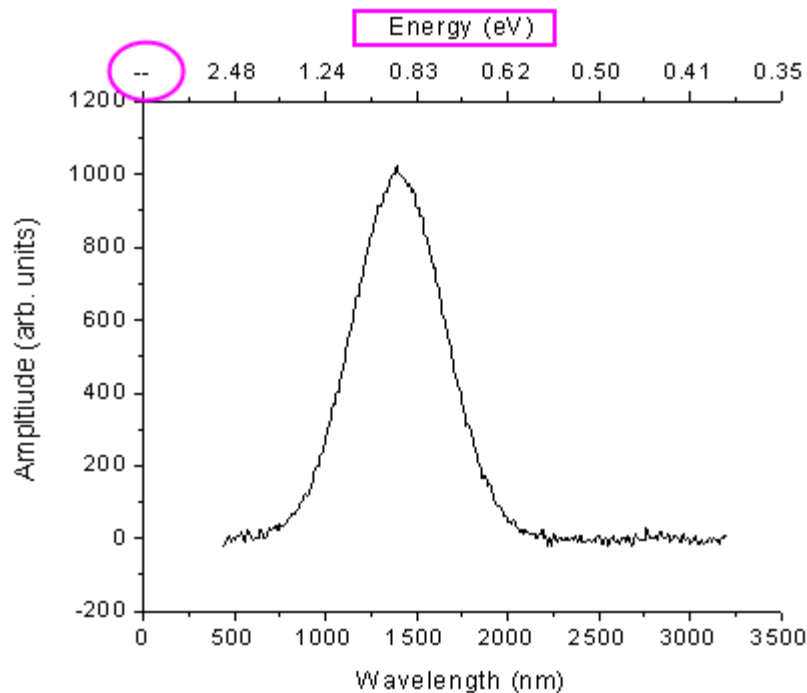

6. In the above image, the first tick label of the top axis is a missing value for energy that corresponds to zero wavelength. To hide it, double-click the top axis labels or axis, to open the Axis dialog. Go to the **Special Ticks** tab in **Top** icon. Then select **Hide** in the **Axis Begin** drop-down list. Click **OK** to apply the

settings and close the dialog.

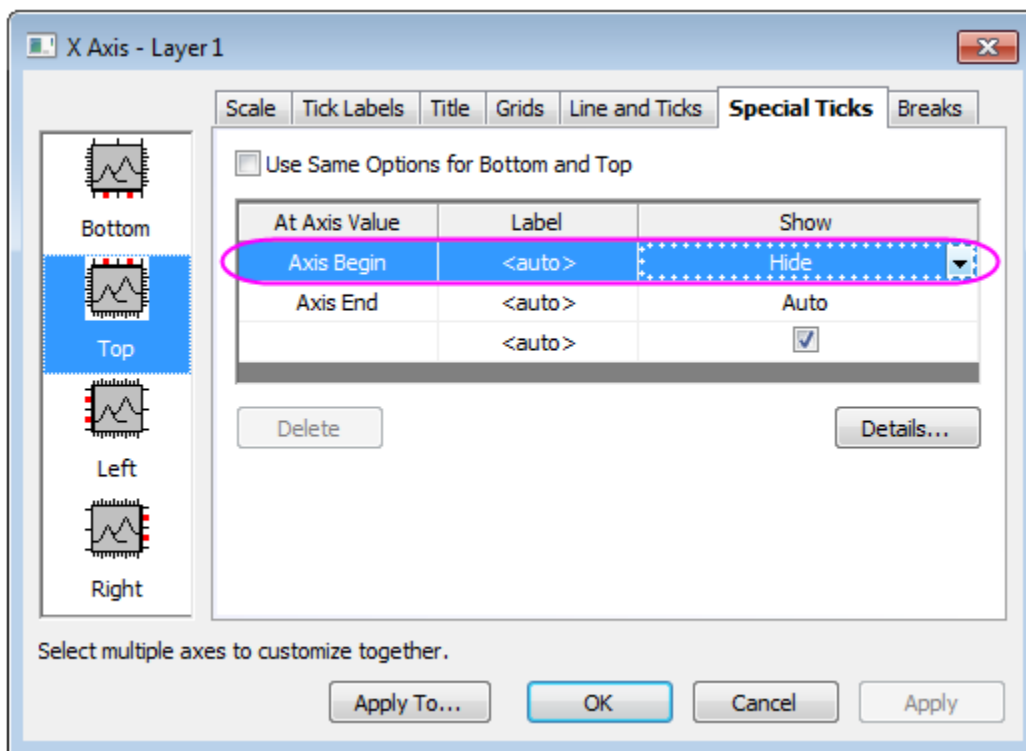

### 6.5.3.5 Using Layer Management to Link and Position Layers

The Layer Management tool can be used to position, resize, swap, and link layers:

1. Reopen the project **\Samples\Graphing\Layer Management.opj** and then switch to the subfolder named **Arranging Layers**. You can reopen the project by selecting **File: Recent Projects: Layer Management.opj**. Do not save changes to the project.
2. Bring up the **Layer Management** tool from **Graph: Layer Management**. In the left panel, rename the layers so that they are, top to bottom: Peak 3, Peak 2, Peak 4, Peak 1. The layer names now correspond to the legend for each layer.

**Note:** To rename a layer, double-click on the name.

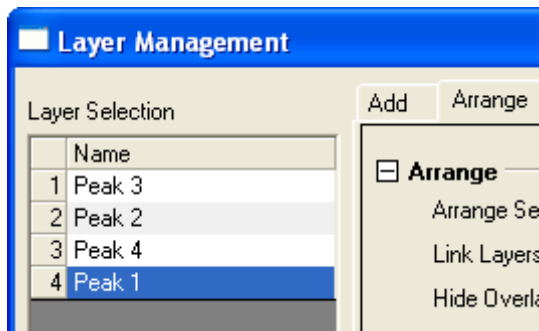



3. Now drag and arrange the list on the left so that they are ordered Peak 1, Peak 2, Peak 3, Peak 4. The layer number and names now match.

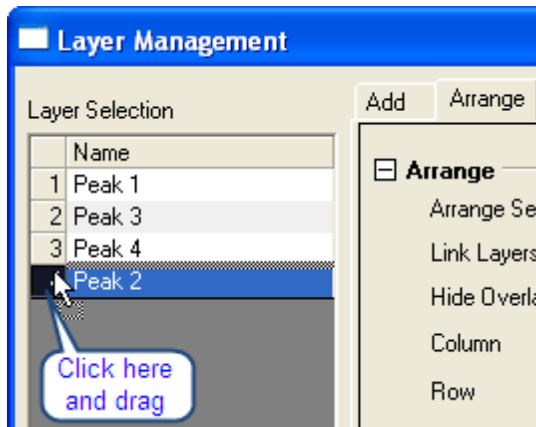

4. Now switch to the **Arrange** tab and do the following:
1. Check **Show Axes Frame**.
  2. Set **Horizontal Gap** and **Vertical Gap** to 0.

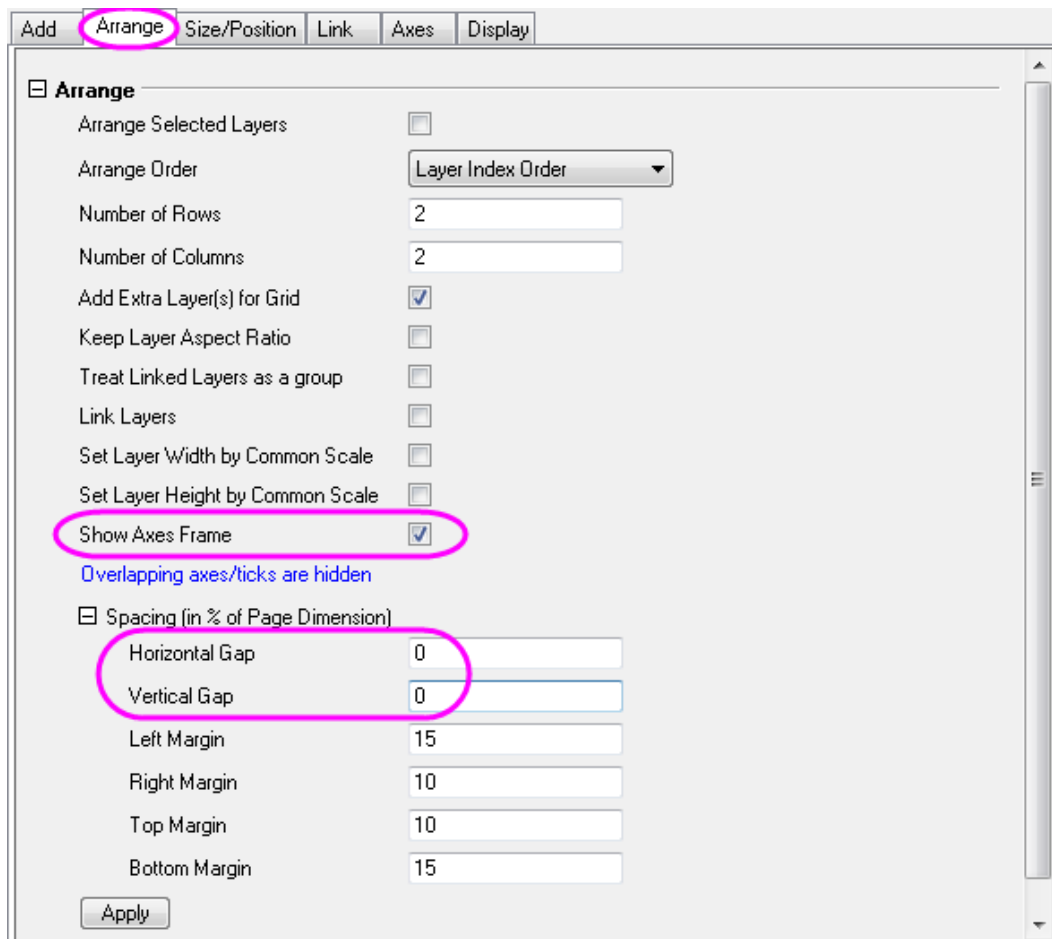

3. Click **Apply**.

This resizes and repositions the layers so they are aligned, and hides ticks and labels where layers overlap.

- Go to the **Axes** tab, hold down the **CTRL** key and select Peak 1 and 3 on left list, then expand the **Left** branch and set tick direction to **In**, and click **Apply**.

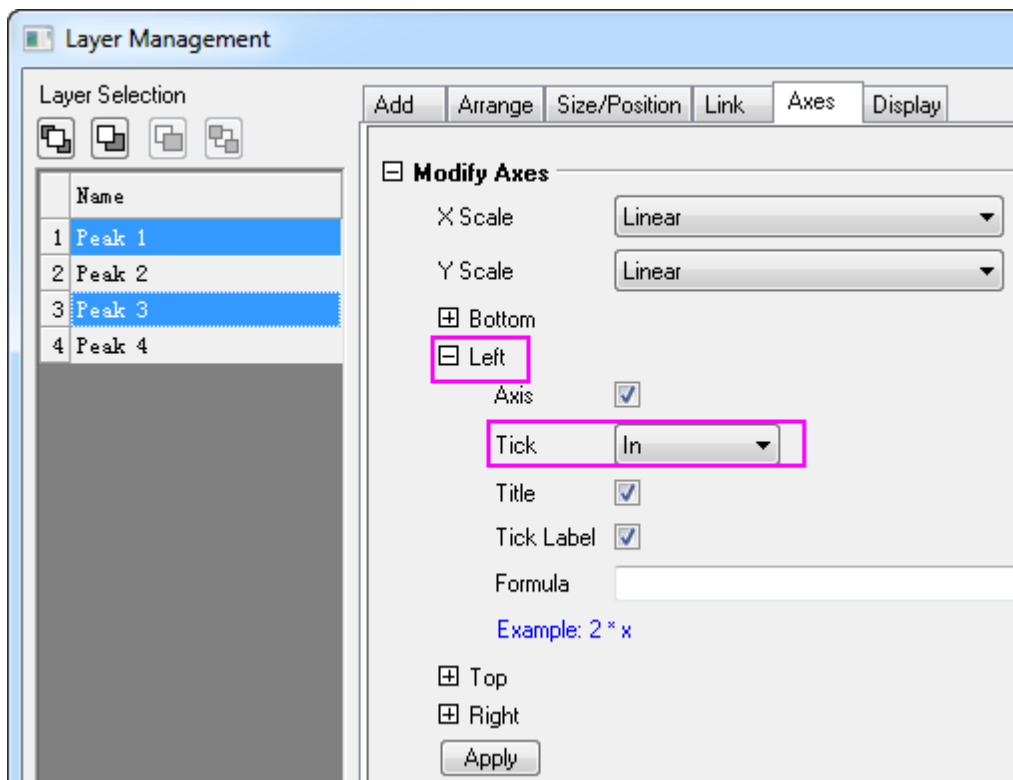

- Now select Peaks 3 and 4, set the **Bottom** tick direction to **In** and click **Apply**. Then select Peaks 1 and 2, set the **Top** ticks to **In** and click **Apply**.
- go to the **Link** tab and select Peaks 2, 3, and 4 in the left list and link them to layer 1, making sure you have the X-Axes linked **Straight(1 to 1)**, and click **Apply**.

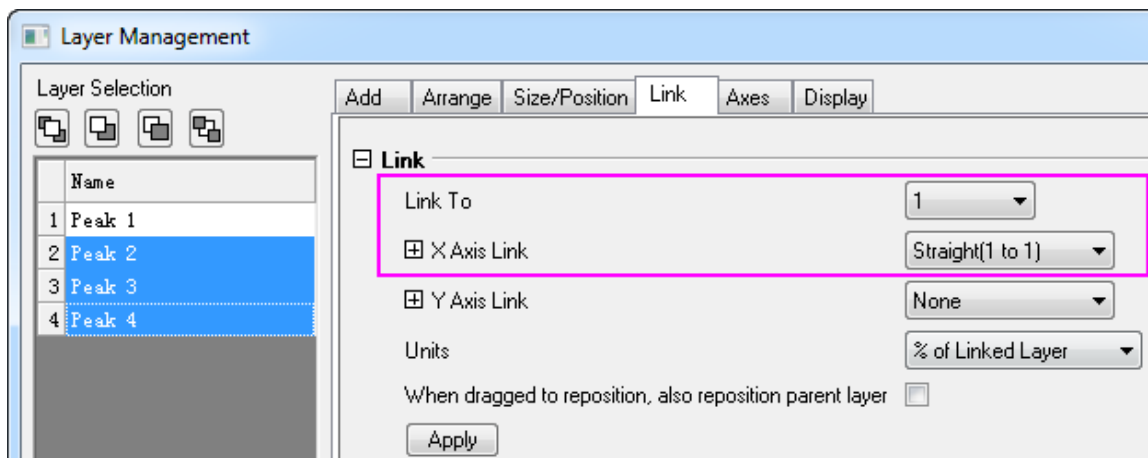

Click **OK** to close the dialog box.

- Click and select the top left layer, layer 1, then drag and resize the layer, then move the layer. Note that the child layers resize and move too, since they are dimensionally linked to layer 1.

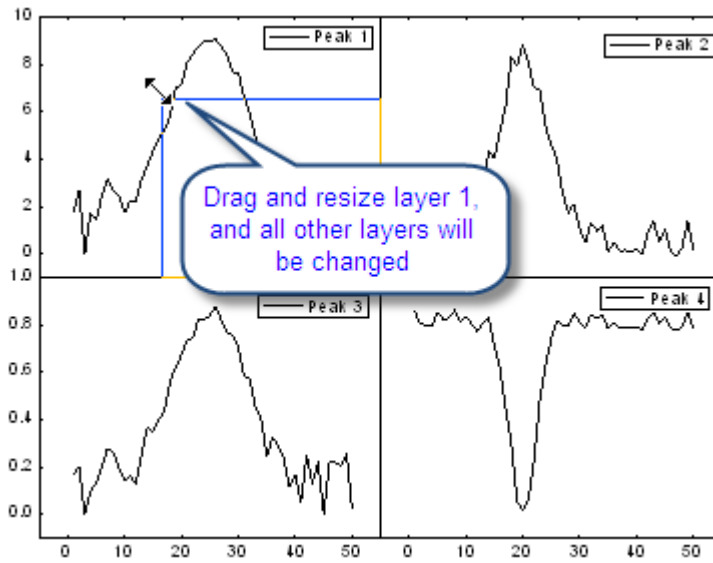

- Go to the top left layer (layer 1), and double-click the top X-axis. In the X-Axis dialog, change the X-Axis scale From 10 To 35, and click **OK**. You'll see that all the other layers now display the same X-axis scale range.

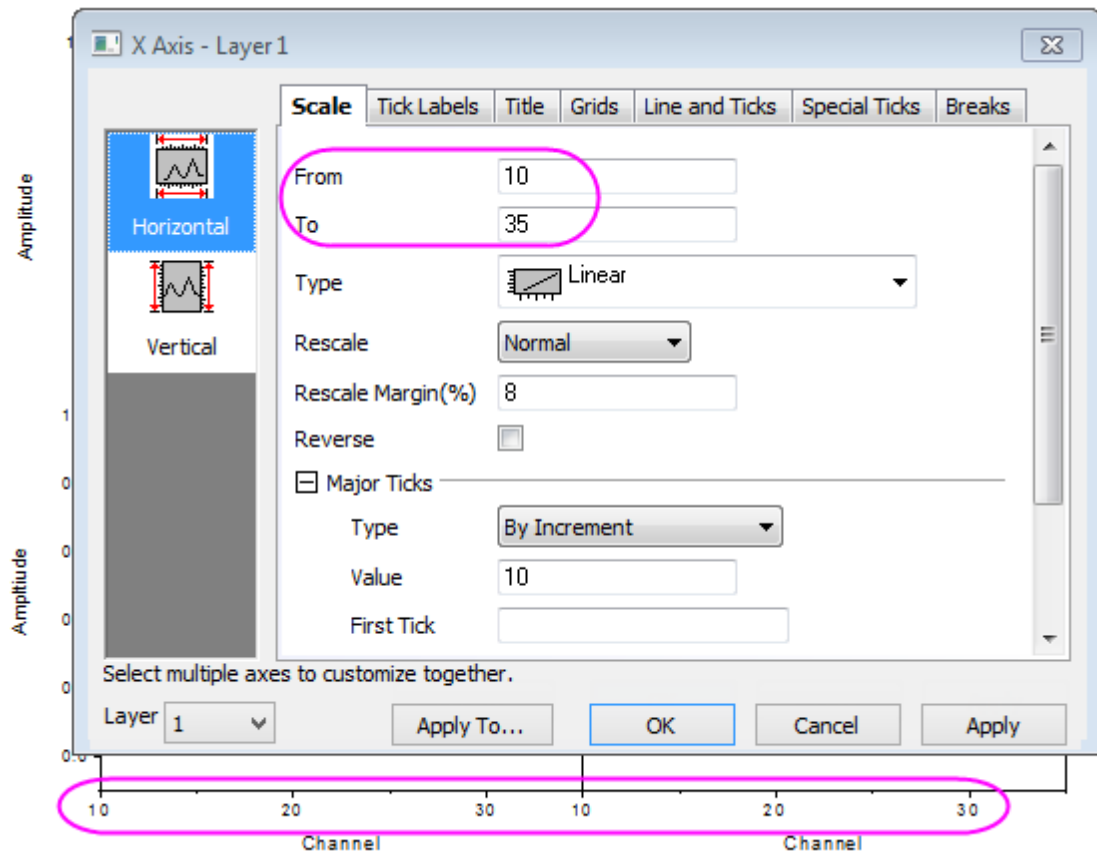



If the layers are linked, they are treated as one unit. If you need to rearrange layers, you should first unlink them. You can re-link layers after arranging.

#### 6.5.3.6 Merge Multiple Graphs

In this section, we merge two graphs from different subfolders of the same project while treating the four layers in one graph as a unit.

1. Click on the **Rescale** button when the Graph 1 in the **Arranging Layers** subfolder is active.
2. Select **Graph: Merge Graph Windows** in the main menu to open the dialog.
3. Do the following:
  - Click the triangle button to the right of **Graphs** and from the flyout menu choose **All in Project**. **Graph1** and **Graph2** will show in the **Preview** panel (not shown).
  - Make sure **Number of Rows = 2** and **Number of Columns = 1**.
  - Make sure **Treat Each Source Graph As a Unit** is selected.
  - Set the **Vertical Gap** to **20**.

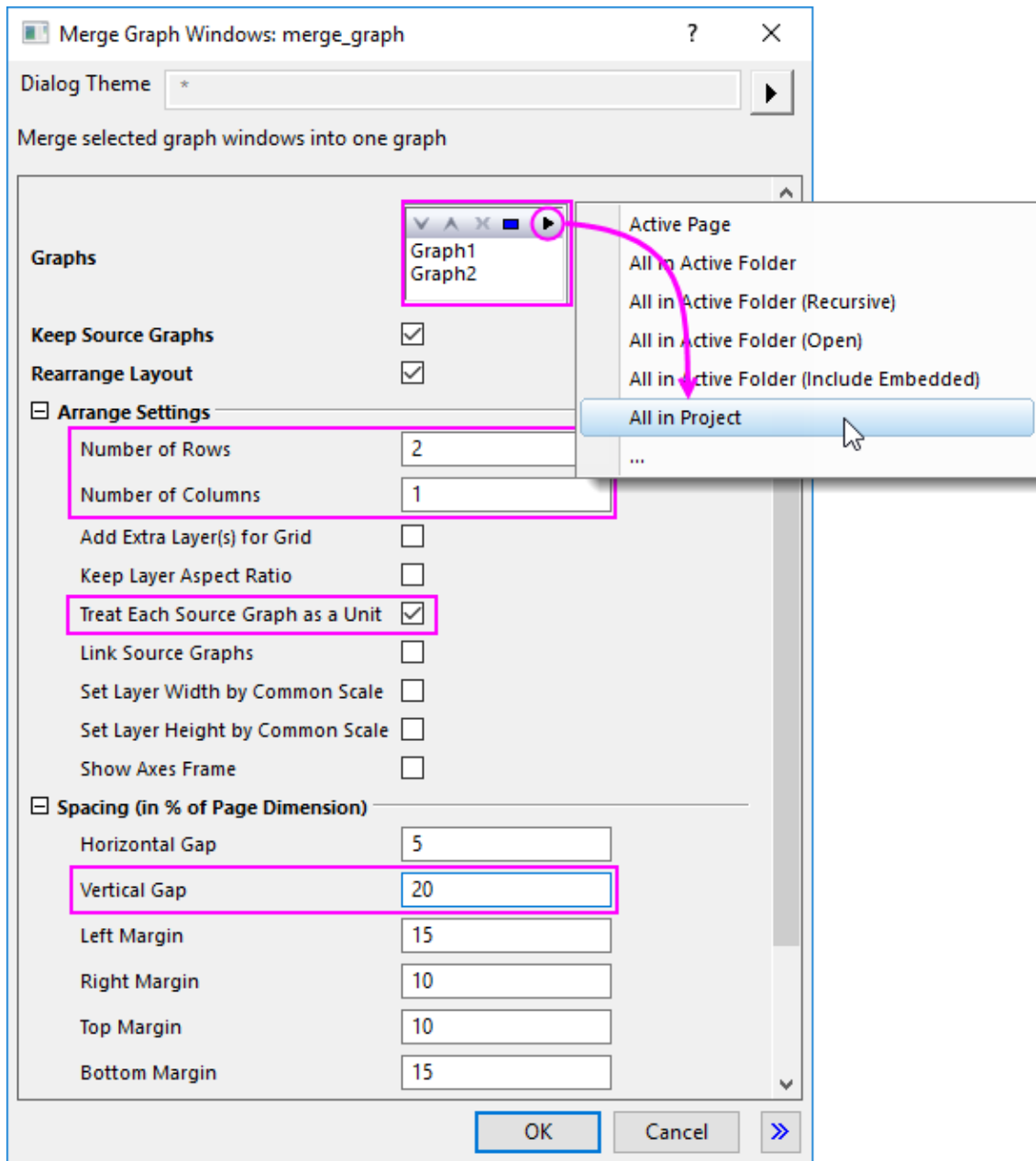

4. Click **OK** to close the dialog box. A new merged graph page is created:

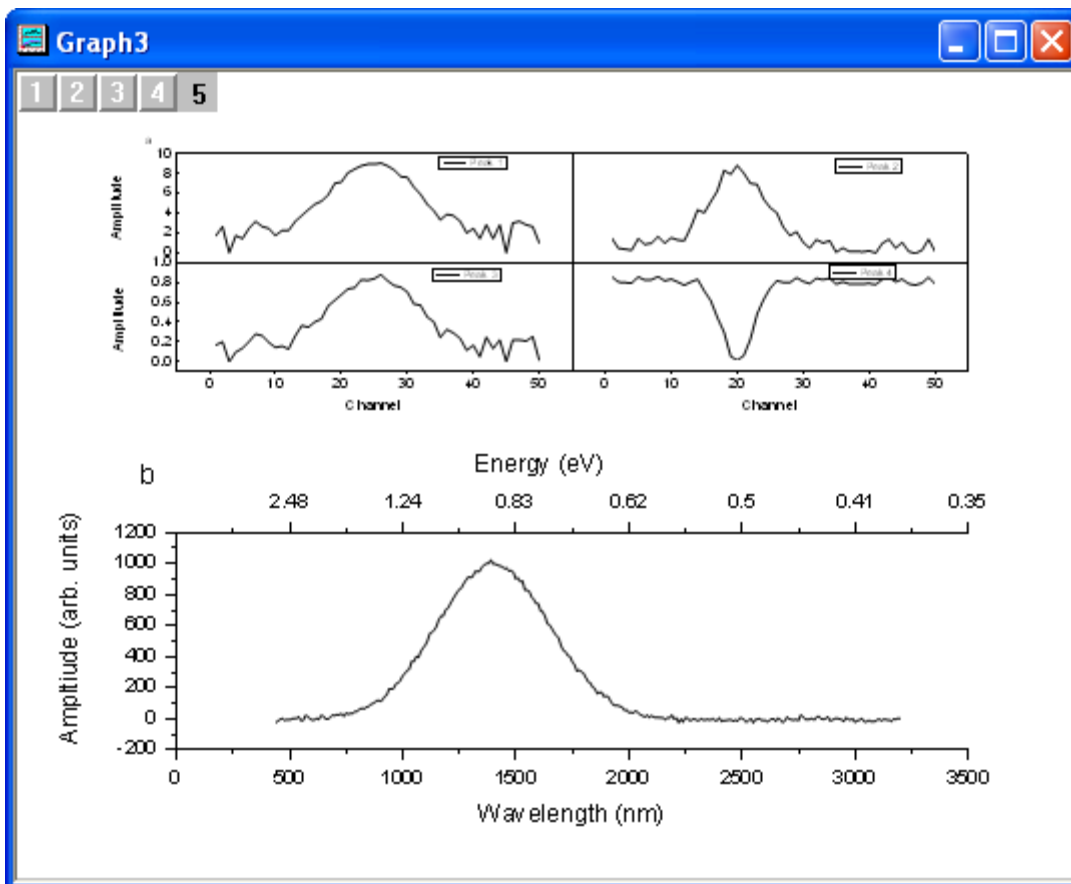

## 6.5.4 Multiple Layers with Linked Axis

### 6.5.4.1 Summary

This tutorial will show how to merge four graphs to one graph, which contains multiple layers with linked axis.

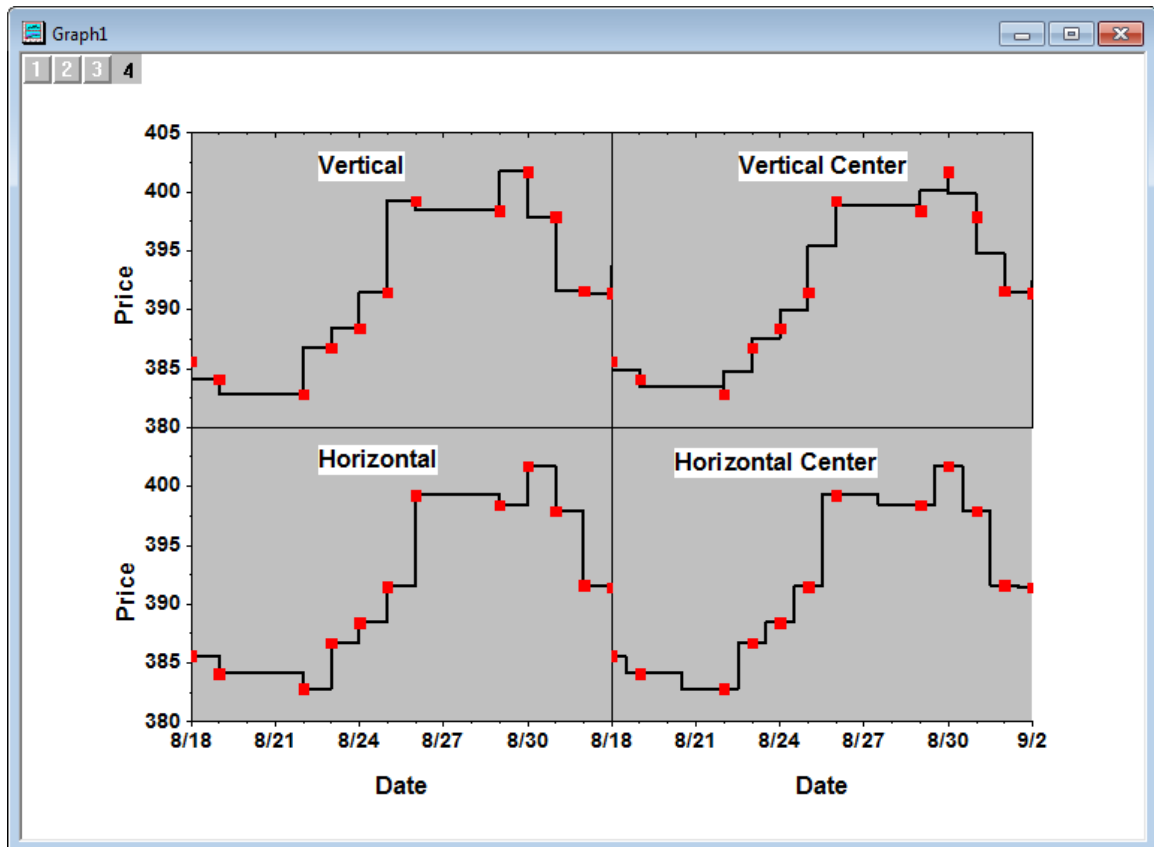

Minimum Origin Version Required: Origin 2015 SR0

#### 6.5.4.2 What you will learn

- How to make a Line + Symbol plot
- How to merge graphs
- How to link axis of layers
- How to customize axis

#### 6.5.4.3 Steps

This tutorial is associated with the Tutorial Data project: <Origin EXE Folder>\Samples\Tutorial Data.opj.

1. Open the **Tutorial Data** project and browse to folder *Multiple Layers with Step Plot* in **Project Explorer**.
2. Activate the workbook and highlight column Value1 and make a graph by selecting Origin menu **Plot > Basic 2D : Line + Symbol**.
3. Activate the graph, right-click the legend and choose **Properties** from the context menu. In the **Object Properties** dialog,
  - In the **Text** tab, put this text in the text field:  $\backslash b(\textit{Vertical})$  and set **Size** to 36.
  - Go to the **Frame** tab, and set as following image. Click the **OK** button. Move the legend to the correct position.

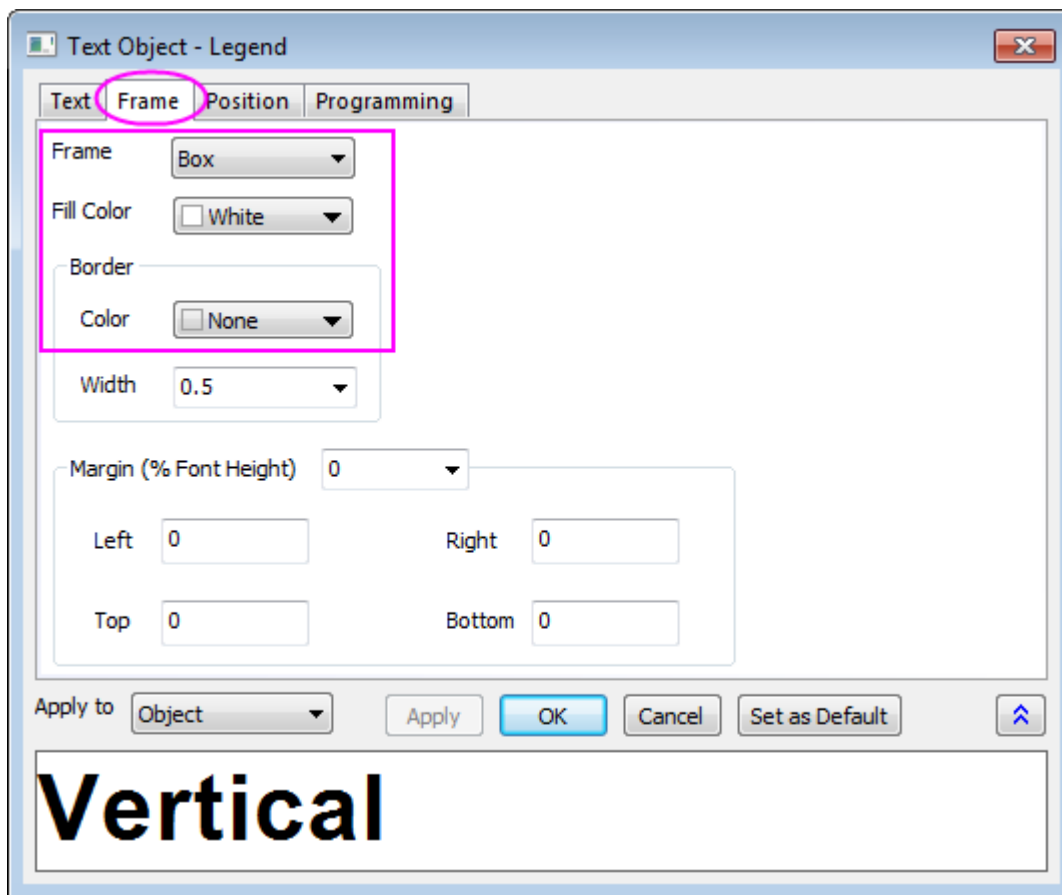

4. Double click on the open white space in layer of the graph to open the **Plot Details** dialog. In the left panel, select **Layer1**. Activate the **Background** tab in the right panel, choose *LT Gray* for the **Color**. Then select the plot in **Layer1** from the left panel, under the **Symbol** tab in the right panel, set **Size** to 15 and **Symbol Color** to red. Switch to the **Line** tab, choose **Step Vert** from the **Connect** drop-down list and set **Width** to 4 and click **OK** to apply settings.



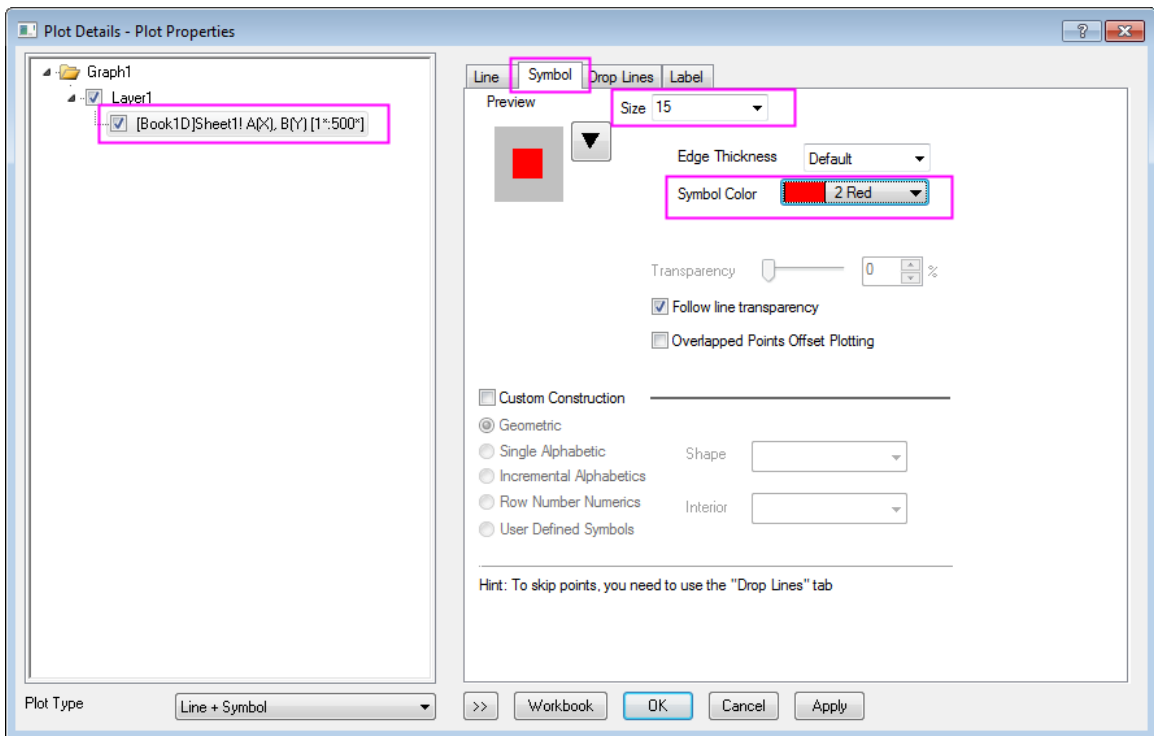
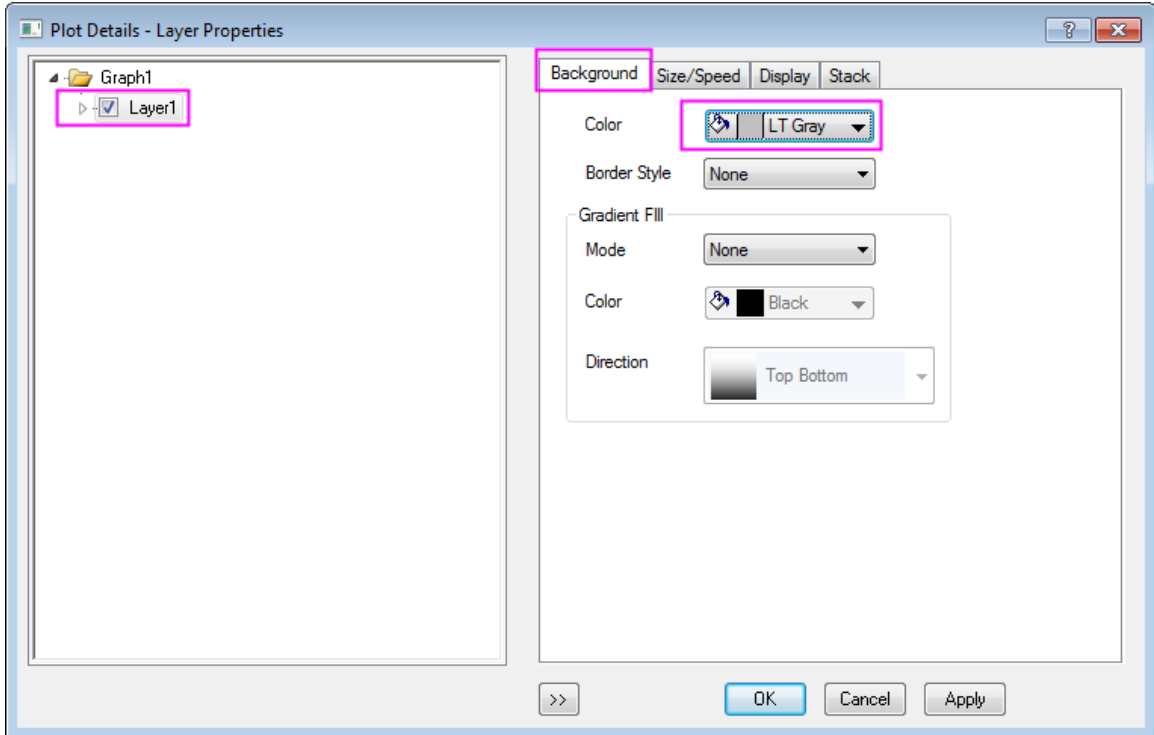

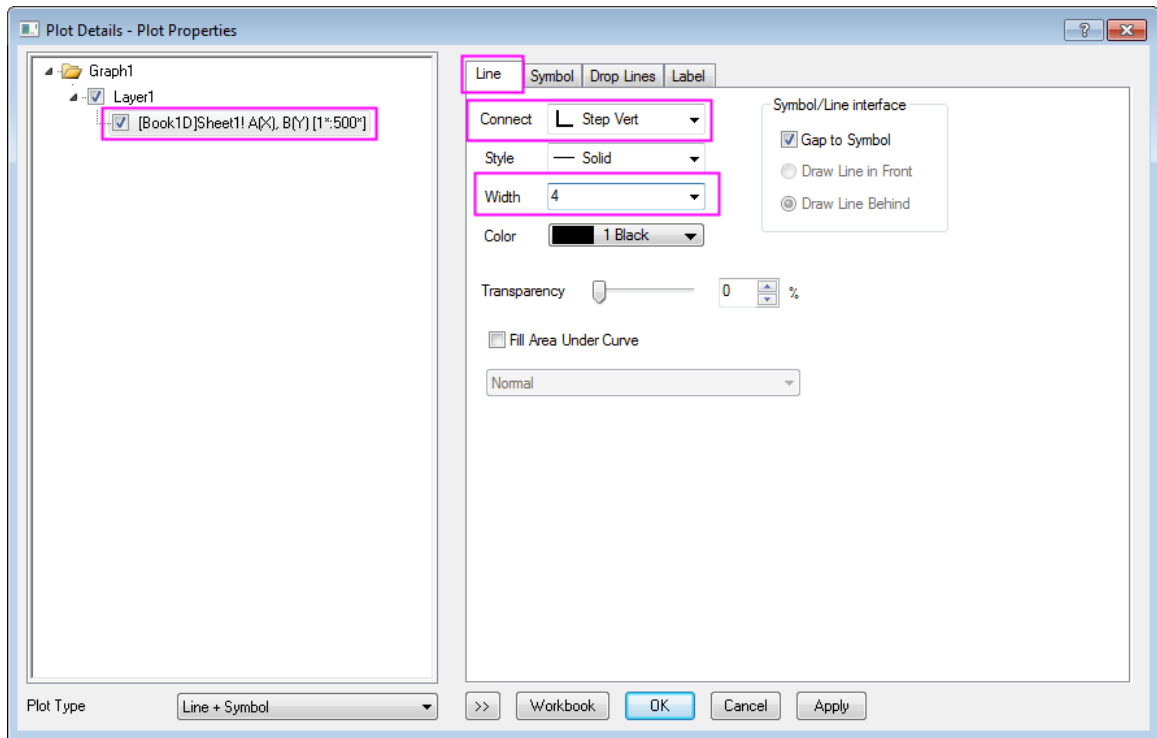

- Now we are going to duplicate similar graphs from the other three columns. Right click on the graph window title bar and select **Duplicate (Batch Plotting)** from the context menu:

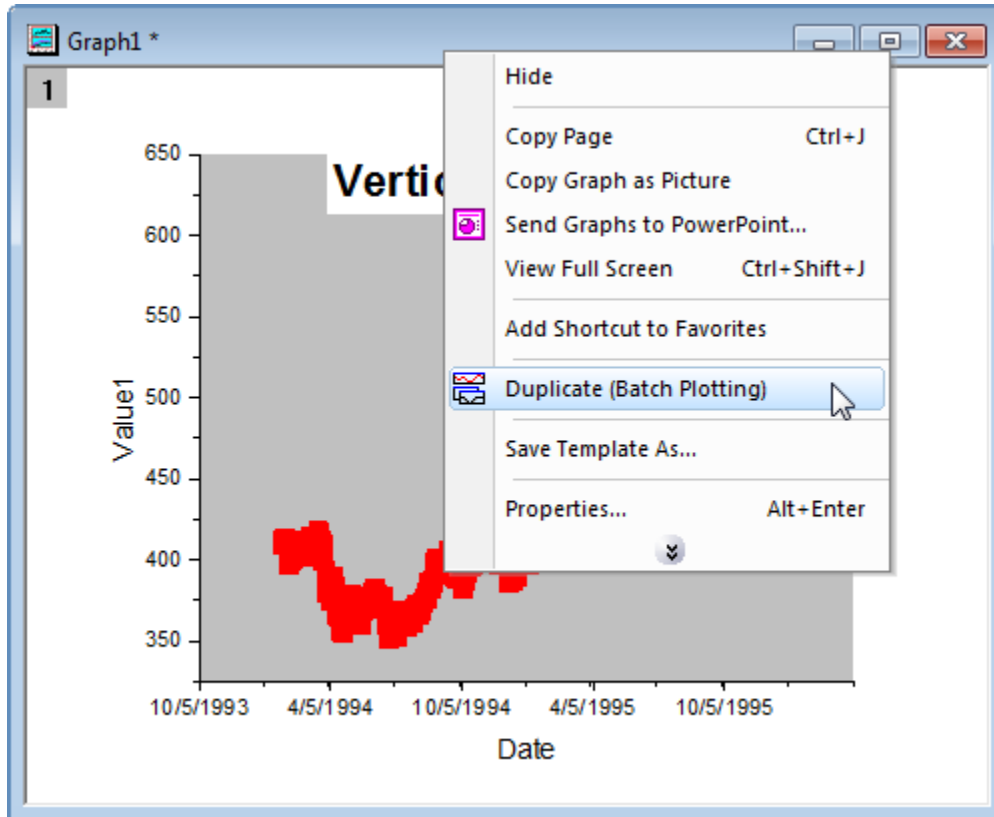

6. In the dialog that opens, select **Column** from the **Batch Plot with** drop-down list, hold Ctrl key and click to select all three columns C, D, E and click OK:

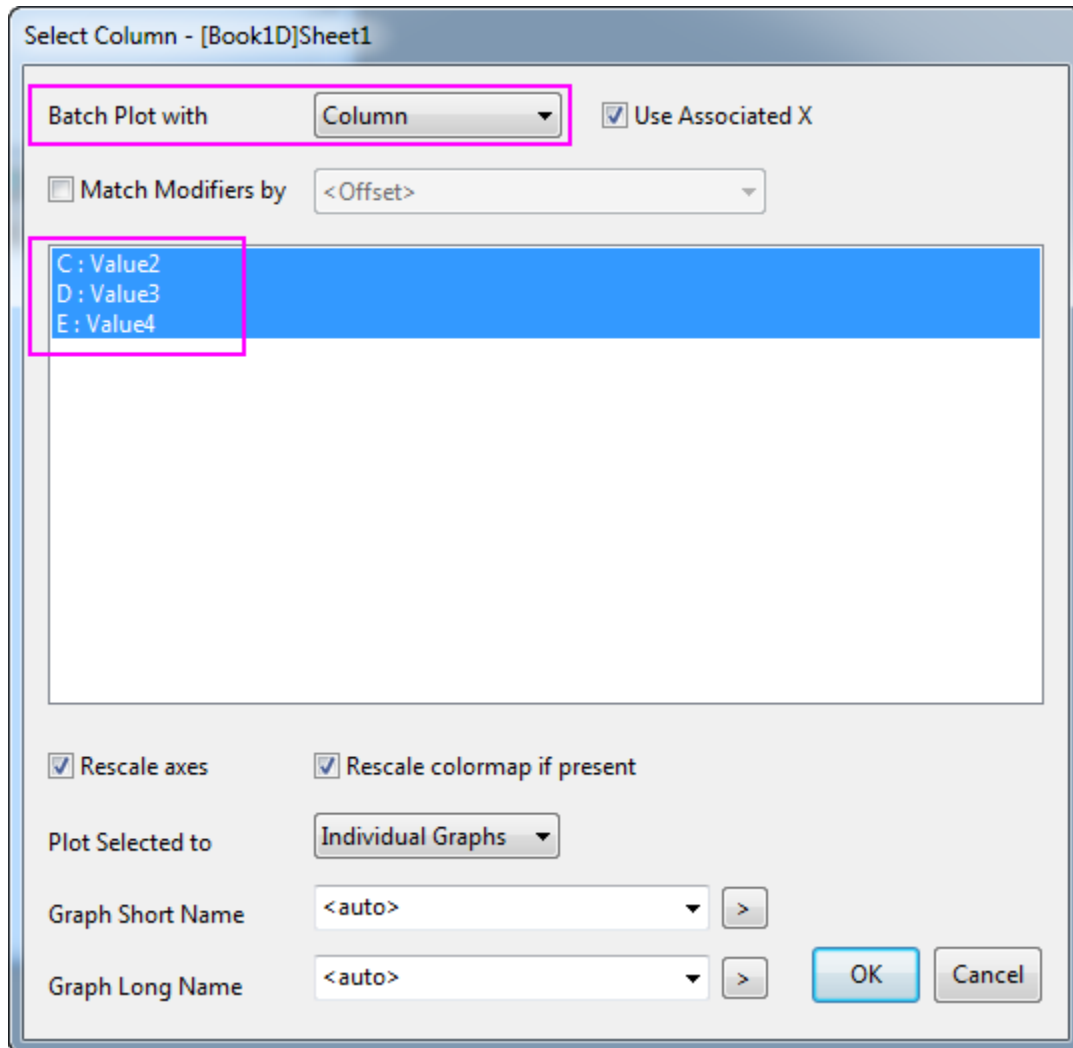

7. For graph from each column, the legend text and **Connect** drop-down list will be different, listed below.

For column **Value2**:

legend text = \b(Vertical Center)

**Connect** = Step V Center

For column **Value3**:

legend text = \b(Horizontal)

**Connect** = Step Horz

For column **Value4**:

legend text = \b(Horizontal Center)

**Connect** = Step H Center

8. Activate a graph and then select Origin menu **Graph: Merge Graph Windows** to open the **merge\_graph** dialog. Change the settings as the following image shows. Then click the **OK** button to merge these graphs.

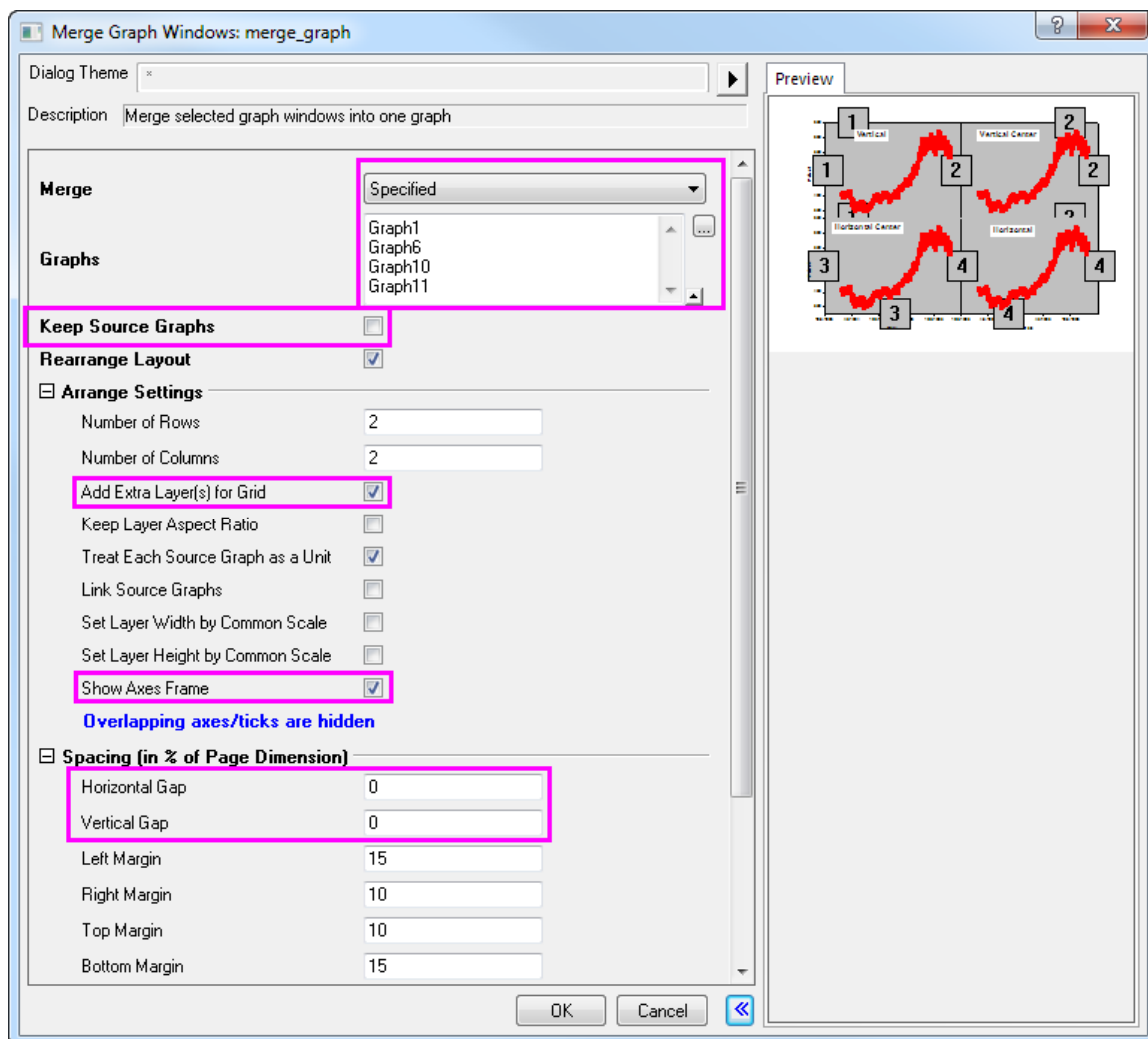

9. Activate the new merged graph, choose Origin menu **Graph: Layer Management** to open the **Layer Management** dialog. In the **Layer Selection** panel, rename the layers by double clicking on the name and reorder the layers by clicking on the layer index and dragging up and down. Make sure the final layers' names and order are the same as the image shows below (In the **Preview** panel, the layers' indices and positions can be shown).

Layer Management

Layer Selection

Name
1 Vertical
2 Vertical Center
3 Horizontal
4 Horizontal Center

Rename and reorder layers

Modify Axes

X Scale: Linear

Y Scale: Linear

Value1

Value3

Date

Tick: None

Title:

Tick Label:

Formula:

Example:  $2 * x$

Right

Use the Apply buttons on each tab to update your preview graph. Use the OK button to apply changes to the source graph.

Undo OK Cancel

Click this button to show or hide Preview panel

- In the **Layer Selection** panel, press **Ctrl** key on the keyboard to select the following layers: *Vertical Center*, *Horizontal* and *Horizontal Center*. Go to the **Link** tab, select **1** from the **Link To** drop-down list. Then both **X Axis Link** and **Y Axis Link** are set to **Straight(1 to 1)**. Then click the **Apply** button.

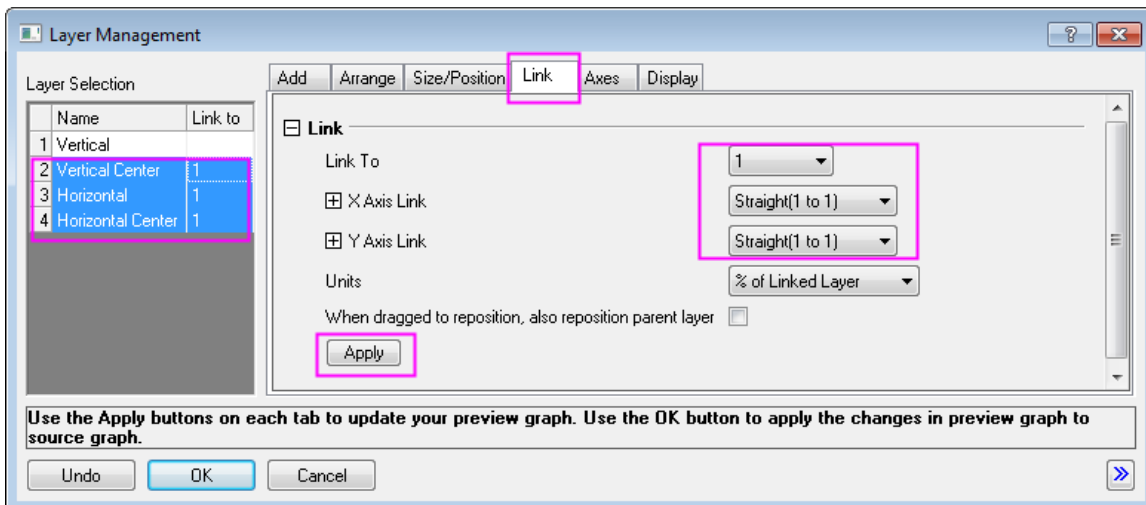

- Go to the **Axes** tab, select *Vertical* layer from the left panel, then check all **Axis** check-boxes under **Bottom** branch, **Left** branch, **Top** branch and **Right** branch. Also, select *In* for **Tick** drop-down list under **Top** branch. Click the **Apply** button.

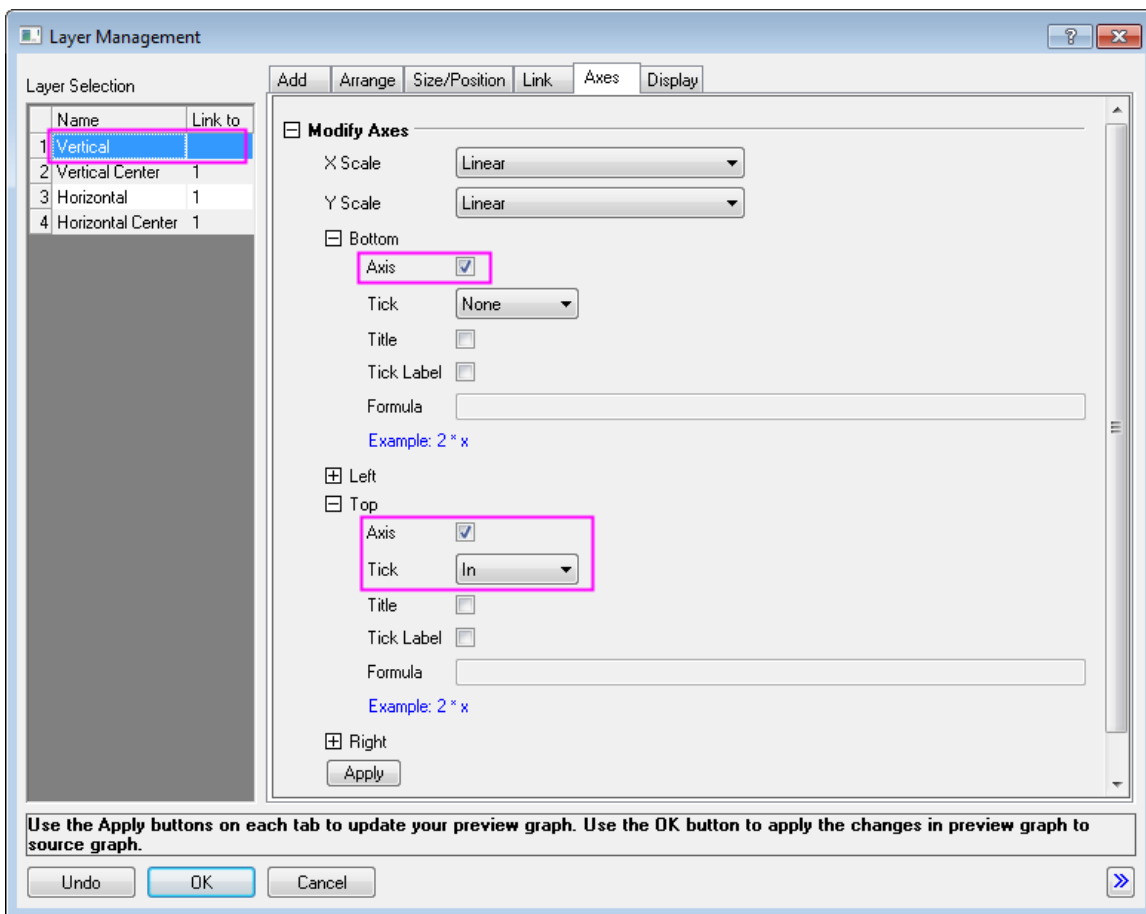

- Select *Vertical Center* layer, in the **Axes** tab, **Bottom** branch, **Left** branch and **Right** branch share the same settings. And settings for **Top** branch shows in the image below. Click the **Apply** button.

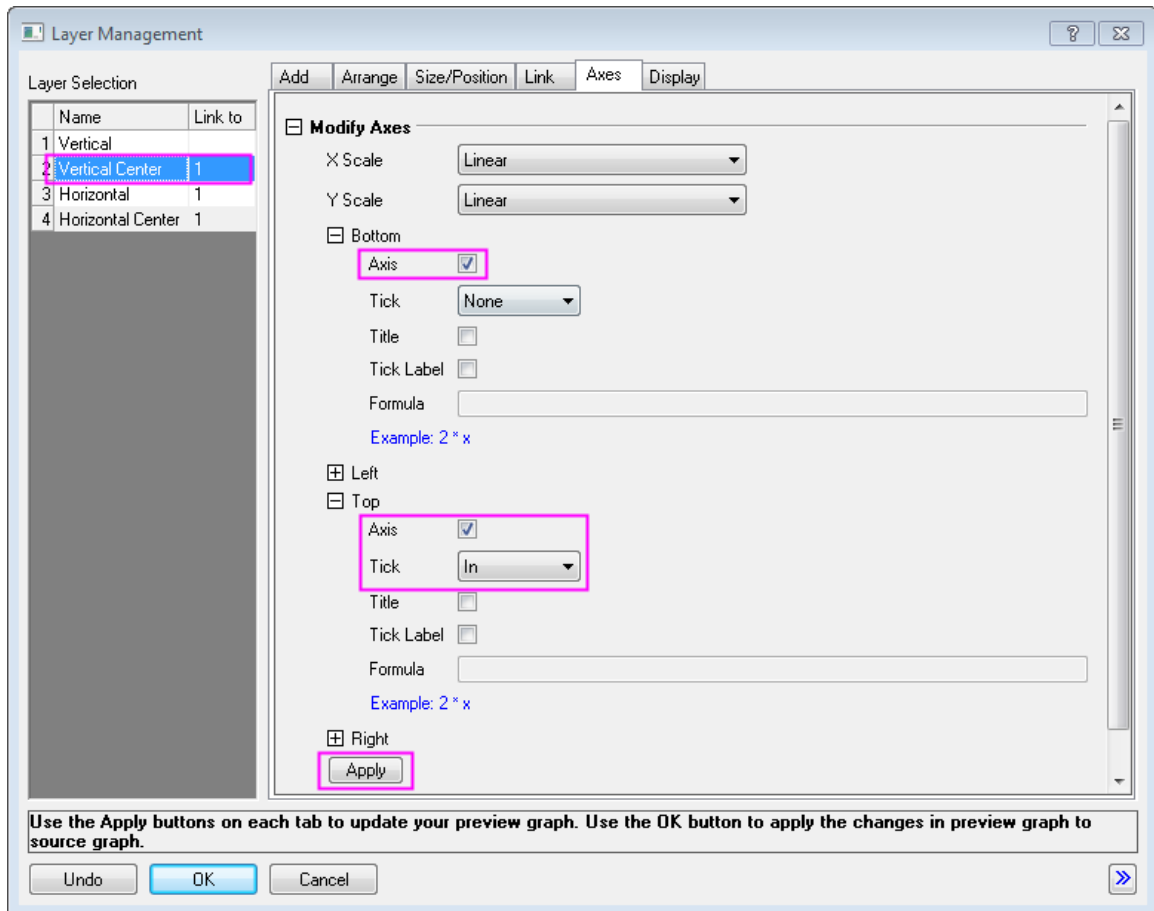

13. Select *Horizontal* layer, in the **Axes** tab, check the **Axis** check-boxes under both **Top** branch and **Right** branch. Click the **Apply** button.

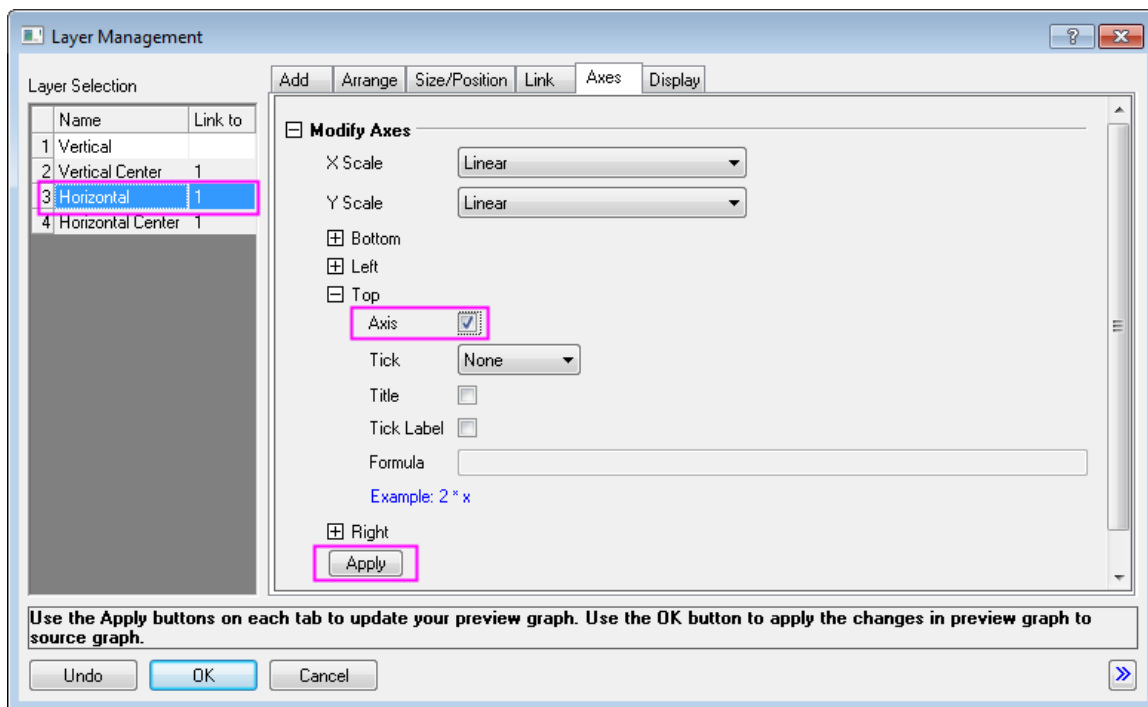

14. Select *Horizontal Center* layer, in the **Axes** tab, check the **Axis** check-box under **Top** branch. Click the **Apply** button.

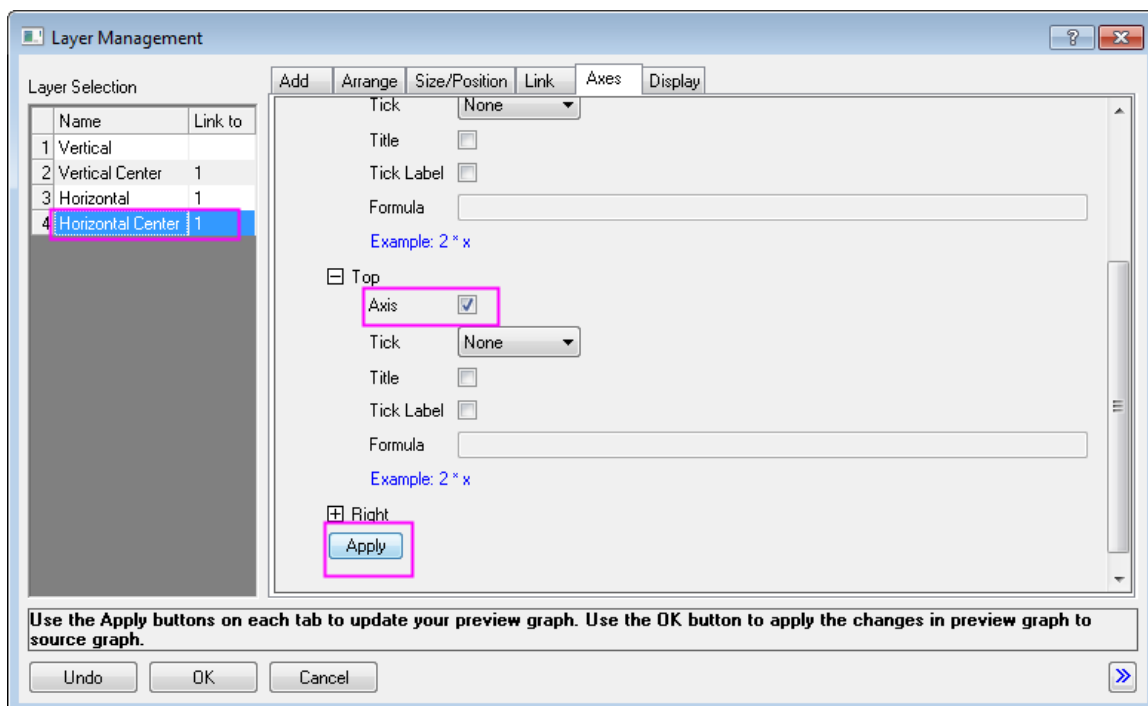

15. Click the **OK** button to close the **Layer Management** dialog.



16. Double click on the X axis of the lower-left layer to open the **X Axis** dialog. In the **Scale** tab, change the axis scale as the image below:

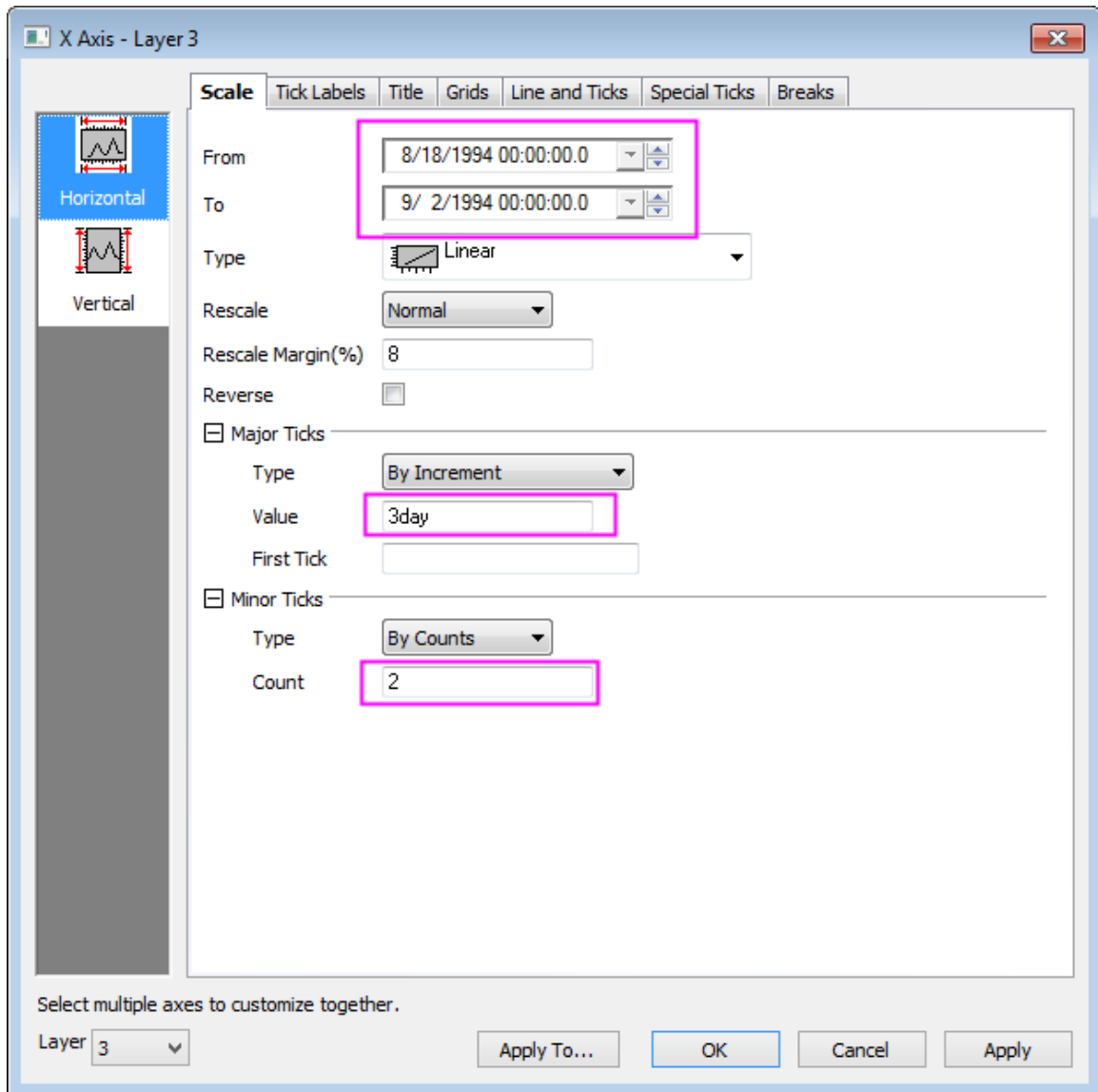

17. Click the **Vertical** icon on the left panel to go to **Scale** tab for **Y Axis** and change the axis scale:

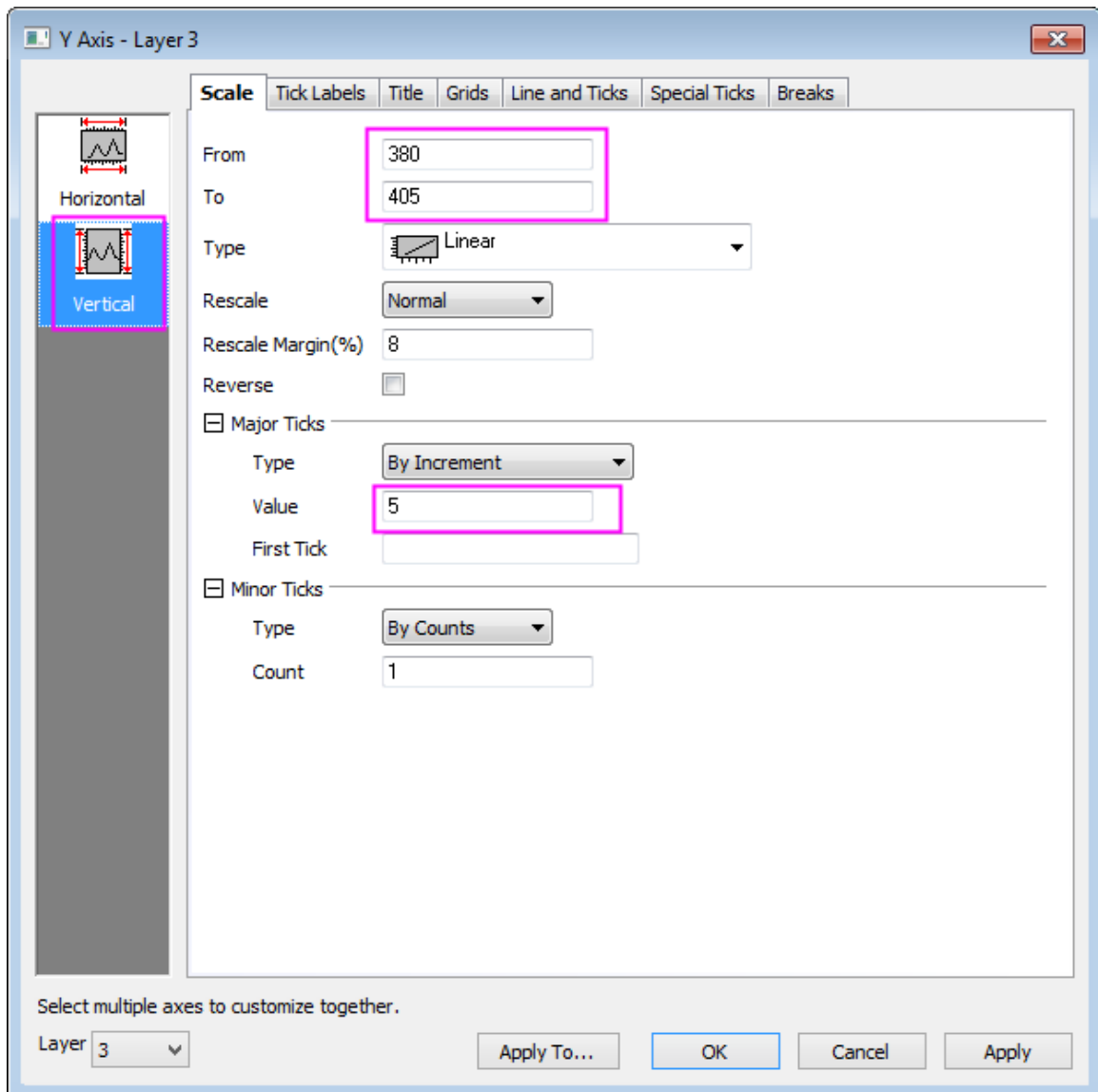

18. Go to **Tick Labels** tab and click **Bottom** icon on the left panel and change the display of X tick labels:

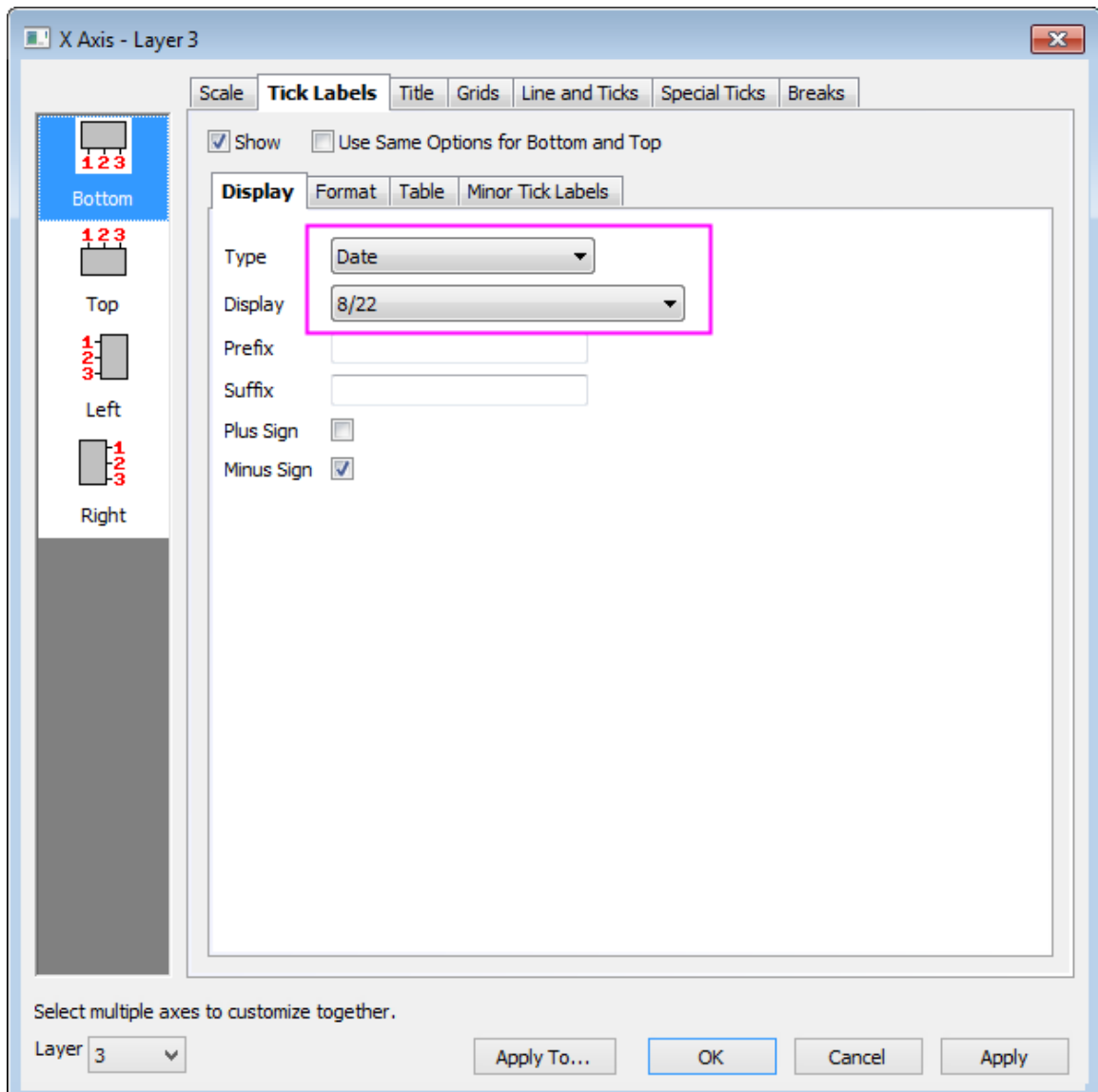

19. Go to **Special Ticks** tab and hide the label at axis end by selecting **Hide** from **Show** drop-down list for **Axis End**:

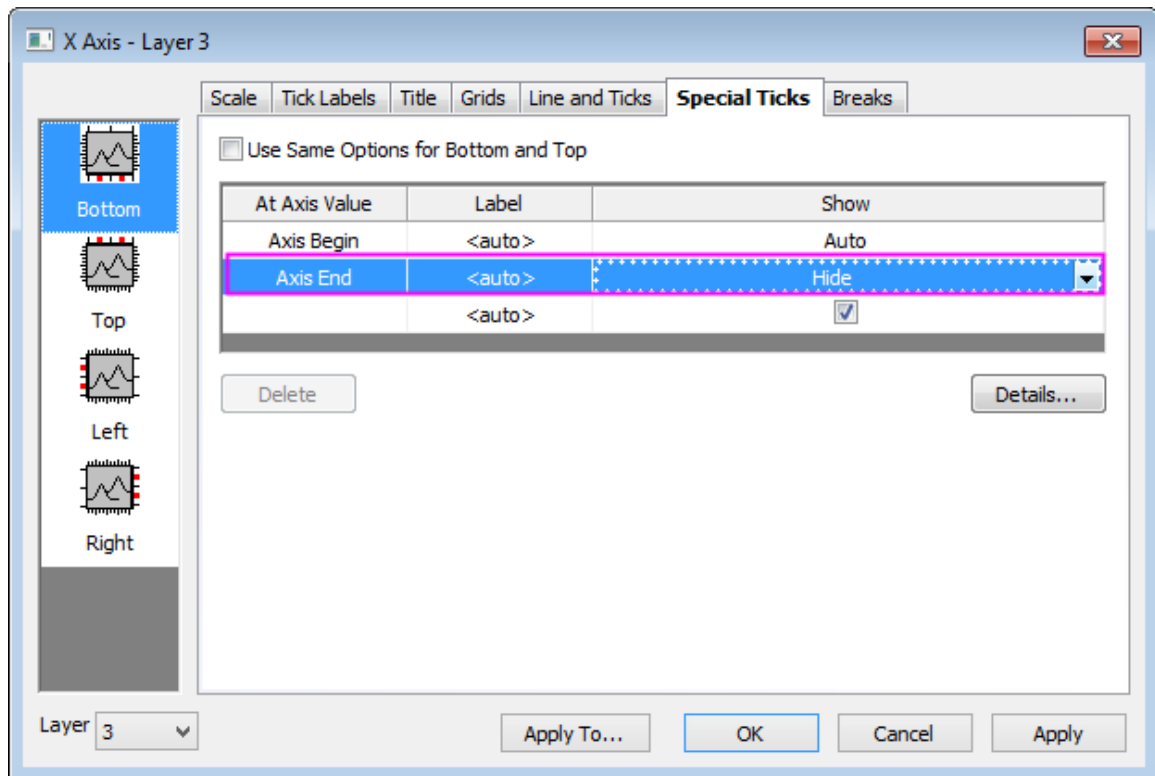

20. Click on the **Left** icon on left panel, and hide the label at Y axis end by selecting **Hide** from **Show** drop-down list for **Axis End**.
21. Repeat step 16 to step 18 for the X axis of the lower-right layer.
22. Double click on the axis of lower right X axis, go to **Tick Labels** tab and **Format**, change the **Size** to be **30** and check **Bold** box.
23. Click on the **Apply To...** button on the bottom, in the bring up **Apply To** dialog.
24. Check **Size** and **Bold** boxes under **Tick Labels** node and select **This Window** from the drop-down list for both and click **OK** to apply the settings so that all axes' tick label size is set to be 30 now.

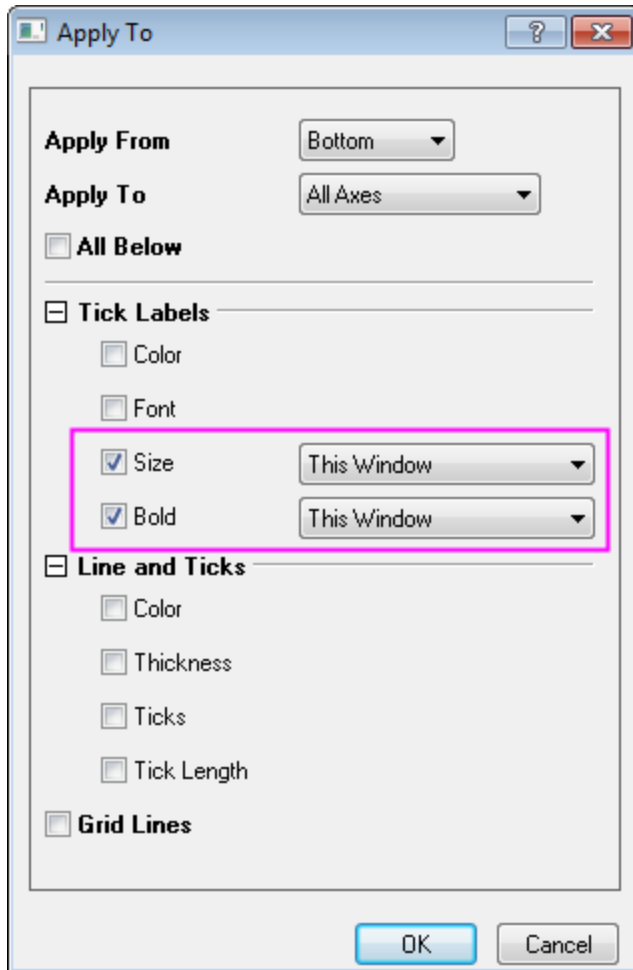

25. Change the both Y titles to *Price* and make them bold.

## 6.5.5 Multi Layer Graph Customization

### 6.5.5.1 Summary

The **graph layer** is the basic building block of all Origin graphs. A graph layer consists of a set of coordinate axes and (usually) one or more data plots, plus attached axis titles, plot legends, text labels, drawn objects, button objects, etc. The graph layer can be moved to any location or resized to any dimensions within the graph window. An Origin graph window contains between 1 and 1,024 graph layers.

When working with graphs that contain multiple layers, it helps to have some tools and a strategy for applying customizations to multiple layers a time, as opposed to simply modifying each plot or each axis scale individually. Beginning with Origin 2018b, you can edit multiple graph layers simultaneously using the Plot Details **Layers** tab **Common Display** controls.

Minimum Origin Version Required: Origin 2018b

### 6.5.5.2 What you will learn

- How to control the scaling of elements (axis titles, tick labels and graph legends) when graphs are merged.

- How to merge graph windows containing a single layer into a multi-panel graph.
- How to configure the merged graph so that plot or axis customizations made in one layer are applied to all layers.
- How to fix scaling issues with fonts in merged graphs.
- How to remove white space from the merged, multi-panel graph.
- How to remove unneeded legend objects and customize one object so that it serves as a legend for the multi-panel graph.

### 6.5.5.3 Steps

1. Start a new project. Press **F11** to open **Origin Central**, click the **Graph Samples** tab, set the graph drop-down list to **Multi-Panel Graphs** and double-click on the **Multiple Panel Graph from Index Data**.

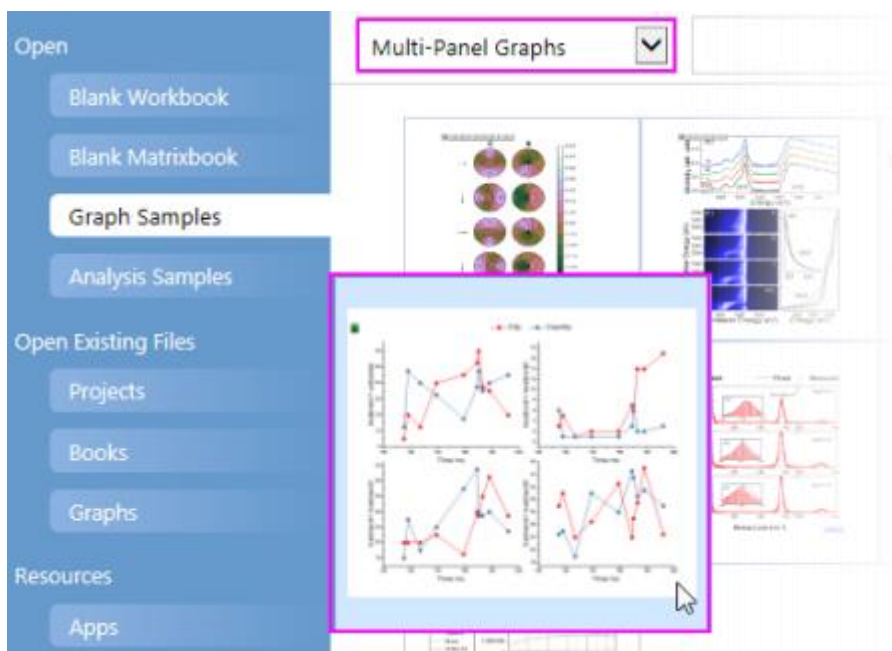

2. In the worksheet that opens, click on the **Output Data** tab and resize the window so that you can see all 12 columns of data. Note that the column headings have (1) a green lock on them, indicating that these are calculated values and (2) the [column designations](#) repeat in the pattern  $X1, Y1, Y1, X2, Y2, Y2$ , etc.
3. Select columns  $B(Y1)$  and  $C(Y1)$  and click the **Line + Symbol** button  on the **2D Graphs** toolbar. Repeat the process for columns  $E(Y2)+F(Y2)$ ,  $H(Y3)+I(Y3)$ ,  $K(Y4)+L(Y4)$ . You should now have 4 similar graph windows, each containing a single graph layer with two plots (Note that you don't need to select the X column when making these graphs because Origin's default behavior is to plot Y values against any X column immediately to the left of selected Y columns).

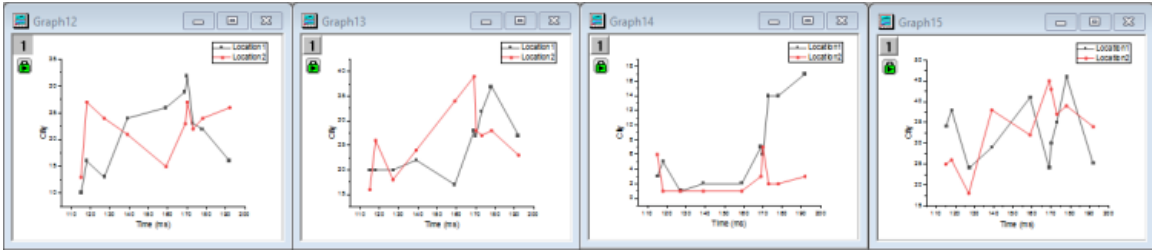

### 6.5.5.3.1 Scale Elements

We are going to merge the above graph windows into a single 4-panel graph window but before we do that, we will briefly discuss element (axis titles, graph legends, etc.) scaling so that we understand how to control this in a merged graph.

1. Click on one of the four graph windows -- it doesn't matter which one -- and click **Format: Layer**.
2. In the Plot Details dialog box, click the **Display** tab and note the **Scale Elements** settings. By default, **Scale With Layer Frame** is selected. This tells us that when the size of the layer is changed, the size of attached elements such as the axis titles, graph legend, etc., will be scaled accordingly.
3. Click **OK** to close Plot Details, then right-click on the graph window title bar and choose **Duplicate**. You now have two identical windows.
4. Click on the duplicated window and click **Format: Layer**, again. Click on the **Display** tab again, but this time, set **Scale Elements** to **Fixed Factor: 1**, then click **OK** to close Plot Details. We now have two identical graphs, one with **Scale Elements = Scale With Layer Frame** and one with **Scale Elements = Fixed Factor: 1**.
5. Reposition and resize your identical graphs so that we can do a side-by-side comparison.

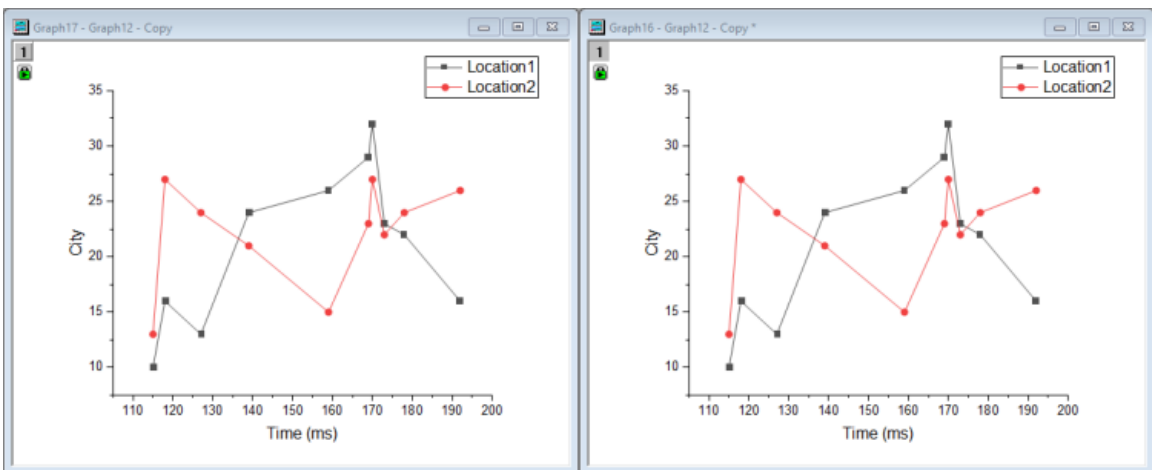

As mentioned, we ultimately plan to merge 4 separate graphs into a single, 4-panel graph and in doing so, we must shrink the size of our graphs to fit four to a page. What will be the effect of shrinking on text elements, for instance? We have set up a comparison to identical graphs, one with elements set to scale with the layer and one with elements set to a fixed size.

- In the graph window that is set to **Scale With Layer Frame**, click once in an empty portion of the graph page and when the green selection handles appear, hold the CTRL key and drag a corner handle so that the graph covers approximately 25% of the page.
- Repeat the last step with the graph window that is set to **Fixed Factor: 1**.
- Now, compare the resulting smaller graphs and note, in particular, the difference in the way that the various elements -- the plot symbols, the text and legend objects -- behaved when the graph was made smaller.

Elements **Scale With Layer Frame**

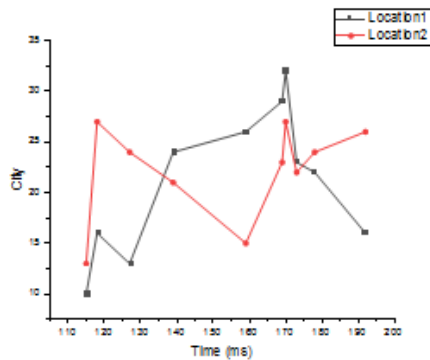

Elements Do NOT Scale - **Fixed Factor: 1**

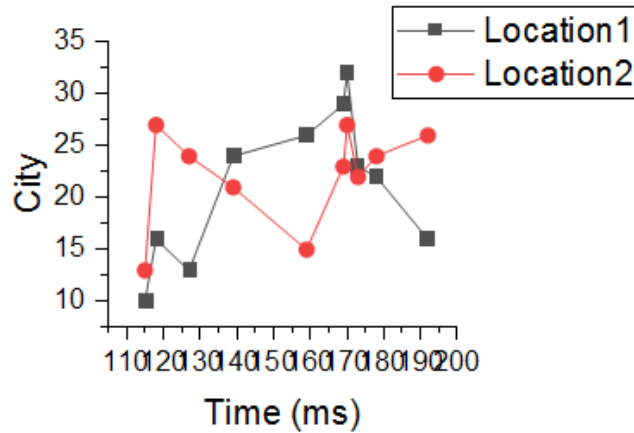

We can see that setting the elements to **Fixed Factor: 1** is probably going to cause problems when four graphs are merged onto a single page, so when we merge, we will leave the default setting for each of the merged graphs to **Scale With Layer Frame**.

- So that you don't get it mixed up with the other graphs, delete the "Fixed Factor" graph.

### 6.5.5.3 Merging Graph Windows

- With all four (and *only* the four) of your original graph windows showing in the workspace, choose **Graph: Merge Graph Windows** and open the **Merge Graph Windows** dialog box.
- Make sure that all four graphs are listed in the **Graphs** box, then expand the **Scale Elements** branch and make sure that **Scale Mode** is set to *Auto*. Note the Preview pane to the right side of the dialog box, showing an approximation of your final, merged graph. **Tip:** If you want to keep your original graphs, make sure the **Keep Source Graphs** box is checked, or the graphs will be destroyed.
- Click **OK** and a four-panel graph is created. Note the four layer icons in the upper-left corner of the merged graph -- one icon for each graph layer.



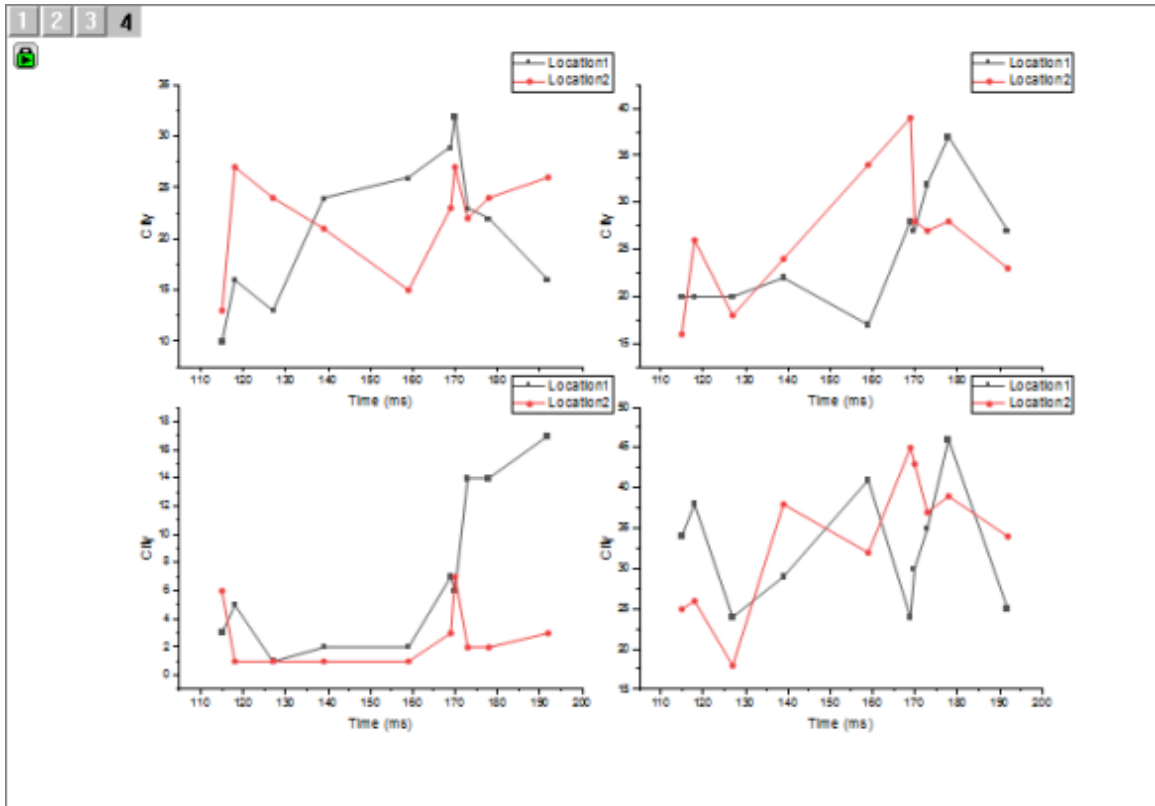

### 6.5.5.3 Common Display Controls for Simultaneous Edits to Multiple Layers

Suppose that we want to customize some elements or properties of the layers, plots and axes in a multi-panel graph? We could make edits to each layer, one-by-one, but this would be tedious. Beginning with Origin 2018b, you can use [the Plot Details Layers tab Common Display controls](#) to apply edits made to one layer, to other layers.

1. With your 4-panel (merged graph) active, click **Format: Page**. This opens the Plot Details dialog box.
2. Click on the **Layers** tab.
3. Under **Common Display**, check the **Plot Properties** box. As the "blue hint" tells us, we should check the appropriate boxes here *first*, then make customizations at the Layer/Plot level. We can use the **Apply to** controls to selectively apply **Common Display** changes (see documentation of [Apply to](#) controls).
4. In the left panel of Plot Details, click the arrow to the left of the *Layer1* icon to expand to show the two data plots in the layer.

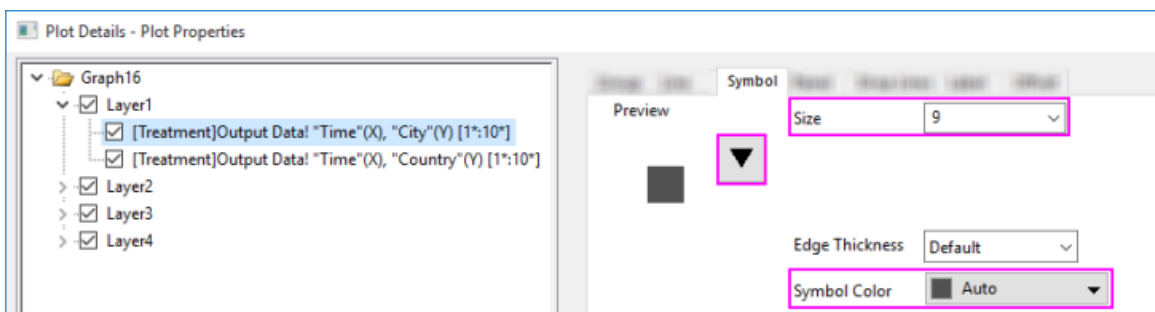

- Click on the first plot in the layer, then on the **Symbol** tab to the right side of Plot Details, click on the symbol gallery (downward-pointing arrow) and change plot symbol shape to Circle, then change **Size** to 15. Leave **Symbol Color** as *Auto* as that will allow symbol color to follow line color. Click **OK** to close Plot Details and note that the symbol size is increased in all plots in our 4-panel plot.
- We can continue to customize our 4-panel plot using **Format** and **Style** toolbar buttons. Click on one of the gray plots and note that both plots in the layer are now highlighted. Pause slightly and click a second time on the gray plot and this time, you will see that only *that* plot is selected.
- Click the Line/Border Color button on the Style toolbar and choose *Navy*. Note that gray plots in each of the four panels are now navy blue in color. The graph should look something like this:

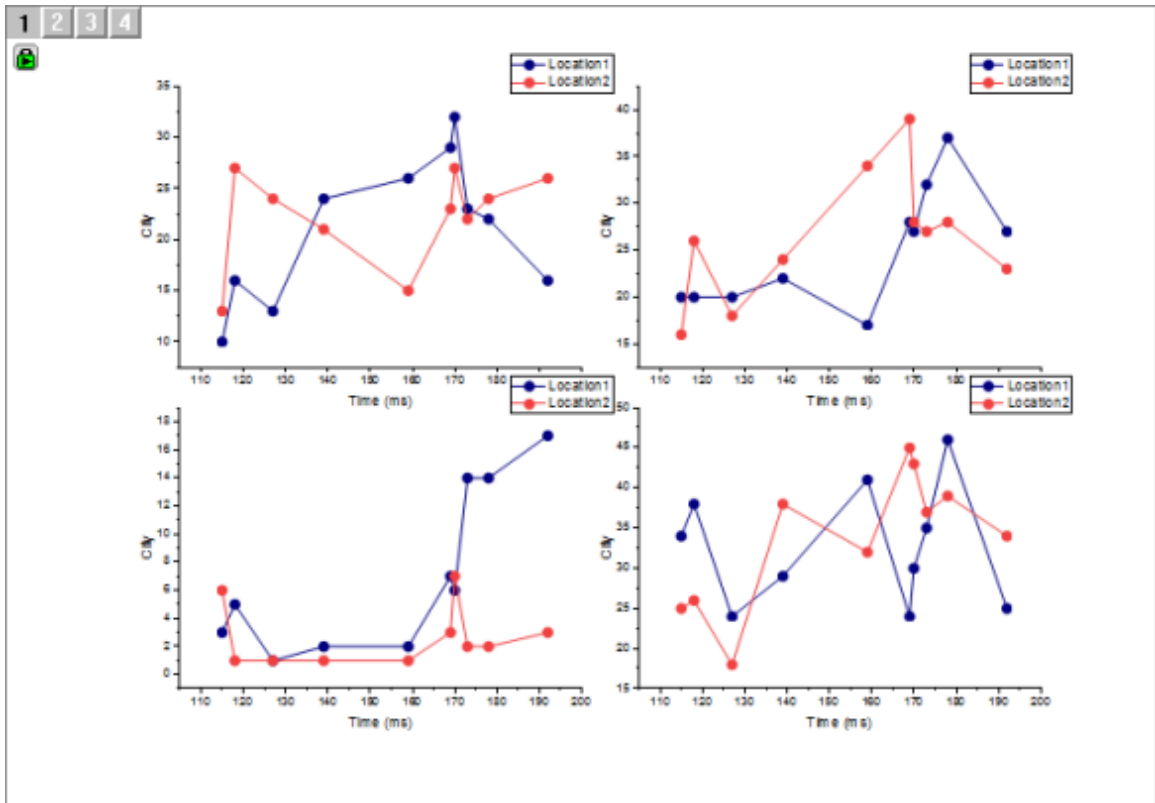

#### 6.5.5.3.4 Fix Scale Factors

At this point, we have a satisfactory graph and we may consider our work finished. However, one thing that we should be aware of is that when the four graphs were merged, the scaling down of font size produced one small issue.

- Select one of the graph legend objects, then hover over it with your mouse and you will see a tooltip that appears something like this:

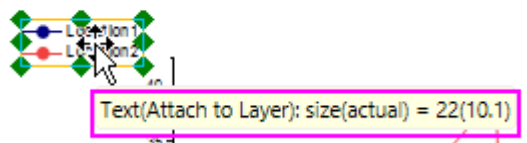

The tooltip reports that the (font) size = 22 but that the actual size is 10.1. This occurs because, as we expected, the font was scaled down when we merged graphs. The problem now is that we have a font size that *looks* like it is 10.1 but Origin still thinks of it as a size = 22 (Look to the **Font Size** list on the Format toolbar and it will report the original size of 22). We can correct this conflict with a simple menu command.

2. With the graph window active, choose **Graph: Fix Scale Factors** and accept the default value of 1 by clicking **OK**. Now, select one of the four legend objects, hover and you'll see that the tooltip now reports that both size and actual = 10.1 (the decimal is not meaningful as Origin rounds to the nearest 0.5). Note also, that the Format toolbar now reports **Font Size** = 10.

While we could have skipped this detail, it is not uncommon for users to want to be confused by conflicting information about scaled font sizes and this menu item is the best way to reset font size so that you know just what you are working with.

#### 6.5.5.3.5 Fit Layers to Page

At this point, our graph looks satisfactory but we could do a couple of things to improve it. One would be to remove extra white space from the graph. We have a couple of options there but one quick way to do this is to choose the Fit Layers to Page menu item.

1. With the graph window active, choose **Graph: Fit Layers to Page**. This opens the **Fit Layers to Page:gfitp** dialog.
2. Set a **Margin** of 5 and clear the **Maintain Layer Aspect Ratios** box, then click OK. Our graph layers are slightly re-proportioned and the white space around the outside is reduced.



If you are exporting or copying your graph to an external application, [the Export Margin Offsets dialog box](#) can also be used to remove white space from the outside of the graph.

#### 6.5.5.3.6 Graph Legend Adjustments for Panel Graphs

We don't need the four graph legend objects since each panel plots the same two variables. So, we will eliminate three objects and slightly reconfigure the fourth to act as a legend object for the four panels.

1. Press CTRL + select three of the legend objects and when the green selection handles appear surrounding the three, press Delete.
2. Drag the remaining legend object to the top-center of the graph page.
3. With the legend object still selected (green handles showing), press CTRL again and drag one of the green handles on the *side* of the legend object and drag it out horizontally until it looks like this:

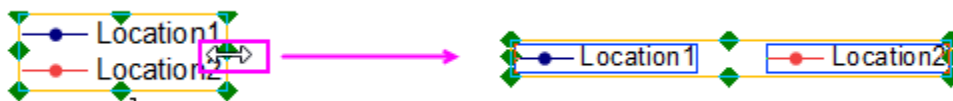

- Center the graph legend on top of the page. Your graph should now look something like this:

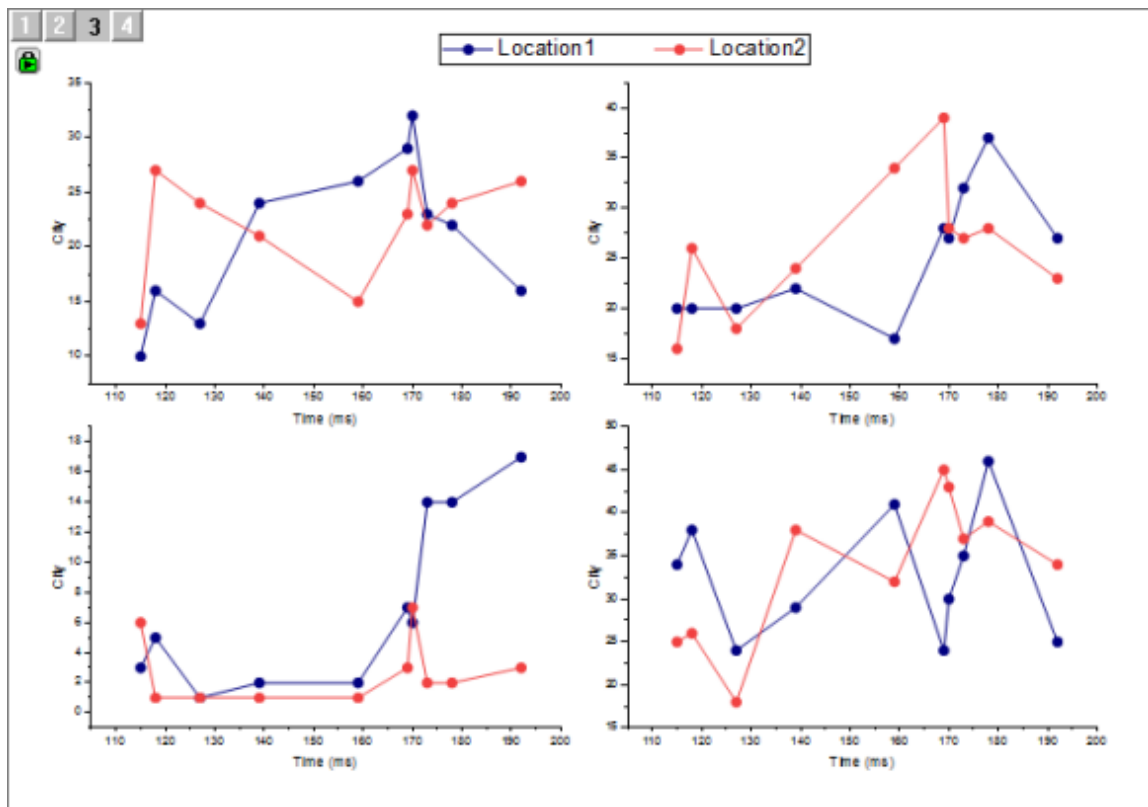

## 6.6 Graph Template and Theme

### 6.6.1 Graph Template and Theme

- [Copy and Apply a Plot Format to Another Plot](#)

### 6.6.2 Copy and Apply a Plot Format to Another Plot

#### 6.6.2.1 Summary

It is possible to copy and paste formatting from one plot to another, so there is no need to spend time recreating identical customizations such as size and color of symbols and lines.

Minimum Origin Version Required: Origin 8.0 SR6

#### 6.6.2.2 What you will learn

This tutorial will show you how to:

- Copy a plot format (color, size, etc. of the symbol or the line), and apply it to other plot.

#### 6.6.2.3 Steps

1. Click the **New Project** button on the Standard toolbar to begin with a new project.
2. Select **Data: Import from File: Single ASCII** menu, and import **exponential decay.dat** in the **\Samples\Curve Fitting** subfolder in your Origin program directory.
3. Highlight column B, C and D, and select **Plot: 2D: Line+Symbol: Line+Symbol" menu to plot these three datasets.**
4. Double-click on the plot to show the **Plot Details** dialog box.
5. Choose **Group** tab in the dialog, and select **Independent** for the **Edit Mode** -- this makes it easier to customize individual plots.
6. Make sure that the top data plot (Time(X) Decay 1(Y)) is selected in the left panel of the **Plot Details** dialog. If not, select this plot branch in the left panel.
7. Select the **Symbol** tab, and change the Size to "5". (You can also change the shape or the color to others of your choice.)
8. Select the **Line** tab, and change the width to "0.2". (You can also change the style or the color to others of your choice.) Click OK. You will see that the **Decay 1** plot has been customized.
9. Click on **Decay 1** plots to select. Right-click on it and select **Copy format**. This will copy the plot format of Decay 1 to the clipboard.
10. On the graph, click on the **Decay 2** data plot to select it, right-click and select **Paste Format to: All**. You will see the plot format of Decay 1 copied to Decay 2.

Note: Right-clicking on third plot "Decay 3" to select **Paste Format(Advanced)** to open the [Apply Formats](#) dialog, you can do further and more detailed settings.

## 6.7 Line and Symbol

### 6.7.1 Line and Symbol

- [Complicated Fill Area](#)
- [Fill Partial Area between Function Curves](#)
- [Line Graph with Recession Bars](#)
- [Scatter Plot of Decay and Recovery Curves](#)
- [Micro-Raman spectroscopy of complex nanostructured mineral systems](#)
- [Multi-line-plot with Special Position Annotation Line](#)
- [Scatter Central Plot](#)
- [Line Graph with Masked Data](#)
- [Symbol Plot with Color Transparency](#)
- [Symbol Plot with Size and Colormap from Other Columns](#)

### 6.7.2 Complicated Fill Area

#### 6.7.2.1 [Summary](#)

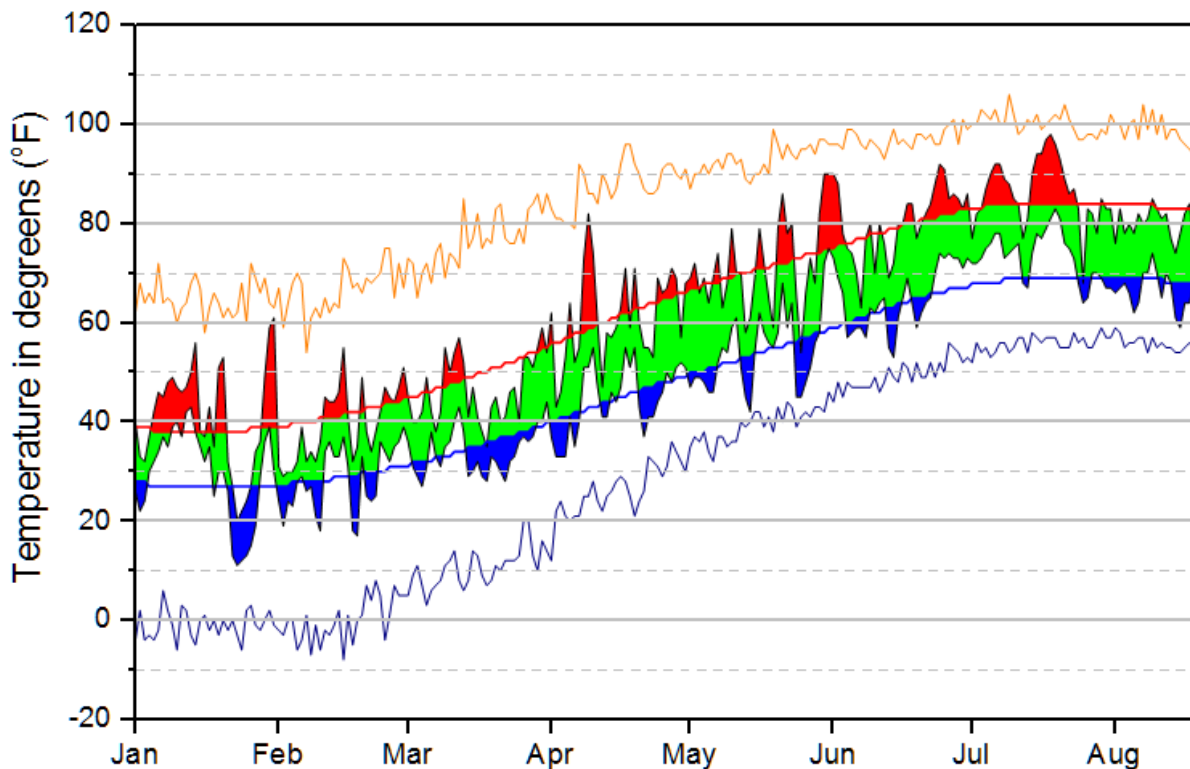

Minimum Origin Version Required: 9.1 SR0

#### 6.7.2.2 What You Will Learn

- Fill area between curves with two different colors.
- Use an ordered plot sequence to implement complex graph fills.



In this tutorial you will choose a Plot Details setting **Fill to next data plot**. When we say "next" this refers to the next plot in the plot list in the left panel of Plot Details". This has nothing to do with intersecting plots on the graph page.

#### 6.7.2.3 Creating the Basic Plot

This tutorial is associated with <Origin EXE Folder>\Samples\Tutorial Data.opj. Note that this tutorial requires numerous steps to produce a complex graph. Users should understand that this is not a basic Origin graphing tutorial.

1. Open the Tutorial Data.opj and browse to folder *Multiple Fill Area*.
2. Activate workbook **Book2, Sheet1**. Highlight columns C through F, then click **Plot > Basic 2D : Line**. A grouped line plot is created.
3. Select and delete the X axis title and legend object from the graph.
4. Double-click on any plot to open the **Plot Details** dialog. Go to **Line** tab and set **Transparency** to 100%.

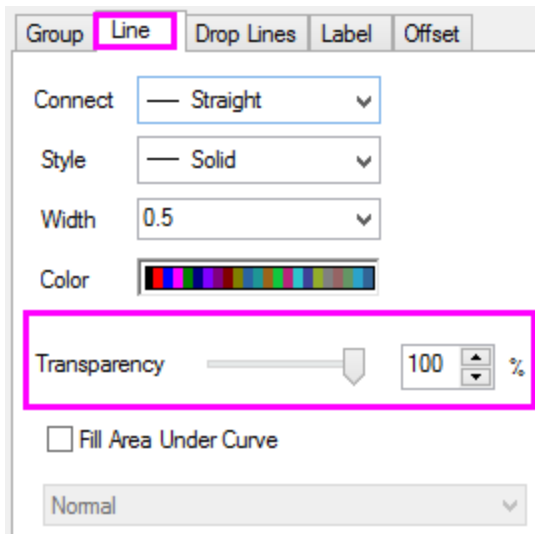

5. Go to **Group** tab and set **Edit Mode** to **Independent**, then click **Apply**. This will allow us to specify custom fill area modes for each line.

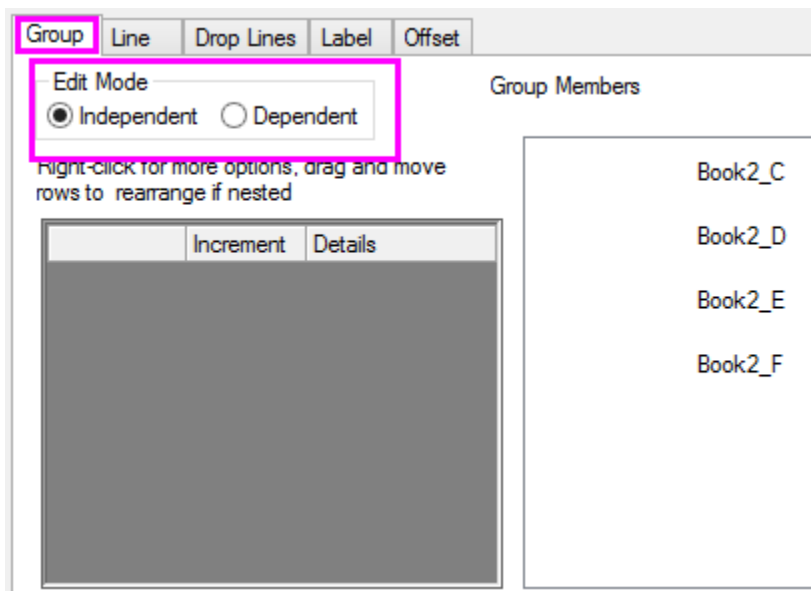

6. Highlight the first plot in the left side of Plot Details. On the **Line** tab, enable **Fill Area Under Curve** and select **Fill to next data plot - Above Below Colors**.

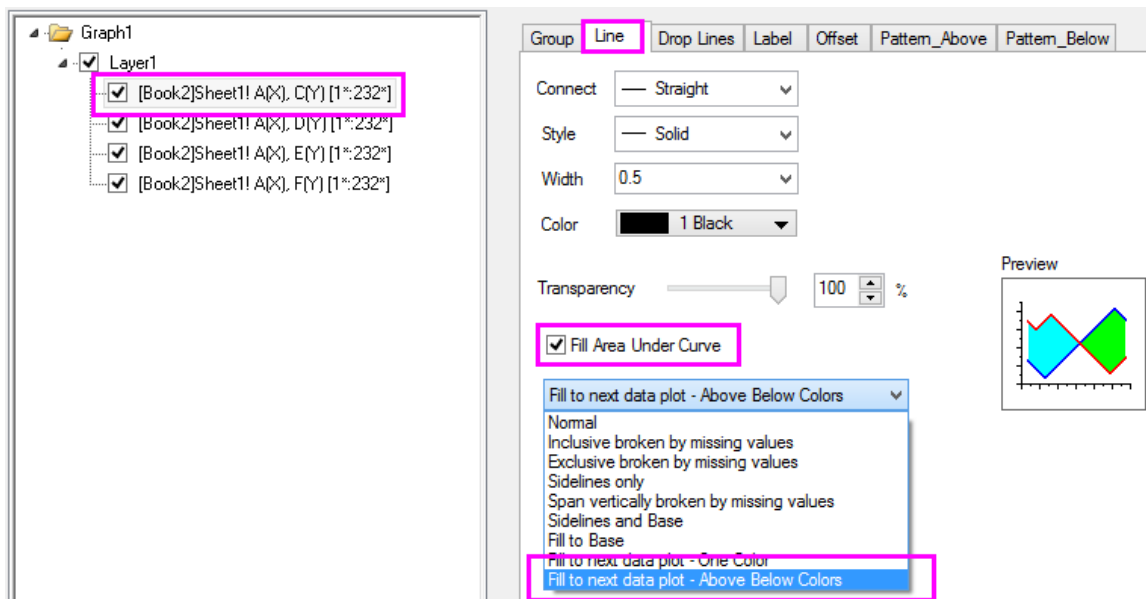

7. Go to **Pattern\_Above** tab and choose settings as shown below.

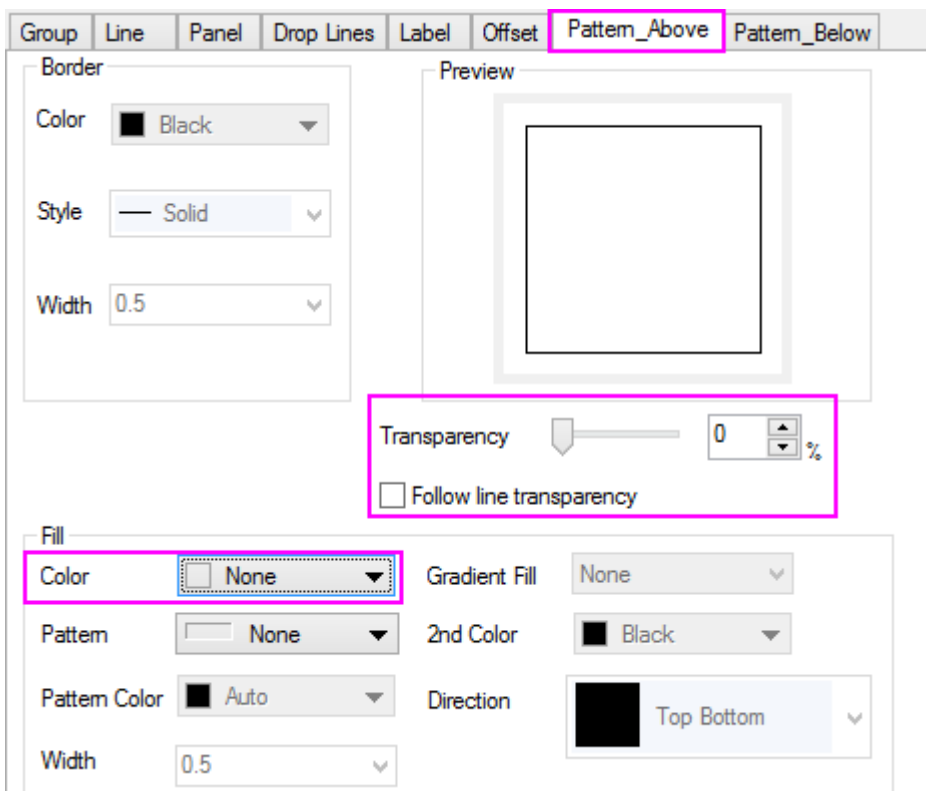

8. Go to **Pattern\_Below** tab and set **Fill Color** to *Red*, then click **Apply**. The first filled area part of our plot is added.



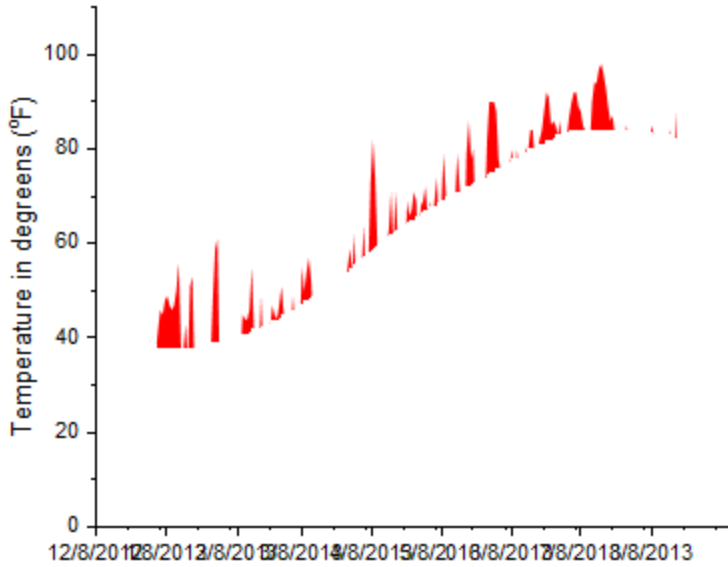

- Highlight the second plot in the left side of Plot Details. Go to the **Line** tab, enable **Fill Area Under Curve** and select **Fill to next data plot - One Color**.

Graph1

- Layer1
  - [Book2]Sheet1! A(X), C(Y) [1\*:232\*]
  - [Book2]Sheet1! A(X), D(Y) [1\*:232\*]
  - [Book2]Sheet1! A(X), E(Y) [1\*:232\*]
  - [Book2]Sheet1! A(X), F(Y) [1\*:232\*]

Group: **Line** | Drop Lines | Label | Offset | Pattern

Connect: Straight

Style: Solid

Width: 0.5

Color: 2 Red

Transparency: 100 %

Fill Area Under Curve

Fill to next data plot - One Color

- Normal
- Inclusive broken by missing values
- Exclusive broken by missing values
- Sidelines only
- Span vertically broken by missing values
- Sidelines and Base
- Fill to Base
- Fill to next data plot - One Color
- Fill to next data plot - Above-Below Colors

Preview: A small graph showing a blue filled area under a red line.

- On the **Pattern** tab, choose settings as shown below.

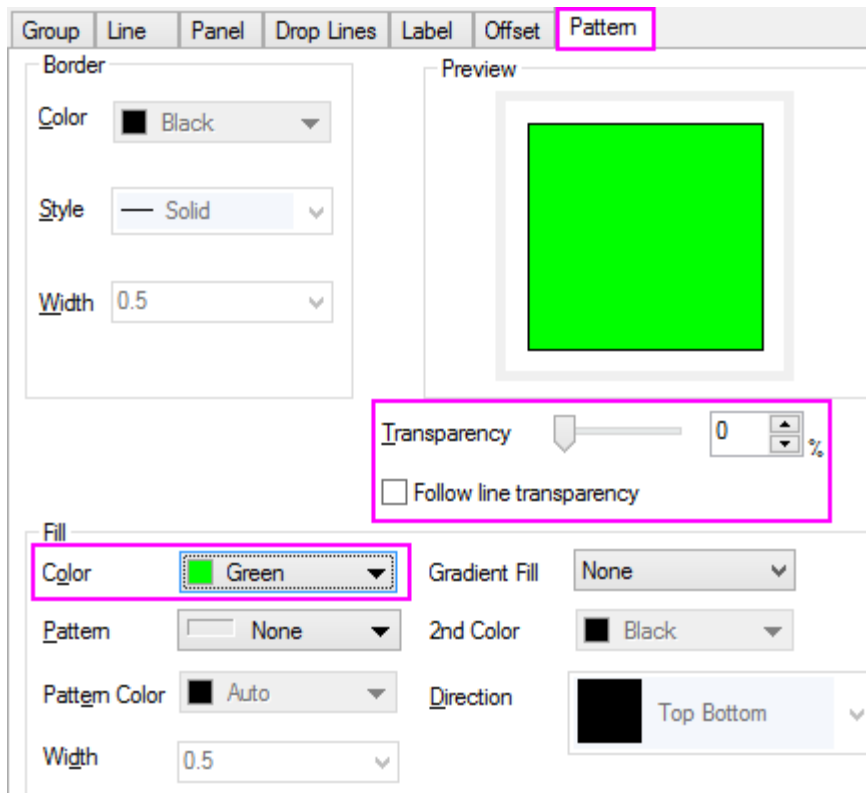

11. Repeat step 6~8 for the third plot in graph but on the **Pattern\_Above** tab, set **Fill Color** to *None* and **Transparency** to 0 (you must clear **Follow Line Transparency**). On the **Pattern\_Below** tab, set **Fill Color** to *Blue*.

12. Your stacked fill area plot should now look like this:

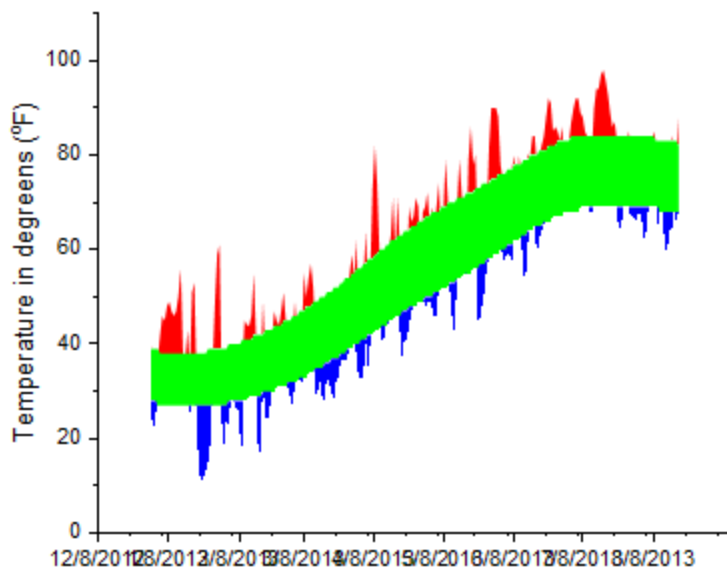

6.7.2.4 Steps to Eliminate Overlapping Fill Areas

In the graph we just created, there are some overlapping fill areas that we do not want. We will hide them by adding a white fill area to cover them. We will be using the **Layer Contents** dialog box to add datasets to the graph, some of them multiple times.

1. From the menu, select **Graph: Layer Contents**. Use the right-pointing arrow button in the middle of the dialog to add these plots to the datasets to the right side of the dialog.

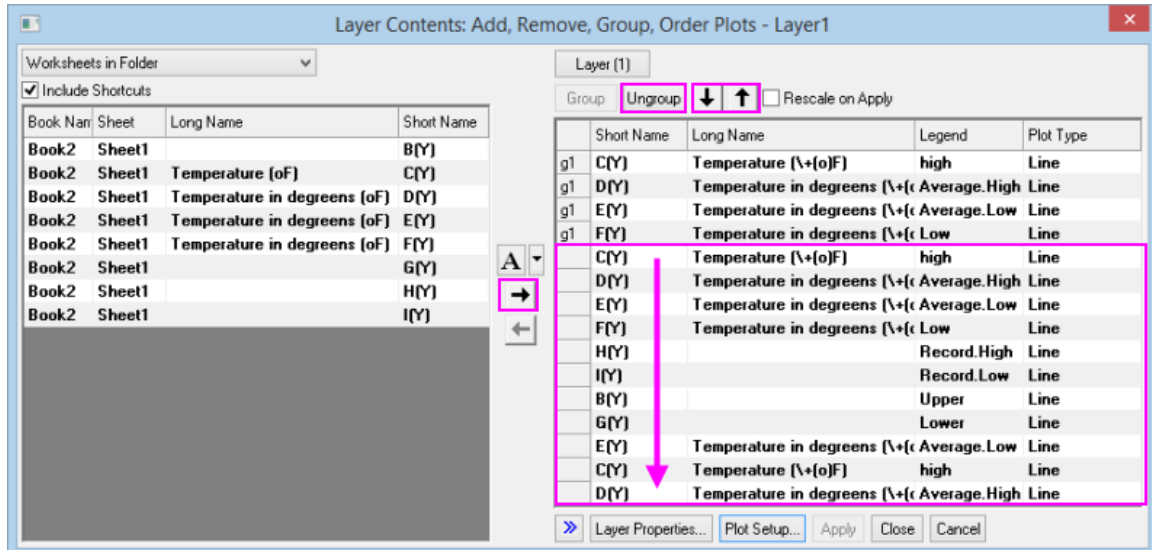

2. Use the **Ungroup** button to ungroup any plots that come over as groups. Grouping is denoted by the **gn** beside each dataset. You want to *make sure that no groups exist* (you can ignore the first four datasets that were added).
3. Arrange added plots in exactly the order shown. Use the up- or down-arrow buttons above the right side list, to rearrange the list as needed. Note that only ungrouped plots can be independently ordered. When your list looks like the figure above, click **OK** to close the **Layer Contents** dialog box.
4. Double-click on a data plot to open the Plot Details dialog box.
5. In the left side of Plot Details, highlight the fifth plot down (C(Y)). On the **Line** tab, check **Fill Area Under Curve**, and from the drop-down choose **Fill to next data plot - Above Below Colors**, **Color** = *Red* and **Transparency** = 0. On the **Pattern\_Above** tab, **Transparency** = 0 and **Fill Color** = *White*. On the **Pattern\_Below** tab **Fill Color** = *Red*.
6. Highlight the sixth plot down (D(Y)) and set **Color** = *Red* and **Transparency** = 0.
7. Highlight the seventh plot down (E(Y)). On the **Line** tab, check **Fill Area Under Curve**, and from the drop-down choose **Fill to next data plot - Above Below Colors**, **Color** = *Blue* and **Transparency** = 0. On the **Pattern\_Above** tab set **Fill Color** to *White* and **Transparency** to 0. On the **Pattern\_Below** tab, **Fill Color** = *Blue*.
8. On the eighth plot down (F(Y)), click the **Line** tab and set **Color** to *Black* and **Transparency** to 0.
9. On the ninth plot down (H(Y)), click the **Line** tab and set **Color** to *Orange* and **Transparency** to 0.
10. On the tenth plot down (I(Y)), click the **Line** tab and set **Color** to *Blue* and **Transparency** to 0.
11. For the eleventh and twelfth plots (B(Y), G(Y) respectively), click the **Line** tab and set the line **Color** to *Gray* and the **Transparency** to 0.
12. For the thirteenth plot down (E(Y)), click the **Line** tab and from the drop-down set **Fill to next data plot - Above Below Colors**, **Transparency** = 0. On the **Pattern\_Above** tab, set **Fill Color** = *None*, **Transparency** = 0; on the **Pattern\_Below** tab, **Fill Color** = *White*.

13. For the fourteenth plot down (C(Y)), click the **Line** tab and verify that **Color** = *Black* and **Transparency** = 0.
14. For the fifteenth (last) plot down, click the **Line** tab and set **Color** = *Red* and **Transparency** = 0.
15. Close **Plot Details** and click the **Rescale** button  on the **Graph** toolbar. Your graph should look roughly like the following. To polish your graph, continue with the last section.

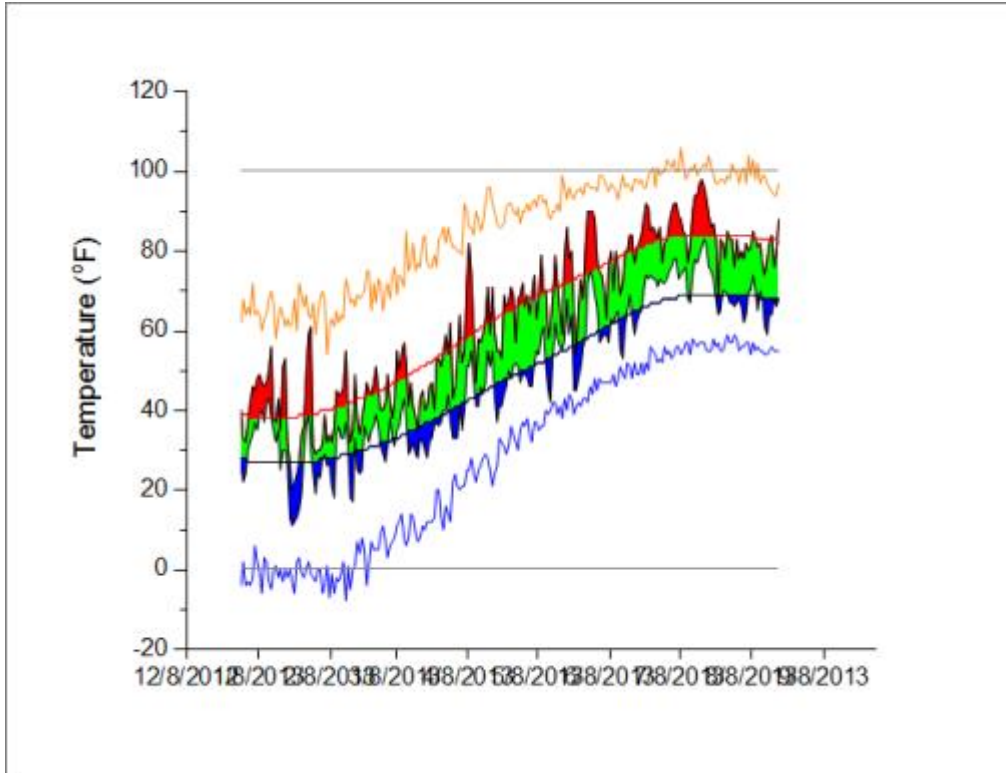

#### 6.7.2.5 Further Customizations

1. Double-click on the X axis (bottom, horizontal) tick labels. This opens the X Axis dialog box. Click the **Scale** tab and set the date range From *1/1/2013* To *8/20/2013*. Set **Minor Ticks Count** = 0.
2. On the **Tick Labels** tab set **Display** to show a three-letter abbreviation for month (e.g. *Apr*).
3. Click Apply.
4. To draw a box around the whole graph layer, choose **View: Show: Frame**.
5. Lastly, to add the dashed lines at temperature = *-10* and *+110*, double-click on the Y axis (left, vertical). Click on the **Reference Lines** tab and enter the following:

At Axis Value	<input type="checkbox"/> Line	Fill To	<input type="checkbox"/> Label	Label Text	Label Location
Axis Begin	<input type="checkbox"/>	None	<input type="checkbox"/>	<value as entered>	Left
Axis End	<input type="checkbox"/>	None	<input type="checkbox"/>	<value as entered>	Left
110	<input checked="" type="checkbox"/>	None	<input type="checkbox"/>	<value as entered>	Left
-10	<input checked="" type="checkbox"/>	None	<input type="checkbox"/>	<value as entered>	Left
	<input type="checkbox"/>	None	<input type="checkbox"/>	<value as entered>	Left

- Click the **Details** button and in the **Reference Lines** dialog box, clear **Auto Format**, set **Style** to **Dash** and **Thickness** to **1**. Do this for both the -10 and +110 lines and click **OK**.
- In the **Axis** dialog box, click **OK** to close the dialog. Your graph should now look like this:

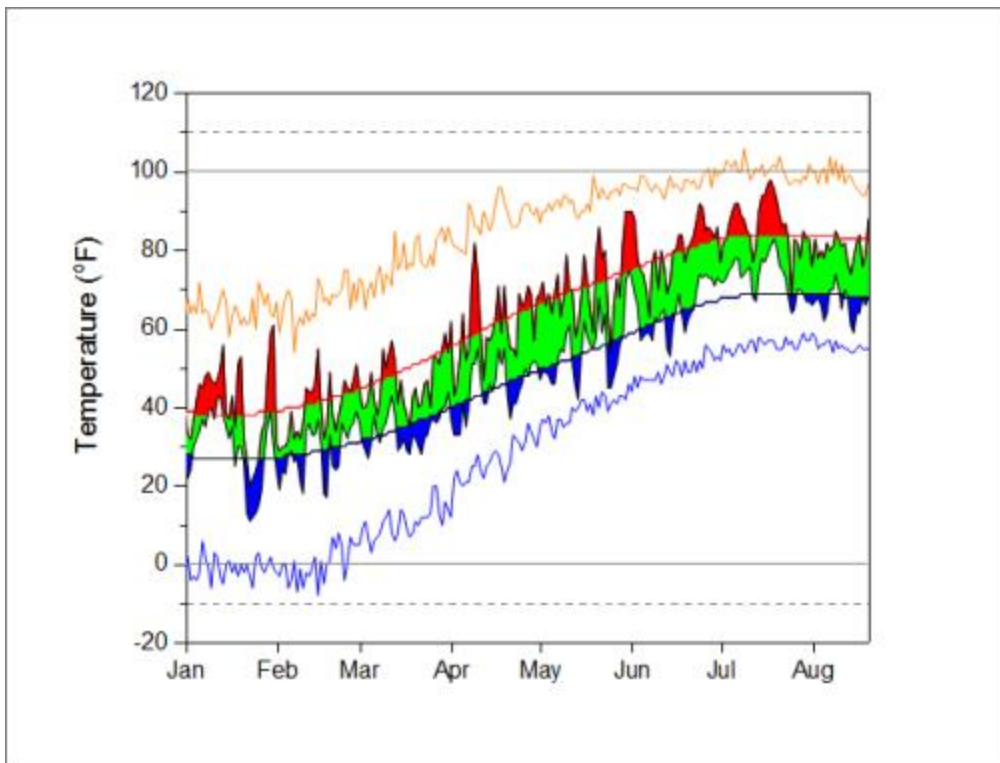

### 6.7.3 Fill Partial Area between Function Curves

#### 6.7.3.1 Summary

This tutorial shows how to plot two functions and customize the graph by partially filling an area between the two function curves.

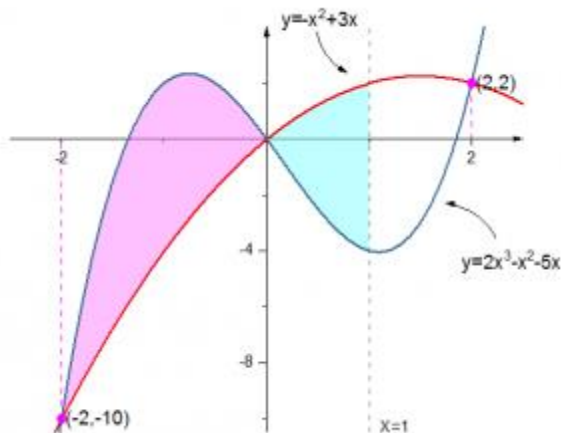

Minimum Origin Version Required: 2017 SR0

### 6.7.3.2 What you will learn

- Generate function data using Set Values tool.
- Fill areas between two lines with different colors.
- Add and edit objects on your graph.

### 6.7.3.3 Steps

This tutorial with the *Fill Partial Area between Function Plots* folder in the project <Origin EXE Folder>\Samples\Tutorial Data.opj.

#### 6.7.3.3.1 Filling Area Between Parts of Two Curves

To apply different fill colors to two or more portions of the curve, you need to plot curves in segments. In this tutorial, you will learn how to fill an area between curves defined by  $X \leq 1$ .

1. Open the Tutorial Data.opj and browse to the *Fill Partial Area between Function Plots* folder. **Book2L** contains two function curves (**Note:** To see how to generate a dataset from a function, see [the last section of this Tutorial](#)).
2. Select rows 1~36 ( $-2.5 \leq X \leq 1$ ) of all three columns in **Sheet1** of **Book2L** and on the menu, click **Plot> Basic 2D: Line** to plot two lines. The two datasets (lines) are automatically grouped.
3. Now, go back to the worksheet, select rows 36~51 ( $1 \leq X \leq 2.5$ ) of all three columns and hover over

the edge of the highlighted area until the cursor looks like this . Drag and drop the selected range, onto the graph you just created. If prompted to rescale the axes and show all data, choose **Yes**.

4. Select and delete the legend and the axis title.

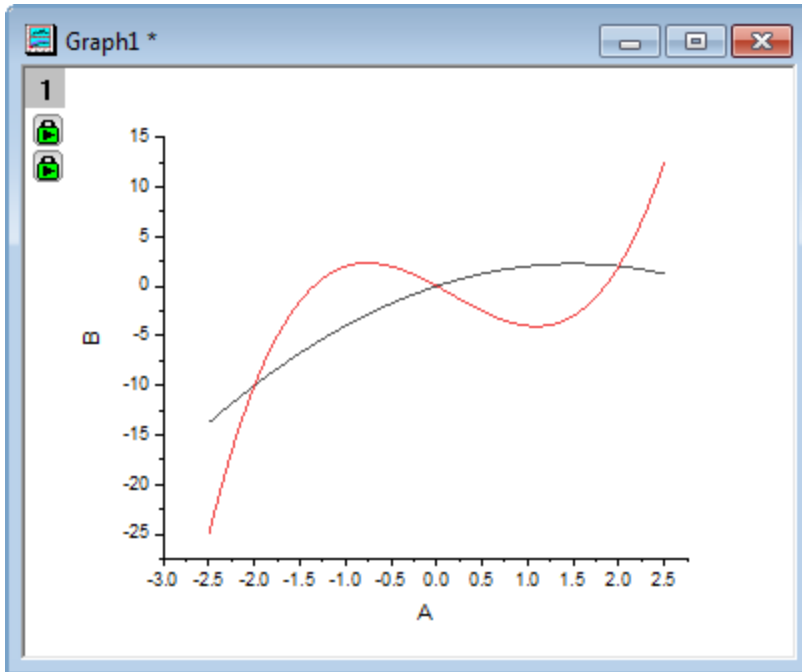

5. Double-click on one of the line plots, to open the **Plot Details** dialog box. Select the 1st plot under the **Layer1** node on left panel.
6. Go to **Line** tab and check **Fill Area Under Curve**. Select **Fill to Next Data Plot - Above Below Colors**. Notice that this action adds a **Pattern\_Above** and a **Pattern\_Below** tab to the dialog box.

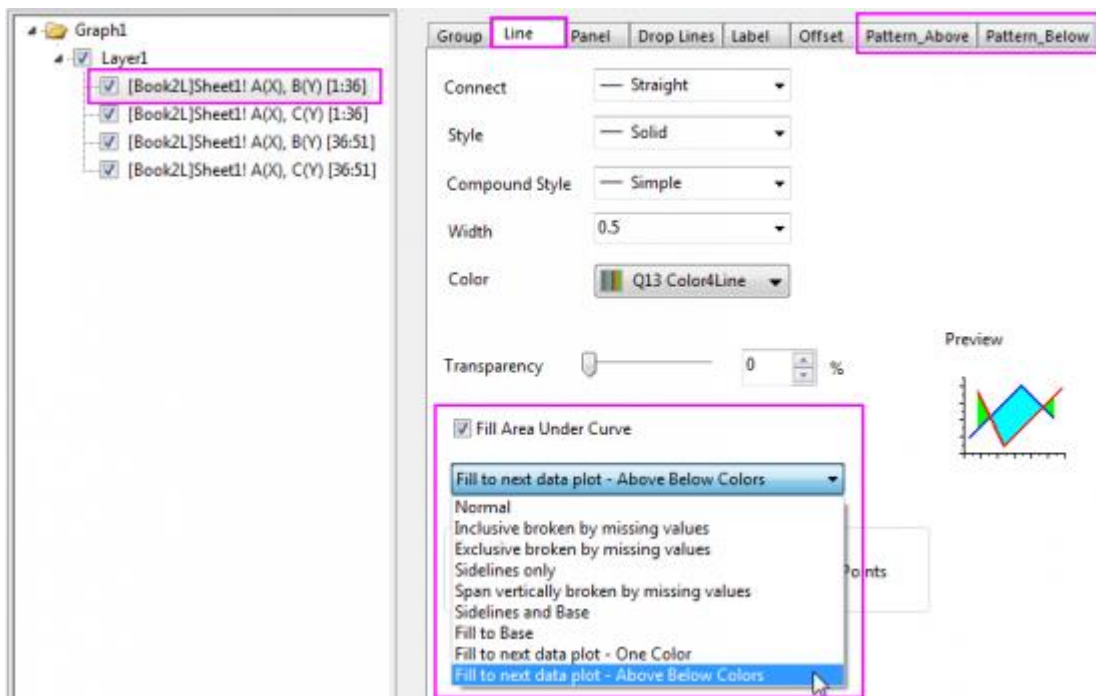

7. Go to **Group** tab, click the line color list in the **Details** column to select the increment list **Candy** as below:

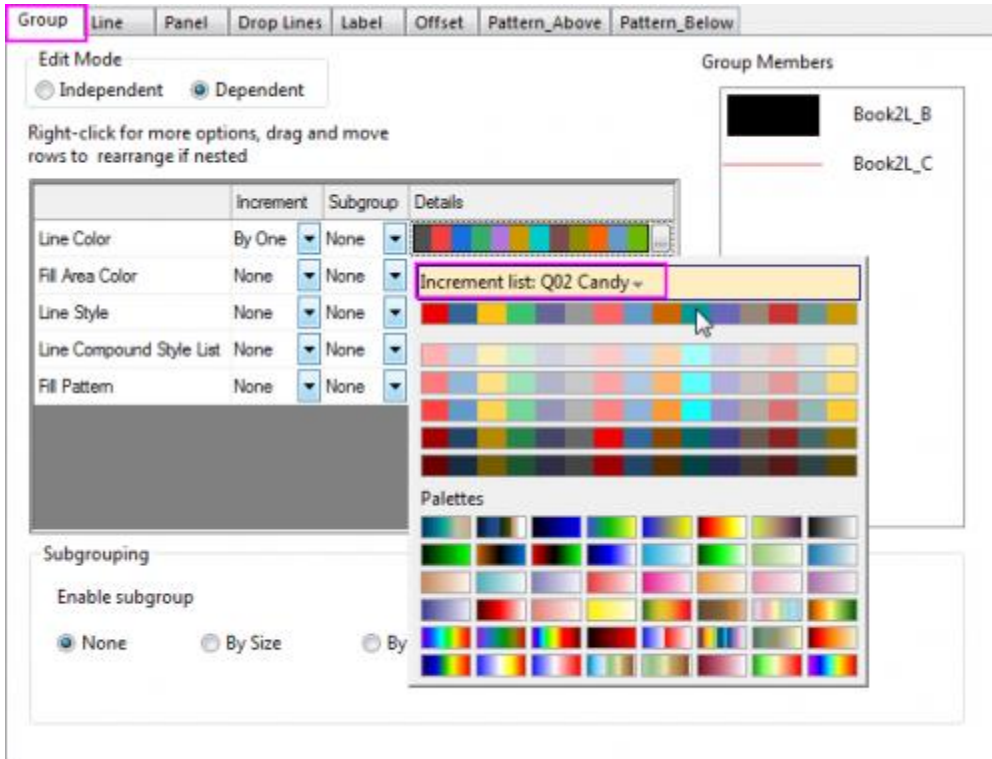

- Go to the **Pattern\_Above** tab and set the fill color of the black line to **LT Magenta** with a 50% transparency.

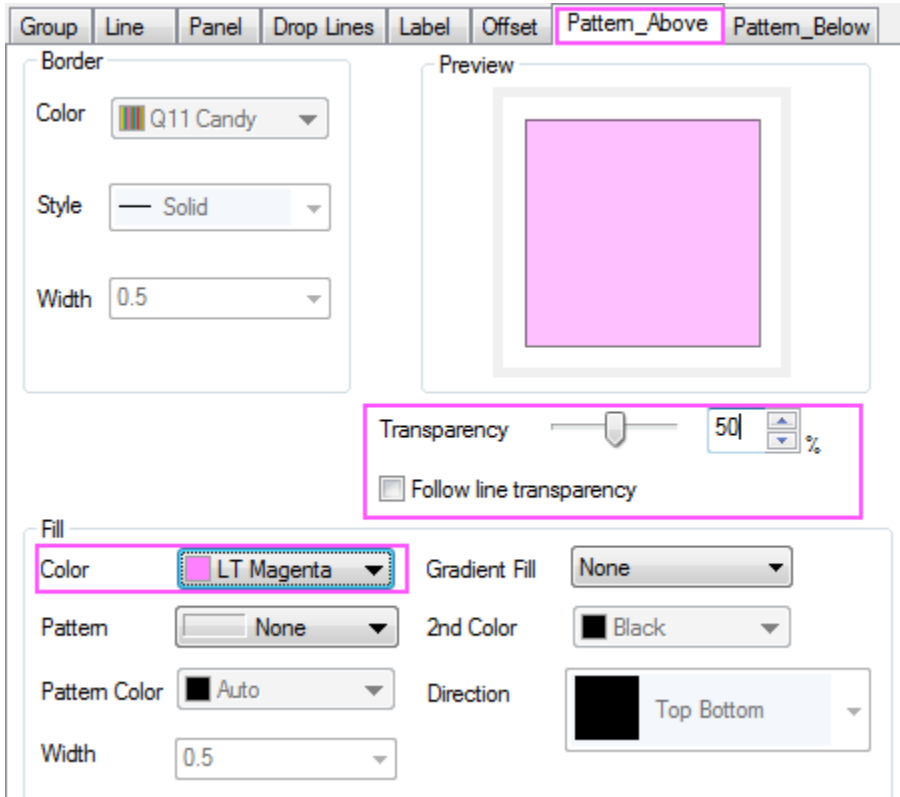



- Go to the **Pattern\_Below** tab and set the fill color below the black line to be **LT Cyan**. Note that there is not a separate transparency control for **Pattern\_Below** (uses the same transparency settings as **Pattern\_Above**).

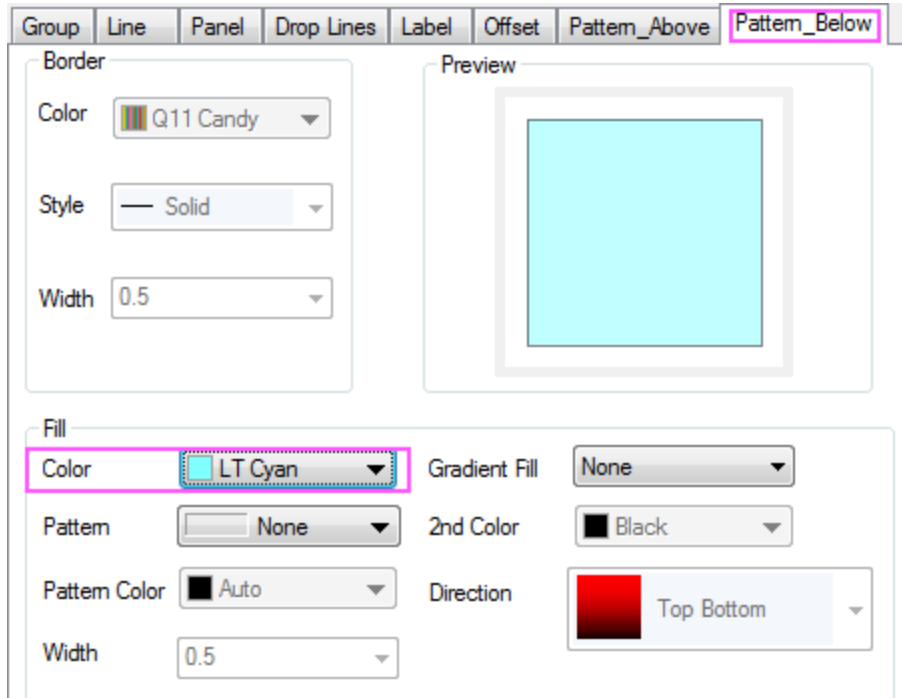

- Select the third plot in the left panel, go to **Group** tab, click the line color list in the **Details** column to select the increment list **Candy** as below:

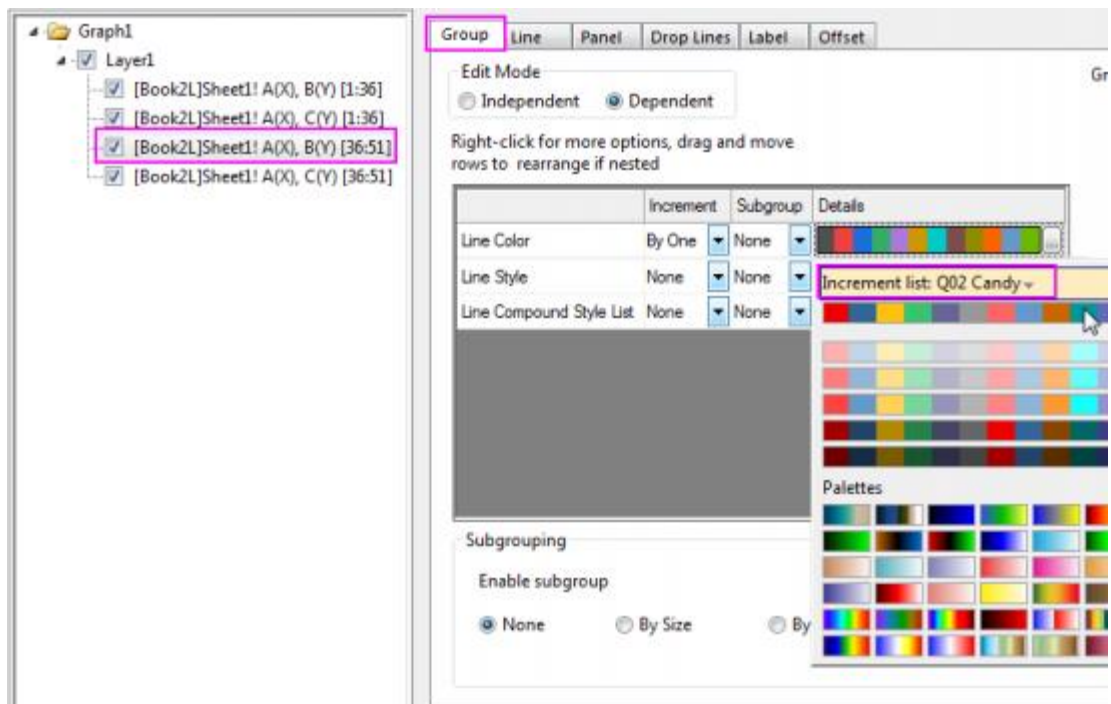

- Click **OK** to close the dialog box. The area in between the curves where  $X \leq 1$  is now filled.

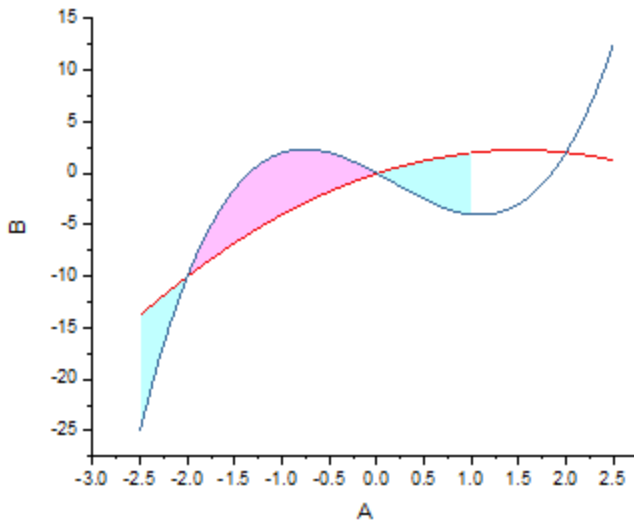

#### 6.7.3.3.2 Changing the Axis Range

- We want to change the **X** axis display range from **-2.5** to **2.5** and the **Y** axis display range from **-10.5** to **4**. To do this, double-click on the X axis to open the **Axis Dialog** box. Set the X axis(**Horizontal** icon) in **Scale** tab as follows.

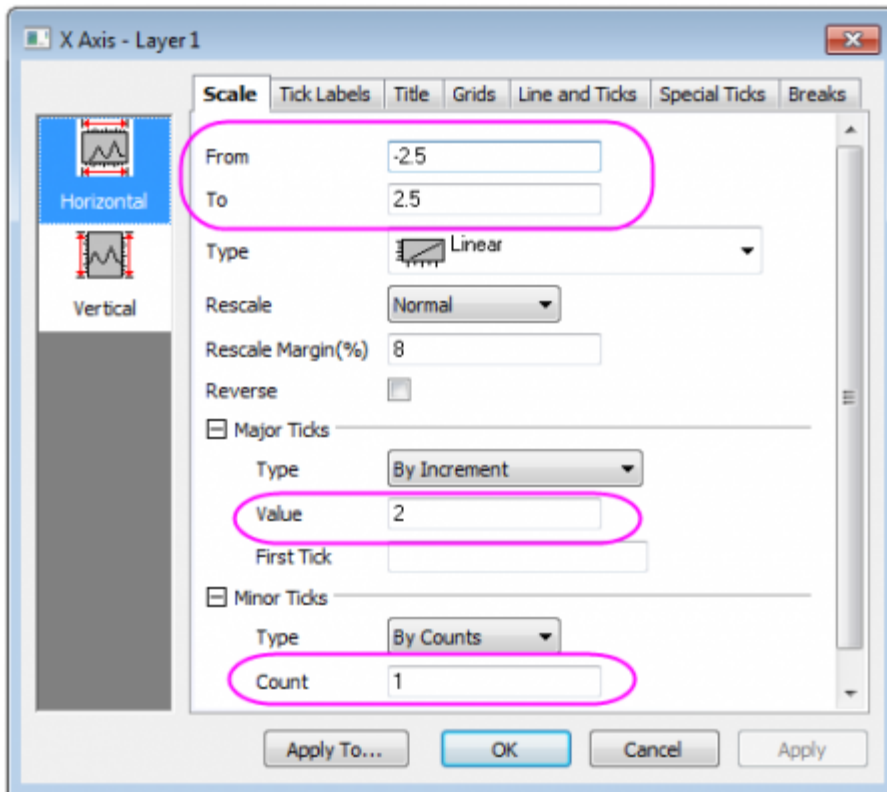

2. Go to **Vertical** icon in **Scale** tab and set the Y axis scale as follows.

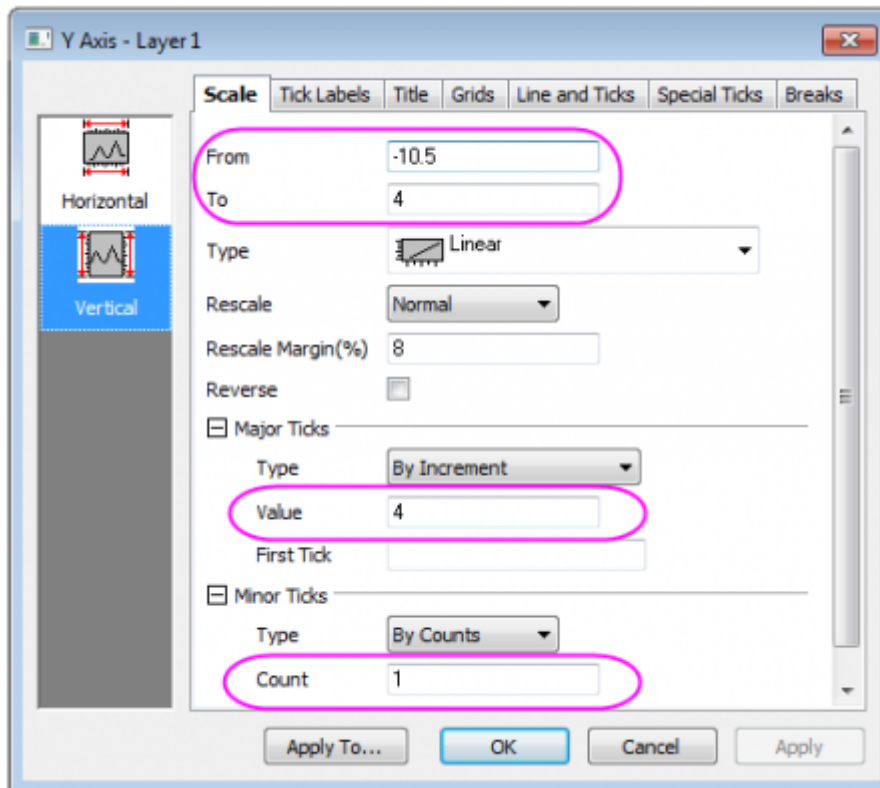

3. To configure the X and Y axes so that they intersect at **0,0**, Select both **Bottom** and **Left** icon in the left panel of the Axis Dialog. Set **Axis Position** to **At Position = 0**.

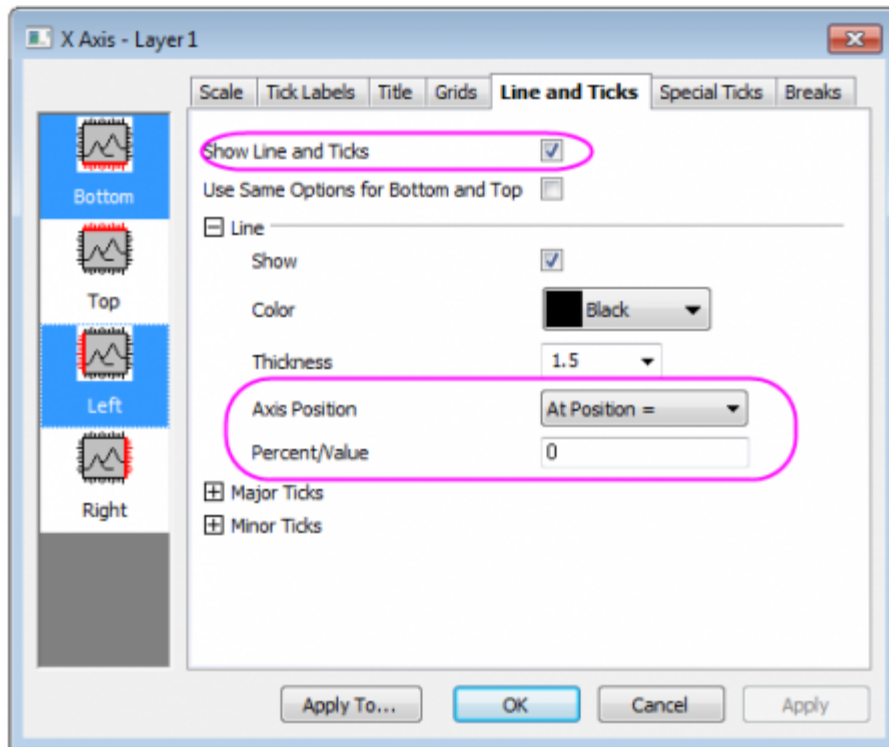

4. Click **OK** to close the dialog. Delete the Axis titles, and then select the two line groups separately to set **Width** to **2** both using the style toolbar. Then, the graph will look like:

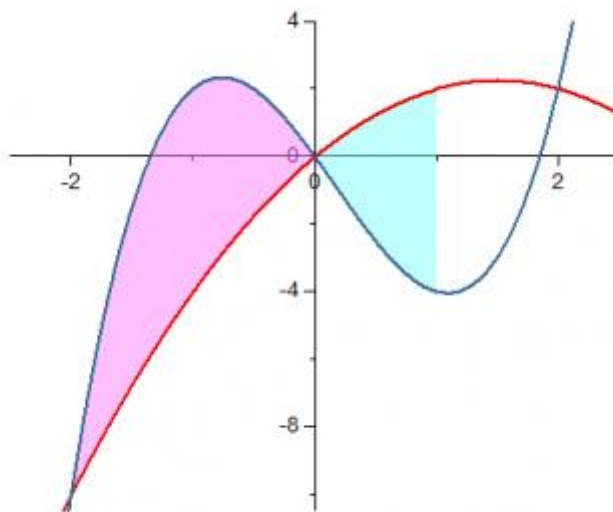

### 6.7.3.3 Adding Special Points with Labels to Annotate the Intersections

In the graph above, there are three intersections of two function curves. We want to mark two of them, at  $X=-2$  and  $X=2$  respectively.

1. Click the blue line( $X \leq 1$ ) twice to select this curve only as below:

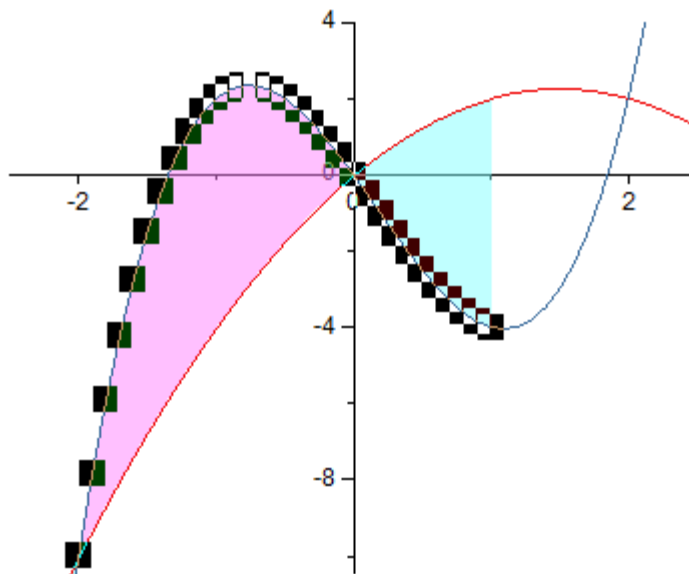

2. Then, click once again on the intersection at  $X=-2$  to select this individual point and then right-clicking on it to select **Edit Point** to open the **Plot Details** dialog. You can learn more about [how to show and customize a individual point on graph](#).

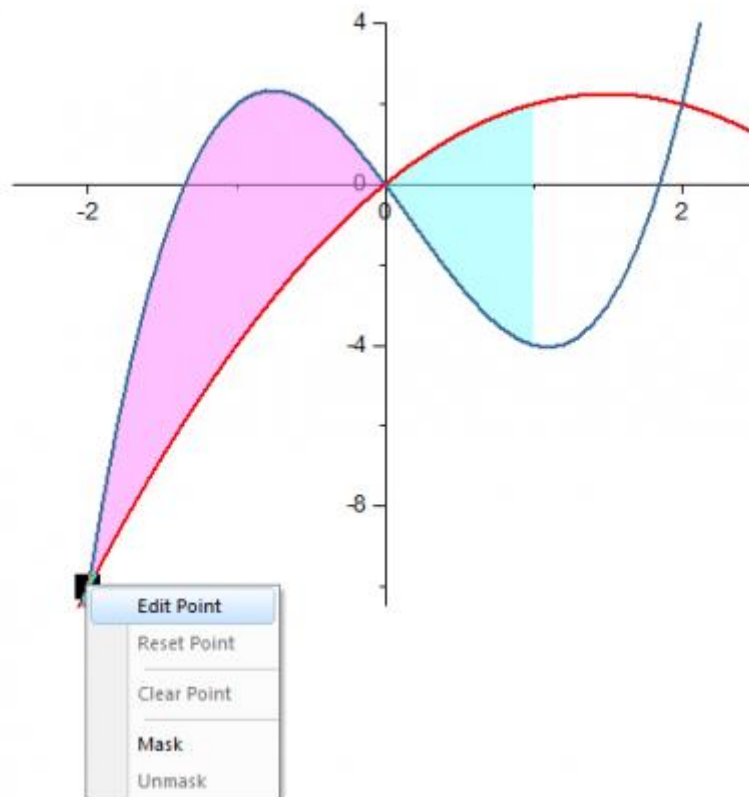

3. In the dialog that opens, you will see a *special* point showing its row index has been added and selected under the second plot.
  - o Go to the **Symbol** tab, customize its style as below:

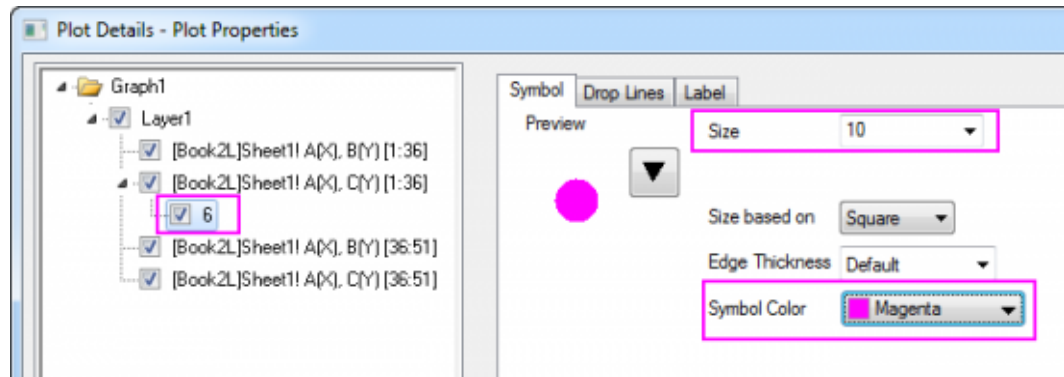

- o Go to the **Drop Line** tab, enable the vertical drop line and set its style as shown below:



- o Go to the **Label** tab, check the Enable check box to set **Label Form** to (X,Y) and **Font Size** to 22

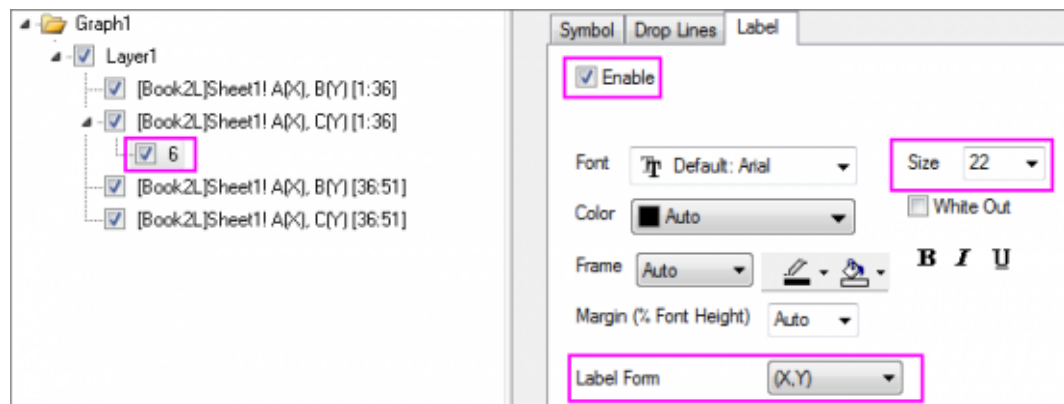

4. Click OK to turn off this dialog. Do the similar steps as step 1 ~ step 2 to add another intersection at X=2(row index = 46).

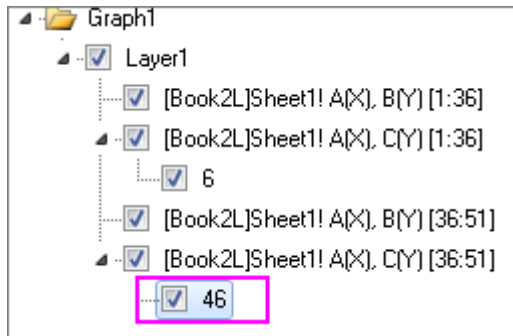

And then, set the same styles for it. At the end, you will get the graph such as the one shown below:

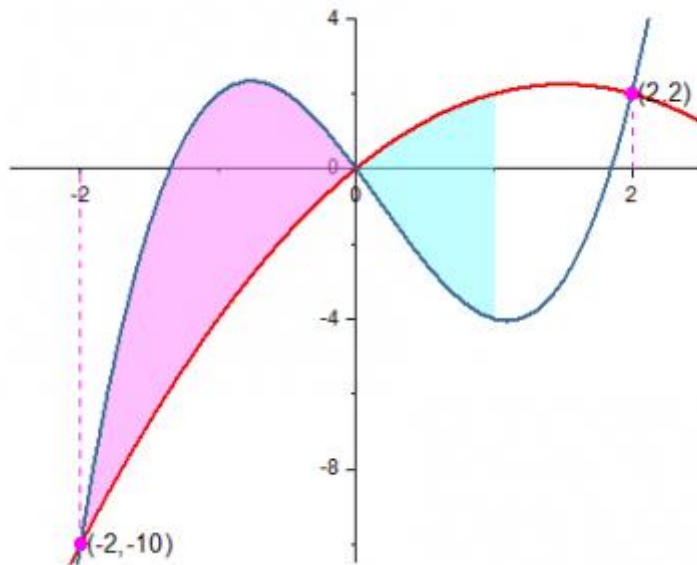

#### 6.7.3.3.4 Adding Function Formulas and Axis Arrows

- To hide the axis tick labels at (0,0), open the **Axis** dialog again and go to **Special Ticks** tab, then for the **Bottom** icon set as below and do the same for the **Left** icon.

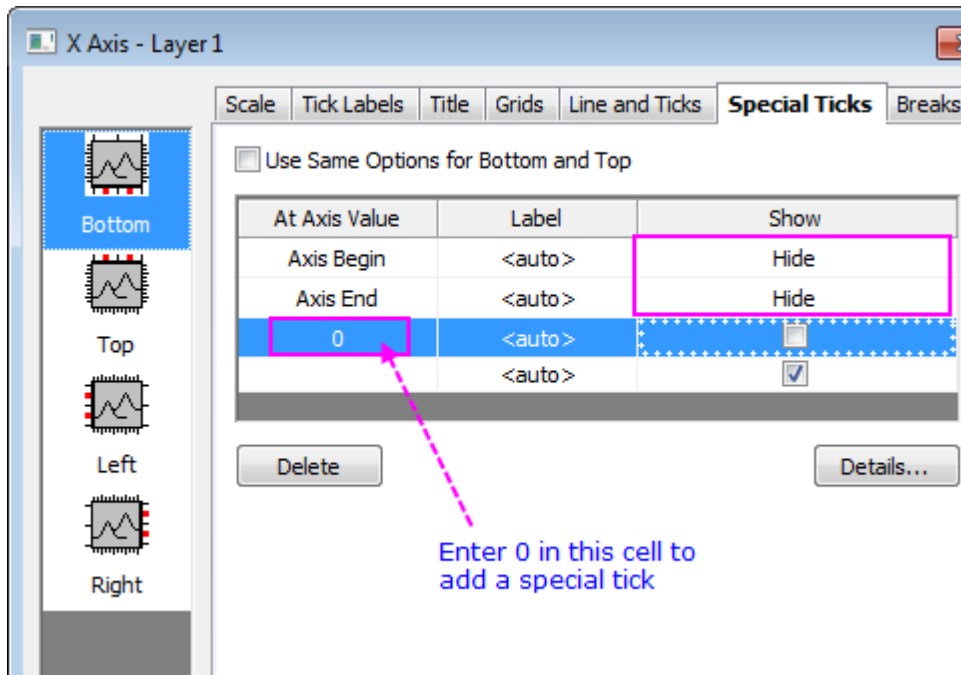

- To add arrows to the ends of the axes. Go to the **Line and Ticks** tab of **Axis** dialog. Select both **Bottom** and **Left** icon in the left panel of the **Axis** dialog. Expand **Arrow** node, check the **Arrow at End** checkbox, and then set **Width** to **5**.

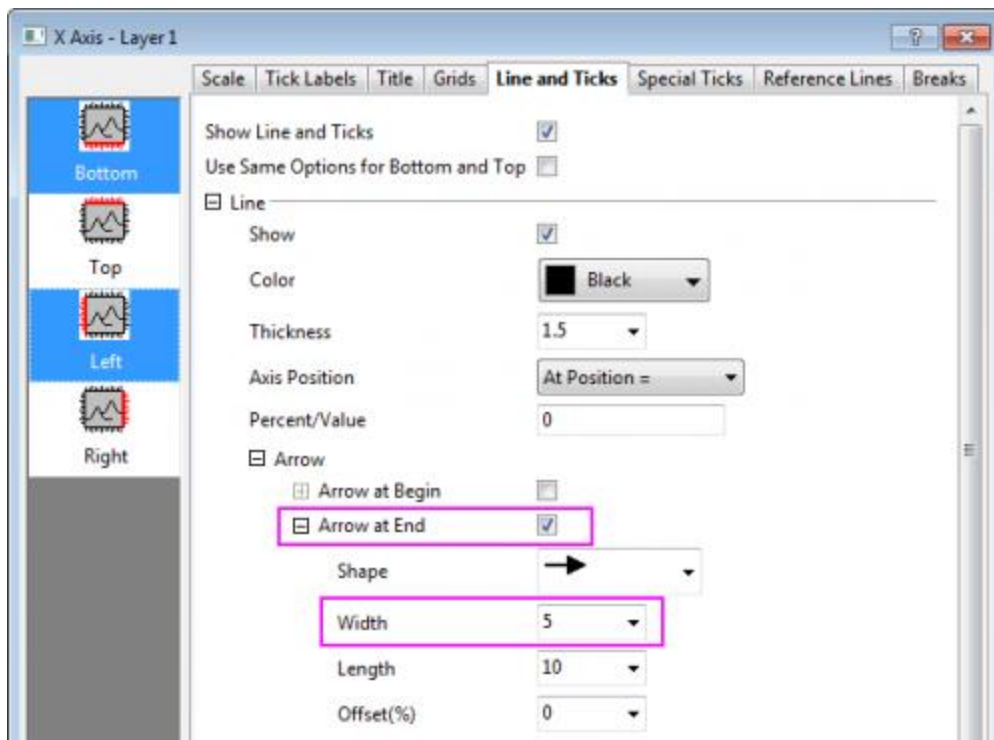

- Double-click on X axis to open the **Axis** dialog. Go to **Reference Lines** tab, enter **1** in the **Reference Lines at Value** text box, then click any place in the list table to add a reference line at X=1. Do the



settings as below:

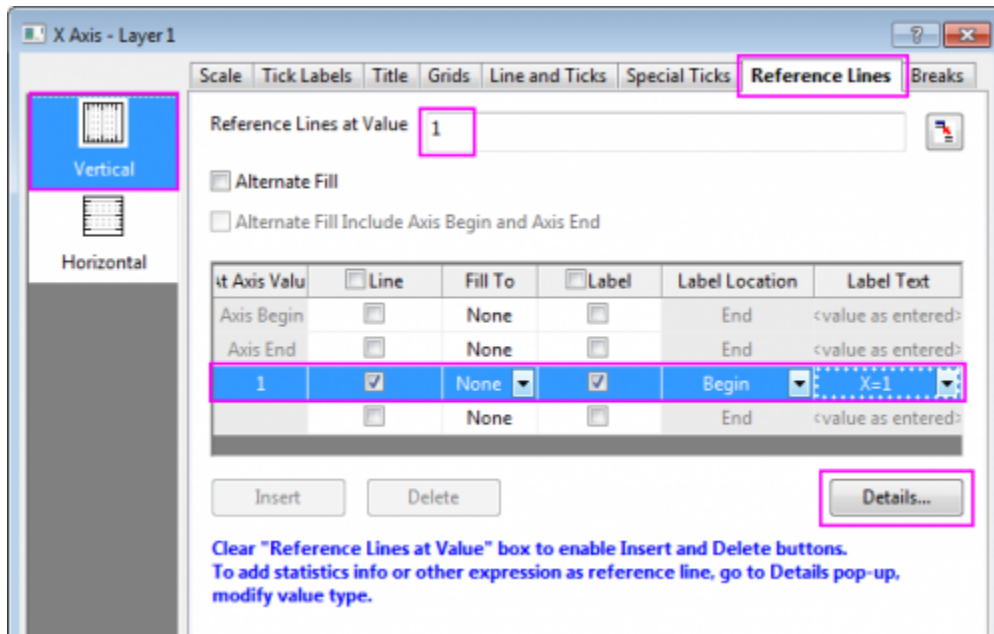

Click the **Details** button to set the line style.

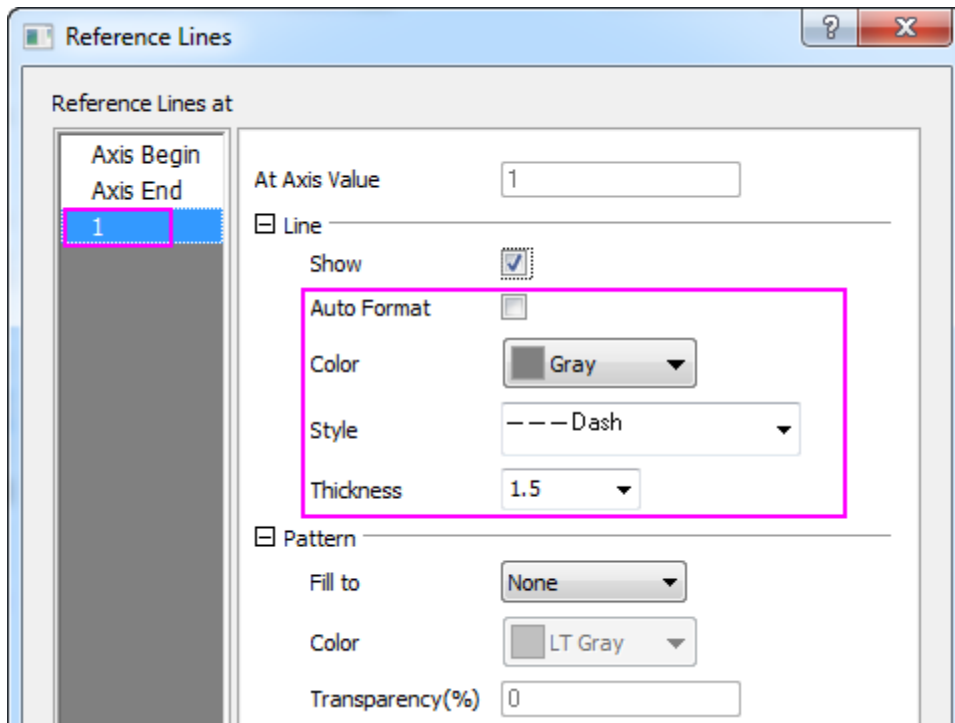

Click **OK** to close this dialog, and then click **OK** button to apply the settings and close the **Axis** dialog too.



You can also use the **Add Straight Line** tool (opened by selecting **Insert: Straight Line** menu) to add such a vertical straight line at **X=1**.

- To add the two curves' formulas to the graph, right-click on a blank area and choose **Add Text...**. Type any character into the object to create a text object firstly. And then right-click on it to select **Properties** from the context menu to open the **Object Properties** dialog. Enter the first formula in the **Text** tab.

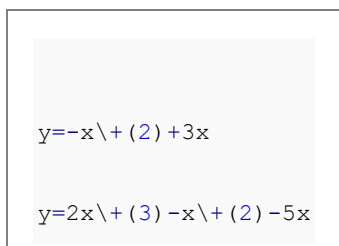

- Click OK button to close the dialog. Add one more text object and open **Text Properties** dialog again to enter the second formula above in **Text** tab. Click OK button again, then these two formulas have been added to the graph window both. Reposition them as needed.
- Select the **Curved Arrow Tool** and add two curved arrows to connect formula labels to line plots.

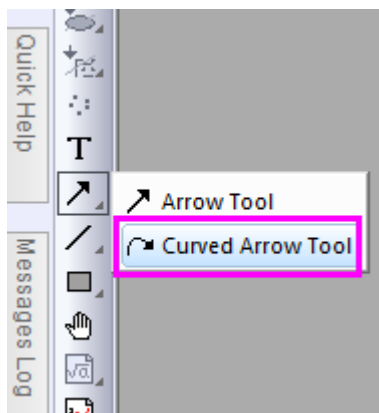

- Your final graph should look something like this:

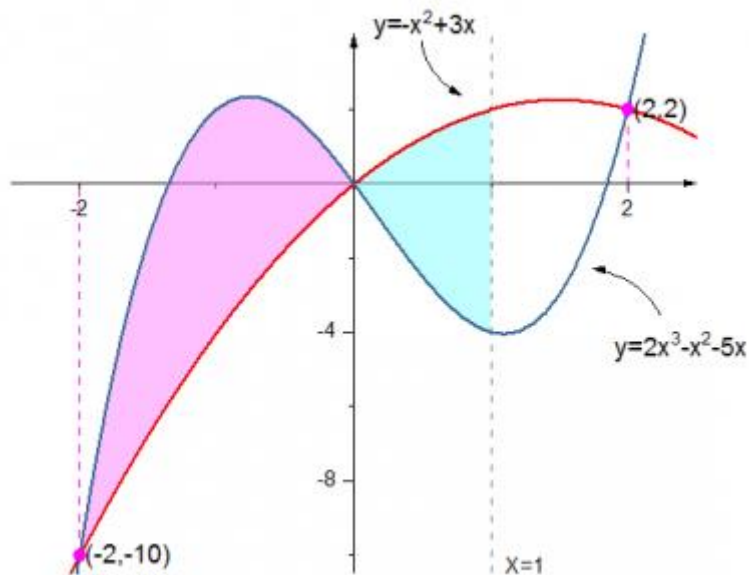

### 6.7.3.3.5 Generating Function Data using Set Values tool

1. Open a new workbook. Choose **Add New Columns** to the worksheet so there are 3 columns.
2. Right-click Col(A) and select **Fill Column with: A set of Numbers...**
3. In the **patternN** dialog box, set up the following parameters:

<b>From</b>	-2.5
<b>To</b>	2.5
<b>Increment</b>	0.1
<b>Mode</b>	<input checked="" type="radio"/> Repeat <input type="radio"/> Random
<b>Repeat Times for Each Value</b>	1
<b>Repeat Times for The Sequence</b>	1
<b>Total Number of Whole Set</b>	51
<b>display</b>	

4. Double-click on the **F(x)** label row of Col(B) to turn to the in-place edit mode, then enter  $-1*A^2+3*A$  as below.

	A(X)	B(Y)
Long Name		
Units		
Comments		
F(x)=		$-1*A^2+3*A$
1	-2.5	-13.75
2	-2.4	-12.96

**Note:** Since Origin 2017, a new control [Spreadsheet Cell Notation](#) has been added and turned on by default (you will see the icon  at the top-left corner of the worksheet), Origin supports to use column Short Name as notation in column formula, such as A+1 instead of col(A)+1.

For earlier version, you are supposed to enter  $-1*col(A)^2+3*col(A)$  instead.

- Highlight col(C) and right-click on it to select **Set Column Values** from context menu to open Set Values dialog. In this dialog, enter formula and the range definition as below:

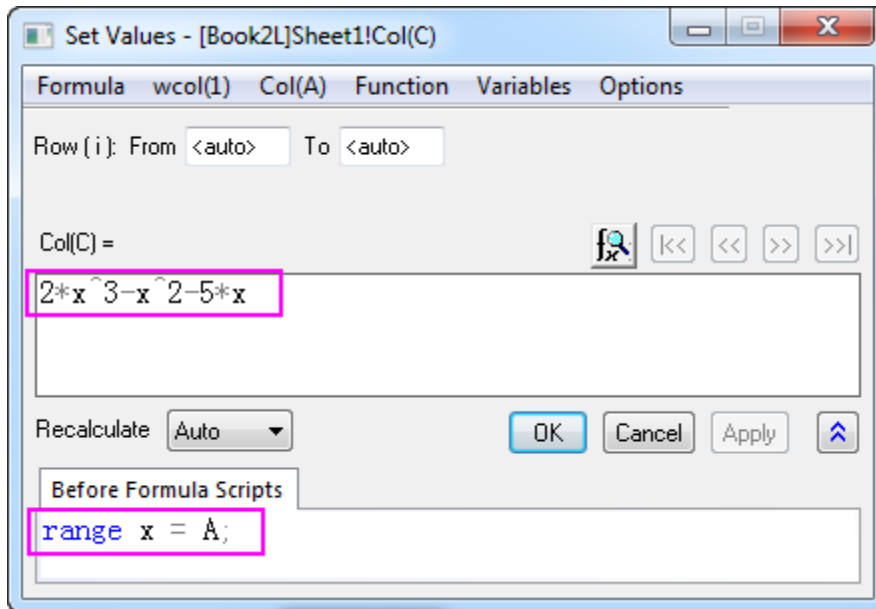

## 6.7.4 Line Graph with Recession Bars

### 6.7.4.1 Summary

This tutorial will show how to create a line graph with recession bars. This type of graph is common when plotting economics data with periods of recession marked as vertical bars.

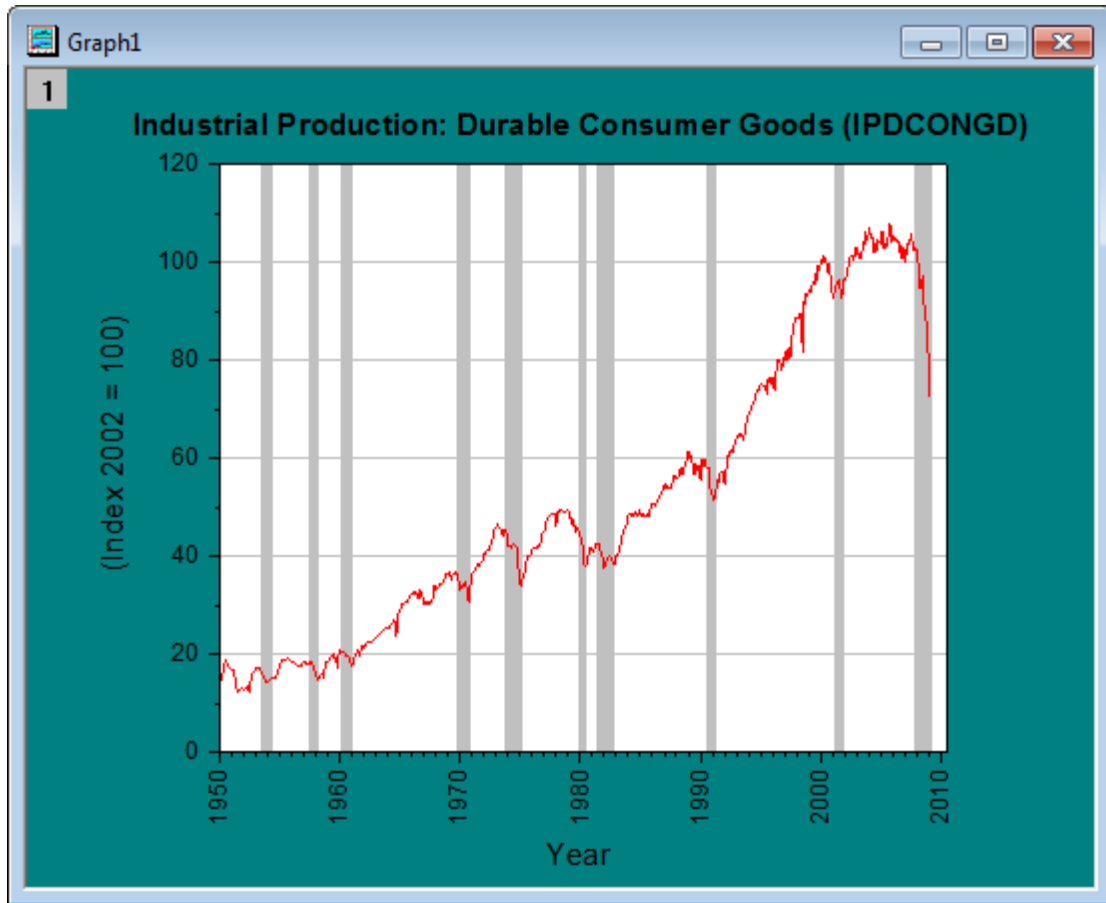

Minimum Origin Version Required: Origin 2017 SR0

#### 6.7.4.2 What you will learn

- Plot a line graph
- Add reference lines and fill paired reference lines to show recession bars
- Set date display format in the **Axis** dialog

#### 6.7.4.3 Steps

This tutorial is associated with <Origin EXE Folder>\Samples\Tutorial Data.opj. Open the **Recession Bars** folder from **Project Explorer** and the workbook *Book1G* is activated.

##### 6.7.4.3.1 Add Reference Lines and do Alternate Fill to add Recession Bars

1. Highlight col(A) and col(B) in the worksheet, choose **Plot > Basic 2D: Line** to create a line graph. Click on the line plot to select it and then use the **Line/Border Color** button  in **Style** toolbar to set its color to *red*.

- Double-click on X axis to open the Axis dialog. Go to **Reference Lines** tab, click the interactive button  beside the **Reference Lines at Value** text box to select col(C) from worksheet. Then the x coordinates of all recession periods will be listed in the display table as reference lines.

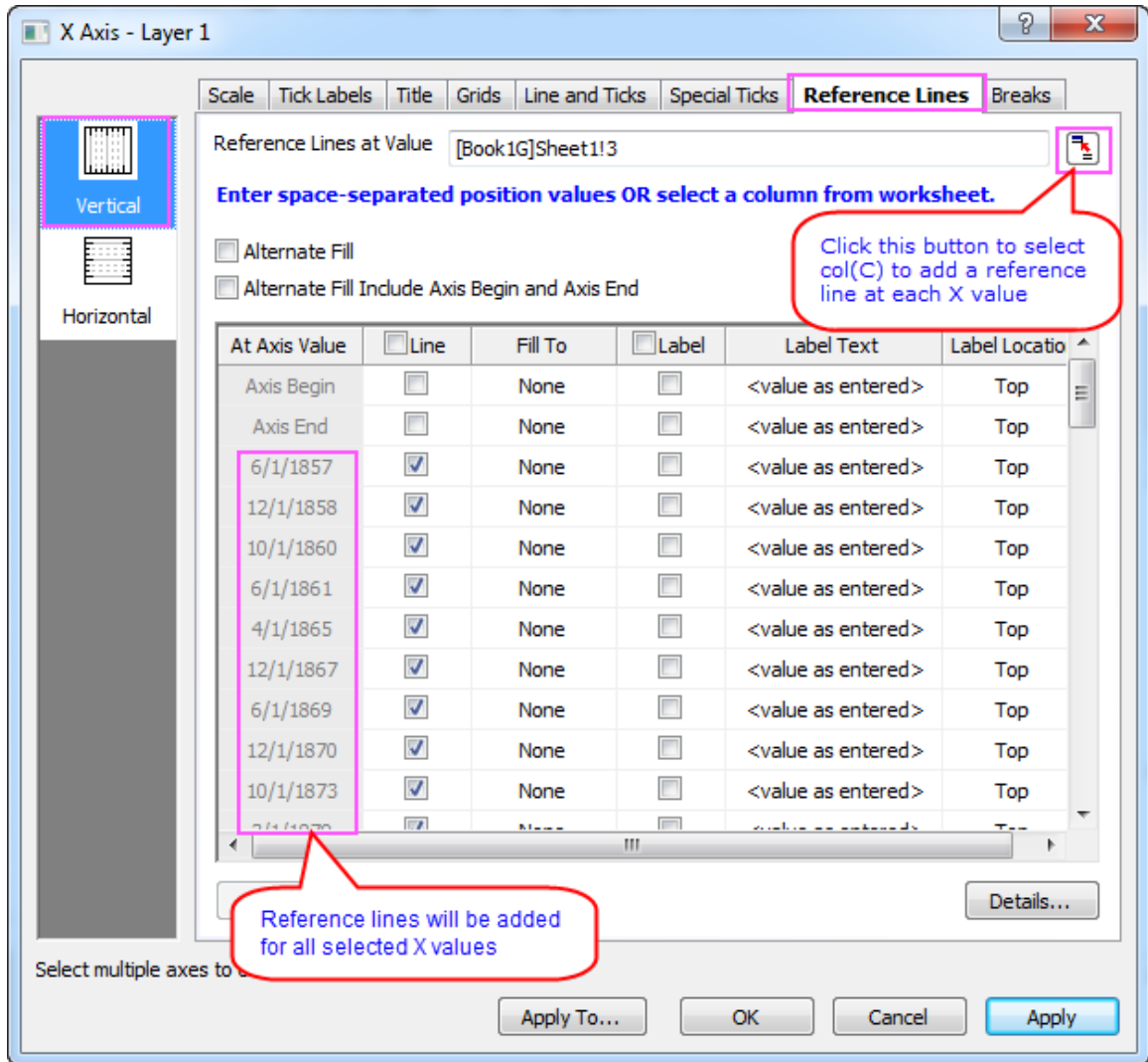

- Check **Alternate Fill** box to fill each period. And uncheck the **Line** check box to hide all reference lines (by checking the **Line** check box on **Line** column header and then unchecking it to remove all selections in this column).

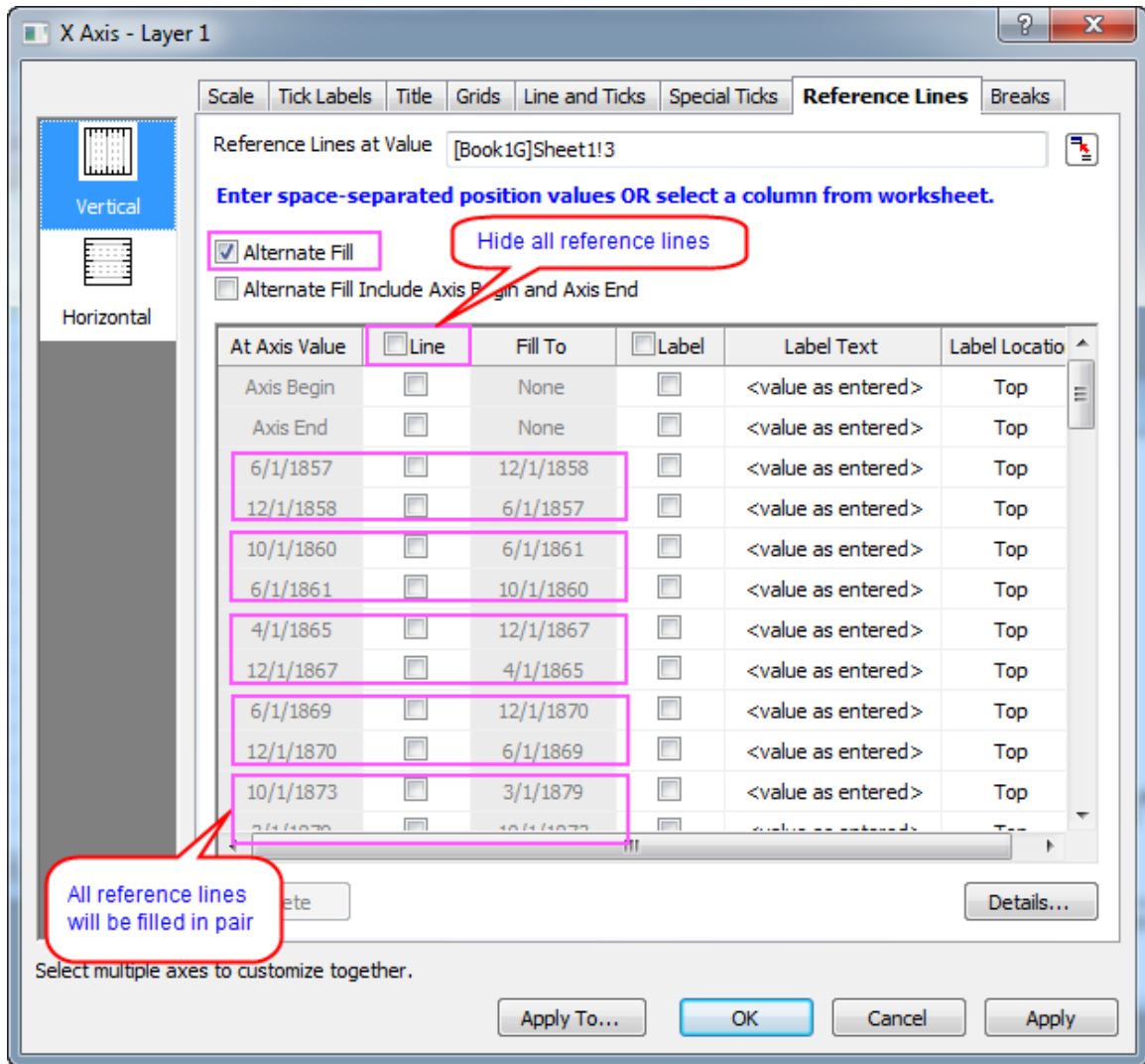

If you elect to show **Label Text**, you can choose <auto>, <value as entered> or enter your own custom string. For more information see [The Reference Lines Tab, Label Text](#).

## 1.2 Customize the Display of Graph

1. Click the Graph1 icon in the left panel (take care not to clear the check box beside it) and on the **Display** tab, set **Color** as **Dark Cyan**. Click the Layer1 icon, set the **Color** on the **Background** tab as **White**, clear the **Data on Top of Axes** check box and check **Frame** check box in the **Display** tab. Click **OK** to close this dialog.

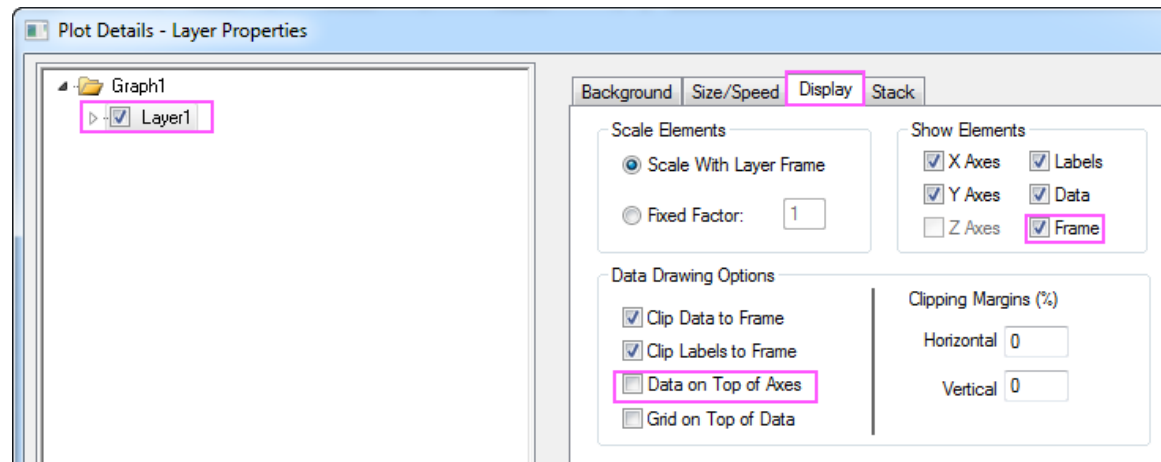
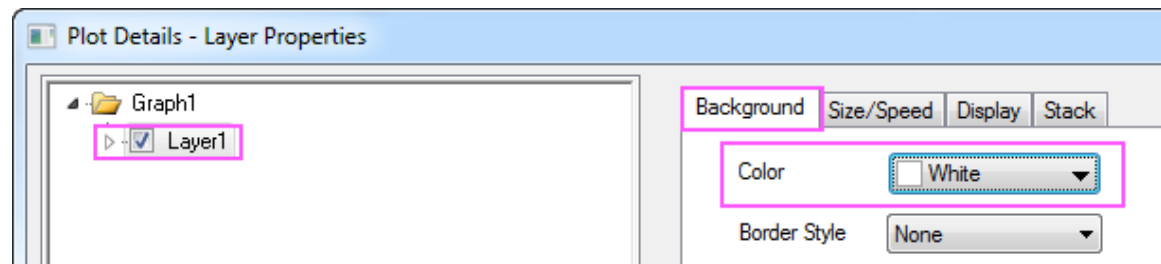
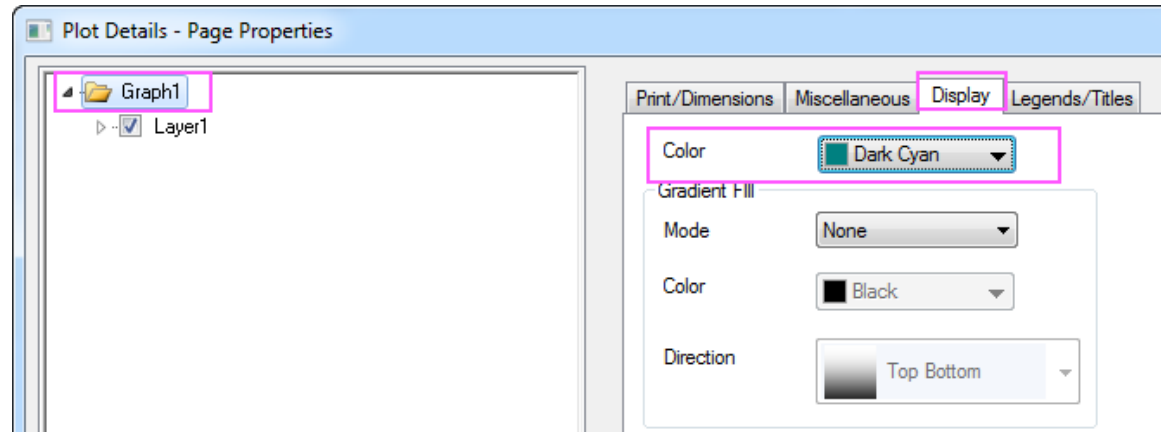

2. Double-click the X axis to open the **Axis** dialog. Click the **Tick Labels** tab, under **Display** page select **2016** from **Display** drop-down list.



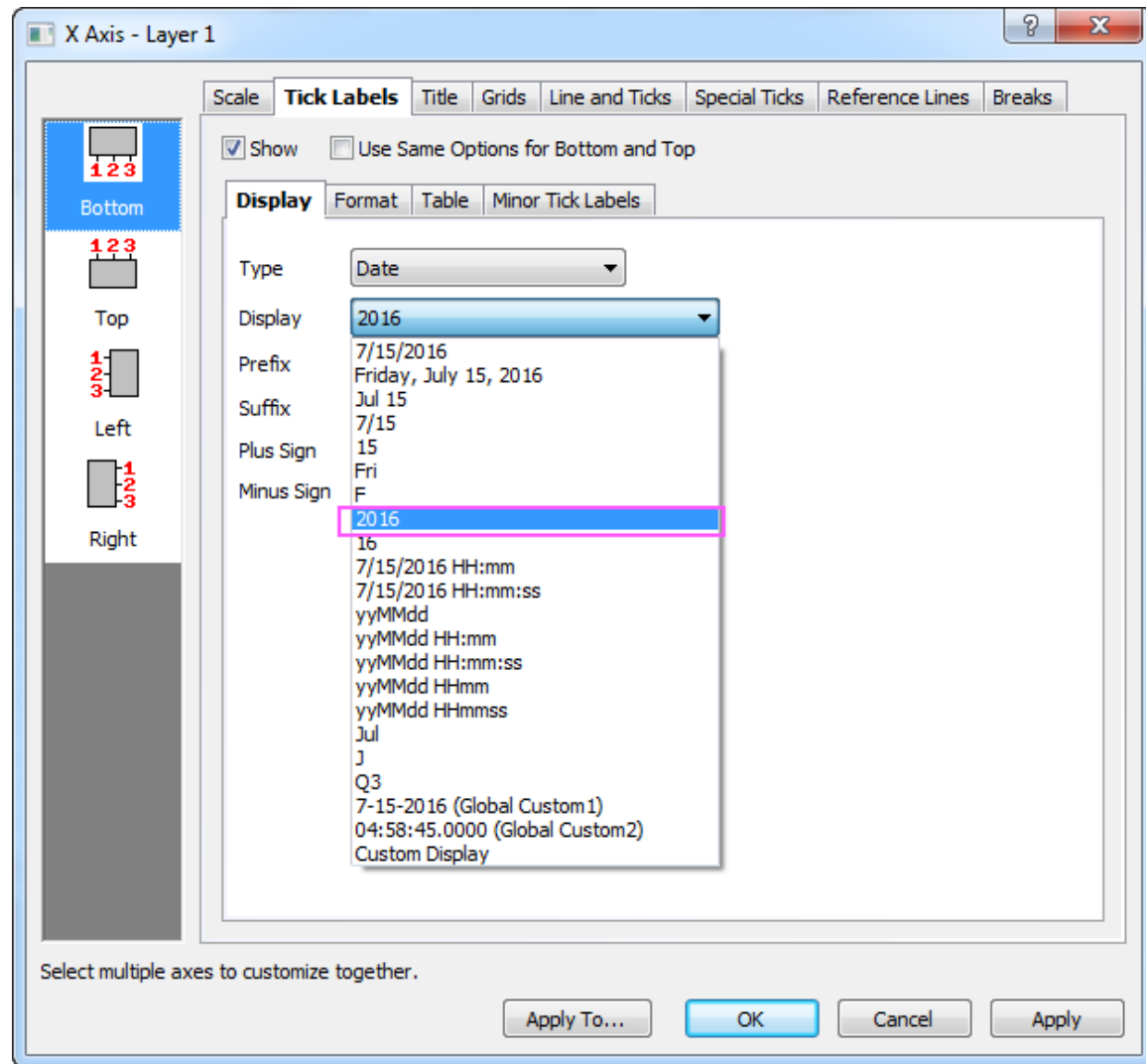

3. Go the **Format** page and change **Rotate (deg.)** to **90**, so that all tick labels will rotate 90 degrees. Click **Apply** to view the settings.

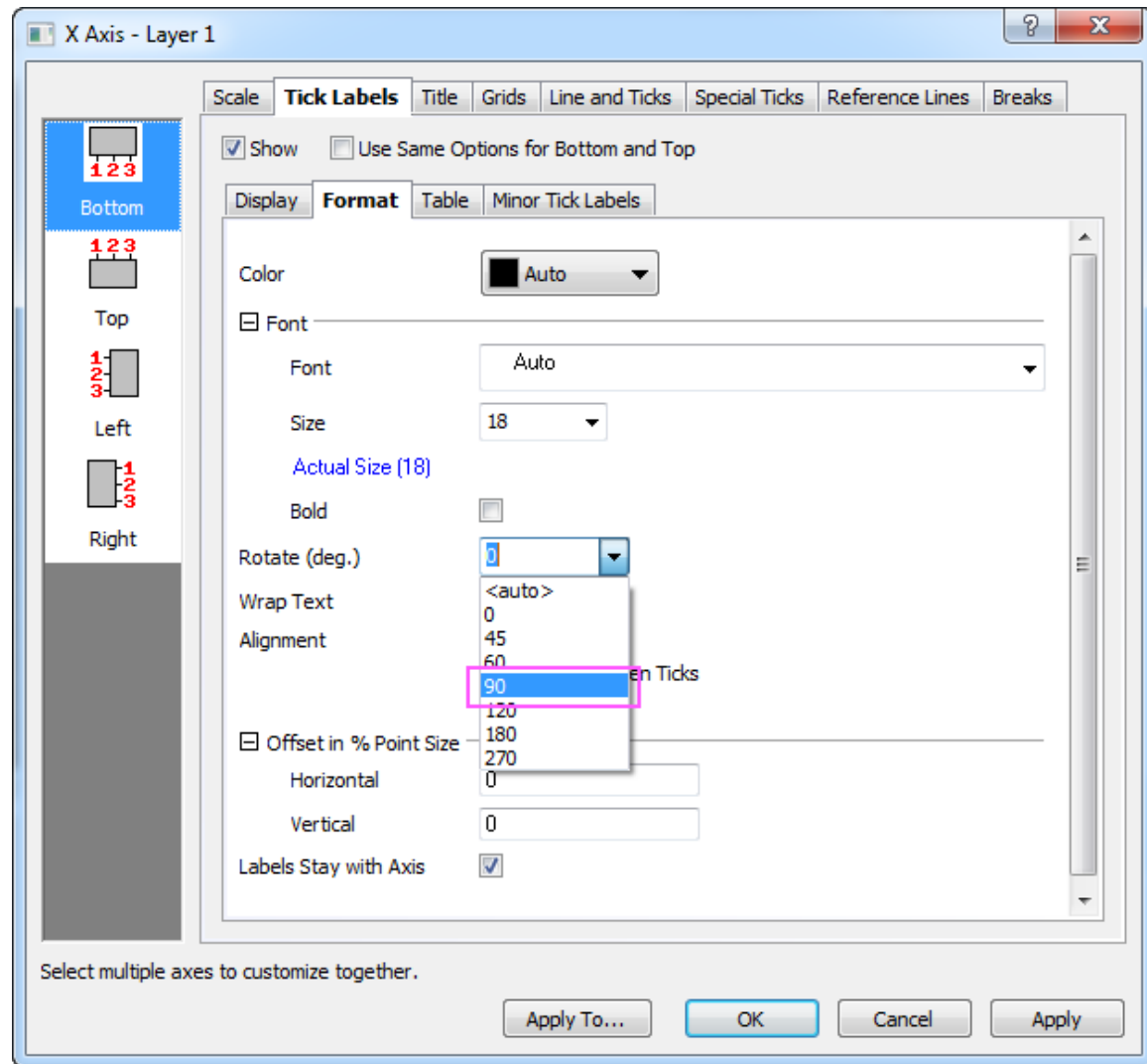

4. Go to the **Scale** tab and set the X axis scale as below:

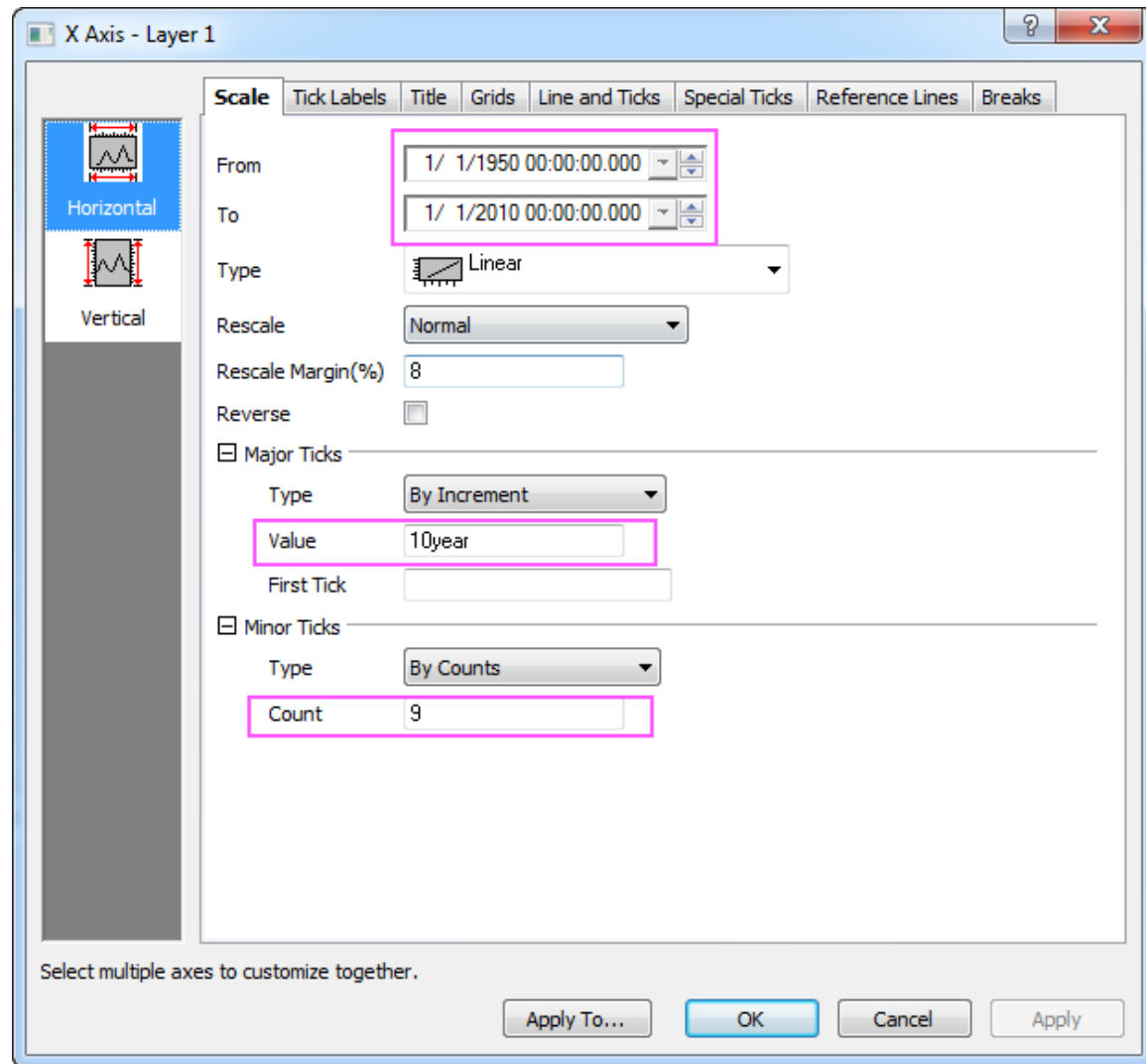

5. Go to the **Title** tab and change the content in **Text** box to **Year** to modify the X axis title.
6. Highlight **Left** icon on the left panel and change the Y axis title text to be **(Index 2002 = 100)** and click **Apply**.
7. Go to the **Scale** tab again and this time the **Vertical** icon is selected which indicates it is the **Scale** tab for Y axis, set the **From** value to 0. Click the **Apply** button.
8. Go to the **Grids** tab and show the major grid lines in **LT Gray** following the settings below:

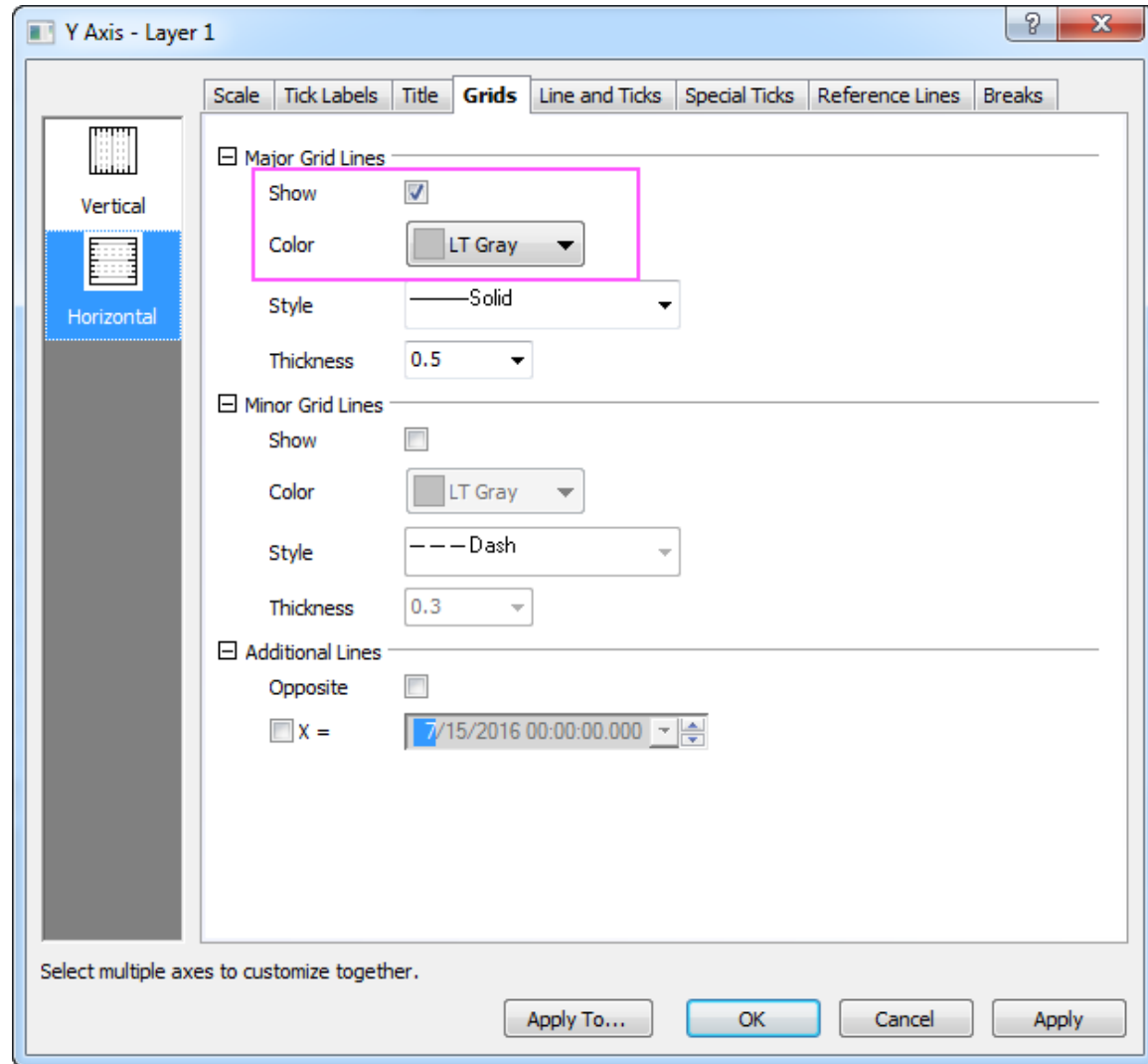

9. Click **OK** to apply the settings and close the dialog.
10. Go back to the graph and delete the legend. Right-click on the layer and select **Add/Modify Layer Title** to add a title. Type *Industrial Production: Durable Consumer Goods (IPDCONGD)* in the text box. Highlight the text and click the **B** button on the **Format** toolbar. Adjust the text to an appropriate size by typing or selecting a number in the **Font Size**  list in the **Format** toolbar. You should get the following graph.

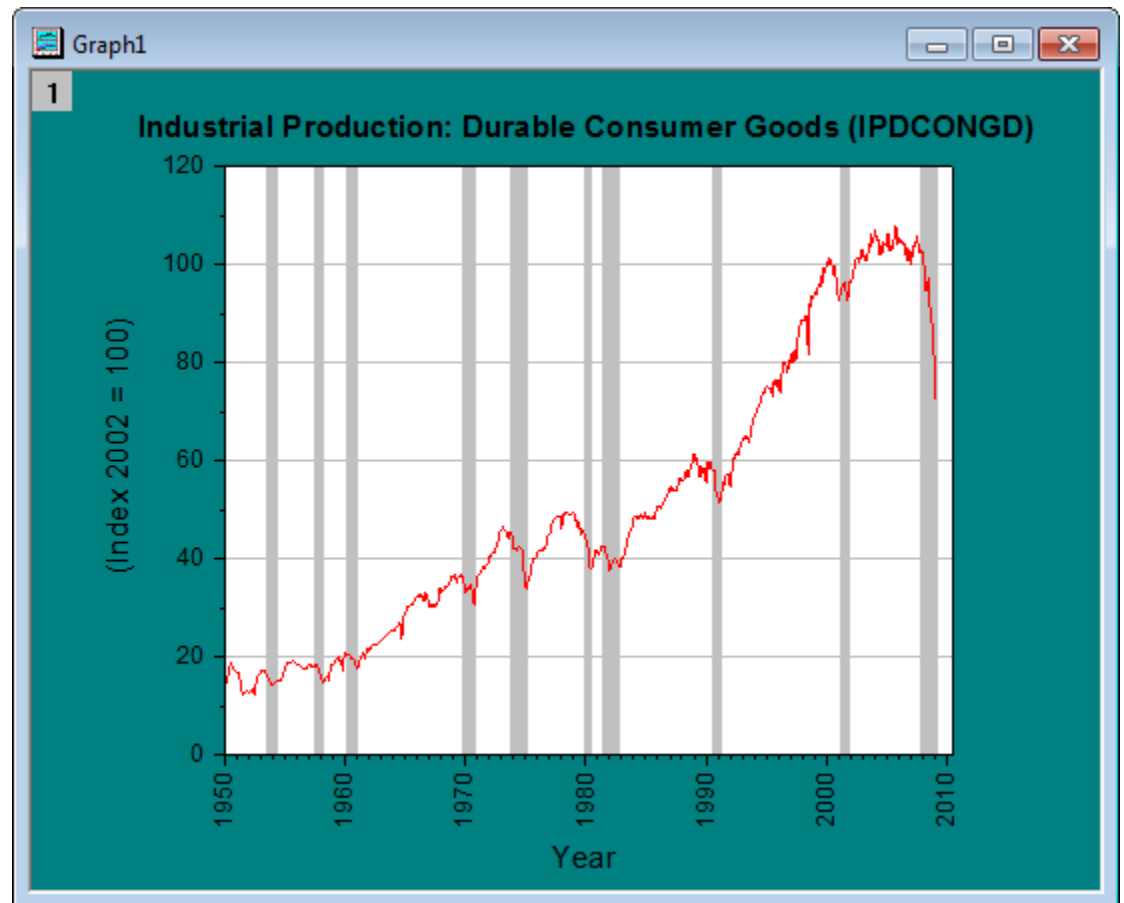

## 6.7.5 Scatter Plot of Decay and Recovery Curves

### 6.7.5.1 Summary

The scatter plot below depicts 3 decay and recovery curves obtained after taking two-photon fluorescence measurements of reversible photodegradation in a dye-doped polymer. To learn more about the graph, please read the [case study](#).

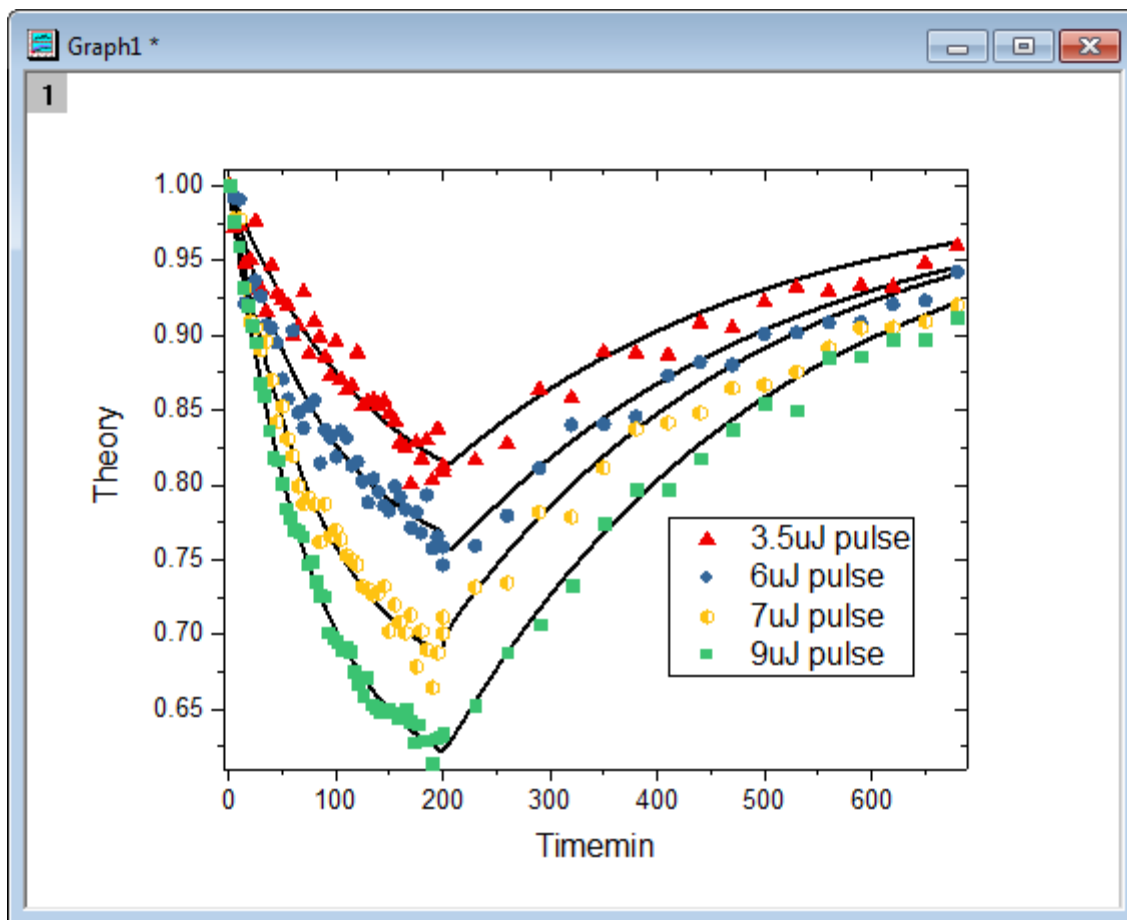

Minimum Origin Version Required: Origin 2016 SR0

#### 6.7.5.2 What you will learn

- How to use the **Plot Setup** dialog to arrange plots in a layer
- How to customize the symbols in your graph

#### 6.7.5.3 Steps

1. Download the zip file from [here](#) and extract the text files .

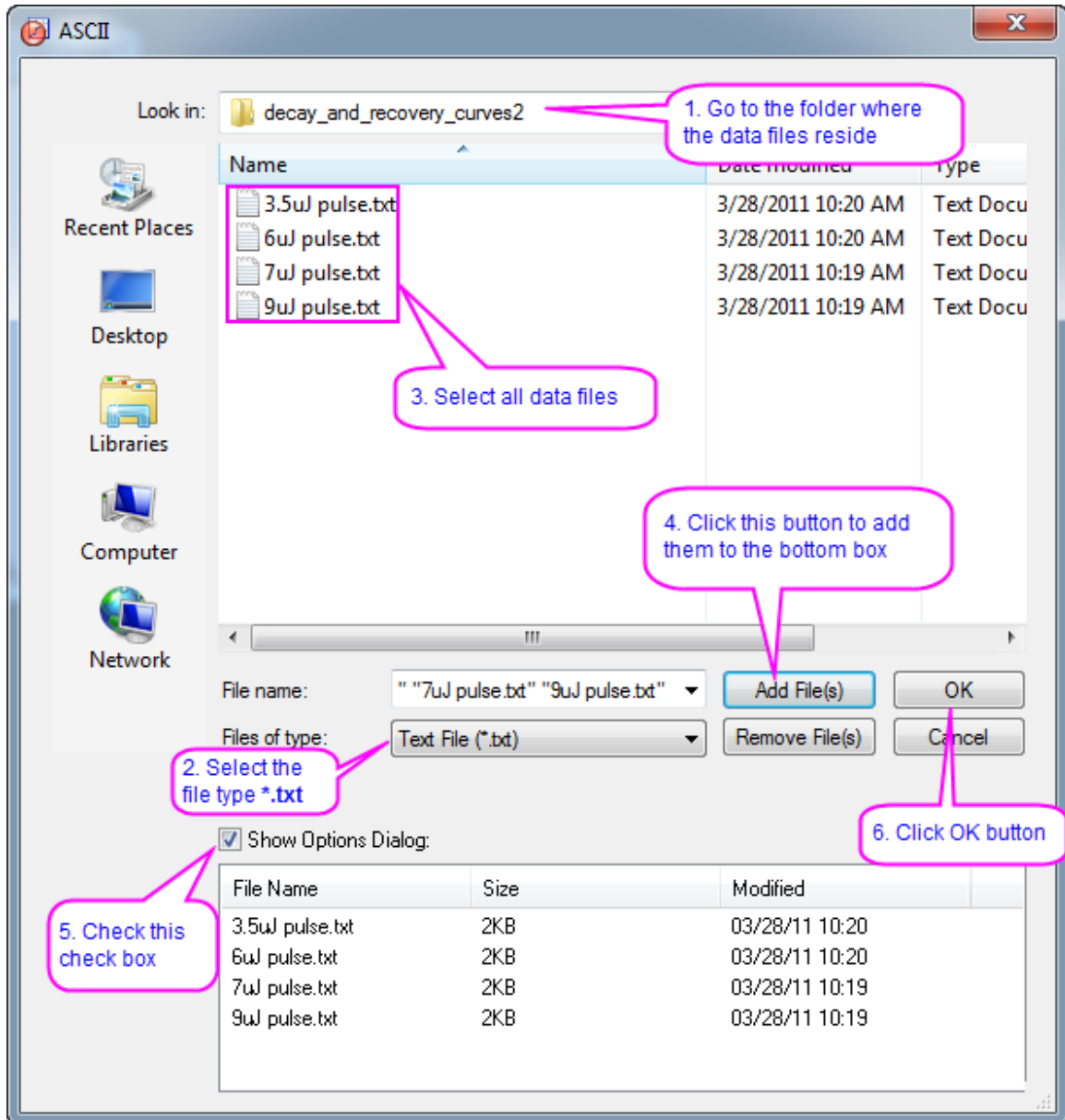

2. Open Origin and click the **Import Multiple ASCII** button  on the **Standard** toolbar to open the **ASCII** dialog and then import the text files.

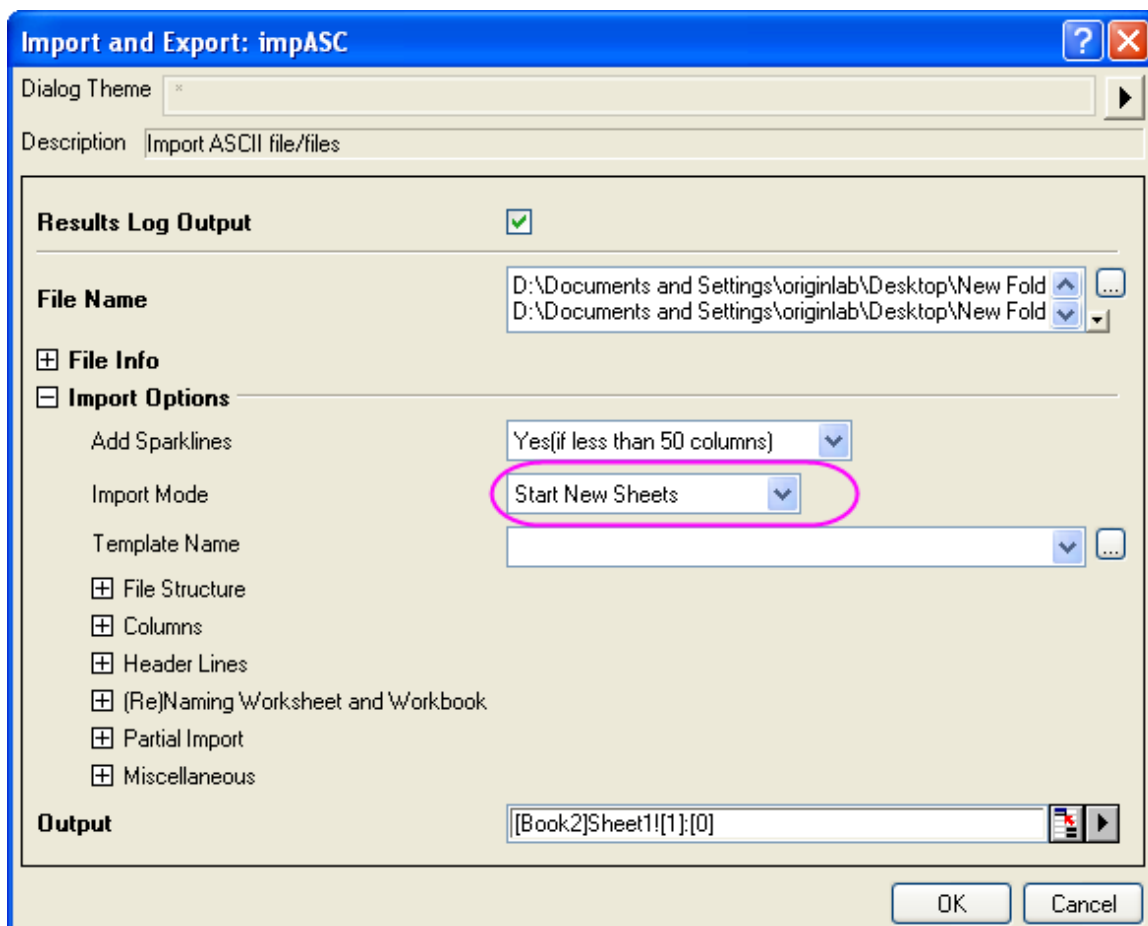

- In the **impASC** dialog, set **Import Mode** as **Start New Sheets**. Click OK to finish importing.



- We will use the Plot Setup dialog to create a graph with 8 plots. Active the workbook, and make sure that no datasets are now selected. Click the  button on the **2D Graphs** toolbar to open the **Plot Setup** dialog.

Show all of the three panels of **Plot Setup** dialog (if not all of them are shown) by clicking the  and  buttons.

First, we will add 4 line plots into a graph by using the Plot Details dialog. Highlight all dataset in the top panel, and then select column **Timemin** as X, column **Theory** as Ys in the middle panel. Then add them into the bottom panel.

Then we will add 4 scatter plots in to the same graph. Select **Scatter** from the **Plot Type** drop-down list, make sure all dataset in the top panel has been selected, and then select column **Timemin** as X, column



**NormData** as Ys in the middle panel. Then add them into the bottom panel.



The screenshot shows the 'Plot Setup: Select Data to Create New Plot' dialog box. It is divided into three main panels. The top panel, 'Available Data', contains a table of data sources. The middle panel, 'Plot Type', shows a list of plot types with checkboxes for X, Y, YEr, and L. The bottom panel, 'Plot List', shows a list of plots with their ranges and scaling options. Callouts provide instructions: 'Hold down the CTRL key, and the select all the sheets that have the just imported data.' (pointing to the 'Available Data' table), 'Select Scatter from the Plot Type drop-down list.' (pointing to the 'Scatter' option in the 'Plot Type' list), 'Set col(A) as X, Col(D) as Y.' (pointing to the 'X' and 'Y' checkboxes in the 'Plot Type' table), and 'Click the Add button after setting the X and Ys to add these Plots into the bottom panel.' (pointing to the 'Add' button).

Long Name	Sheet	Cols	Rows	File Name	File Date	Created
9uJ pulse.txt	3.5uJ pulse	4	60	3.5uJ pulse.txt	3/28/2011	7/4/2011 11:45:21
9uJ pulse.txt	6uJ pulse	4	60	3.5uJ pulse.txt	3/28/2011	7/4/2011 11:45:21
9uJ pulse.txt	7uJ pulse	4	60	3.5uJ pulse.txt	3/28/2011	7/4/2011 11:45:21
9uJ pulse.txt	9uJ pulse	4	90	3.5uJ pulse.txt	3/28/2011	7/4/2011 11:45:21

X	Y	YEr	L	Column	Long Name	Comments	Sampling Interval	Position
<input type="checkbox"/>	<input type="checkbox"/>	<input type="checkbox"/>	<input type="checkbox"/>	<auto>	From/Step=			0
<input checked="" type="checkbox"/>	<input type="checkbox"/>	<input type="checkbox"/>	<input type="checkbox"/>	A	Timemin			1
<input type="checkbox"/>	<input type="checkbox"/>	<input type="checkbox"/>	<input type="checkbox"/>	B	Data			2
<input type="checkbox"/>	<input type="checkbox"/>	<input type="checkbox"/>	<input type="checkbox"/>	C	Theory			3
<input type="checkbox"/>	<input checked="" type="checkbox"/>	<input type="checkbox"/>	<input type="checkbox"/>	D	NormData			4

Plot	Range	Show	Plot T
Layer 1	<input checked="" type="checkbox"/> Rescale	<input checked="" type="checkbox"/>	
Group			
[9uJ pulse.txt]3.5uJ pulse! "Timemin"(X), "Theory"(Y)	[1*:58*] 0 < X < 680 , 0.81 < Y < 0.99894	<input checked="" type="checkbox"/>	Line
[9uJ pulse.txt]6uJ pulse! "Timemin"(X), "Theory"(Y)	[1*:58*] 1 < X < 680 , 0.75 < Y < 0.99823	<input checked="" type="checkbox"/>	Line
[9uJ pulse.txt]7uJ pulse! "Timemin"(X), "Theory"(Y)	[1*:58*] 0 < X < 680 , 0.68655 < Y < 1.00038	<input checked="" type="checkbox"/>	Line
[9uJ pulse.txt]9uJ pulse! "Timemin"(X), "Theory"(Y)	[1*:67*] 1 < X < 680 , 0.62 < Y < 0.99586	<input checked="" type="checkbox"/>	Line



In order to show all three panels in **Plot Setup** dialog, please expand **Plot Type** panel by clicking  and expand **Available Data** panel by clicking  again.

Please refer to [Plotting using Plot Setup](#) for more information.

5.

In bottom panel, if there is a **Group** branch under **Layer1**, right-click on it to select **Ungroup** from the short-cut menu to ungroup these plots.

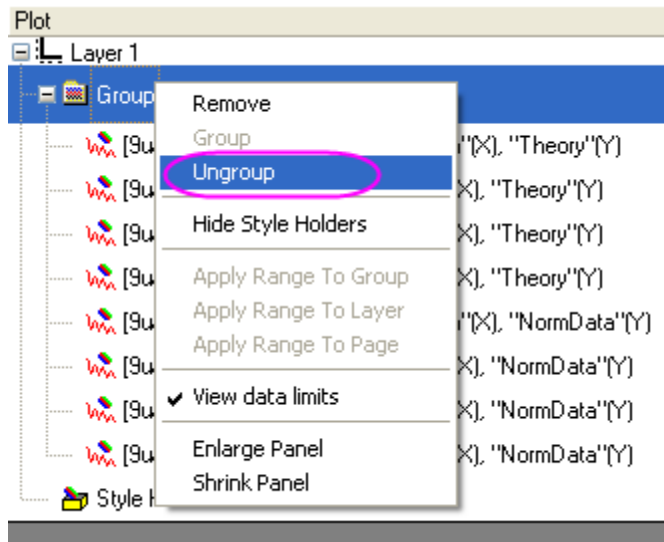

Click **OK** to generate the graph which look like the following image shows.

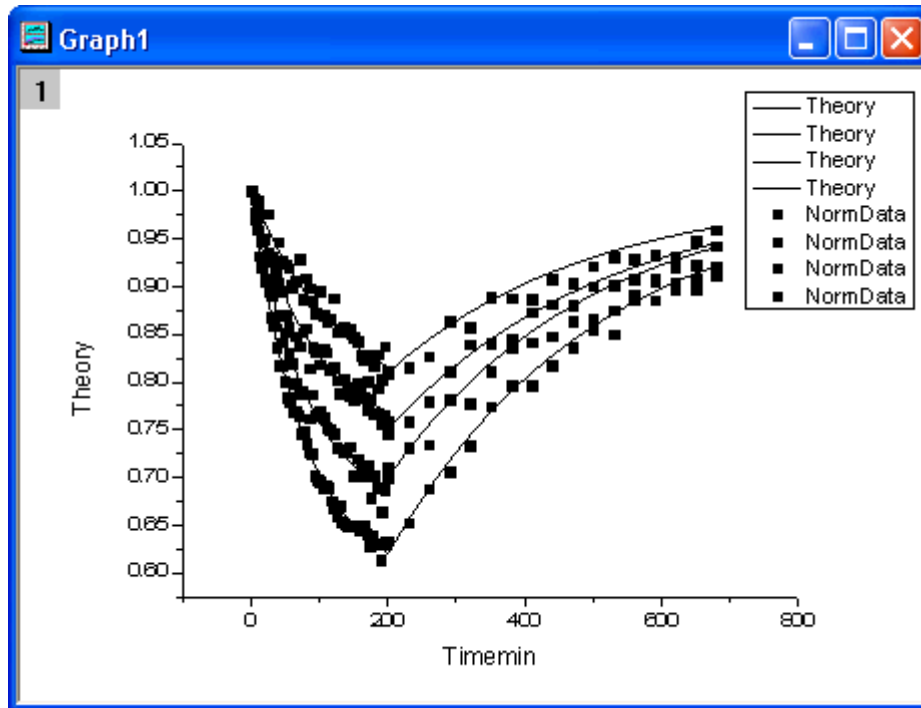

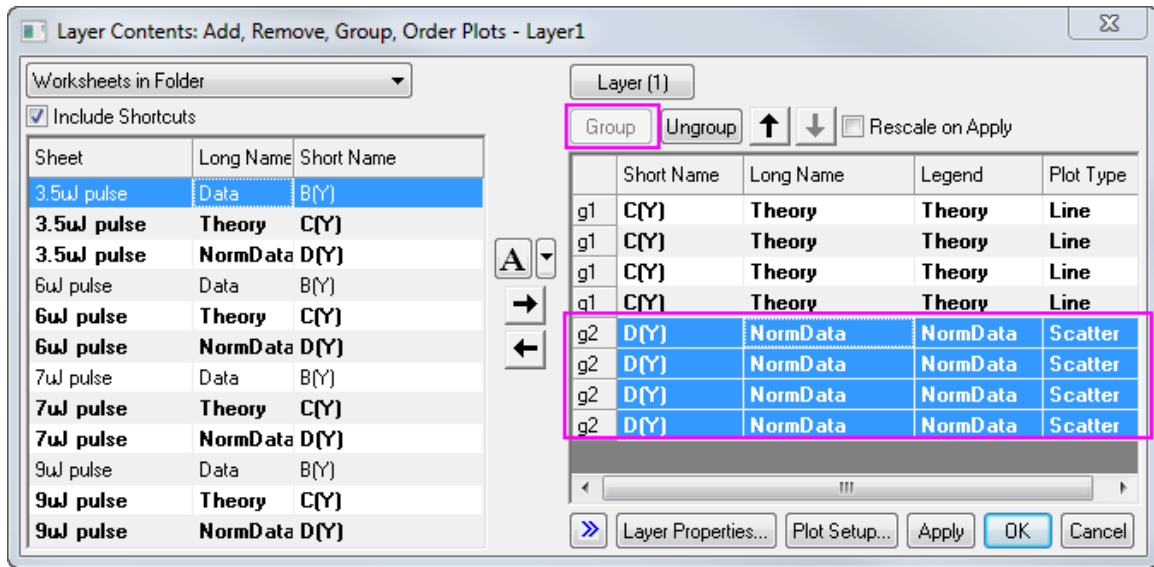

- Double-click the layer icon at the top-left corner of graph window to open the **Layer Contents** dialog. Then group the **Theory** plots and **NormData** Plots as Group 1 and Group 2 using the **Group** button after

highlight the 4 Theory/Norma Data plots separately by using mouse and the **Shift** key,

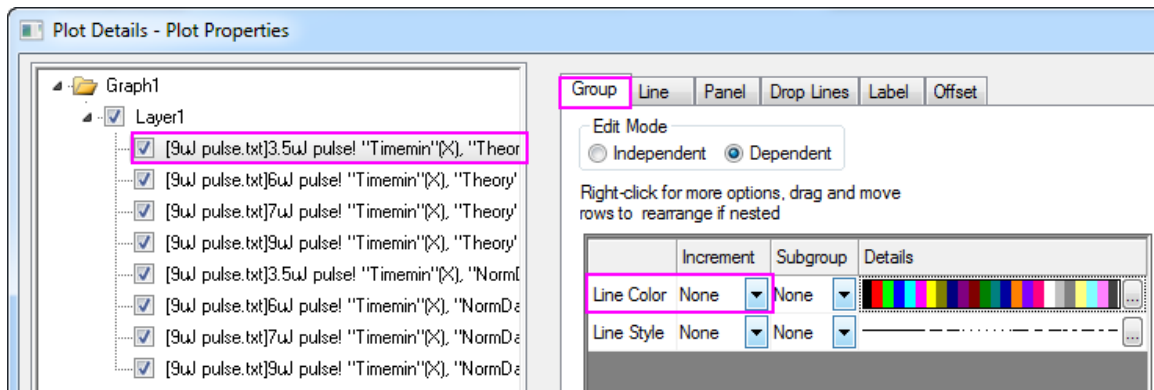

- Then we will customize the 8 plots in the Plot Details dialog. Select **Format: Plot** to open the Plot Details dialog. In the left panel of the dialog, you could see there are 8 plots: the first 4 plots are line plots, the other 4 are scatter plots.
- We will first customize the 4 line plots. Open **Plot Details** by double clicking the plot. On the left panel, 4 line plots are put ahead of the 4 scatter plots. You can select the first line plot by selecting the first plot under *Layer 1* in this panel then go to **Line** tab. Select **B-Spline** from the **Connect** drop down list and set the **Width** to **3**. Then click the **Apply** button. In the **Group** tab, select None for the **increment** cell in **Line Color** row. Click OK to apply these settings.



- Then customize the 4 scatter plots. Go to **Plot Detail** and then select the fifth plot in the left panel, which should be the first scatter plot. Go to **Symbol** tab, change the **Size** to **8** and **Edge Thickness** to **0**. In the **Group** tab, we will mainly customize the symbols in the list box that in the middle of the tab. In the **Symbol Type** row, select **By one** in the **Increment** column. Click the  button to open the **Increment Editor** dialog, in the dialog select **UpTriangle**, **Circle**, **Hexagon** and **Square** for the first 4 rows. In the **Symbol Edge Color** row, select **By one** in the **Increment** column. In the **Details** column, click the color list to select the list *Q11: Candy* from the color list drop-down list.

In the **Symbol Interior** row, select **By one** in the **Increment** column. Click the  button to open the **Increment Editor** dialog, in the dialog select **Solid**, **Solid**, **Half Left** and **Solid** for the first 4 rows. Click

OK button to close the Plot Details dialog, then the graph will look like.

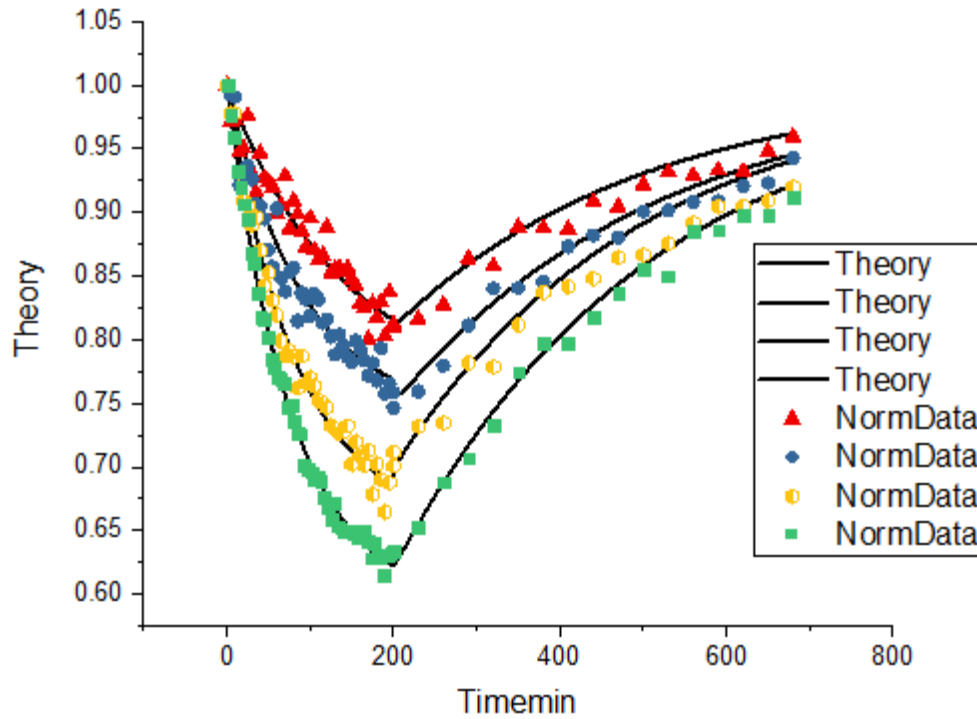

10. Then customize the Axes of the graph. Double click on the X axis to enter Axis Dialog.

First, we customize the axes scale. Go to **Horizontal** icon in **Scale** tab, change **From** to -5, **To** to 690; set *Major Ticks* Type as **By Increment** and **Value** as 100, respectively. Repeat these steps to customize the Y axis range ( the **Vertical** icon) as **From** to 0.61 and **To** to 1.01, and **Value** as 0.05.

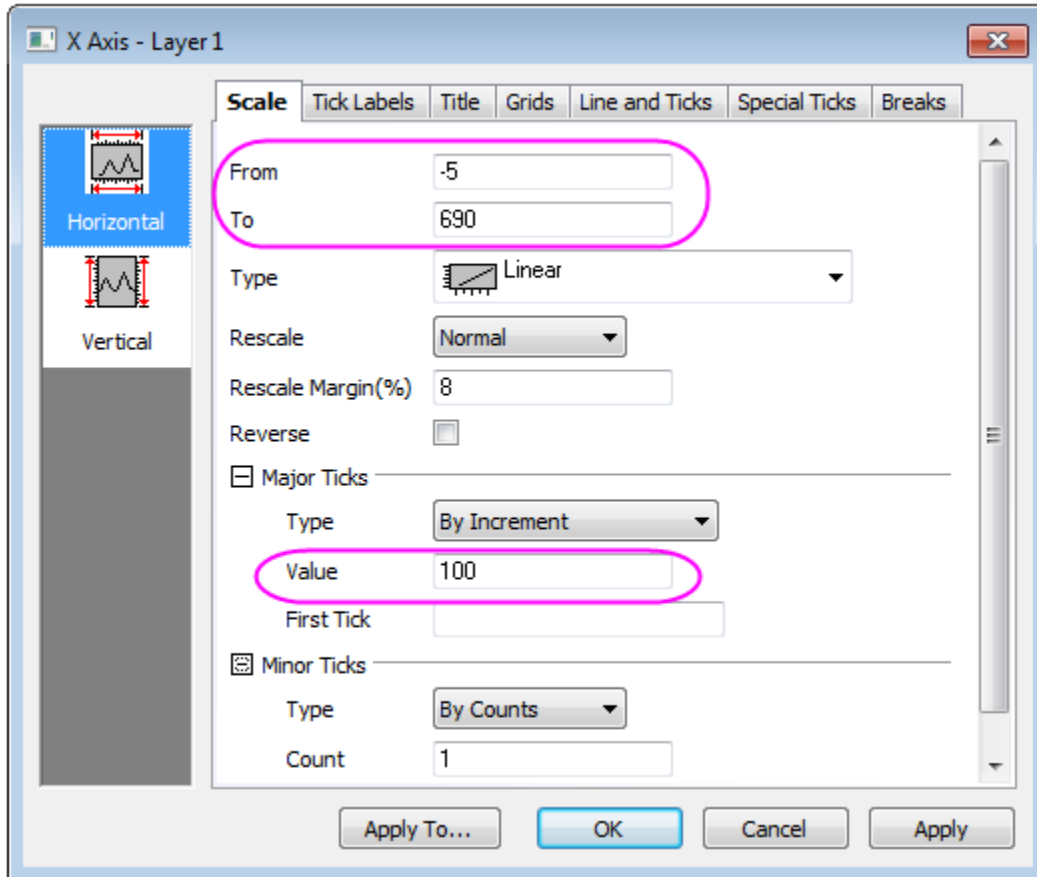

To customize the Axis Ticks, select **Top** icon in **Line and Ticks** tab, enable the **Show** check box, then go to **Top** icon in **Line and Ticks** tab, select **In** from both *Major Ticks* and *Minor Ticks* drop-down lists.

Repeat the same steps for Right Axis under **Right** icon.

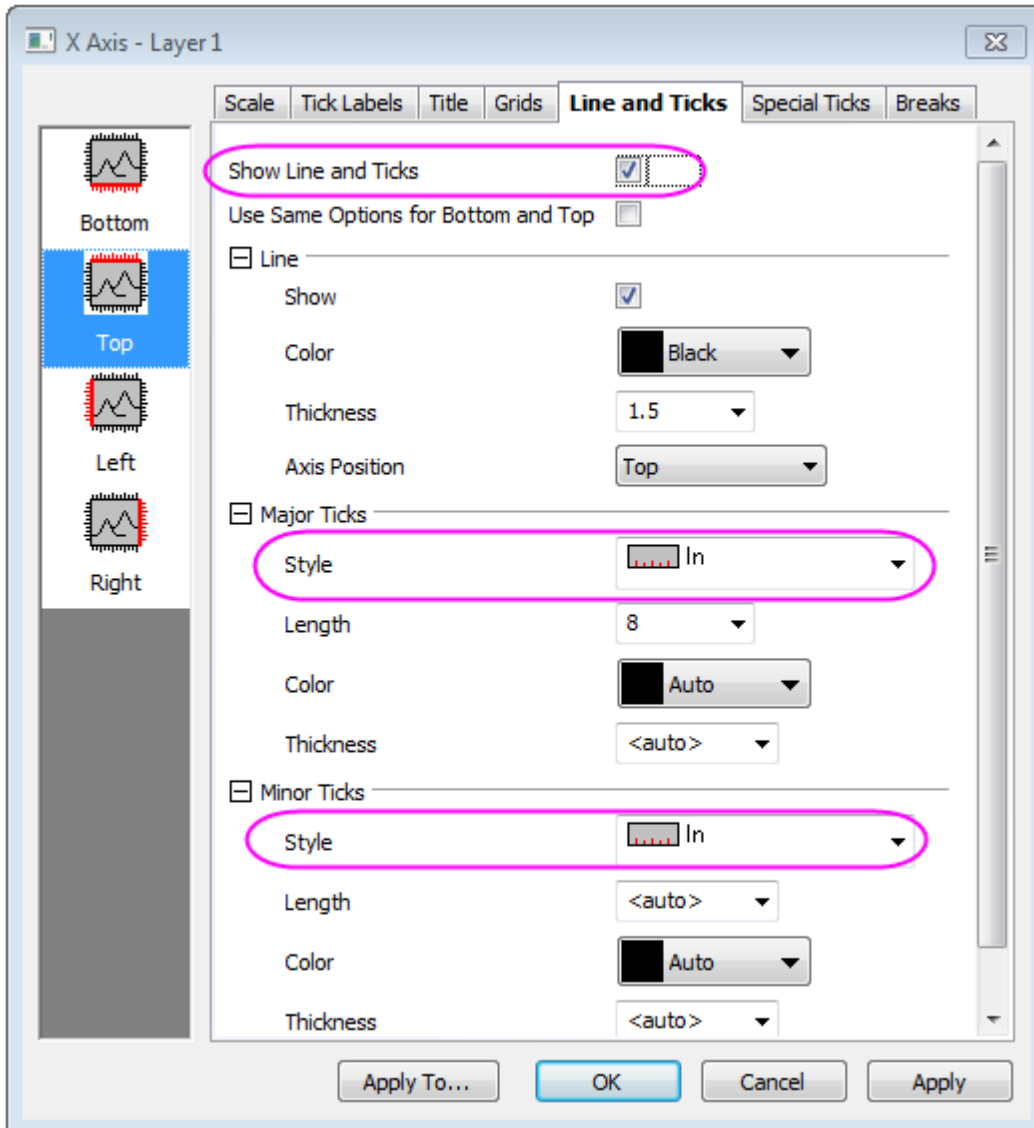

- Then you will will customize the titles and the legend. Change the titles follows the images shows. Right click on the legend and select **Legend:Update Legend** from the context menu to open **legendupdate** dialog. In this dialog, do the following:

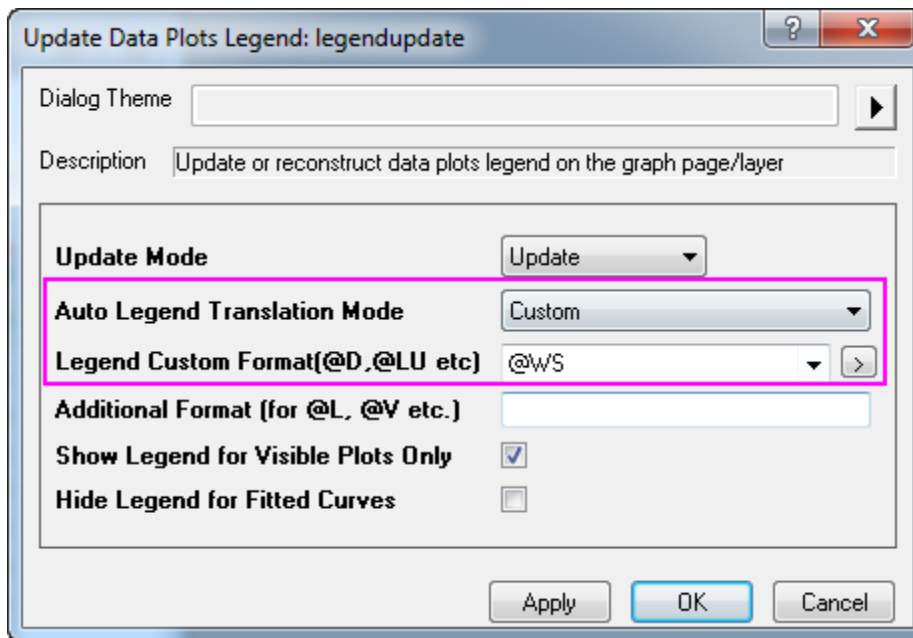

Click Ok to close this dialog. Then the legend will update. Double-click on it to turn to the in-place edit mode, remove the first four rows.

The final graph will look like

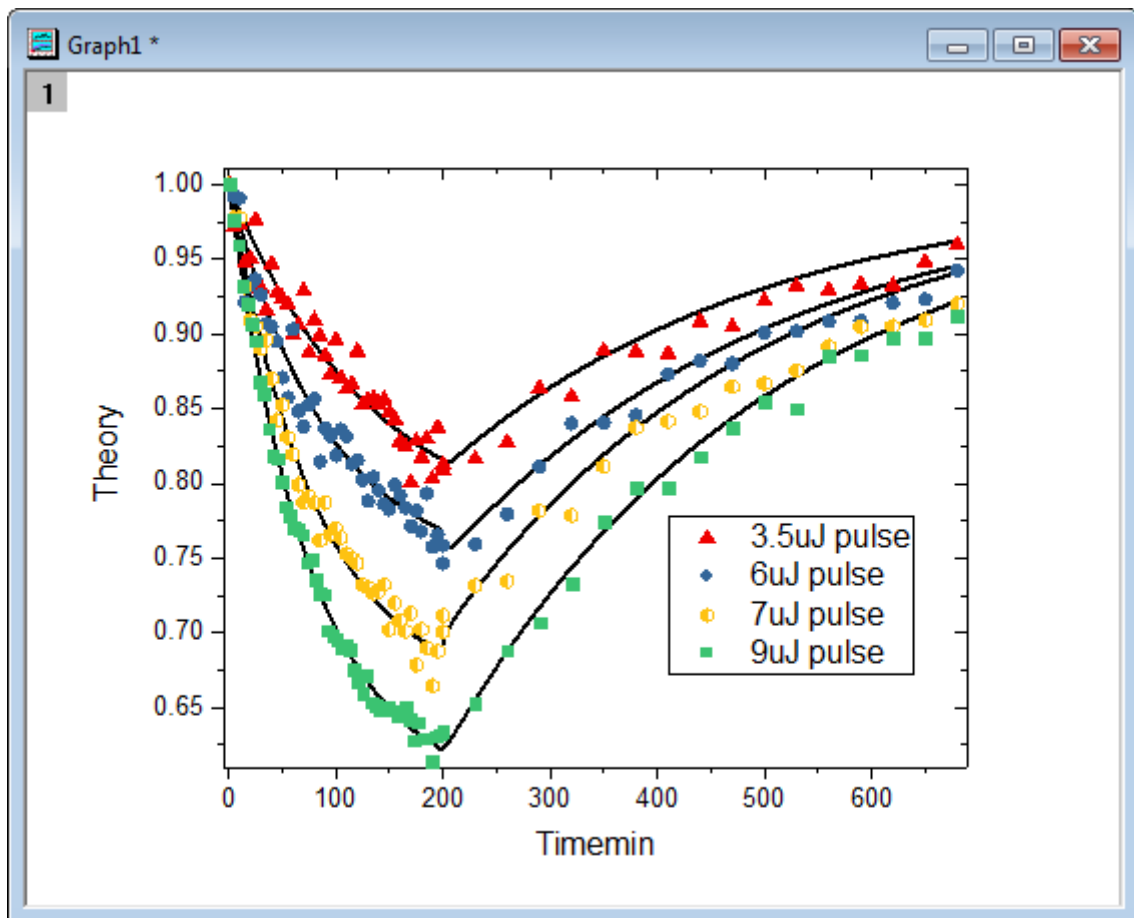

## 6.7.6 Micro-Raman spectroscopy of complex nanostructured mineral systems

### 6.7.6.1 Summary

This tutorial will show you how to create a multiple line plot and how to customize it.

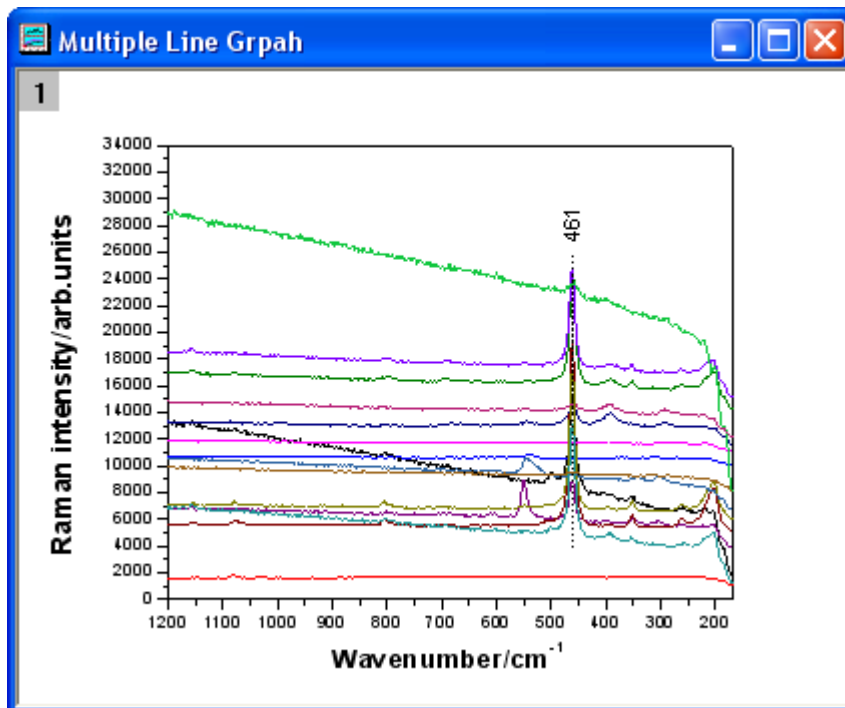

Minimum Origin Version Required: Origin 2015 SR0

### 6.7.6.2 Steps

1. Create a new worksheet. Click the **Import Single ASCII button**  and import the **Micro\_Raman\_Spectroscopy.txt** file under <Origin EXE Folder>\Samples\Graphing\ path.



	A(X)	B(Y)	C1(Y)	C2(Y)	C3(Y)	C4(Y)	C5(Y)	C6
Long Name								
Units								
1	100.263	762.24	100.263	947.9676	100.263	9966.063	100.263	10919
2	101.997	765.94	101.997	951.6754	101.997	9940.0309	101.997	10928
3	103.728	771.5	103.728	944.2353	103.728	9954.8876	103.728	10917
4	105.461	765.92	105.461	957.2229	105.461	9936.3143	105.461	10929
5	107.194	769.61	107.194	936.8001	107.194	9951.1572	107.194	10919
6	108.927	767.74	108.927	944.2147	108.927	9956.7125	108.927	10929
7	110.657	767.73	110.657	959.035	110.657	9943.7279	110.657	10932
8	112.389	784.39	112.389	955.3154	112.389	9969.6578	112.389	10927
9	114.121	760.3	114.121	955.3027	114.121	9945.5715	114.121	10929
10	115.85	762.14	115.85	951.589	115.85	9952.9684	115.85	10932
11	117.581	765.83	117.581	940.4814	117.581	9945.5616	117.581	10928
12	119.312	773.21	119.312	947.8704	119.312	9928.9203	119.312	10938
13	121.041	763.95	121.041	962.6417	121.041	9952.9419	121.041	1097
14	122.771	767.63	122.771	934.9271	122.771	9945.5469	122.771	10927
15	124.501	771.31	124.501	942.3073	124.501	9951.0786	124.501	10927
16	126.228	784.21	126.228	938.6123	126.228	9947.3817	126.228	10927
17	127.957	765.75	127.957	945.9827	127.957	9938.1579	127.957	10927
18	129.686	774.95	129.686	955.1878	129.686	9963.9533	129.686	10928
19	131.413	762.04	131.413	947.8086	131.413	9945.5224	131.413	10930

- Highlight all the columns in the worksheet. Right-click and select **Set As: XY XY** from the context menu. Then click the **Line** button on the **2D Graphs** toolbar.

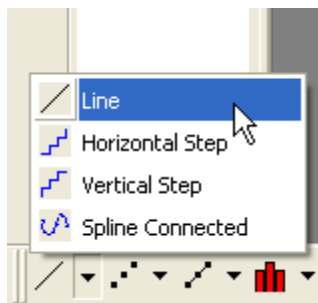

Delete the legend. The graph should look like this:

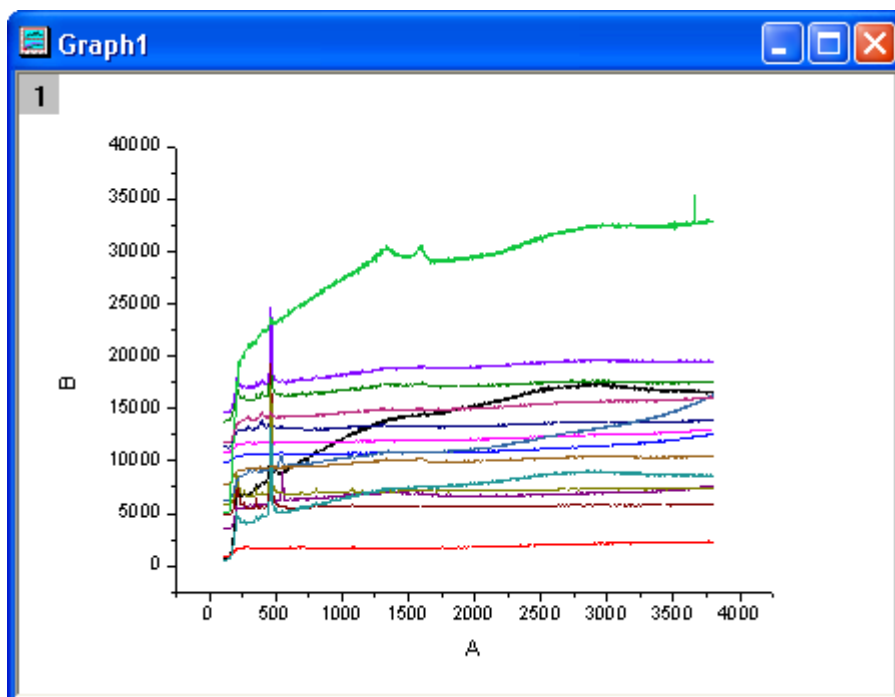

3. Double-click on the **X** axis to bring up the **Axis** dialog box. In the **Scale** tab, set the options as the screenshots below.

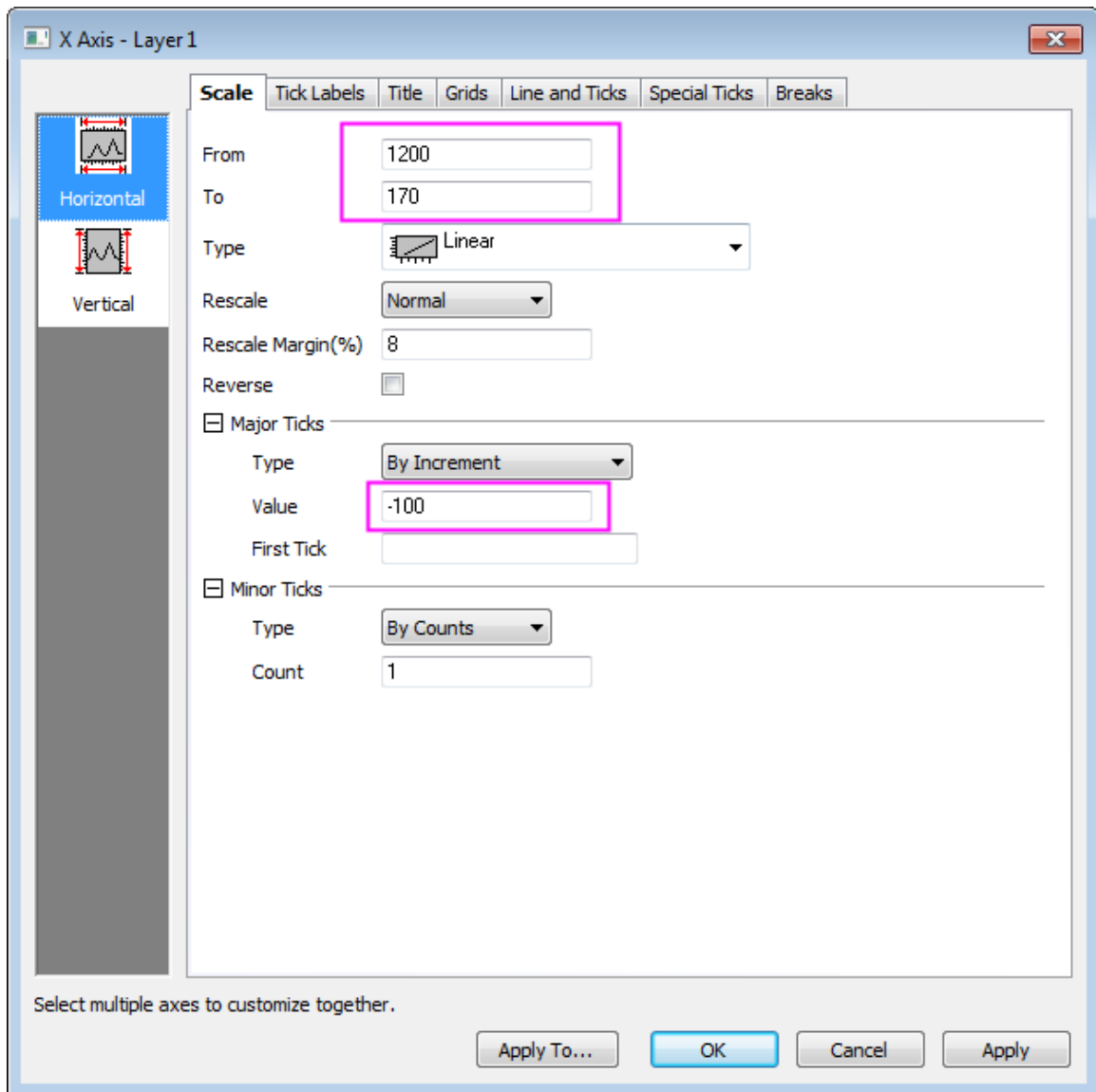

4. Click the **Vertical** icon on the left panel to go to the **Scale** tab of **Y Axis** and then set the options as in the screenshots below and Click **OK**.

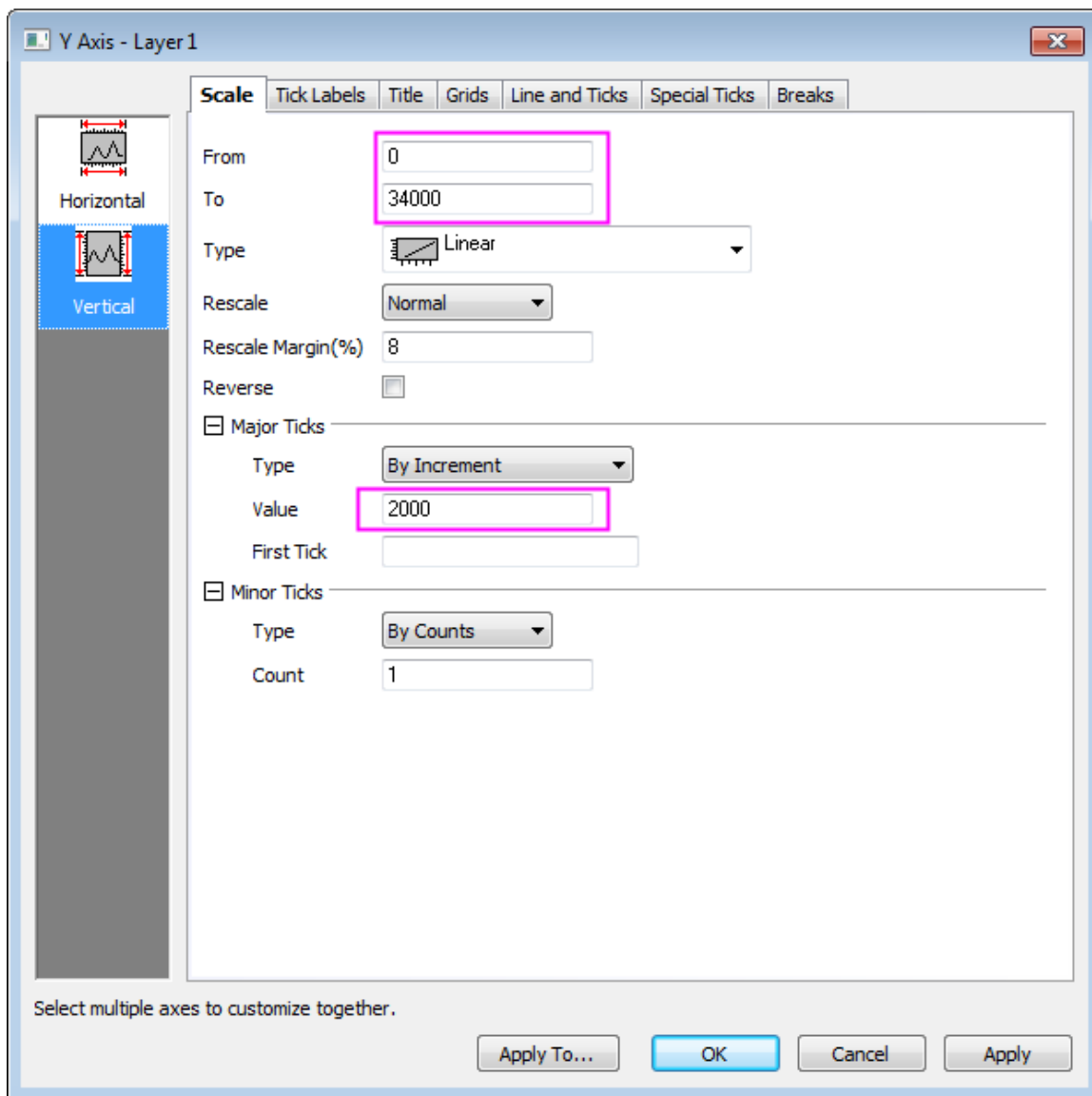

- Now, we will apply a Graph Theme to add a top **X** axis and a right **Y** axis. Select **Preferences: Theme Organizer** to open the **Theme Organizer** dialog. Activate the **Graph** tab and select **Opposite Lines** from the table. Then click **Apply Now**. Click **Close** to close the dialog.

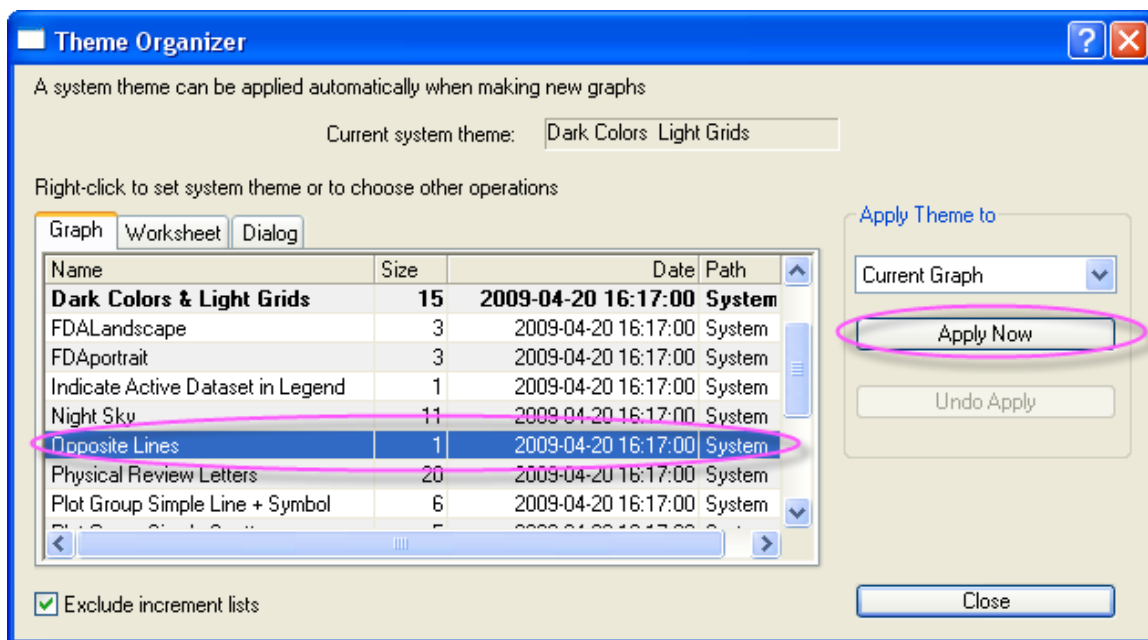

- Click the **Line** button on the **Tools** toolbar and draw a line across the peaks' centers as the sample image shows. Hold down the **SHIFT** key while drawing the line to force it to snap to the vertical. Double-click on the line. In the **Line** tab, select **Dash** with the **Type** drop-down list. Click **OK**.



- Click the **Text** button in the **Tools** toolbar. Add a text object near the line object and enter **461** into the text object.



Right-click on the text object and select **Properties** from the shortcut menu. In the **Text** of the dialog, set the options as in the screenshot below. Click **OK**.

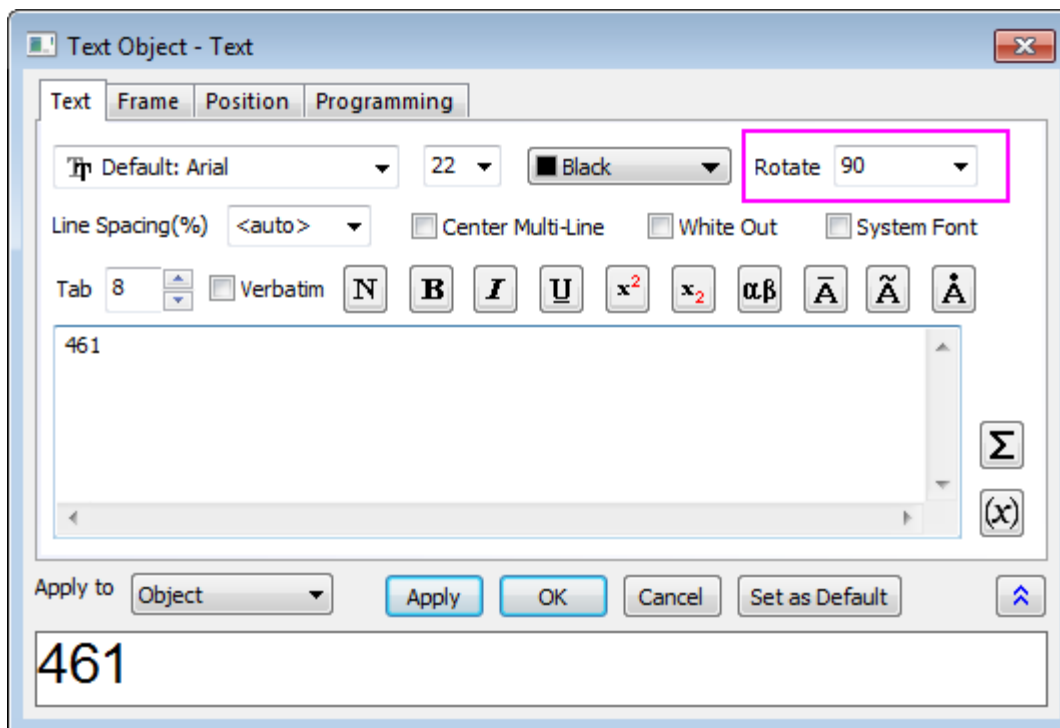

8. Right-click on the title of the Y axis and select **Properties** from the short-cut menu. In the **Text** of the dialog, enter **Raman intensity/arb.units** in the edit box, highlight it, click the **Bold** button, and change size to **28**. Click **OK**.

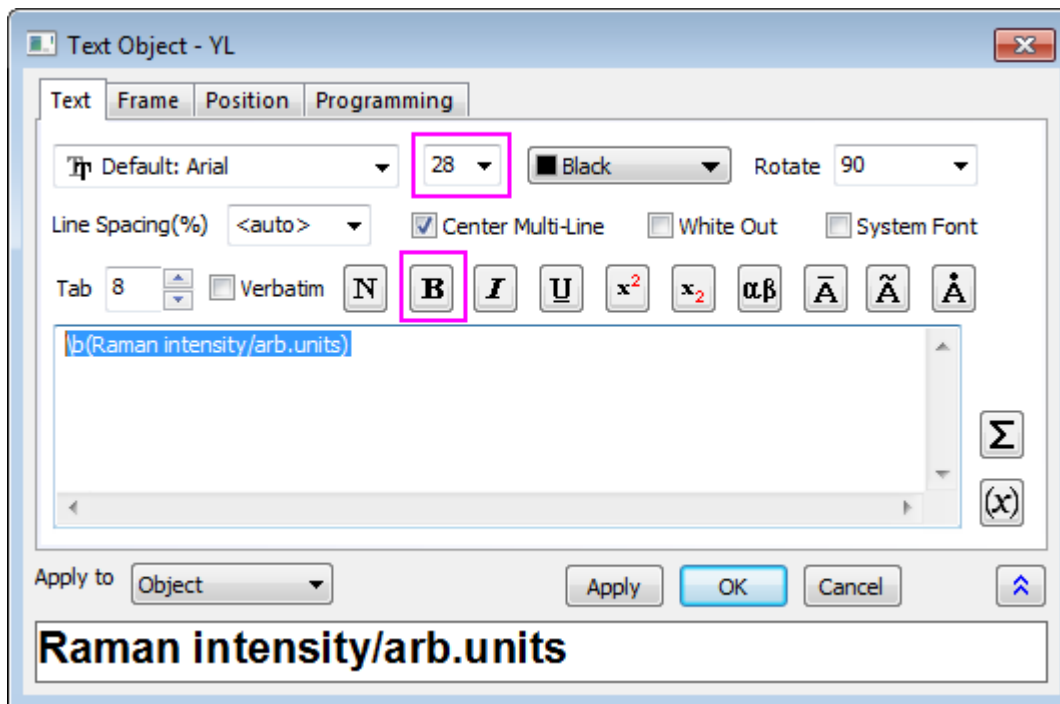

9. Right-click on X axis title and select **Properties** from the shortcut menu. In the **Text** of the dialog, enter **Wavenumber/cm-1** in the edit box, highlight it, click the **Bold** button, and change size to **28**. Highlight **-1** click **SuprtScript** button. Click **OK**.

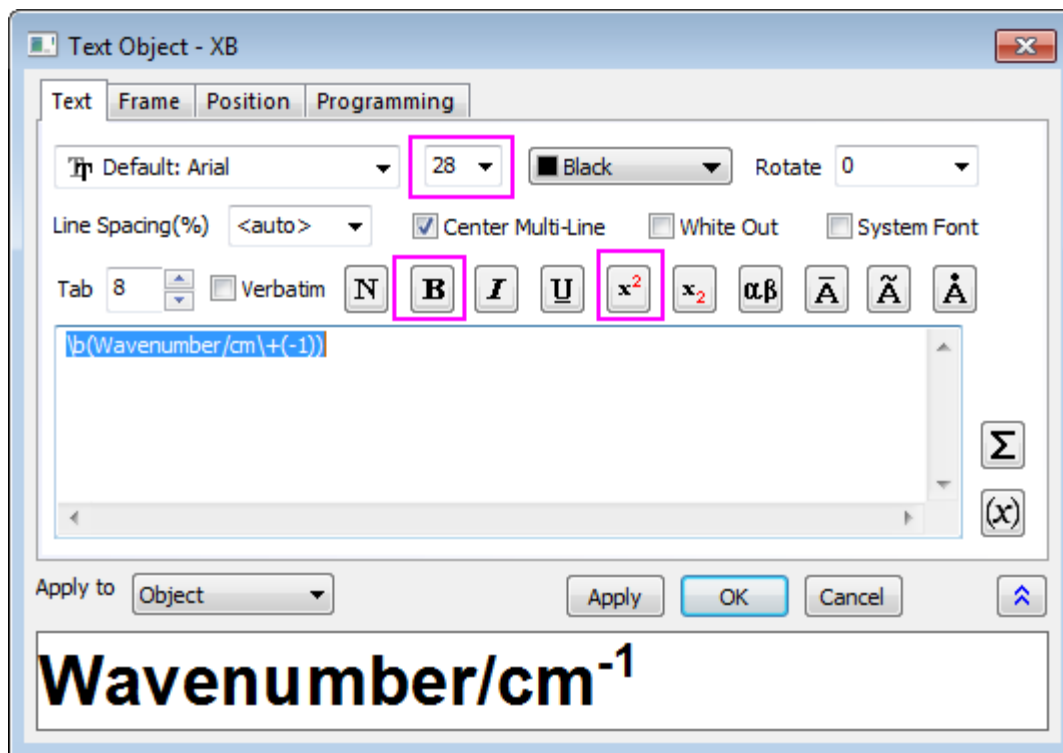

The graph should look like this:

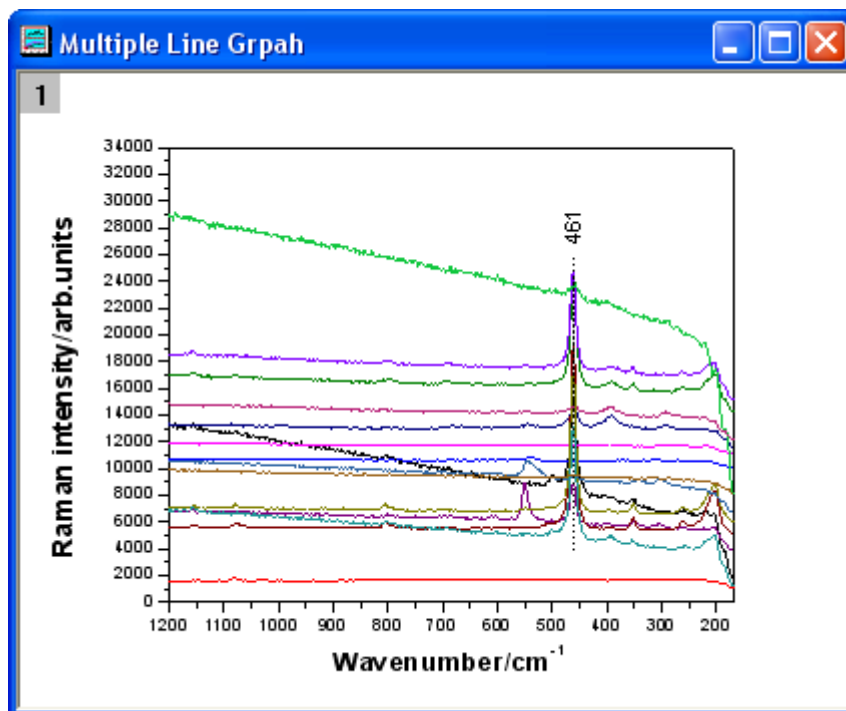

## 6.7.7 Multi-line-plot with Special Position Annotation Line

### 6.7.7.1 Summary

This tutorial will show you how to create a multi-line-plot with special position annotation line.

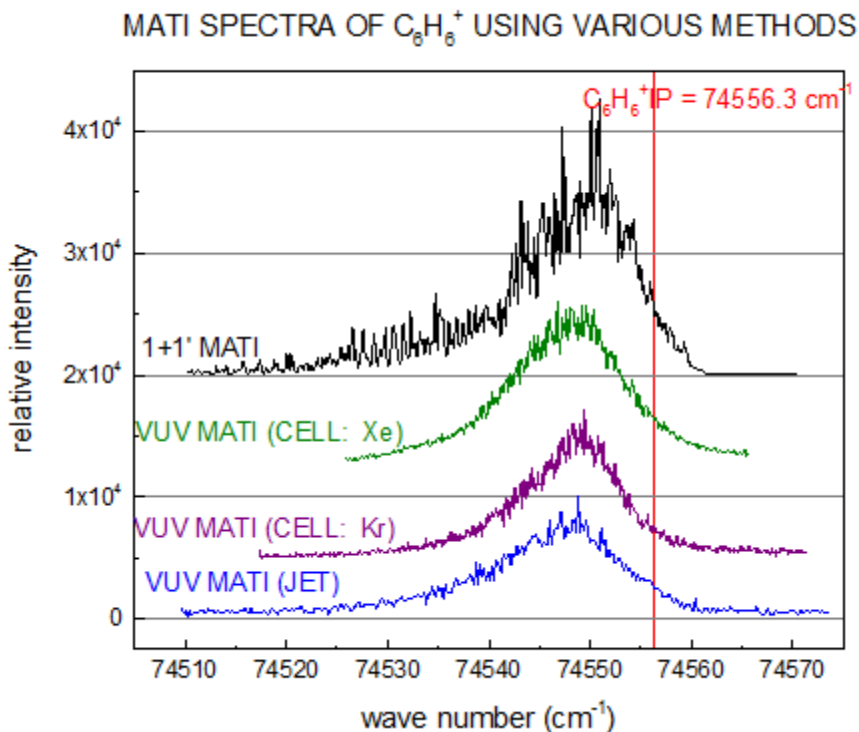

Minimum Origin Version Required: Origin 2015 SR0

### 6.7.7.2 Steps

This tutorial is associated with <Origin EXE Folder>\Samples\Tutorial Data.opj.

Also, you can refer to this graph in Learning Center. (Select **Help: Learning Center** menu or press **F11** key , and then open **Graph Sample: Line and Symbol**)

1. Open **Tutorial Data.opj** and browse to the **Multi-line-plot with Special Position Annotation Line** folder in **Project Explorer** (PE).
2. Active to the worksheet in workbook **Multi-line-plot with Special Position Annotation Line**. To plot a multiple line plot, highlight all the columns in the worksheet, and click the **Line**  button on the **2D**



**Graphs** toolbar. Delete the legend object from graph.

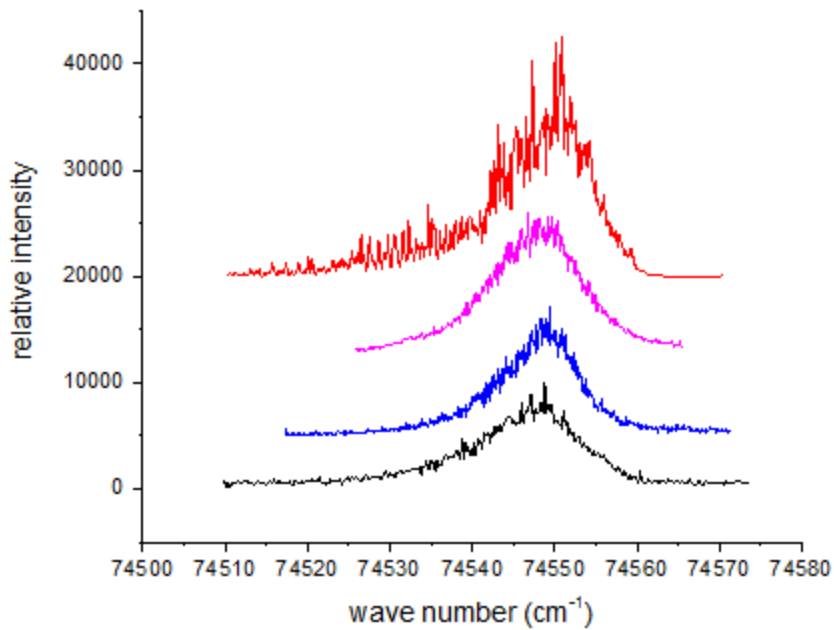

3. Double click the axis to open the axis dialog, set the axis scale and ticks via dialog:
  - Go to the **Line and Ticks** tab and set the ticks:

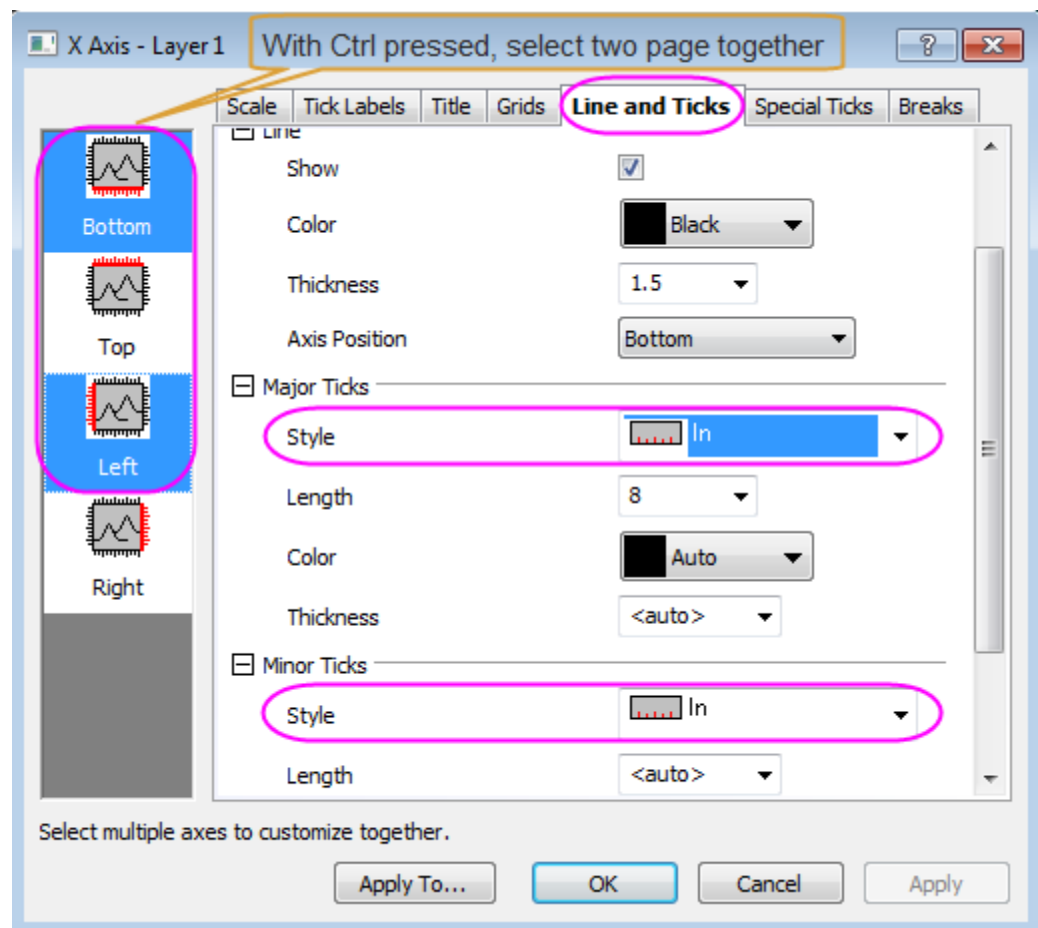

- o Go to the **Scale** tab in same dialog, set the scale for X and Y axis:  
 For X (**Horizontal**): From 74505 to 74575;  
 For Y (**Vertical**): From -2500 to 45000;
- 4. Go to the **Ticks Labels** tab and change the display format for **Left** into **Scientific: 10<sup>3</sup>**, then, go to the **Grids** tab with **Horizontal** icon selected, check **Show** for **Major Grid Lines**, click **OK** to close the dialog.

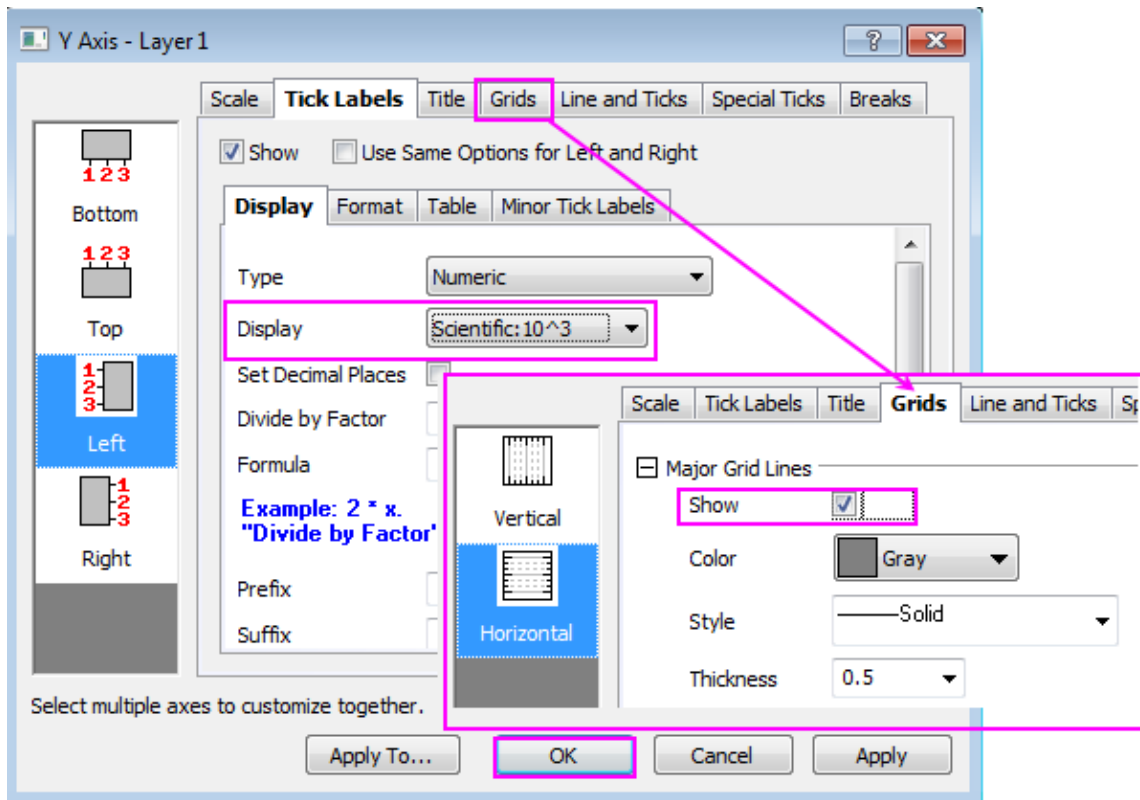

- 5. Select the **View: Show: Frame** in main menu to added a line frame on the graph. The graph is similar to this now:

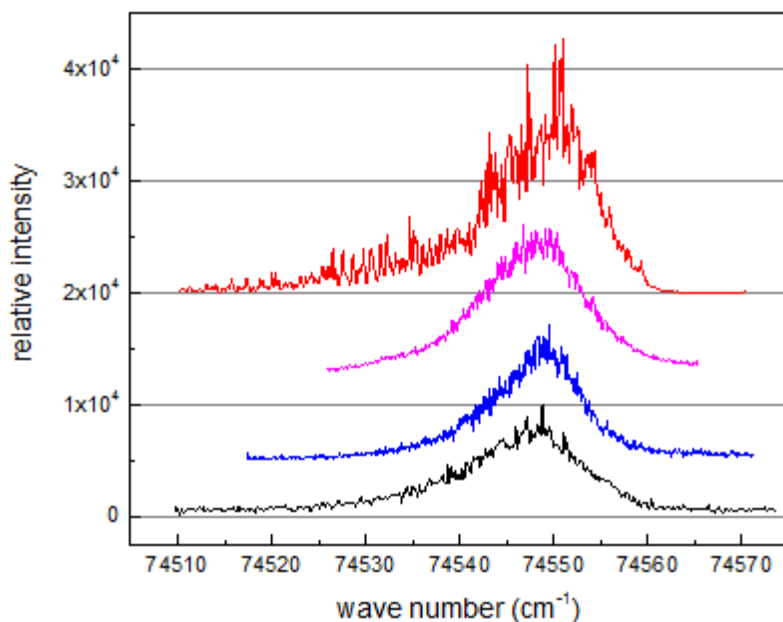

6. Double click the plot line to open the **Plot Details** dialog, in **Group** tab, open the **Increment Editor** as shown in graph, designate color for each line, then click **OK** to close two dialog.

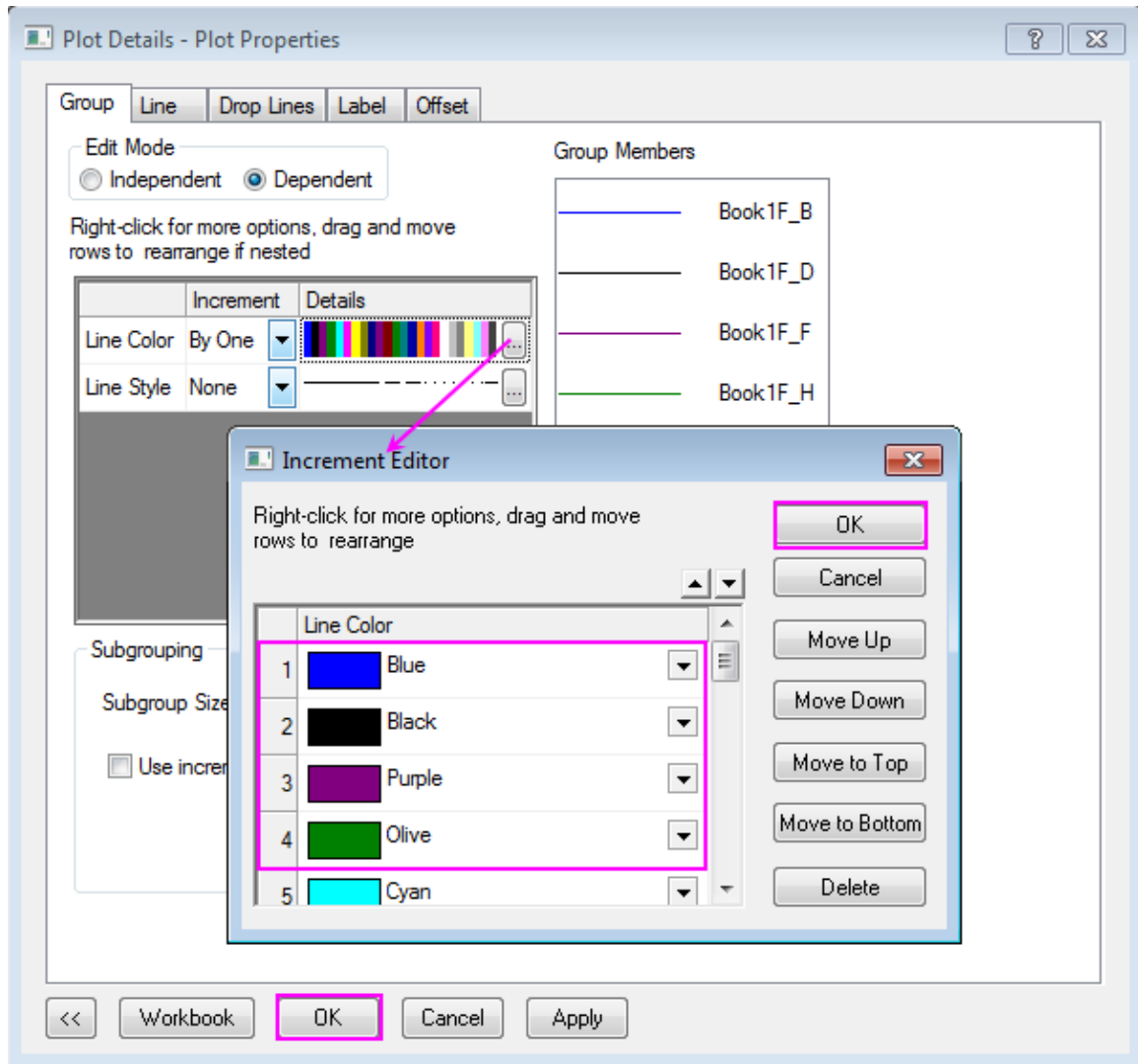

- Then, you will add vertical line on Graph, select **Insert: Straight Line** in main menu to open the dialog, set the X coordinates in the dialog, and set color: **red**, click **OK** to apply the settings.

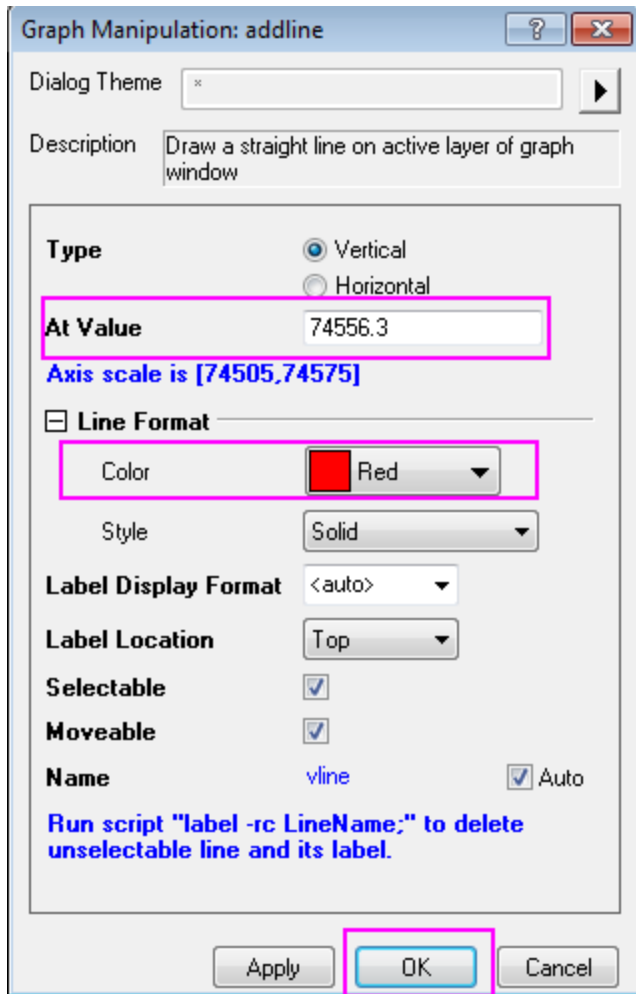

- A straight line with text was added on the graph. Edit the Text object above the line object by double click it, the  $x^2$  and  $x_2$  in **Format** toolbar is helpful when creating superscripts and subscripts. Entering the content as shown in graph below:

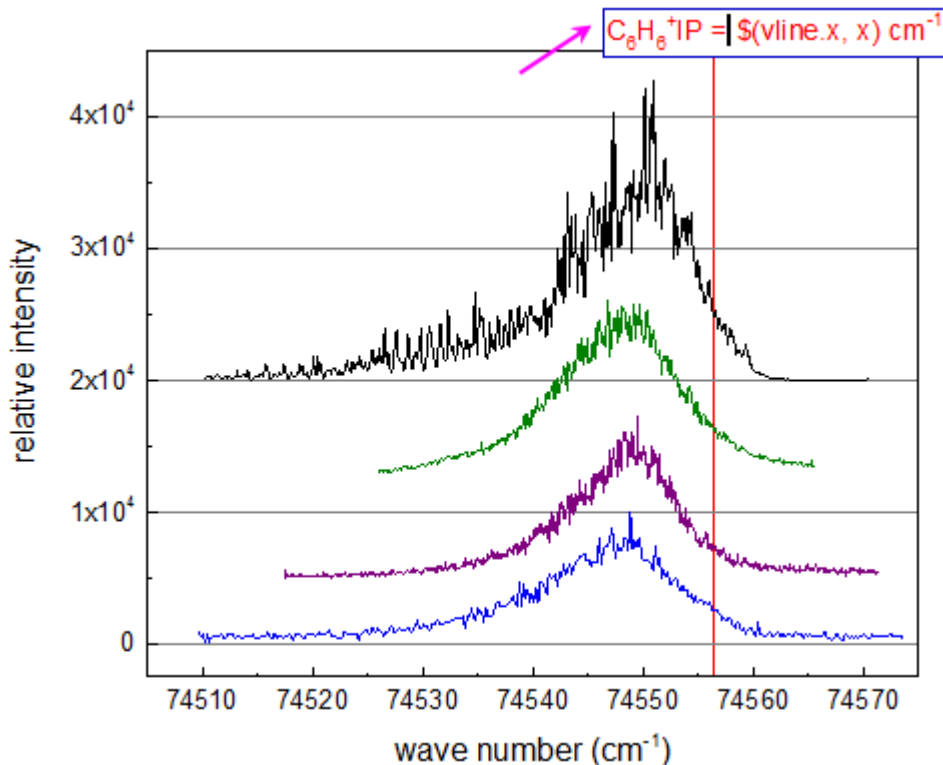

Then, click somewhere outside the text box to quit the text editing, drag to move the text to a proper position.

Now, the text object get the X coordinates of the line, when you drag to move the line object horizontal, the text also updates simultaneously.

9. Add explanatory strings for line plot, add a title on the graph by using Text Tool as well.



There are 2 ways to edit text labels:

- In-place Text Editing: Double-clicking puts you in WYSIWYG edit mode. Using the **Style** and **Format** toolbars makes it easy to add formatting to any text. For special characters, the **Symbol Map** can be used.

The **Symbol Map** can only be opened while in In-place edit mode. To enter In-place edit mode, double-click on the text label. Then, open the Symbol Map by pressing CTRL+M. Or right-click inside the text label and select Symbol Map.

- Text Control dialog box (from previous versions of Origin): Hold down the CTRL key when double-clicking text. Highlight any portion of the text and apply the desired style, Greek font, etc.

You can also right-click on a text label and select Properties to open

this dialog.

10. The finished graph is similar to the graph in [Summary Section](#) in this tutorial.

## 6.7.8 Scatter Central Plot

### 6.7.8.1 Summary

A scatter central plot is a graph with the X and Y axes located in the middle of the layer. In this tutorial, a scatter central plot will be created, then the symbol and the axes will be customized.

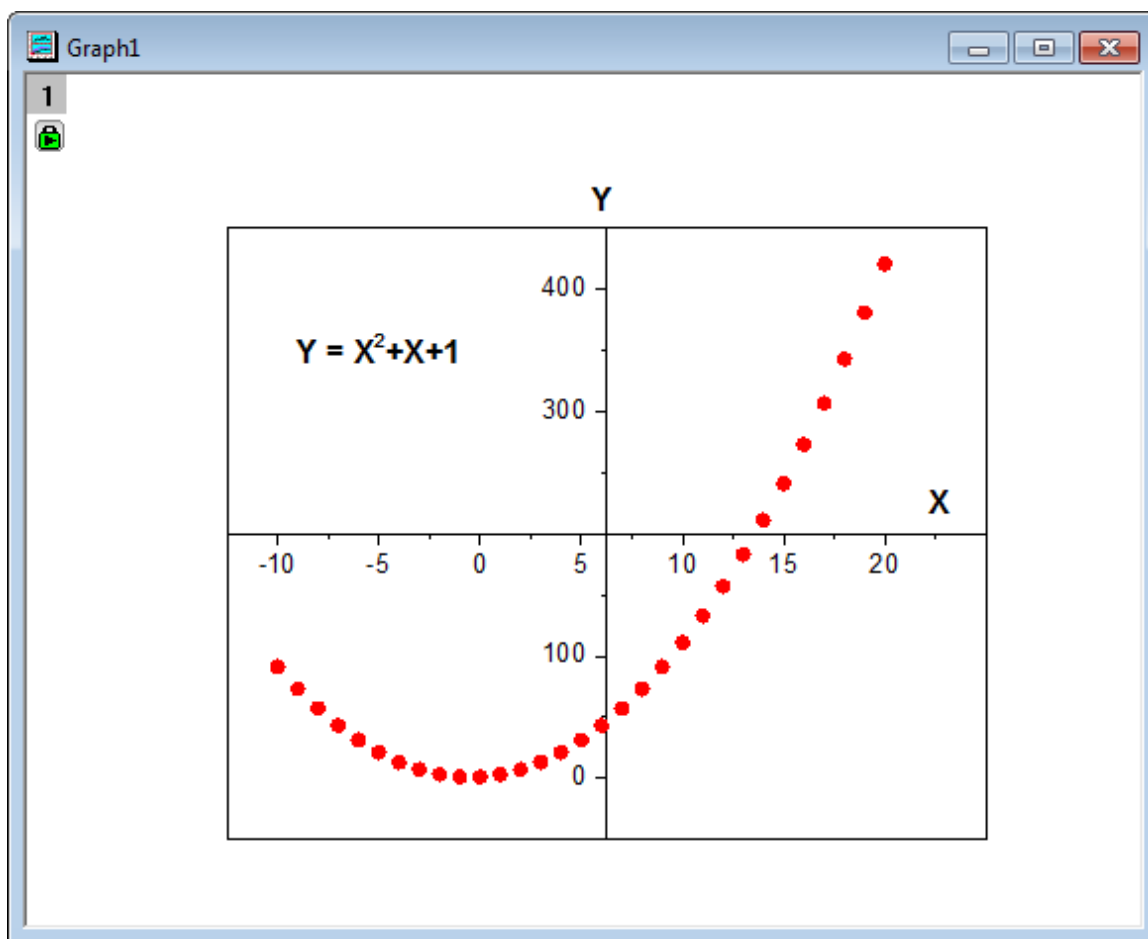

Minimum Origin Version Required: Origin 2015 SR0

### 6.7.8.2 What you will learn

- Set column values using **Set Values** dialog box
- Create a scatter central plot
- Change the color and shape of the scatter points

- Customize axis tick labels

### 6.7.8.3 Steps

1. Start with an empty worksheet with two columns. We are going to fill a worksheet column with values using the **Set Values** dialog box.
2. Highlight column A, right-click and select **Fill Column with: Row Numbers** from the shortcut menu. Right-click column A again and select **Set Column Values** to open the **Set Values** dialog box. Type **This - 11** in the text box, then click **Apply** to finish setting values for column A.

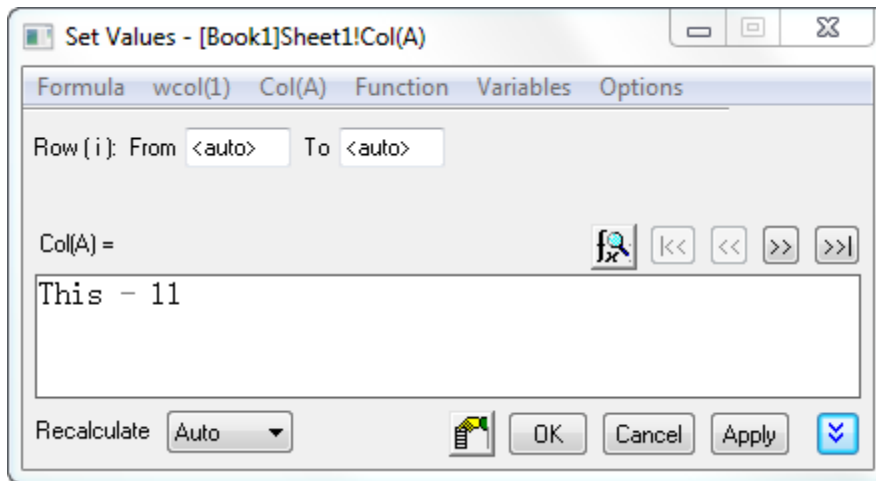

3. Click the **>>>** button to select column B in the **Set Values** dialog box. Type **A<sup>2</sup> + A + 1** in the text box this time. Then click **OK** to set values for column B.

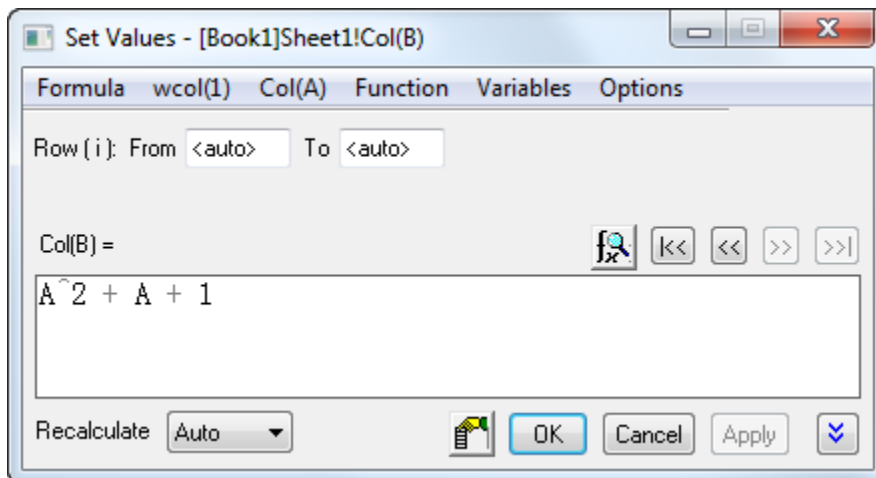

4. Highlight column B and select **Plot > Basic 2D : Scatter Central** from the Origin main menu. This creates a scatter central plot.

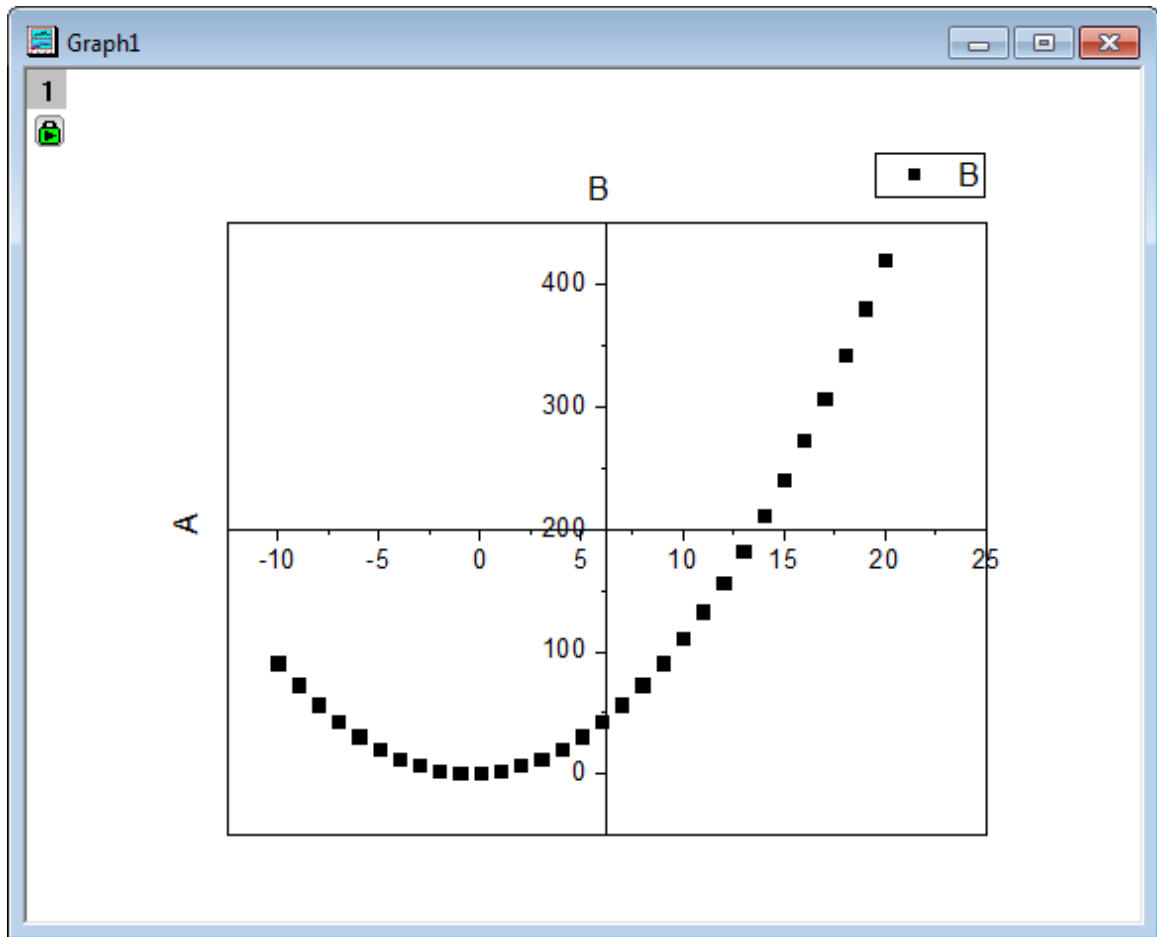

5. We will change the color and shape of the scatter points. Double-click on the scatter plot to open the **Plot Details** dialog, expand **Layer1** node on the left panel and highlight its sub-node. In the **Symbol** tab of right panel, click the down-sided triangle button beside **Preview** and choose the solid circle symbol. Click the button beside **Symbol Color** and choose **Individual Color: Red**. Click **OK** to close **Plot Details**.



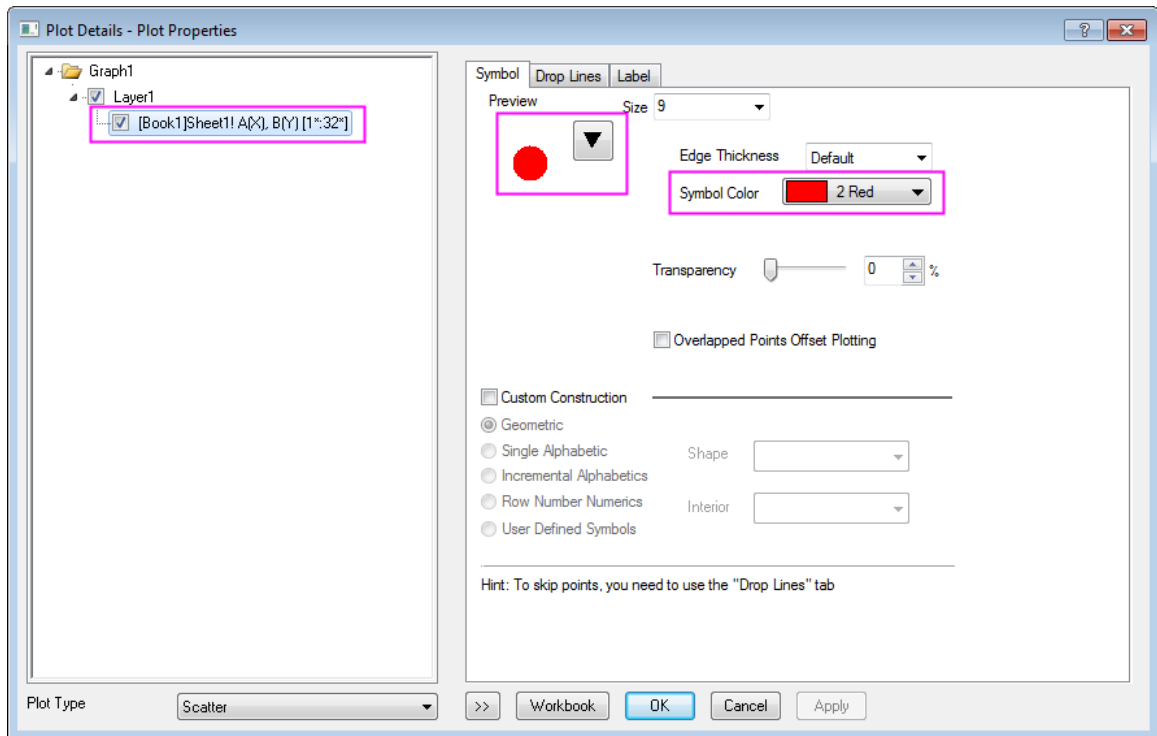

6. Now we will customize the axes. Double click on the Y axis to open the **Axis** dialog box. On the **Scale** tab for **Y Axis**, change the **To** value to **450**.
7. Click **Special Ticks** tab, enter **200** in **At Axis Value** column right below **Axis End** and uncheck its correspond box in **Show** column to hide the special tick as displayed in following:

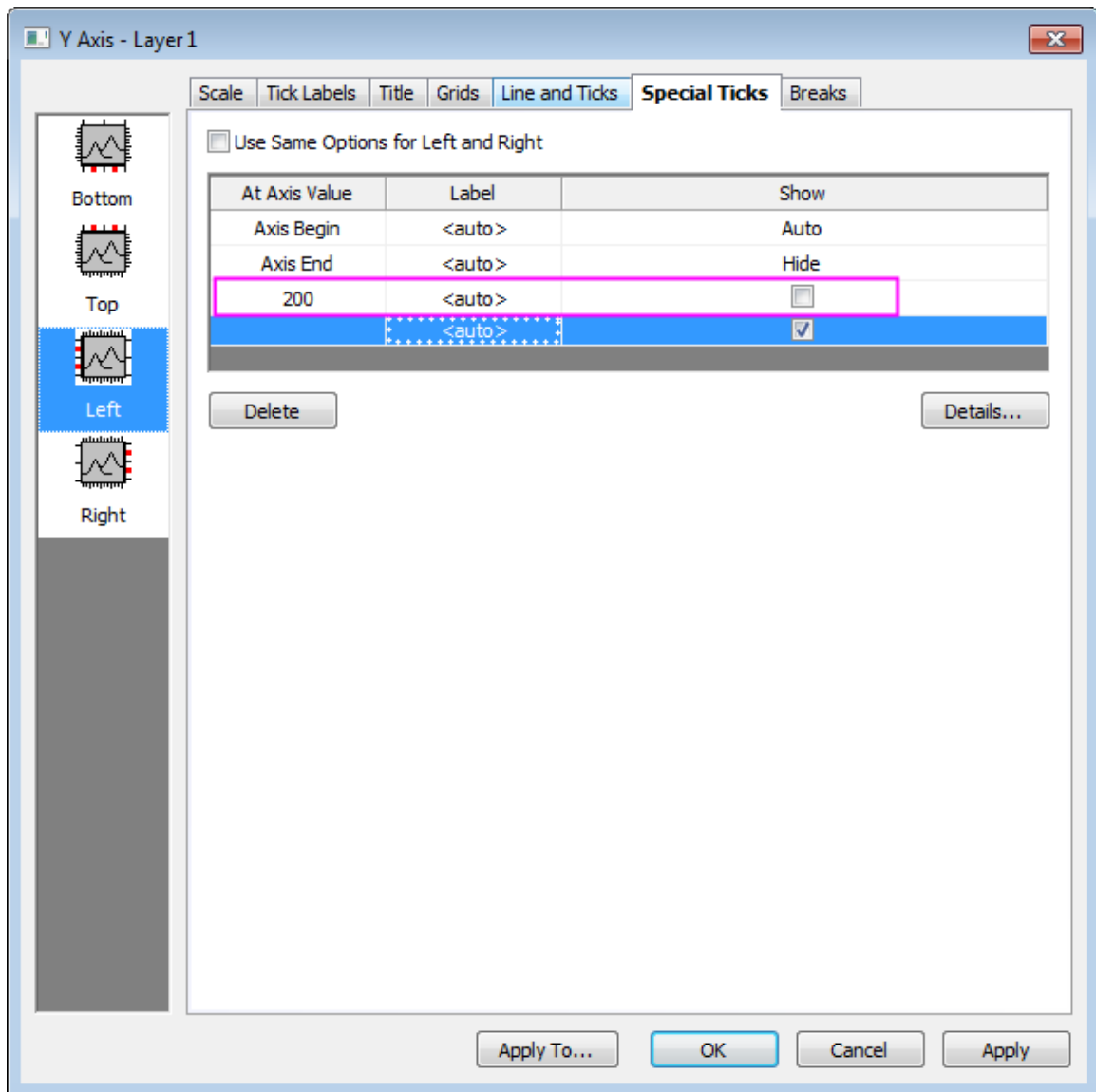

8. Click the **Bottom** icon on the left panel and click to highlight the **Axis End** row, then choose **Hide** from the drop-down list in **Show** column.
9. Click **OK** to finish axes settings. The scatter central plot looks like the following.

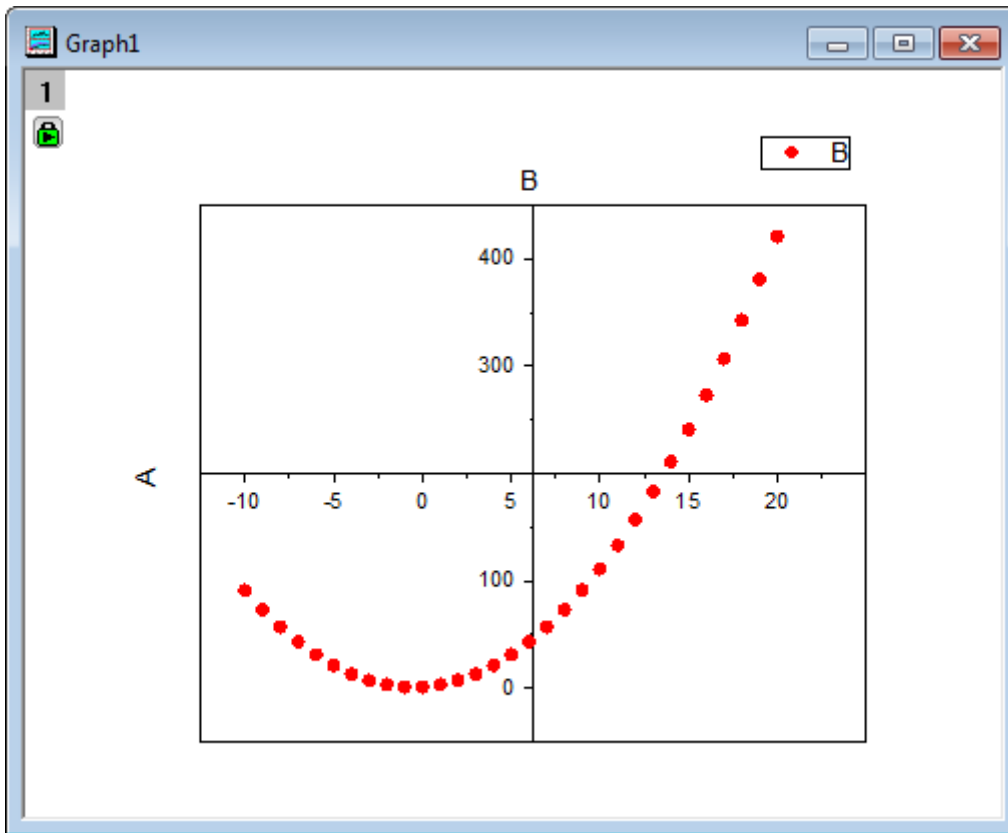

10. Now, delete the legend and change the labels of axes **A** to **X** and **B** to **Y** and make the text bold.
11. Right click on the X axis label and select **Properties** shortcut menu and choose **0** from **Rotate(deg.)** drop-down list, and click **OK**. Move the **X** to the end of X axis. Add a text object  $Y = X^2 + X + 1$  and customize it as  $Y = X^2 + X + 1$  through the following steps:

Object Properties

Background (None) Verbatim OK

Rotate (deg.) 0 Cancel

Tab 8 Size 22 Apply formatting All labels in layer Set Default

Default: Arial Black N **B** *I* U <sup>x<sup>2</sup></sup> <sub>x<sub>2</sub></sub> Γ

\b(Y = X^(2)+X+1)

step1: enter Y = X2+X+1 highlight the text.

step2: select to bold the text.

step3: highlight 2 in text and select the icon to make it superscript.

**Y = X<sup>2</sup> + X + 1**

12. The final graph looks like the following:

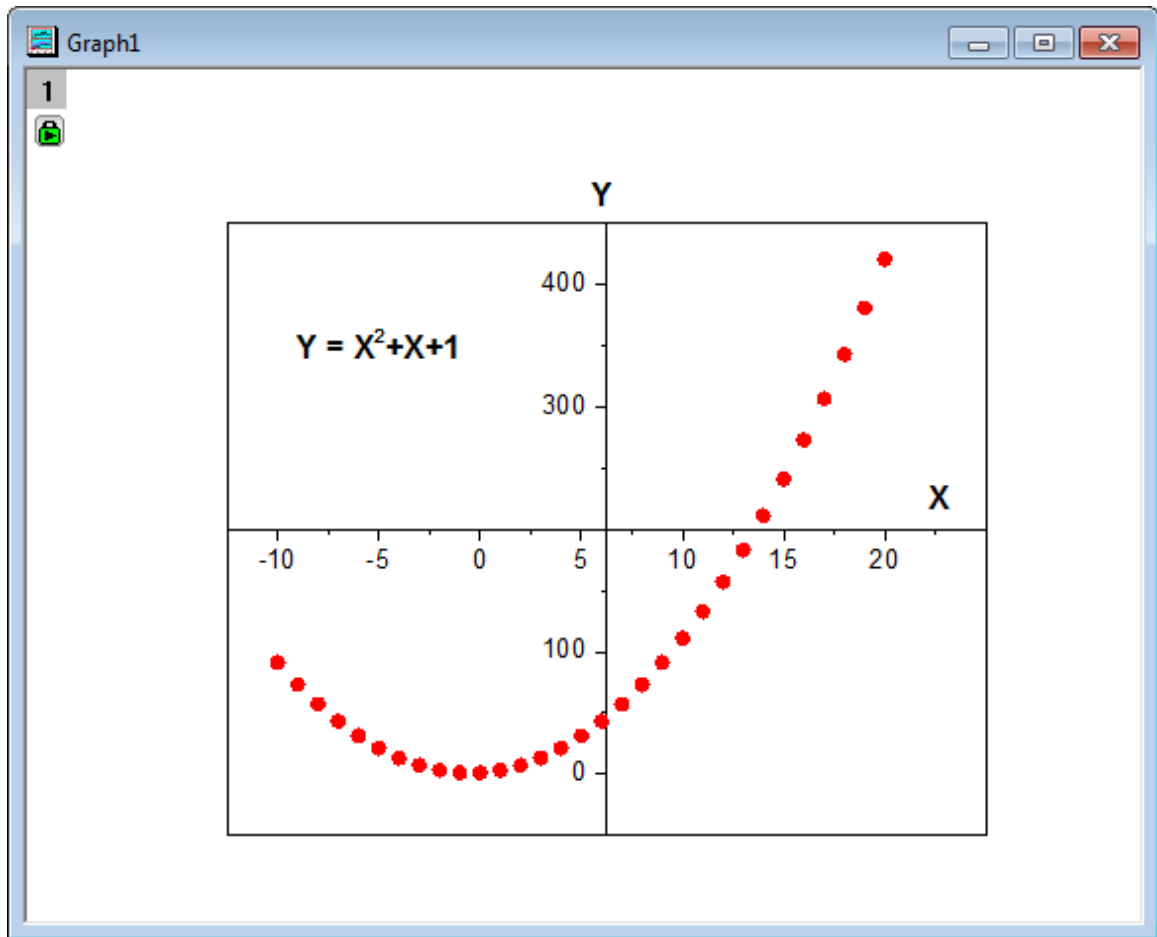

## 6.7.9 Line Graph with Masked Data

### 6.7.9.1 Summary

You can masking subranges of data graphically. In this tutorial, a line graph is created first, then the masking tool is used to mask the low peaks on the graph.

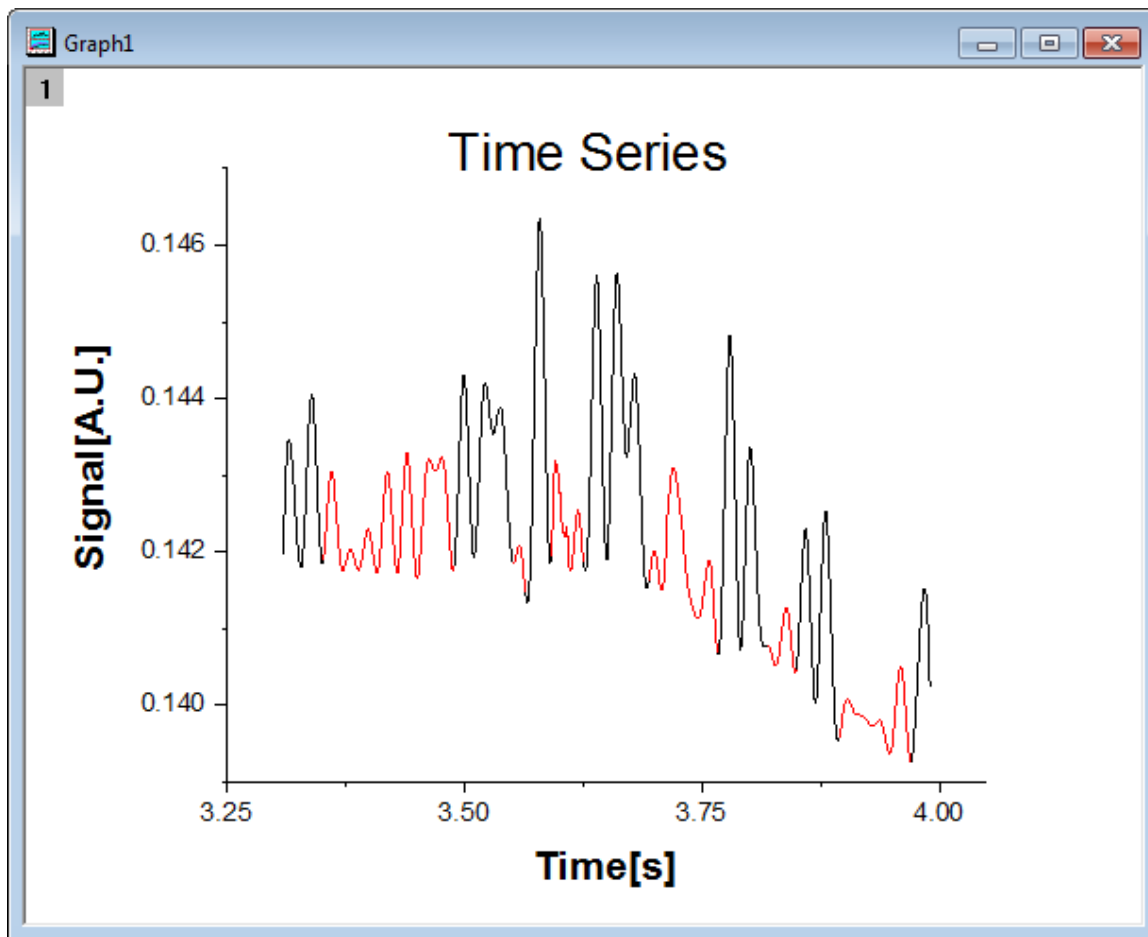

Minimum Origin Version Required: Origin 2015 SR0

#### 6.7.9.2 What you will learn

- Plot a line graph
- Set the scales of axes
- Mask data on the line graph

#### 6.7.9.3 Steps

1. Create a new workbook, click the **Import Single ASCII**  button to import the file **Line\_Graph\_with\_Masked\_Data.txt** under *<Origin EXE Folder>\Samples\Graphing* path.
2. Highlight both columns in the worksheet and select **Plot > Basic 2D : Line** from the Origin main menu to plot a line graph.

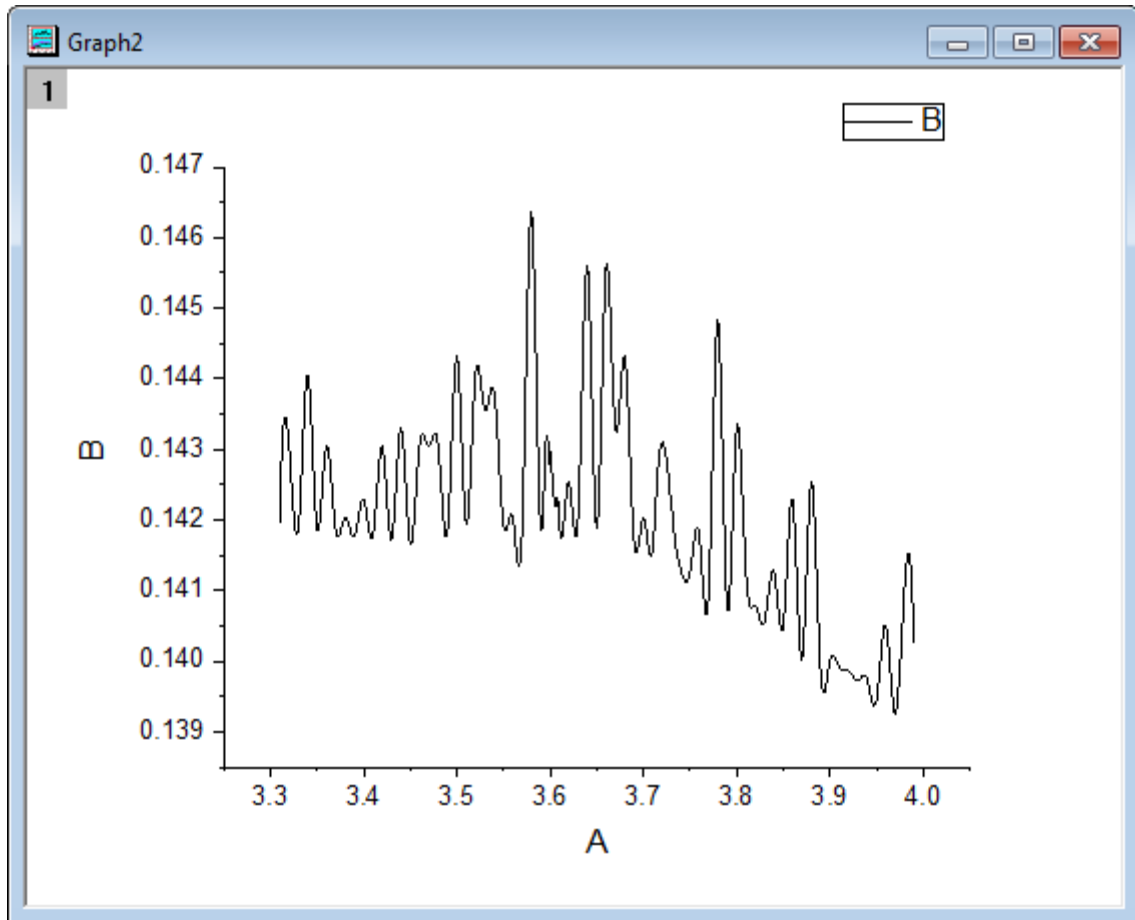

3. Double click on the X axis to open the **Axis** dialog box. Set the increment value to 0.25 as in the image below:

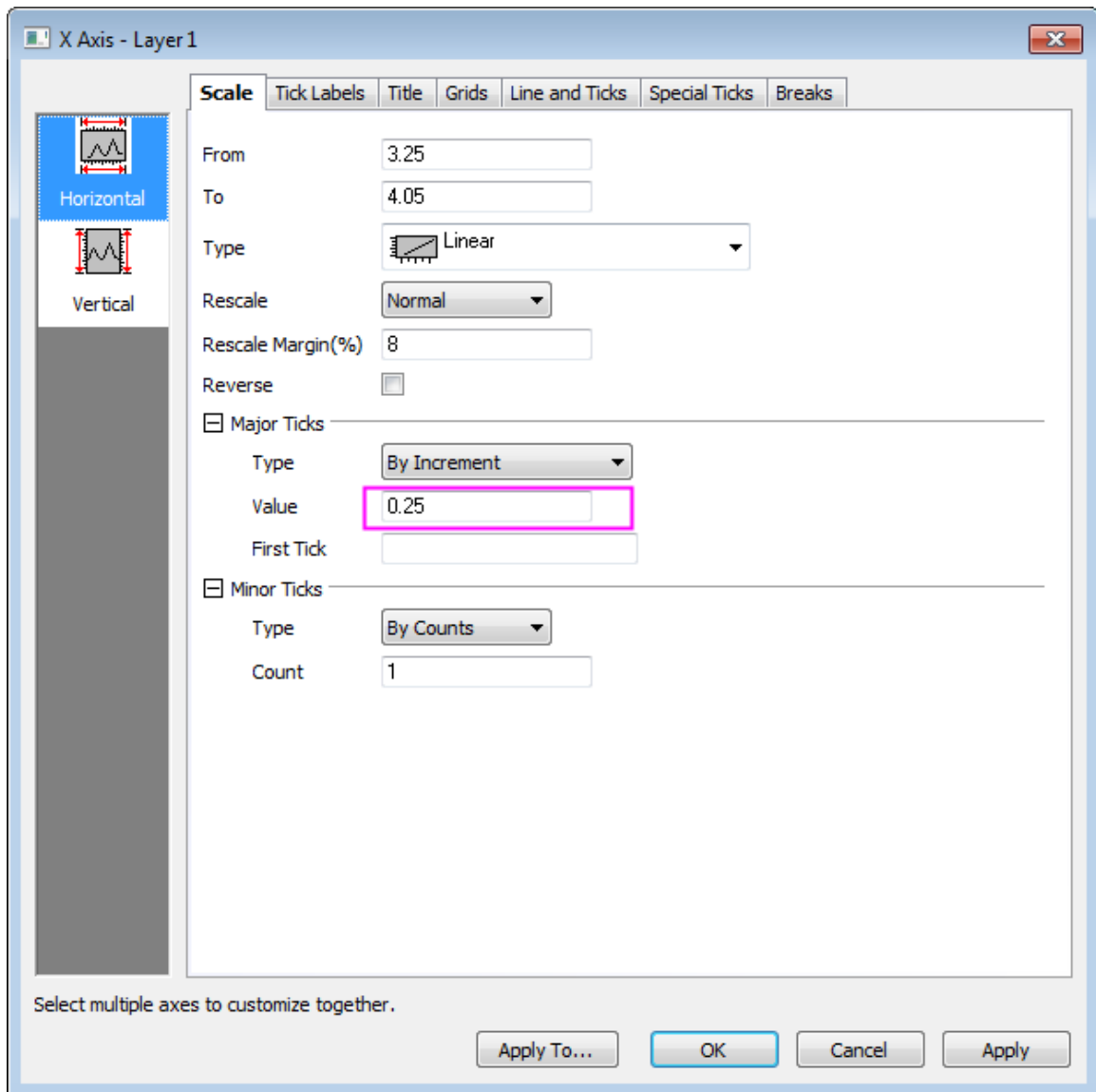

4. Click the **Vertical** icon on the left panel to set the Y axis scale as in the following image:



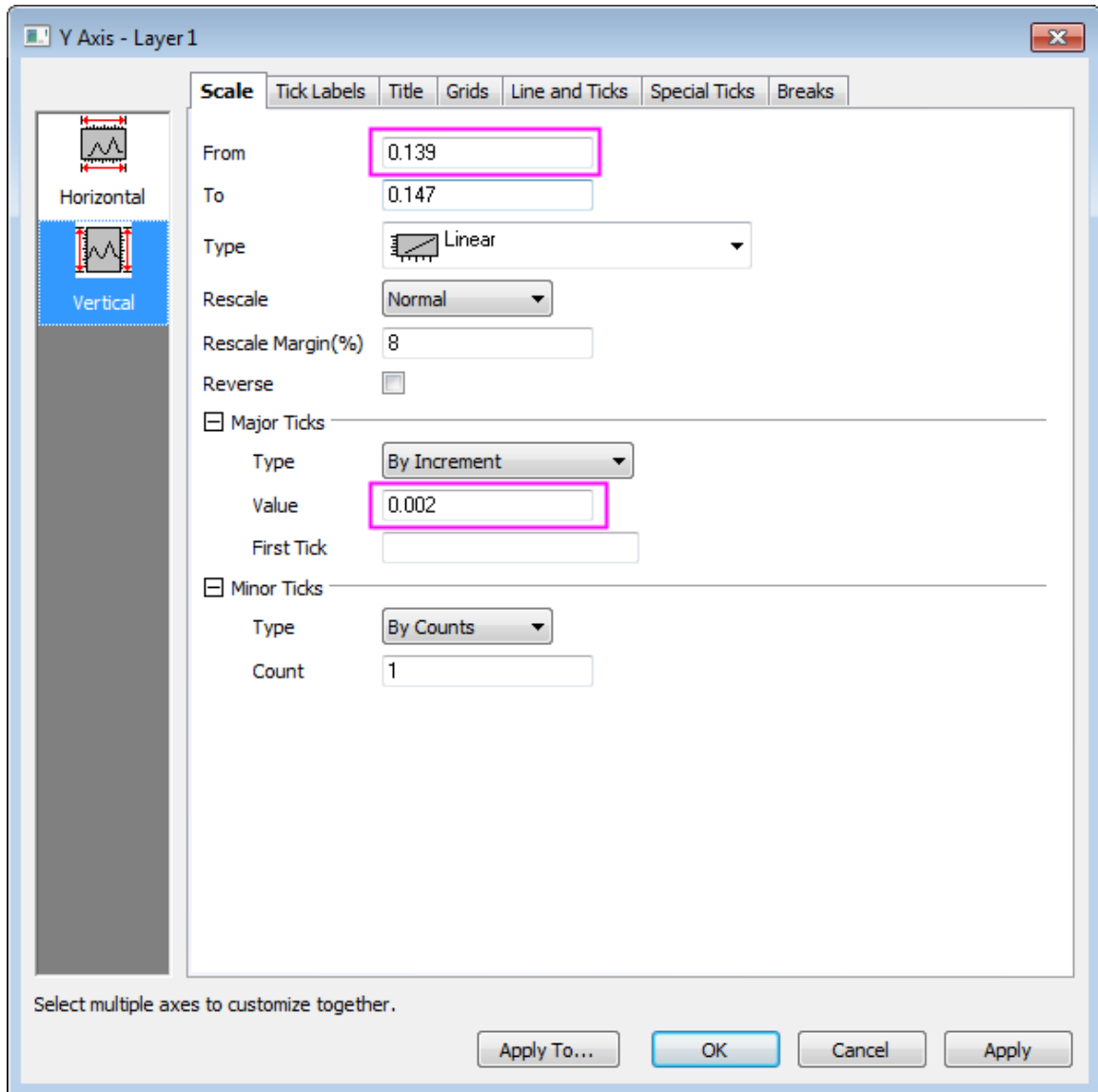

- Click **OK** to close the Axis dialog and delete the graph legend. Change the X label to **Time[s]** and the Y label to **Signal[A.U.]**, and bold both text labels and set the font size as **28**. Create a title by adding a text object that says **Time Series**. Bold the title and set the font size of the title to **36**.

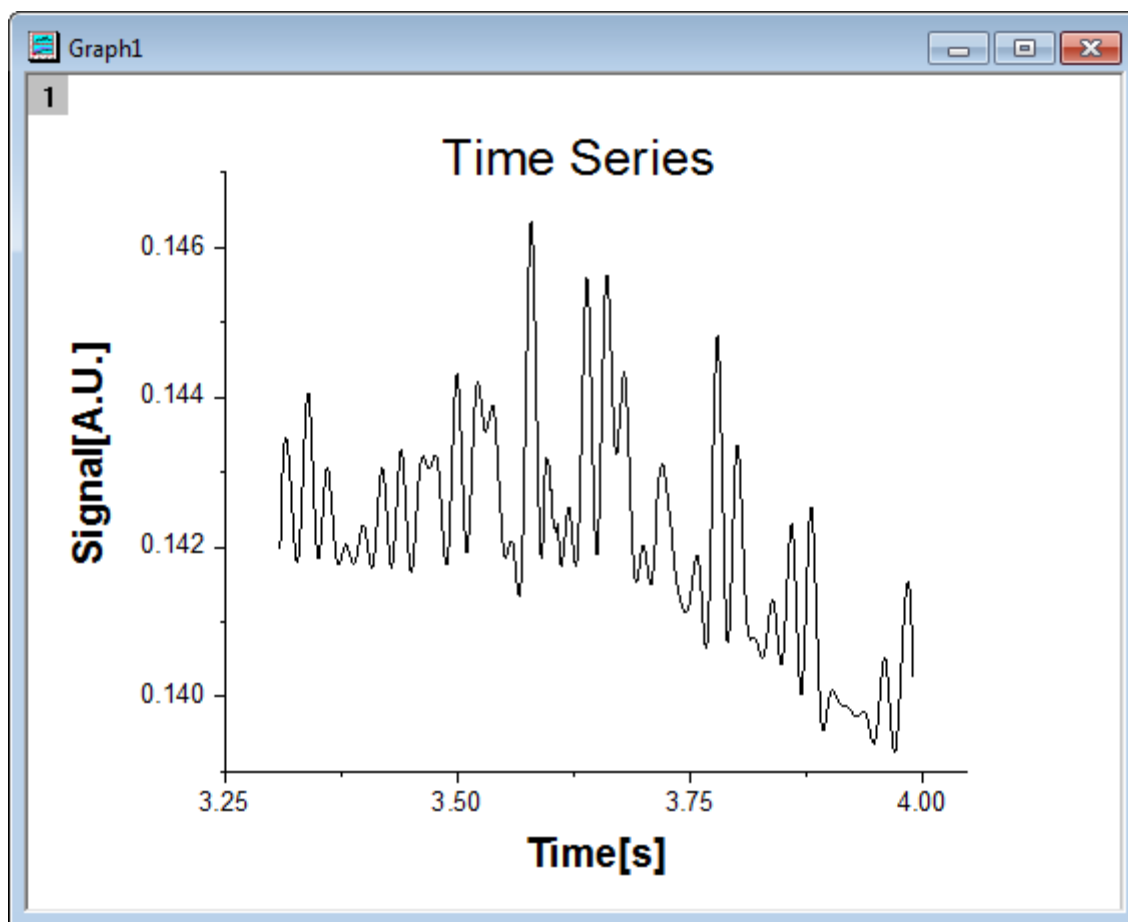

6. Activate this graph, then click and hold the **Regional Mask Tool** button on the Tools toolbar until a menu appears. Select **Mask Points on Active Plot** to enter masking mode.

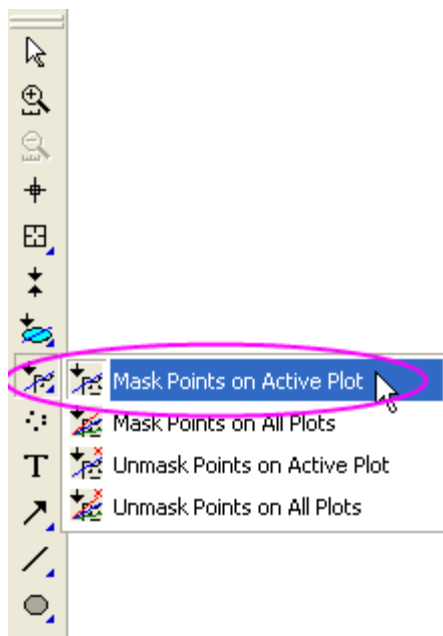

- Click an appropriate place on the graph and drag out a rectangle to select the low peaks and, at the same time, mask them. Drag out additional rectangles until all low peaks are masked. Then click the **Pointer** button on the Tool toolbar to exit masking mode.

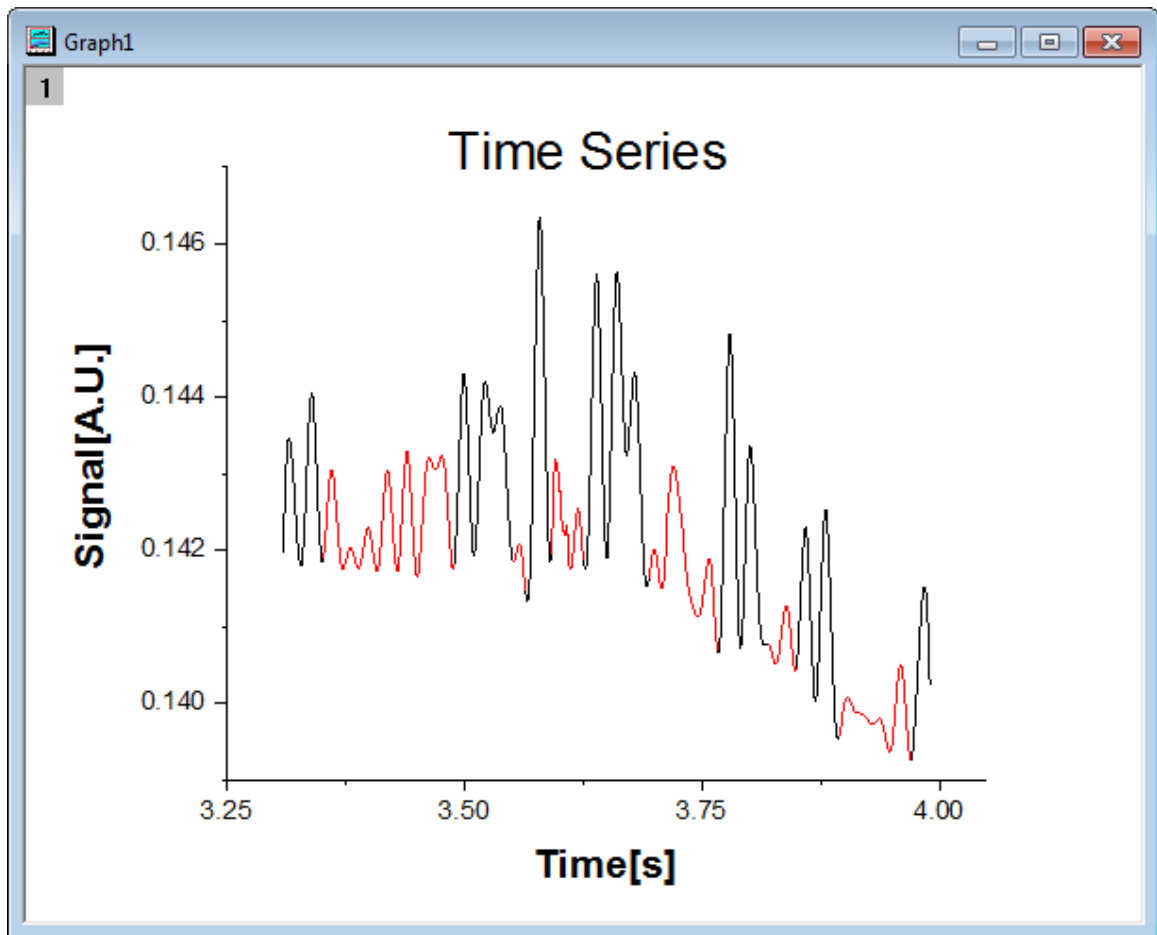

### 6.7.10 Symbol Plot with Color Transparency

#### 6.7.10.1 Summary

This tutorial will show you how to create a symbol plot with color transparency, categorical legend and bubble scale. This graph displays a symbol plot of XY data where the size of the symbol and its color have been mapped to two other data columns in the worksheet: Mass and Type. The categorical legend can be utilized to identify Type via color and the bubble scale can be used to check Mass via symbol size. Color transparency has been applied to the plot so that overlapping data points are visible.

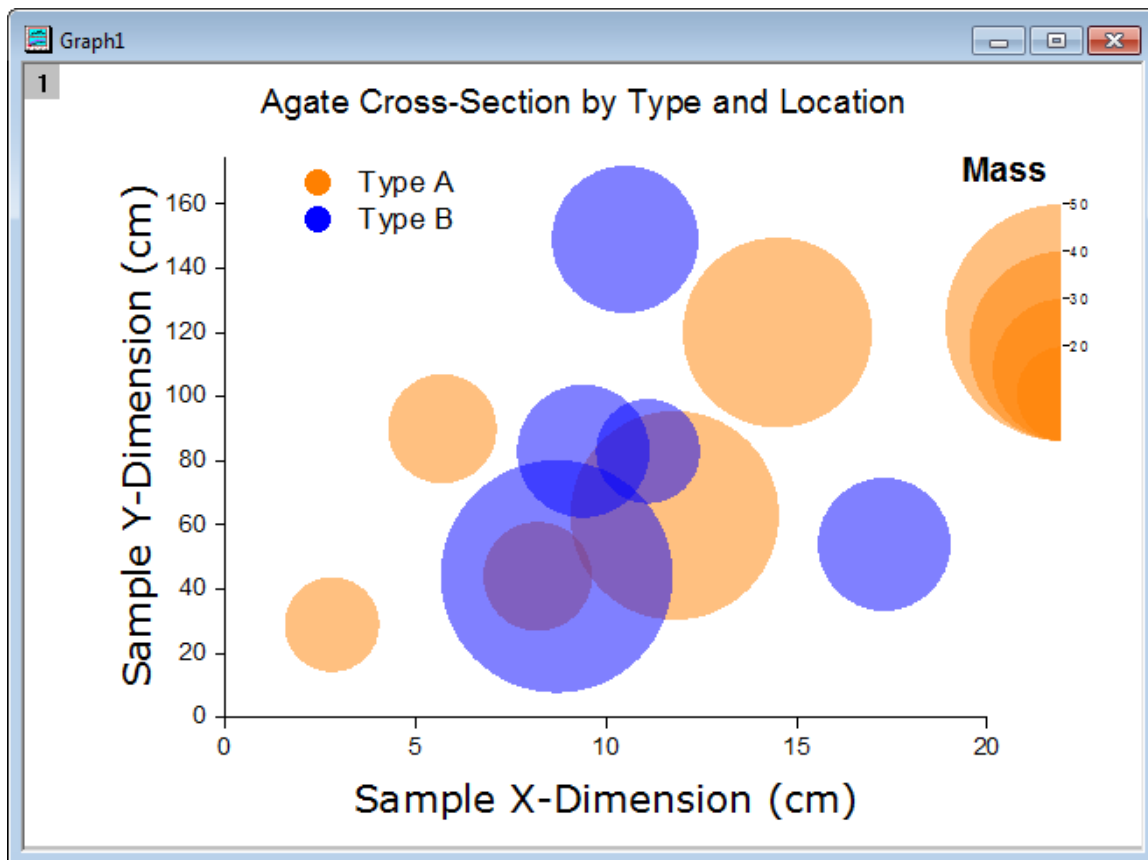

Minimum Origin Version Required: Origin 2015 SR0

#### 6.7.10.2 What you will learn

This tutorial will show you how to:

- How to control the size and color of plot symbols using values in worksheet columns.
- How to add a legend from categorical values
- How to add a bubble scale and customize it
- How to set the transparency to the symbol plot
- How to add a frame to the graph

#### 6.7.10.3 Steps

This tutorial is associated with <Origin EXE Folder>\Samples\Tutorial Data.opj.

Also, you can refer to this graph in Learning Center. (Select **Help: Learning Center** menu or press **F11** key , and then open **Graph Sample: Line and Symbol**)

1. Open **Tutorial Data.opj** and browse to the **Bubble with Transparency** folder in **Project Explorer (PE)**.
2. Go to **Book2G**, highlight Col(A)~Col(C) in the worksheet and select **Plot > Basic 2D : Bubble** from the main menu.
3. Select **Format: Plot...** in the main menu to open the **Plot Details** dialog. Then go to the **Symbol** tab and set the symbol format as in the following:

- Set **Scaling Factor** to **3**.
- Click the down arrow next to the **Preview box** to open the symbol gallery and select the filled circle symbol.
- In the **Symbol Color** drop-down list, select **Indexing: Col("Type")**
- Set **Transparency** to **50%**.

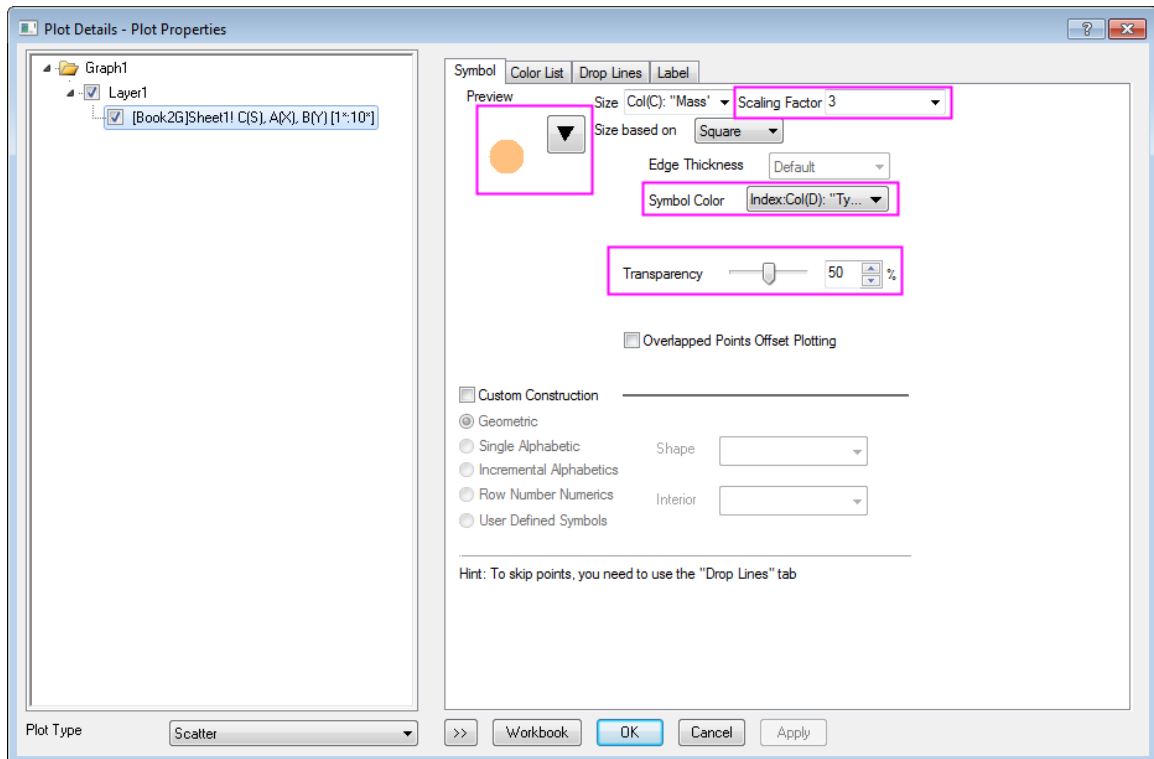

4. Click **OK** to save settings and close the dialog. The graph should now look like this:

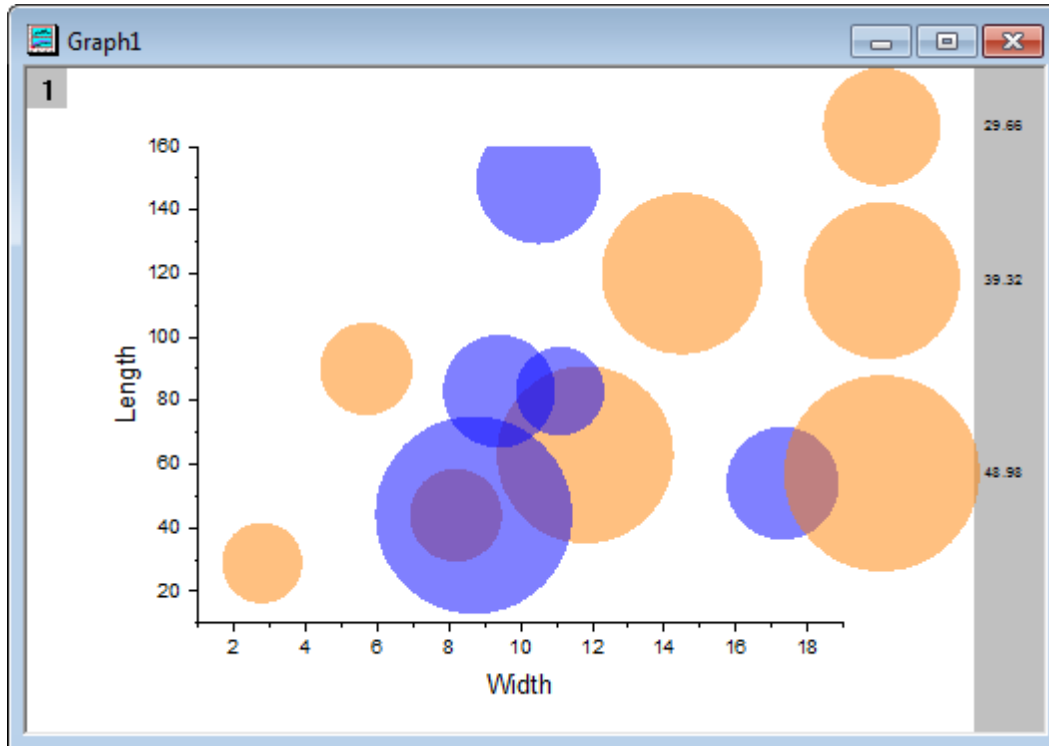

5. To update the axes scales and title, select **Format: Axes: X Axis...** to open the **Axis** dialog box. Modify the following settings:
  - In the **Scale** tab for **X Axis**, choose the following setting:

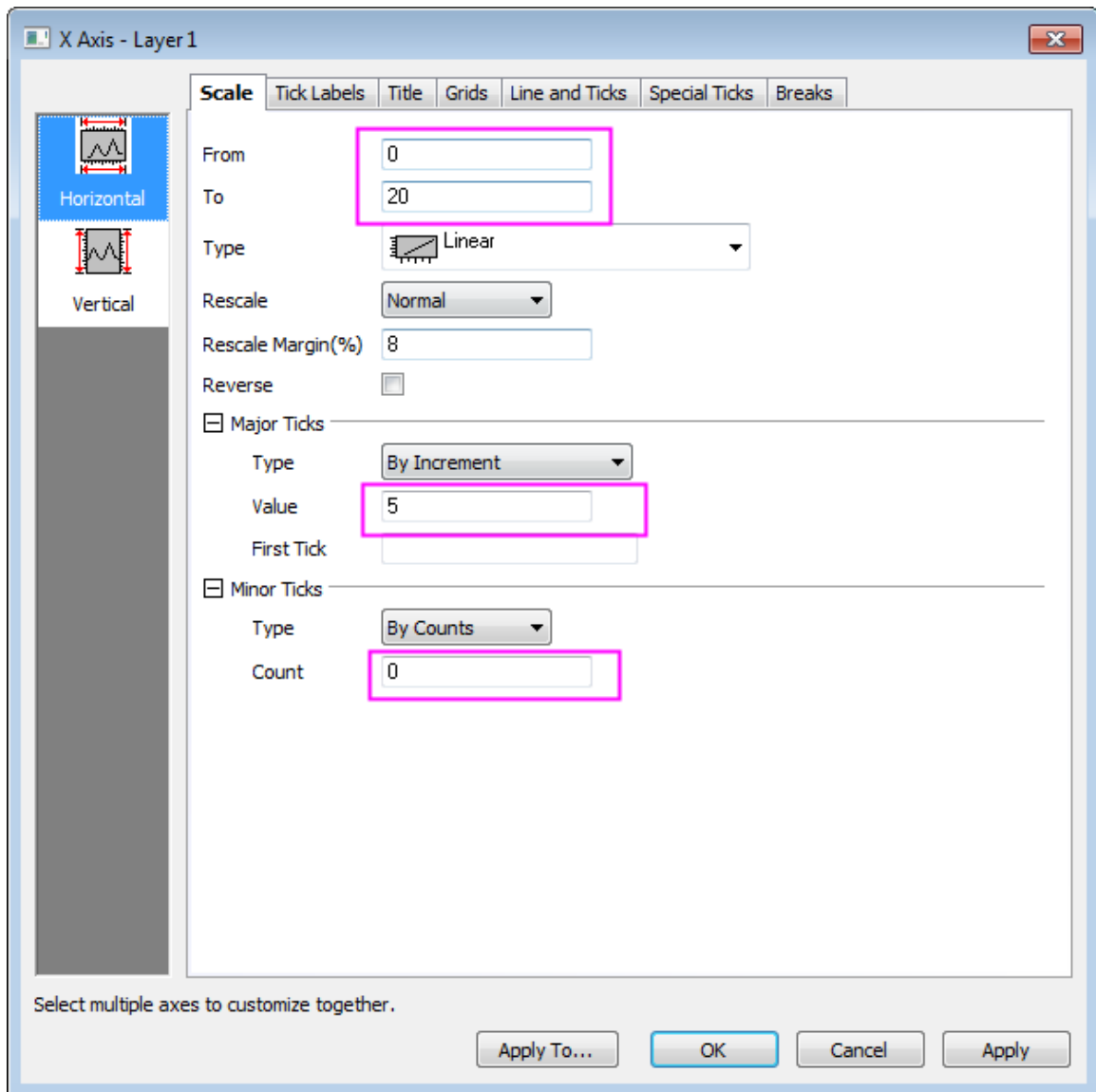

- Click **Vertical** icon on the left panel and go to **Scale** tab for **Y Axis** and set the following:

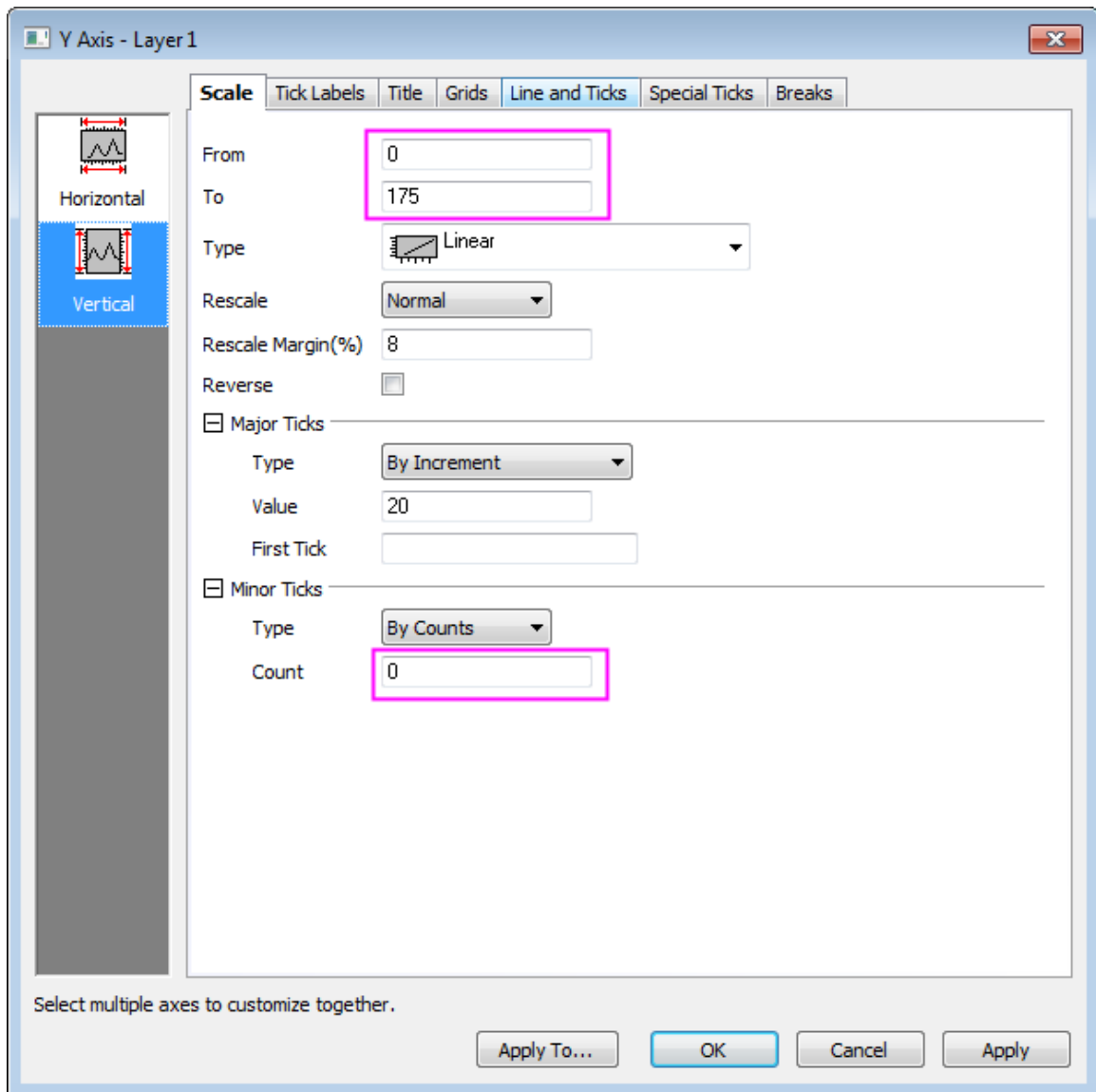

- Go to **Title** tab, and change Y axis title as *Sample Y-Dimension (cm)* and set font and size as following:



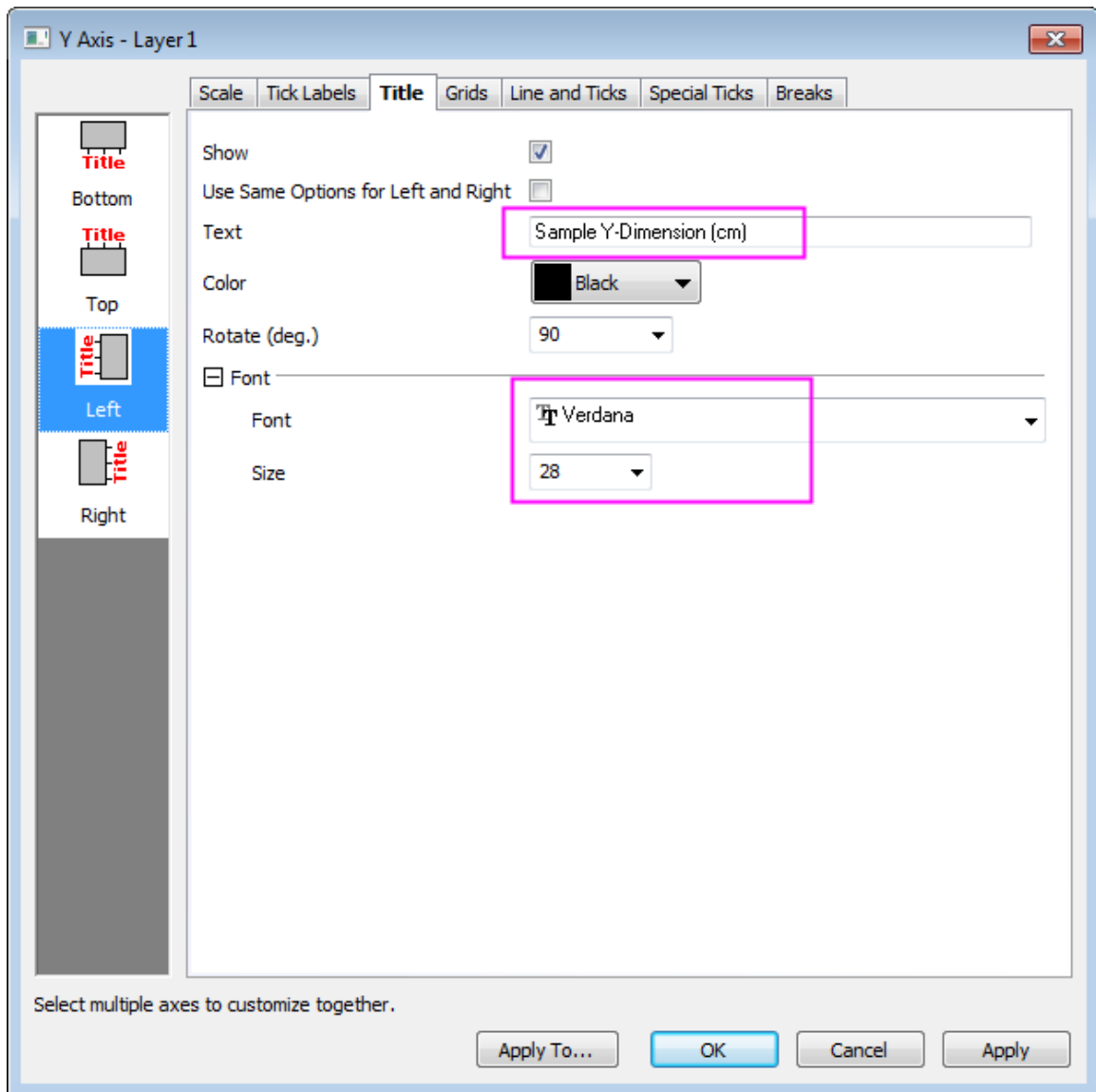

- Then click **Bottom** icon on the left panel and change X axis title as *Sample X-Dimension (cm)* and set and size as following:

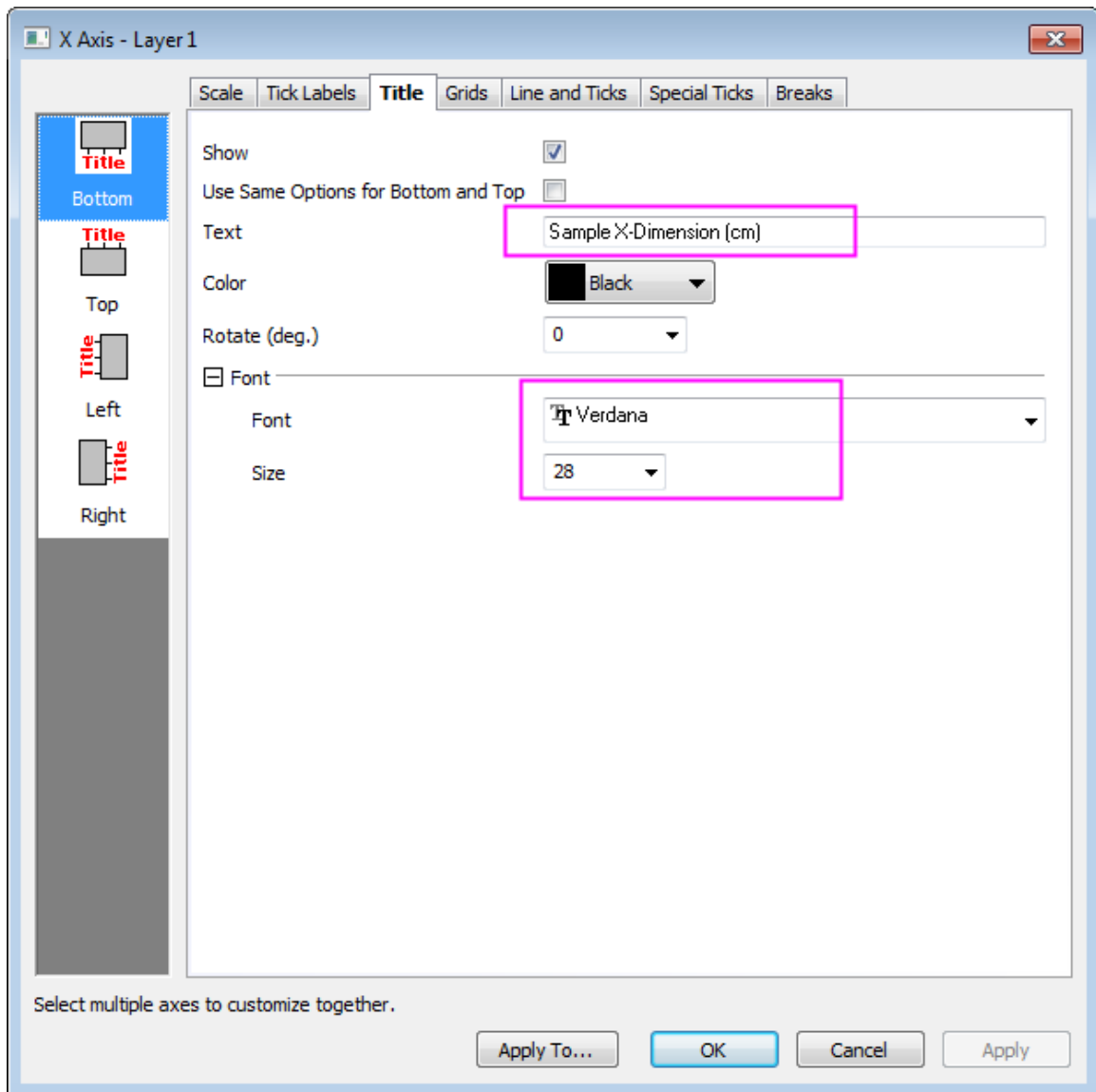

- Click **OK** to apply the settings.

6. Double click on the bubble scale to bring up **Bubble Scale Control** dialog. Select **Nested** from **Layout** drop-down list and check **Half Circle** and **Show Leader Line** boxes and click **Apply** as shown in

following:

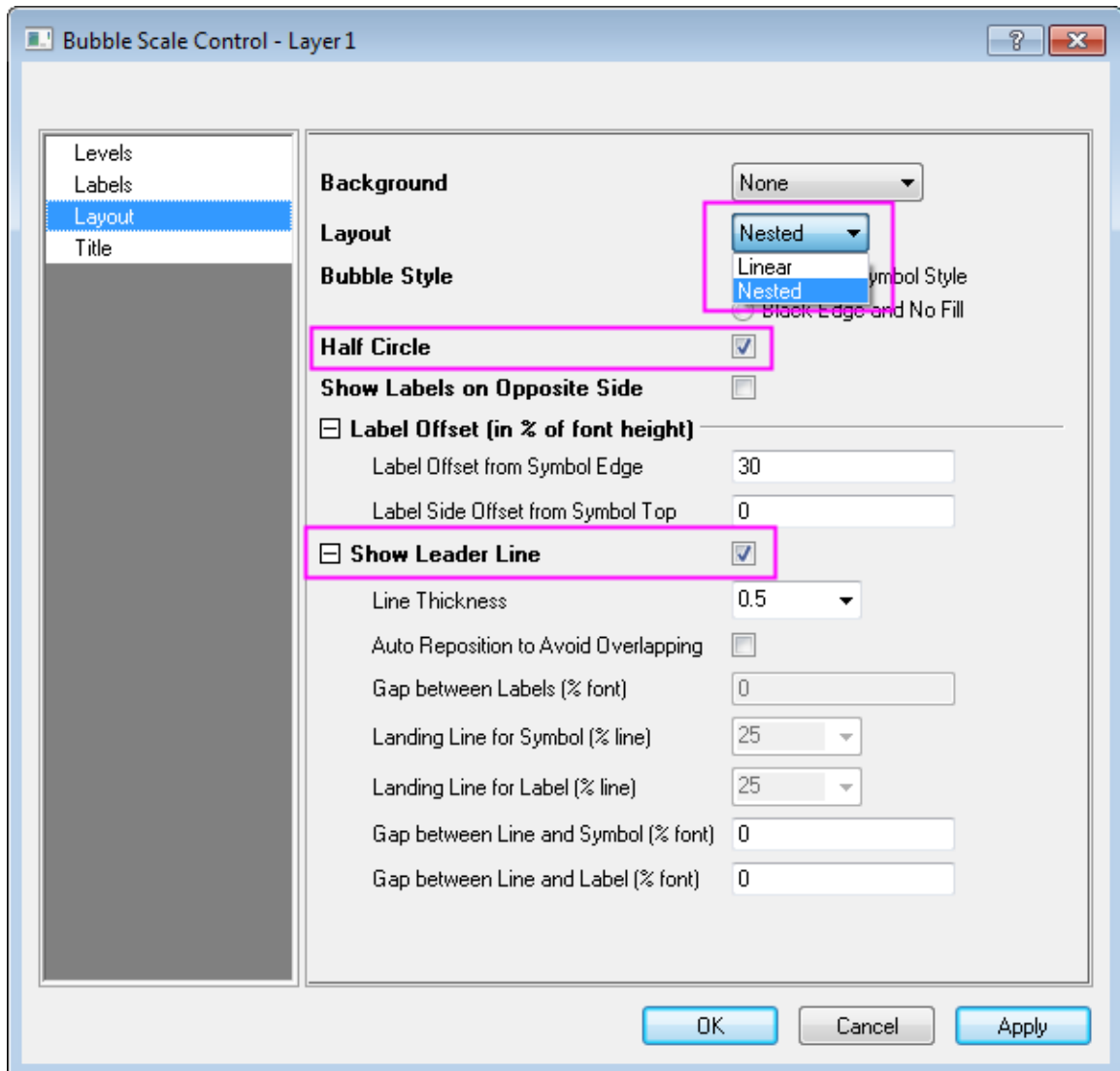

7. Click on the left panel to go to **Levels** page, set **From** as **20** and **To** as **50** and change increment **Value** to **10** as shown in following:

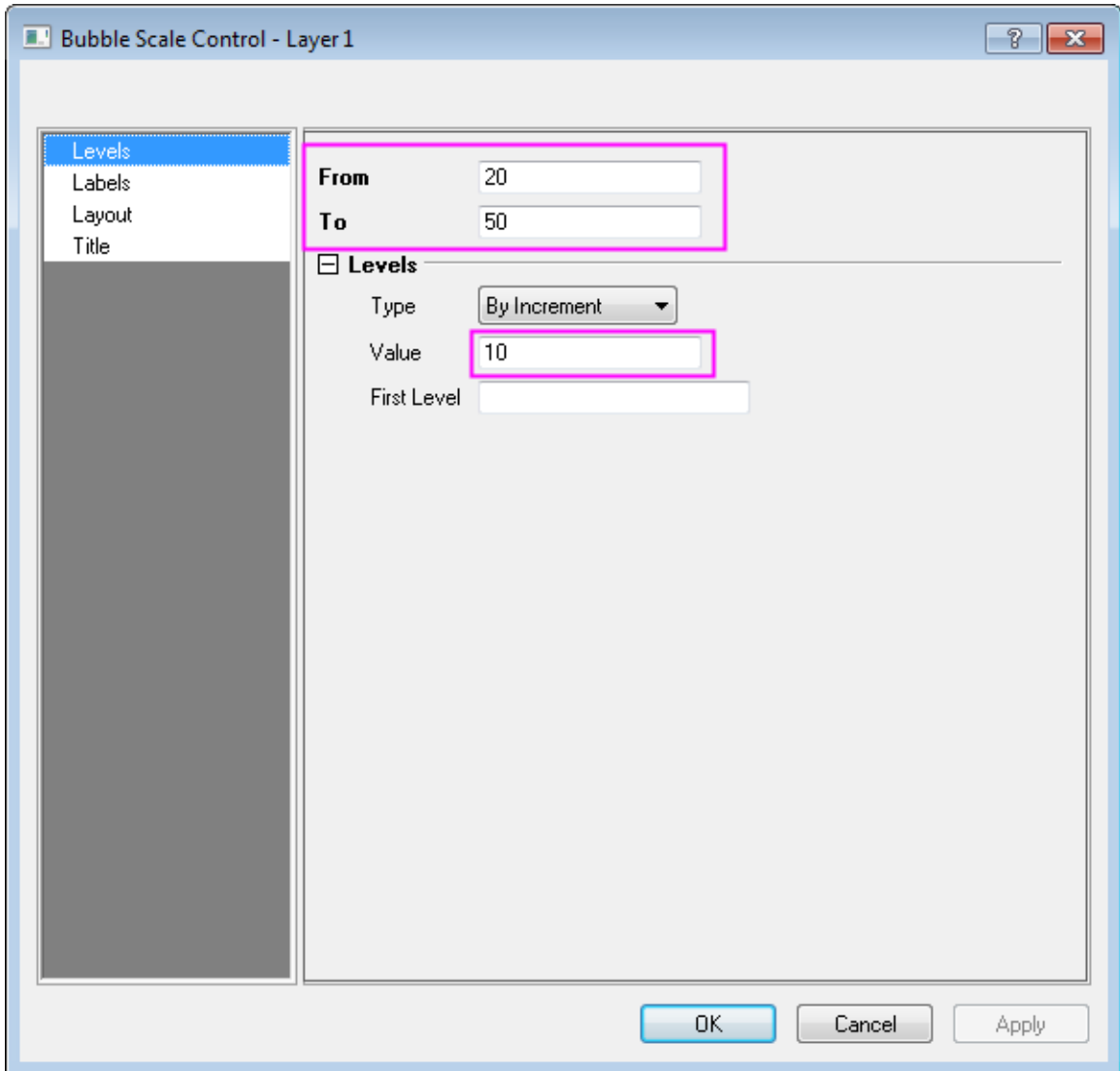

8. Click **Title** on the left panel, check **Show** box and change content in **Title** to be *Mass*, then set the **Size** to be **28** and check **Bold** box. Click **OK** to close dialog as shown in following:

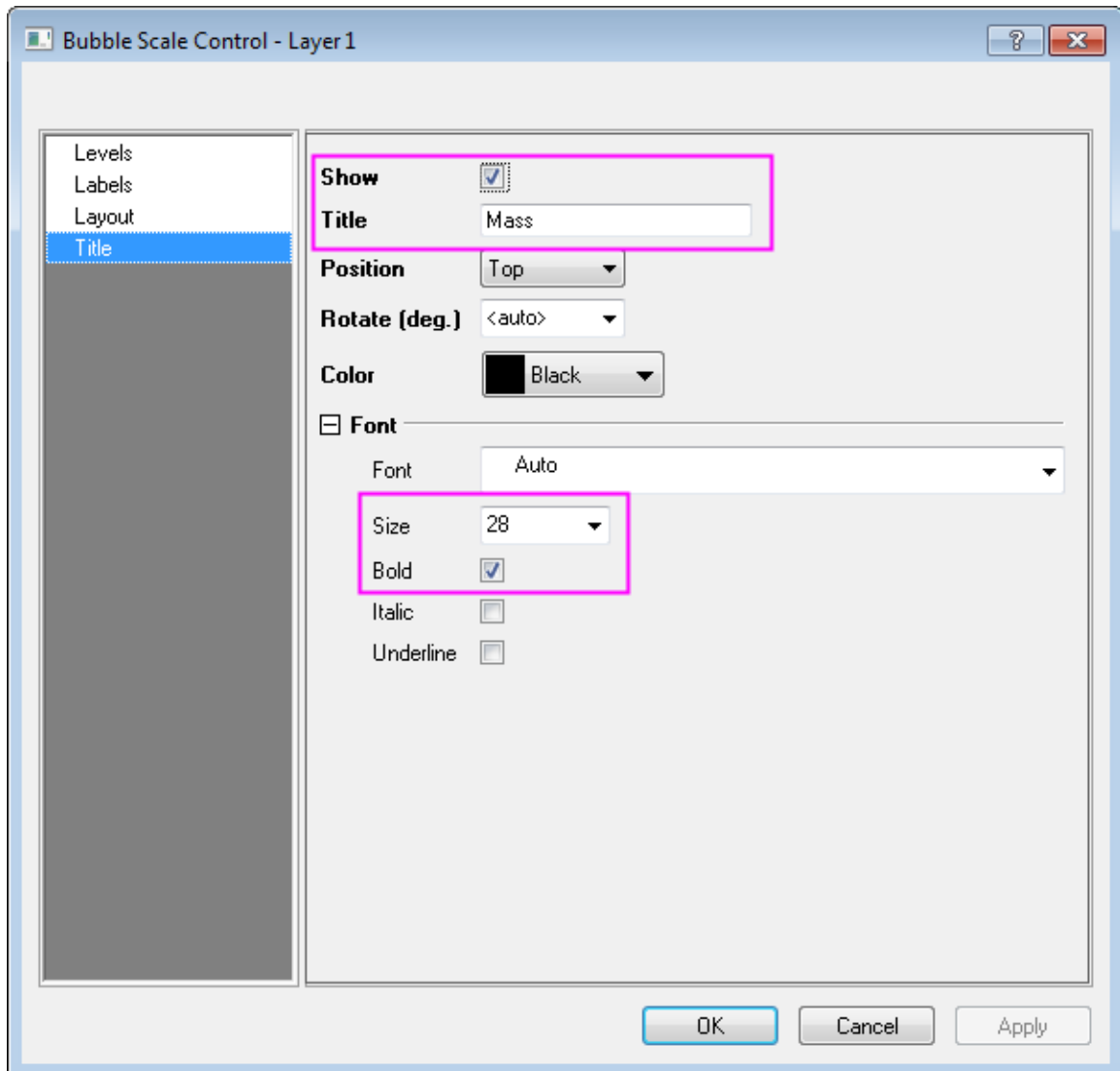

9. The graph is as following now:

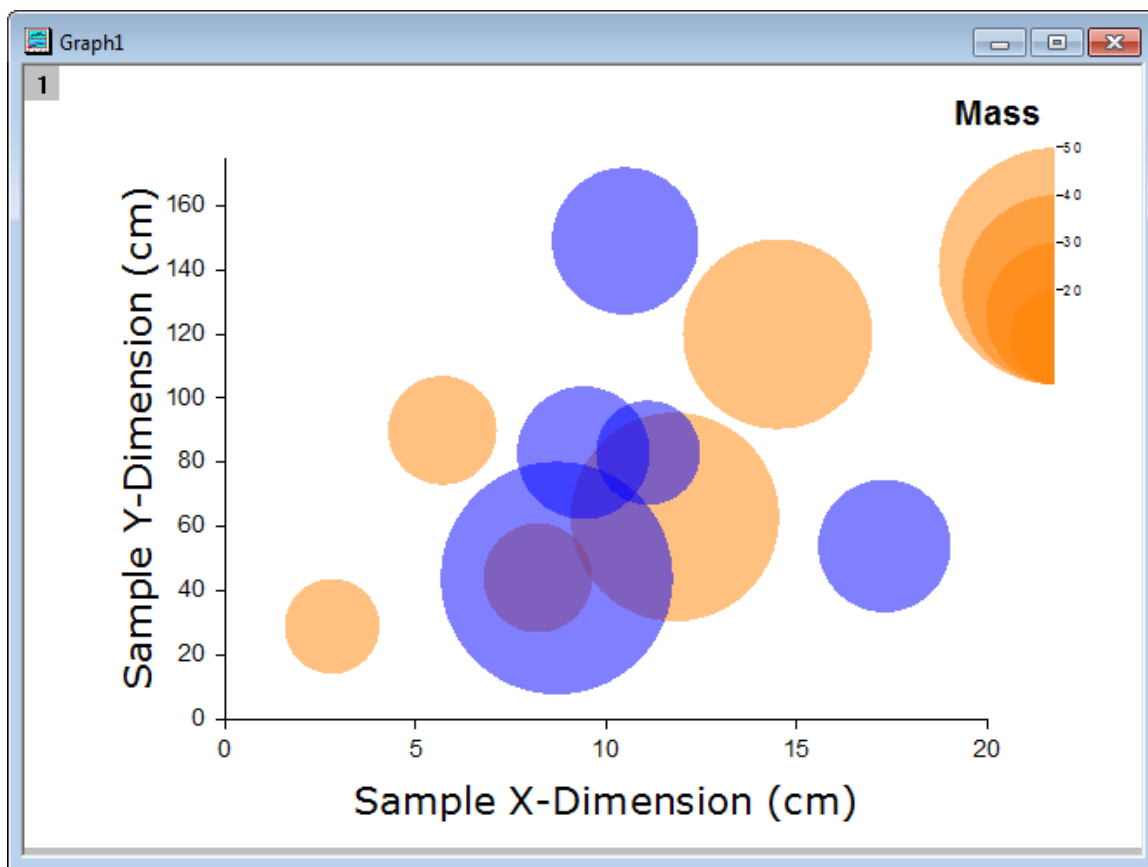

10. Go to **Graph:Legend:Categorical Values...** to bring up **Graph Manipulation:legendcat** dialog. Uncheck **Size** box and click **OK** to close the dialog and move the generated legend to a proper position in top-left corner.

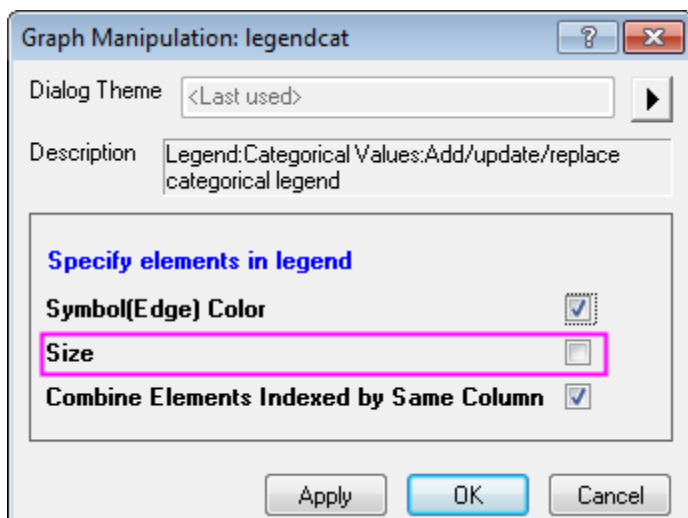

11. Right click on the legend and select **Properties** from shortcut menu, customize the text as shown in the following:

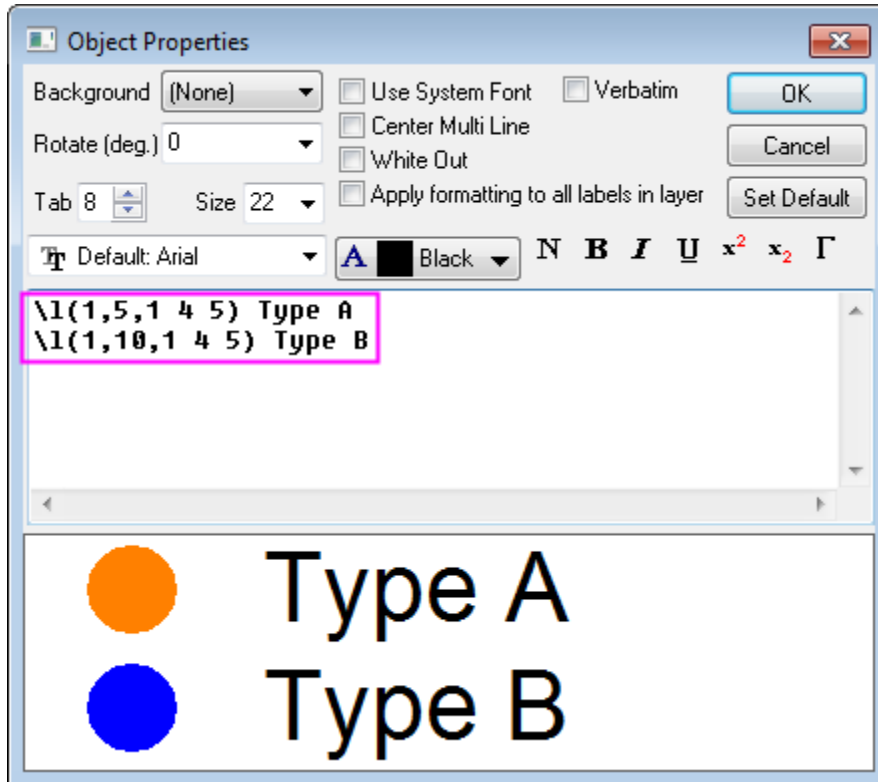

12. Click **OK** to close dialog.
13. Select the **Text Tool**  button on the **Tools** toolbar and click once to the left side of the page just above the frame. Type the following into the text object: *Agate Cross-Section by Type and Location*. Customize the font. Select and re-position the text object as needed.

The final graph should look something like this:

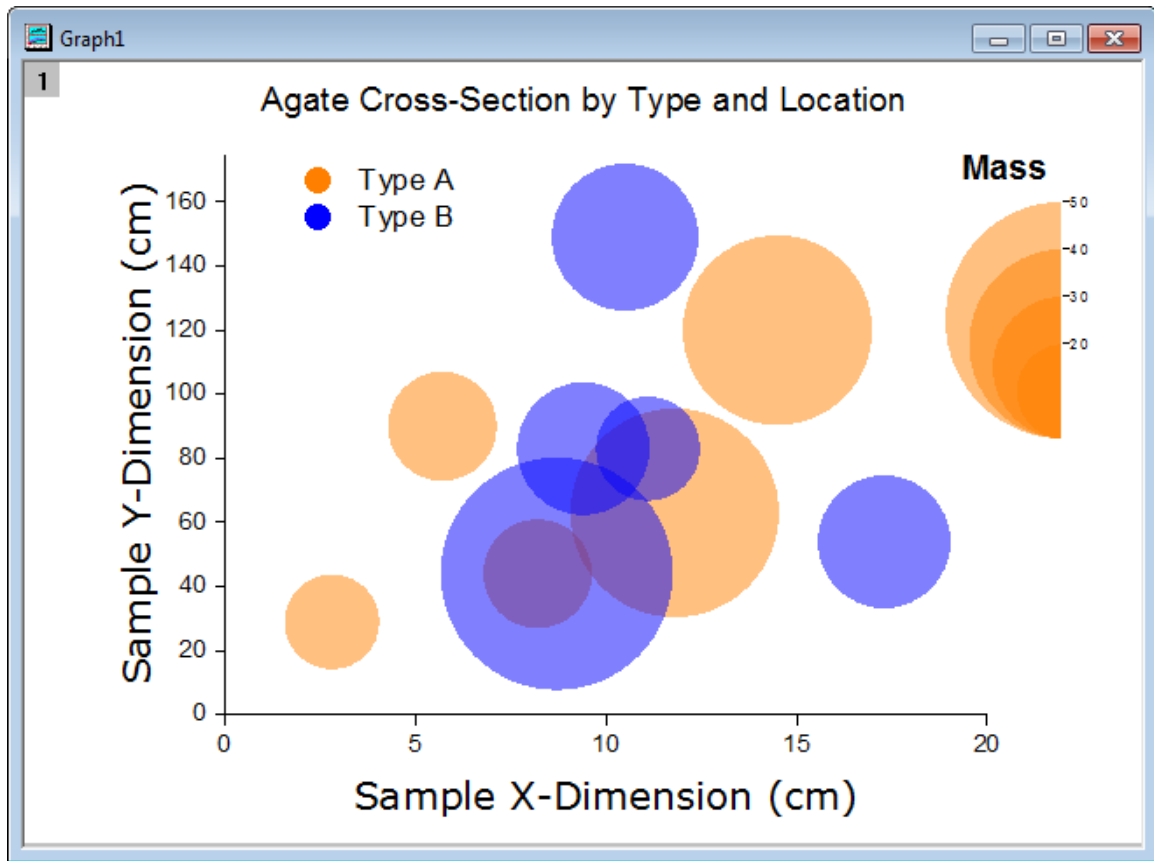

### 6.7.11 Symbol Plot with Size and Colormap from Other Columns

#### 6.7.11.1 Summary

This tutorial will show you how to create a symbol plot with size and color from other columns.

This graph displays a symbol plot of data from multiply columns where the size and color of the symbol have been derived from other data columns in the worksheets. User defined Colormap has been applied to the plot.



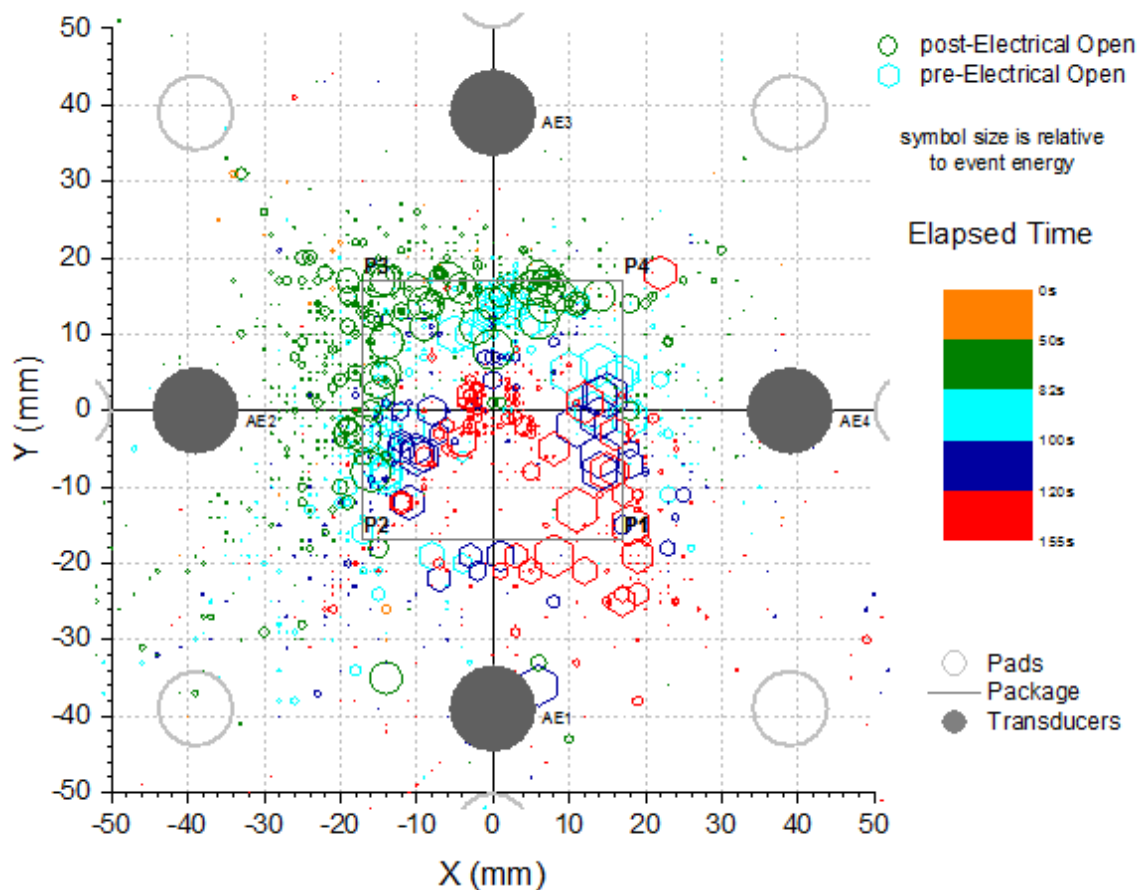

Minimum Origin Version Required: 2016 SR0

#### 6.7.11.2 What you will learn

This tutorial will show you how to:

- How to control the size and color of plot symbols using values in worksheet columns.
- How to set the user defined colormap
- How to edit the grids lines for plot

#### 6.7.11.3 Steps to Construct a Symbol Plot with Size and Colormap from Other Columns

This tutorial is associated with the Tutorial Data project: <Origin EXE Folder>\Samples\Tutorial Data.opj.

1. Open the Tutorial Data project and browse to folder *Symbol Plot with Size and Color Mapping* in **Project Explorer**.
2. Select the Col(X) and Col(Y) in first sheet of the workbook and click **Plot > Basic 2D : Scatter** to get a scatter plot.
3. Click **Graph: Layer Contents** in main menu with the graph active, and select all the columns with Long name **Y, Y1, Y2** and add them into the right panel. Click **Ungroup** button to ungroup all datasets. Click

**OK** to close dialog. The order and quantity of column Long name listed in right panel should be exactly the same as the graph, use up and down button to adjust the position, and use  to remove the repetitive items.

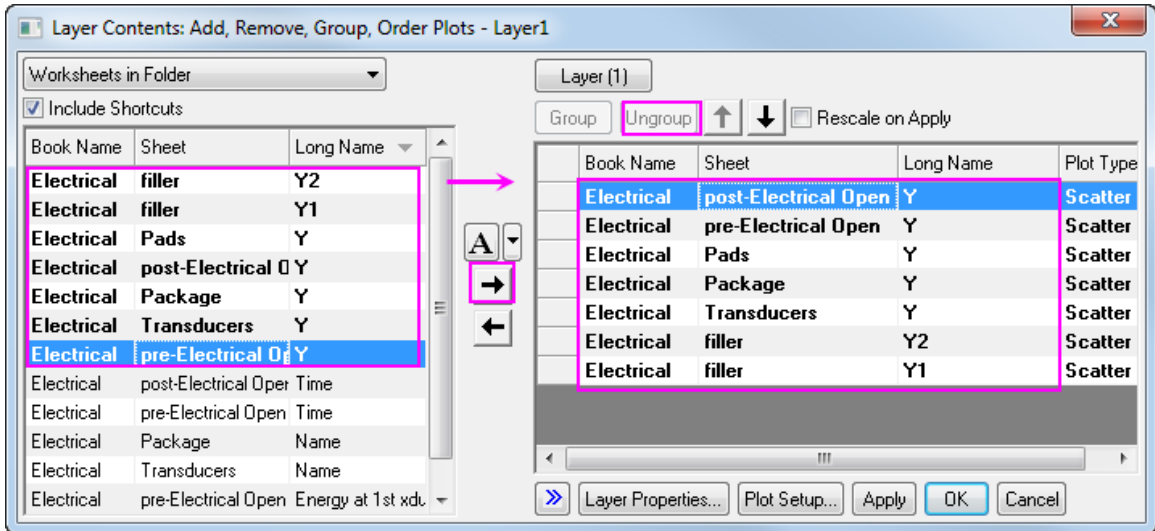

4. Double click the scatter to open the Plot Details dialog, go to **Symbol** tab, Set the Symbol for each plot one by one follows the Graph below, after each step setting, please click **Apply** to make a rudimentary saving.

5. The next 7 steps will guide you finish the symbol setting for each dataplot. Symbol setting for dataplot 1:

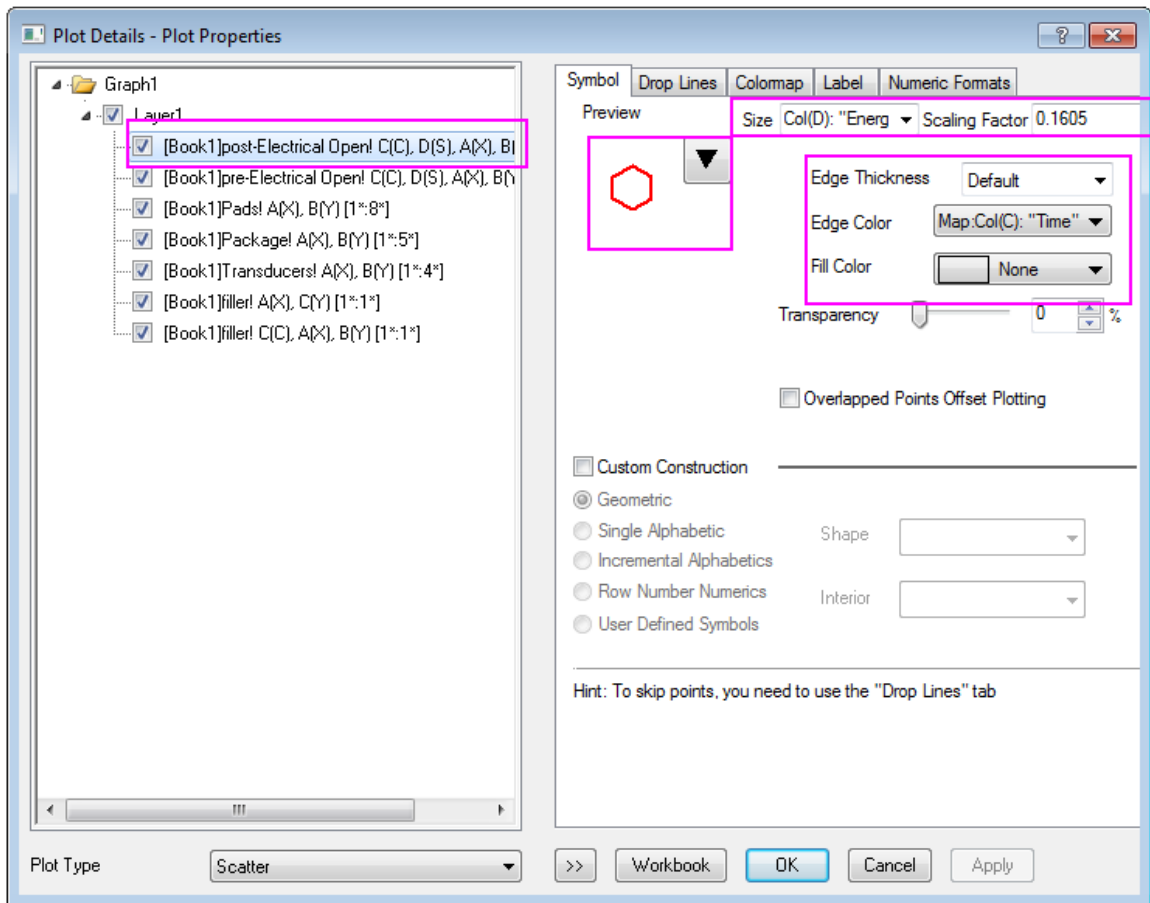

6. Symbol setting for dataplot 2

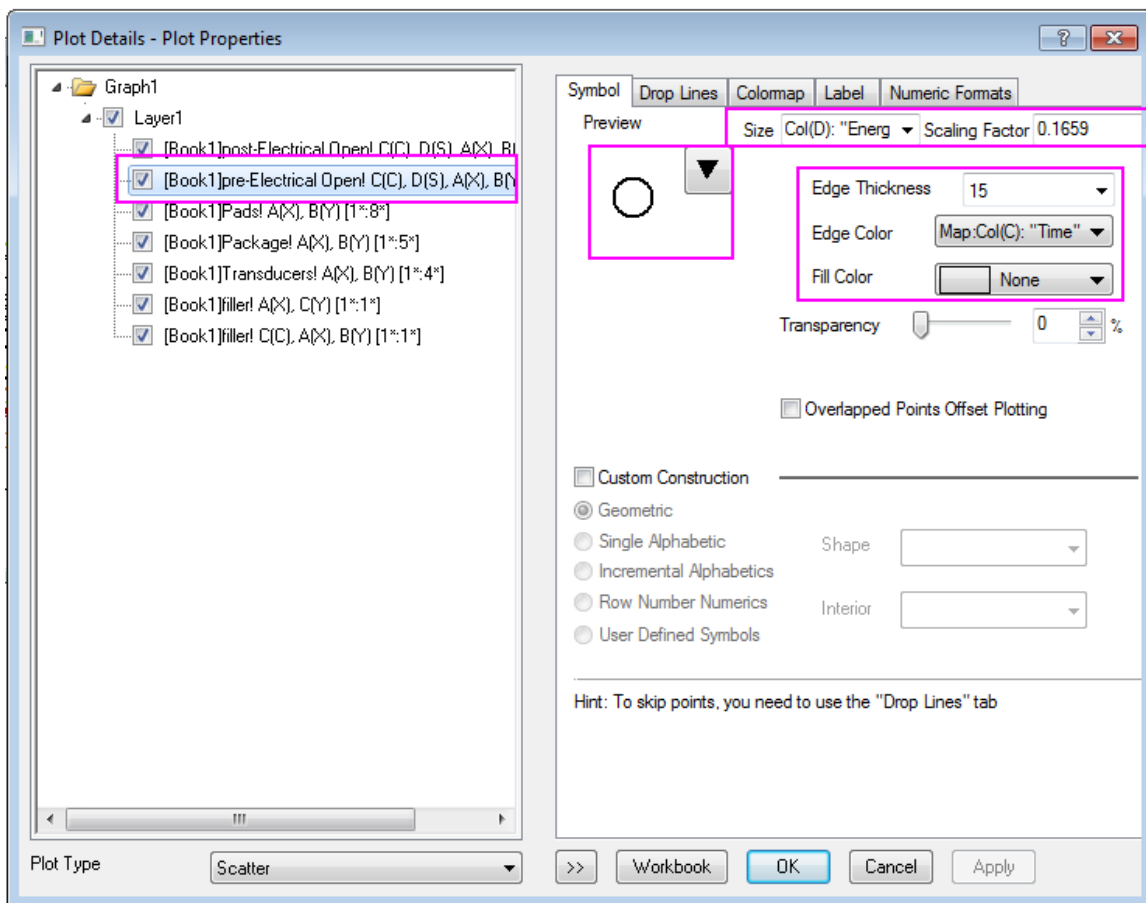

7. Symbol setting for dataplot 3

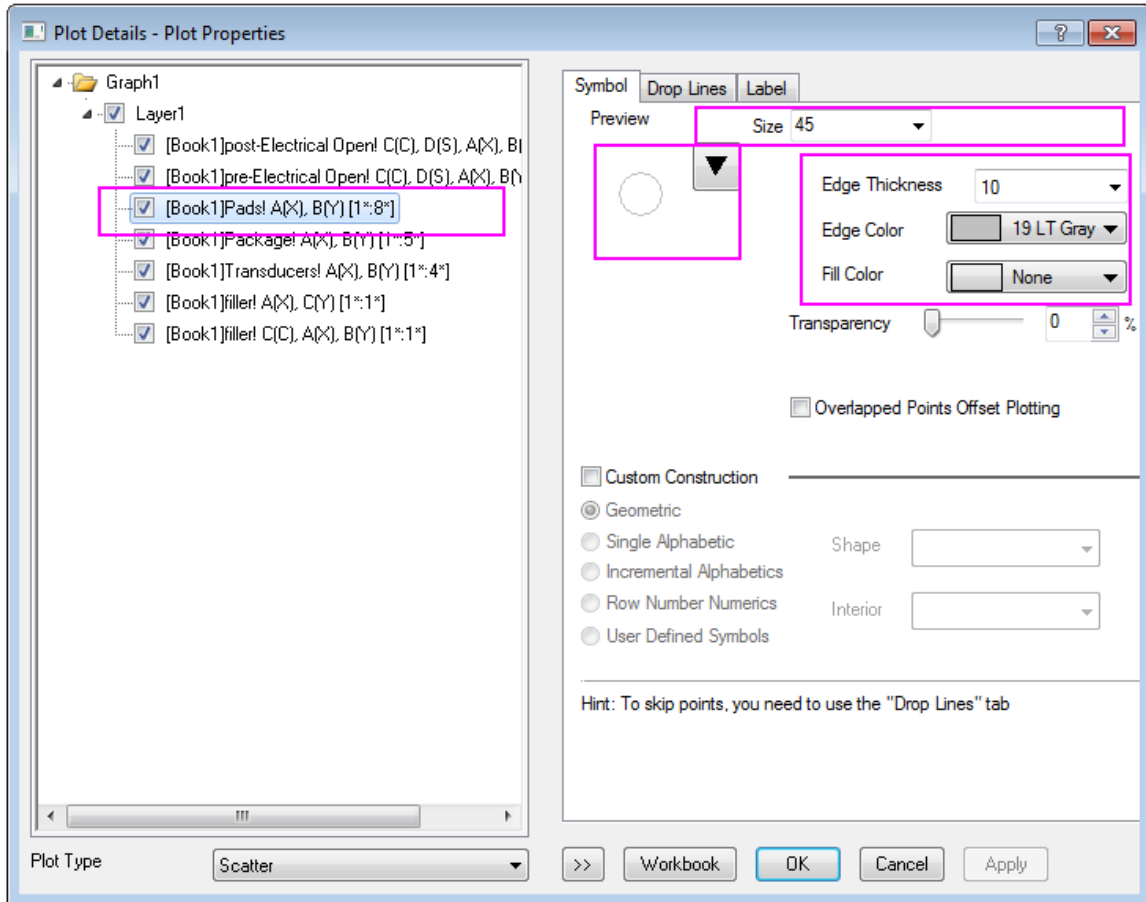

8. Symbol setting for dataplot 4

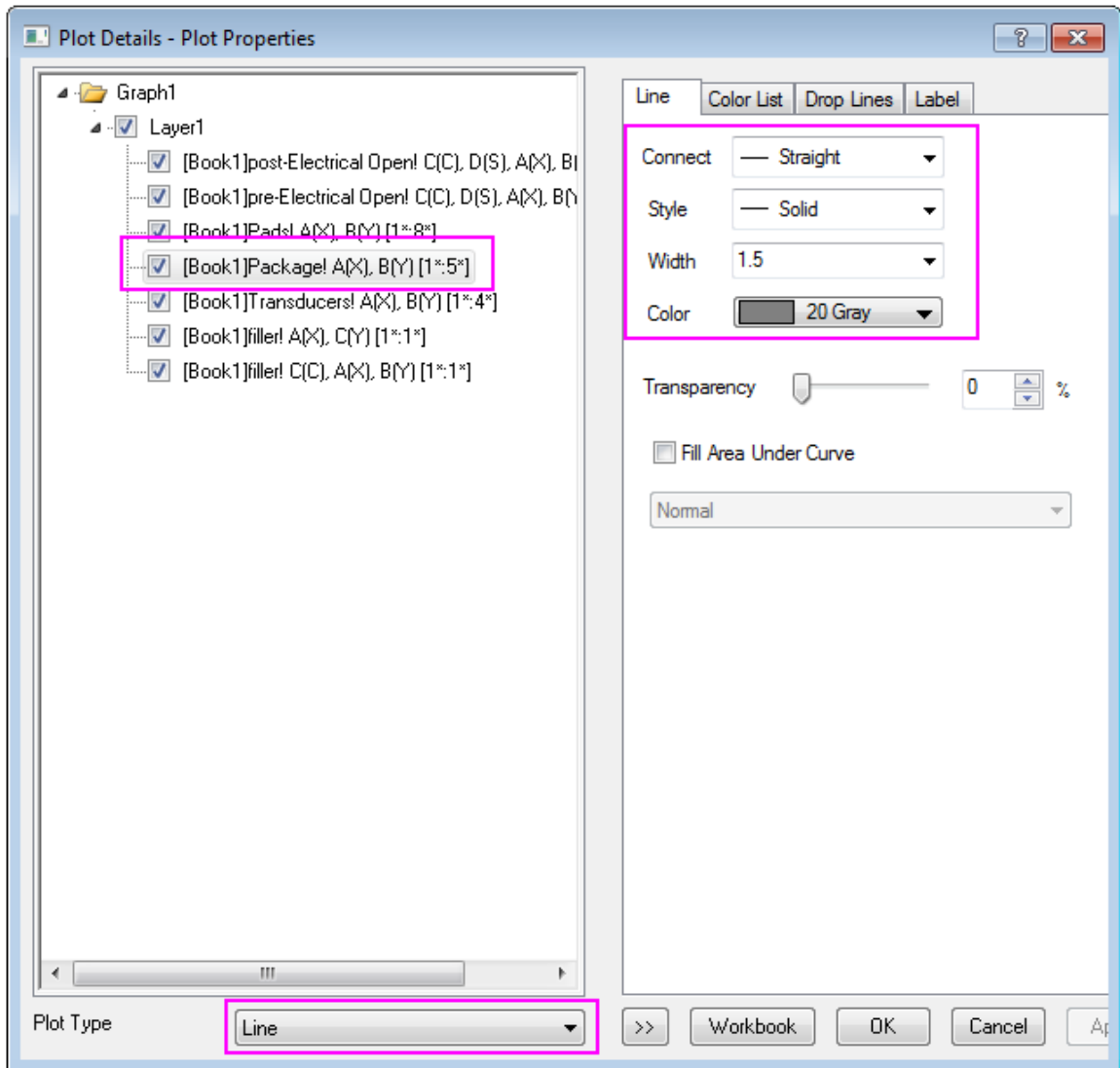

Add label for dataplot 4

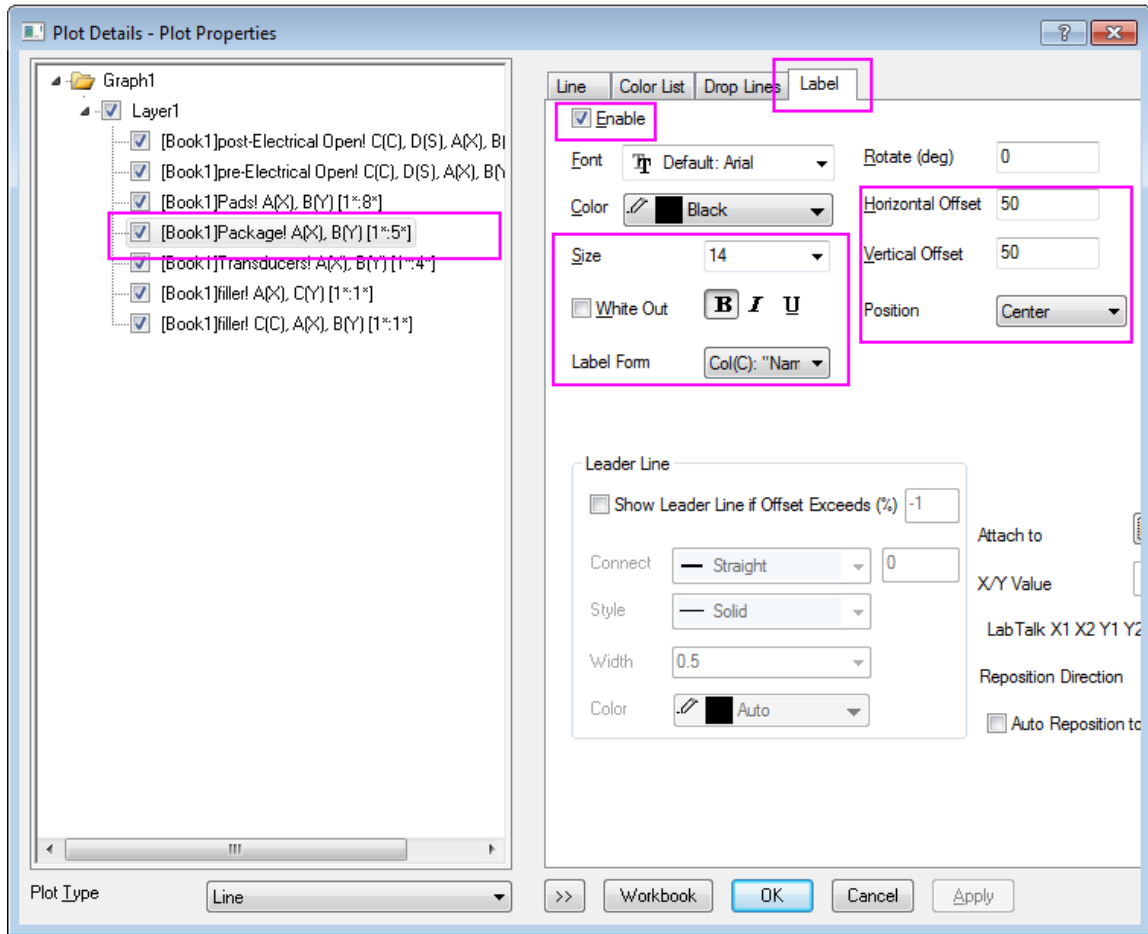

9. Symbol setting for dataplot 5

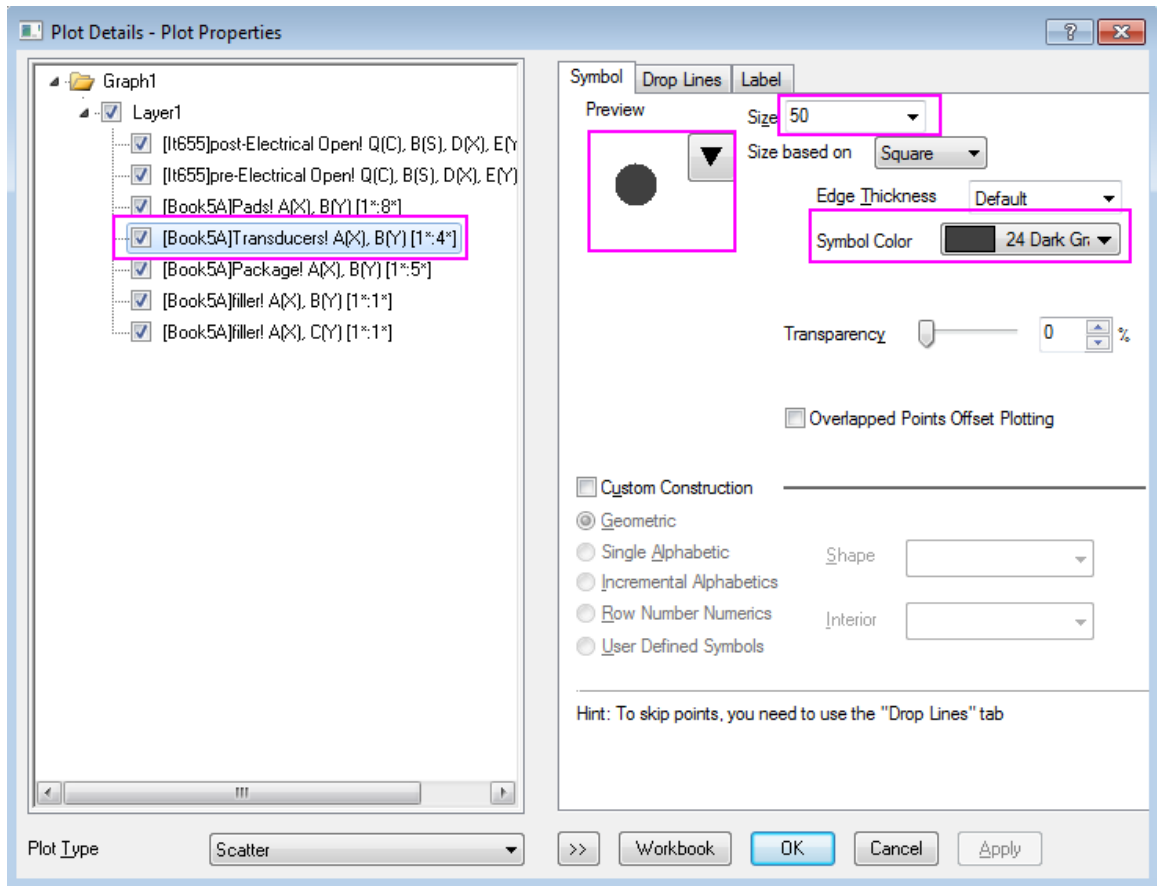



Add label for dataplot 5

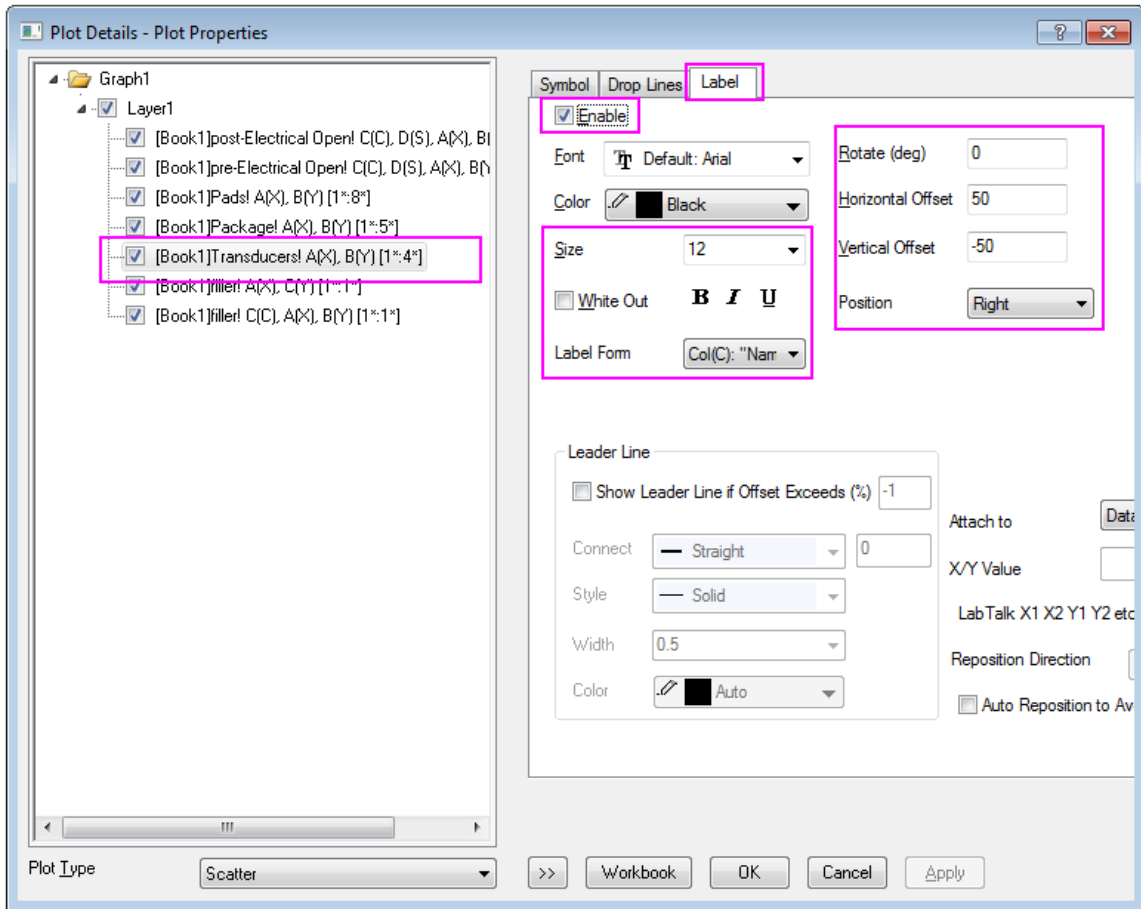

10. Symbol setting for dataplot 6 and 7, which act as the legend:

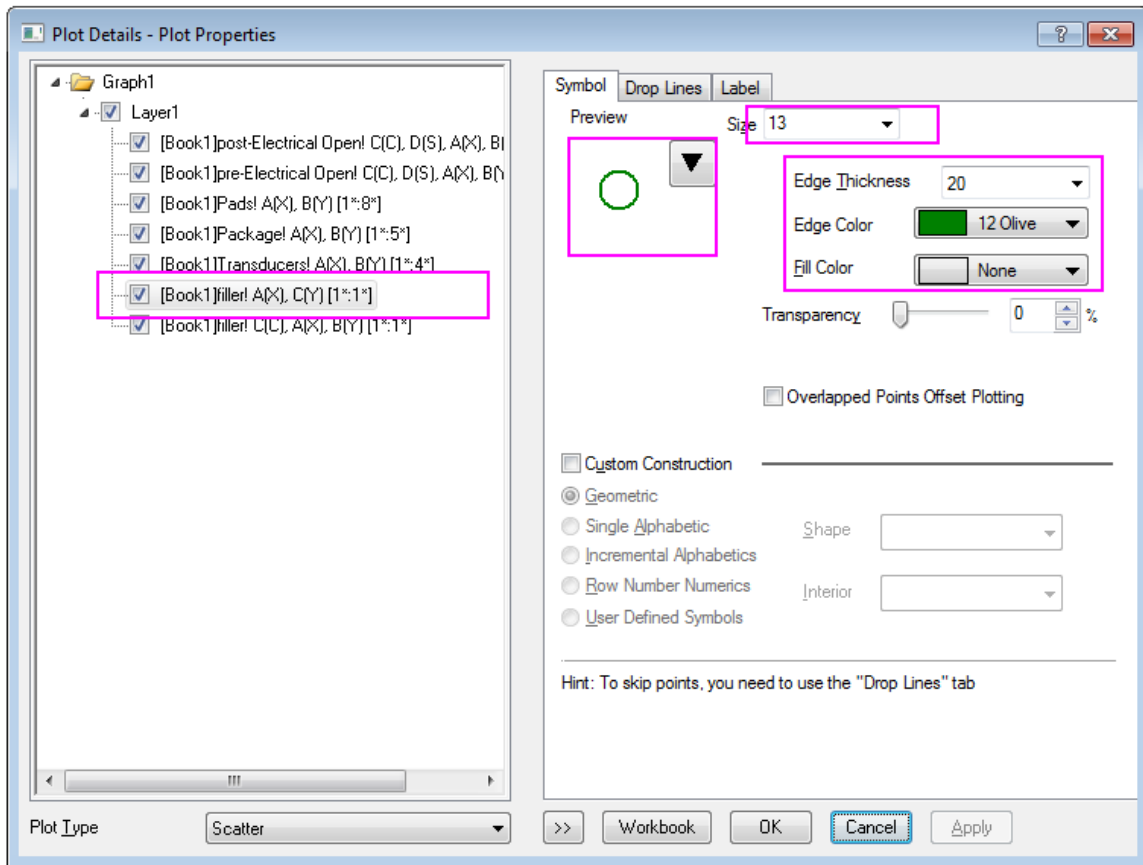

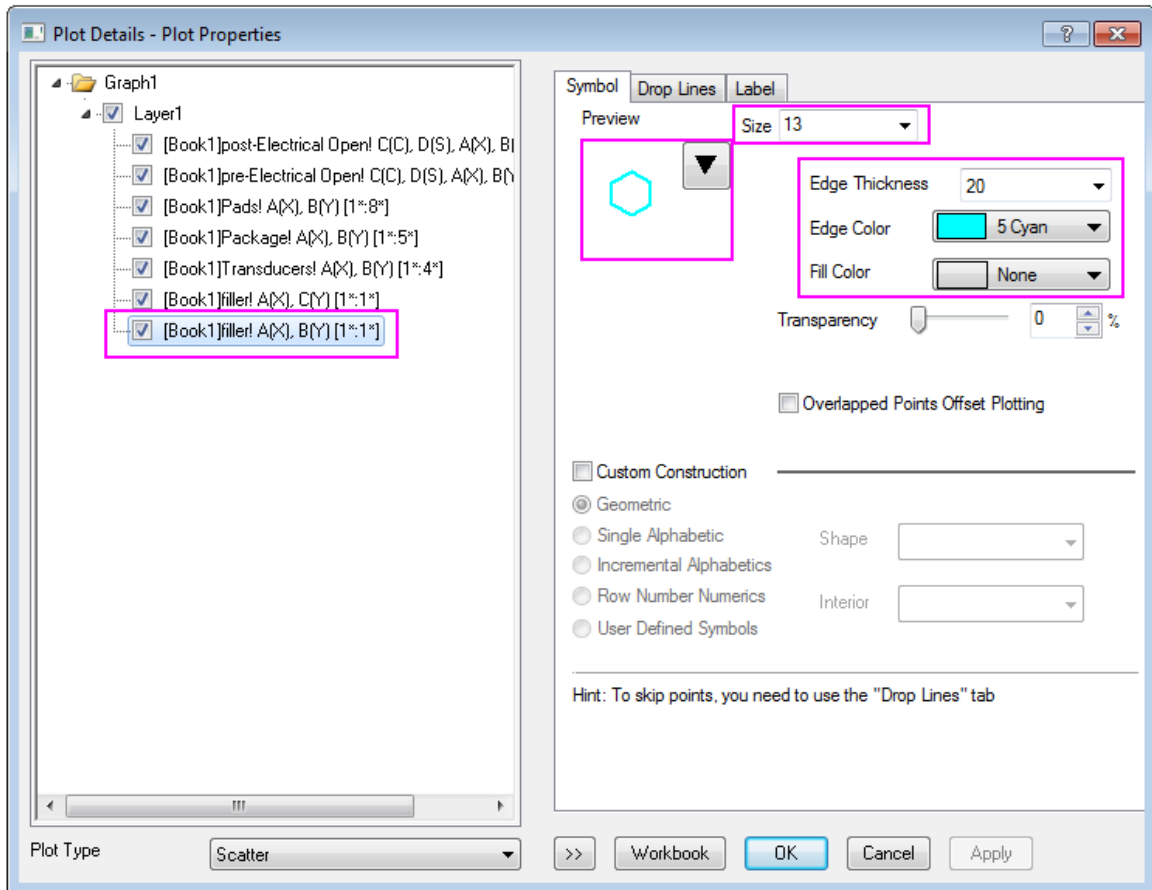

- Then, Click **OK** to close the window. Double click the Axis X to open the Axis dialog, and set the Scale for both **Horizontal** and **Vertical** icons From -50 to 50 with same Major and Minor ticks style:

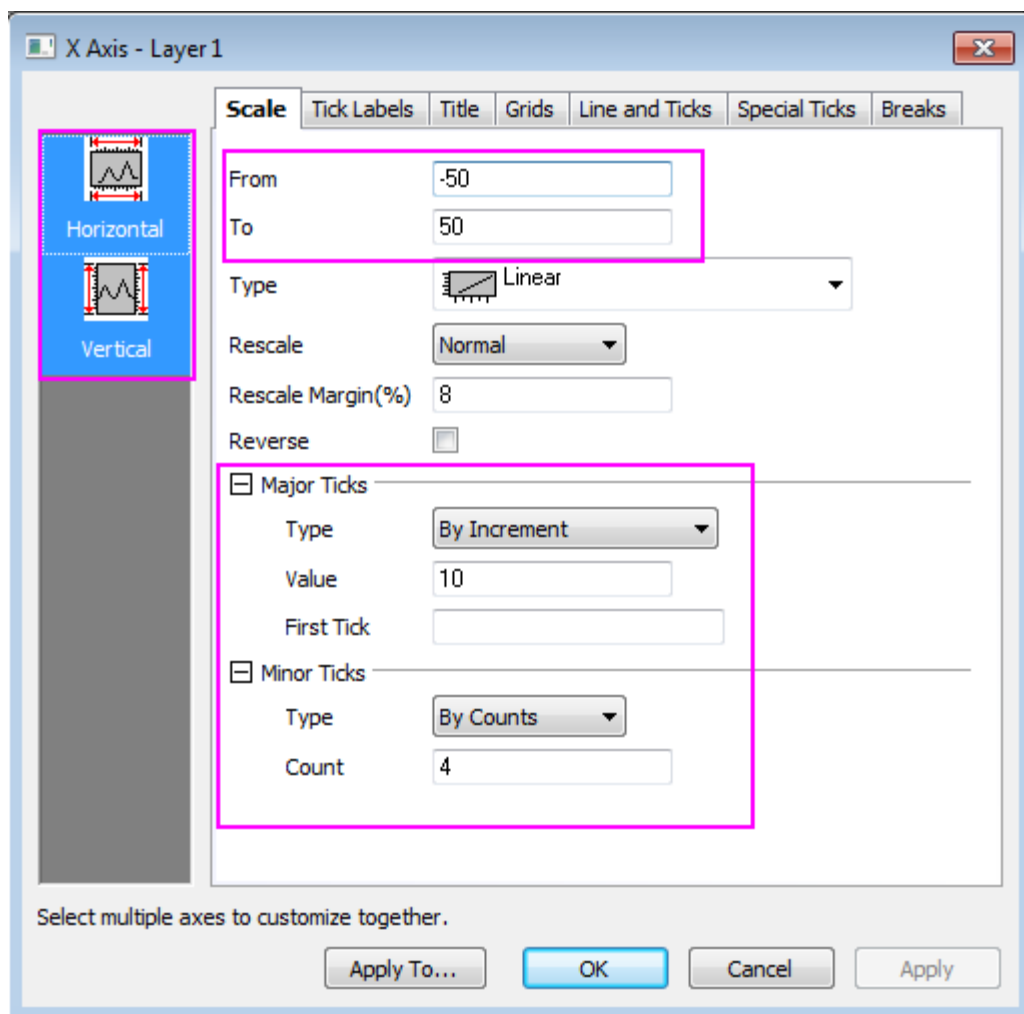

then click **OK** to apply. you can get a graph like this:

12.

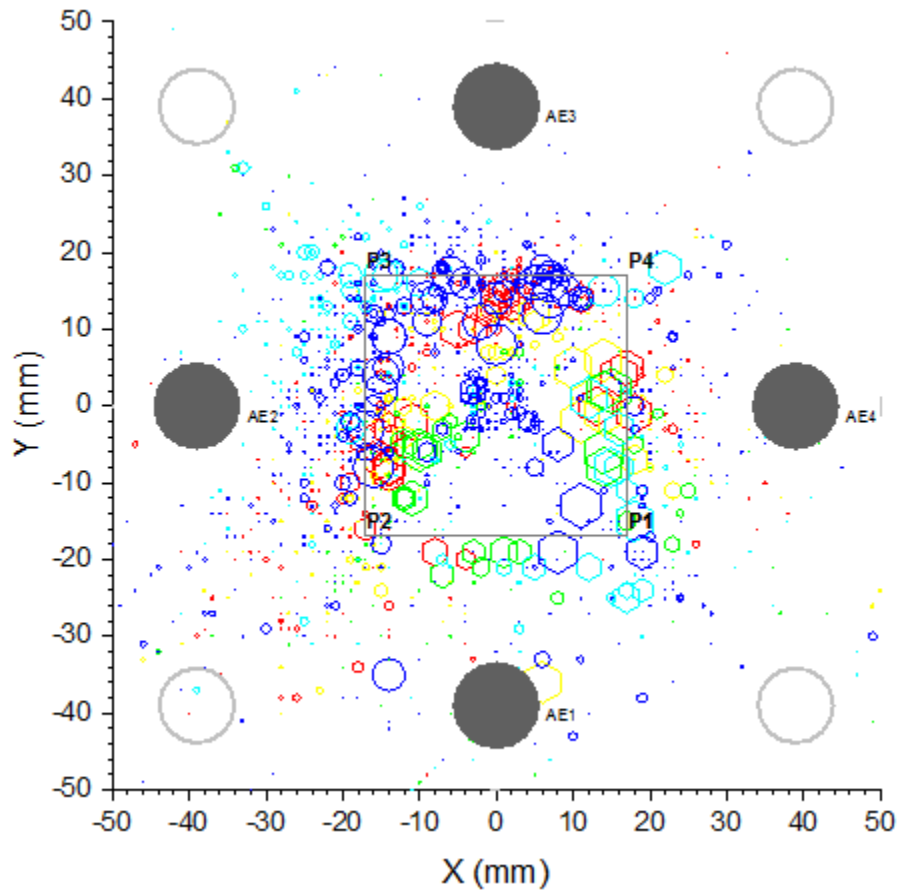

#### 6.7.11.4 Steps to Set the Colormap and Legend

1. The Edge color of the post-Electrical Open and pre-Electrical Open plot both used Map:Col(C), so we will further make some style setting for Color scale in **Colormap** tab. Click **Level** to open **Set Levels** dialog, set levels from 0 to 155 with Major Levels 5.

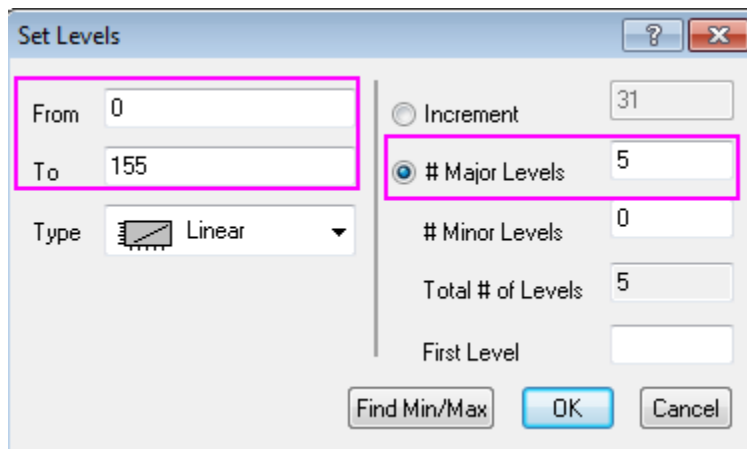

2. Double click each Level value to edit them and double click each Fill color to edit them as well :

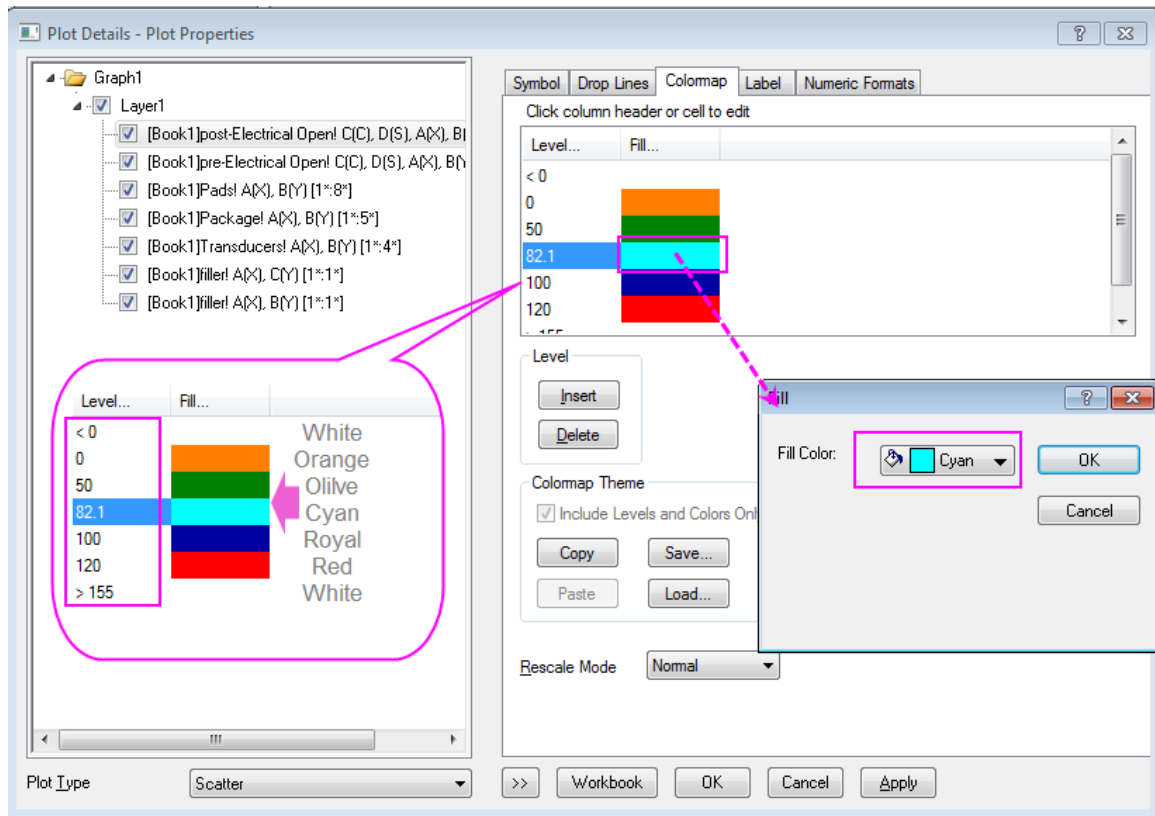

Click Apply to apply these color setting to the graph (for the post-Electrical Open scatter).

3. Then we would like to save the setting as a theme named as mycolor.oth. The theme will be applied to the post-Electrical Open scatter.

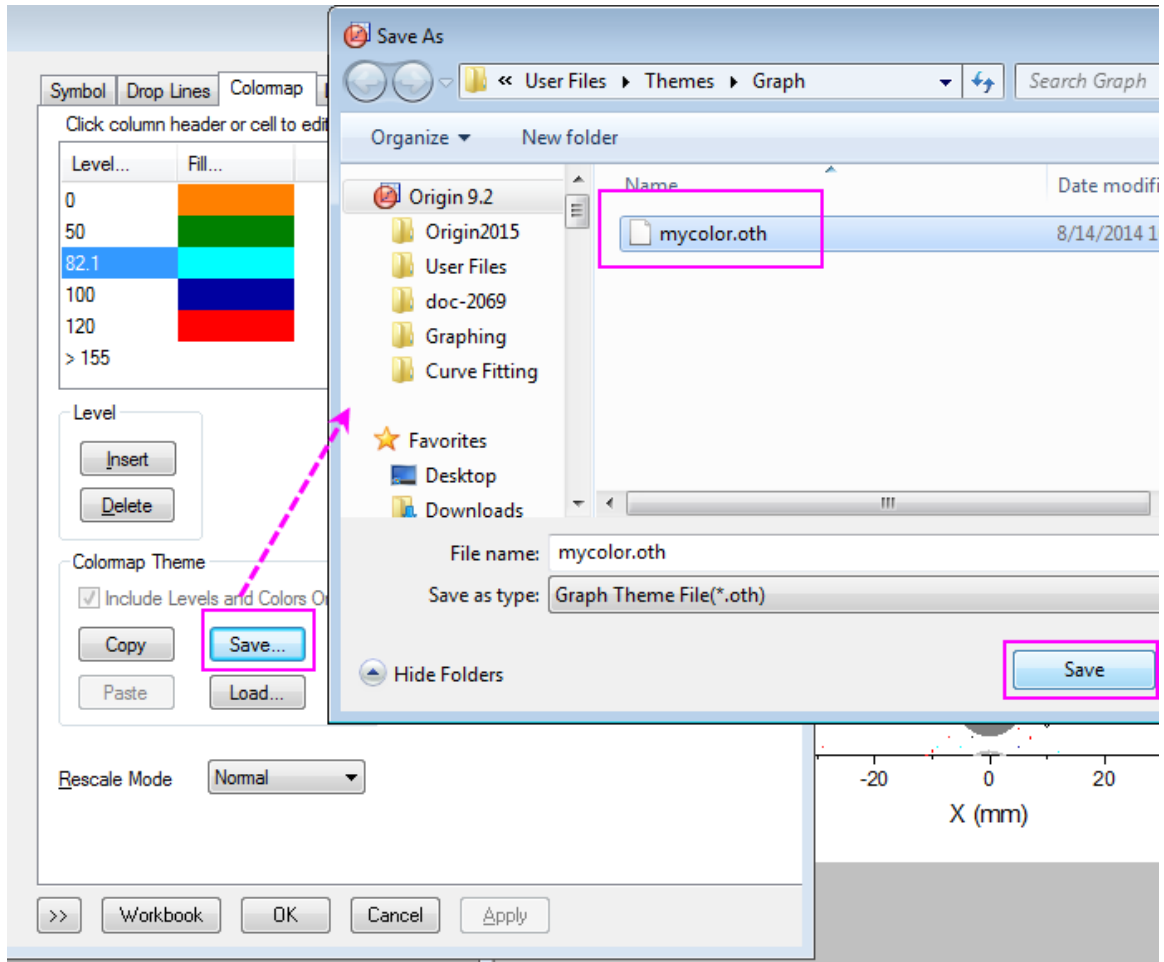

Apply the theme to the pre-Electrical Open scatter.

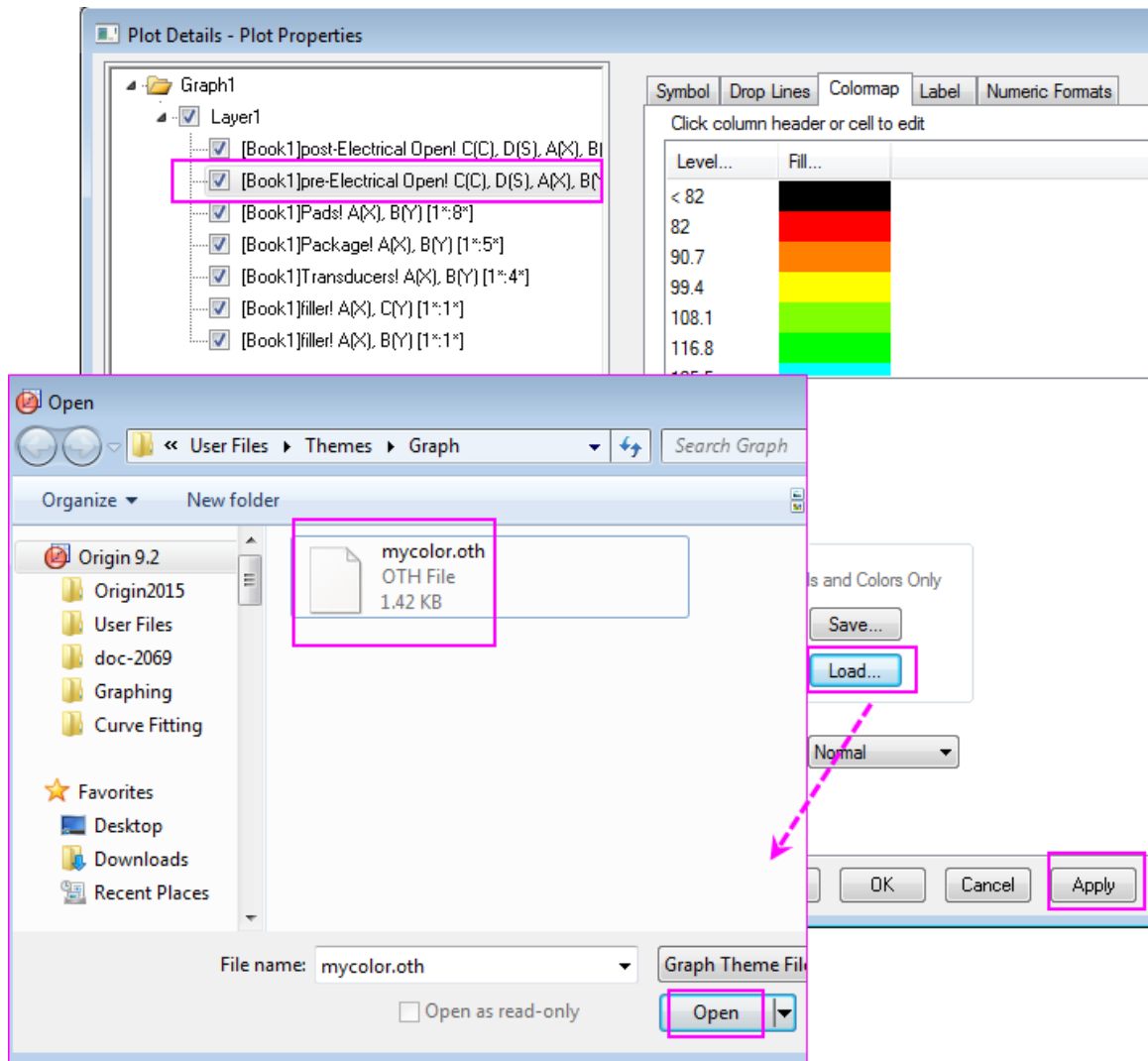

Click OK to close the window.

4. Click **Graph: Legend: Dataplot** in main menu, a legend will display in the graph. Right click the legend and click **Properties** in list, and edit the content in Object Properties dialog as follows graph, then click



OK.

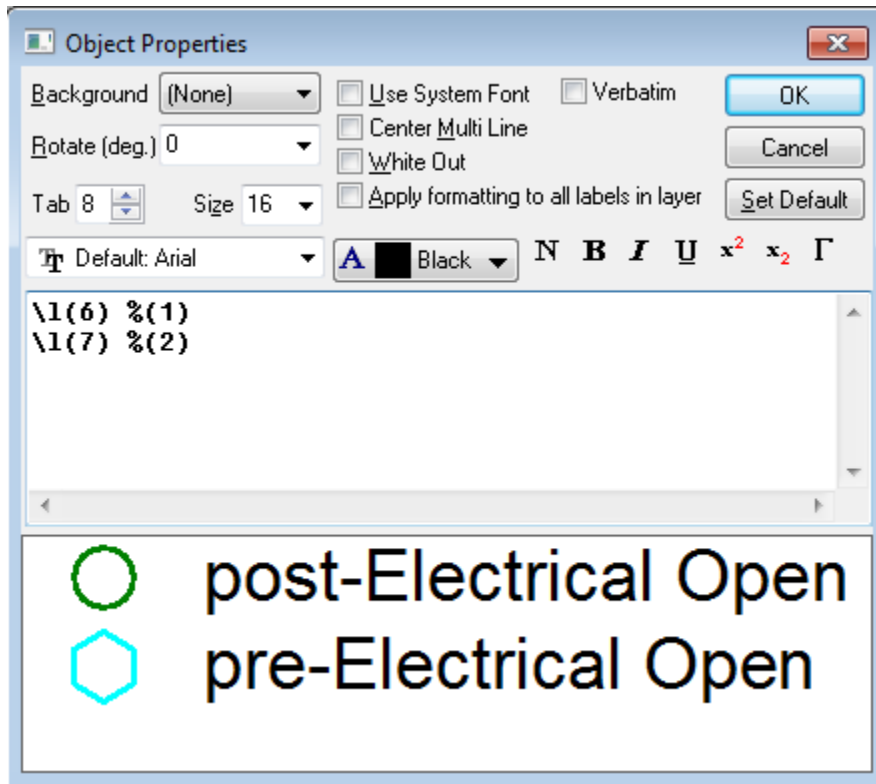

5. Click **Insert: Color Scale** in main menu, an Color Scale will display in the graph.

#### 6.7.11.5 More Customization Steps

1. Select **Format: Layer** in main menu to open the **Plot Details** dialog, go to the **Size/Speed** tab, edit the Layer Area as follows:

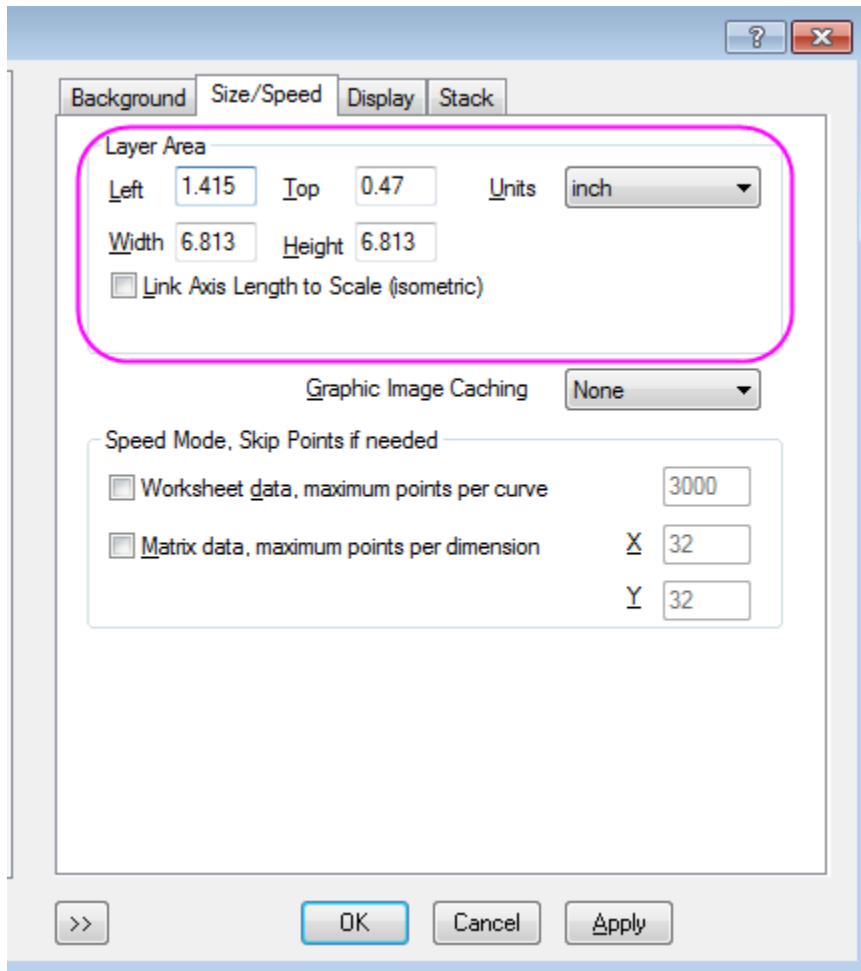

2. Go to the **Display** tab in **Plot Details** dialog, edit the **Clipping Margins(%)** to -2%, click OK to close dialog.

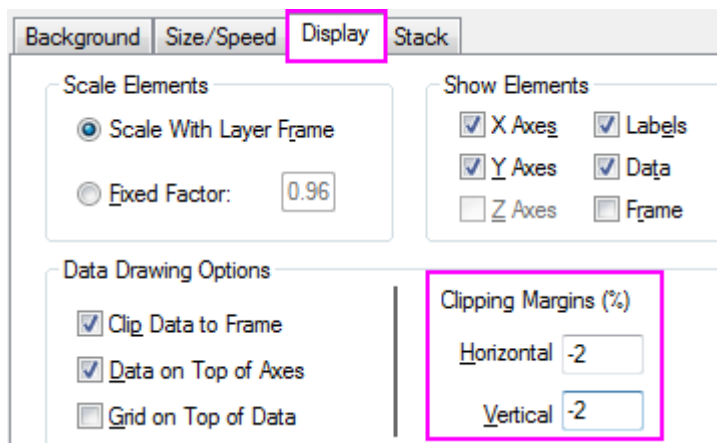

3. Copy the previous Legend and paste it on the graph, edit the new legend in this way:

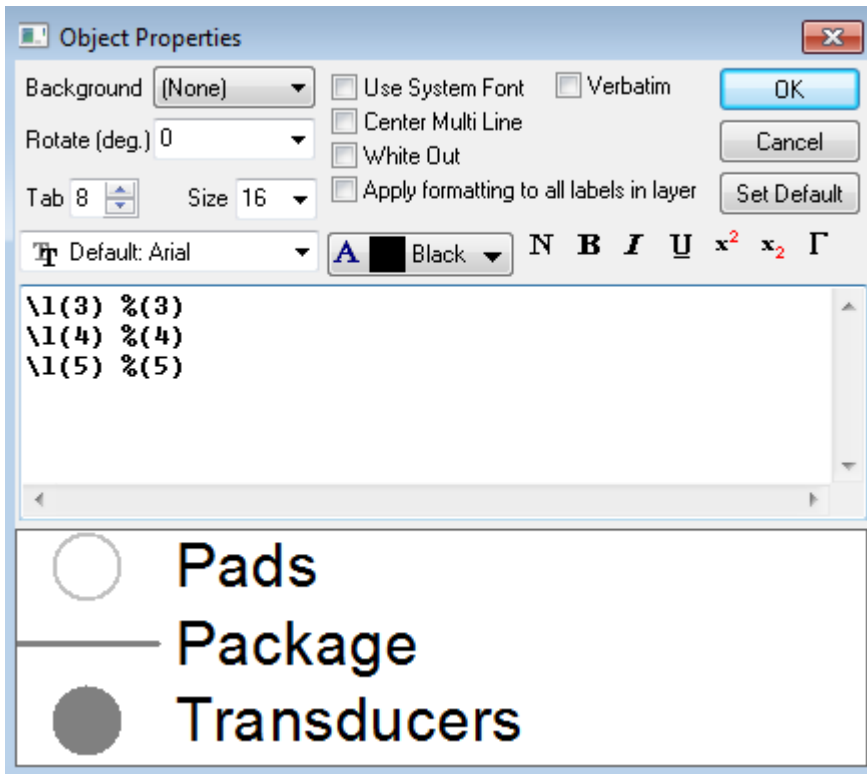

click OK to close dialog.

4. Double click the color scale to open the **Color Scale Control**, go to the **Levels** page, check on **Hide Head and Tail Levels**, then go to the **Labels** page and set the **Display** as graph below:

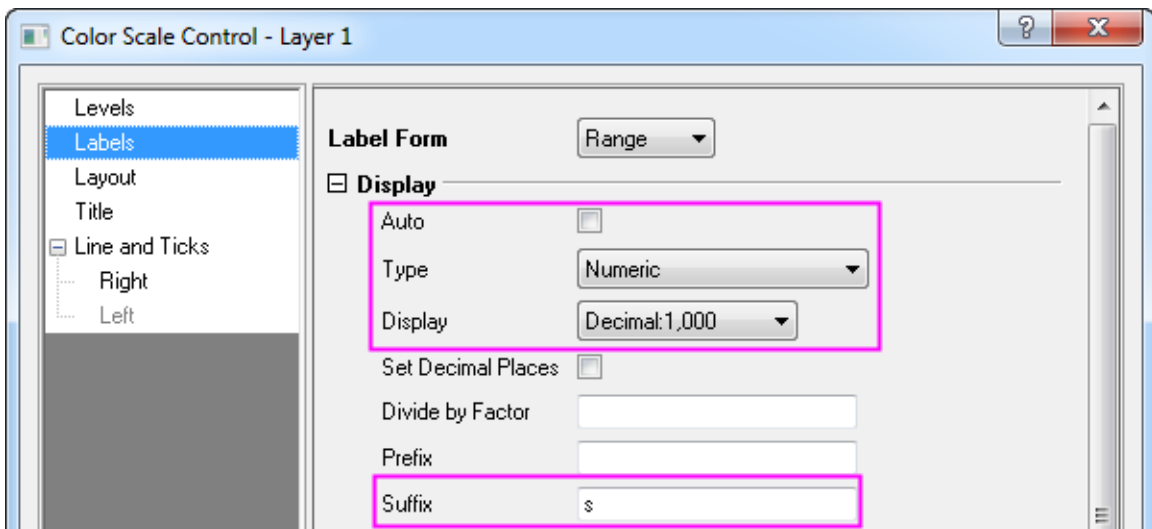

Add a title *Elapsed Time* for the color scale in **Title** tab, Click OK to apply.

5. Double click the axis to open the **Axis** dialog. Set Grids line for both Horizontal and Vertical in **Grids** tab in the same style as shown in graph below:

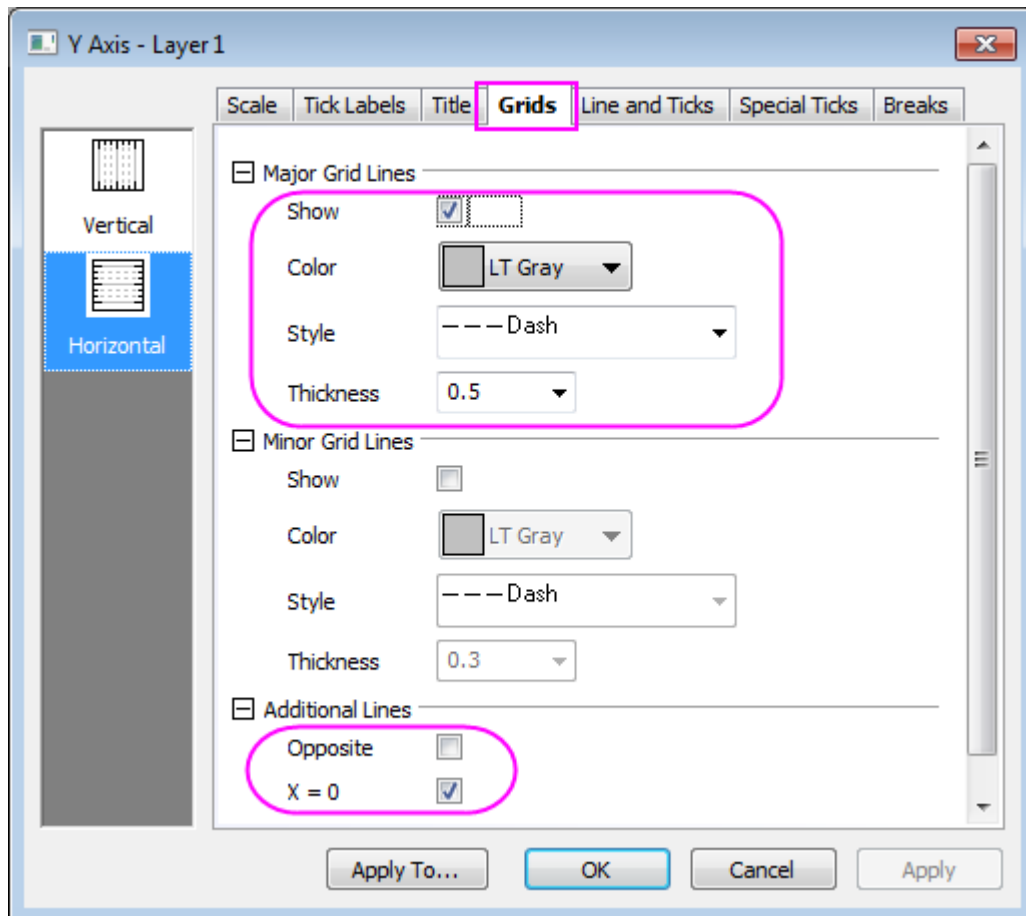

Click OK to apply the setting and close dialog.

- At last, add a Text "*symbol size is relative to event energy*" in the graph by using **Text Tool**  in **Tools** box.

## 6.8 Column, Bar and Pie

### 6.8.1 Column, Bar and Pie

- [2D Pie Chart of a Population Study](#)
- [Bar Graph of African Population](#)
- [Bar and Scatter Plot with Error Bar](#)
- [Column Graph with Error Bars](#)
- [Stack Column With Labels](#)
- [Clustered-Stacked Column Chart](#)
- [Grouped Column with Error Bars and Data Labels](#)
- [Grouped Stacked Column](#)
- [Stack Column Plot with Different Positive and Negative Y Scale](#)
- [Variable Column Width](#)

- [Stack Column and Bar Charts of Rechargeable Battery Statistics](#)

## 6.8.2 2D Pie Chart of a Population Study

### 6.8.2.1 Summary

This tutorial will show you how to create and customize a **2D Pie** chart.

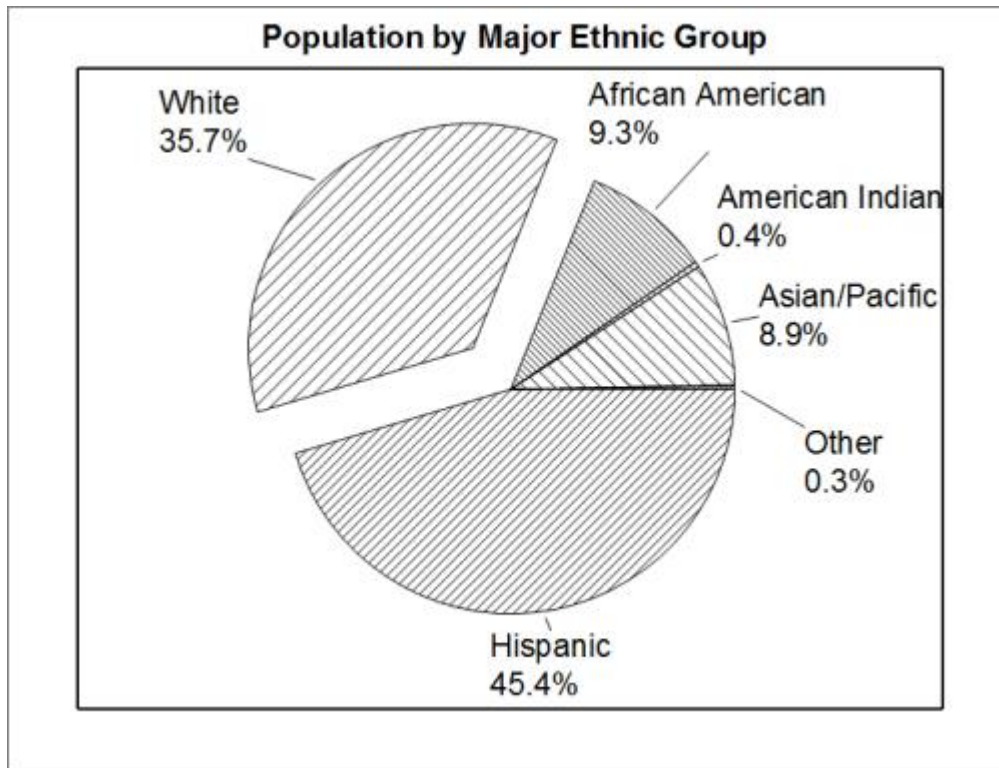

Minimum Origin Version Required: Origin 2018 SR0

### 6.8.2.2 What will you learn

This tutorial will show you how to

- Create a 2D Pie chart
- Customize the Pie chart

### 6.8.2.3 Steps

1. Create a new worksheet paste the sample data [shown here](#).

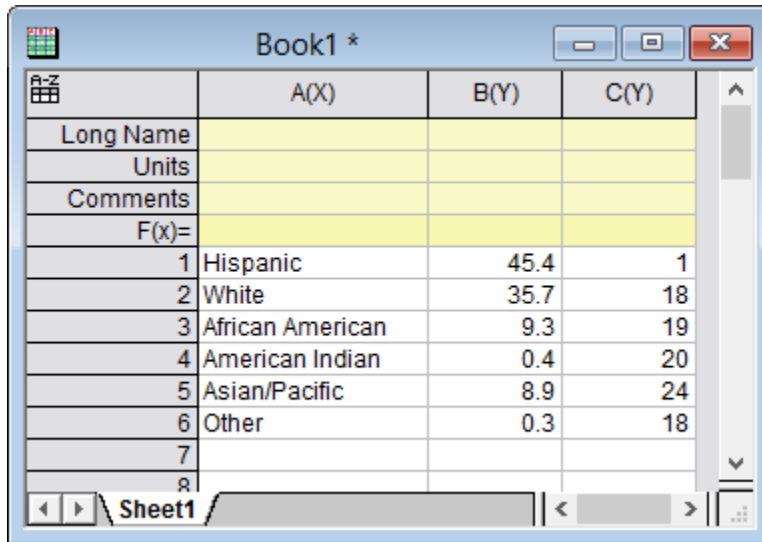

	A(X)	B(Y)	C(Y)
Long Name			
Units			
Comments			
F(x)=			
1	Hispanic	45.4	1
2	White	35.7	18
3	African American	9.3	19
4	American Indian	0.4	20
5	Asian/Pacific	8.9	24
6	Other	0.3	18
7			
8			

2. Highlight column **B** and select the **2D B&W Pie Chart** button on the **2D Graphs** toolbar.

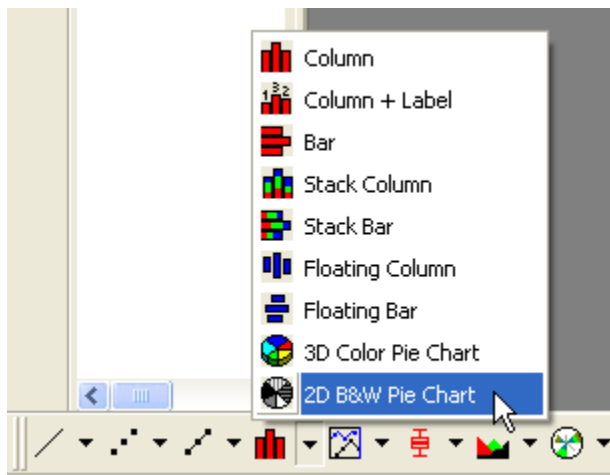

The graph should look like this:

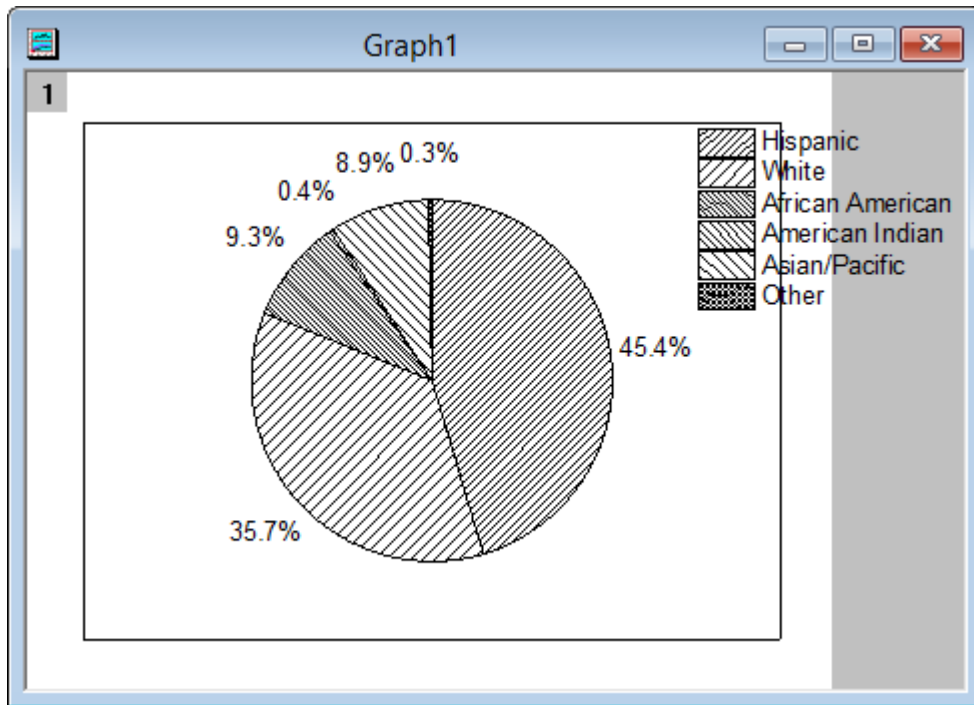

- Right click on the **Legend** and select **Delete** from the short-cut menu.
- Right-click on the graph and select **Plot Details** from the short-cut menu to open the **Plot Details** dialog. In the **Pie Geometry** tab, set the options as in the screenshot below.

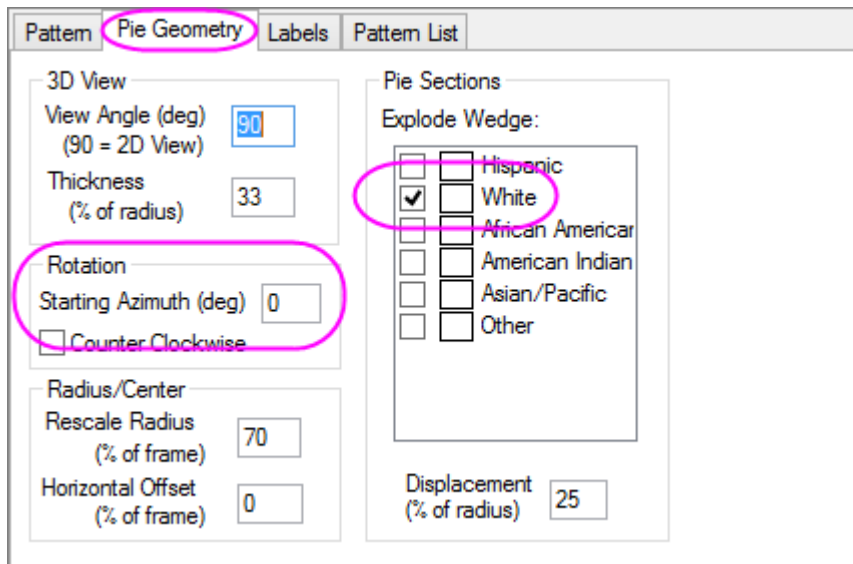

- In the **Labels** tab, set the options as in the screenshot below.

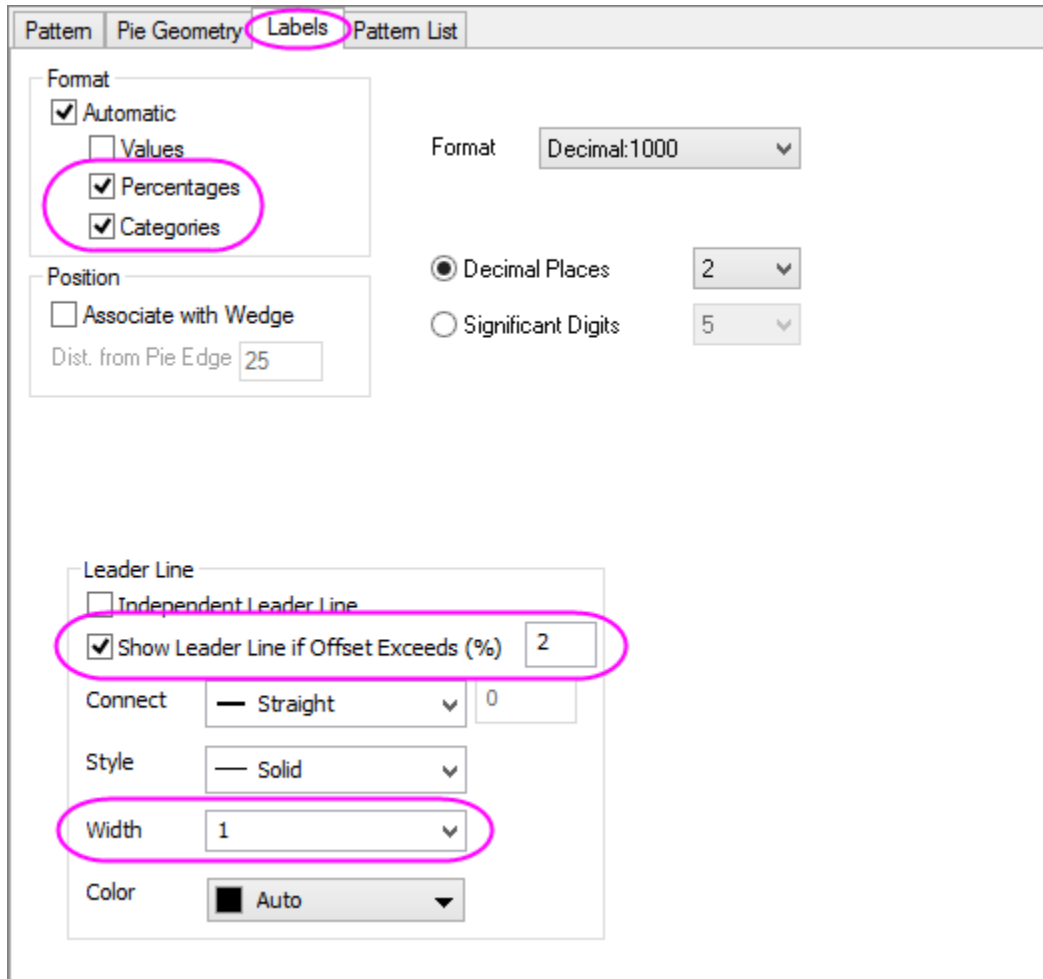

Click **OK** to close the **Plot Details** Dialog. Rearrange the text labels so that they do not crowd each other.

6. Select the **Text** button from the **Tools** toolbar. Then click near the top of the layer. Enter **Population by Major Ethnic Group** to add a title for the graph. Use the tools in the **Format** toolbar to customize the text, as needed. The graph should look something like this:



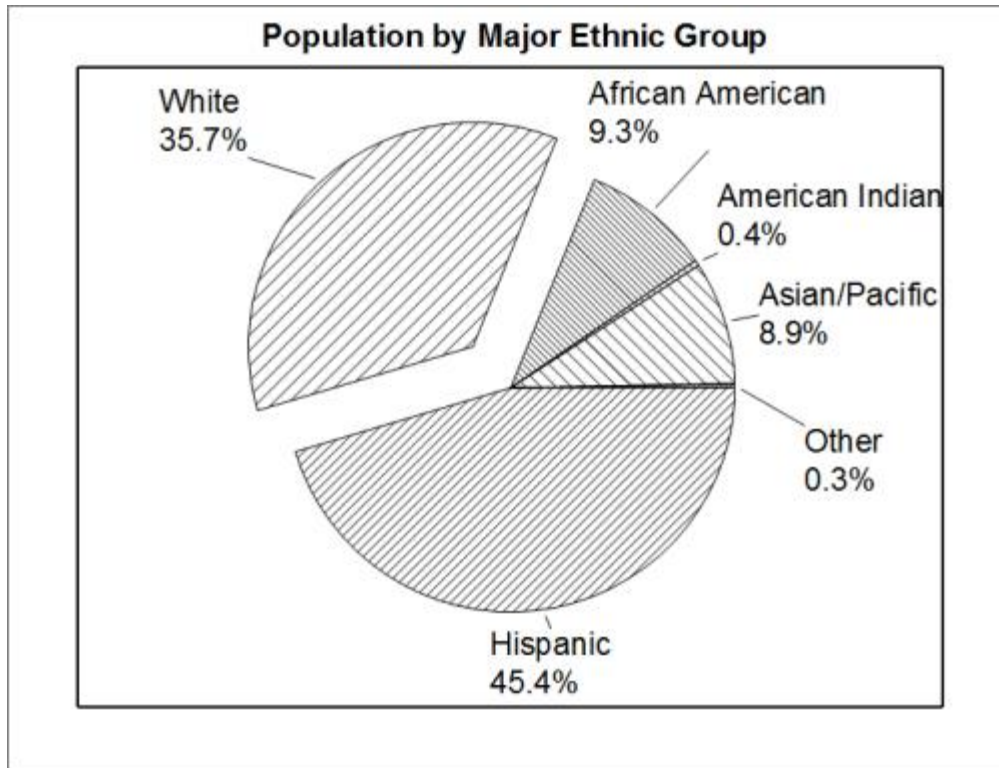

#### 6.8.2.4 Sample Data

Open a fresh worksheet and either click this link ([http://www.originlab.com/ftp/graph\\_gallery/data/2D\\_Pie\\_Chart.txt](http://www.originlab.com/ftp/graph_gallery/data/2D_Pie_Chart.txt)) and copy the data from your browser page; or select the data in the table below and copy.

Click on the empty data cell in row 1, column A(X) and paste the copied data.

A(X)	B(Y)	C(Y)
Hispanic	45.4	1
White	35.7	18
African American	9.3	19
American Indian	0.4	20
Asian/Pacific	8.9	24
Other	0.3	18

### 6.8.3 Bar Graph of African Population

#### 6.8.3.1 Summary

In this tutorial, we will create a graph to compare African population distributions for 2010 vs. predictions for 2050.

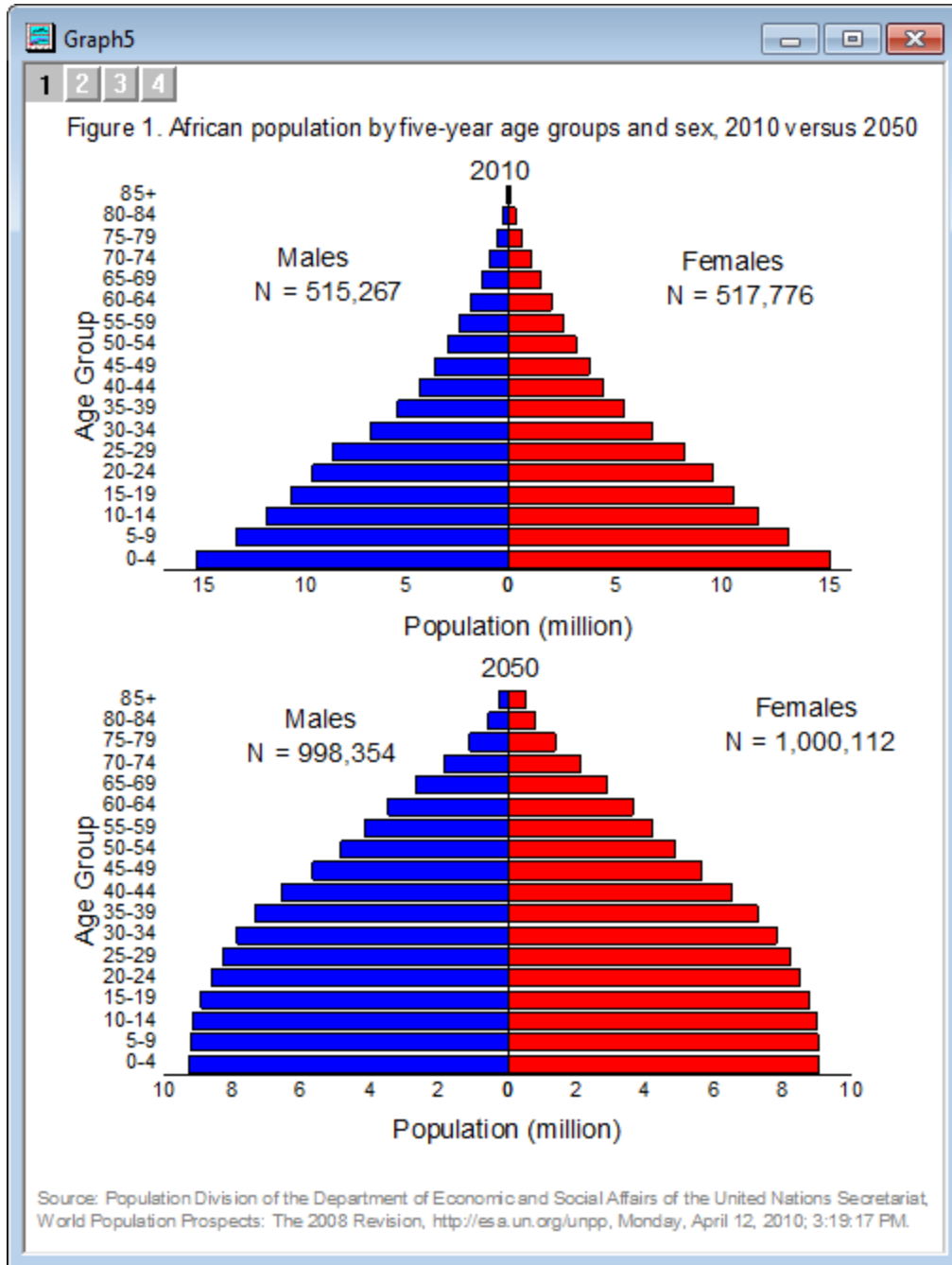

Minimum Origin Version Required: Origin 2015 SR0

#### 6.8.3.2 What you will learn

This tutorial will show you how to:

- Duplicate graph with data in other columns
- Set axis scale to reverse a bar chart
- Merge graphs

### 6.8.3.3 Steps

To create this graph, we must create four separate bar plots, customize them and merge them into one graph.

#### 6.8.3.3.1 Prepare Source Bar Plots with Batch Plotting

1. Start with an empty Origin workbook, import the data file **African\_Population.dat** under <Origin EXE Folder>\Samples\Graphing path. (Or if you do not have the file in your Origin installation, download the zipped data file from [ftp](#).)

	A(X)	B(Y)	C(Y)	D(Y)	E(Y)
Long Name	Age Group	Population	Population	Population	Population
Units		million	million	million	million
Comments		male-2010	female-2010	male-2050	female-2050
F(x)=					
Sparklines					
1	0-4	15.4267	15.0117	9.27	9.02679
2	5-9	13.4204	13.08944	9.238	9.02129
3	10-14	11.92	11.64616	9.15	8.9538
4	15-19	10.736	10.52617	8.93	8.76722
5	20-24	9.646	9.5354	8.61	8.50235
6	25-29	8.6265	8.21996	8.266	8.19188
7	30-34	6.82	6.76084	7.877	7.79863
8	35-39	5.45	5.41933	7.345	7.25389
9	40-44	4.388	4.45714	6.598	6.50407
10	45-49	3.62	3.77074	5.69	5.62547
11	50-54	2.98	3.17473	4.852	4.84986
12	55-59	2.386	2.58509	4.15	4.21943
13	60-64	1.835	2.0281	3.49	3.62979
14	65-69	1.316	1.51224	2.68	2.88718
15	70-74	0.901	1.09101	1.86	2.09807
16	75-79	0.535	0.67829	1.12	1.37265
17	80-84	0.246	0.34107	0.56	0.79171
18	85+	0.09	0.15258	0.27	0.50594
19					
20					
21					

- Highlight column B and select **Plot >Basic 2D : Bar** to plot a bar graph. Use the **Fill Color** button  in the **Style** toolbar to change the fill color to Red.
- Now we are going to duplicate similar graphs from the other three columns. Right click on the graph window title bar and select **Duplicate (Batch Plotting)** from the context menu:

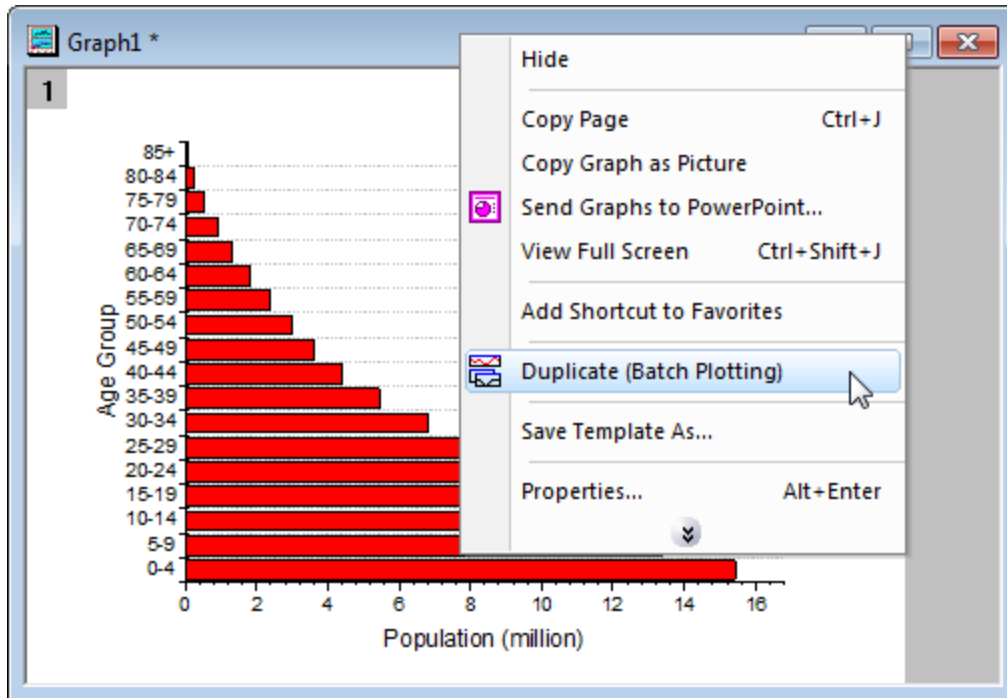

- In the dialog that opens, select **Column** from the **Batch Plot with** drop-down list, hold **Ctrl** key and click to select all three columns C, D, E and click **OK**:

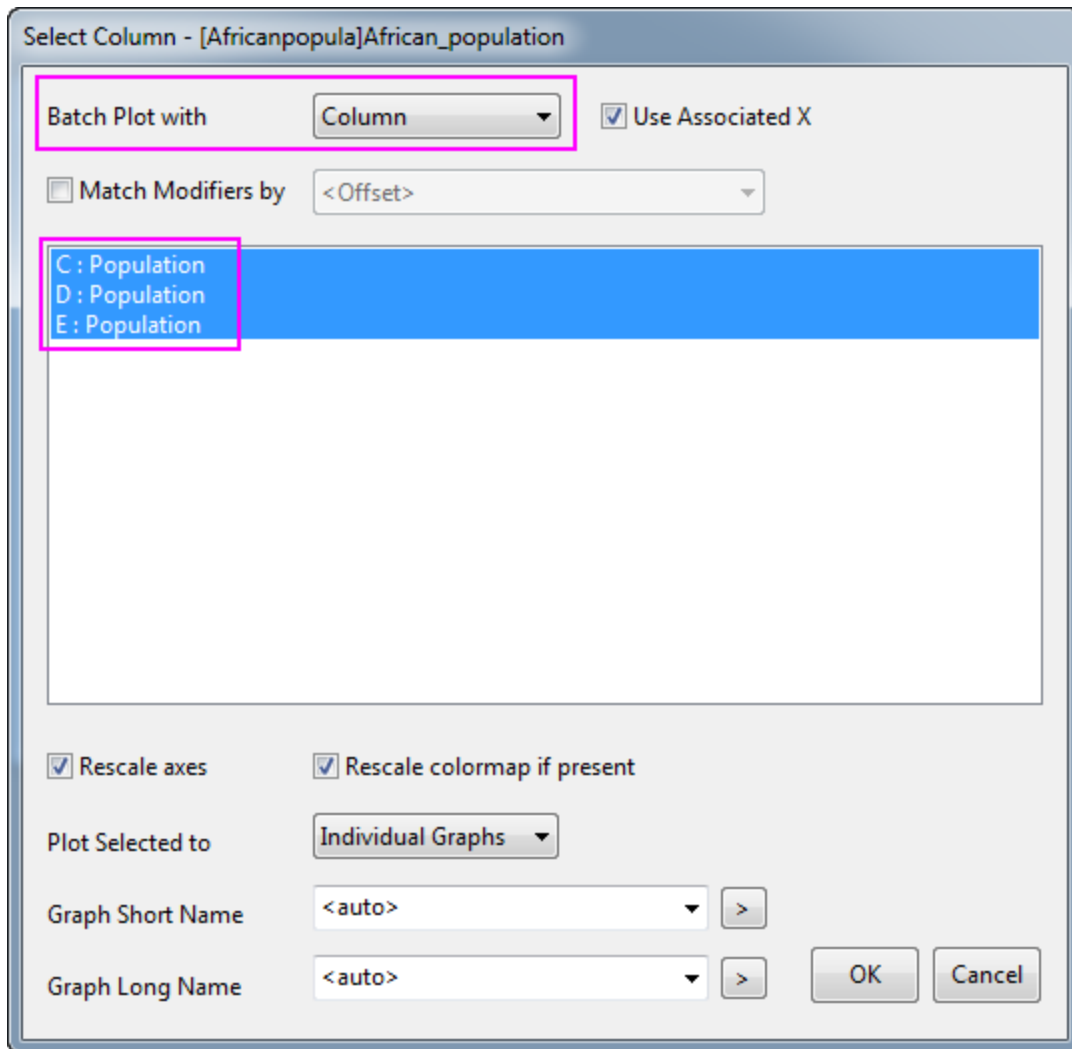

5. Three similar graphs will be created (When you get a **Reminder Message** asking *Would you like to rescale the axes to show all the data*, select **Yes** and click **OK**).
6. We now have four bar graphs of four groups: male-2010, female-2010, male-2050, female-2050.

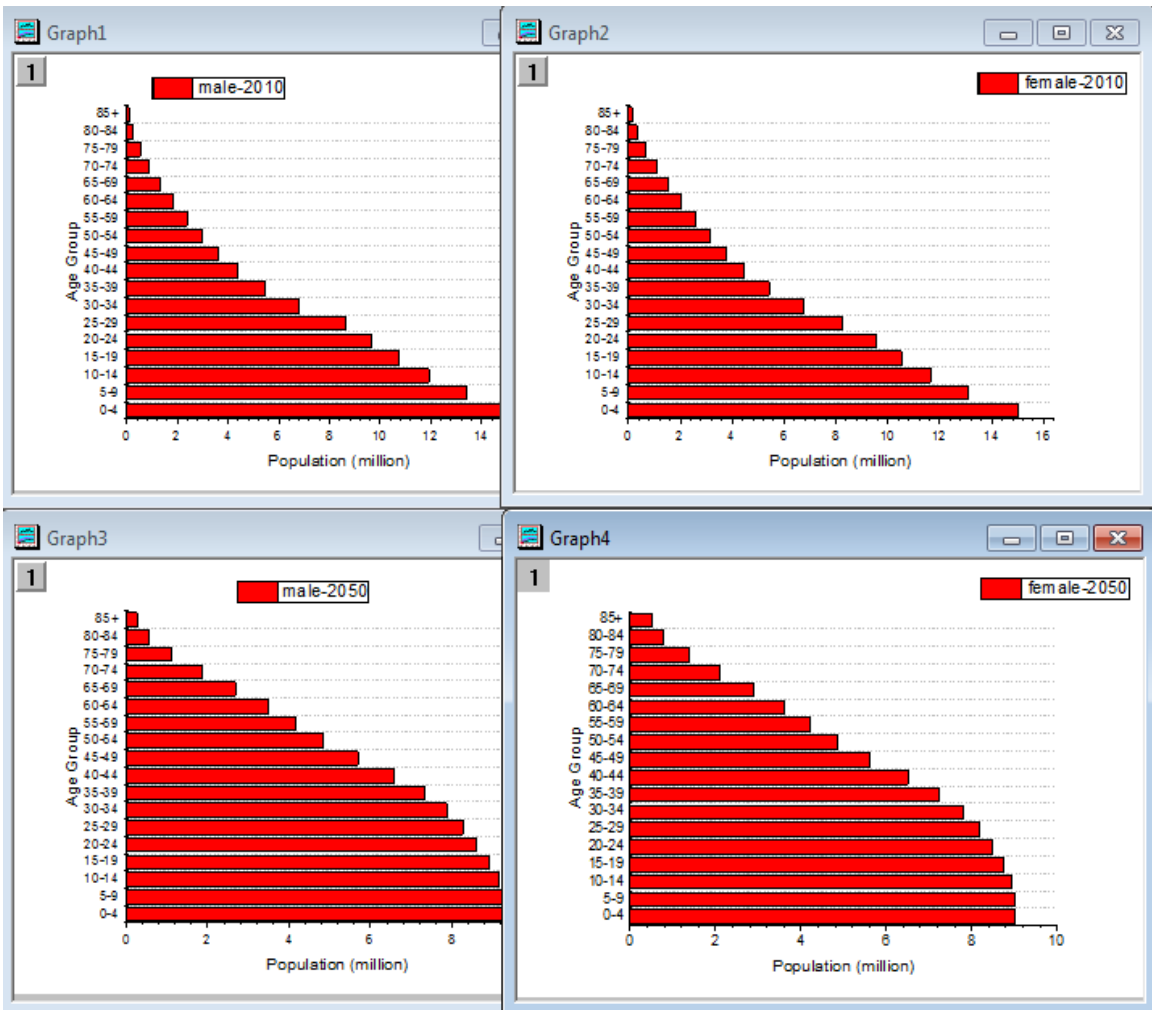

### 6.8.3.3.2 Customize Bar Plots

We will now individually customize the four bar plots.

1. First we will customize **Graph1** (i.e. the one with legend showing *male-2010*).
2. Double-click on the data plot to open the **Plot Details** dialog box. Expand **Layer1** node on the left panel and highlight its subnode, on the **Pattern** tab on right panel, change the **Color of Fill** to **Blue**. Click **OK** to apply the color setting and close the dialog.
3. Double click on the Y axis (the horizontal axis in bar plot) to open the **Axis** Dialog. On the **Scale** tab for **Y Axis**, set **From** = **17**, **To** = **0**, **Value** of major tick increment = **-5**:

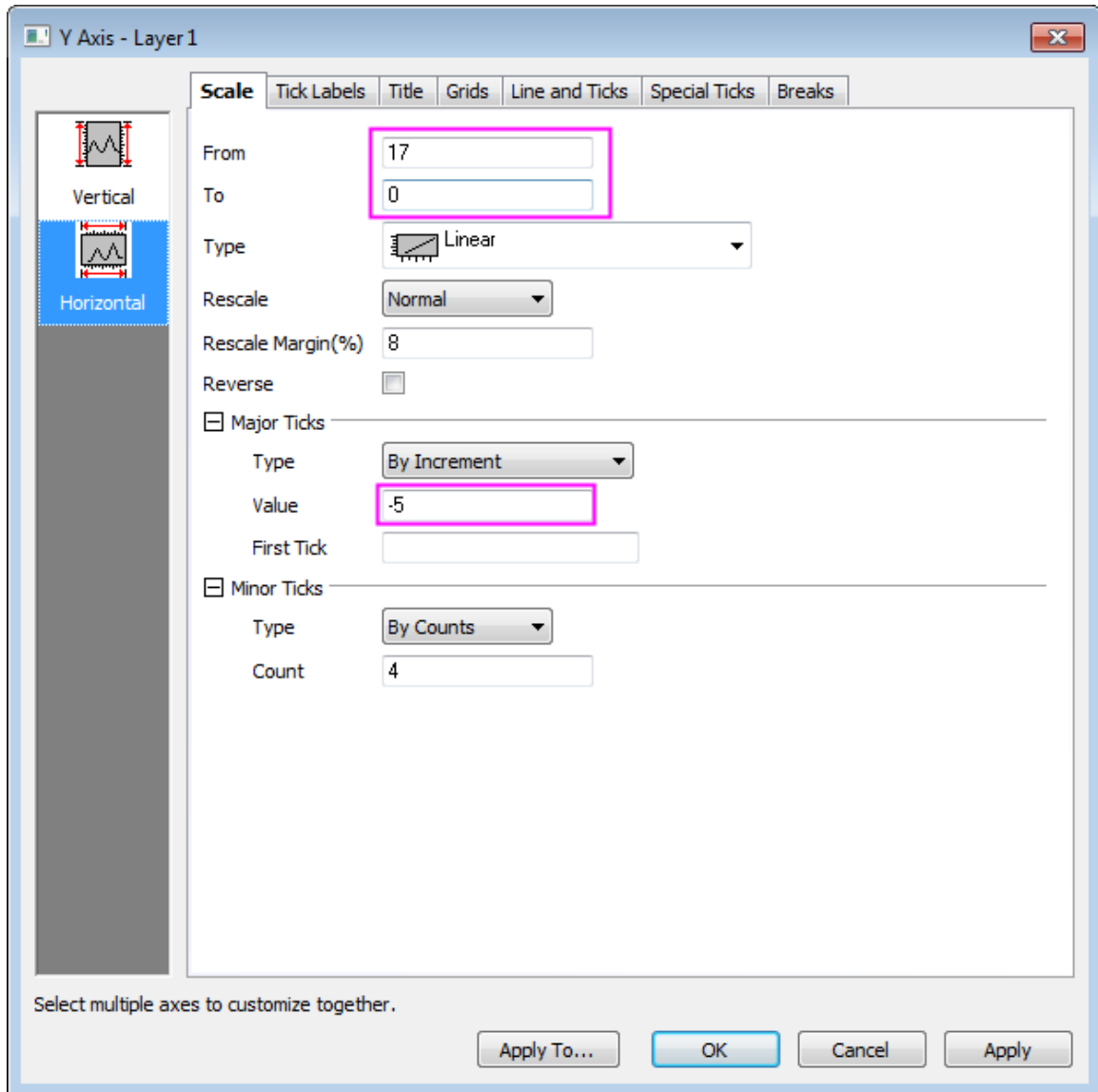

4. Click the **Vertical** icon on the left panel and go to **Grids** tab of X Axis and clear the **Show** check box under the **Minor Grid Lines** branch, to hide the minor grid lines. Click **Apply**:

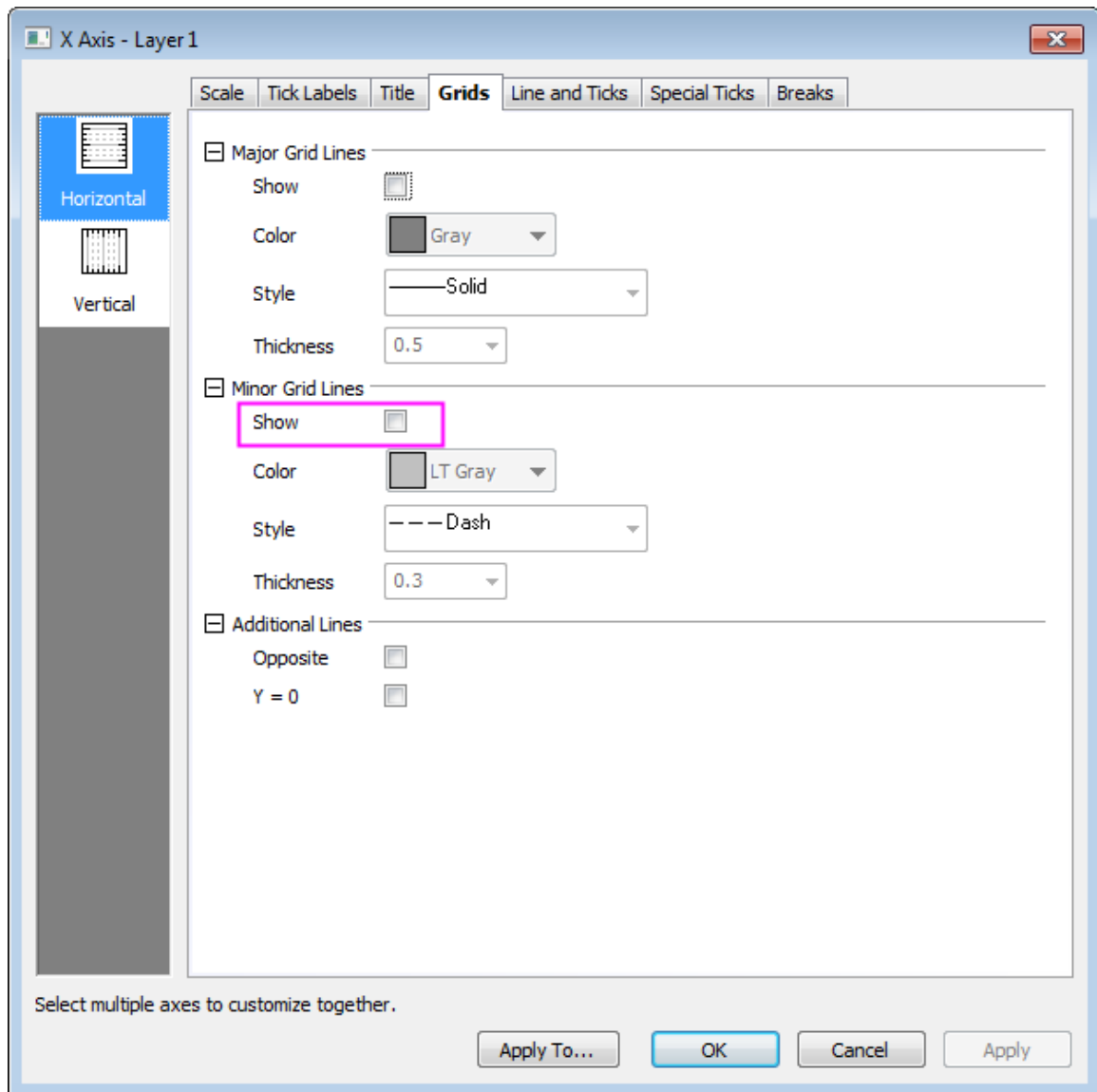

5. Go to the **Line and Ticks** tab and set **Style** under **Minor Ticks** to **None**:



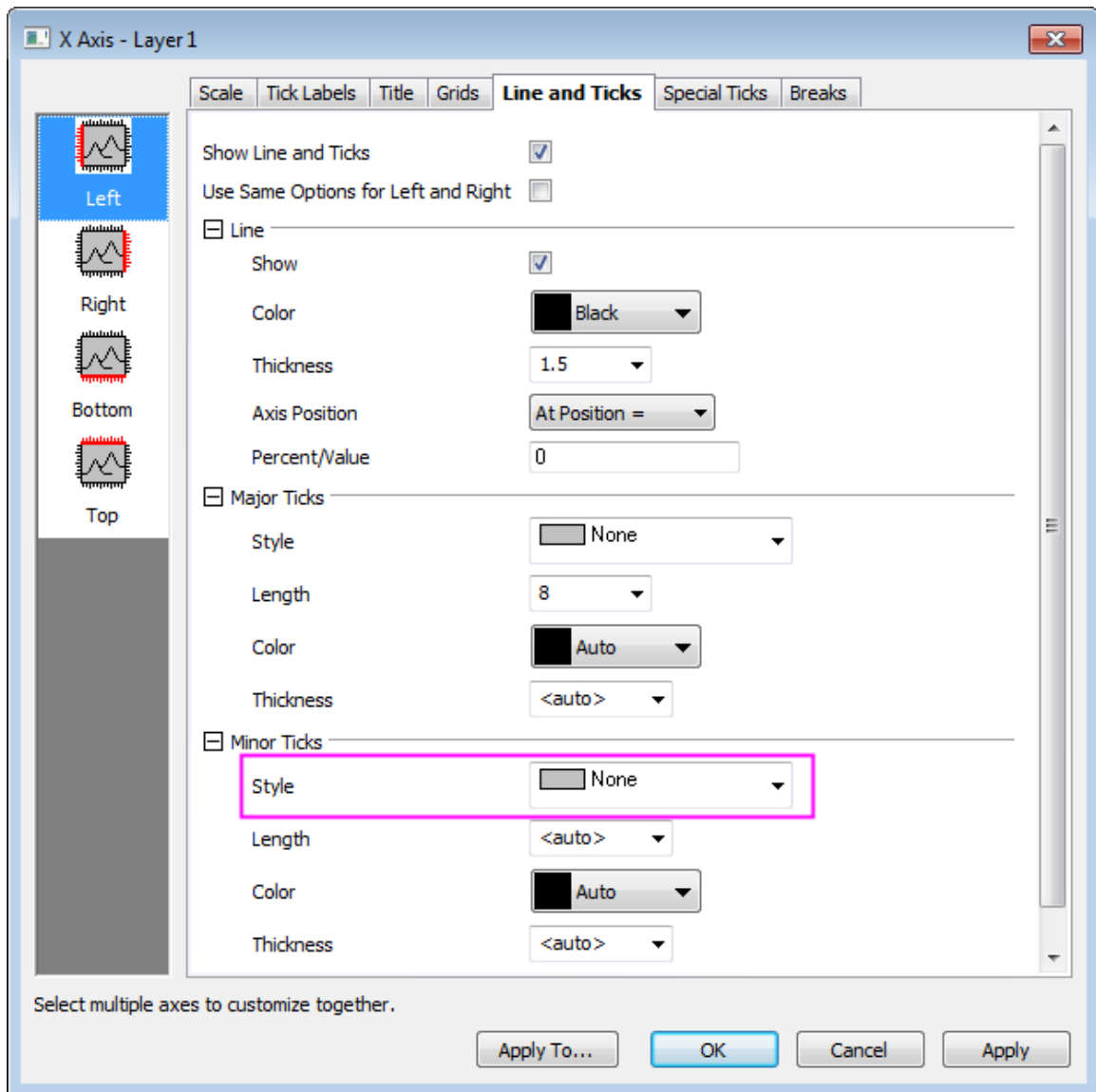

6. Now we will hide minor grid lines and minor ticks for all other graphs. Click the **Apply to...** button to bring up **Apply To** dialog and select the check box beside **Ticks** and **Grid Lines**. In the drop-down menus for both, select **All Windows in Folder** and click **OK** to apply settings. Now, minor grid lines and ticks in all graph windows in the same folder of **Project Explorer** will be hidden:

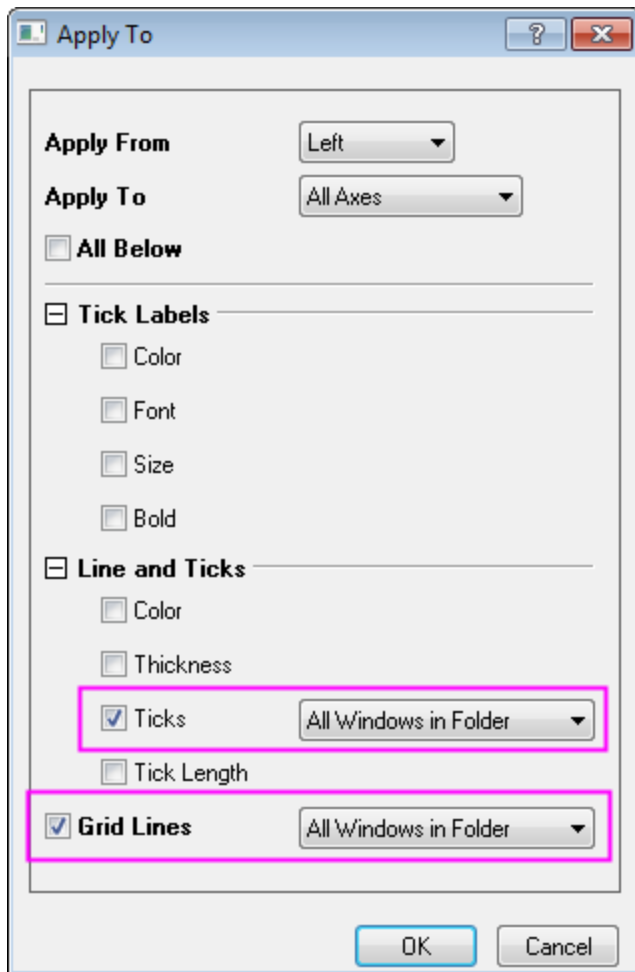

7. Next we will customize the Y axis scales for **Graph2**(female-2010) and **Graph3**(male-2050). Open the **Axis** Dialog for each graph and set the axis scales following the screenshots below:

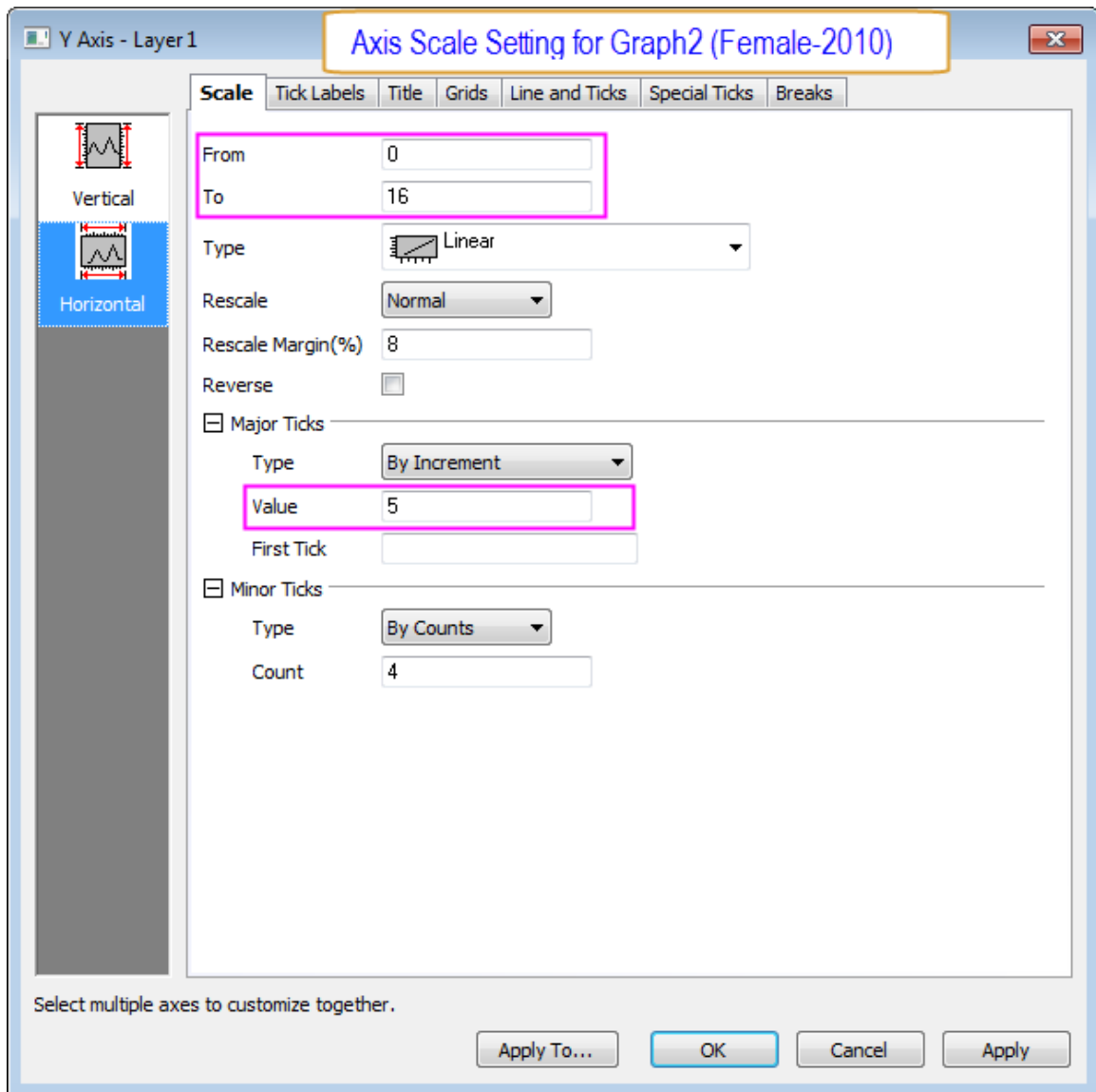

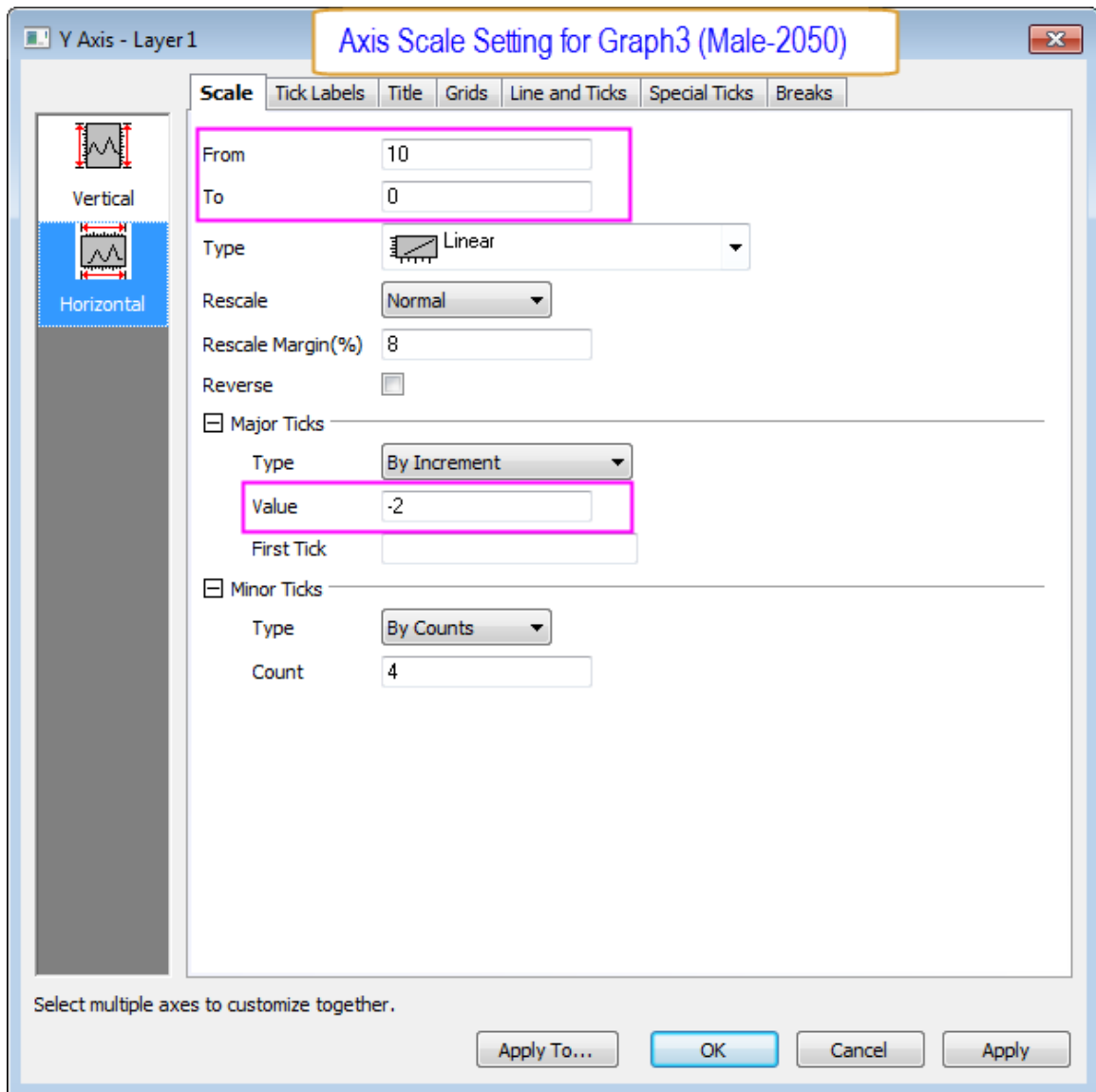

8. Double-click on X axis of **Graph4** to open the **Axis** dialog to set the X-axis scale following the screenshot below:

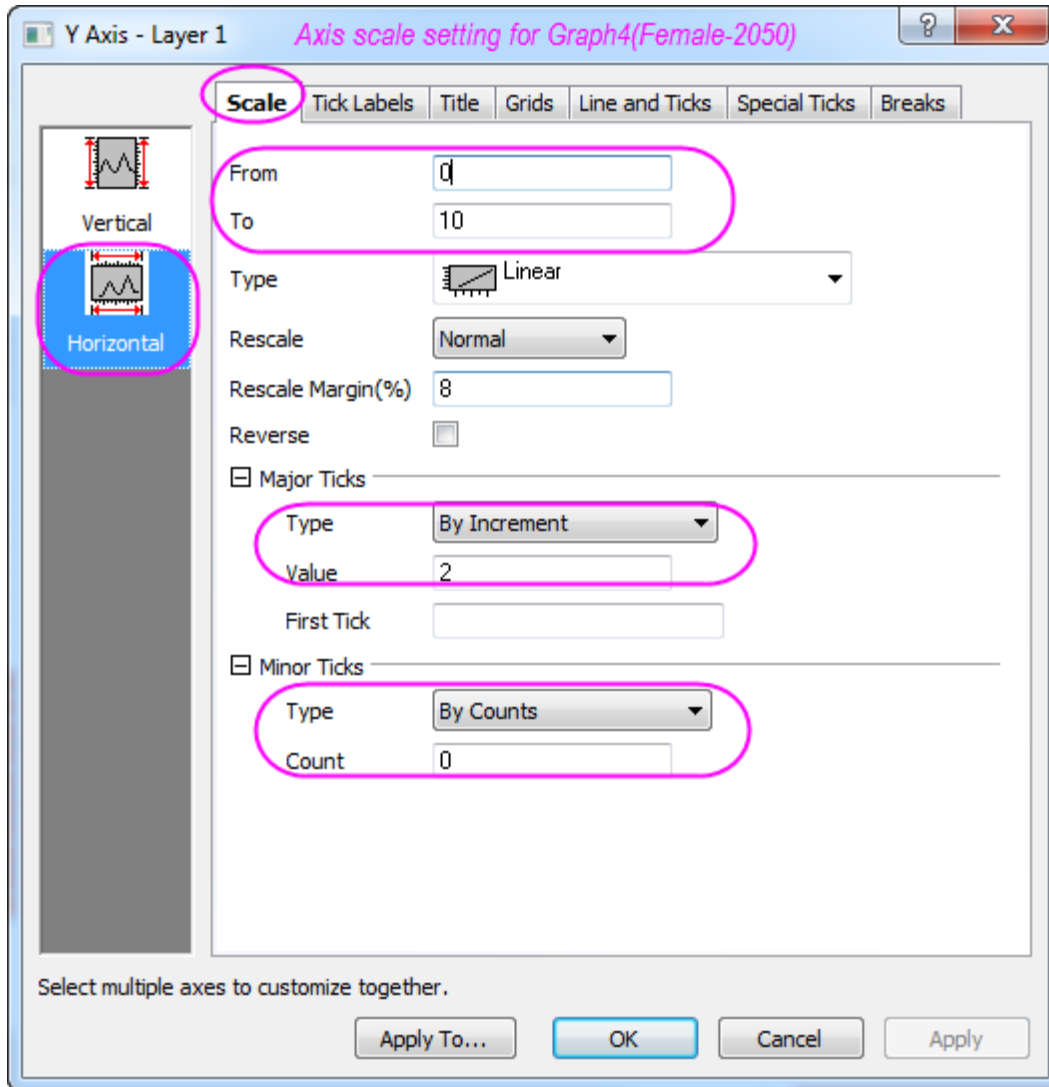

9. Double-click on the data plot of **Graph3** (male-2050) and open the **Plot Details** Dialog. Expand **Layer1** node to highlight its subnode, click the **Pattern** tab on right panel, set the **Color** for **Fill** to **Blue**.
10. For **Graph2**(female-2010) and **Graph4** (female-2050), select the tick label for X axis (vertical axis) and press the **Delete** key to remove them. Similarly, remove the axis titles for both X and Y axes. Now you should have four customized bar plots like those below:

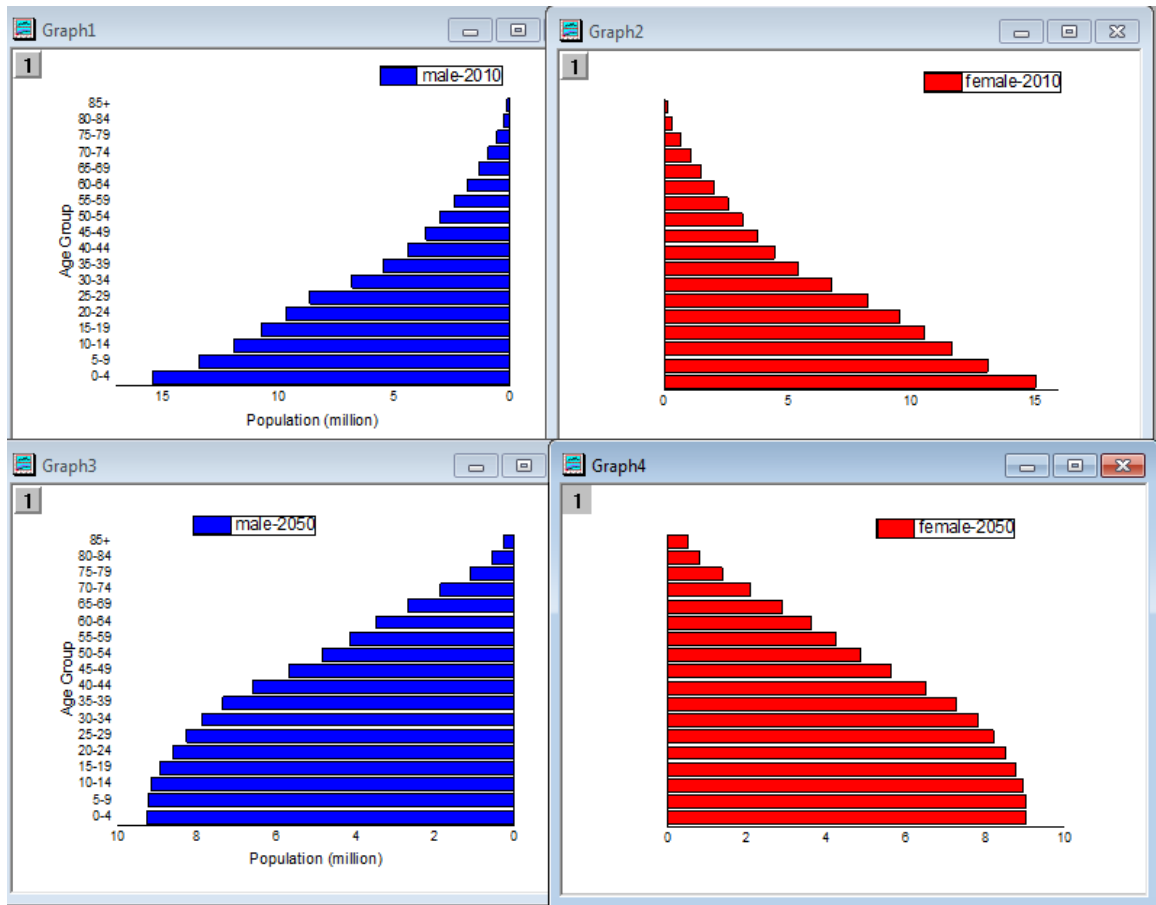

### 6.8.3.3 Merge Multiple Graphs

Now we have four distinct bar graphs. We will merge these four graphs and do some final customizations, such as adding text annotations.

1. Activate one of the four graph windows and select **Graph: Merge Graph Windows** from the main menu. This opens the **merge\_graph** dialog box. Edit the settings as follows and merge these four bar graphs into one graph window.

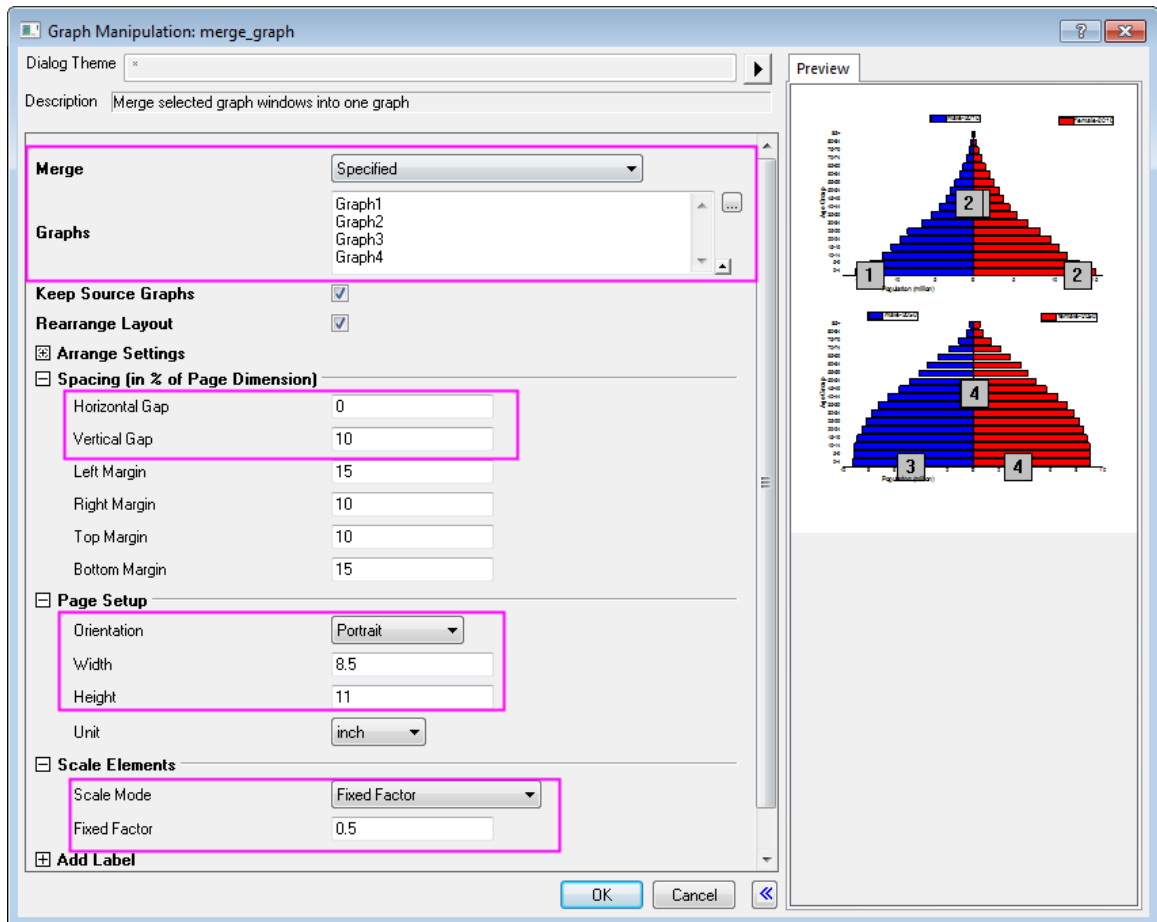

2. In the merged graph, drag the two Y (horizontal) axis titles "Population (million)" to center align them. Sequentially select and delete the four graph legends.
3. Right click on an open space in the graph layer and select "Add Text". Type to create the four text labels. The text labels used are:

- *Figure 1. African population by five – year age groups and sex, 2010 versus 2050*
- 2010
- Males  
*N=515,267*
- Females  
*N=517,776*
- 2050
- Males  
*N=998,354*
- Females  
*N=1,000,112*
- *Source: Population Division of the Department of Economic and Social Affairs of the United Nations Secretariat,*

World Population Prospects: The 2008 Revision, <http://www.un.org/en/index.html>, Monday, April 12, 2010; 3:19:17 PM.

You may further customize the position, text font, size, color and alignment of the newly added labels. Your final graph should look much like the the graph pictured below.

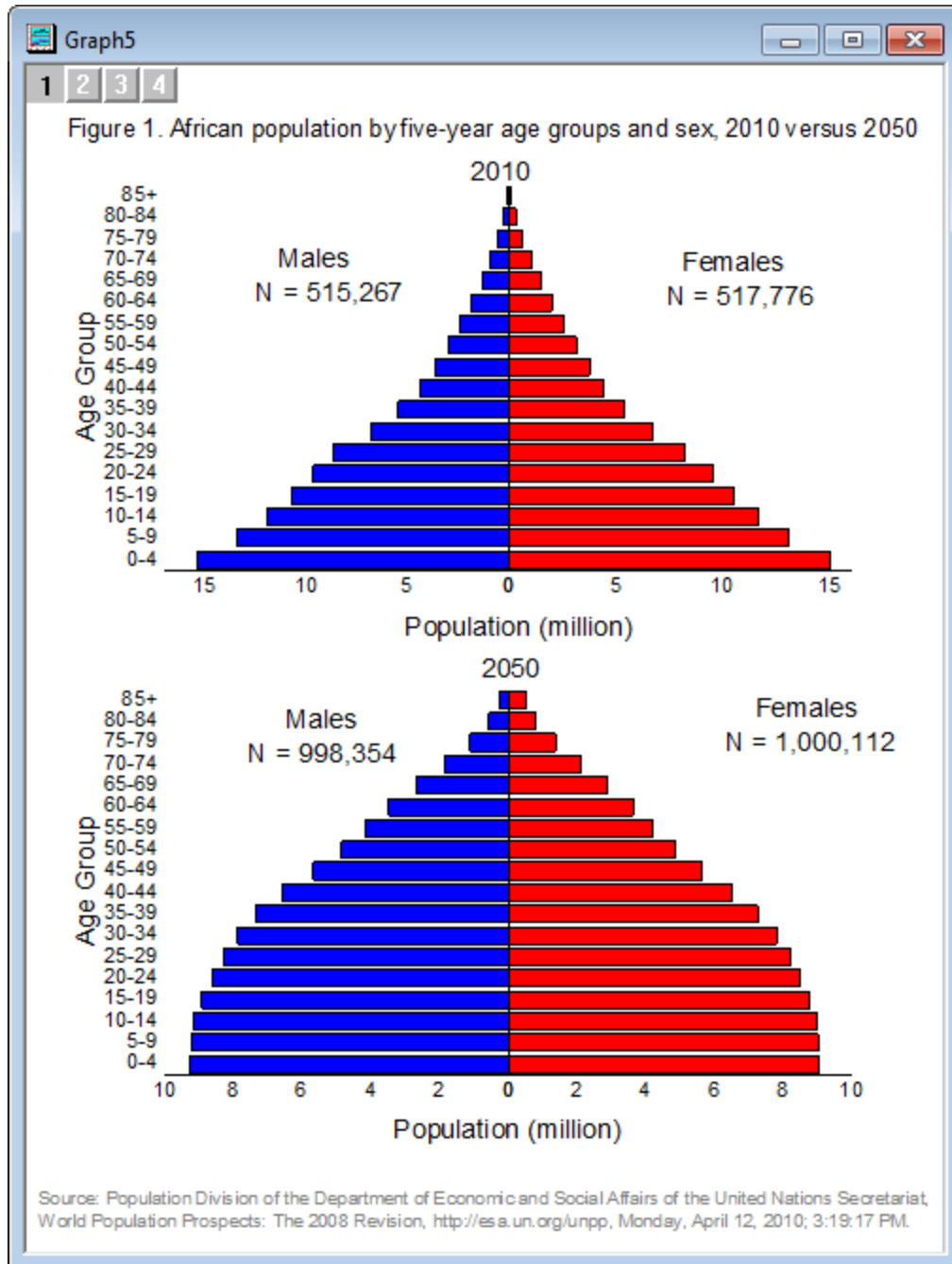

## 6.8.4 Bar and Scatter Plot with Error Bar

### 6.8.4.1 Summary



Below graph is made of bar chart and scatter plot.

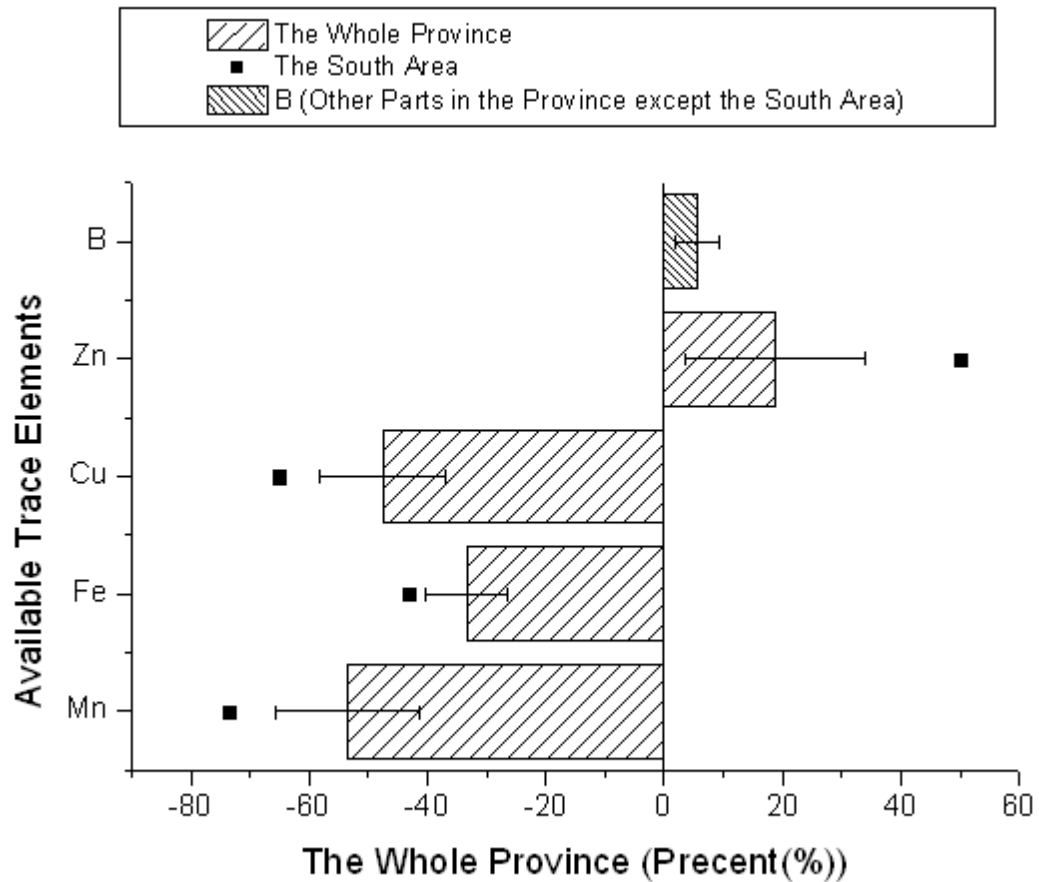

Minimum Origin Version Required: Origin 8.0 SR0

#### 6.8.4.2 What will you learn

- How to add a scatter plot to a bar graph
- How to set the Plus and Minus error bar

#### 6.8.4.3 Steps

This tutorial is associated with the Tutorial Data project: <Origin EXE Folder>\Samples\Tutorial Data.opj.

1. Open the Tutorial Data project and browse to folder *Bar Plot with Errors* in **Project Explorer**.
2. Activate the workbook **Book2N**, right-click the col(C) to select **Set as: Y Error** from the context menu.
3. Highlight Col(A), col(B) and col(C), select **Plot > Basic 2D : Column** from the main menu to plot a column graph with Y error bar.

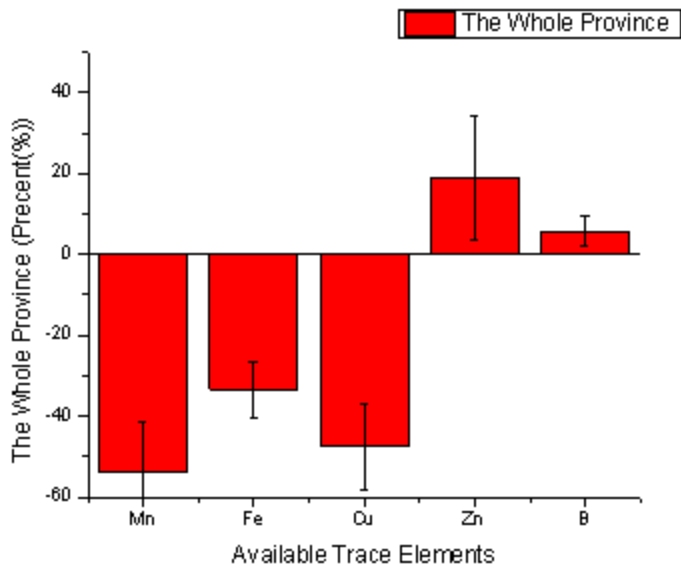

4. Activate the graph window, and then select **Graph: Exchange X-Y Axes**.

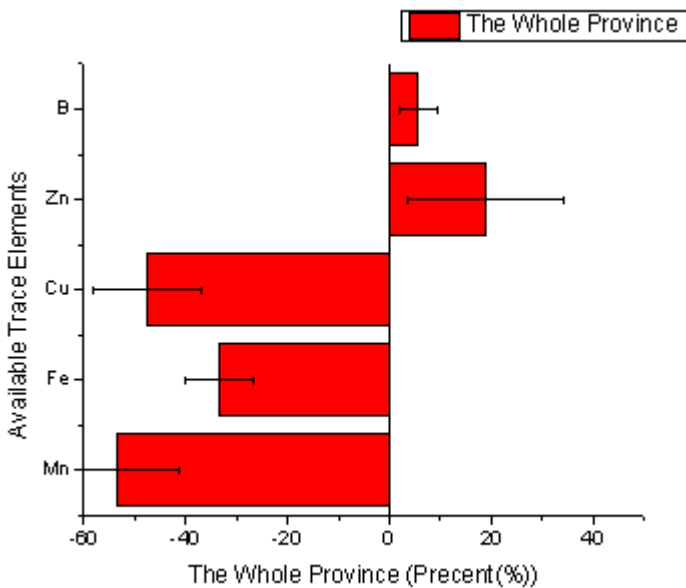

5. Highlight the col(D) in the worksheet and then activate the graph window again. Select **Insert: Plot to Layer: Scatter** from the main menu to add the col(D) as scatter to the column graph.

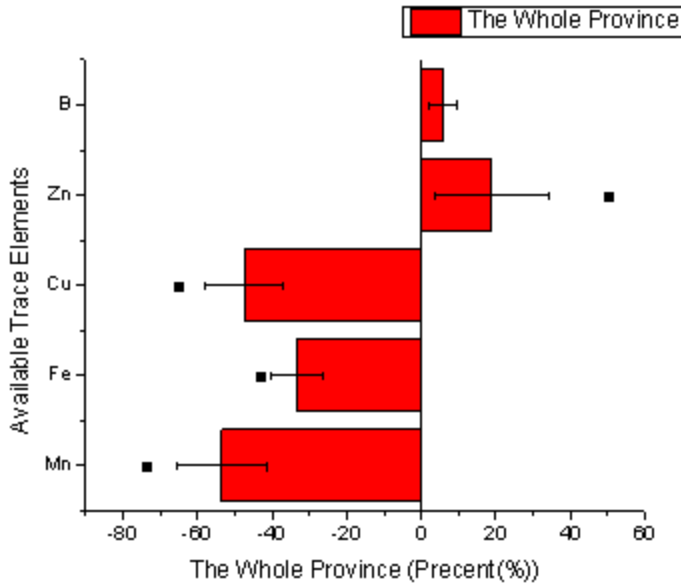

- Double-click the column graph to open the Plot Details dialog. Set the **Color** and **Pattern** options in the **Fill** group of **Pattern** Tab as below.

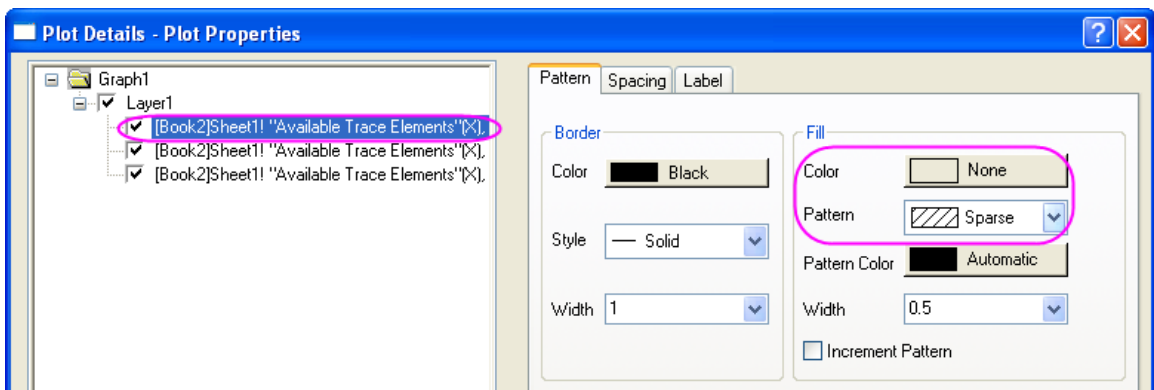

- Select the scatter plot in the left panel, then set the Symbol as below. Then click **OK** button to close the dialog.

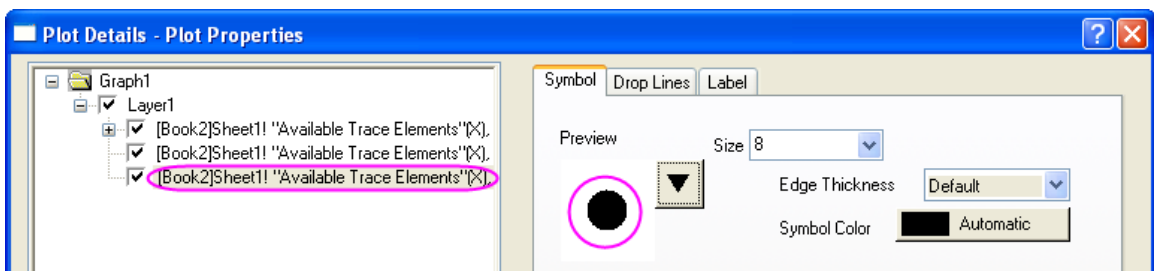

- Activate the graph window, hold the **Ctrl** key and select the first bar to set its pattern as **Dense** as below from the **Style** toolbar.

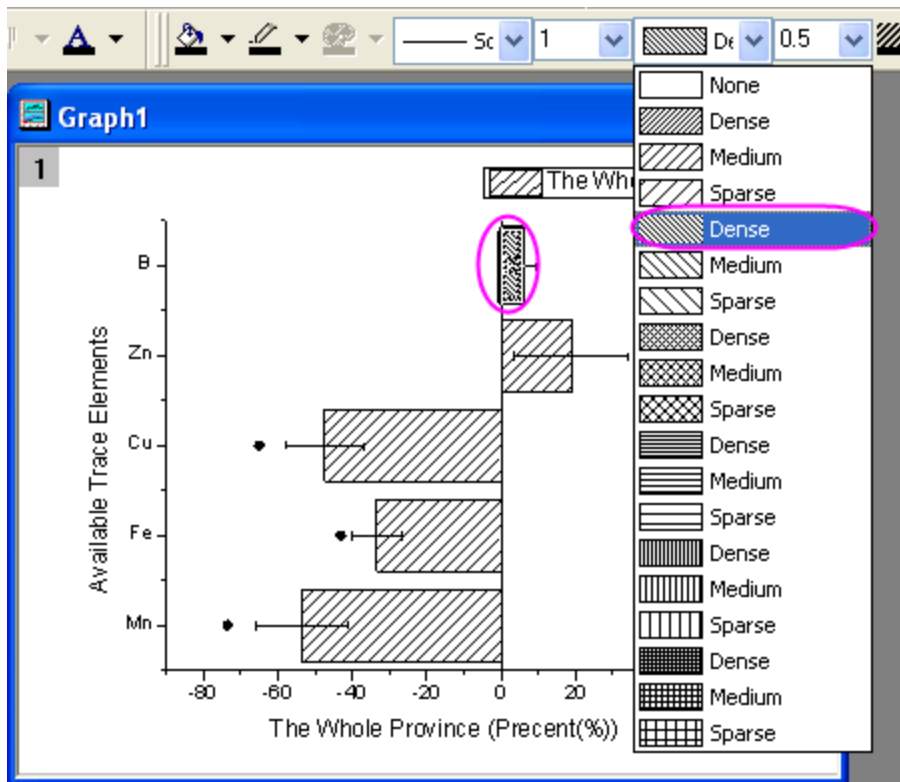

9. Select **Graph: Legend: Reconstruct Legend** from the main menu to update the legend for graph.
10. Right-click the legend to select **Properties** from the context menu to open the **Objects Properties** dialog. Set **Background** as **Black Line**. Then edit and move the legend as below.

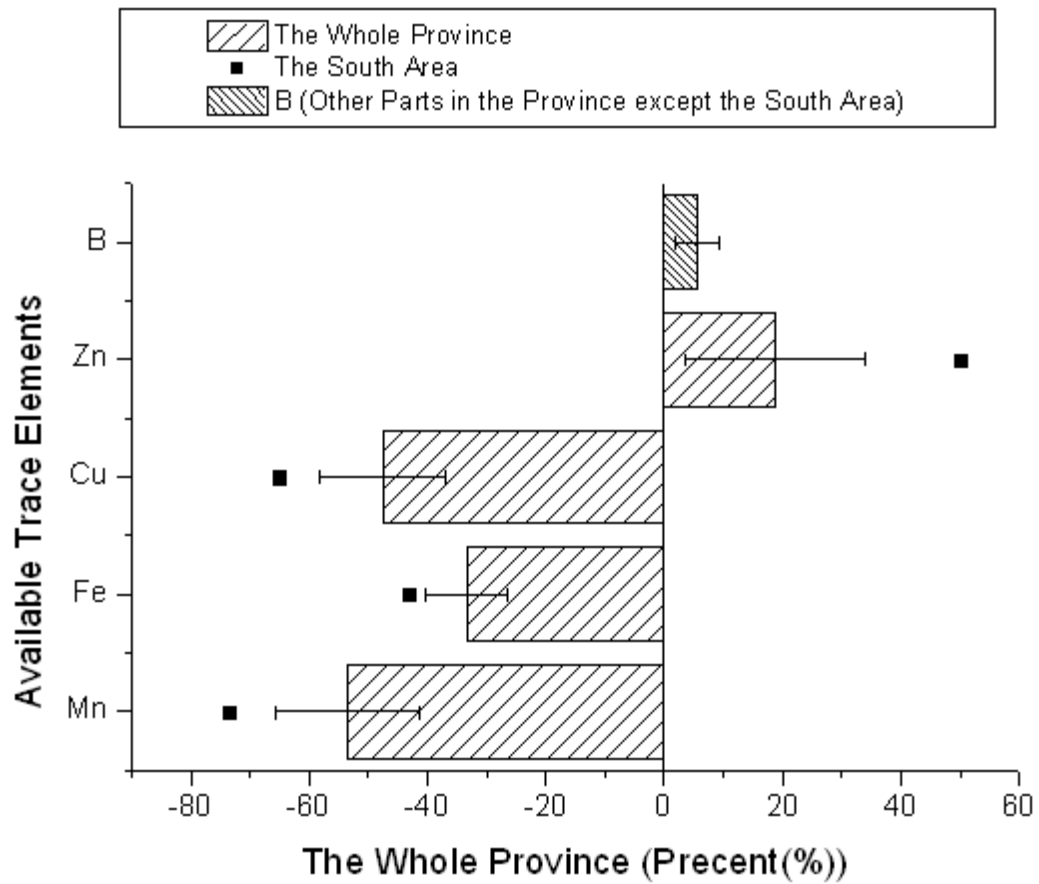

### 6.8.5 Column Graph with Error Bars

#### 6.8.5.1 Summary

This customized graph shows an example of a bar graph with added error bars. The same Y data is plotted twice, once as a scatter plot and again as a column plot. The error bars are attached to the scatter plot in this case. Error bars can be included in the graph in both the Y and X dimensions.

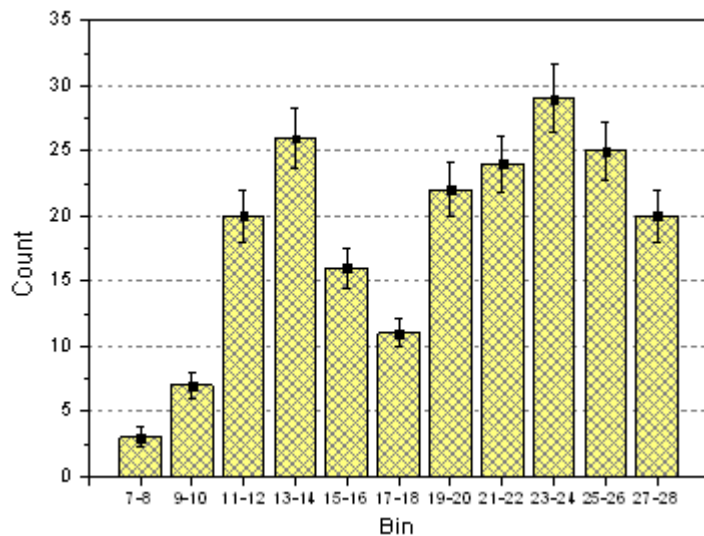

Minimum Origin Version Required: 2015 SR0

#### 6.8.5.2 What you will learn

- Create and customize a column graph
- Use the Plot Setup dialog to add a new data plot to your graph



#### 6.8.5.3 Steps

This tutorial is associated with <Origin EXE Folder>\Samples\Tutorial Data.opj. (If you don't have the Project file, please download the data file from [here](#))

1. Open the **Tutorial Data.opj** and browse to the folder *Column Graph with Error Bars*. Activate the worksheet and make sure the column plot designations are set as **X**, **Y**, **Y Error** and **Label** accordingly.
2. Highlight column 2 and select **Plot > Basic 2D : Column** to create a column graph.
3. With the graph window active, select **Graph: Plot Setup...** to bring up the **Plot Setup** dialog box. Click the up-sided double triangle arrow icon to expand top two panels and we will add the scatter data and

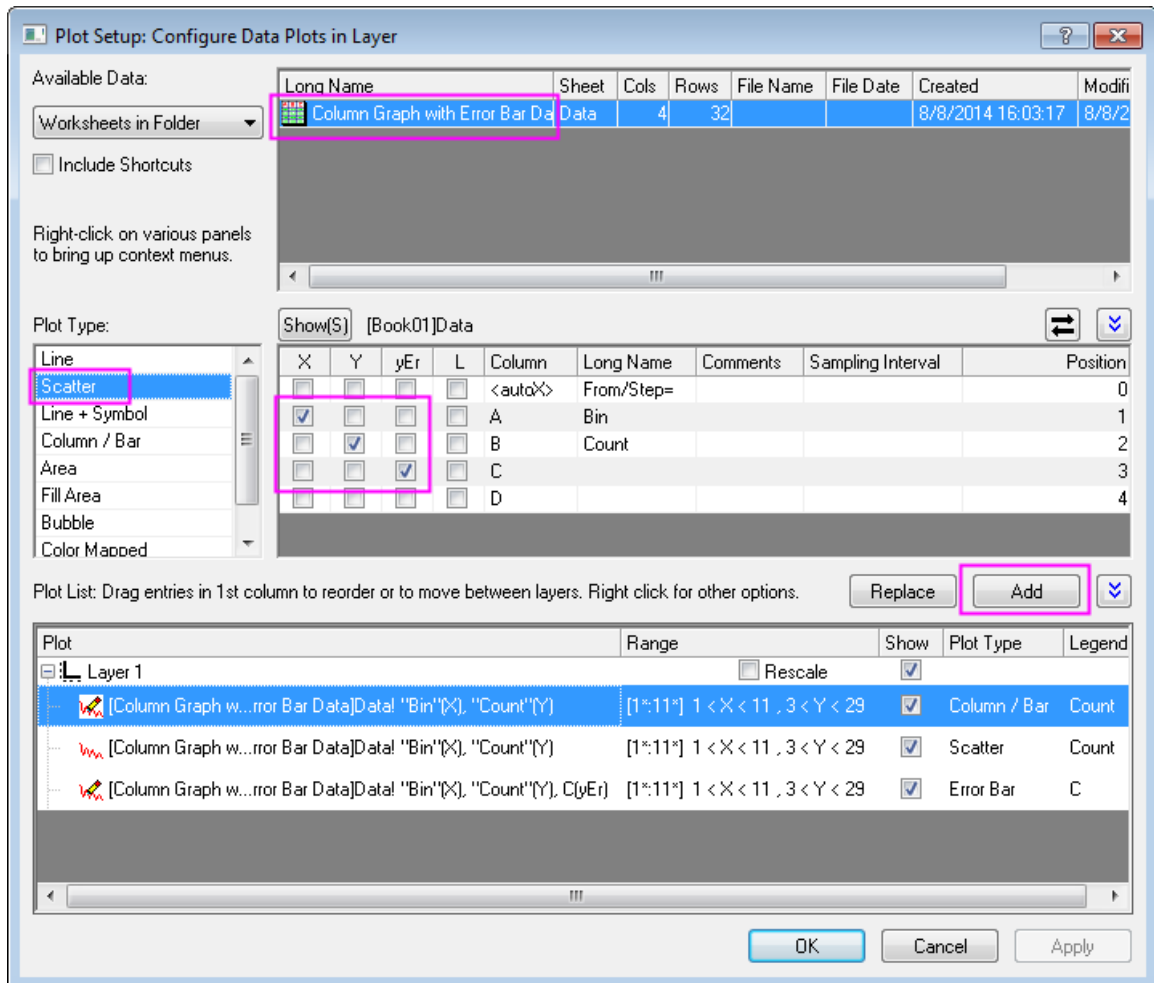
error bars from this dialog box, as shown below:



In order to show all three panels in **Plot Setup** dialog, please expand **Plot Type** panel by clicking  and expand **Available Data** panel by clicking  again.

Please refer to [Plotting using Plot Setup](#) for more information.

- Click the **Add** button to add scatter data to the column plot. Then click **OK** to go back to column graph window.
- Double-click the columns to bring up the **Plot Details** dialog box. Customize the graph using settings on the **Pattern** tab as shown below:

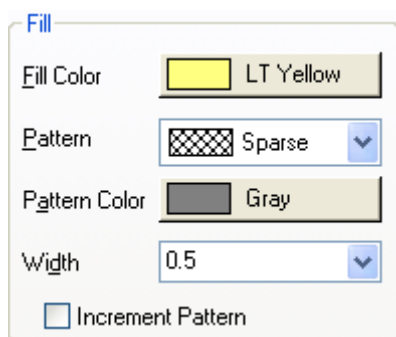

6. Double-click on the Y axis to open the **Axis** dialog box. Set the Y axis scale as shown in the screenshot below:

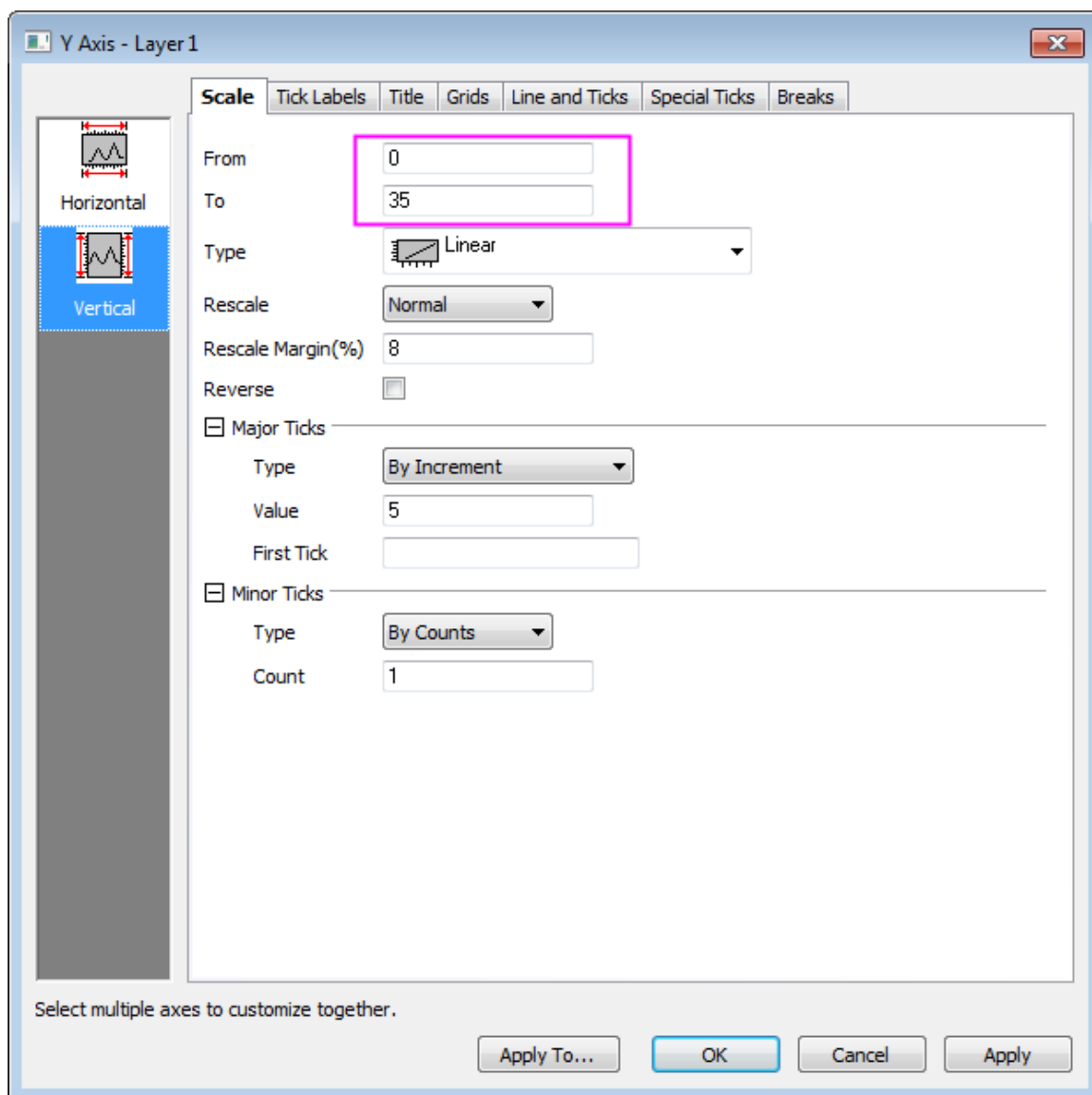



7. Then go to the **Tick Labels** tab to set X axis tick labels as shown in following screenshot:

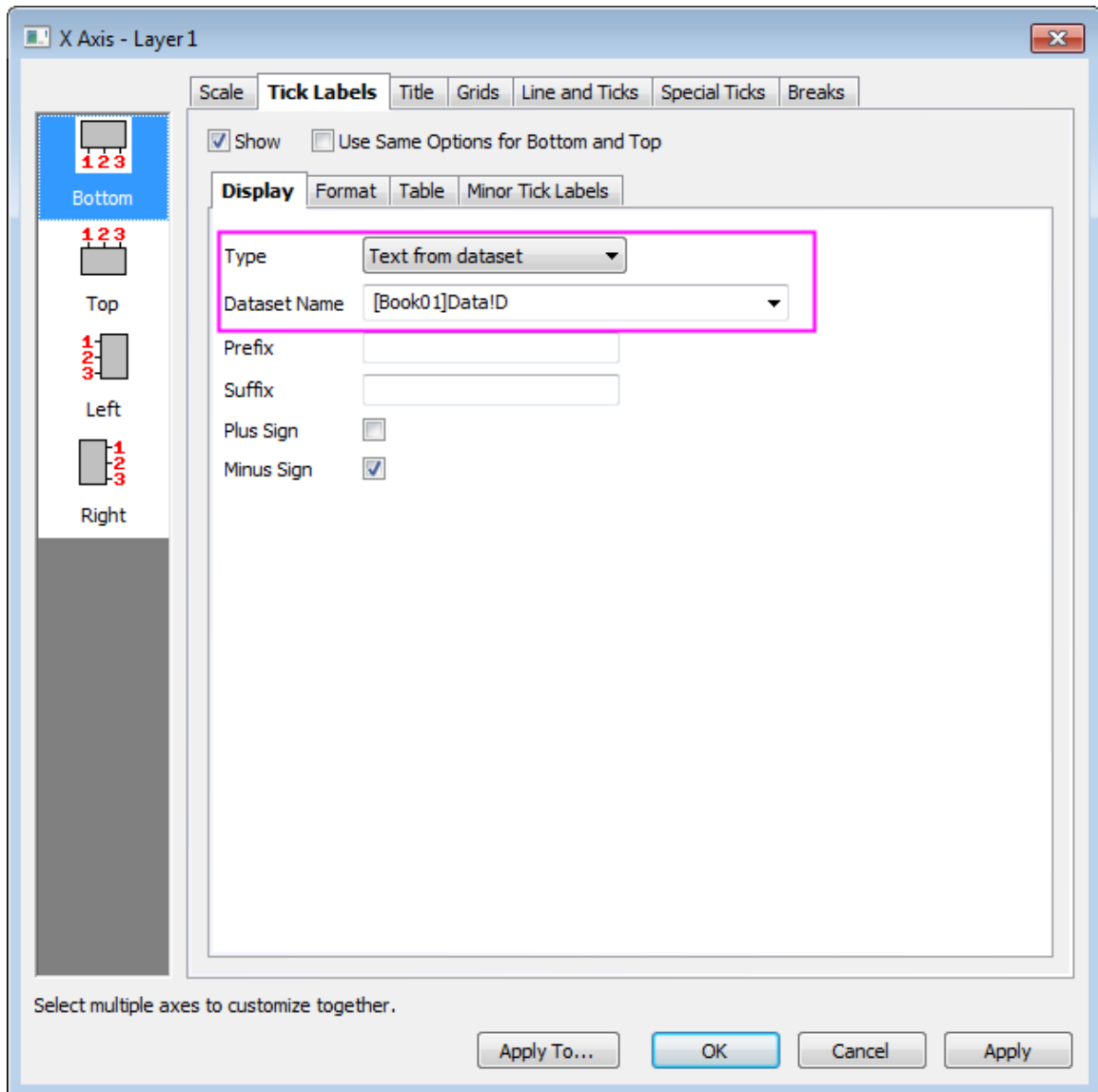

8. Go to the **Grids** tab and click the **Horizontal** icon on the left panel to customize grids for **Y Axis** and turn on major grid lines by duplicating the settings in the image below:

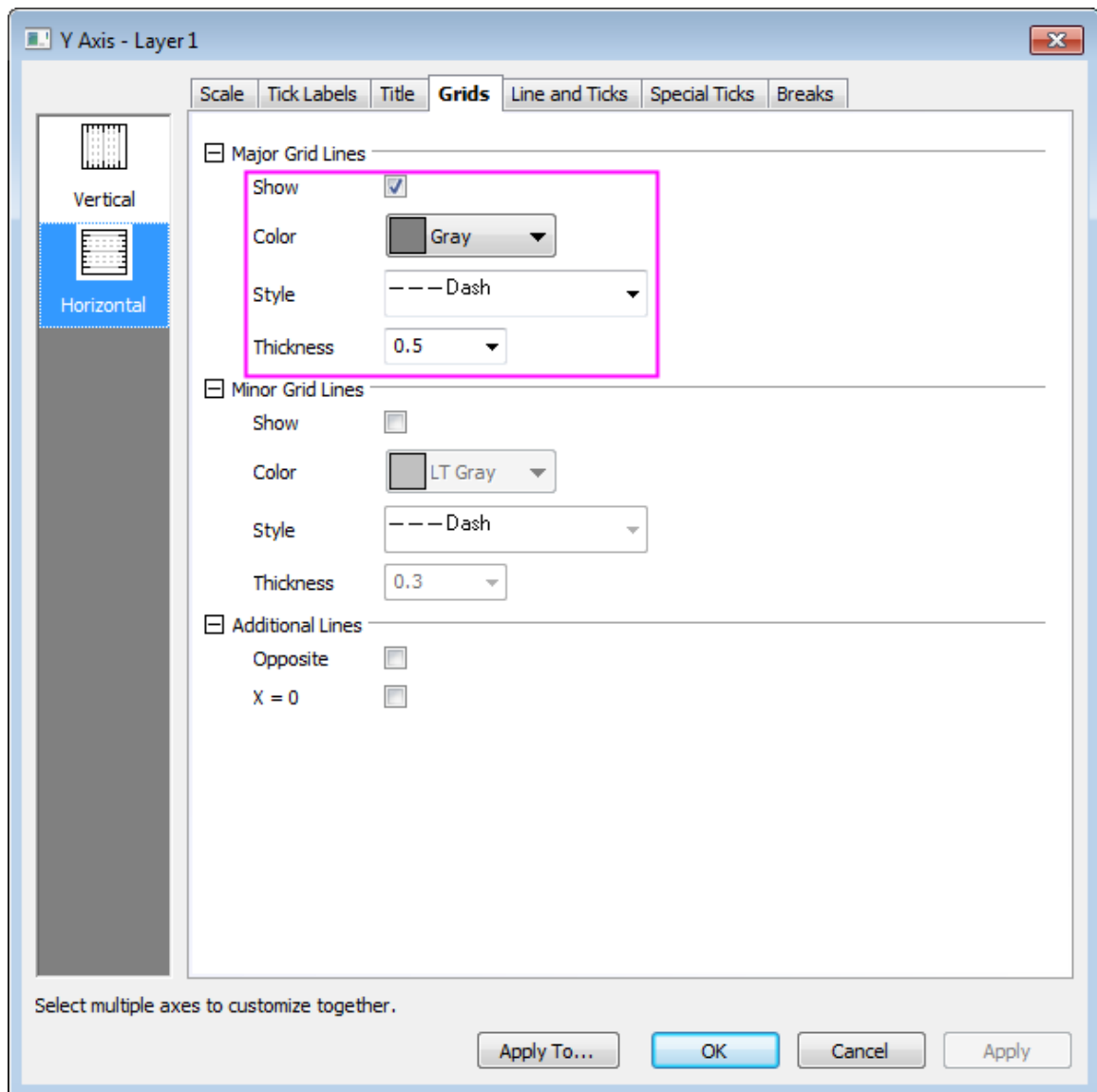

9. Click **Apply** first, and then hold Ctrl key to select both **Vertical** and **Horizontal** icons on the left panel and select the **Opposite** checkbox to turn on opposite additional lines for both X and Y axes.
10. Click **OK** to apply settings and close the **Axis** dialog box. Finally, delete the legend object.

## 6.8.6 Stack Column With Labels

### 6.8.6.1 Summary

This graph displays a stack column plot. Each data point in each column has been labelled using the associated data value, and custom formatting applied to column fills and labels.

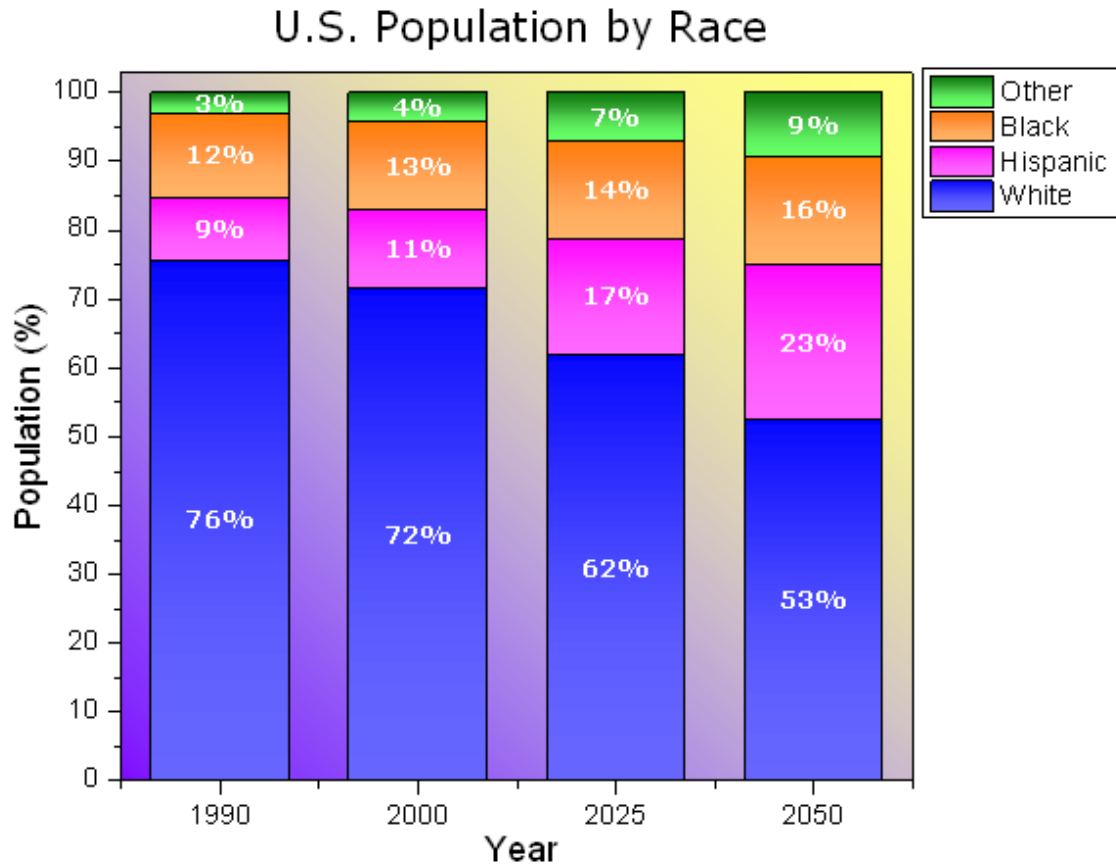

Minimum Origin Version Required: 2015 SR0

#### 6.8.6.2 What will you learn

This tutorial will show you how to

- Create a stack column plot
- Add labels for columns
- Customize the column graph

#### 6.8.6.3 Steps

This tutorial is associated with <Origin EXE Folder>\Samples\Tutorial Data.opj.

1. Open **Tutorial Data.opj** and browse to the **Stack Column With Labels** folder in **Project Explorer** (PE).
2. Activate the worksheet and select columns B through E. In the main menu, select **Plot > Basic 2D : Stacked Column**. Alternatively, you can click the **Stacked Column** button on the 2D Graph toolbar.

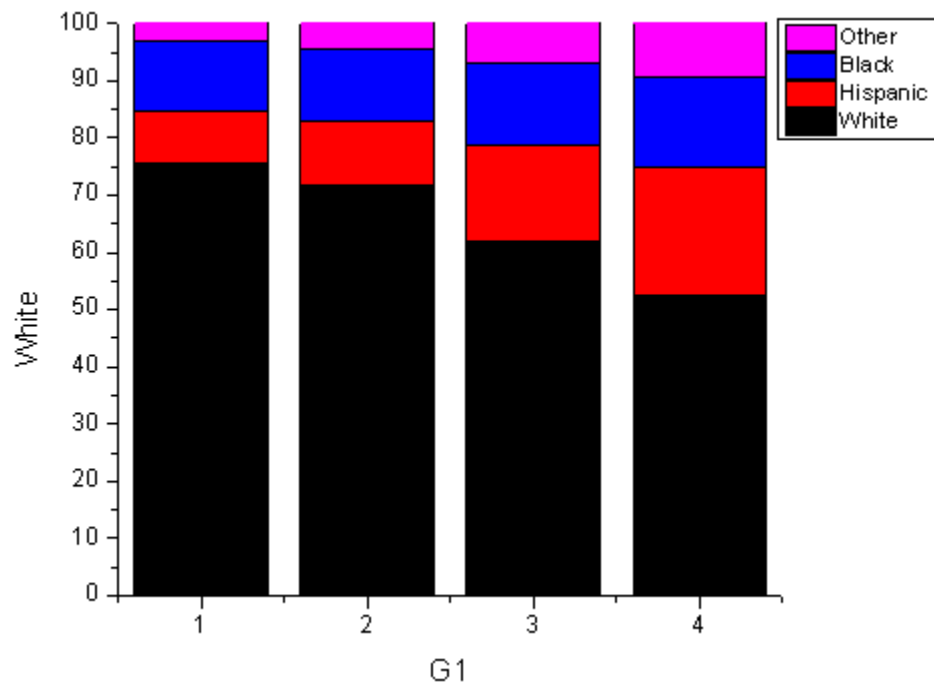

3. Double-click the X axis tick labels to open the **Axis** dialog box. Go to **Tick Labels** tab and set the X axis tick labels as following:

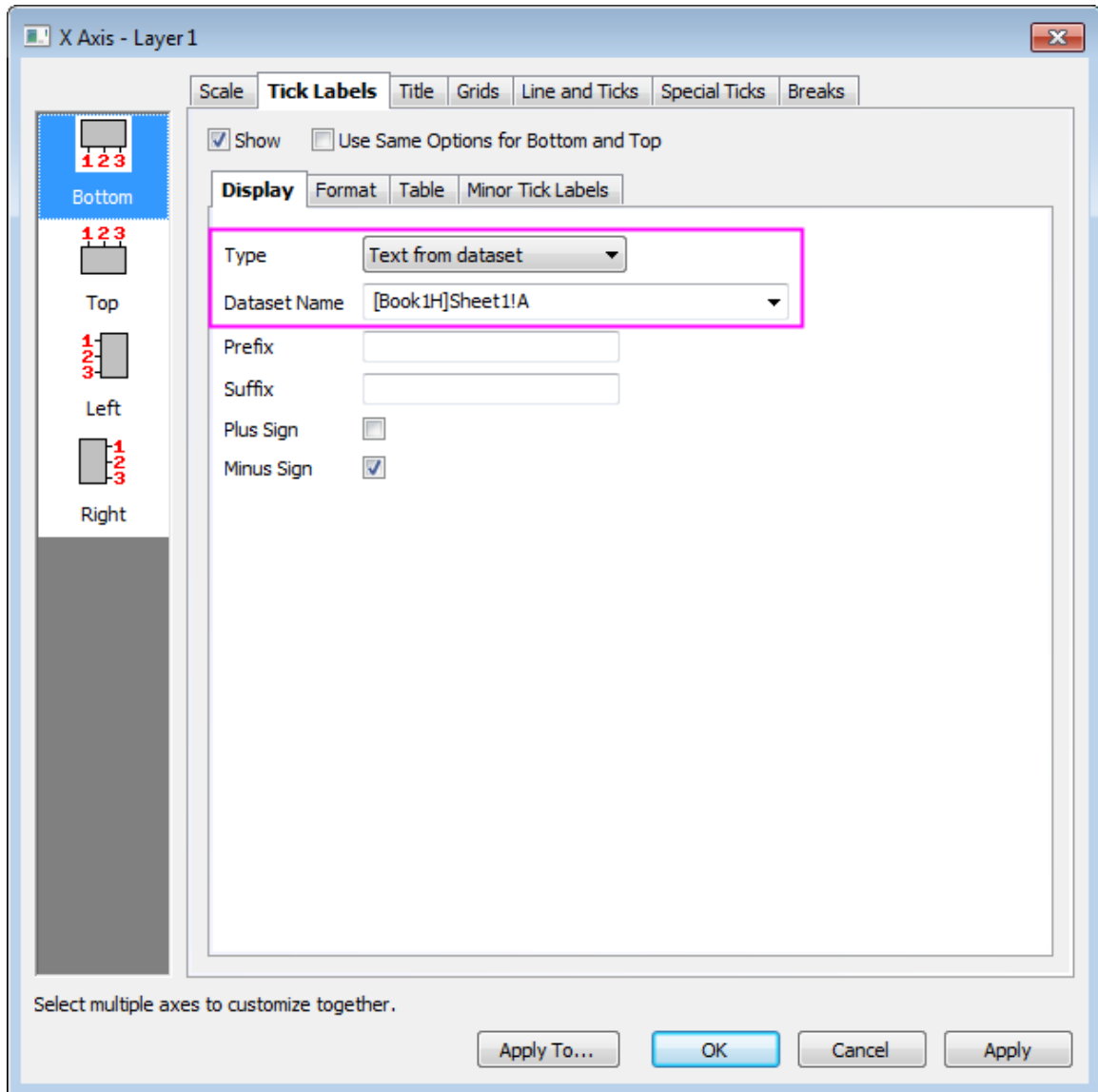

4. Select the **Grids** tab and hold Ctrl key to select **Horizontal** icon in left panel to simultaneously apply changes to the **Y Axis**. , Check the **Opposite** box to add lines opposite both the X and Y axes:

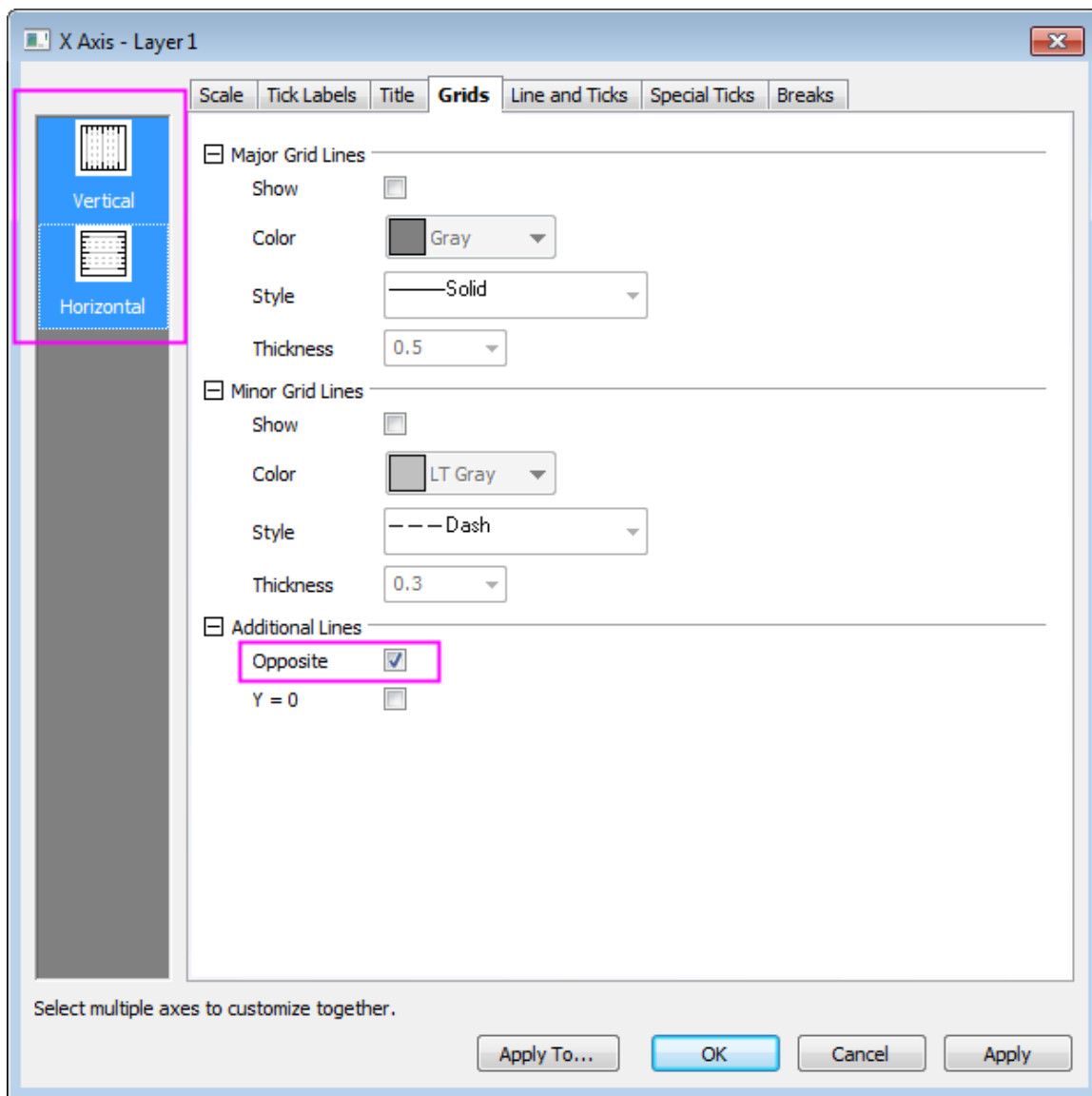

5. Go to the **Scale** tab and click **Vertical** icon on the left panel to set the value of **To** to **102** for Y axis and click **OK** to apply settings and close the Axis dialog box.
6. Double-click the plot to open the **Plot Details** dialog box. On the **Group** tab, set the **Fill Color** as shown below:

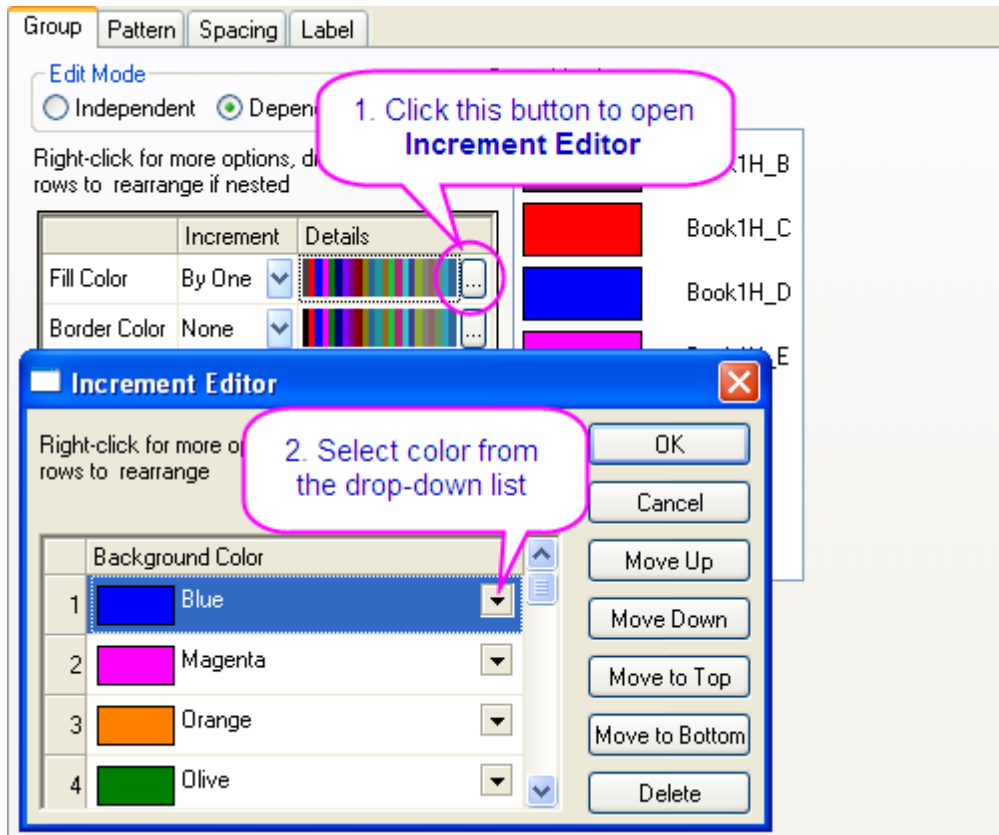

- On the **Label** tab, select **Enable**. Set the **Font**, **Color**, and **Size** to **Verdana**, **white**, and **18**. Set **Label Form** to **Custom** and enter "\$((y),.0)%" for the **Format String**.

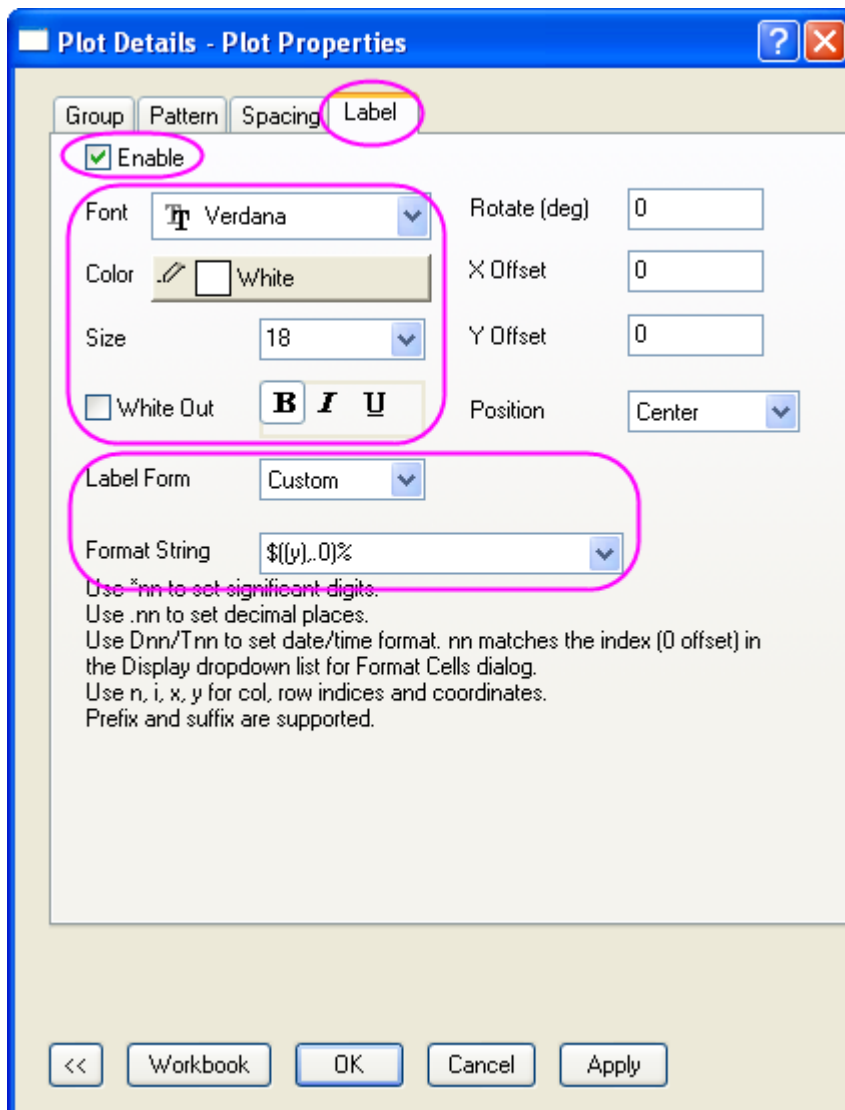

- On the **Spacing** tab, set **Gap Between Bars(in %)** to **30**.

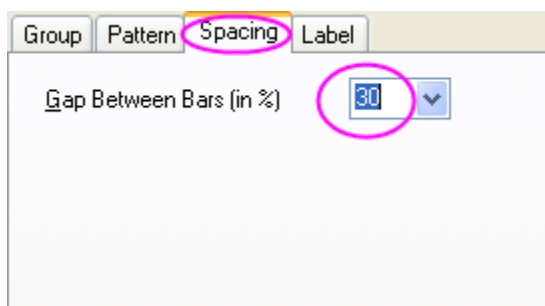

- On the **Pattern** tab, set **Gradient Fill** as shown below:



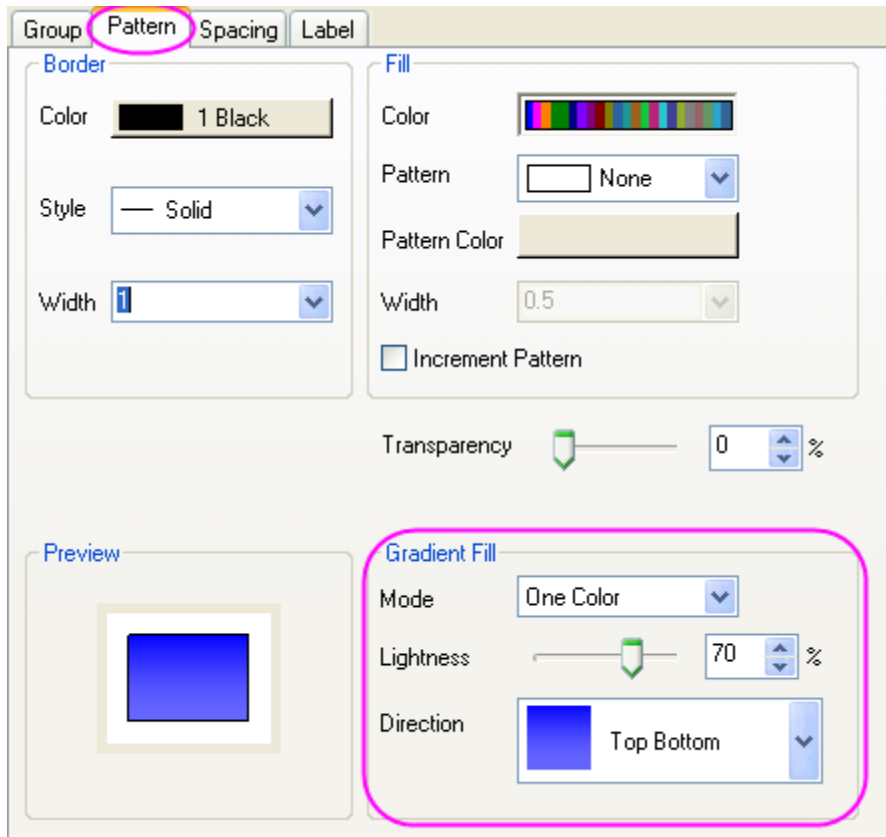

10. In the left panel, select **Layer1**. On the **Background** tab, set **Color** and **Gradient Fill** as shown below:

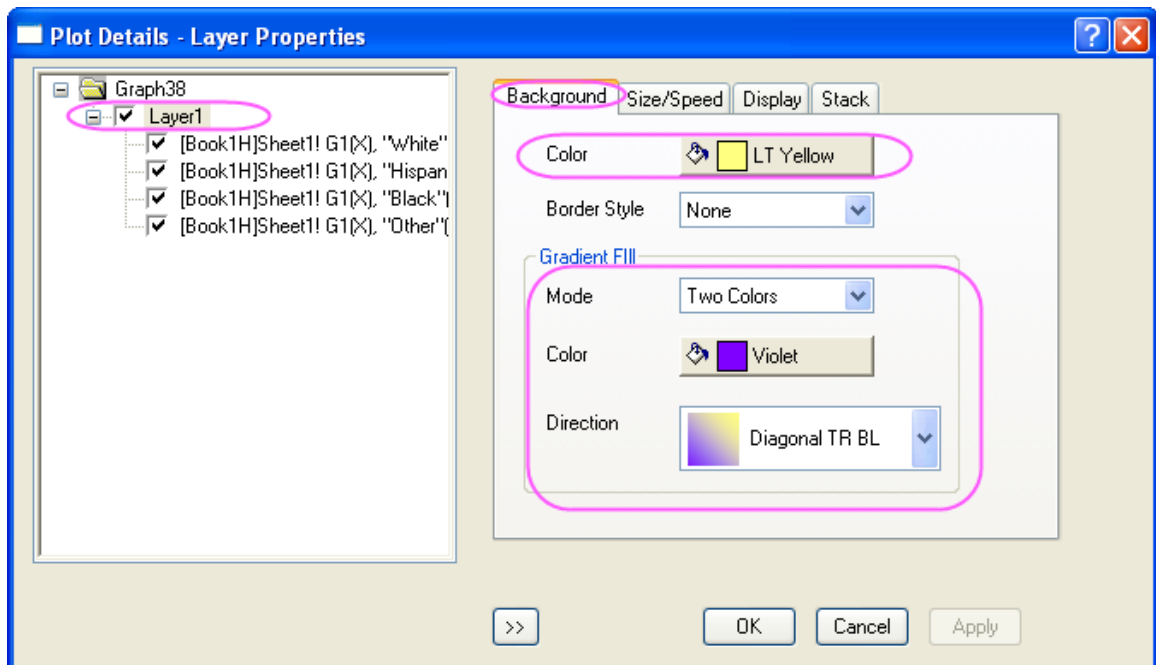

11. Click **OK** to close the dialog box. To complete the graph, change the X and Y axis labels to "Year" and "Population (%)", then add the graph title "U.S. Population by Race."

## 6.8.7 Clustered-Stacked Column Chart

### 6.8.7.1 Summary

This tutorial will show you how to create a clustered-stacked column chart in Origin. This graph consists of two graph layers, each of which has a stacked column.

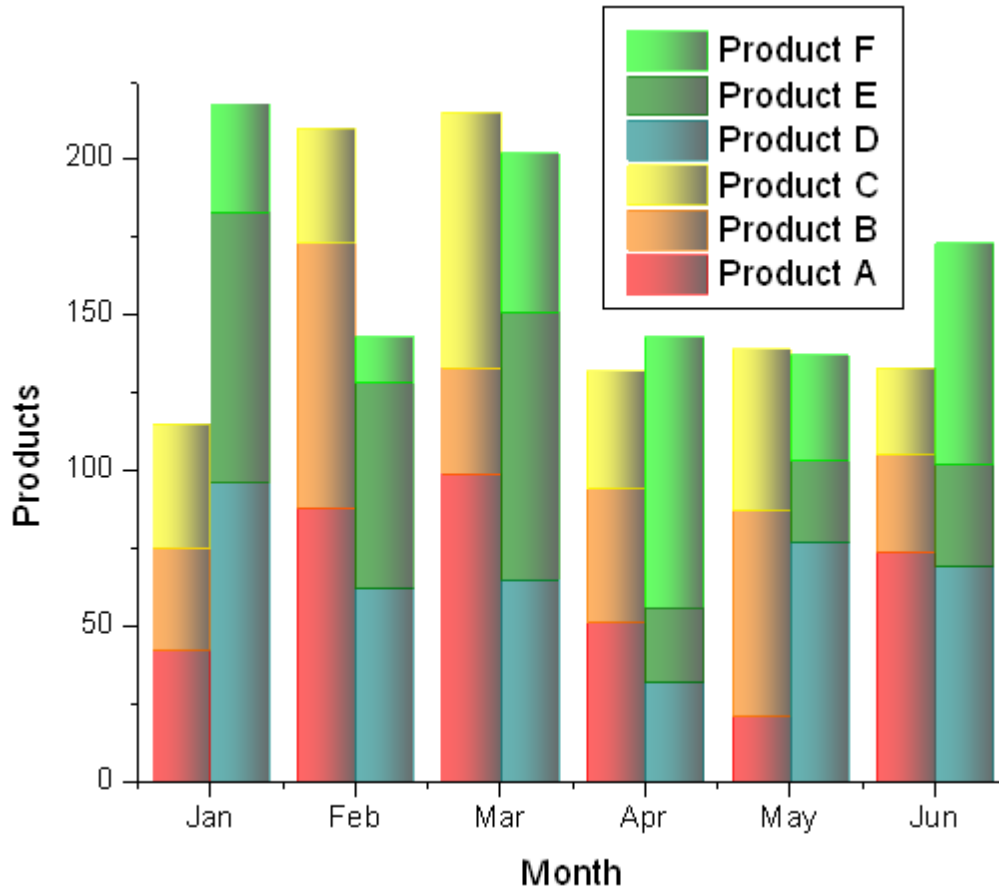

Minimum Origin Version Required: Origin 8.5.1 SR0

### 6.8.7.2 What will you learn

This tutorial will show you how to

- Create a stacked column graph.
- Create a graph that has two stacked column graphs.
- Customize a column chart.

### 6.8.7.3 Steps



After version 2015, Origin supports to set subgroup for multiple stacked column plots in a layer. And it is easier to plot the grouped stacked columns graph. Please refer this tutorial: [Grouped Stacked Column](#)

1. Import the sample data [Data 1](#) and [Data 2](#) into different worksheets in Origin. Set the first line as Long Name for them and set the sheet names as 2010 and 2011 respectively.

	A(X)	B(Y)	C(Y)	D(Y)
Long Name		Product A	Product B	Product C
Units				
Comments				
1	Jan	42	33	40
2	Feb	88	85	37
3	Mar	99	34	82
4	Apr	51	43	38
5	May	21	66	52
6	Jun	74	31	28
7				
8				

2. Create a new graph layer by selecting **File : New : Graph** from the main menu. And then select **Insert: New Layer: No Axes(Link XY Scale and Dimension)** from the main menu to add another layer to the graph window you just created.
3. Select **Graph: Plot Setup...** from the main menu to open the **Plot Setup** dialog. In this dialog, select **Column/Bar** in the **Plot Type** box, select worksheet *2010* and *2011* in the top panel respectively, assign col(A) as X and col(B)~col(D) as Y in the middle panel, and then click the **Add** button to add them to

**Layer 1** and **NoAxes** layer respectively.

**Available Data:**

Long Name	Sheet	Cols	Rows	File Name	File Date	Created	Modified
Book1	2010	4	32			11/27/2017 11:34:52	11/27/2017 11:35:21
Book1	2011	4	32			11/27/2017 11:34:52	11/27/2017 11:35:21



**Plot Type:** Show(S) [Book1]"2011"

X	Y	yEr	L	Column	Long Name	Comments	Sampling Interval	Position
<input type="checkbox"/>	<input type="checkbox"/>	<input type="checkbox"/>	<input type="checkbox"/>	< autoX >	From/Step=			0
<input checked="" type="checkbox"/>	<input type="checkbox"/>	<input type="checkbox"/>	<input type="checkbox"/>	A	Product A			1
<input type="checkbox"/>	<input checked="" type="checkbox"/>	<input type="checkbox"/>	<input type="checkbox"/>	B	Product B			2
<input type="checkbox"/>	<input type="checkbox"/>	<input checked="" type="checkbox"/>	<input type="checkbox"/>	C	Product C			3
<input type="checkbox"/>	<input type="checkbox"/>	<input type="checkbox"/>	<input checked="" type="checkbox"/>	D	Product D			4

**Plot List:** Drag entries in 1st column to reorder or to move between layers. Right click for other options.

Plot	Range	Show	Plot Type	Legend
Layer 1		<input type="checkbox"/> Rescale <input checked="" type="checkbox"/>		
Group				
[Book1]2010! A(X), "Product A"(Y)	[1:*6*] 21 < Y < 99	<input checked="" type="checkbox"/>	Column / Bar	Product A
[Book1]2010! A(X), "Product B"(Y)	[1:*6*] 31 < Y < 85	<input checked="" type="checkbox"/>	Column / Bar	Product B
[Book1]2010! A(X), "Product C"(Y)	[1:*6*] 28 < Y < 82	<input checked="" type="checkbox"/>	Column / Bar	Product C
NoAxes		<input type="checkbox"/> Rescale <input checked="" type="checkbox"/>		
Group				
[Book1]2011! A(X), "Product D"(Y)	[1:*6*] 32 < Y < 96	<input checked="" type="checkbox"/>	Column / Bar	Product D
[Book1]2011! A(X), "Product E"(Y)	[1:*6*] 24 < Y < 87	<input checked="" type="checkbox"/>	Column / Bar	Product E
[Book1]2011! A(X), "Product F"(Y)	[1:*6*] 15 < Y < 87	<input checked="" type="checkbox"/>	Column / Bar	Product F



In order to show all three panels in **Plot Setup** dialog, please expand **Plot Type** panel by clicking  and expand **Available Data** panel by clicking  again.

Please refer to [Plotting using Plot Setup](#) for more information.

- Click **OK** button to close the **Plot Setup** dialog. Click the **Rescale** button, you will get a graph with two column graphs overlapped as shown below:



- Double-click on the graph to open the **Plot Details** dialog. Select **Layer1** level in the left panel, go to **Stack** tab in the right panel, and select the **Cumulative** option. Select **NoAxes** level, do the same setting.

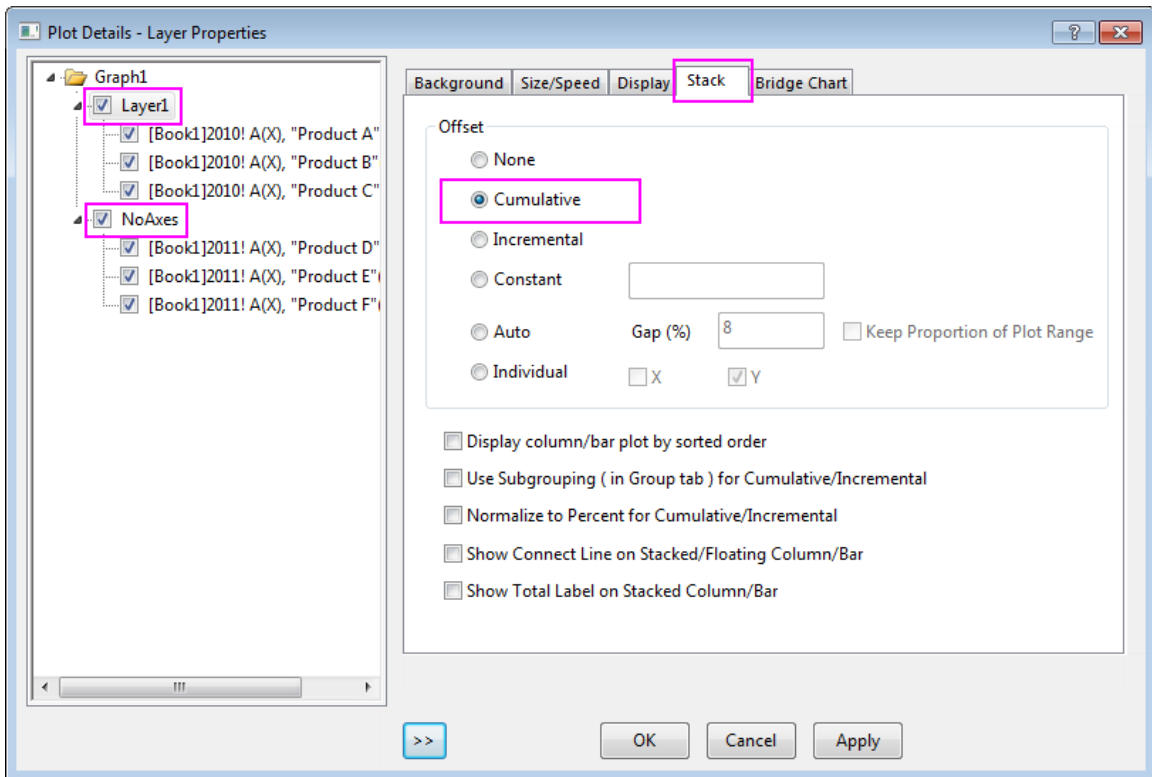

6. Select **Graph1** level in the left panel, go to the **Miscellaneous** tab in the right panel, and check the **Column/Bar Gap/Offset Across Layers** check box.

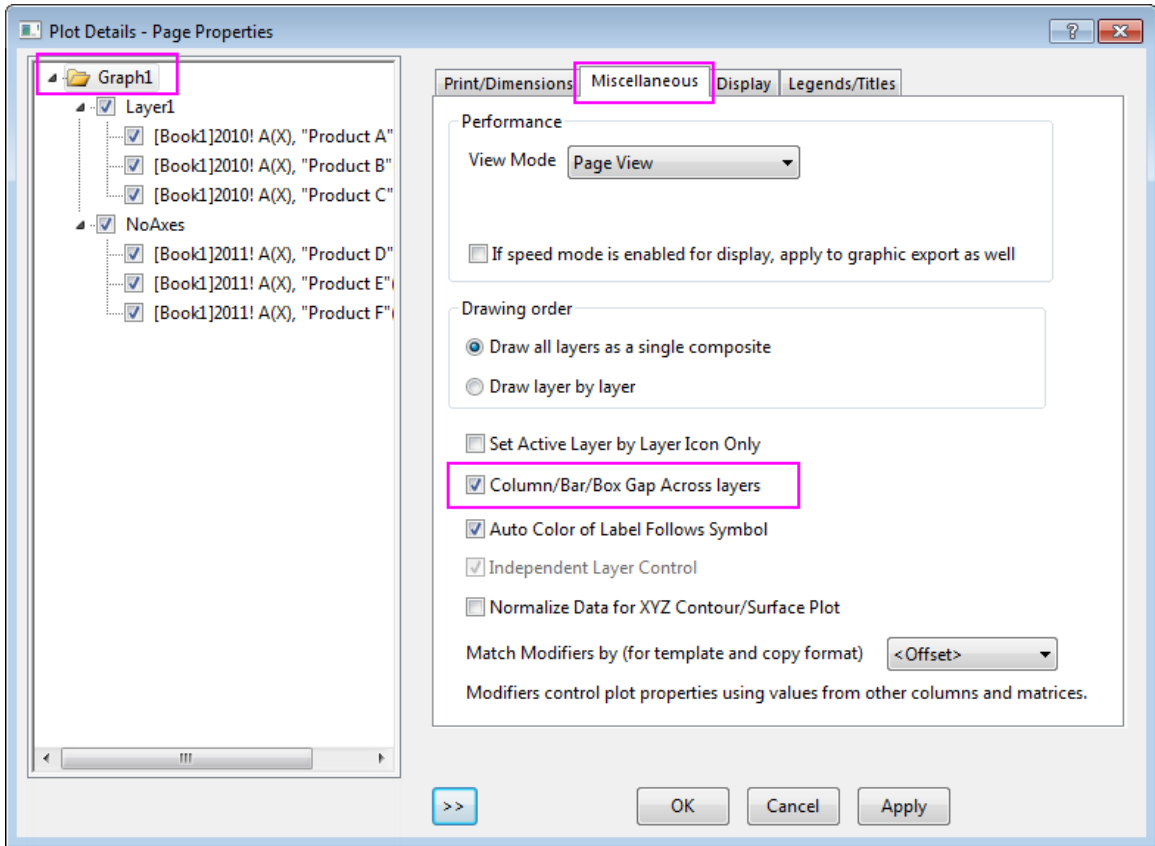

7. Click **OK** button, you will see the plot with two stacked columns will show side by side with an auto gap.

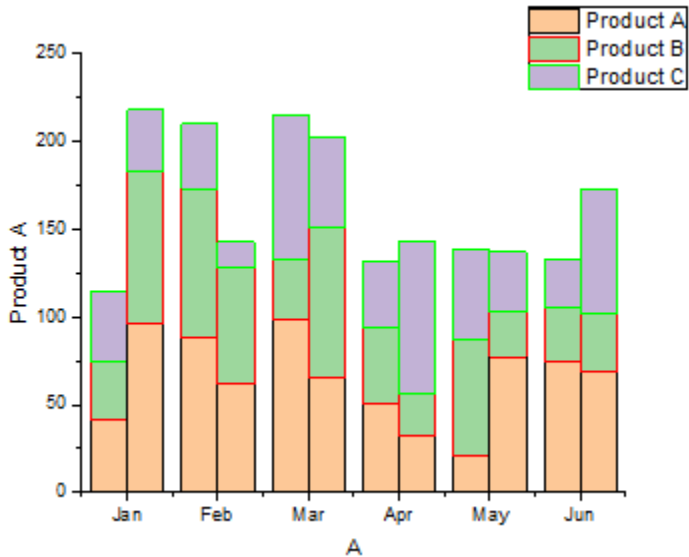

8. Double-click on the graph to open the **Plot Details** dialog again. Set the **Border Color** and **Fill Color** respectively, as shown below:

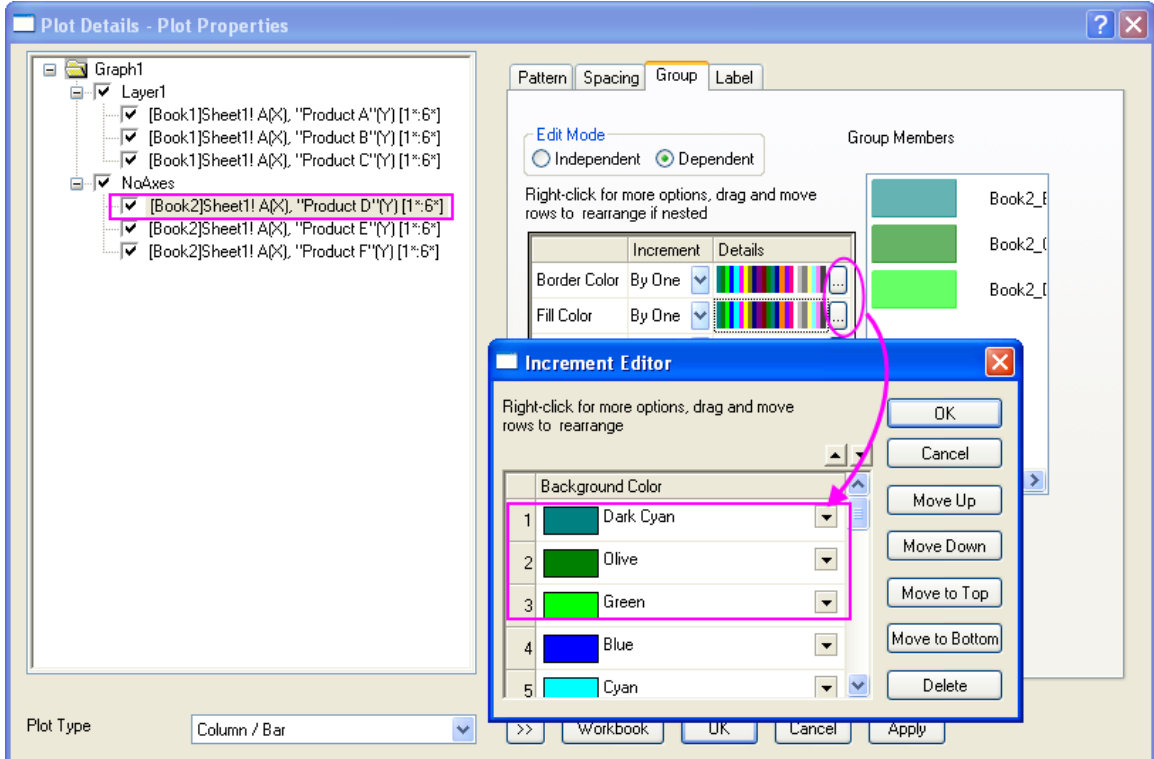
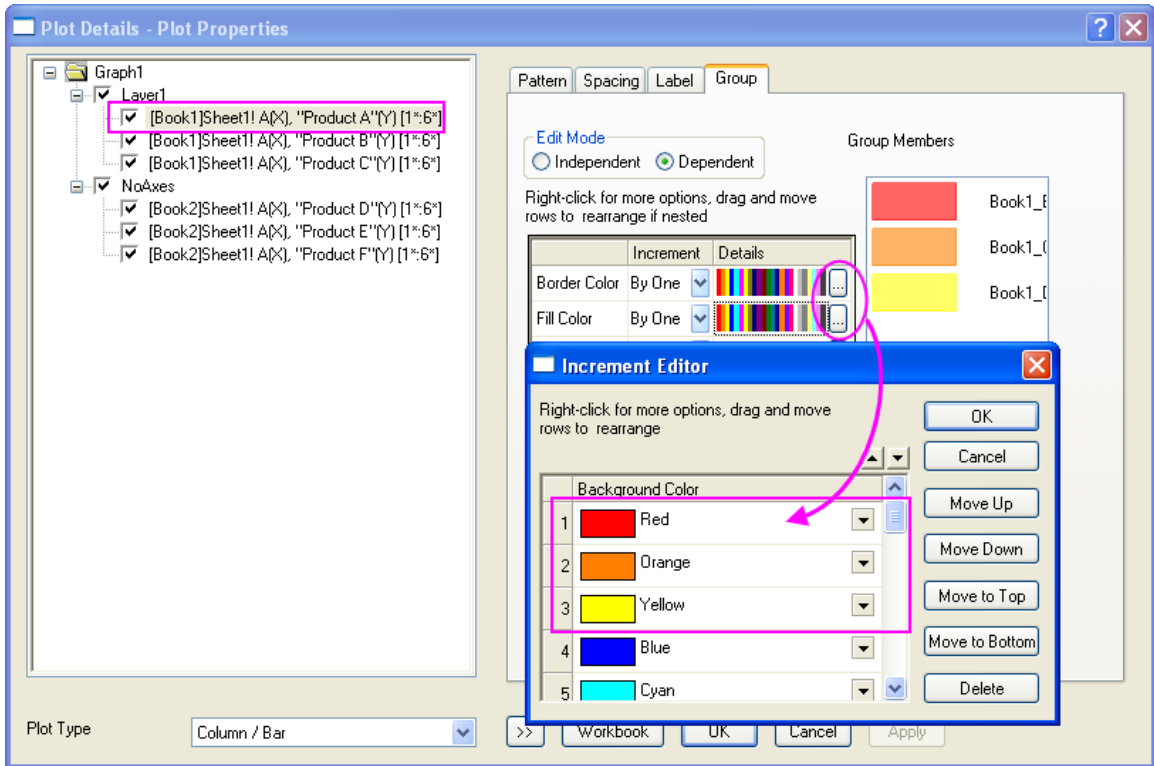

- Go to the **Pattern** tab to set the **Transparency** as *40*, **Border Width** as *0.2*, and **Gradient Fill** as shown for both graph layers:

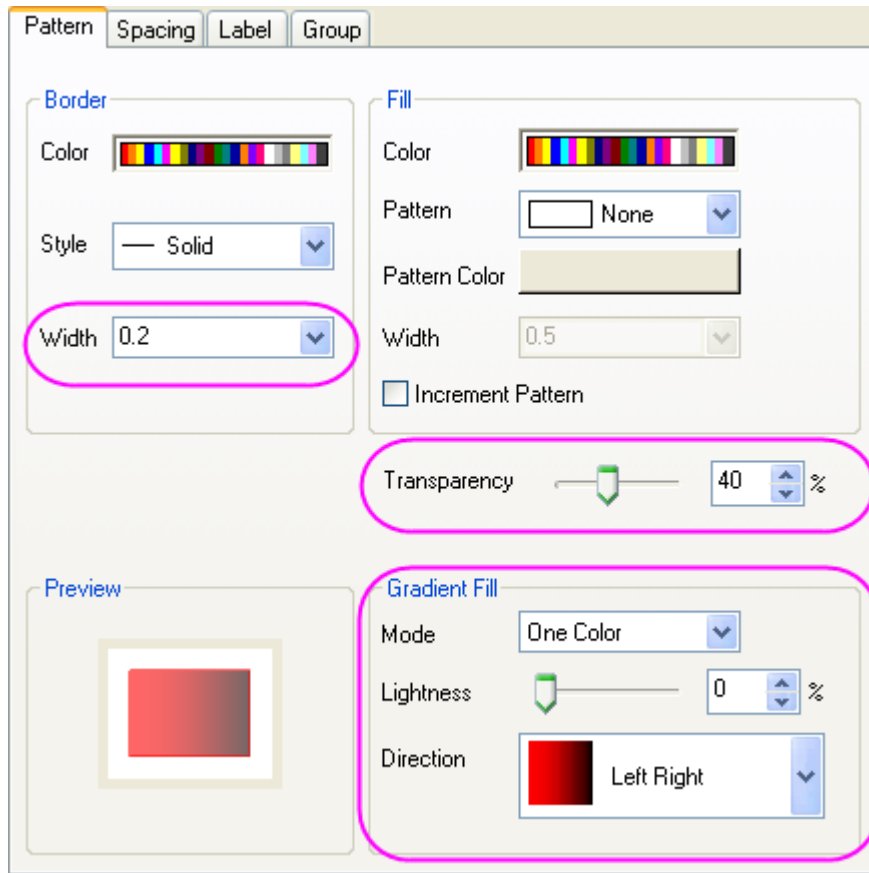

- Click **OK** button to close the **Plot Details** dialog.

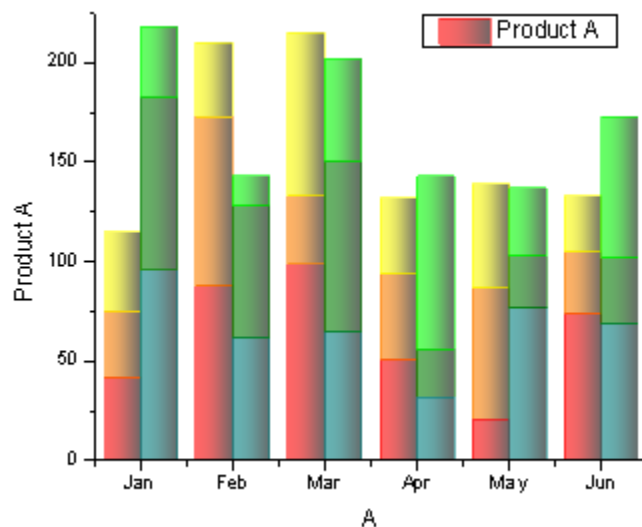

- Right-click on the graph legend, select **Update Legend** from the context menu to open the **LegendUpdate** dialog. Set the **Update Mode** as **Reconstruct**, **Legend** as **One Legend for All,Layer**



Order as **Descending** and **Plot Order within Layer** as **Ascending**.

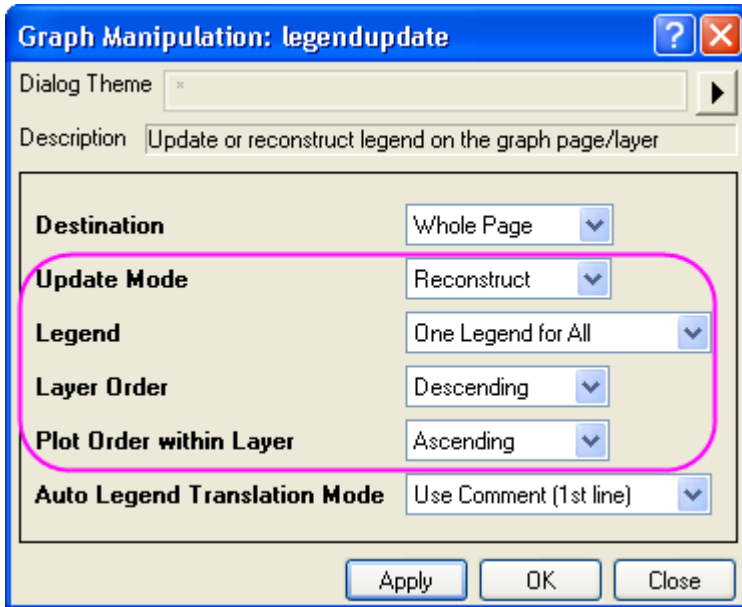

- Click **OK** button to close the dialog and then update the axis labels, you will get the final graph shown below:

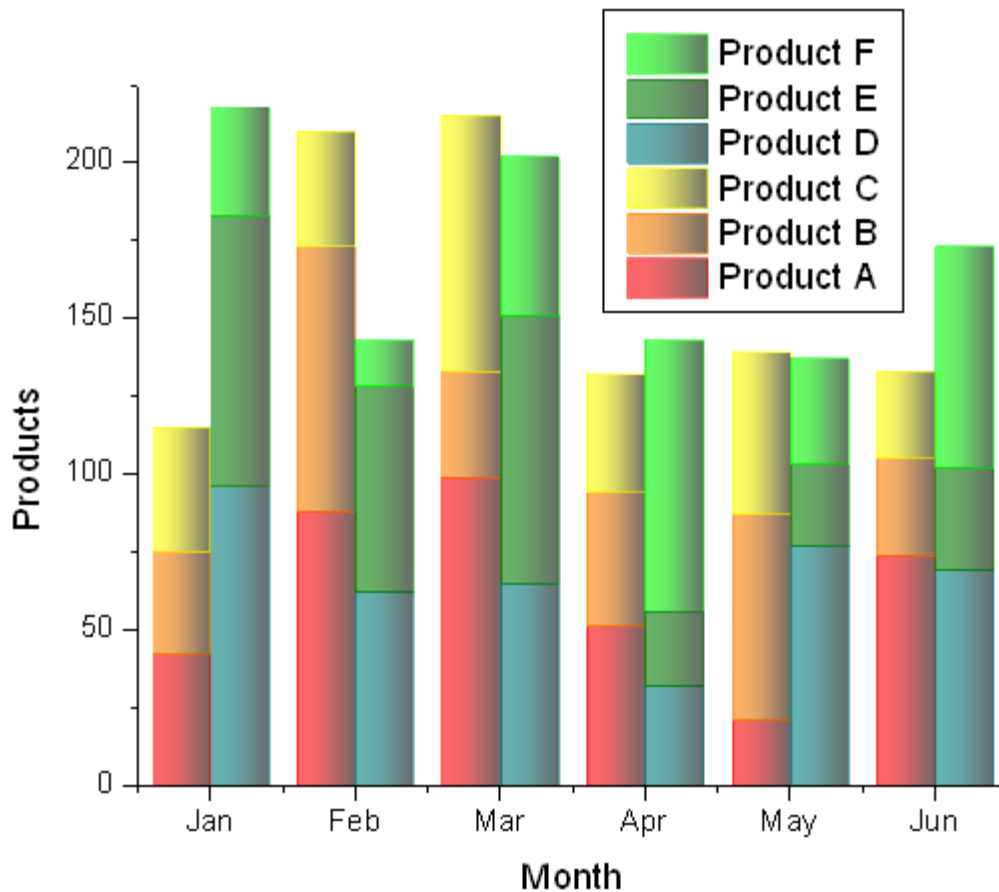

6.8.7.4 Sample Data

**6.8.7.4.1 Data 1**

	Product A	Product B	Product C
Jan	42	33	40
Feb	88	85	37
Mar	99	34	82
Apr	51	43	38
May	21	66	52
Jun	74	31	28

**6.8.7.4.2 Data 2**

	Product D	Product E	Product F
Jan	96	87	35
Feb	62	66	15
Mar	65	86	51
Apr	32	24	87
May	77	26	34
Jun	69	33	71

**6.8.8 Grouped Column with Error Bars and Data Labels**

6.8.8.1 Summary

Origin supports grouped column graphs with indexed data. Multiple group levels are supported. Grouping information can be shown in tick label tables on the X or Y axes.

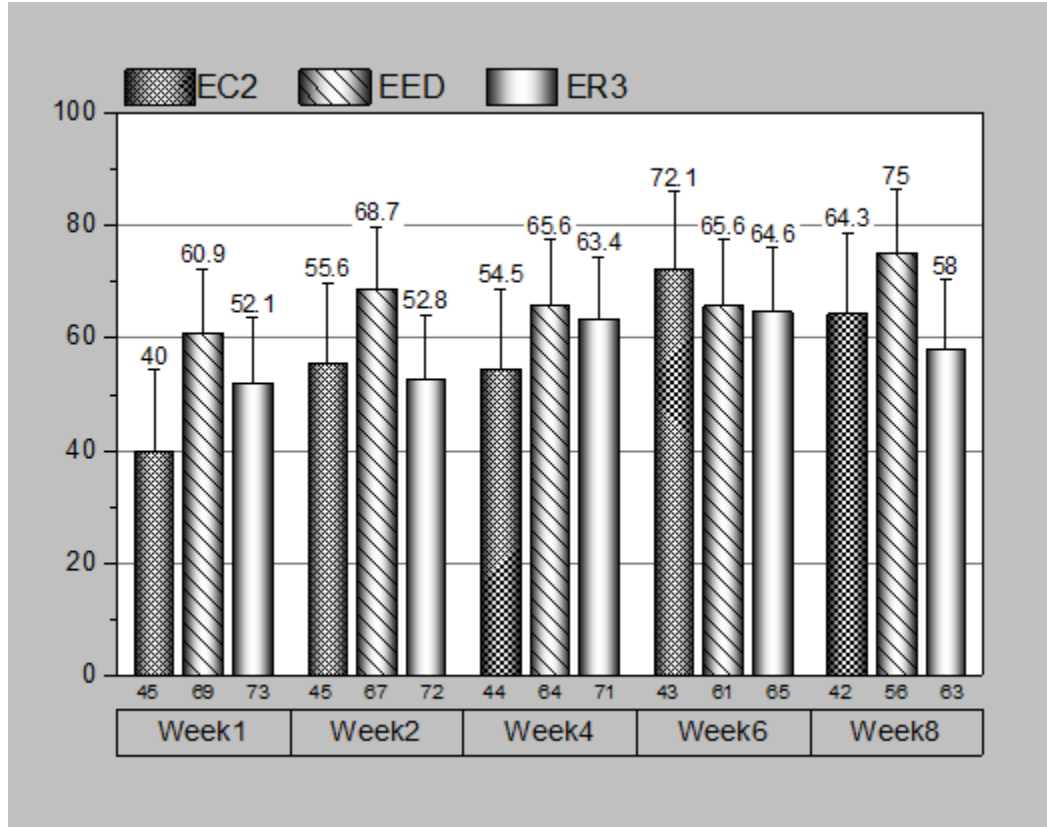

Minimum Origin Version Required: 2015 SR0

### 6.8.8.2 What will you learn

This tutorial will show you how to

- Plot grouped column and error bar with indexed data
- Customize tick labels, colors, gaps, error bars and data labels
- Update legend to show grouping information.

### 6.8.8.3 Steps

This tutorial is associated with <Origin EXE Folder>\Samples\Tutorial Data.opj.

Also, you can refer to this graph in Learning Center. (Select **Help: Learning Center** menu or press **F11** key , and then open **Graph Sample: Column and Bar**)

1. Open **Tutorial Data.opj** and browse to the **Grouped Column with Error Bars and Data Labels** folder in **Project Explorer** (PE).
2. In the following steps, we want to customized the order of values shown in the graph but not change the source data. Right click Column **B** in workbook, select **Set As Categorical** in the list menu, double click the literal "Unsorted" to open the **Categories** tab. Then select **Ascending** in **Sort** list and click **OK** to

close the dialog.

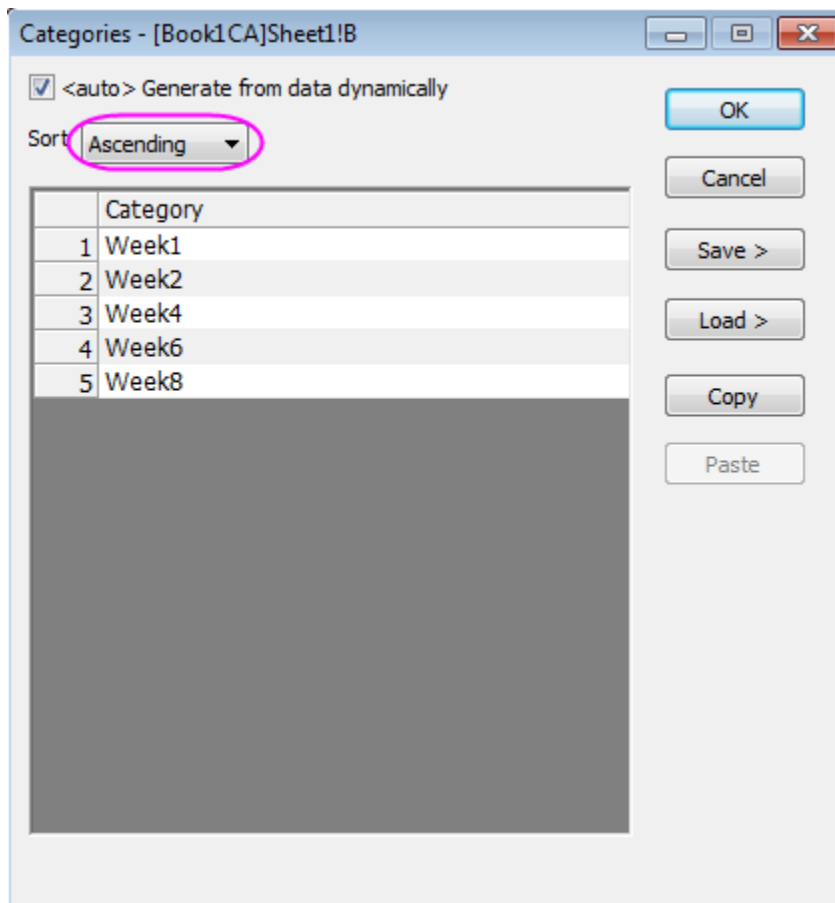

3. Do the same operation for Column **C** and **F** to set the Column **C** and **F** as categorical data as well and set the order of categorical values as **Ascending**.
4. We are going to create a grouped column chart from worksheet. Highlight column **D(Y2)** and **E(yErr)** and select **Plot > Categorical : Grouped Columns - Indexed Data...** from the main menu.
5. In **plot\_gindexed** dialog, click  in the "Group Column(s)" to add columns **B**, **C**, and **F** (in that order) to the Group List. Click the **OK** button.

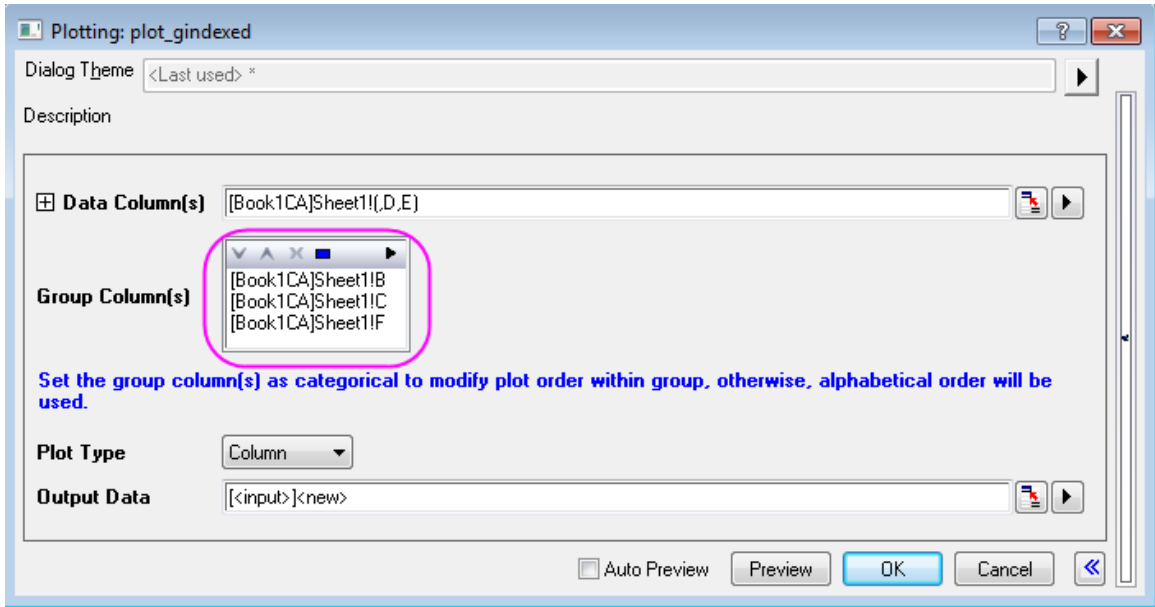

A grouped column plot with error bar is created. The 3-row tick label table at the bottom shows the grouping information. Note that a worksheet is created to contain the data used to create this graph.

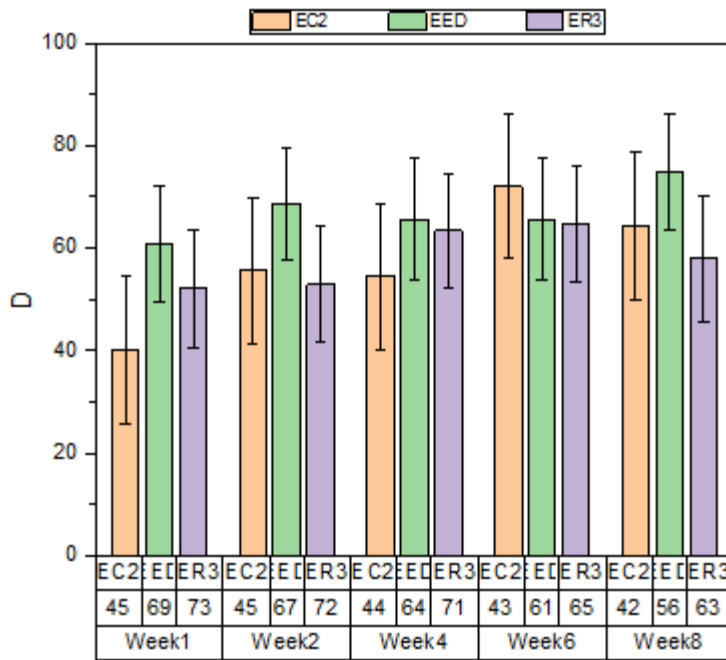

- To hide the first tick label row, double-click on any tick label in the row, e.g. **EC2**. The **Axis** dialog box will open with the **Bottom 3** icon selected in the left panel. uncheck the **Show** box and click Apply.

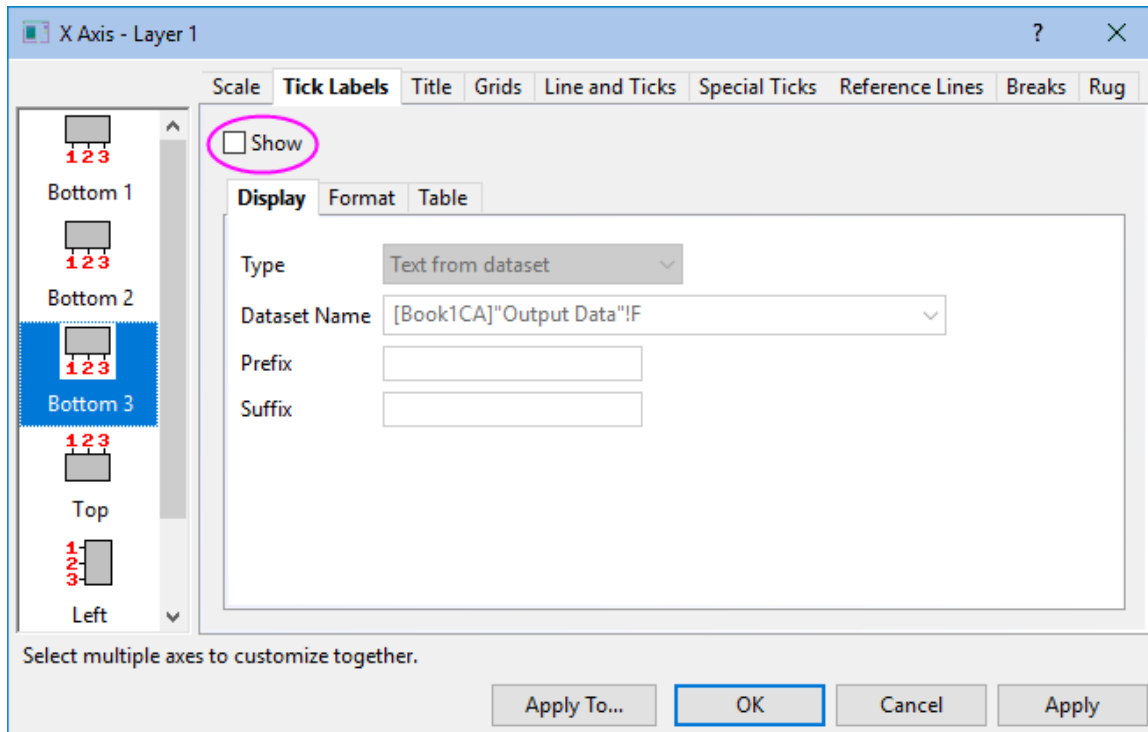

- We want to customize the appearance of the **Bottom 2** tick label row. Select the **Bottom 2** icon on the left panel. On the Table tab, clear the **Auto** box, clear all **Border** check boxes then click the **OK** button.

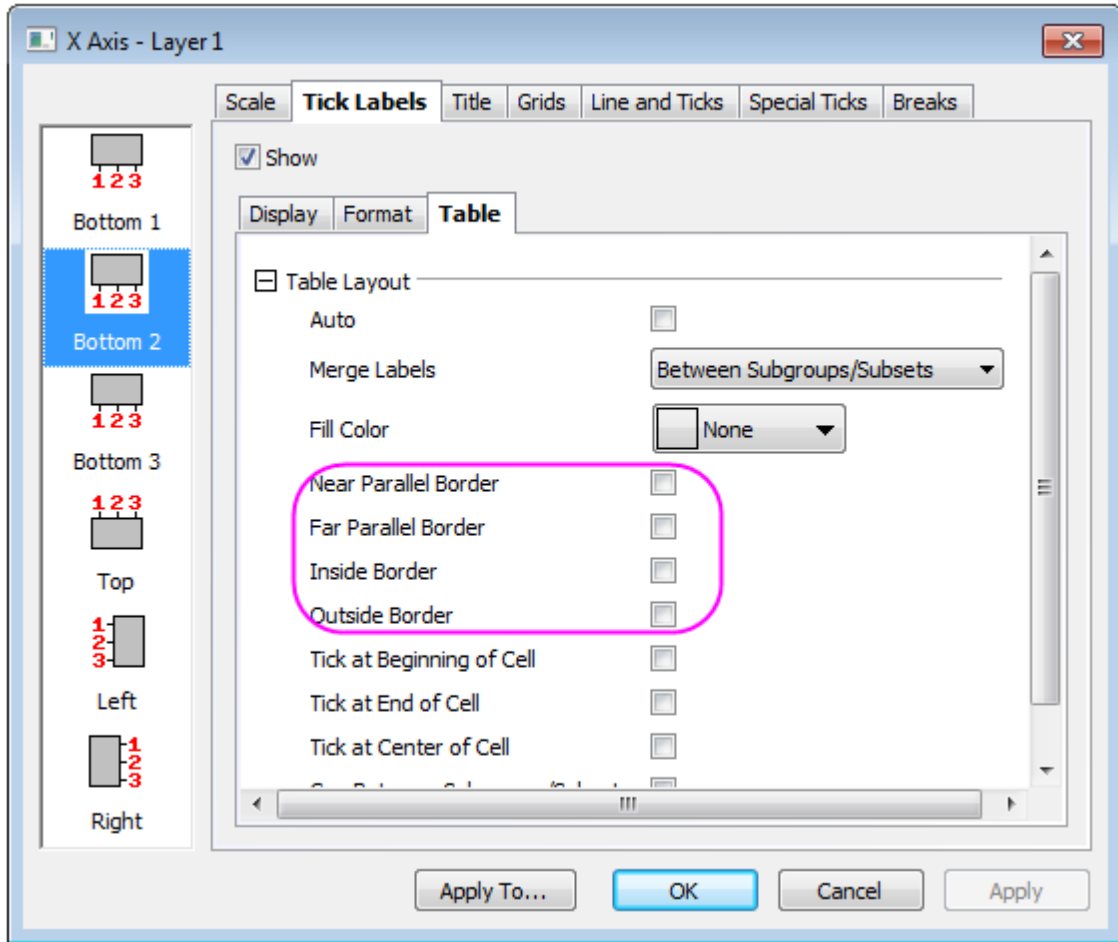

Two tick label rows remain, each with different layout.

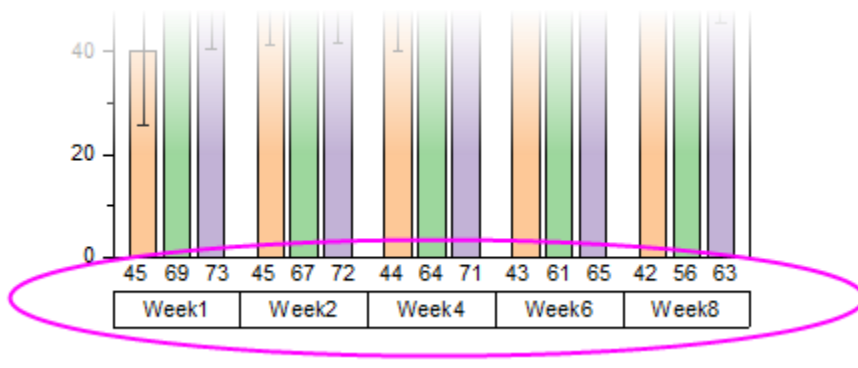

#### 6.8.8.4 Further Customizations

The tutorial steps that follow, further customize the graph so that it looks like the image in the **Summary** section.

1. With the graph window active, choose **Format: Axis Tick Labels: Y Axis Tick Labels**. Click the **Grids** tab. With **Horizontal** highlighted in the left panel, under **Major Grid Lines**, check the **Show** box. Click

**Apply** to show horizontal grids.

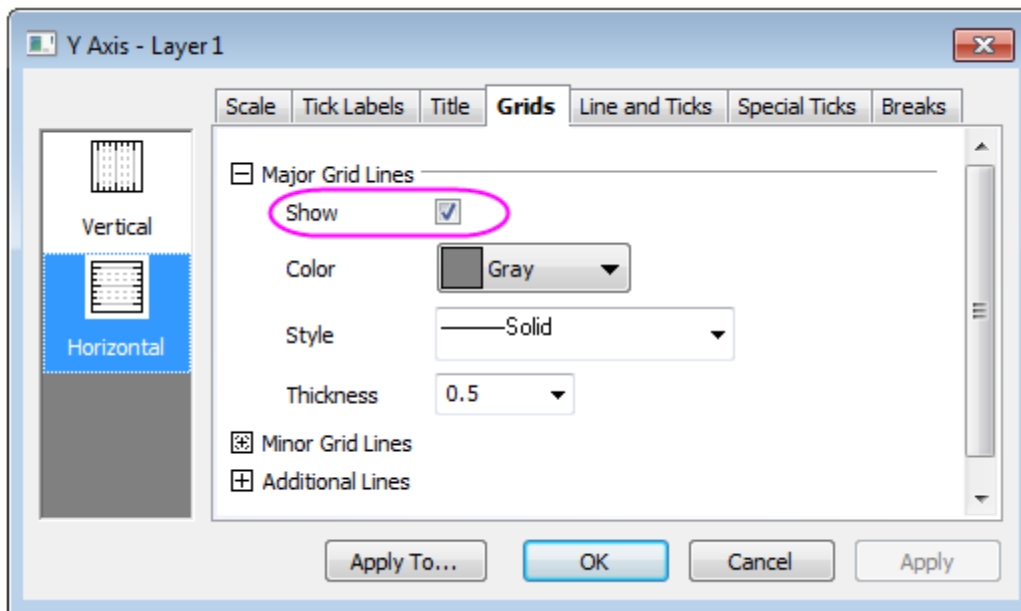

2. To turn on frames for both X and Y axes, hold the CTRL key and select both **Horizontal** and **Vertical** in left panel. Under **Additional Lines**, check the **Opposite** box and click **OK**.
3. From the menu, choose **Format: Plot**. In Plot Details, click the **Label** tab and check the **Enable** box. Duplicate the settings as shown below.

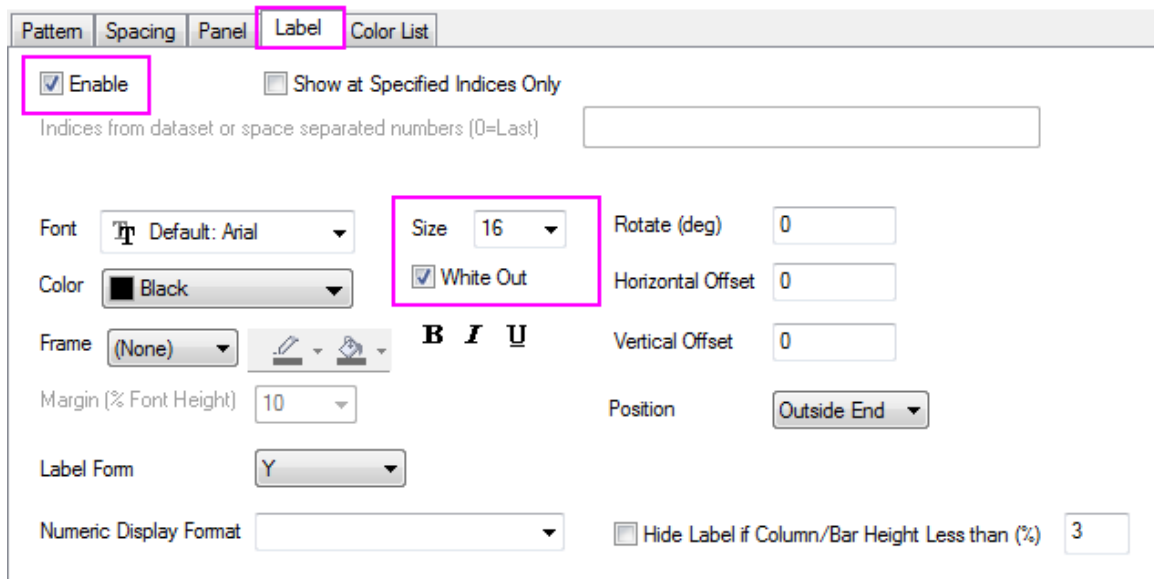

You can use the **Numeric Display Format** drop-down to format the label values. For instance, to show a single decimal place for each label, enter ".1", then click **Apply**. For more information, see [Custom Numeric Formats](#)



4. To adjust the gap between each week, go to the **Spacing** tab and set the **Gap Between Subsets(%)** to **15** (hint: you can type into the box).

Pattern	Spacing	Panel	Label	Pattern List
Gap Between Bars (in %)		20		
Overlap(%, Negative for Gap)		0		
Gap between Bars from Different Panels (in %)		0		
Width (in %)		None		Scaling Factor
				1
Subset				
Enable Subset		<input type="radio"/> None <input type="radio"/> By Size <input checked="" type="radio"/> By Column		
		Col(A)		
Gap Between Subsets (%)		15		

5. We are going to use the data in column F to set fill pattern and add a color gradient fill to the column plot. Go to the **Pattern** tab of **Plot Details** and set as follows. The gradient fill direction should be **Horizontal Center Out**.



To set fill **Color** to White, click the drop-down, click the **Single** tab and click the White cell. Similarly, for fill **Pattern**, click the drop-down, click the **By Points** tab, click the **Use Column Values** button and choose *Col(F)* from the list.

6.

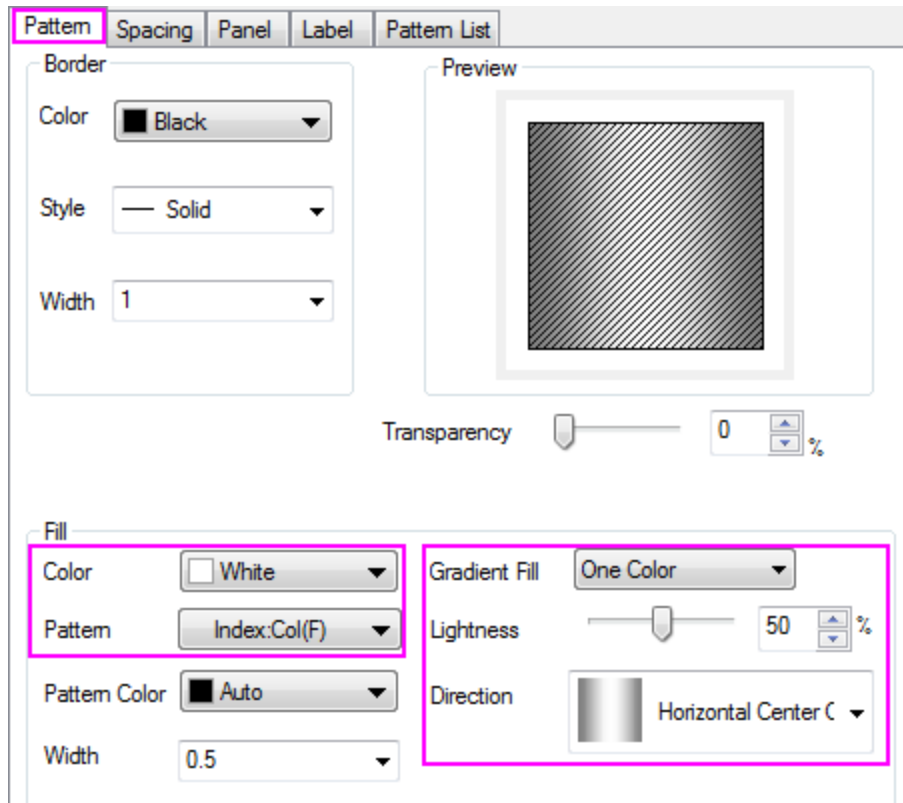

7.

- To customize the pattern list, click on the **Pattern** drop-down list again and then click the pencil icon to the right of the pattern list. This opens the Increment Editor, where you create your custom pattern list. Rearrange the top three entries in your custom list as shown, by dragging the numbered buttons to the left side of the pattern gallery.

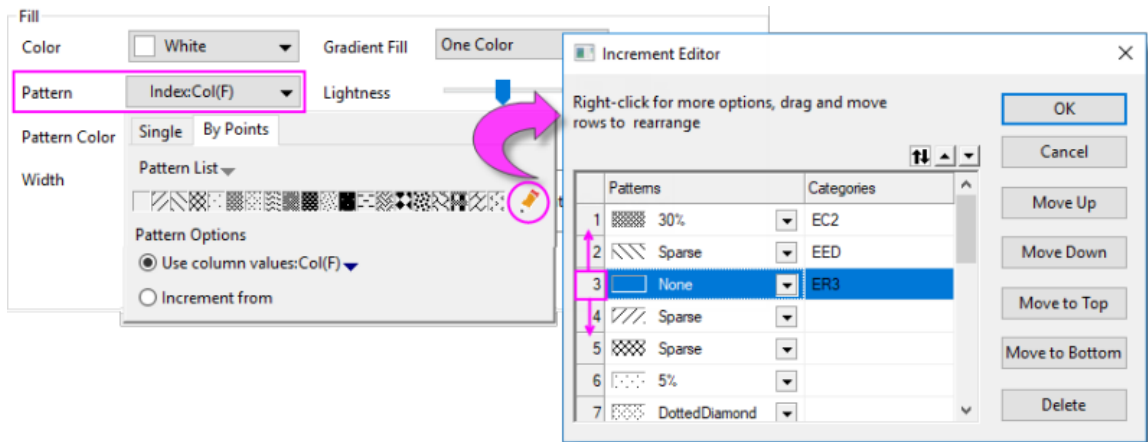

- To remove negative error bars, select the error bar plot in the left panel of **Plot Details**, (The second dataset under **Layer1**), then go to the **Error Bar** tab and clear the **Minus** check box.

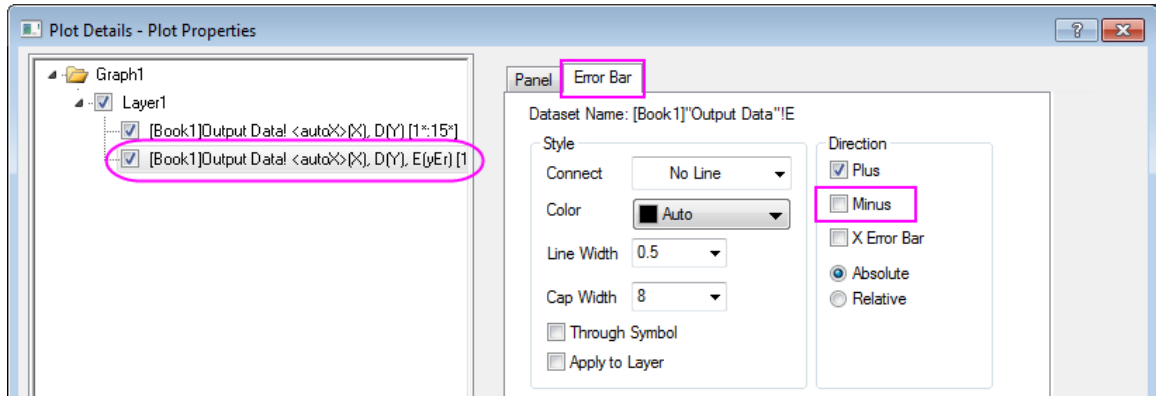

- To change the graph page background color, select the **Graph** icon in the left panel of the **Plot Details** dialog box. Go to the **Display** tab and set color to **LT Gray**.

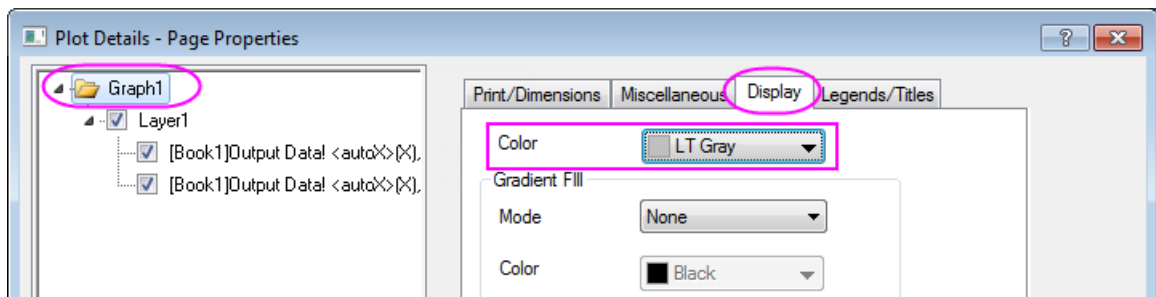

- To change layer background color to white, select **Layer1** node on left panel of the **Plot Details** dialog. Go to the **Background** tab and set **Color** to **White**. Click **OK** to close Plot Details.

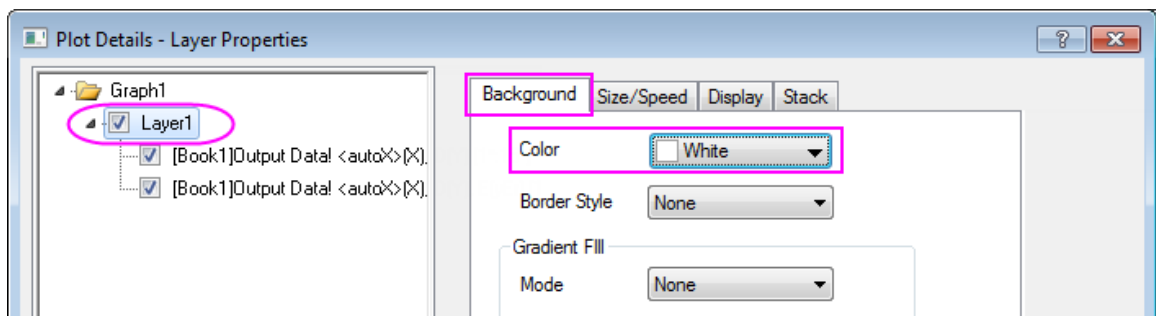

- To show pattern information in the legend, right click the legend and choose **Legend: Categorical Values**. Check the **Fill Pattern** and **Show All Categories** boxes and click **OK**.
- To arrange the legend horizontally, select the legend, press the CTRL key and drag one of the green handles along the sides of the legend until the legend entries are arranged in a horizontal fashion.

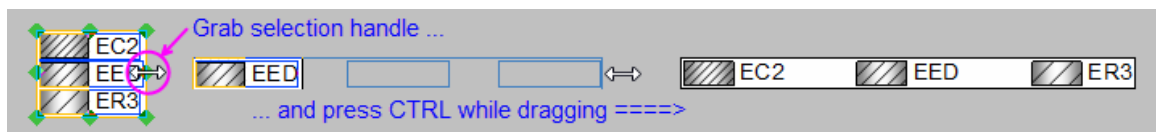

14. Drag the legend to an appropriate position. Select and press **Delete** to remove the Y axis title.

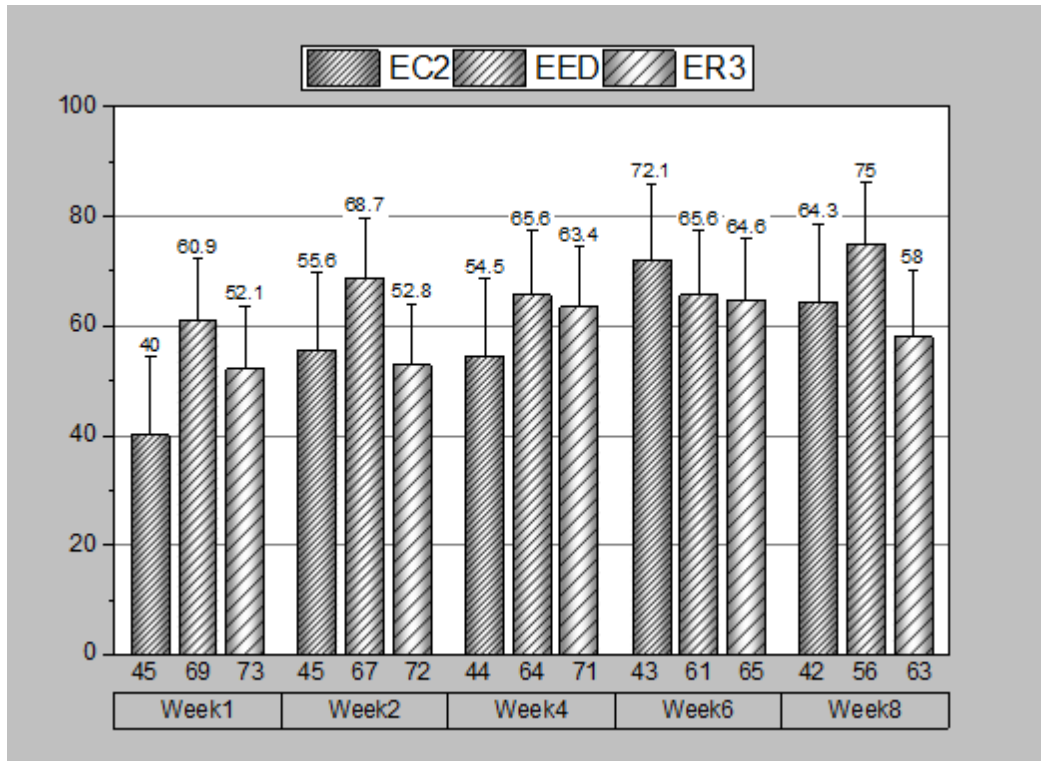

To center and adjust margins on a finished graph, click on the graph to activate it, then choose **Graph: Fit Layers to Page**. Enter your **Margin** and determine whether to **Maintain Layer Aspect Ratios**, then click **OK**.

## 6.8.9 Grouped Stacked Column

### 6.8.9.1 Summary

In Origin, multiple datasets can be plotted as a stacked column graph. Usually these datasets are grouped together by default. In addition, subgrouping is possible for stacked column graphs such as the one shown

below with 2 subgroups:

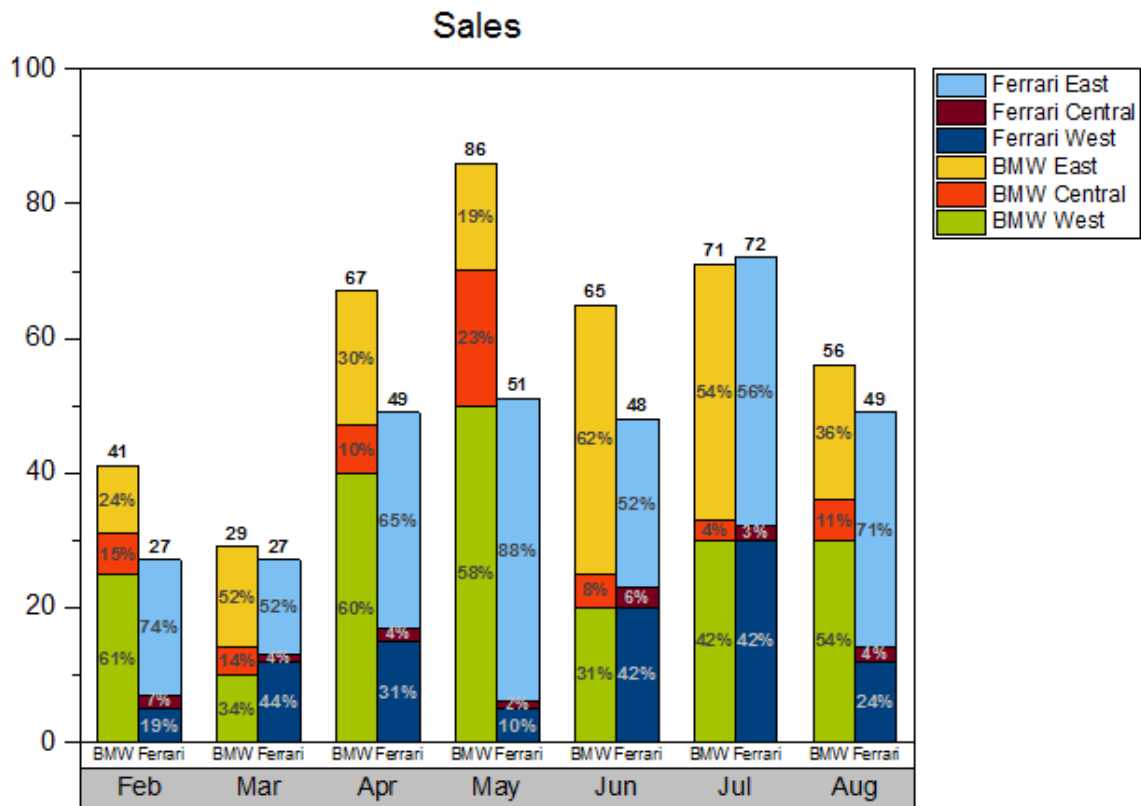

Minimum Origin Version Required: 2017 SR0

### 6.8.9.2 What will you learn

This tutorial will show you how to:

- Plot a stacked column graph
- Subgroup the stacked column
- Create and customize an X axis table for the graph

### 6.8.9.3 Steps to Create a Grouped Stacked Column Plot

This tutorial is associated with the *Grouped Stacked Column* folder in the project <Origin EXE Folder>\Samples\Tutorial Data.opj.

**Note:** You can also access this sample graph by double-clicking on its thumbnail under the *Column and Bar* graph sample in the **Learning Center** dialog (**Help: Learning Center** menu or press **F11**).

1. Activate the worksheet **Sheet1**, highlight col(B)~col(G) and select **Plot > Basic 2D: Stacked Column** from the menu to create a stacked column graph:

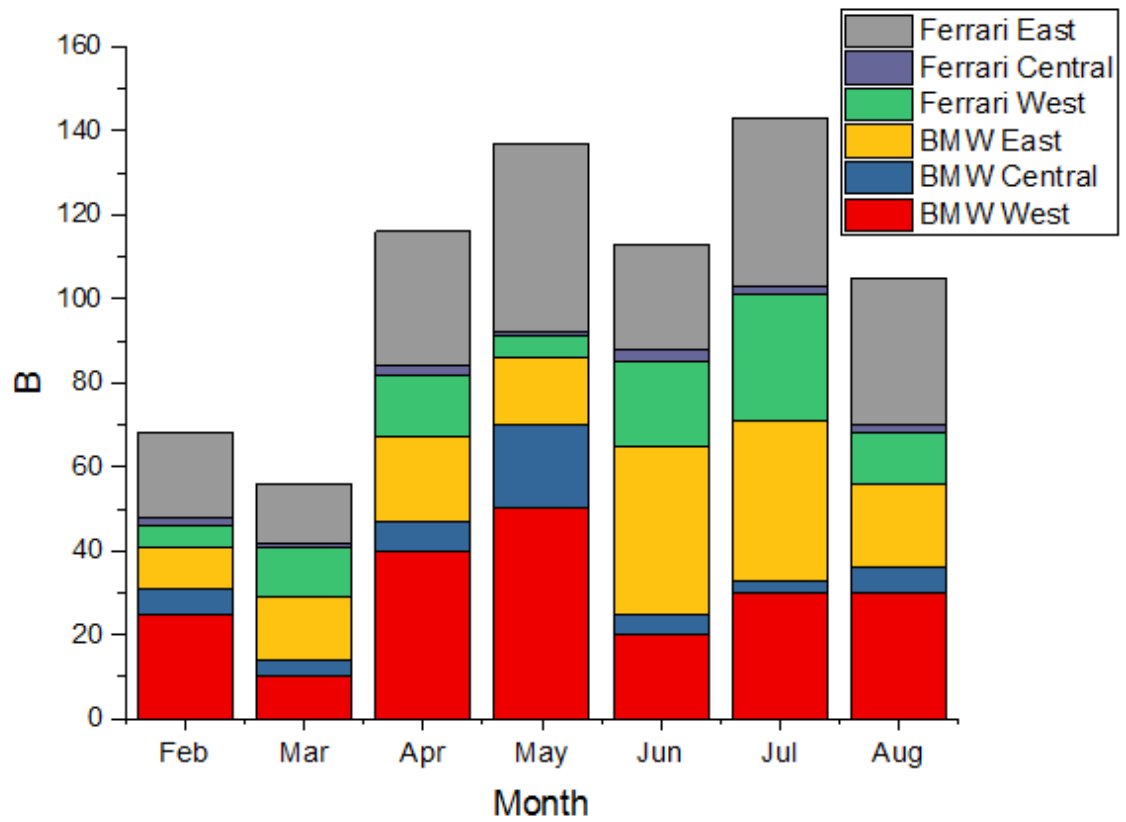

2. Double-click on the column plot to open the **Plot Details** dialog. On the **Group** tab, select **By Size** for **Enable subgroup** and set **Subgroup Size** to **3**.

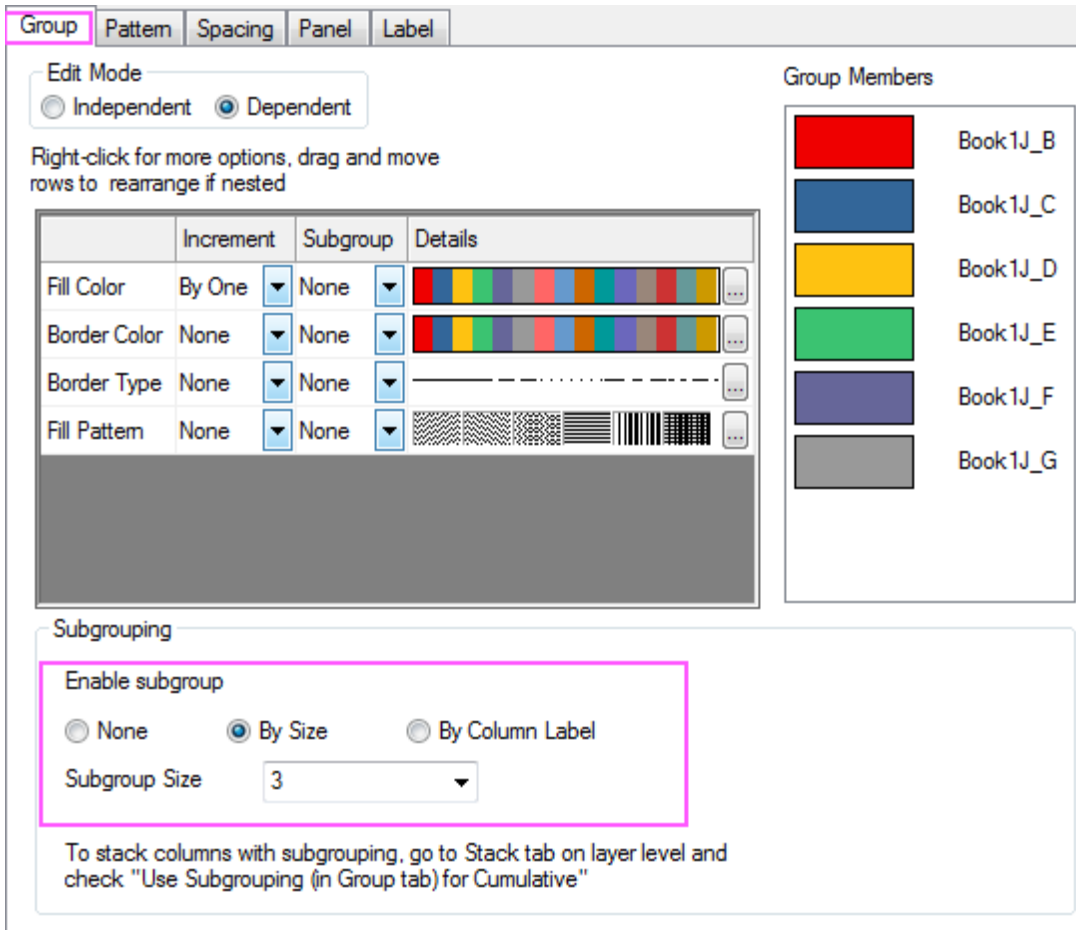

3. On the **Label** tab, check the **Enable** checkbox.

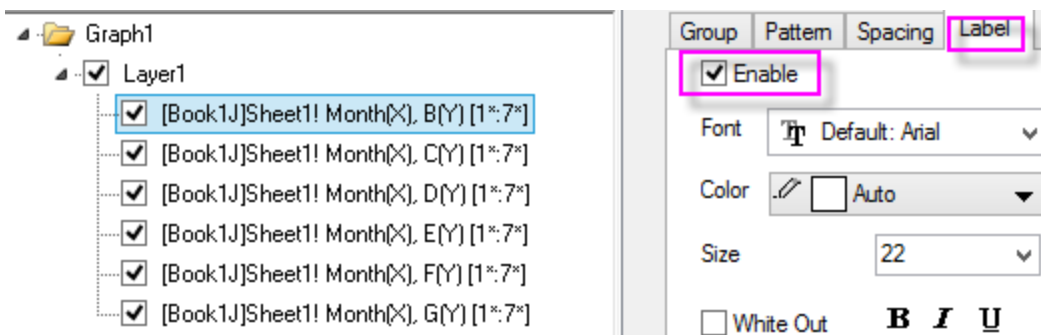

4. Select **Layer1** in left panel of **Plot Details** dialog and click the **Stack** tab. Check the **Use Subgrouping (in Group tab) for Cumulative/Incremental** check box. Click the **Apply** button.

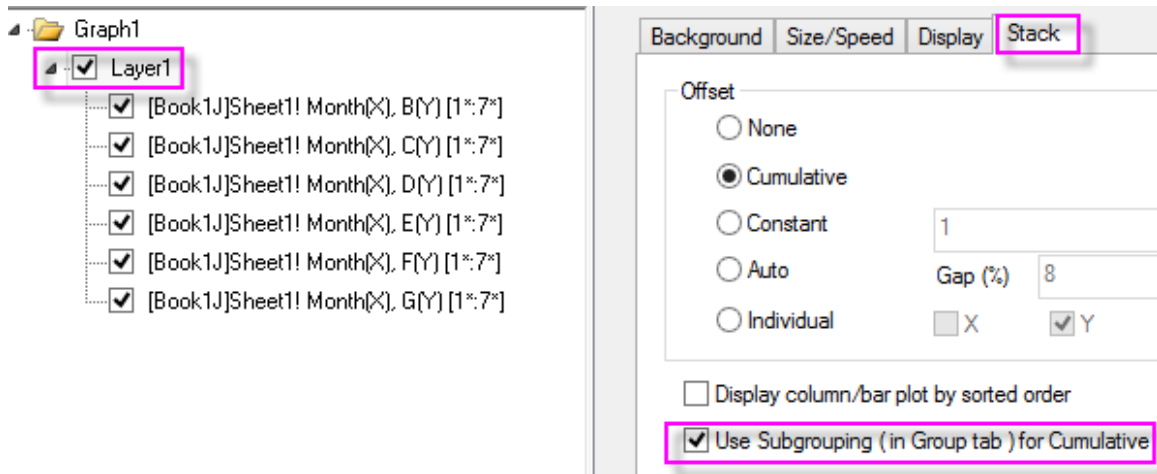

5. Click **OK** to close the dialog. Select **Graph: Rescale to Show All** from the main menu.

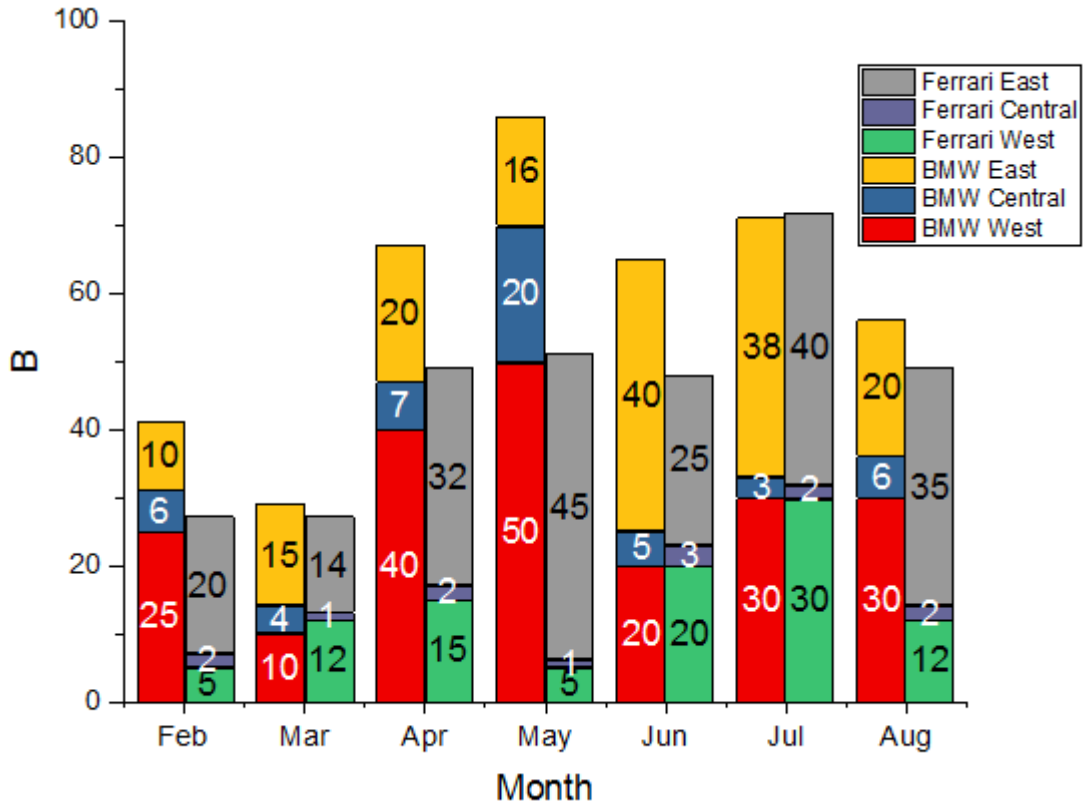

#### 6.8.9.4 Steps to Create a Tick Label Table for X Axis

1. To create two rows of tick labels for the X axis, double-click on the X axis tick labels to open the **Axis** dialog.
  - o Go to **Bottom** icon with **Tick Labels** tab selected.
  - o Under **Format** tab, change **Font Size** to **16**



- Under **Table** tab, check the **Enable** checkbox and set **Number of Rows** to **2**. **Bottom** icon will change into **Bottom 1** and **Bottom 2** on the left panel.
- Set the Table layout as shown below:

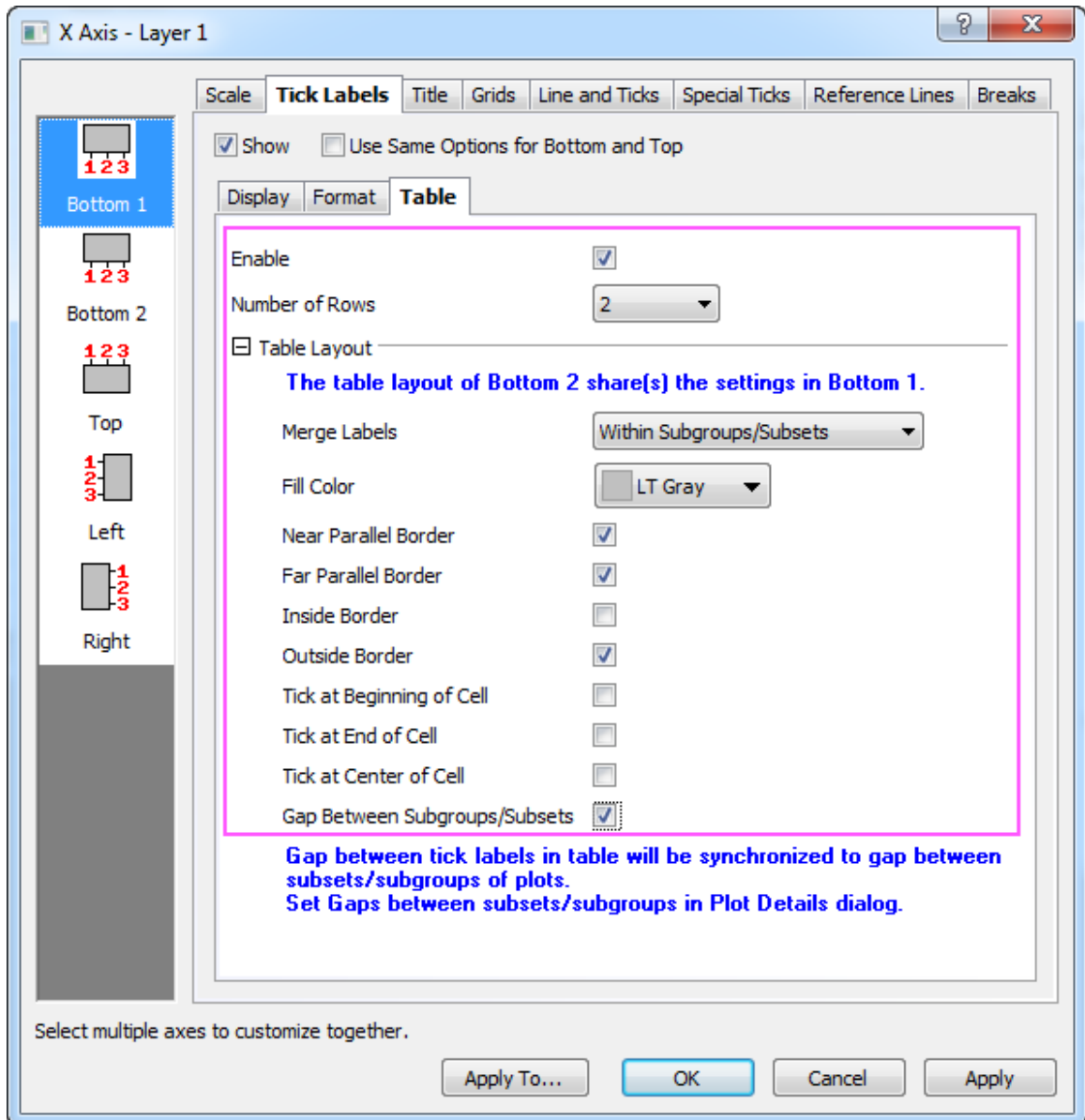

- Select the **Bottom 2** icon and set **Dataset Name** to `[Book1]Sheet1!label` in Display tab, and set the Font size to 10 in the **Format** tab. This will change the tick label row to the car names from the worksheet **label (Y)** column.
- Set the table layout as the dialog below:

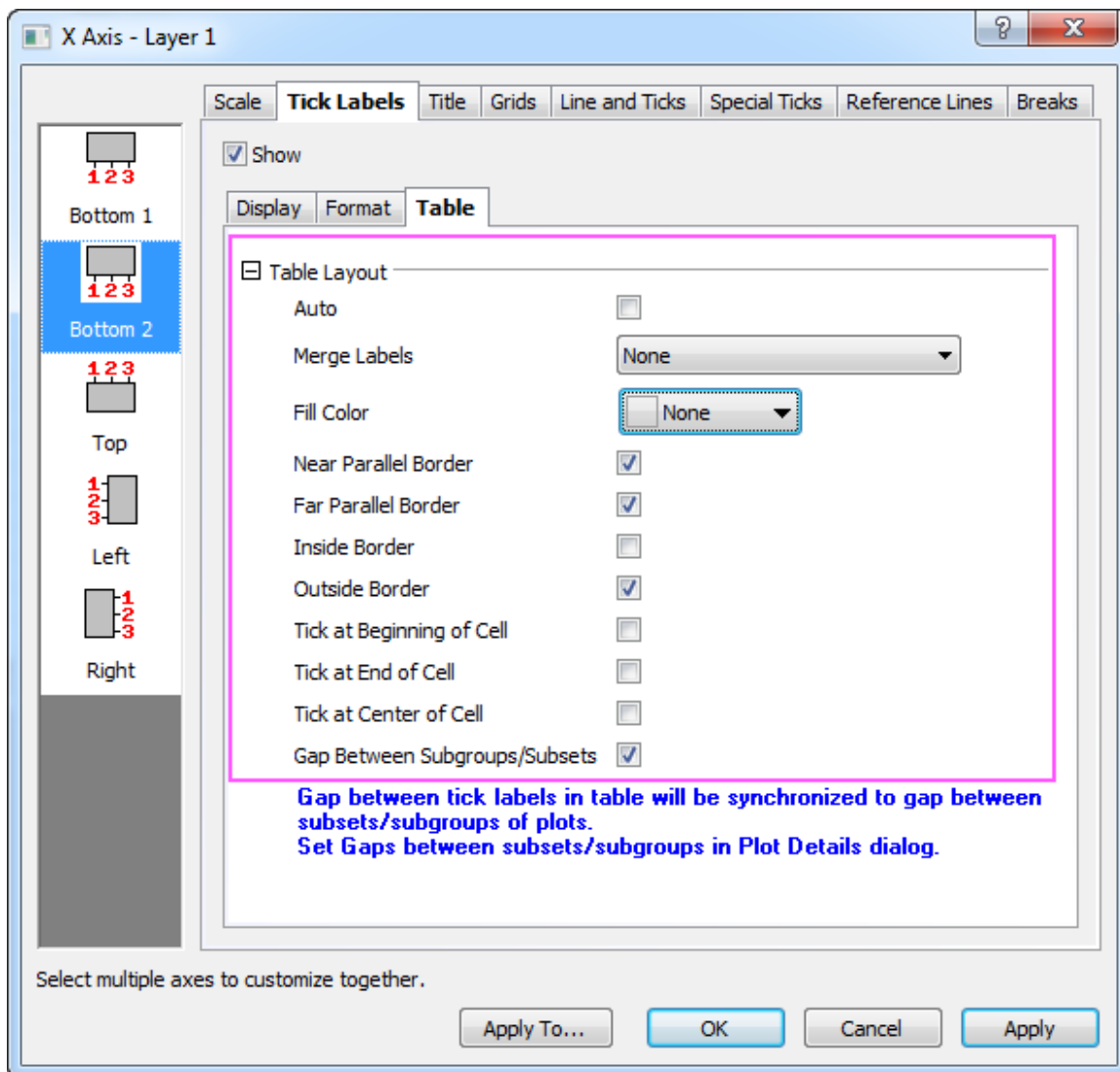

- To show a frame around the layer, select the **Grids** tab, Check on the **Opposite** check box under the **Additional Lines** branch and click **OK** button for both **Horizontal** and **Vertical** icons.

#### 6.8.9.5 More Customization Steps

The following steps can further customize the graph to be exactly the same as the image in **Summary**.

1. Double-click on the column plot to open the **Plot Details** dialog. On **Group** tab, click the  button in the **'Details** column of the **Fill Color** row. **Increment Editor** opens.
2. Click on the arrow to the right of the first color, then click on an empty color well under **Custom**. In the **Color** dialog that opens, set the **Red, Green** and **Blue** values to **165, 196** and **0**, then click **OK**.
3. Create five more custom colors using these RGB values: **(243, 62, 12)**, **(243, 200, 30)**, **(0, 64, 127)** **(119, 0, 31)**, and **(124, 191, 243)**.

- Click the number (7) to left of the next color in the Increment Editor list, then scroll to the bottom of the list, press **Shift** then click on the number to the left of the last color. Click **Delete** to remove the selected colors so that you have just the six custom colors that you just created. Click **OK** to close the Increment Editor.

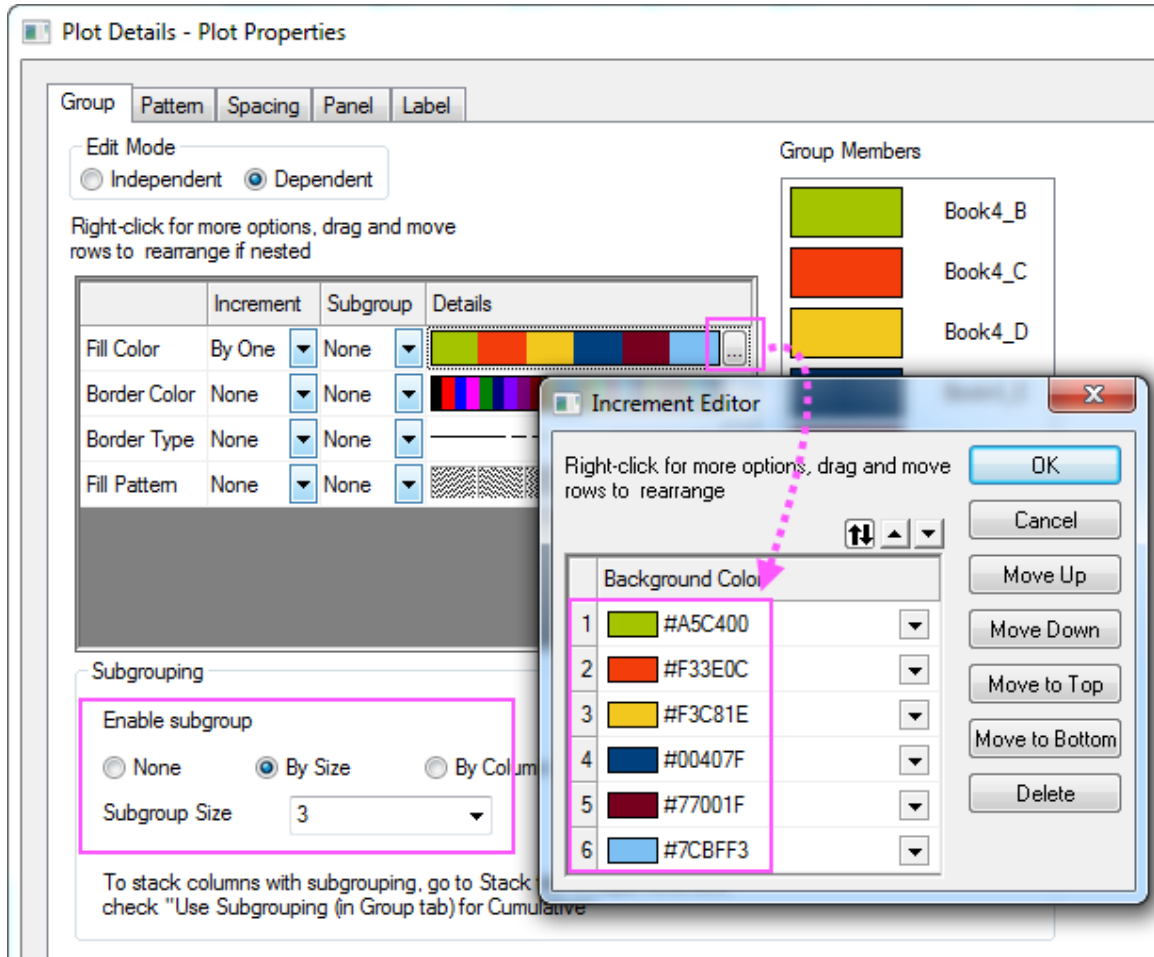

- On the **Label** tab, set **Size** to **12**, **Color** to **Dark Gray** and click on the **Bold** button. Choose **Custom** as **Label Form** and enter **\$(p,0)%** in **Format String** box. This adjusts the labels on the columns.

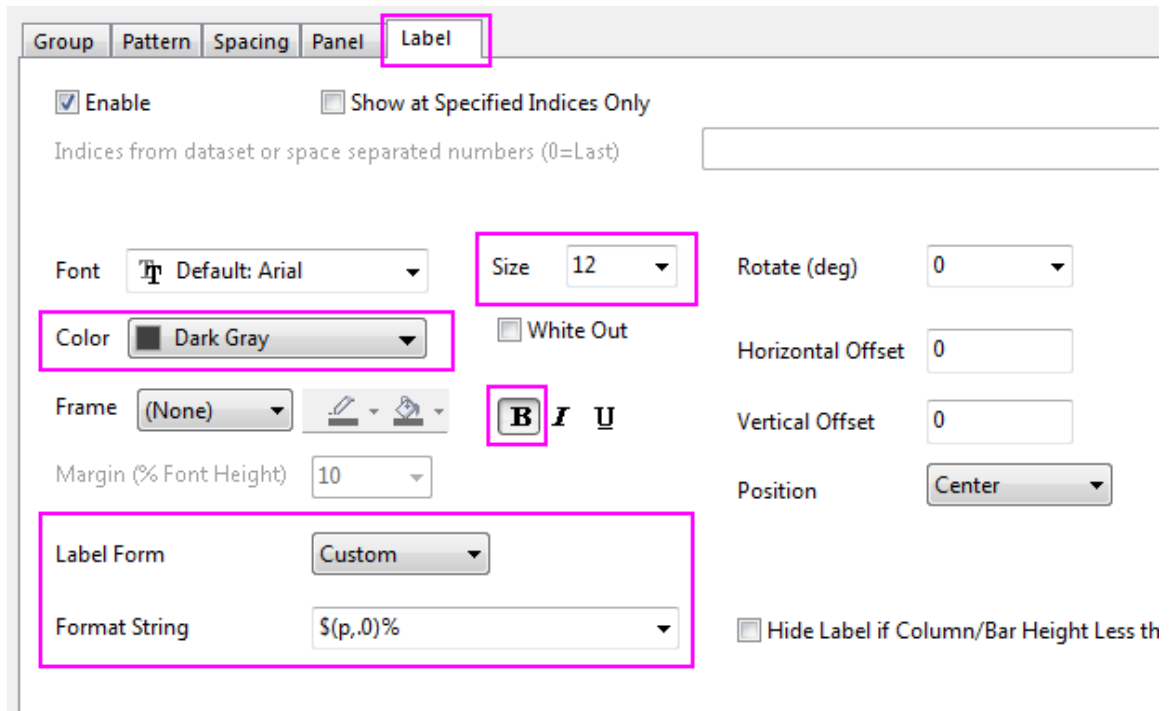

6. Click the **Spacing** tab and increase the **Gap Between Bars(in %)** to **30**.



7. Select **Layer1** in left panel of **Plot Details** dialog and click the **Stack** tab. Check the **Show Total Label on Stacked Column/Bar**.

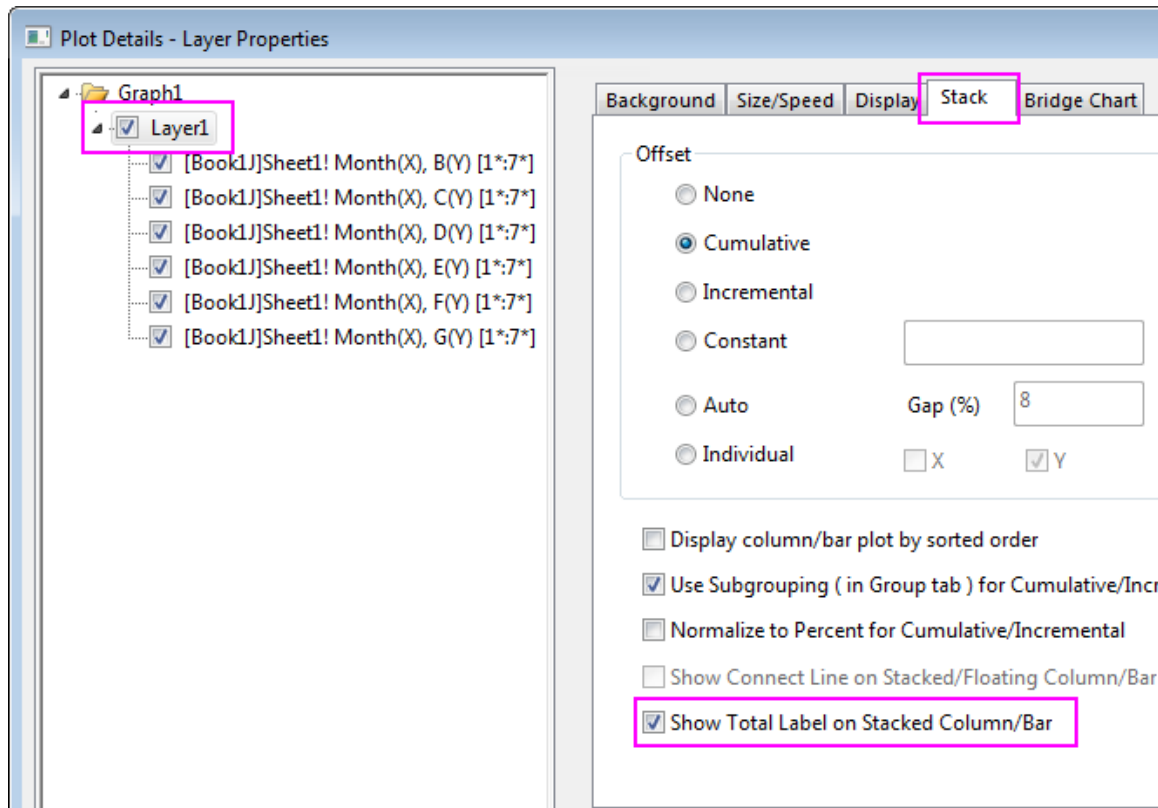

8. On the **Group** tab, change **Edit Mode** to **Independent**.
9. Select the 4th plot in the left panel and click on the **Label** tab. Set **Color** to **LT Gray**. Click **Apply** button.
10. Select the 5th plot in the left panel, and on the **Label** tab change **Color** to **LT Gray** and **Size** to **11**. Click **OK** to close the dialog.
11. Select and delete the X and Y axis titles.
12. Right-click on an empty portion of the graph window and select **Add/Modify Layer Title** from the context menu. Type **Sales** as a layer title.
13. Select and drag the legend box to an appropriate position. Resize as needed, using the green selection handles.

## 6.8.10 Stack Column Plot with Different Positive and Negative Y Scale

### 6.8.10.1 Summary

We will show how you can use axis break without a gap to produce this graph, that has much larger Y scale range for the negative bars.

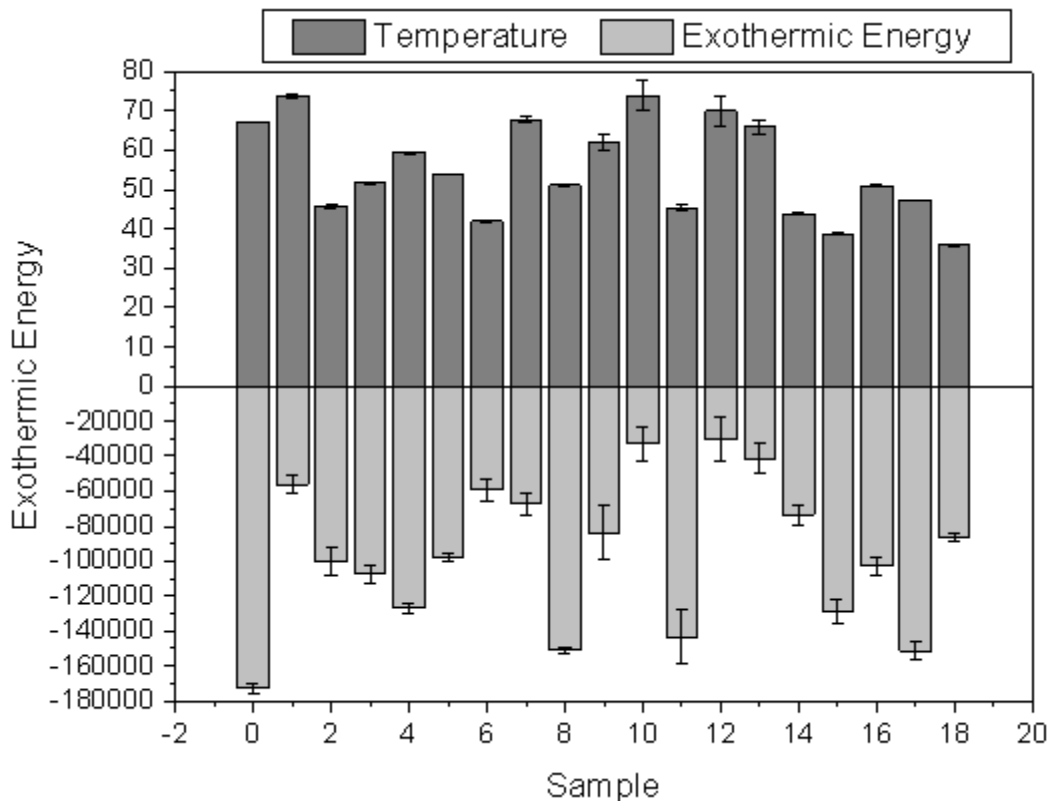

Minimum Origin Version Required: 2015 SR0

### 6.8.10.2 What You Will Learn

This tutorial will show you how to:

- create a stacked column plot with error bars.
- enable an axis break without a gap.
- divide one axis into several segments and set scales separately.

### 6.8.10.3 Steps to Add Axis Break with No Gap

This tutorial is associated with <Origin EXE Folder>\Samples\Tutorial Data.opj.

Also, you can see this graph in **Origin Central**(Select *Help: Origin Central* menu or press **F11** key). It is listed under the **Column and Bar Charts** sample graph table. Double-clicking on the thumbnail will open the target folder.

1. Open **Tutorial Data.opj** and browse to the *Custom Axis Scale to Show Different Scale* folder in **Project Explorer** and activate the workbook **sample**.

- select all the columns and choose **Plot > Basic 2D :Stacked Column** to create a stacked column plot with error bars.

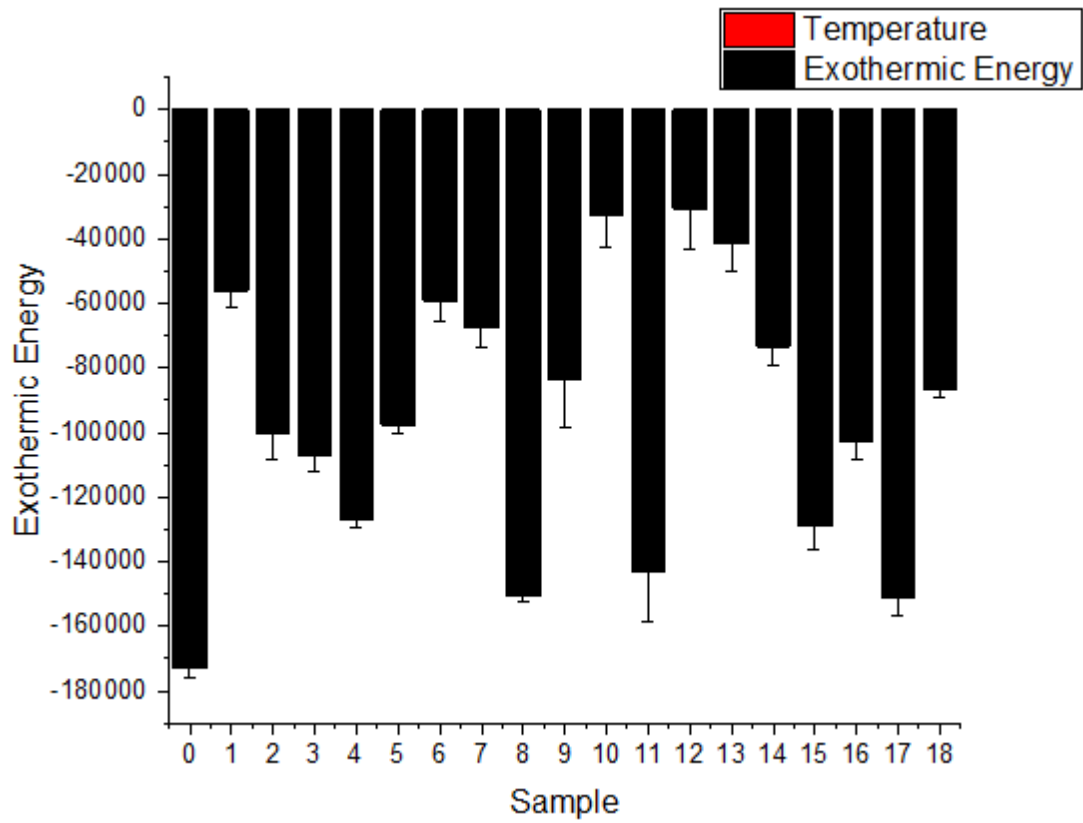

- Positive columns cannot be seen since their absolute values are too small comparing to those of negative columns.

- We can break the Y axis at Y=0 and use different axis scale for those two segments. First double click on the Y axis to open the **Axis** dialog and set Y Range (in **Vertical** icon) to be from -180000 to 80

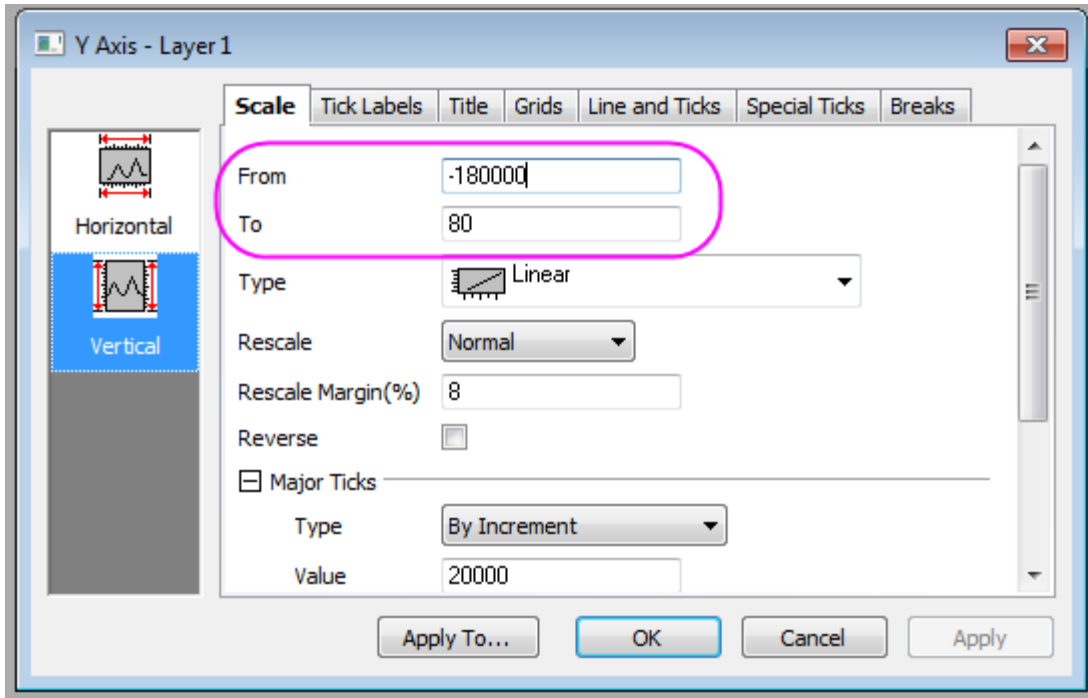

- Then go to the **Breaks** tab with **Vertical** icon active, and enable 1 axis break. Also set the Break Half Length to 0 so the break indicator will not show. Set both the **Break From** and the **Break To** to 0 so the axis will break at 0 and no break gap shows. Uncheck **Auto Position** and enter 50 for the **Position** cell.

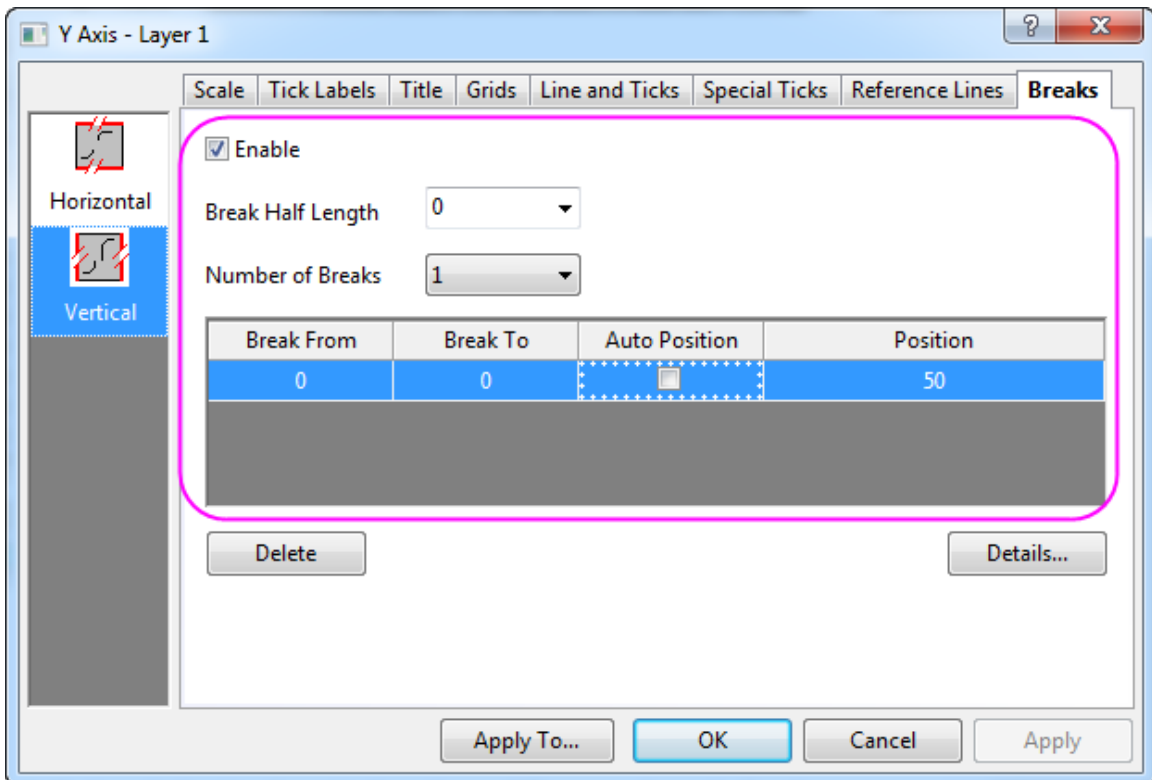



6. Set Custom Scale for the region after break ( $Y > 0$ ) by clicking **Details**:

The screenshot shows the 'Breaks Details' dialog box with the 'Scale After Break' tab selected. The 'Breaks' list on the left contains 'Break 1'. The 'Scale After Break' section is highlighted with a pink box and contains the following settings:

- Axis From is -180000**
- Break From: 0
- Break To: 0
- Axis To is 80**
- Position (% of Axis Length): 50  Auto
- Auto Scale:
- Scale Type: Linear
- Major Ticks
  - Type: By Counts
  - Count: 0
  - First Tick:
- Minor Ticks
  - Type: By Counts
  - Count: 1

At the bottom of the dialog, there are buttons for 'Add', 'Delete', 'OK', 'Cancel', and 'Apply'. The text 'Select multiple breaks to customize together' is located above the 'Add' and 'Delete' buttons.

7. Click **Apply** to apply the settings and view the updated graph, you can see the axis scales are different for the regions above or below the  $Y=0$  line and the columns for positive values can also be seen in the

graph.

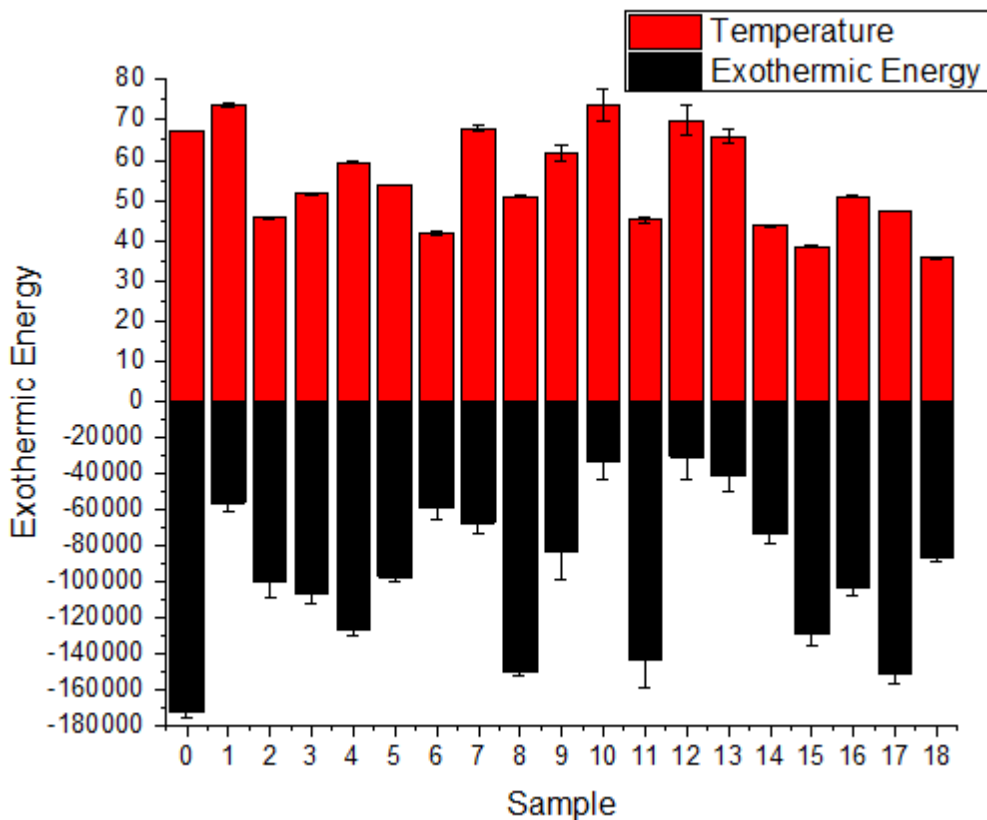

#### 6.8.10.4 More Customization Steps

The following steps can further customize the graph to be exactly the same as the image in Summary.

1. Set the X scale to be from -2 to 20, *Major tick* by increment 2.
2. Go to the **Grids** tab and select both **Vertical** and **Horizontal** icons, select the **Opposite** check box so the grid lines opposite to both X and Y axes will show.

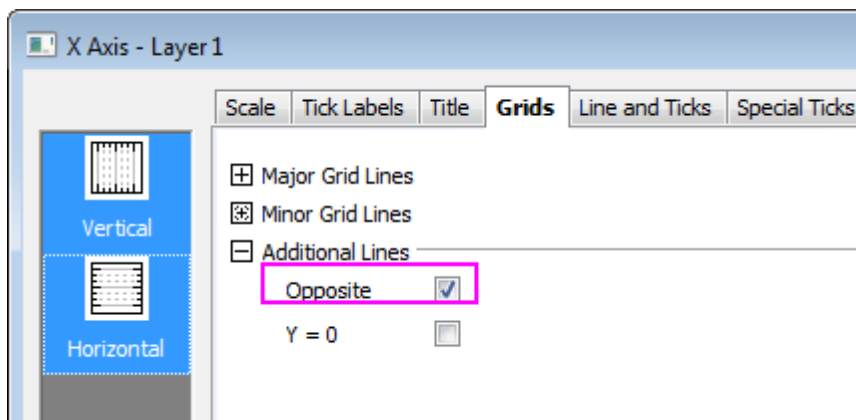

3. Click **OK** to apply the settings and close the **Axis** dialog.

- To change the positive and negative column colors to light gray and gray, double click on the columns to open the **Plot Details** dialog to make the changes shown below

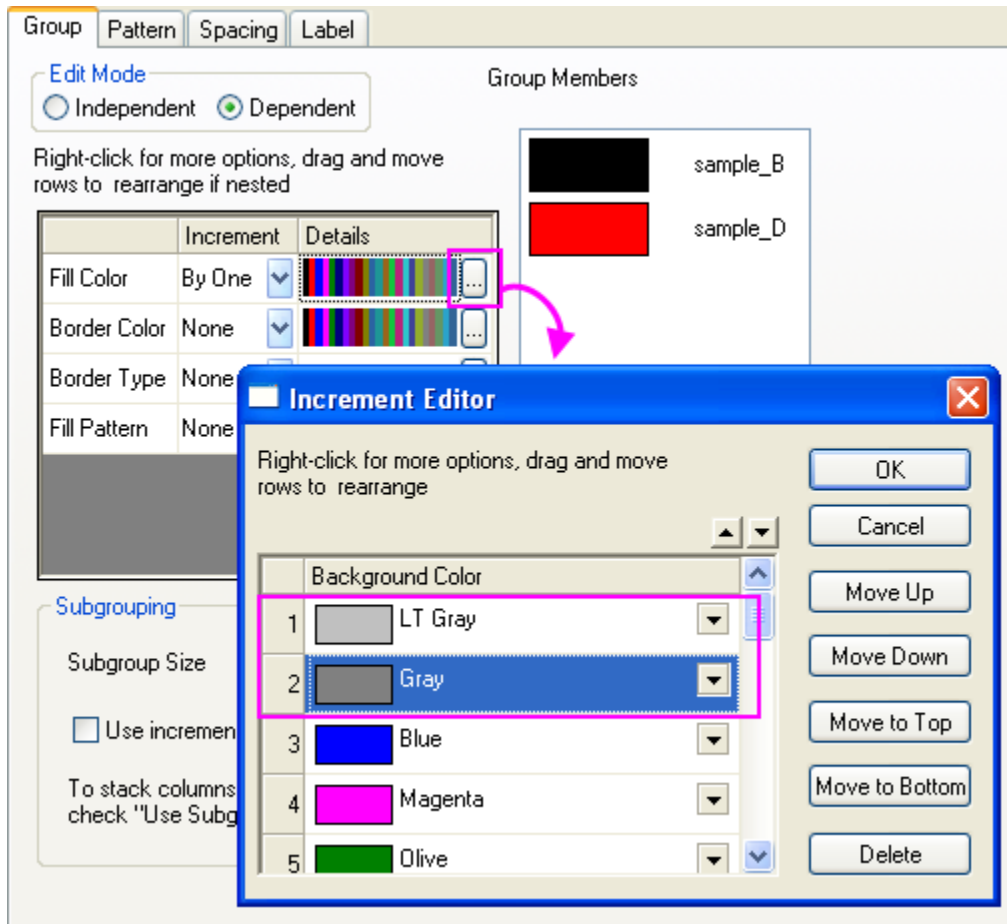

- To customize the legend, right click on the legend object and select **Properties** to open the **Object Properties** dialog, arrange the two legend entries to be in the same row as below and click **OK**

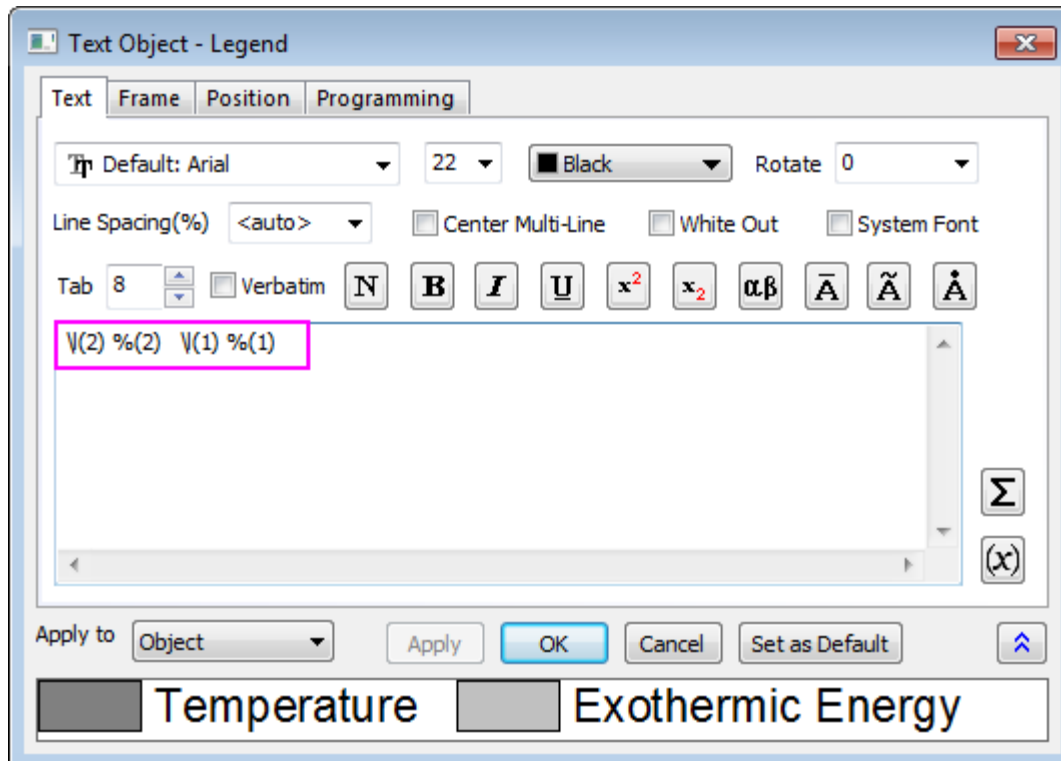

- Move the legend to be above the graph.

## 6.8.11 Variable Column Width

### 6.8.11.1 Summary

Origin allows you to specify a dataset to control column/bar width. When the Scaling Factor is 0, the dataset values determine bar width in terms of X axis scale values.

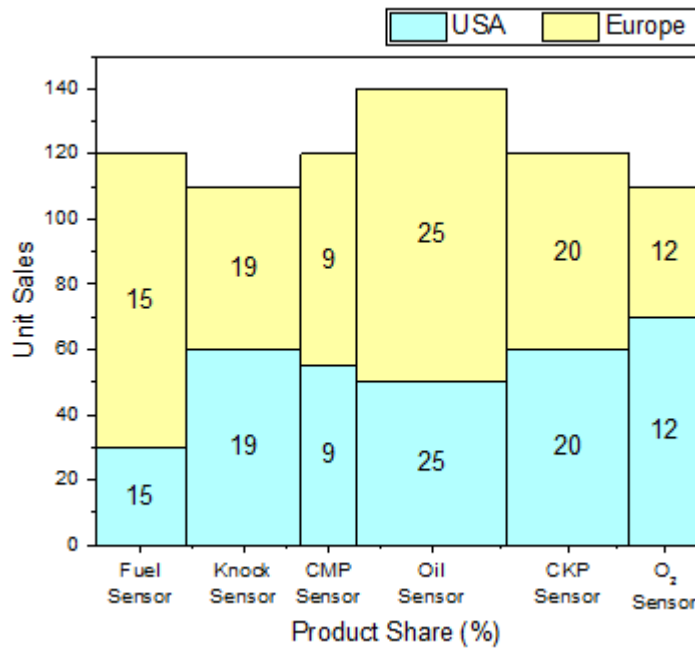

Minimum Origin Version Required: Origin 2015 SR0

#### 6.8.11.2 What will you learn

This tutorial will show you how to

- Plot a stack column graph
- Set the width of column with a variable
- Customize the axis ticks and tick labels

#### 6.8.11.3 Steps

This tutorial is associated with the Tutorial Data project: <Origin EXE Folder>\Samples\Tutorial Data.opj.

1. Open the Tutorial Data project and browse to folder *Variable Column Width* in **Project Explorer**.
2. Activate the workbook **Book3A**, highlight col(F), col(A) and col(B) and select **Plot > Basic 2D : Stacked Column** from menu to plot a stacked column.

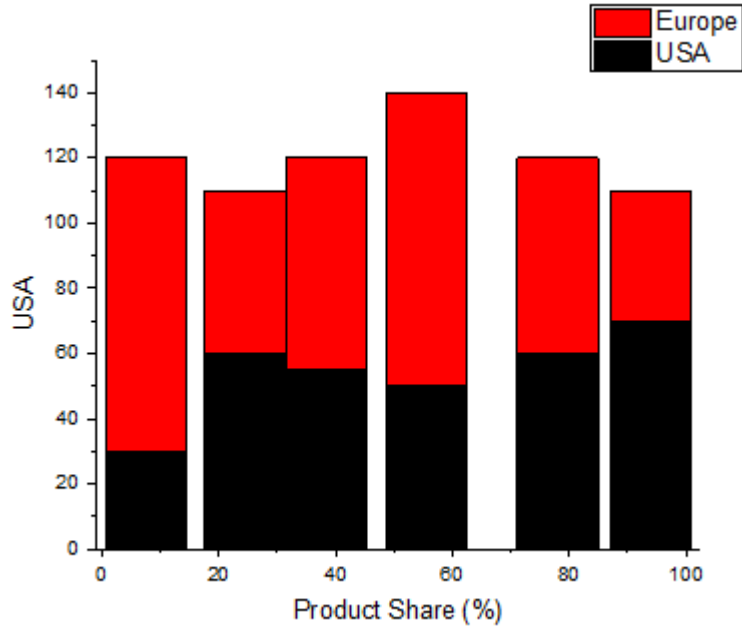

3. Double-click on the plot to open the **Plot Details** dialog. Click the **Group** tab then click the button  to open the **Increment Editor**. Select two custom colors as **Fill Color**.

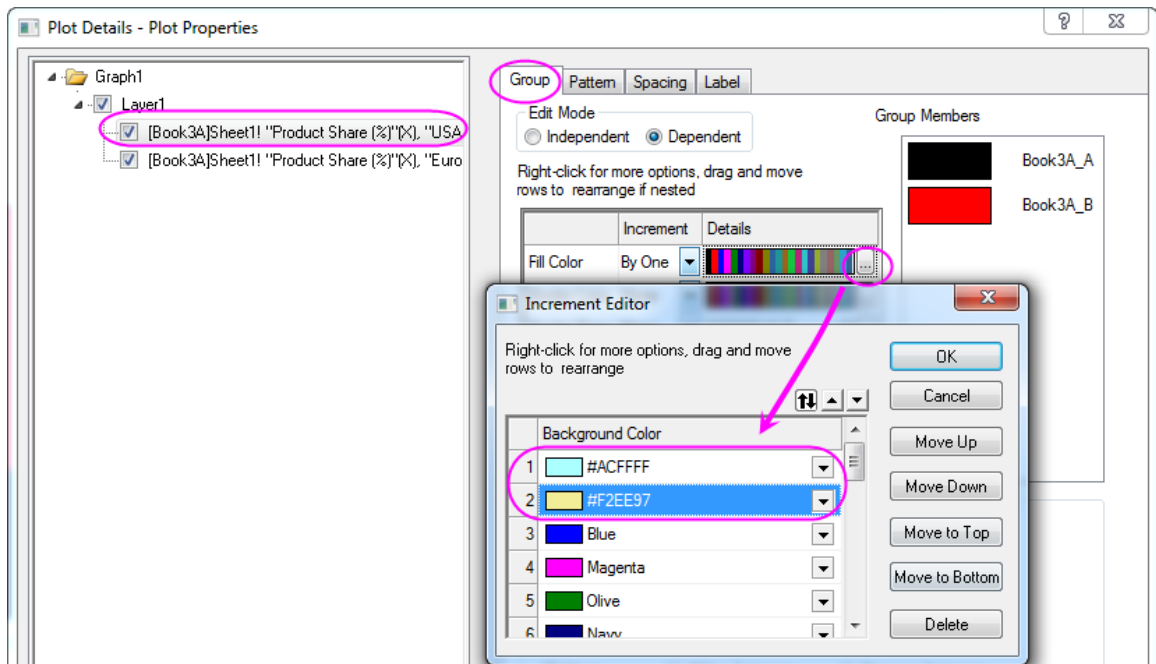

4. Go to the **Spacing** tab, select *Col(C): "w"* as **Width (in %)** and set **Scaling Factor** to 0. After clicking Apply, it will be displayed as '<0=Use X Unit>'.

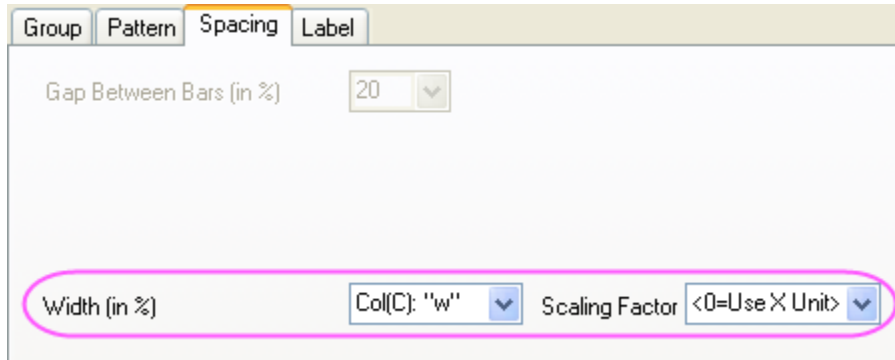

5. Go to the **Label** tab, set **Position** to *Center* and select *Col(C): "w"* from the **Label Form** drop-down list.

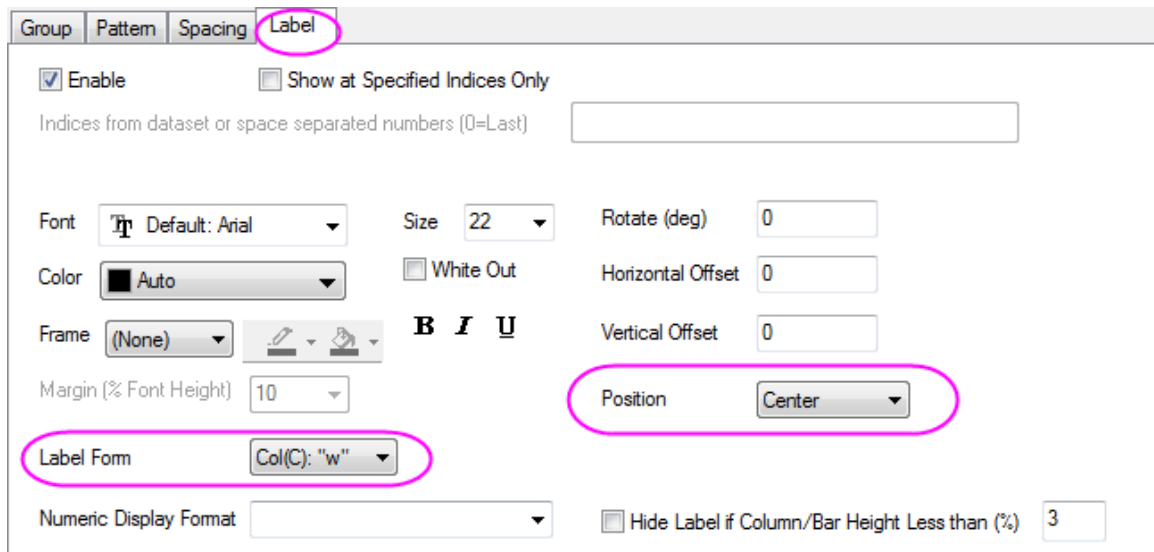

6. Click **OK** to close the dialog. Double-click on the X Axis to open the **Axis** dialog.
- o Select **Horizontal** icon in the **Scale** tab, select **By Custom Positions** for **Type** and *[Book3A]Sheet1!F"Product Share (%)"* for **Position**.

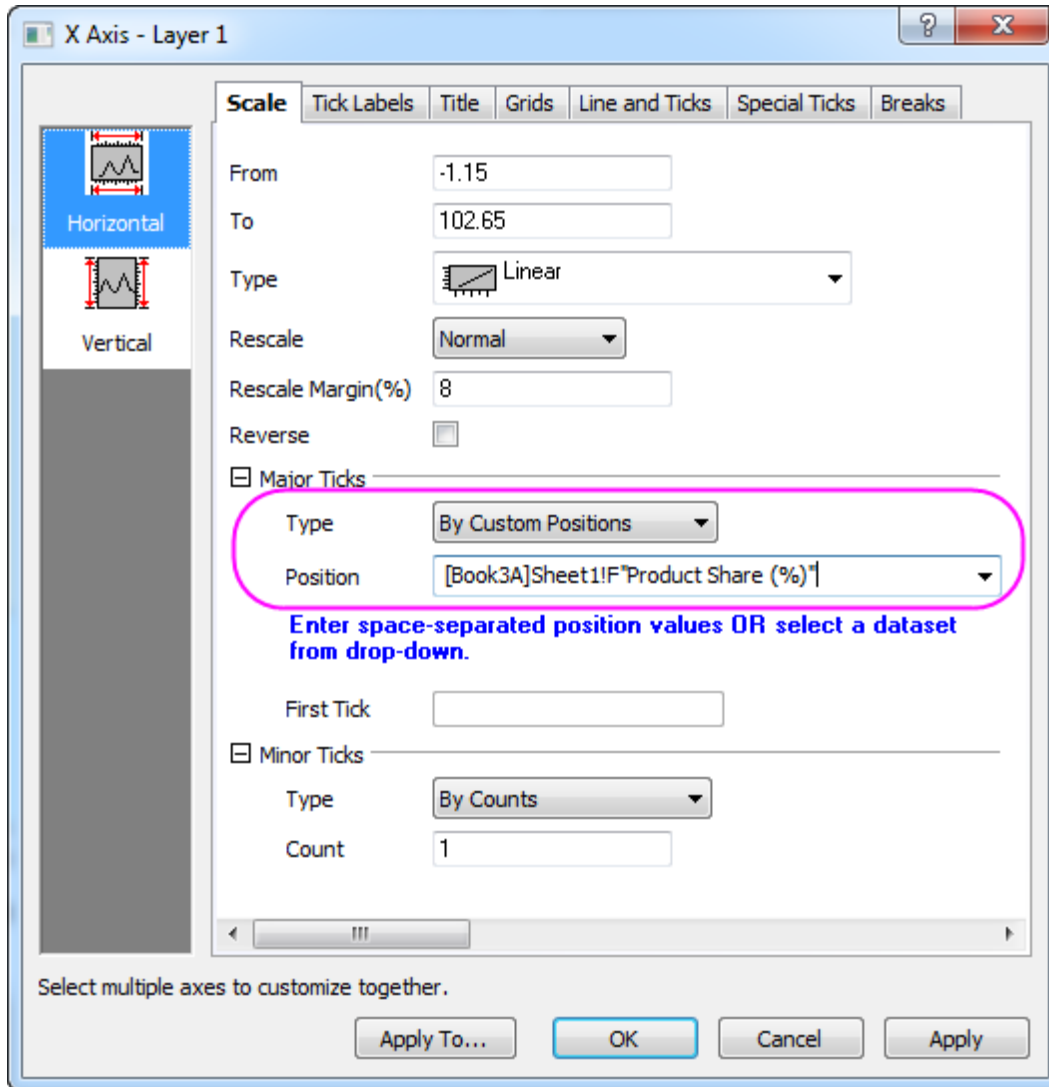

- Go to **Bottom** page in **Tick Labels** branch, set **Type** to **Tick-indexed dataset** and **Dataset Name** to `[Book3A]Sheet1!D"Item"`.



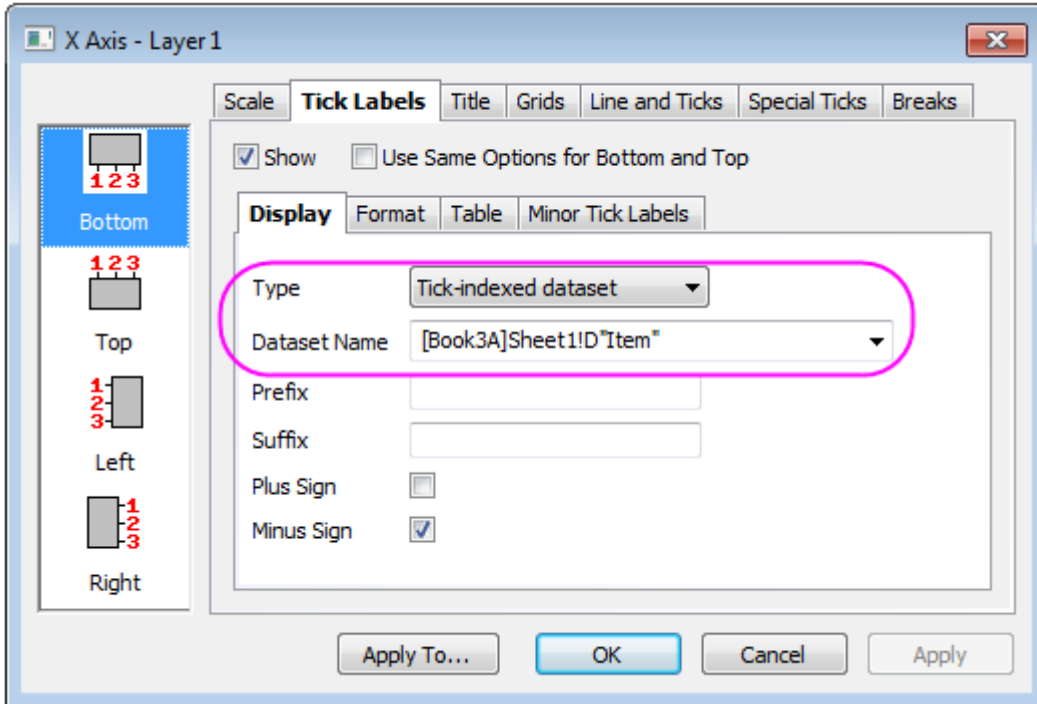

- Go to the **Grids** tab and check the **Opposite** check box under the **Additional Lines** branch for both **Vertical** and **Horizontal**
  - Click **OK** to close the dialog.
7. Double-click on the Y axis title and change it to **Unit Sales**. Right-click the legend box and select **Properties...** from fly-out menu. Edit the legend to display on one line. The graph should look like the following:

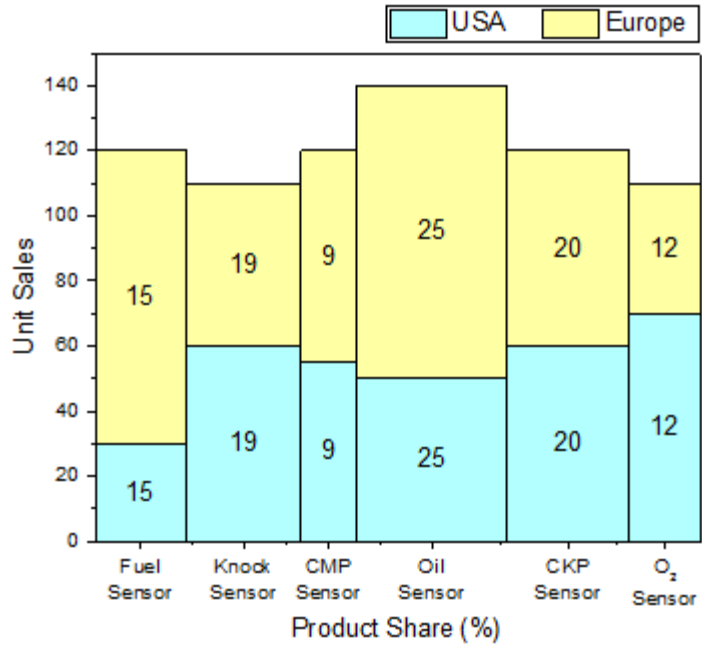

### 6.8.12 Stack Column and Bar Charts of Rechargeable Battery Statistics

#### 6.8.12.1 Summary

This tutorial will show you how to create a Stack Column bar graph.

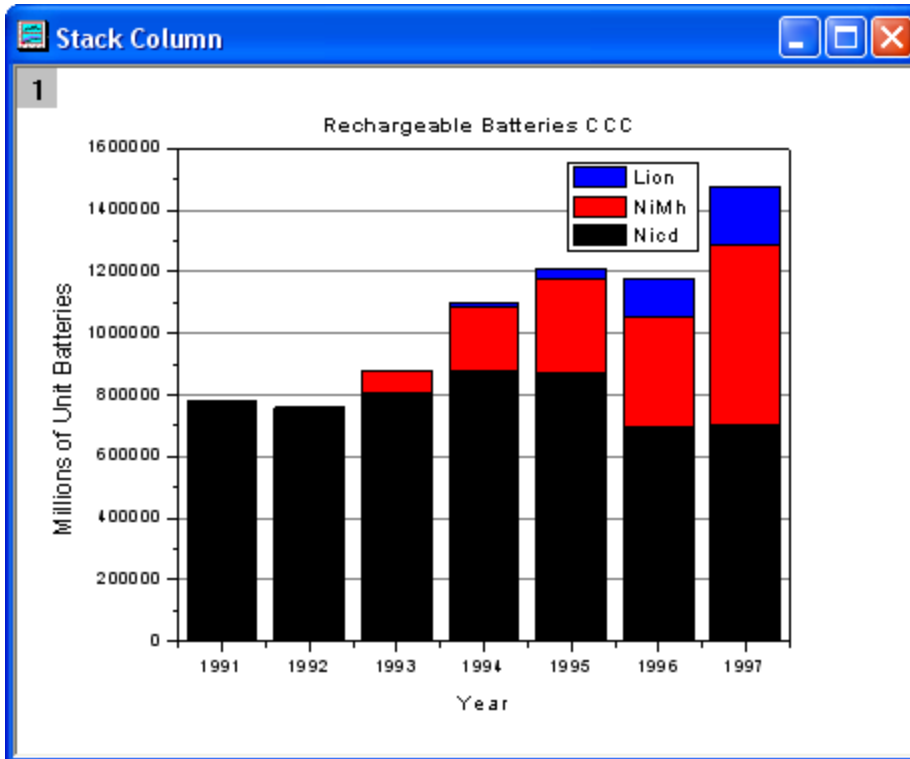

Minimum Origin Version Required: Origin 2015 SR0

### 6.8.12.2 What will you learn

This tutorial will show you how to

- Create a Stack Column bar graph.
- Customize the graph.

### 6.8.12.3 Steps

1. Create a new worksheet. Import [the sample data](#).

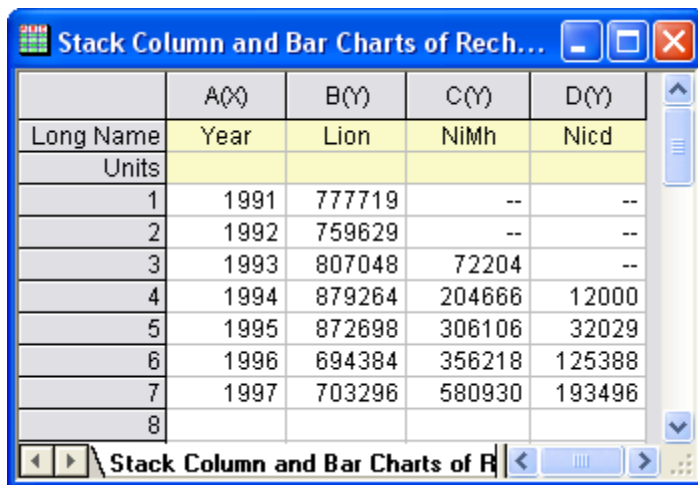

	A(Y)	B(Y)	C(Y)	D(Y)
Long Name	Year	Lion	NiMh	Nicd
Units				
1	1991	777719	--	--
2	1992	759629	--	--
3	1993	807048	72204	--
4	1994	879264	204666	12000
5	1995	872698	306106	32029
6	1996	694384	356218	125388
7	1997	703296	580930	193496
8				

2. Highlight all the columns and click the **Stack Columns** button on the **2D Graphs** toolbar.

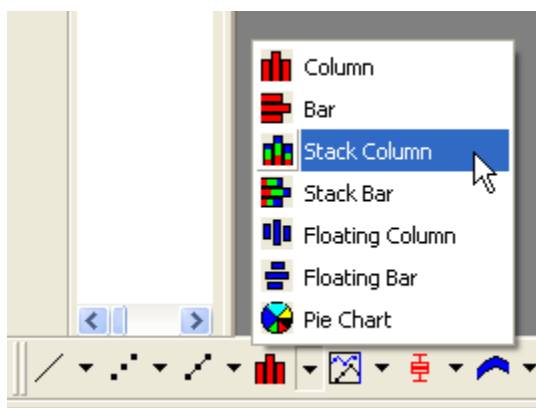

The graph should look like

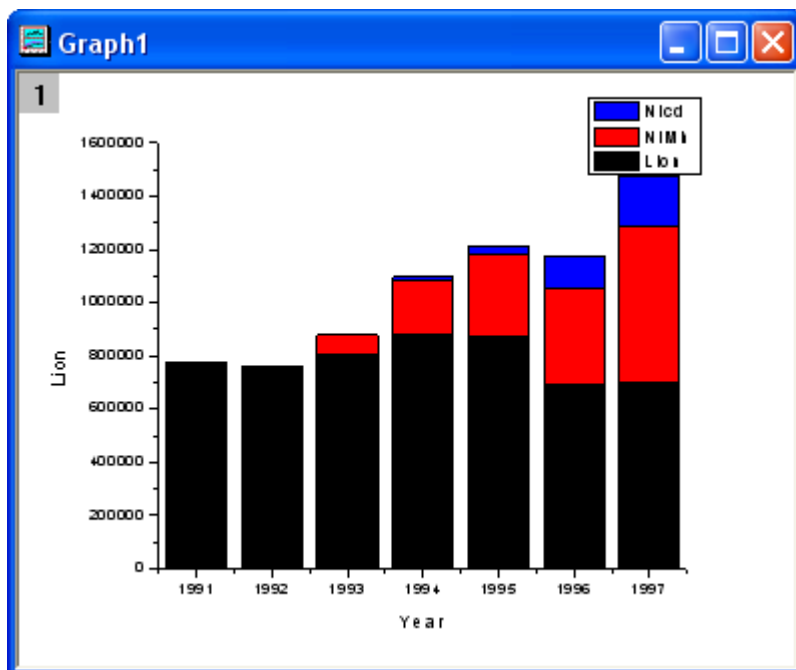

- Then apply a graph theme to add a top **X** axis and a right **Y** axis. Select **Preferences: Theme Organizer** to open the **Theme Organizer** dialog. Activate the **Graph** tab and select **Opposite Lines** from the table. Then click the **Apply Now** button. Click the **Close** button to close the dialog.

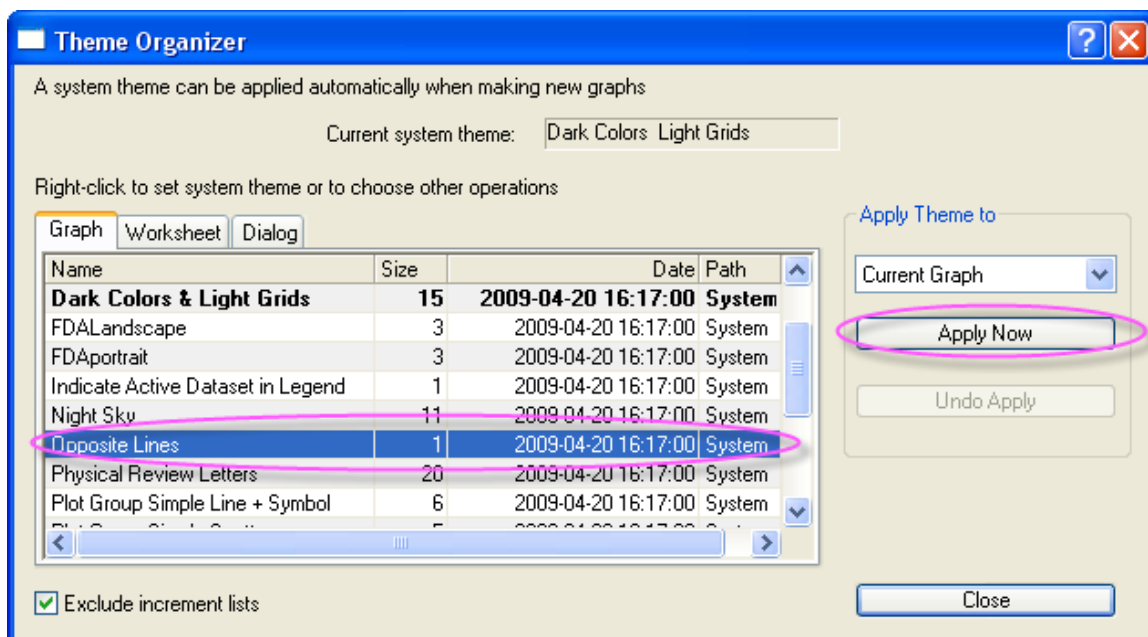

- Double-click on the **Y** axis to open the **Axis** dialog. Go to **Horizontal** icon in **Grids** tab, and check **Show** checkbox under the *Major Grid Lines* section. Click the **OK** button to add grid lines to the graph.

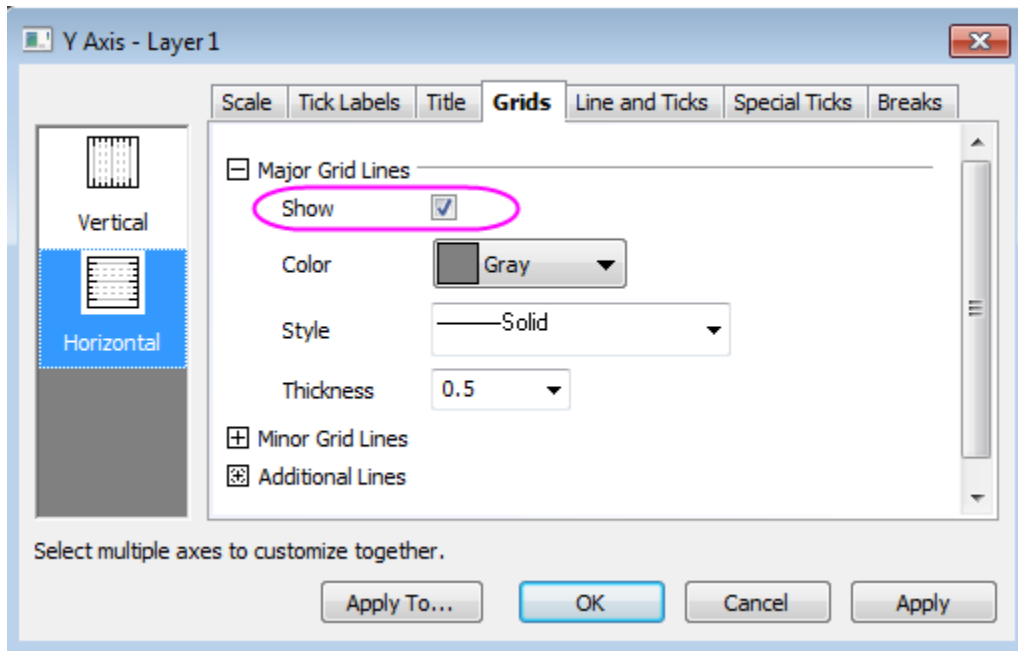

5. Go to the **Title** tab to change the title of Y axis to **Millions of Unit Batteries**. Then choose **Top** icon and add a graph title **Rechargeable Batteries CCC**. The graph should look like:

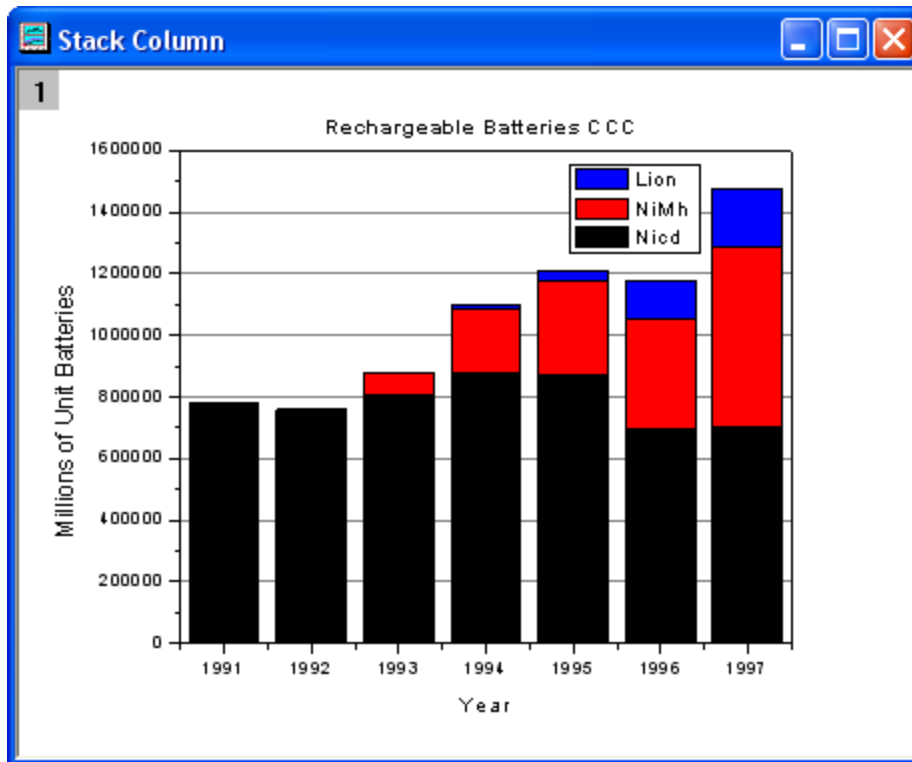

6.8.12.4 Sample Data

Download the **Stack\_Column\_and\_Bar\_Charts.txt** file from [http://www.originlab.com/ftp/graph\\_gallery/data/Stack\\_Column\\_and\\_Bar\\_Charts.txt](http://www.originlab.com/ftp/graph_gallery/data/Stack_Column_and_Bar_Charts.txt). Click the **Import**

**Single ASCII button**  and select the file to import it into Origin.

The following table contains part of the sample data.

year(X)	Nicd(Y)	NiMh(Y)	Lion(Y)
1991	777719	--	--
1992	759629	--	--
1993	807048	72204	--
1994	879264	204666	12000
1995	872698	306106	32029
1996	694384	356218	125388
1997	703296	580930	193496

## 6.9 Multi-Axis and Multi-Panel

### 6.9.1 Multi-Axis and Multi-Panel

- [Double Y](#)
- [3Ys Y-YY](#)
- [Stack Lines by Y Offsets](#)
- [Vertical 2 Panel Line](#)
- [Multiple Axis Plot](#)
- [Energy-Level Structure of the Er<sup>3+</sup> Ion in A YAG Crystal](#)
- [Create an 8 layer multi-panel plot template](#)
- [Panel Graph with Inset Plots of High-resolution Electron Energy-loss Spectra](#)

### 6.9.2 Double Y

#### 6.9.2.1 Summary

This tutorial will show how to create a graph with double Y axes.

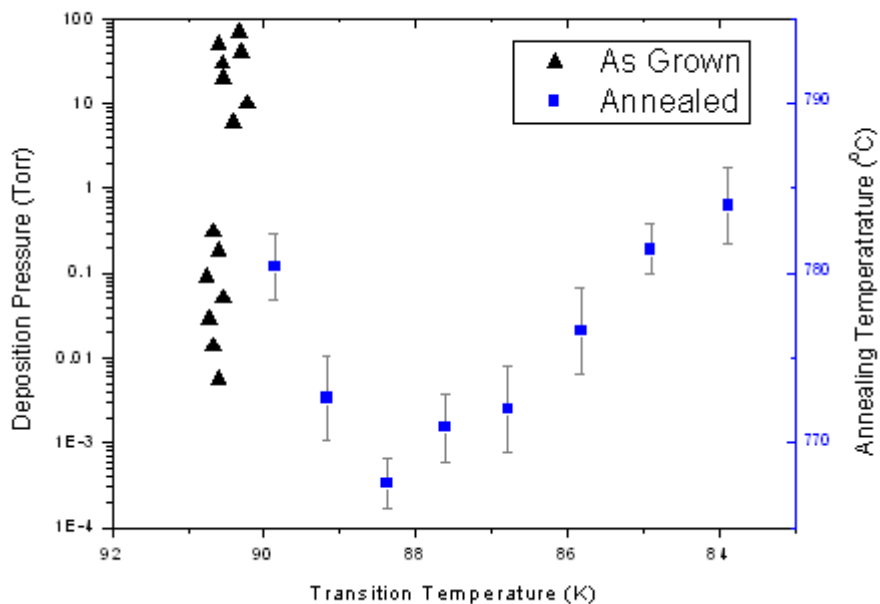

Minimum Origin Version Required: Origin 2015 SR0

#### 6.9.2.2 What you will learn

- Create a graph with double Y axes
- Customize scatter plots
- Change axis scale, type, title, etc.
- Update legend

#### 6.9.2.3 Steps

This tutorial is associated with the project: `\Samples\Graphing\Double Y.opj`.

1. Open the project `<Origin Installation Directory>\Samples\Graphing\Double Y.opj` and activate the workbook.
2. Highlight four columns of data in the worksheet, then choose menu **Plot > Basic 2D : Double-Y** to create a graph with double Y axes.
3. Customize scatter plots:
  - Double click on the plot to open the **Plot Details** dialog box. In the left panel, select the plot in Layer1, and set the plot type to **Scatter**, symbol to **Triangle** and size to **10** (Hint: the box accepts text entries).

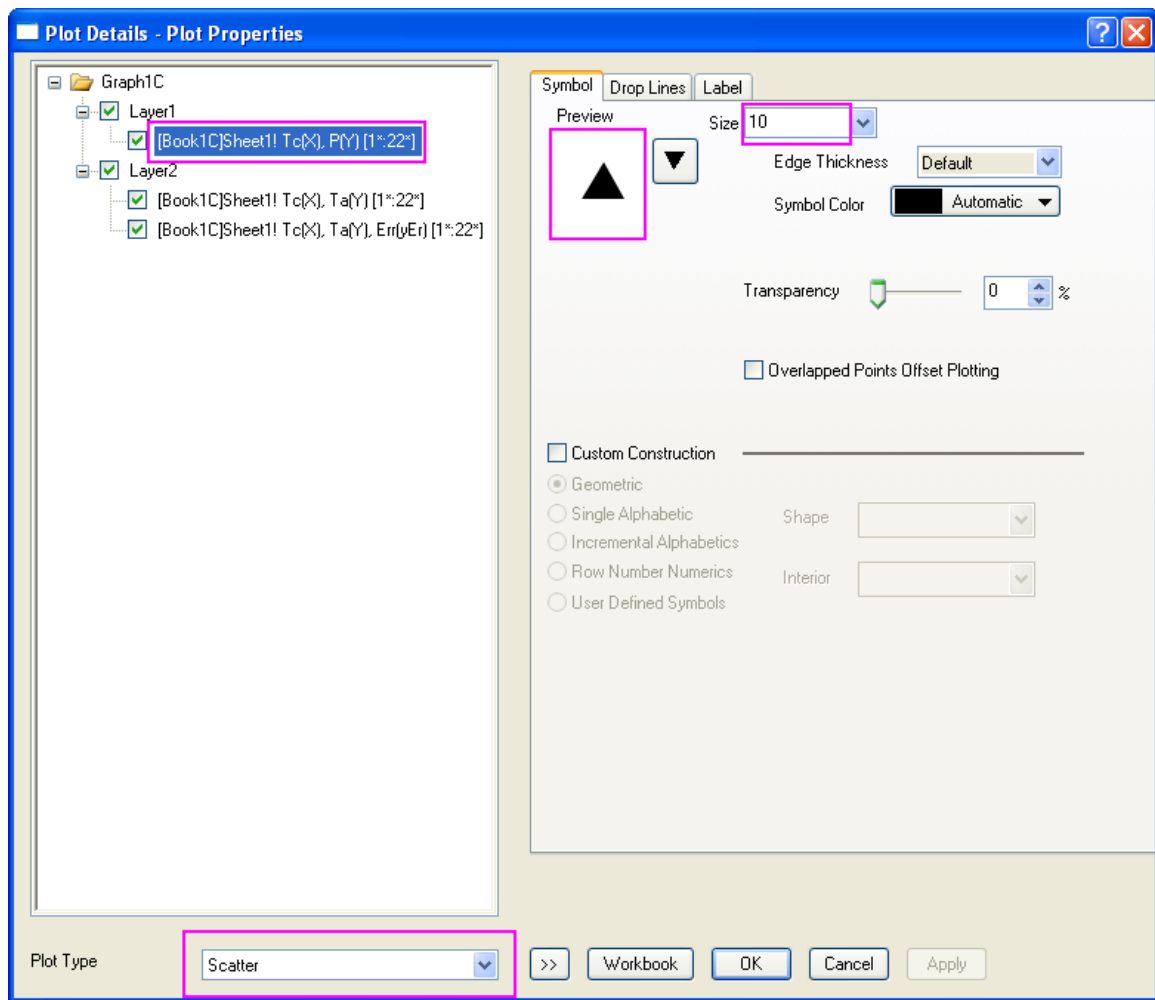

- Choose the first plot in Layer2, then change the **Plot Type**, **Size** and **Color** as shown below.



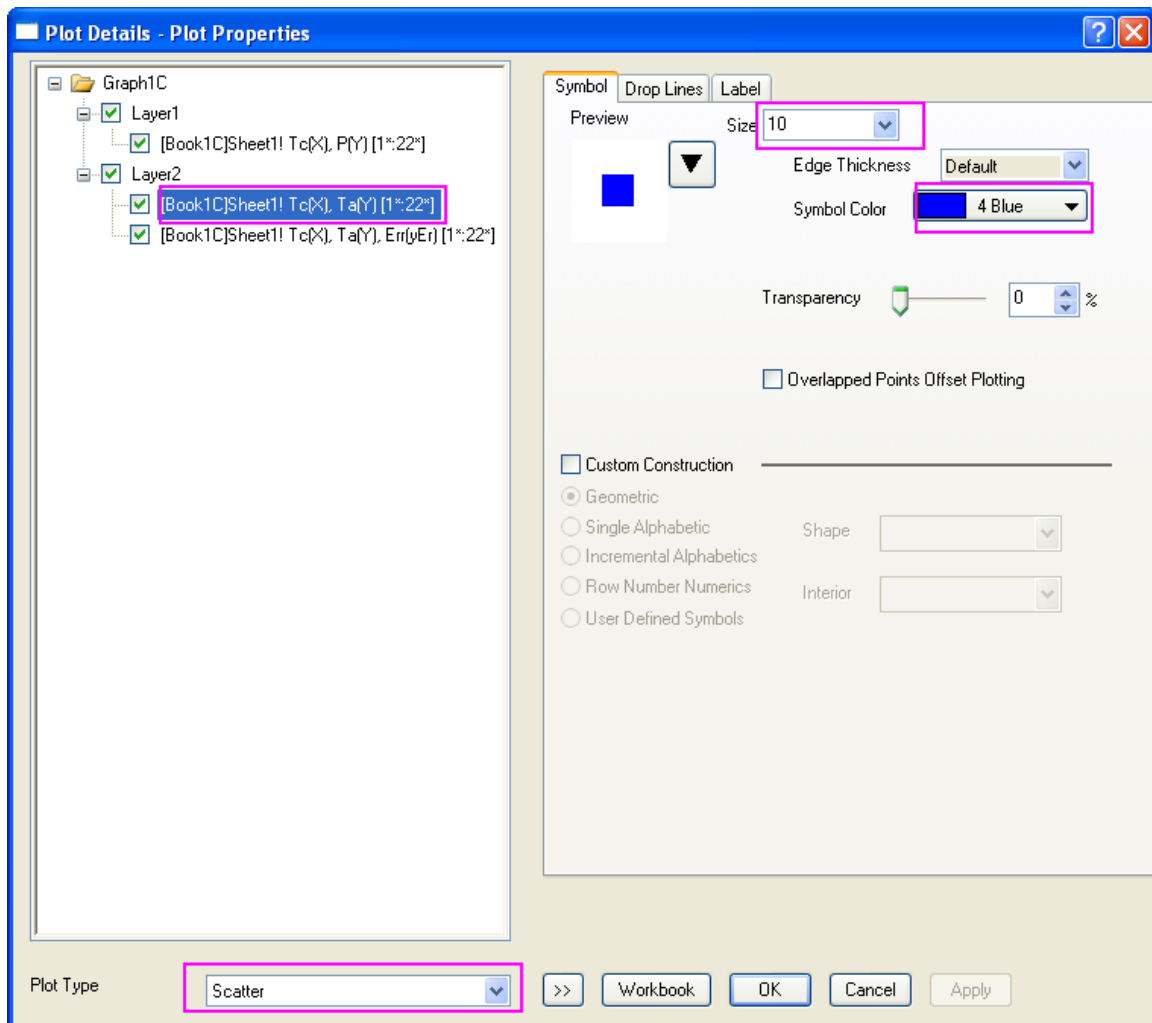

- Choose the Error bar plot in Layer2, then change **Color** to **Gray** in the **Error Bar** tab.
  - Click **OK** to apply your customizations and close the dialog box.
4. Double click on X axis to open the **Axis** dialog box. On the **Scale** tab for **X Axis**, set the X axis scale to be from 92 to 83 with increment of -2.

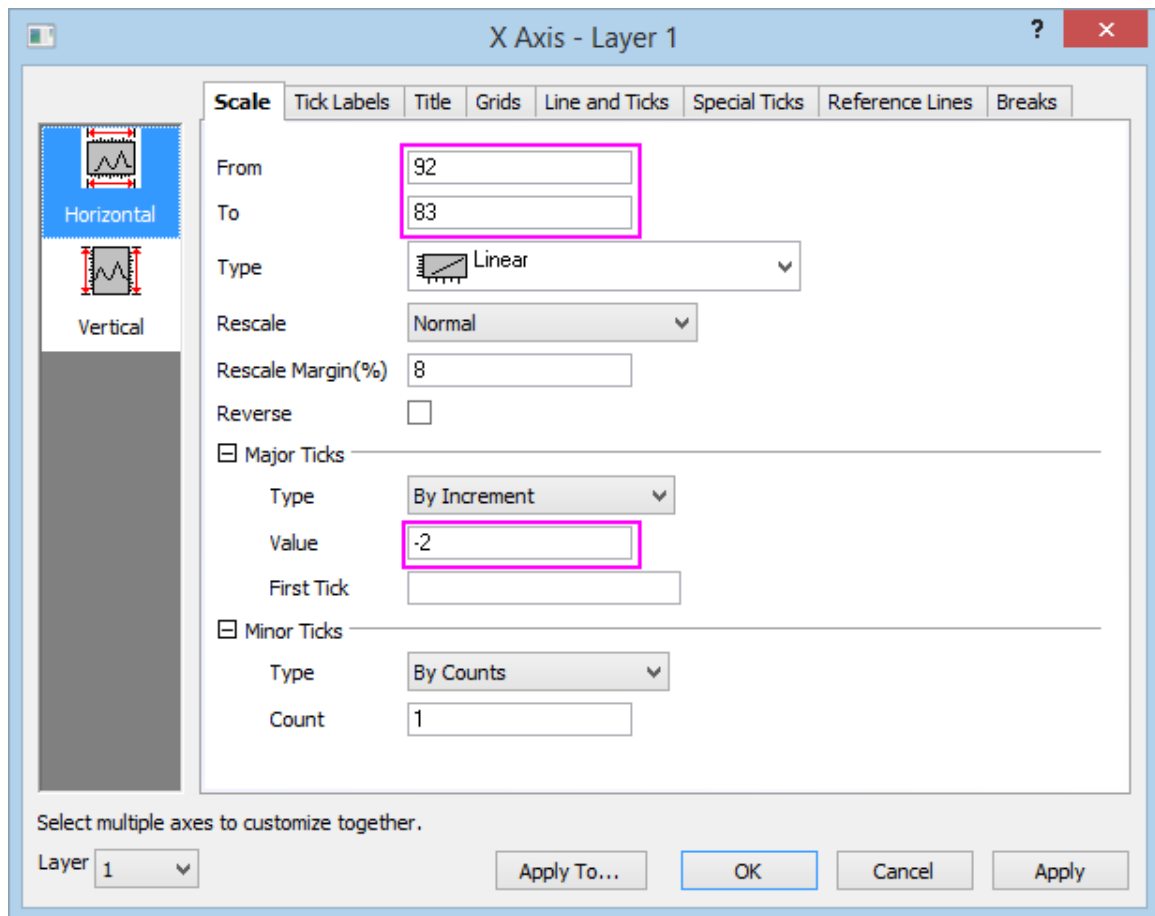

5. Click **Vertical** icon on the left panel and go to the **Scale** tab for **Y Axis** and apply the following settings to the left Y axis:

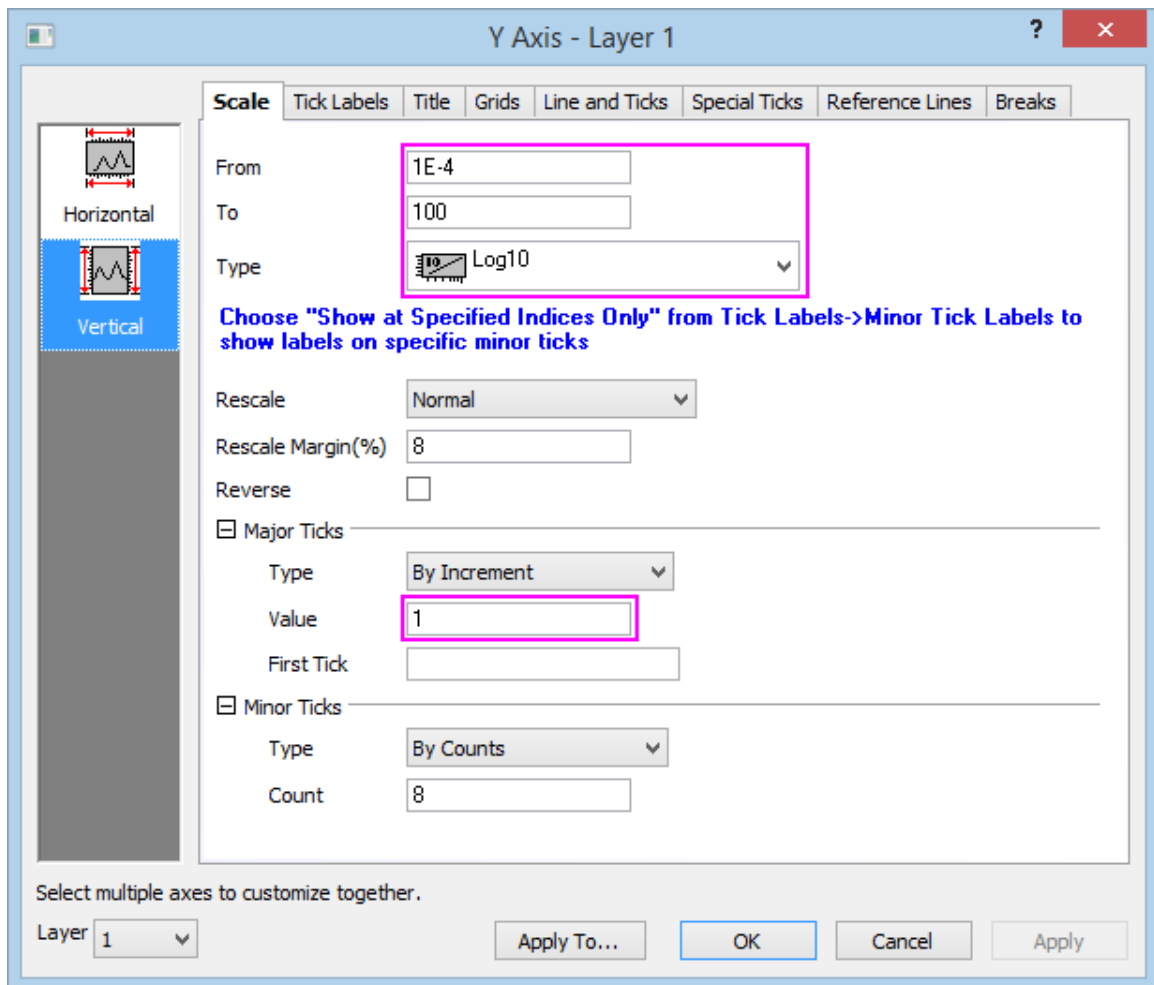

6. Click **Horizontal** icon on the left panel to go to **Title** tab and change the X Axis title to *Transition Temperature (K)*:

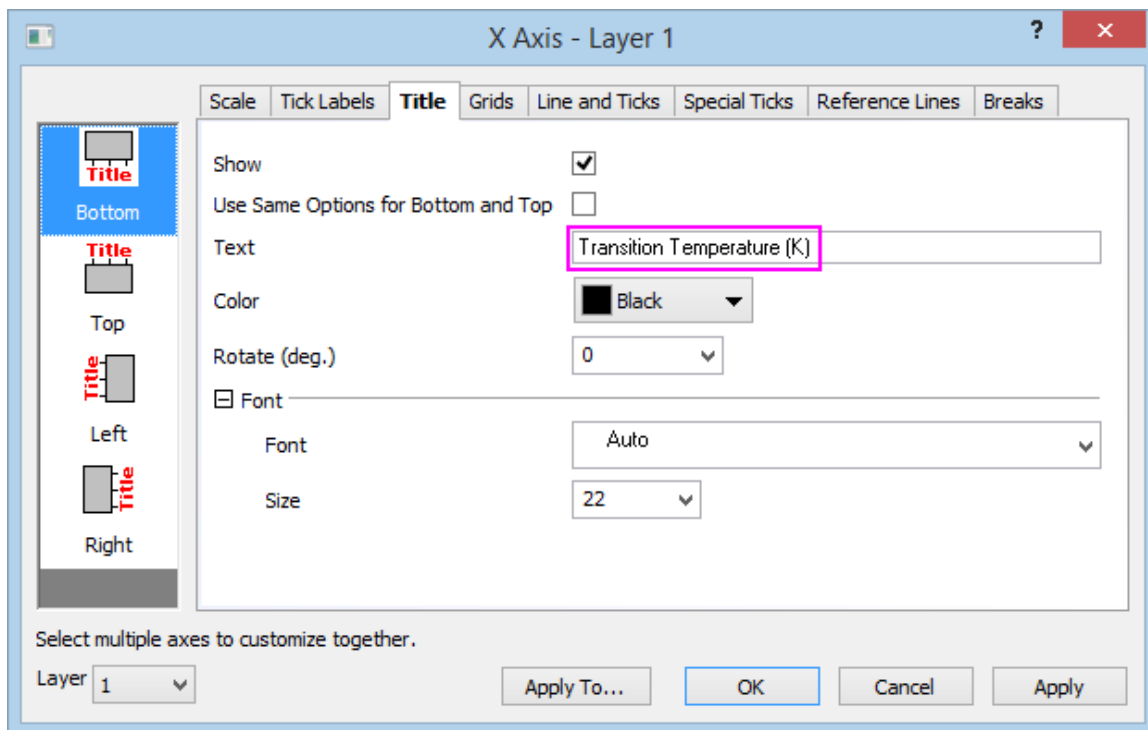

7. Click **Left** icon on the left panel to change the Y Axis title to *Deposition Pressure (Torr)*.
8. Set the **Layer** drop-down to 2 to switch to Layer 2 controls. Repeat the settings as in step 5 - 6, but with scale **From** = 765, **To** = 795, **Type** = *Linear*. For **Major Ticks**, change the **Value** for **Increment** to 10. Go to **Title** tab and change **Text** to *Annealing Temperature (\+(0)C)*.
9. Go to the **Line and Ticks** tab and set both **Major Ticks** and **Minor Ticks** to *In* and click **OK** to apply settings.

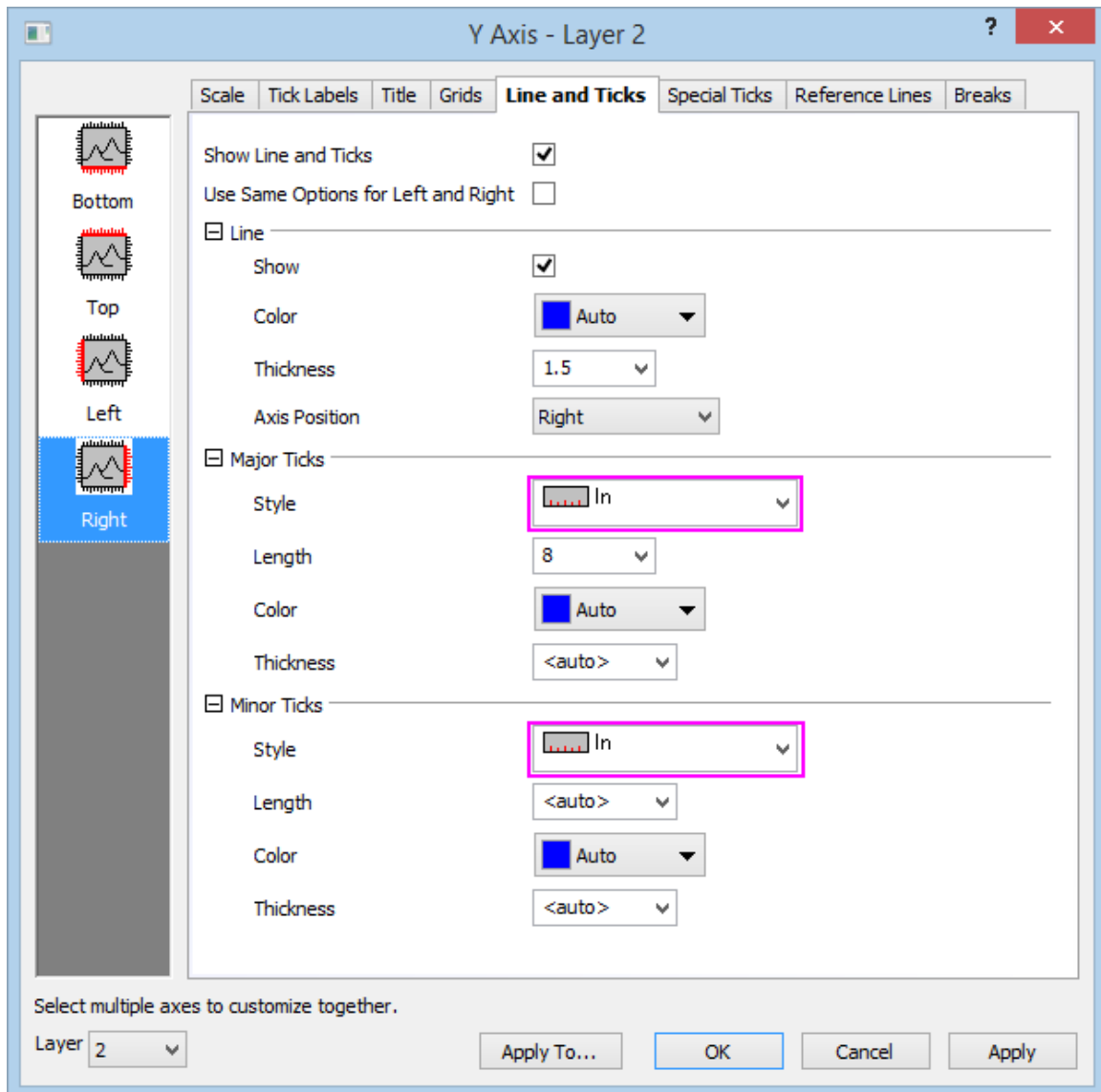

10. Click the legend to select it, then right-click and choose **Properties** from the shortcut menu. This opens the **Object Properties** dialog box. Go to **Frame** tab, change **Frame** to *Box*. In the **Text** tab, enter the following:

\(1.1) As Grown

\(2.1) Annealed

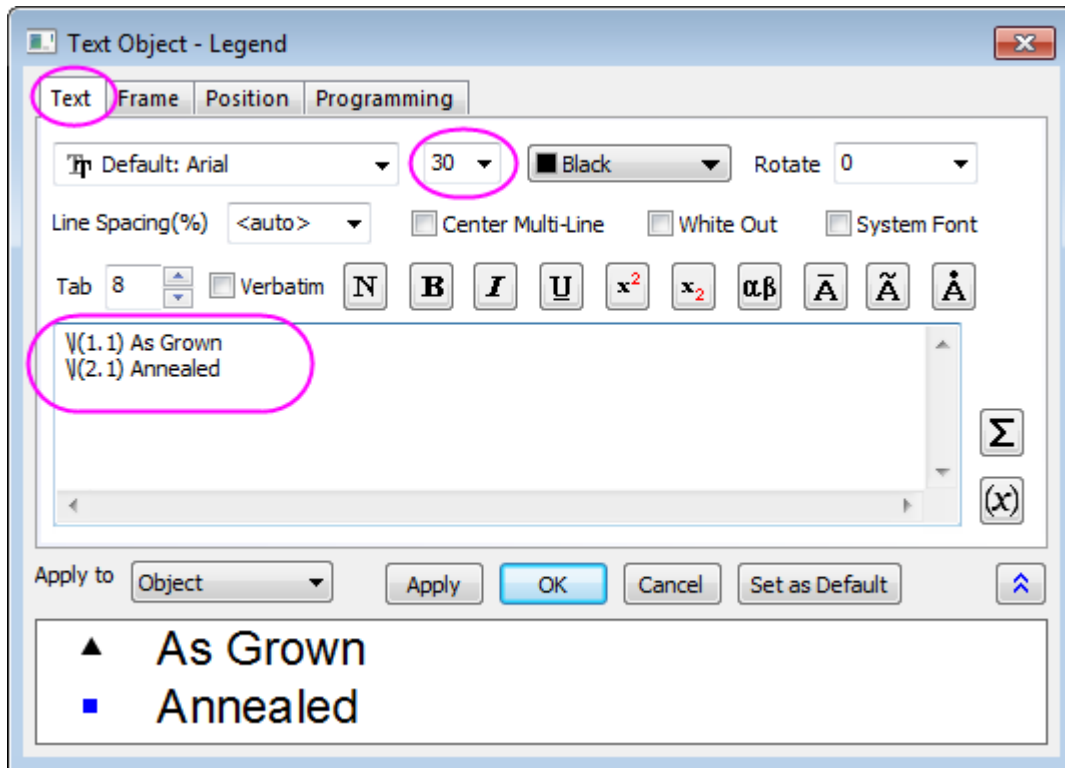

11. Click **OK** to close the **Properties** dialog box. Move the legend to an appropriate position.

### 6.9.3 3Ys Y-YY

#### 6.9.3.1 Summary

This tutorial will show how to create a graph with three Y axes; one left Y axis and double right Y axes.

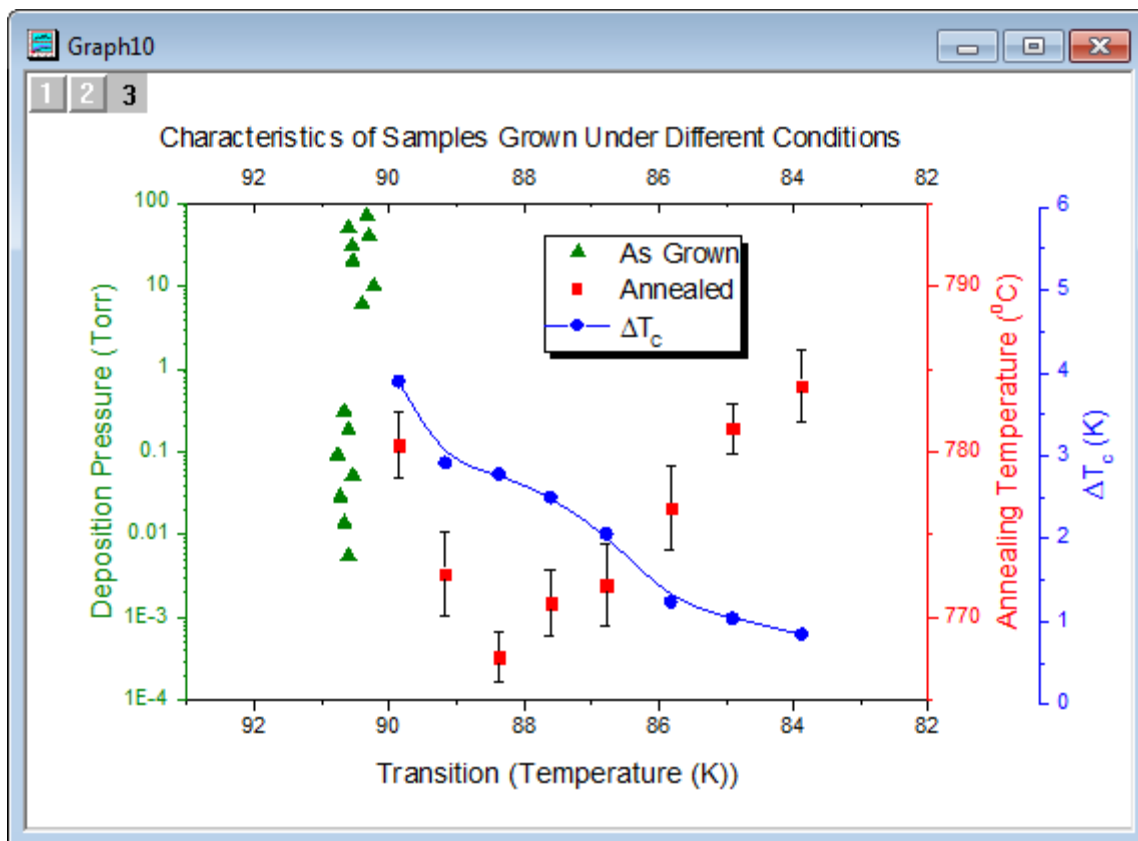

Minimum Origin Version Required: Origin 2015 SR0

#### 6.9.3.2 What you will learn

- Create a graph with three Y axes; one left Y axis and double right Y axes.
- Customize scatter plots.
- Change axis scale, type, title, etc.
- Add an axis to an existing graph.
- Update the graph legend.

#### 6.9.3.3 Steps

This tutorial is associated with <Origin EXE Folder>\Samples\Tutorial Data.opj.

You will also find this graph in Learning Center. Select **Help: Learning Center** from the menu or press the **F11** key. From the **Samples in** list, choose **Graph Sample: Multiple Axis**.

1. Open **Tutorial Data.opj** and browse to the **3Ys Y-YY** folder in **Project Explorer** (PE).
2. Highlight all data columns in the worksheet, select **Plot > Basic 2D : 3Ys Y-YY** main menu to create a graph with three Y axes - one left Y and two right Y.
3. Customize data plots:

- Double-click on the plot to open the **Plot Details** dialog box. In the left panel, select the plot in Layer1, then change the plot type, symbol and color as shown below (be careful not to clear the check box to the left of the plot):

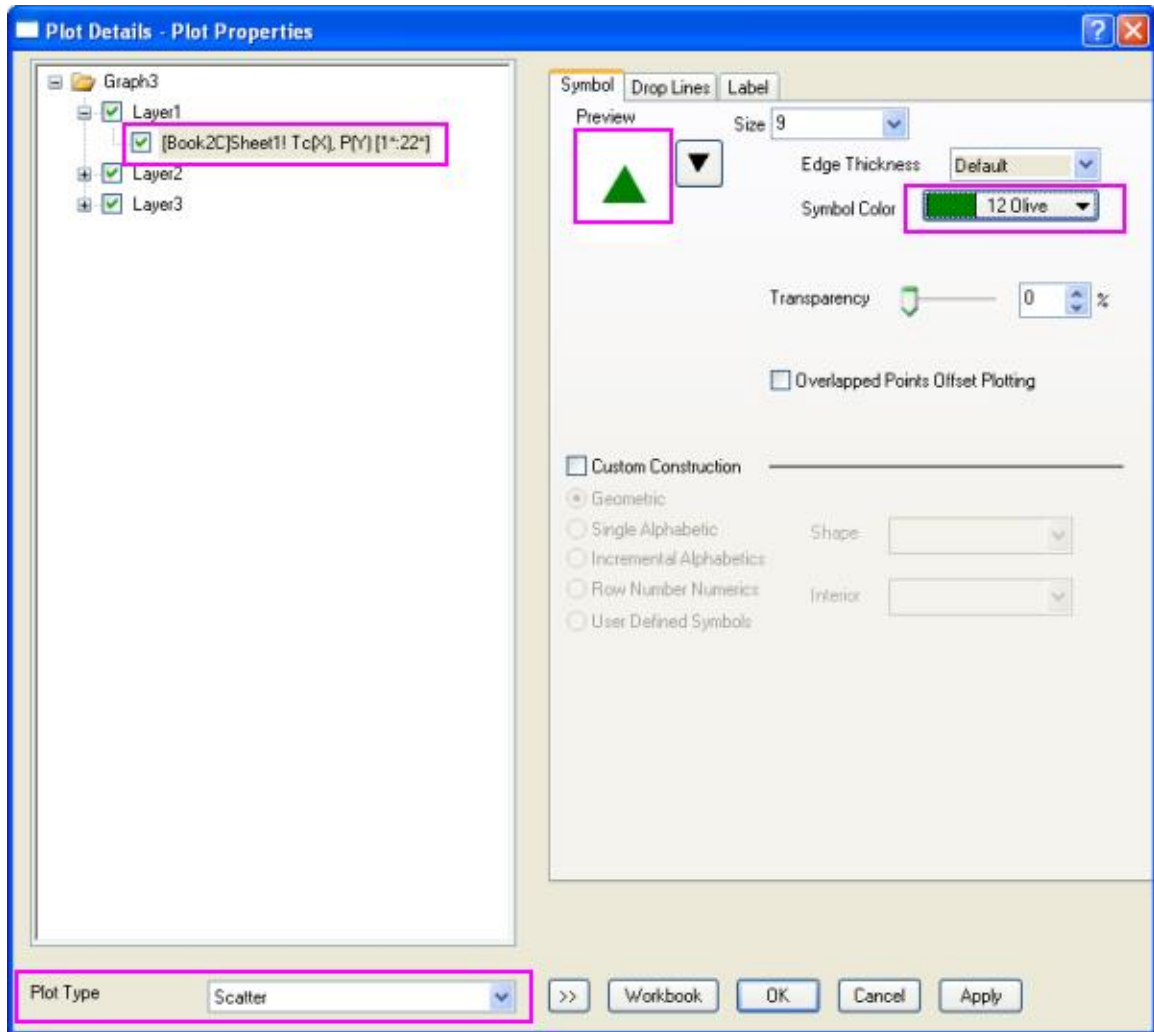

- Click the data plot in Layer2 and change the plot type and symbol shape as shown in the following:



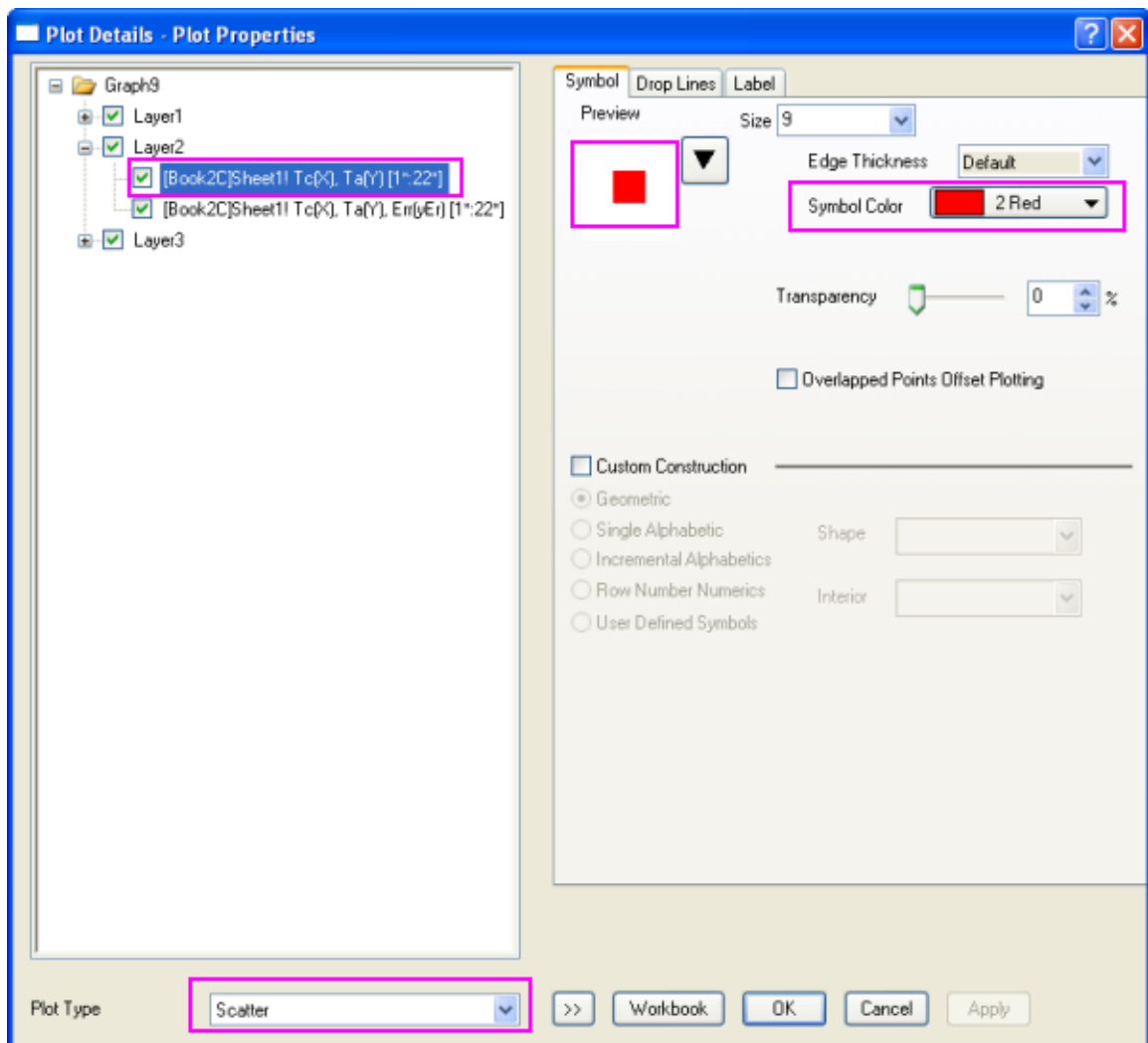

- Choose the Error bar plot in Layer2, then change its color to **Black**.
- Choose the plot in Layer3. Change the **Plot Type** to be **Line + Symbol** and go the **Symbol** tab (right panel), choose the following settings:

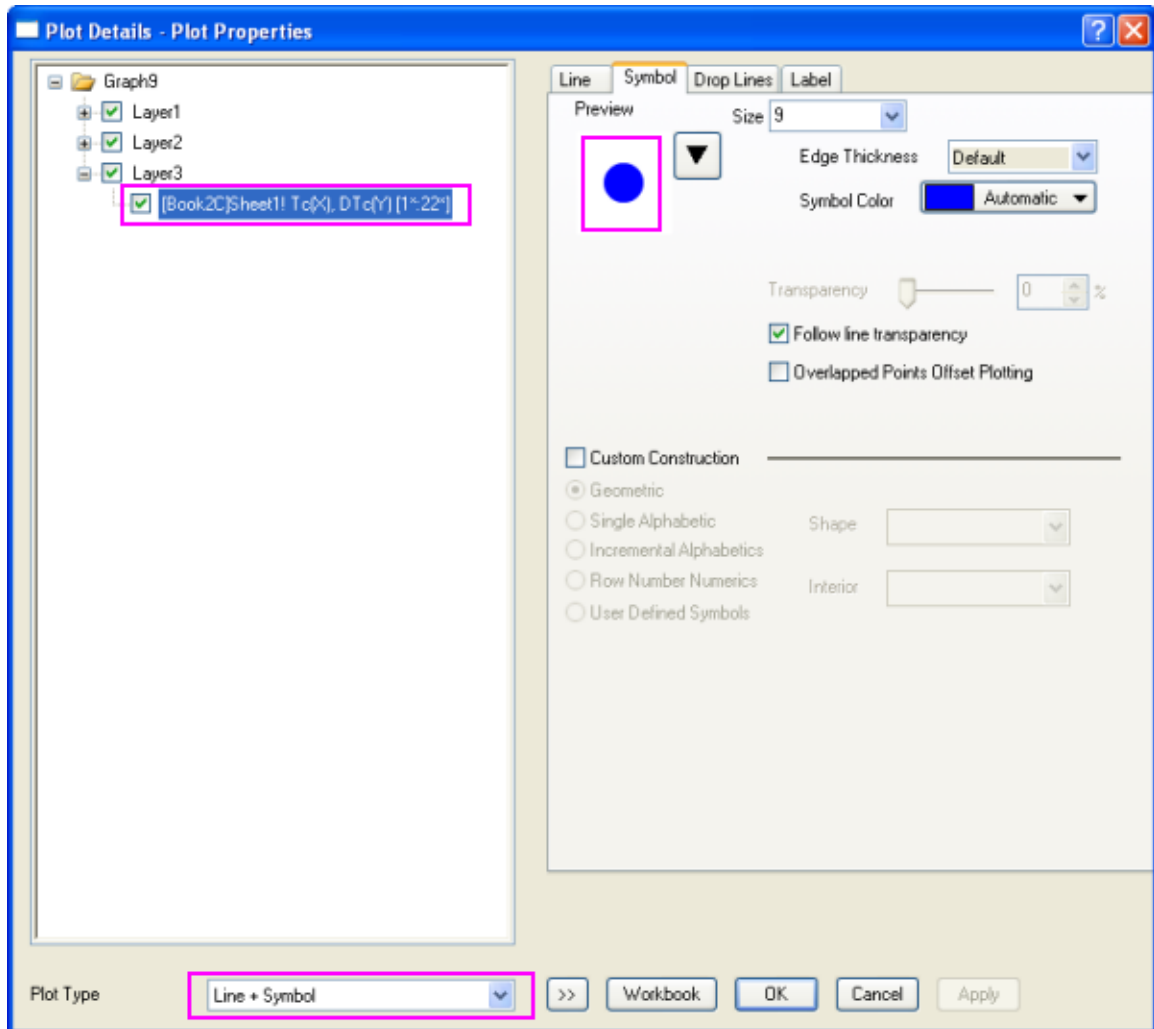

- Select the **Line** tab (with Layer 3 still selected) and change **Connect** to **B-Spline**. Click **OK** to close **Plot Details**.

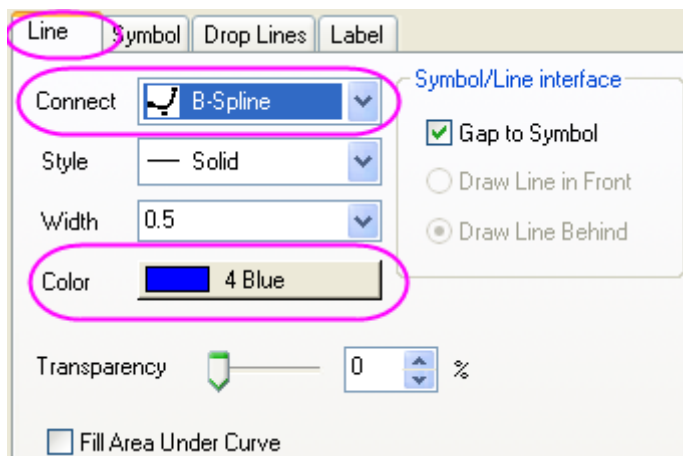

4. Double-click on the X axis to open the **Axis** dialog box. Configure the X axis scale as shown in the following:

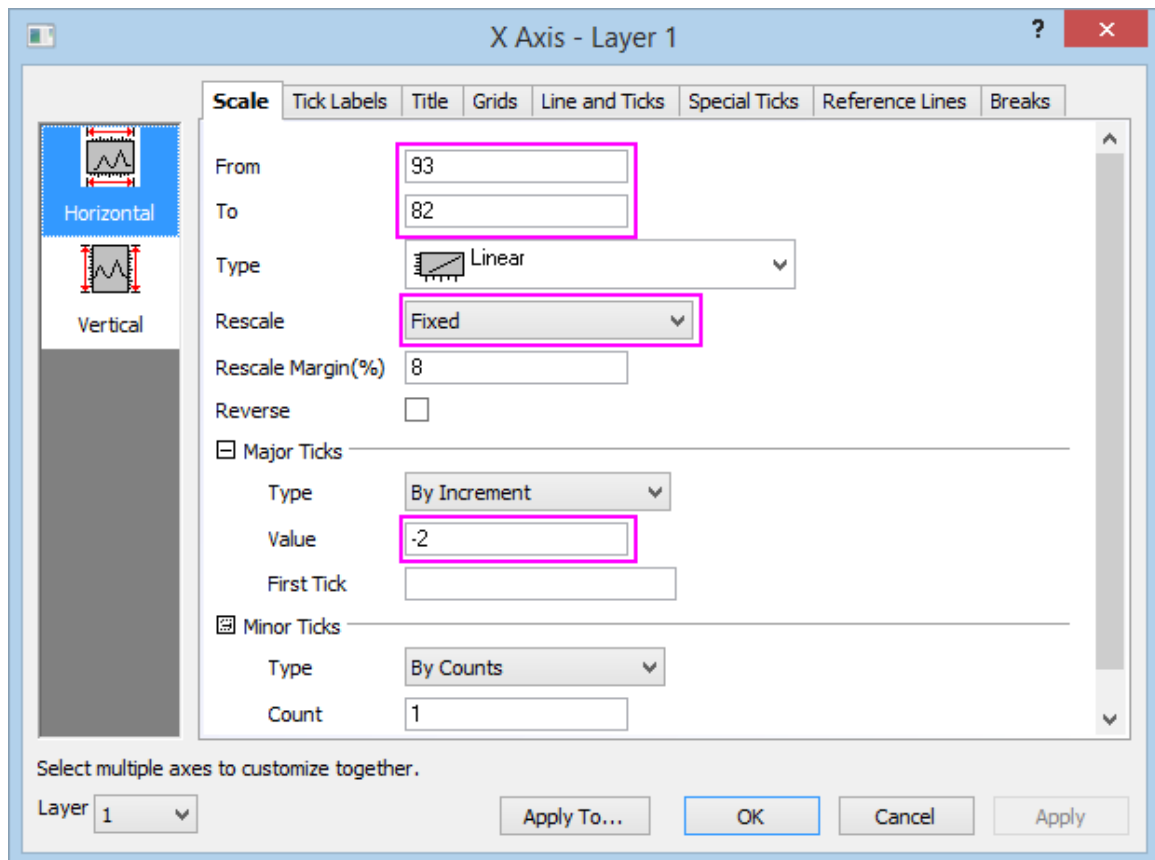

5. Go to **Tick Labels** tab and click **Top** icon on the left panel, check the **Show** box and show tick labels of top axis.

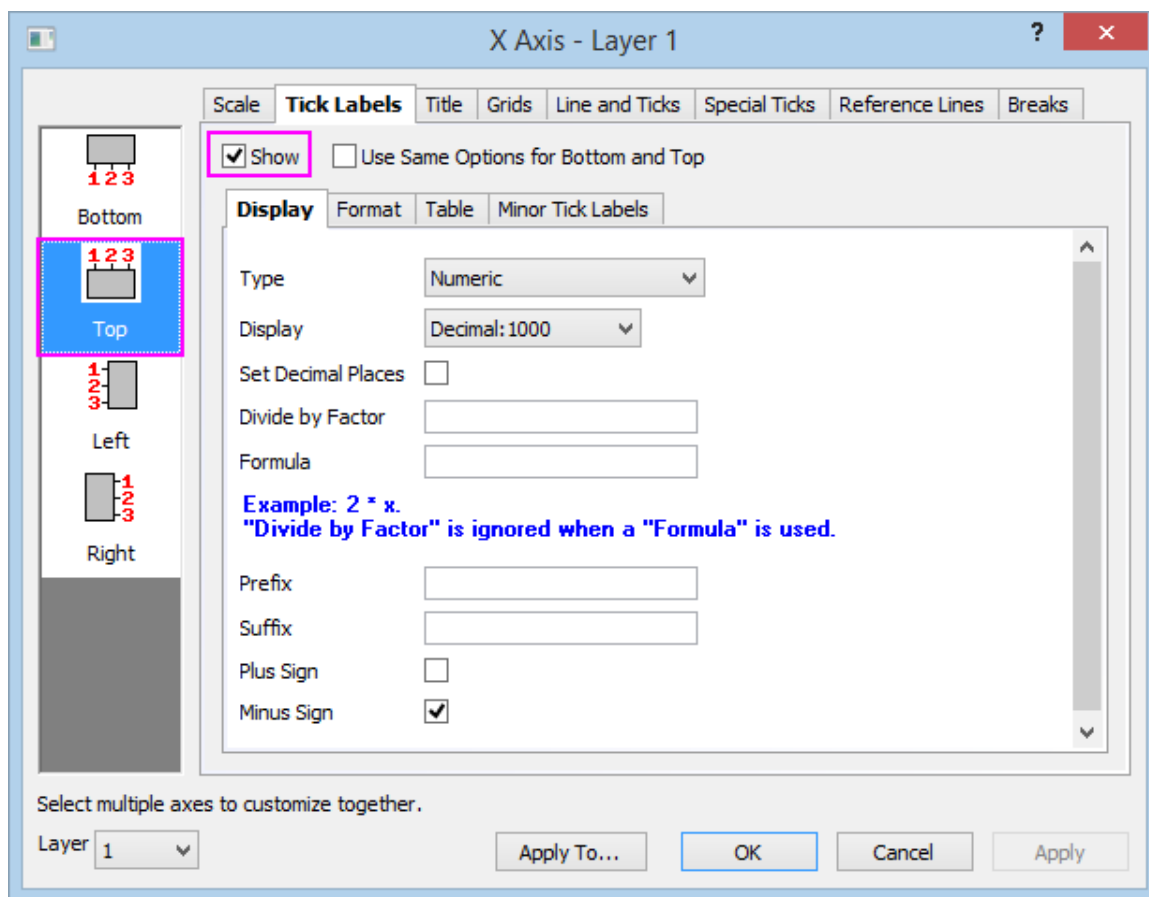

6. Then go to **Line and Ticks** tab, check **Show Line and Ticks** box to show line and ticks for top axis and click on **Apply**.

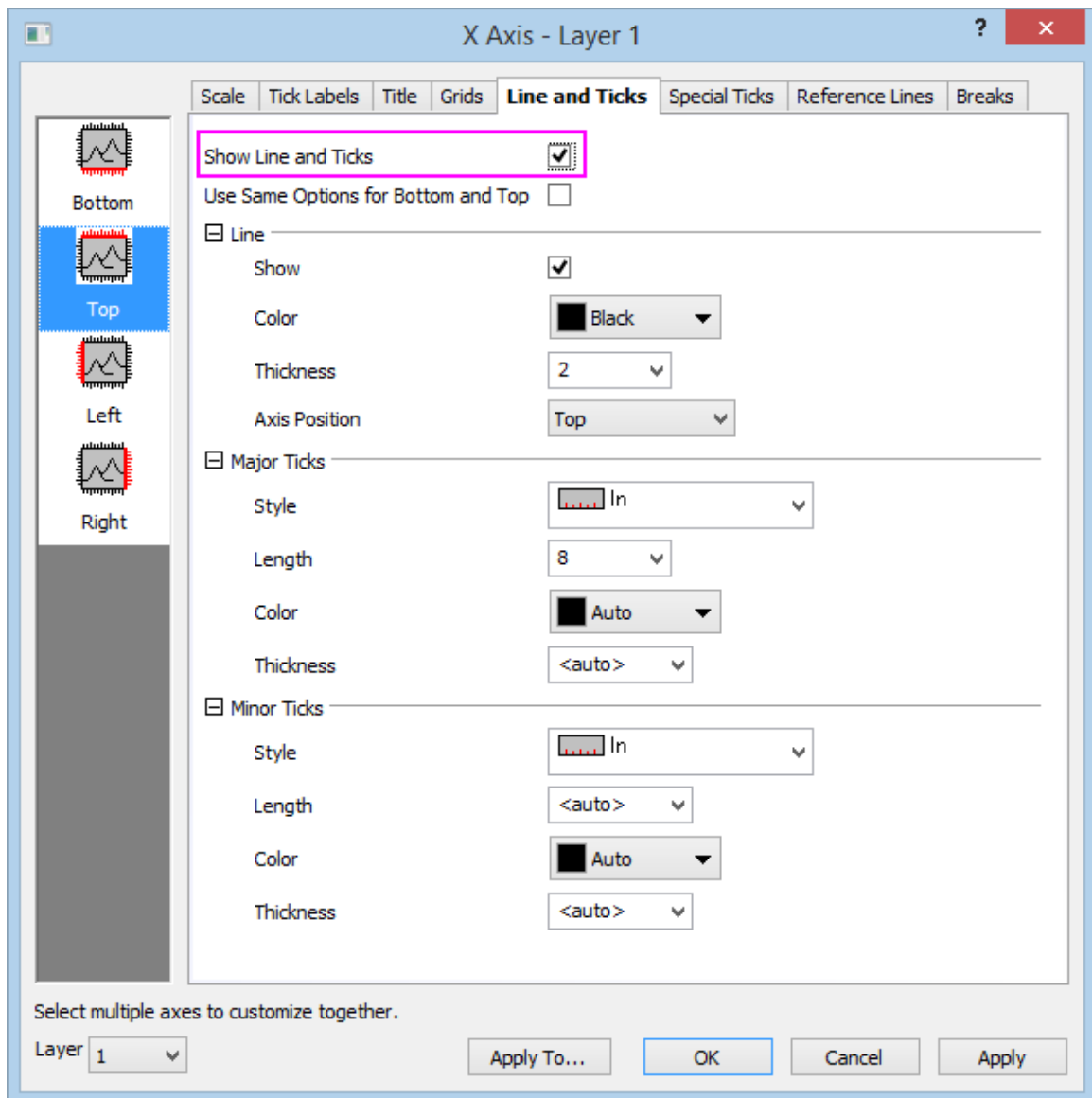

7. Go to the **Scale** tab and click the **Vertical** icon on the left panel and duplicate the following settings:

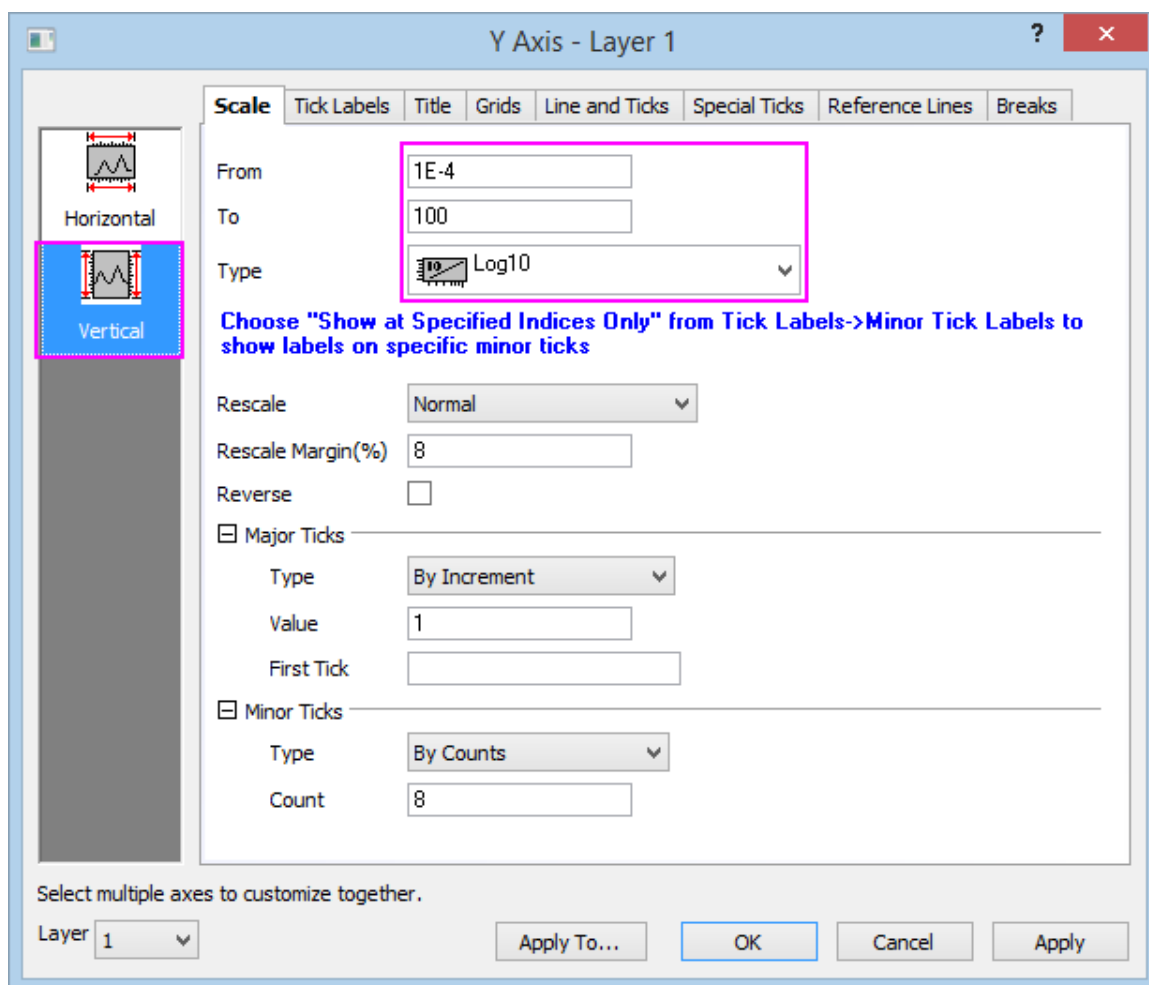

8. Go to the **Title** tab, select Show and change the title Text to *Deposition Pressure (Torr)* and select **Auto** from color drop-down list.

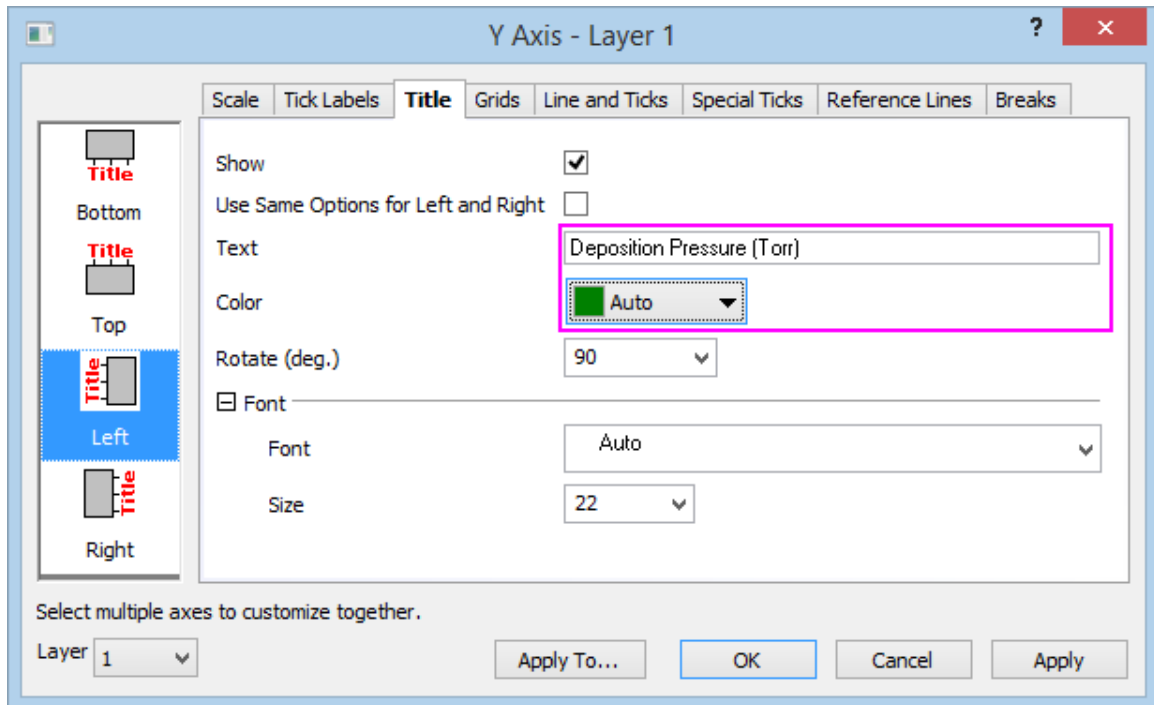

9. Click **Apply** to and apply the axis settings to layer 1.
10. Set the **Layer** drop-down list to 2 and in the left panel, choose **Right**.
11. Click the **Scale** tab and set **From** = 765 and To = 795, and set the **Major Ticks** increment **Value** to 10. Click the **Title** tab, check **Show** and change the axis title to *Annealing Temperature (+0)C* and select **Auto** from the **Color** drop-down list.
12. Set the **Layer** drop-down list to 3 and in the left panel, choose **Right**. On the **Scale** tab, set the axis scale to read from 0 to 6 with a major tick increment **Value** = 1. On the **Title** tab, check **Show** and enter  $\lg(D)T^{-c}$  (K) for **Text** and set the **Color** drop-down list to **Auto**.
13. Click **OK** to apply settings and close the dialog box. On the graph, right-click the legend object and choose **Properties** from the shortcut menu. This opens the **Object Properties** dialog box. Go to **Frame** tab, and change **Frame** to **Shadow**. Go to **Text** tab, and enter the text shown below, then click **OK** to close the dialog box. Reposition the legend object, as needed.

\(1.1) As Grown

\(2.1) Annealed

\(3.1)  $\lg(D)T^{-c}$

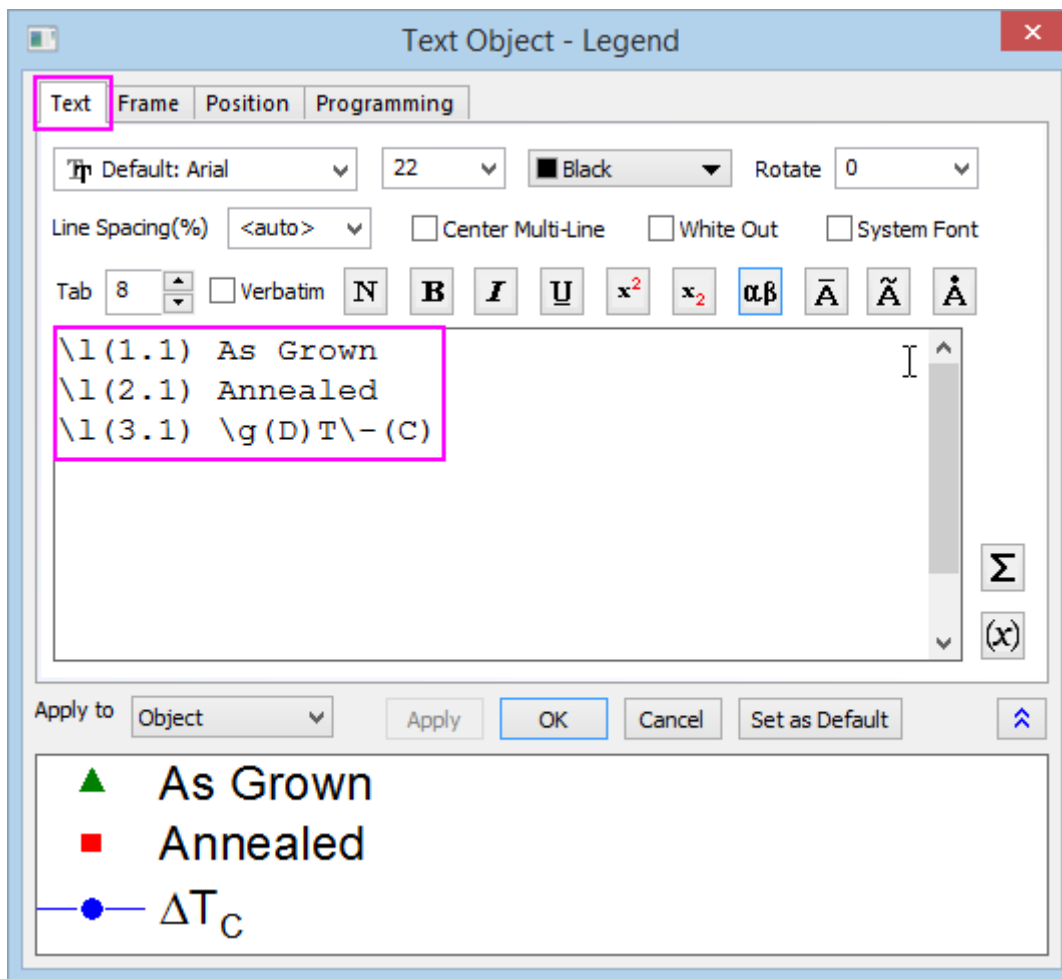

14. Add a graph title by creating a text object and typing *Characteristics of Samples Grown Under Different Conditions*. Reposition as needed.
15. Right-click outside the graph (but still within the white area) and select **Fit Page To Layers...**. Accept the defaults and click **OK** to adjust the page size to better fit the graph layers.
16. To the right side of the graph, click once to select the axis titles and the blue Y axis, then drag to reposition them so that they don't overlap one another. Your graph should now look something like this:



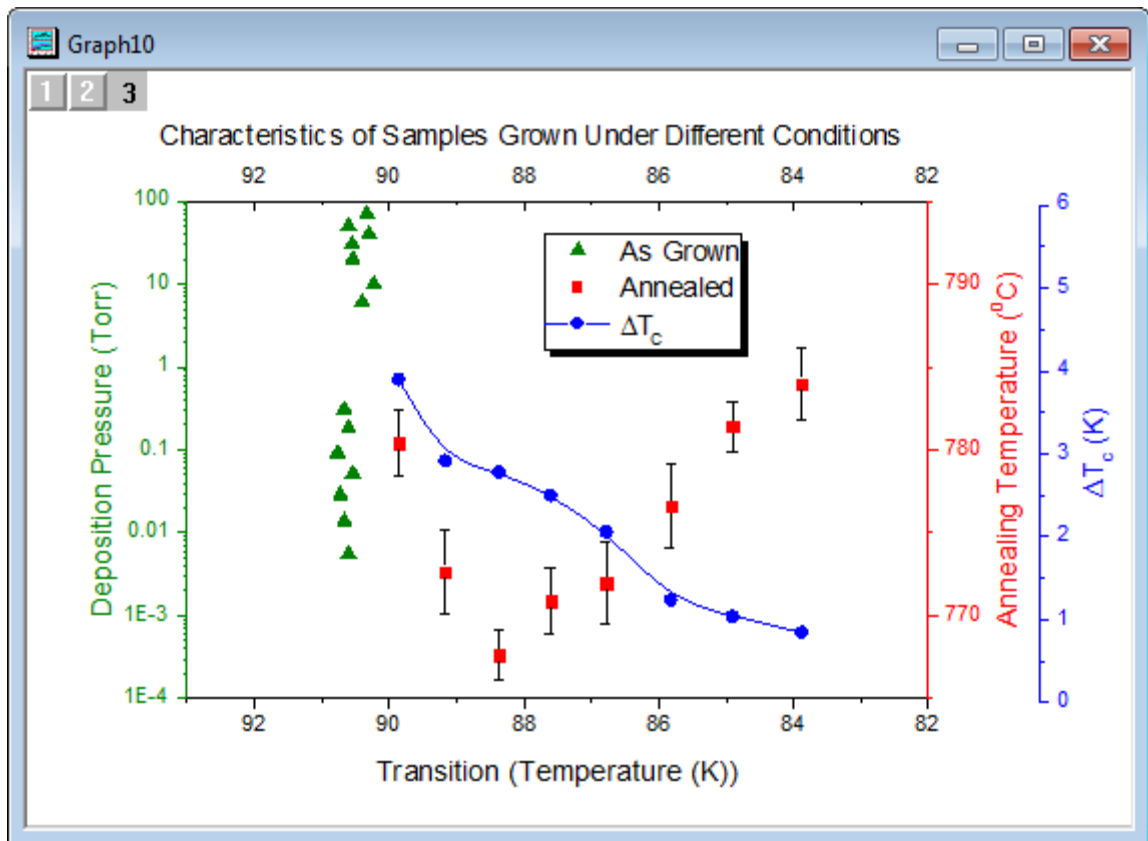

## 6.9.4 Stack Lines by Y Offsets

### 6.9.4.1 Summary

This tutorial will demonstrate how to create a graph with stack lines by Y offsets.

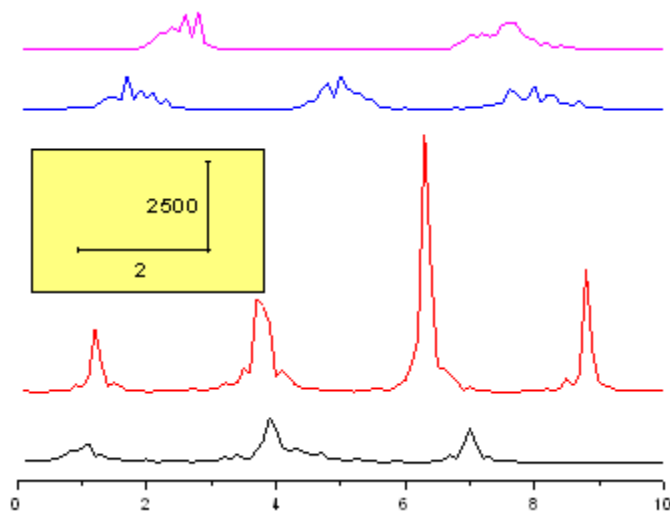

Minimum Origin Version Required: Origin 2015 SR0



Aside from the stacked individual line plots described in this tutorial, you can create stacked line plots comprised of sub-groups of lines, with offsets created between sub-groups. See [the Plot Details Stack tab](#) for details.

#### 6.9.4.2 What you will learn

- How to create a graph with stack lines by Y offsets
- How to customize a rectangular object
- How to add a new XY scaler

#### 6.9.4.3 Steps

This tutorial is associated with the **Tutorial Data** project: <Origin EXE Folder>\Samples\Tutorial Data.opj.

##### Create a Stack Line Plot

1. Open the **Tutorial Data** project and browse to folder *Stack Lines by Y Offsets* in **Project Explorer**.
2. Highlight all the columns in the data worksheet of **Book6A**, and choose menu **Plot > Basic 2D : Stack Lines by Y Offsets** to create a graph with stack lines by Y offsets.

##### Customize the Stack Line Plot

1. Delete the following objects by selecting them and pressing the **Delete** key on your keyboard:

Legend

Y axis

Y axis labels

Y axis title

X axis title

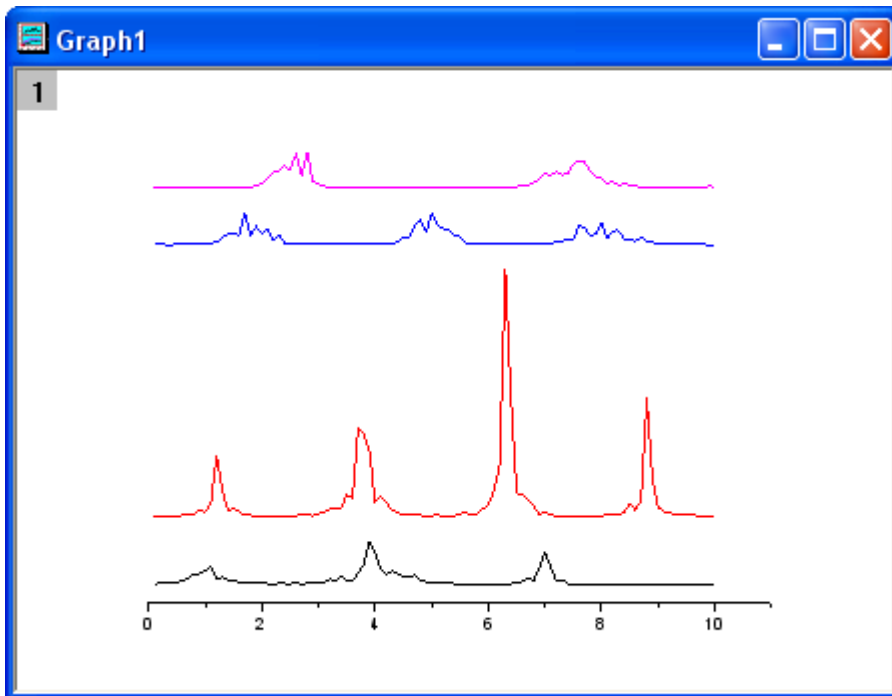

2. Double click on the X axis to open the **Axis** dialog. On the **Scale** tab, change the value of **To** to 10. Click **OK** to close the dialog.

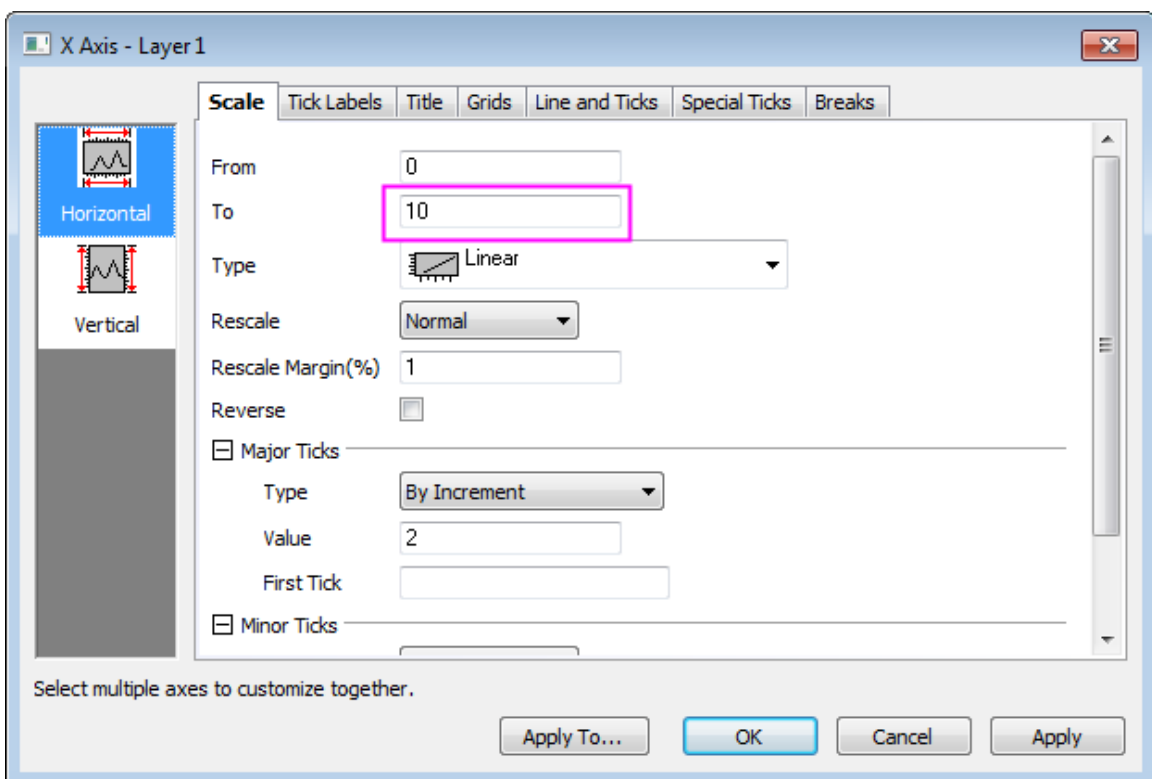

Add XY Scaler

1. Click the **Rectangle** button on the **Tools** toolbar and then create a rectangle on the graph.
2. Double click on the rectangle to open its properties dialog. Change the following settings.

Fill Pattern tab

Fill Color = LT Yellow

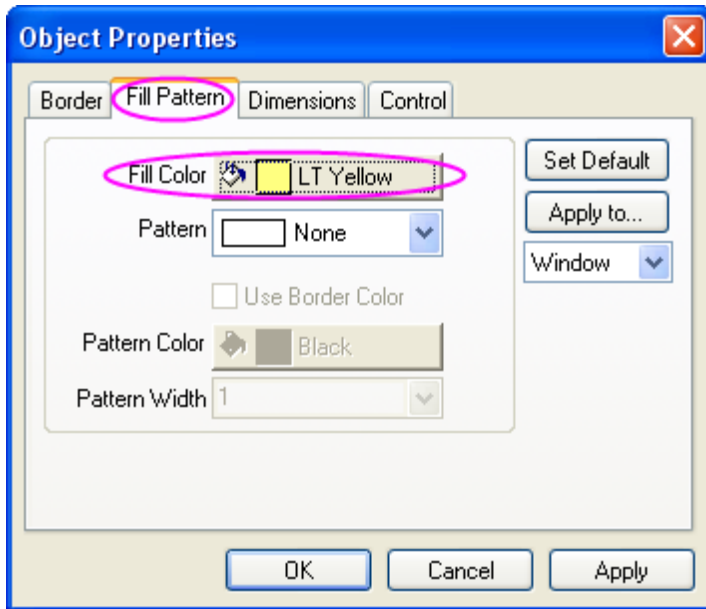

Dimensions tab

Units = scale

Left = 0.25

Top = 9000

Width = 3.5

Height = 4000

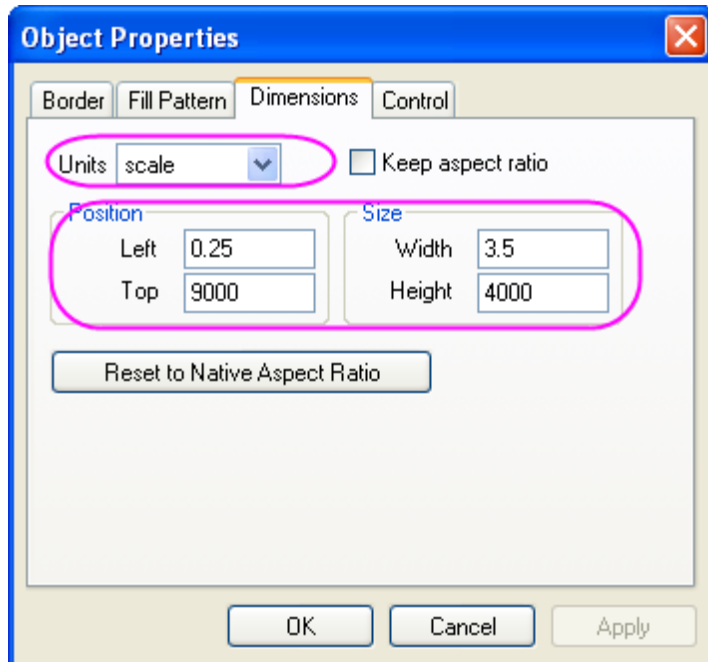

3. Click OK to close the **Object Properties** dialog.
4. Select **Graph: New XY Scaler** from the Origin menu to create a new XY scaler.
5. Double click on the scaler to open the **Scaler Properties** dialog. Set the following properties in the dialog:

Font Settings branch

Font Size = 24

X branch

Length(Scale) = 2

Title = 2

Y branch

Position = Right

Length(Scale) = 2500

Title = 2500

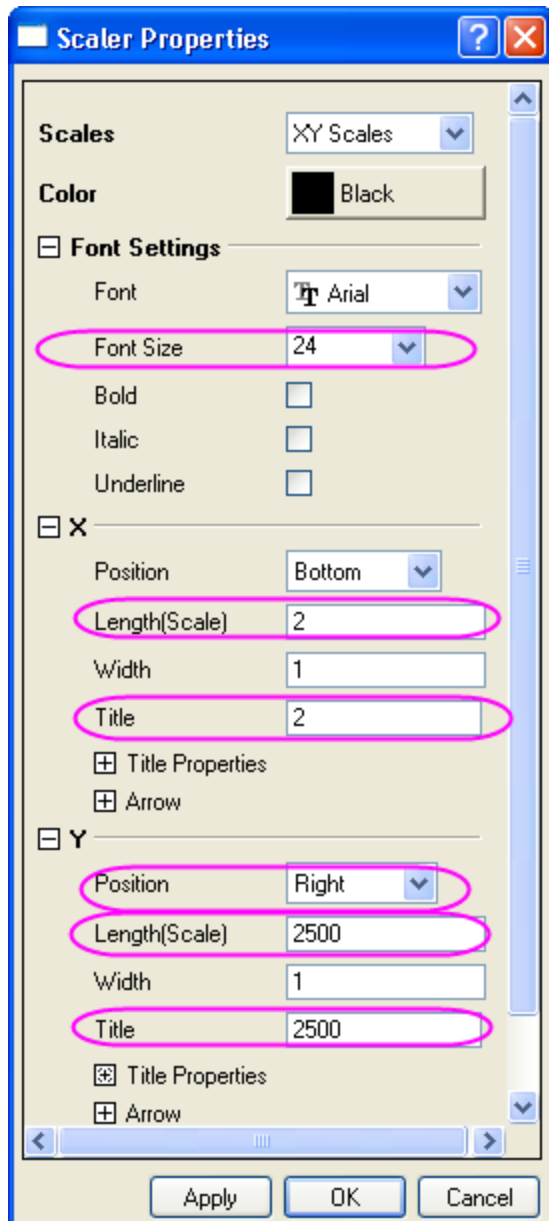

6. Click OK to close the **Scaler Properties** dialog.
7. Move the scaler object onto the rectangle you created.

#### Drag and Change Plot Offset

1. Click on the top data plot (purple one) twice to select it. (Click only once will select the whole group):

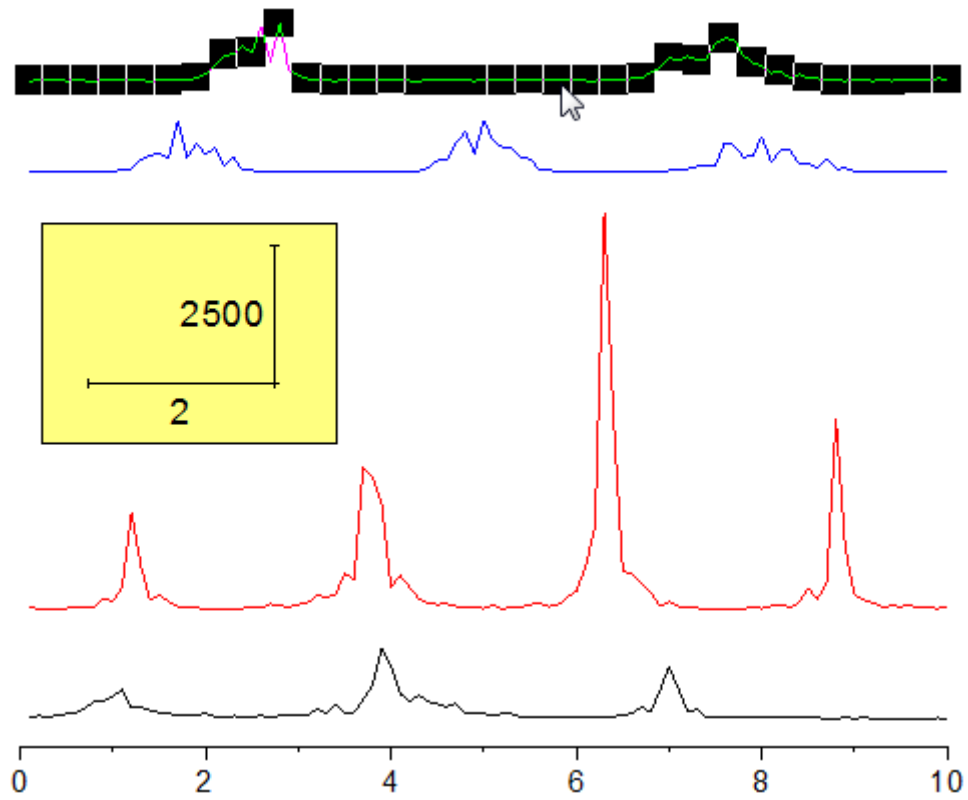

2. Click and drag the mouse to move the data plot.

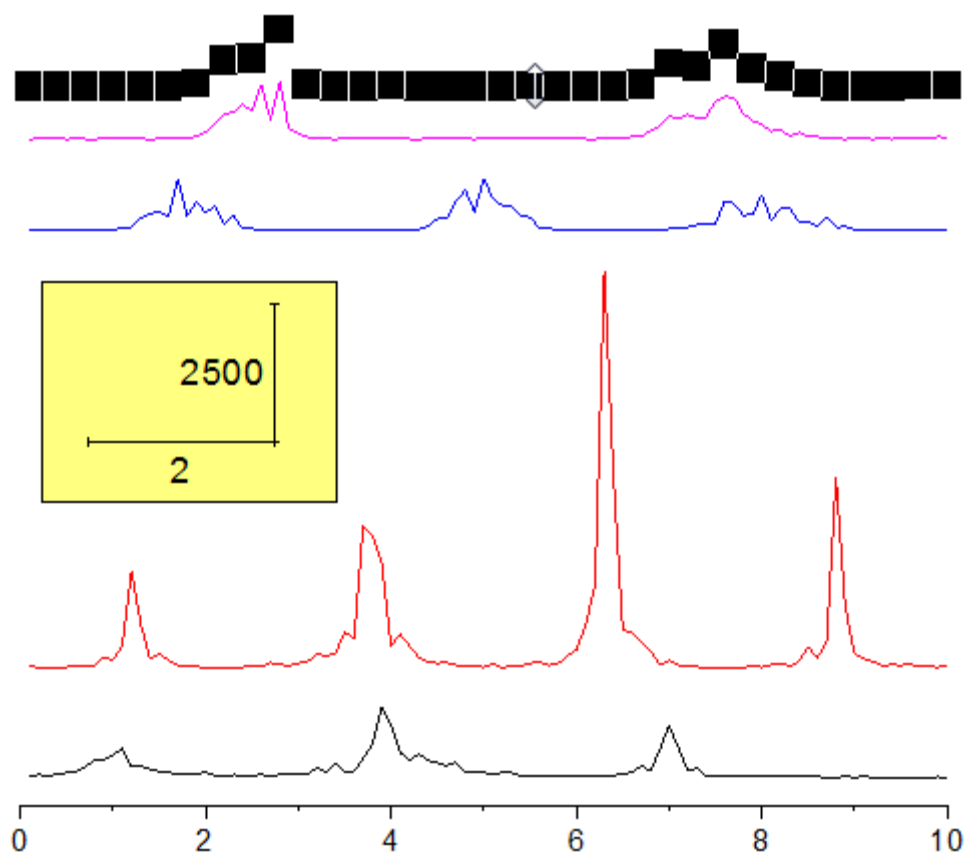

**Note:** an alternative is to go to the **Offset** tab in **Plot Details** dialog and change the Y offset.

## 6.9.5 Vertical 2 Panel Line

### 6.9.5.1 Summary

This tutorial will demonstrate how to merge and customize two graphs.



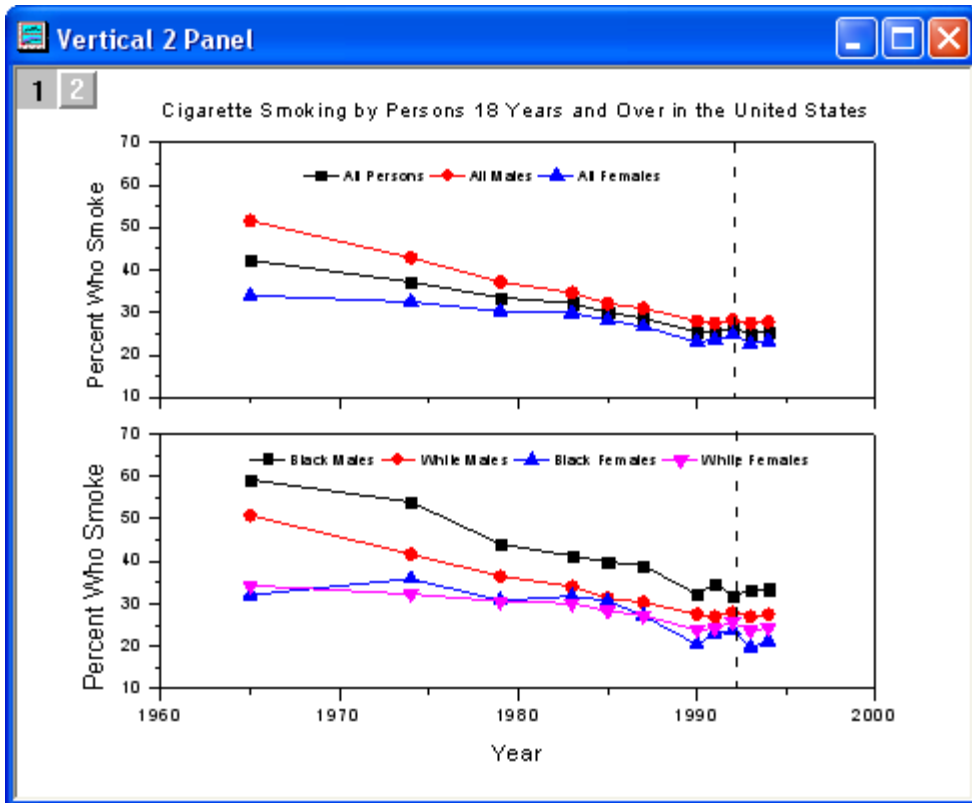

Minimum Origin Version Required: Origin 2015 SR0

#### 6.9.5.2 What You Will Learn

In this tutorial, you will learn how to:

- Merge graph windows
- Customize graph axes after merging
- Apply a graph theme

#### 6.9.5.3 Steps

1. Create a new worksheet. Click the **Import Single ASCII button**  and import the **Vertical\_2\_Panel\_Line.txt** file under <Origin EXE Folder>\Samples\Graphing path.

	A(Y)	B(Y)	C(Y)	D(Y)	E(Y)	F(Y)	G(Y)	H(Y)
Long Name	Year	All Persons	All Males	All Females	Black Males	White Males	Black Females	White Females
Units								
1	1965	42.3	51.6	34	59.2	50.8	32.1	34.3
2	1974	37.2	42.9	32.5	54	41.7	35.9	32.3
3	1979	33.5	37.2	30.3	44.1	36.5	30.8	30.6
4	1983	32.2	34.7	29.9	41.3	34.1	31.8	30.1
5	1985	30	32.1	28.2	39.9	31.3	30.7	28.3
6	1987	28.7	31	26.7	39	30.4	27.2	27.2
7	1990	25.4	28	23.1	32.2	27.6	20.4	23.9
8	1991	25.4	27.5	23.6	34.7	27	23.1	24.2
9	1992	26.4	28.2	24.8	32	28	23.9	25.7
10	1993	25	27.5	22.7	33.2	27	19.8	23.7
11	1994	25.5	27.8	23.3	33.5	27.5	21.1	24.3
12								

2. Select column 2 to column 4, select **Plot > Basic 2D: Line + Symbol** main menu or click the **Line + Symbol** button on the **2D Graphs** toolbar.

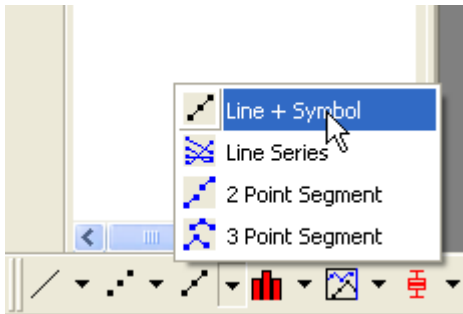

The following graph will be created:

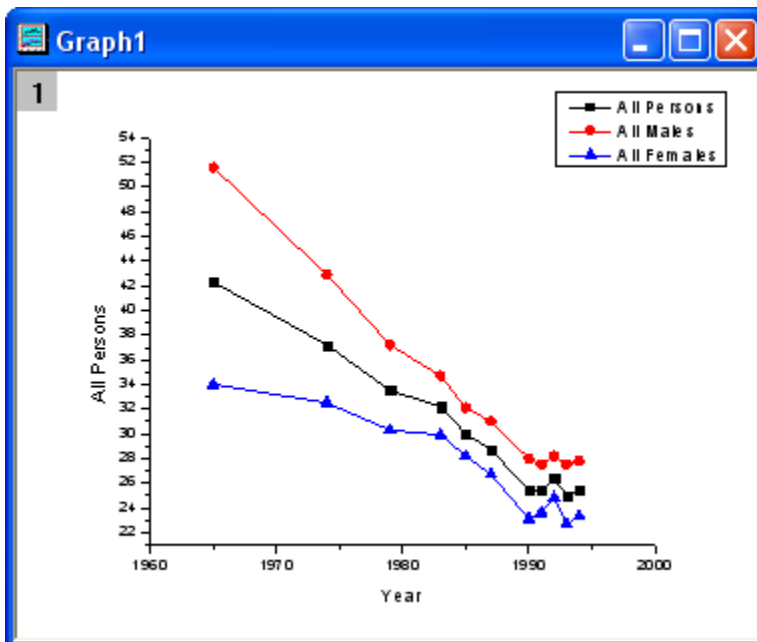

Go back to the worksheet. Select column 5 to column 8 and click the **Line + Symbol** button on the **2D Graphs** toolbar to create a new graph as shown below:

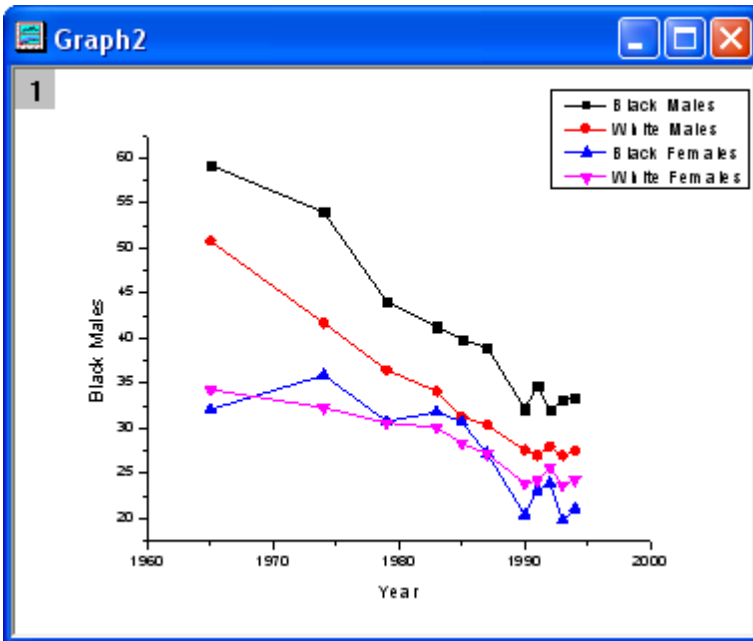

- To merge the two graphs, select **Graph: Merge Graph Windows** from the menu. Accept the default settings and click **OK**. The two graphs will merge in one window:

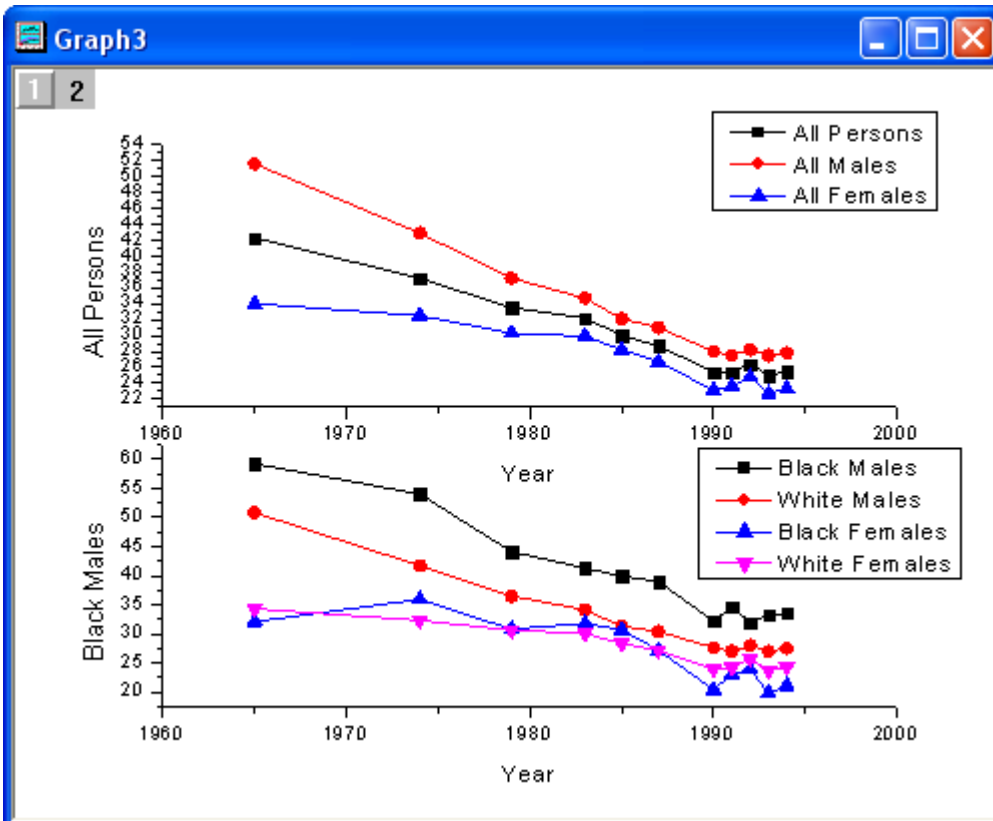

4. Ensure that Layer 1 is selected on the top left corner of the graph and double-click on the **Y** axis of Layer 1 to open the **Axis** dialog. In the **Scale** tab, set the dialog options as shown below:

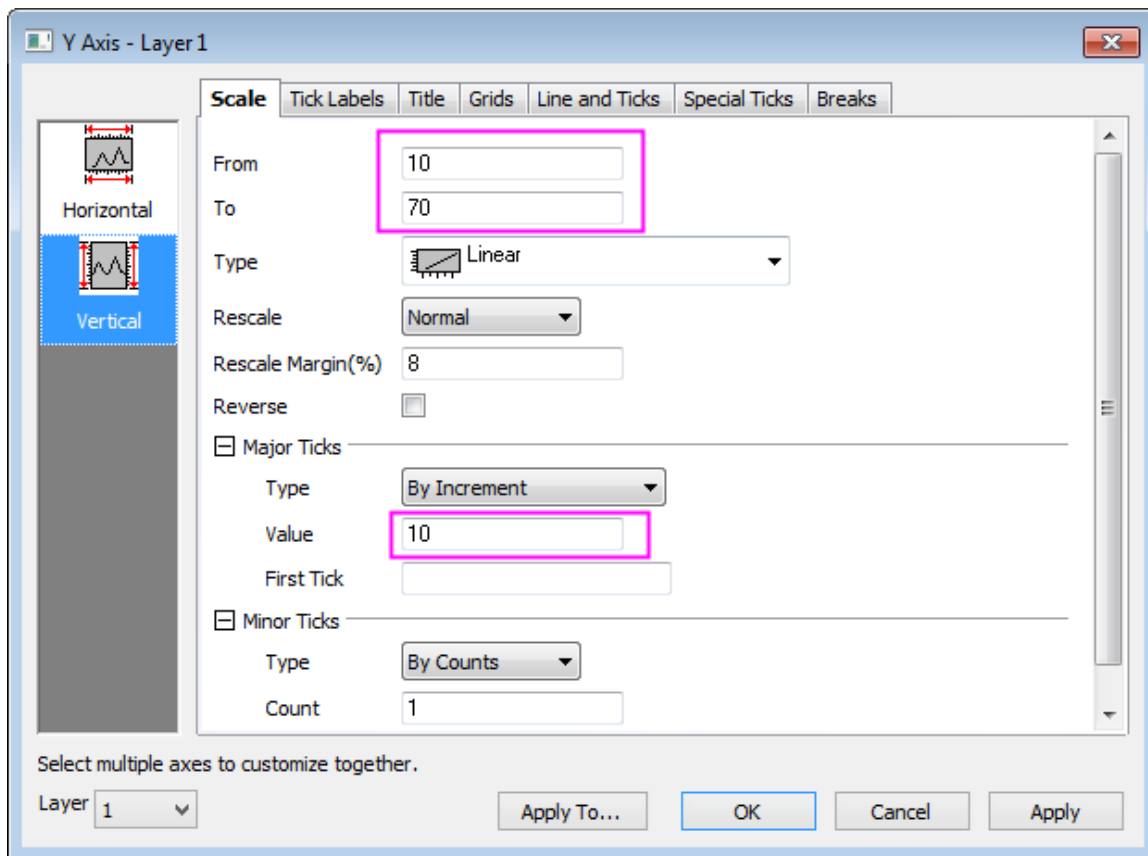

5. Click **Horizontal** icon on the left panel, and go to **Tick Labels** tab, uncheck the **Show** box to hide the tick labels in Layer 1 and click **OK** to apply settings.

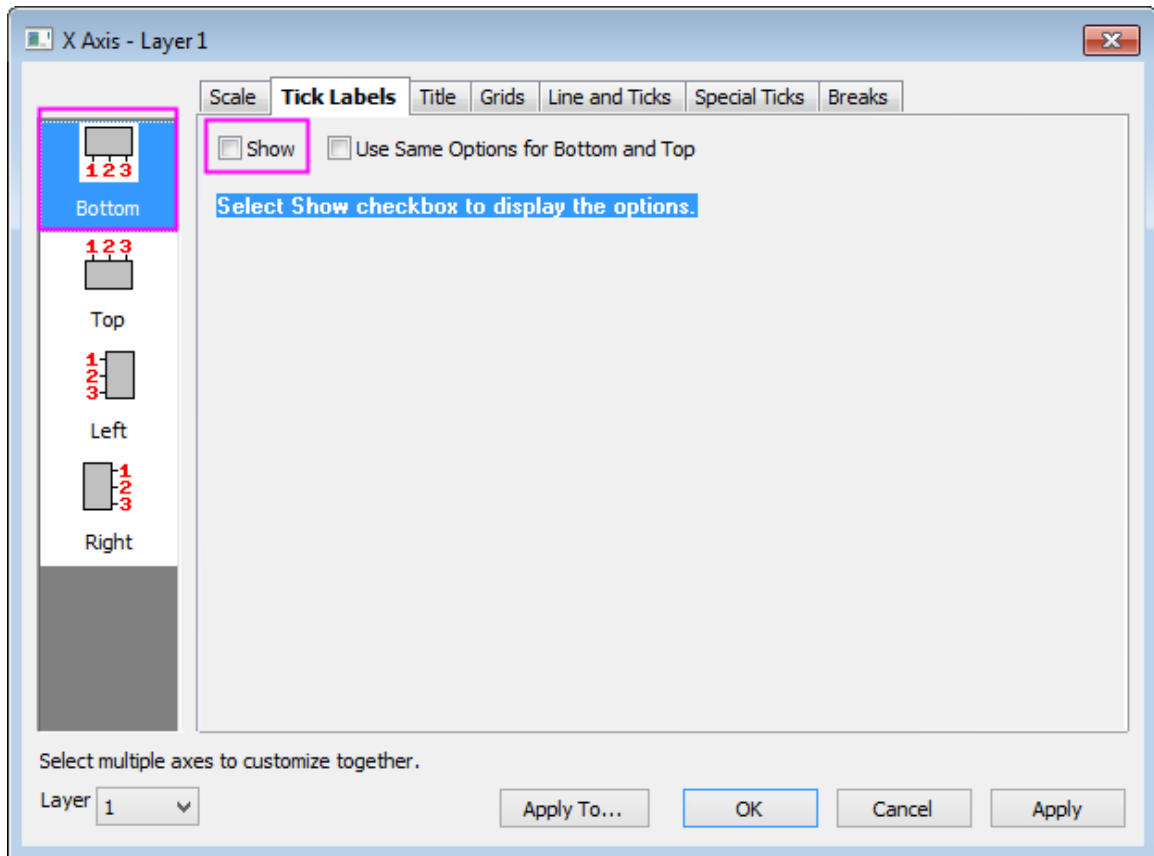

6. Delete the X axis title in Layer 1. Set the same scale for the Y axis of Layer 2. The graph should now appear as shown below:

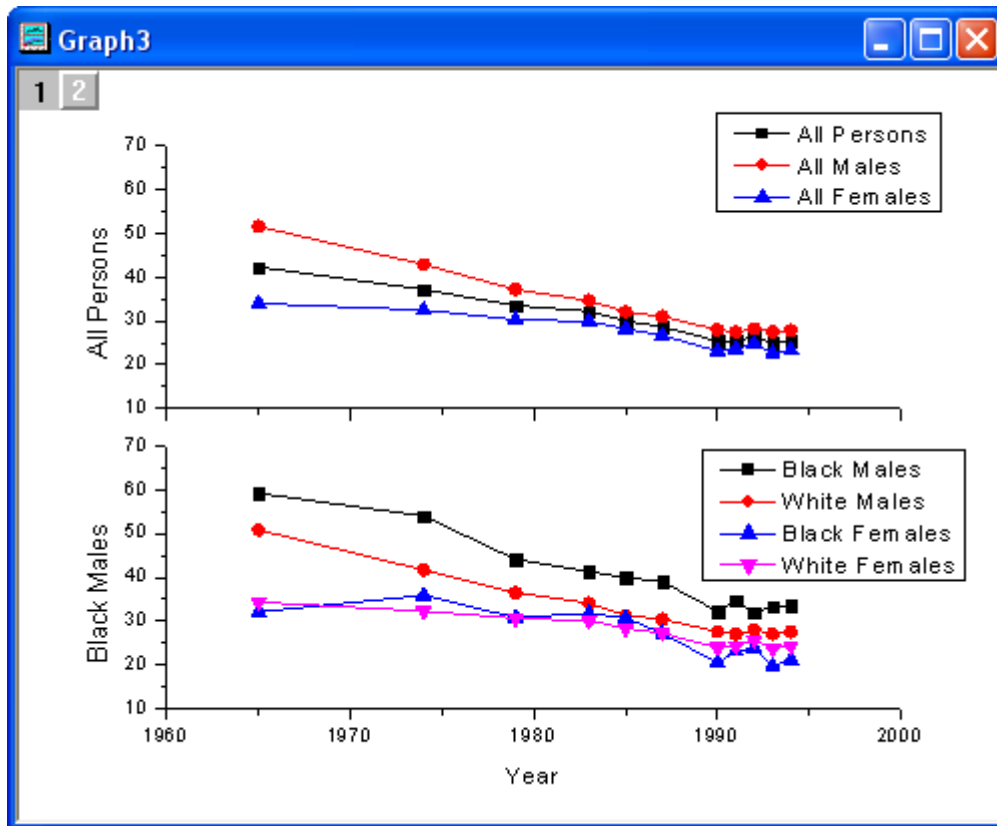

- Apply a theme to add a top **X** axis and a right **Y** axis. Select **Preferences: Theme Organizer** from the main menu to open the **Theme Organizer** dialog. Activate the **Graph** tab and select the **Opposite Lines** from the table and click the **Apply Now** button. Use the **Close** button to close the dialog.

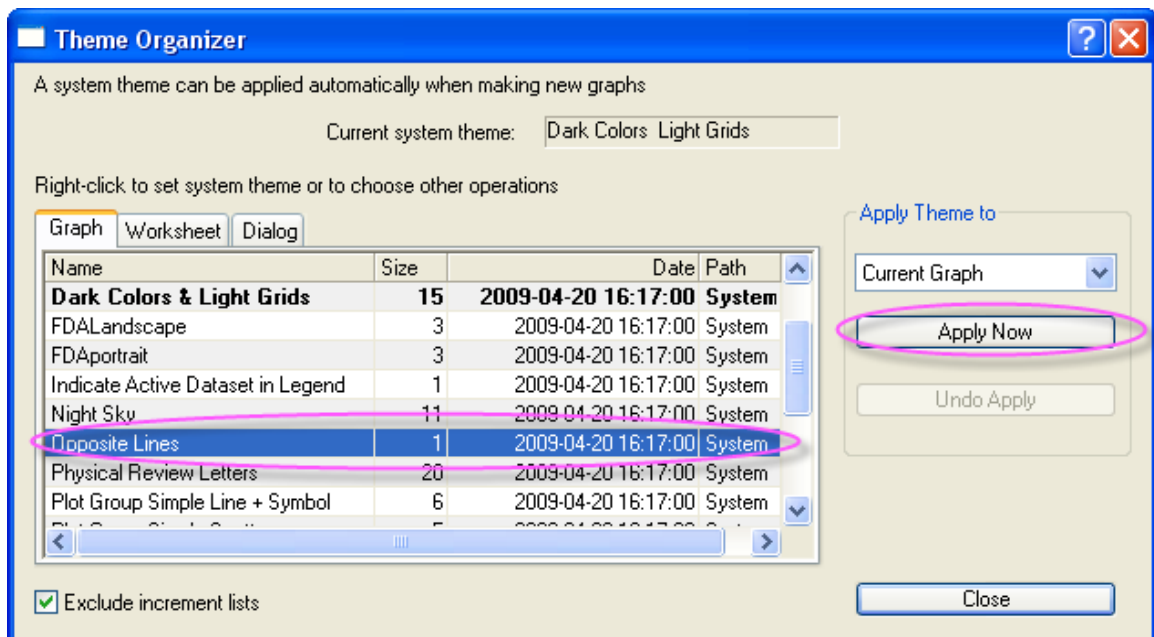

8. Select the **Legend** of Layer 1 and right-click on it to select **Properties** from the short-cut menu. Set the dialog options as shown below:

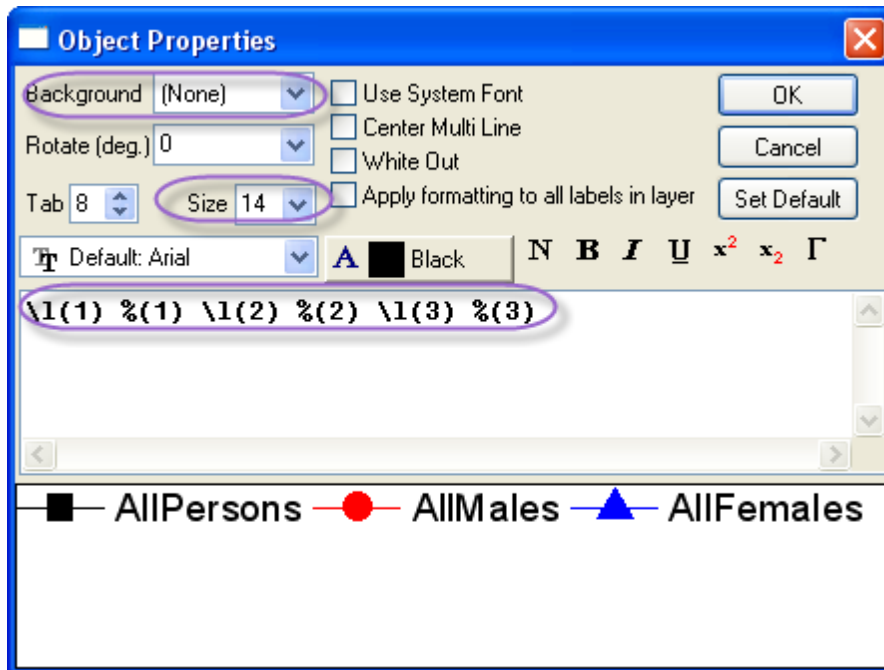

Move the legend to the desired position.

9. Select the **Line** button from the **Tools** toolbar and draw a line on the Layer 1 as shown in the sample image. Hold down the **SHIFT** key while drawing to ensure that the line is vertical. Double-click on the line to open the Properties dialog of the line object. In the **Line** tab, select **Dash** in the **Type** drop-down list and enter **2** in the **Width** edit box. Activate the **Control** tab. Select both the **Horizontal Movement** and the **Vertical Movement** check boxes. Click the **OK** button to finish.
10. Repeat steps **8-9** for Layer **2**.
11. Select the **Text** button in the **Tools** toolbar. To add a title for the graph click in the middle of the graph and enter **Cigarette Smoking by Persons 18 Years and Over in the United States**.  
Double-click on the **Y** axis title of Layer 1 and Layer 2 and enter **Percent Who Smoke**.

The final graph should appear as shown below:

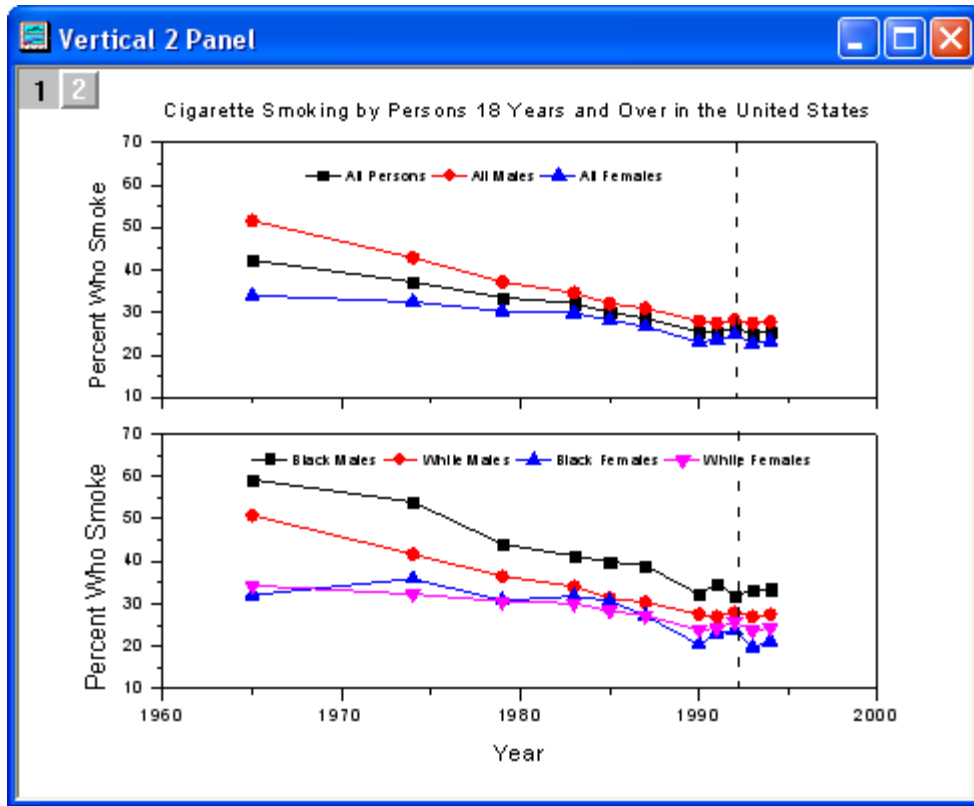

## 6.9.6 Multiple Axis Plot

### 6.9.6.1 Summary

This tutorial will demonstrate how to create a 4-Y plot and add recession bars.



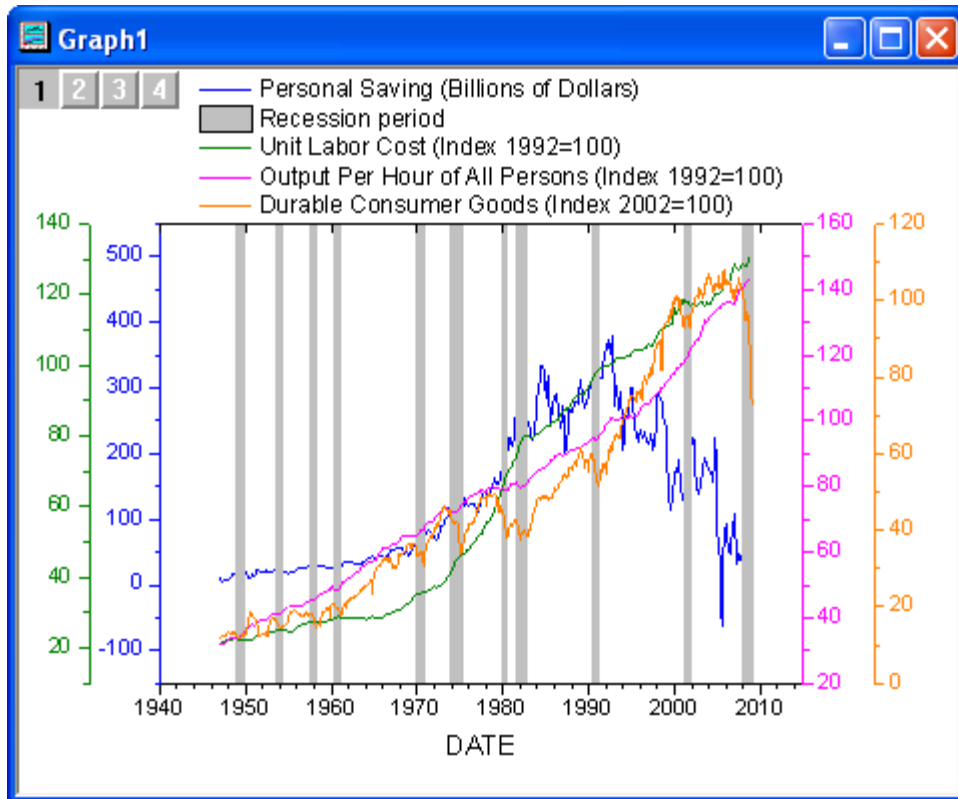

Minimum Origin Version Required: Origin 2015 SR0

#### 6.9.6.2 Steps

1. Create a new workbook, click the **Import Single ASCII** button  and import the **multi\_axis\_plot.txt** file under <Origin EXE Folder>\Samples\Graphing path.
2. Place the mouse cursor near the top left corner of the worksheet. When the cursor changes to a down-right arrow, left-click to select the whole worksheet.

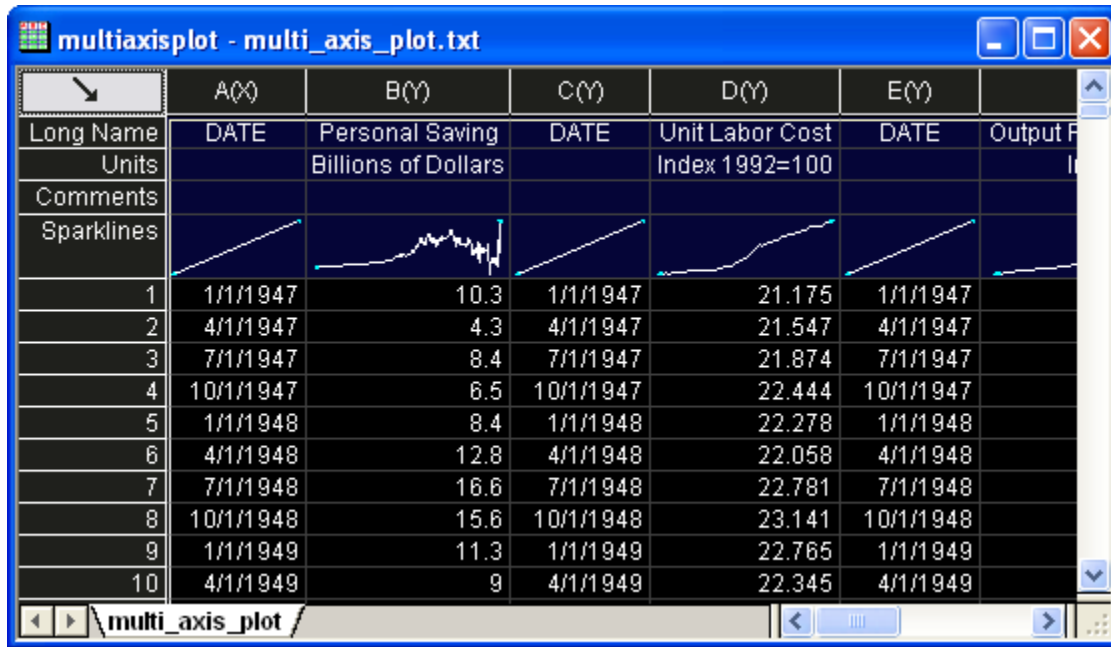

- Right-click and select **Set as: XY XY** from the short-cut menu to set proper plotting designations for the worksheet columns.

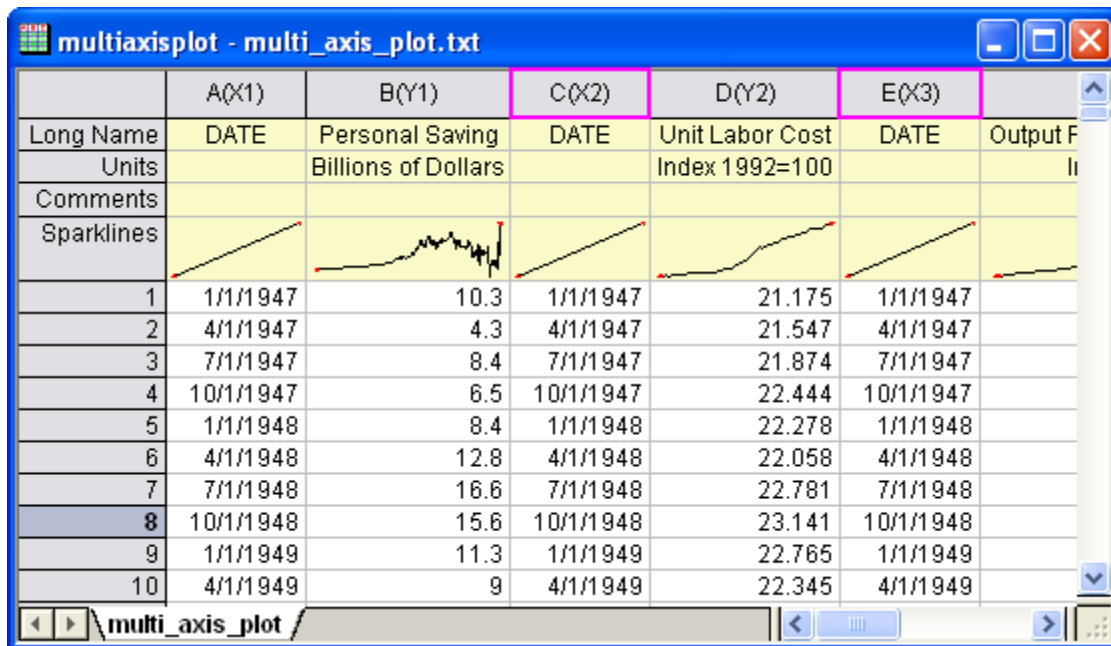

- Highlight all the columns. From the main menu, select **Plot > Basic 2D : 4Ys YY-YY** to create a plot as shown below:

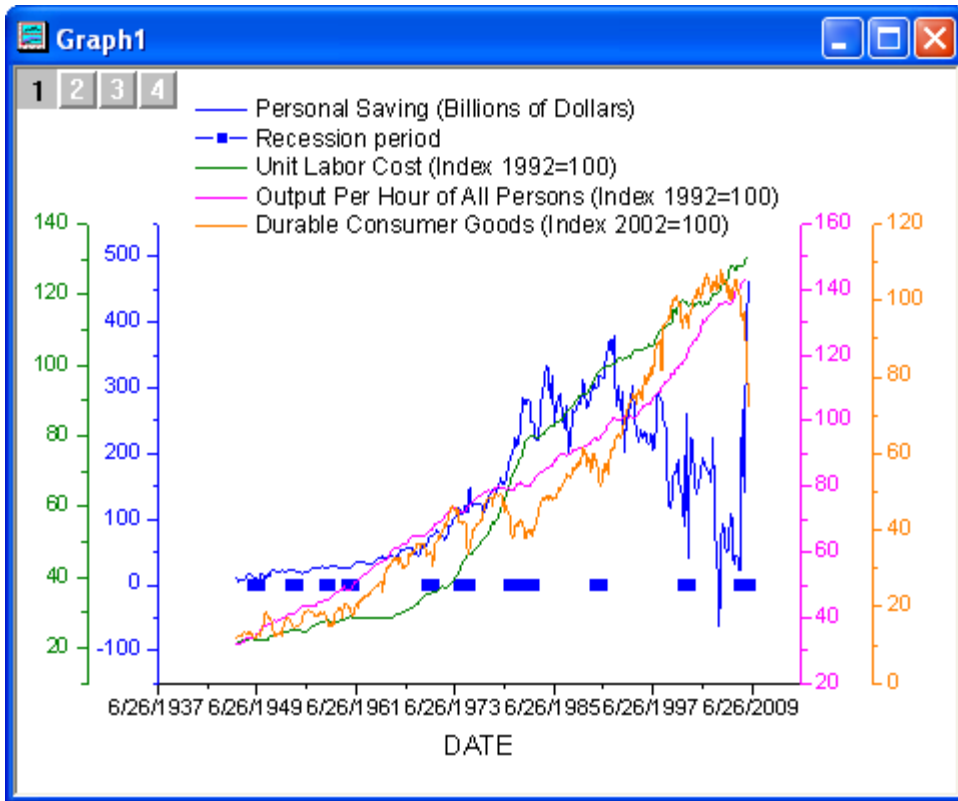

5. Double-click on the graph to open the **Plot Details** dialog shown below. In the left panel, select the second plot in Layer 1 and set the **Plot Type** option at the bottom of the dialog as Line. In the right panel **Line** tab, choose the settings shown below and **Apply**.

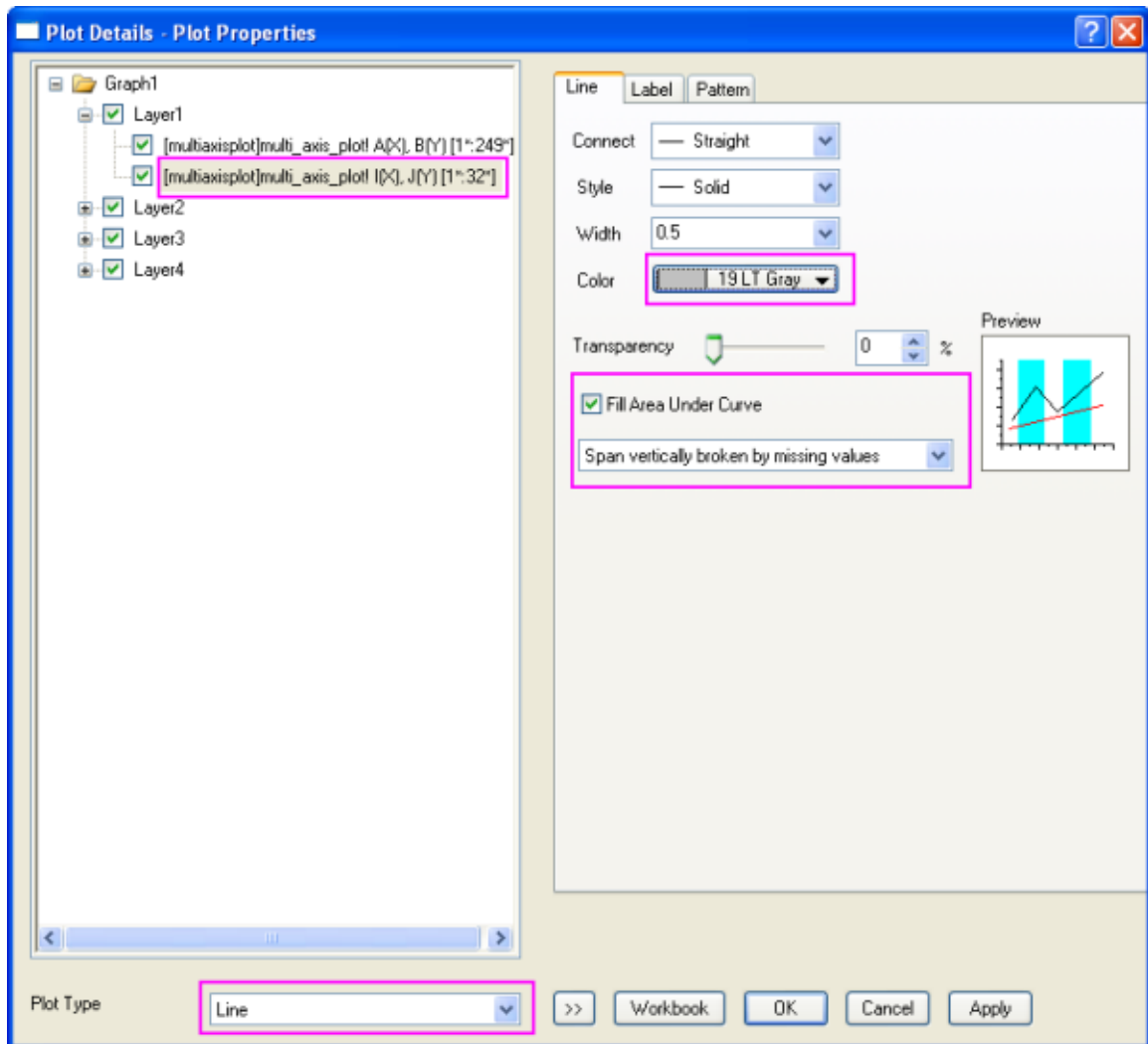

6. Select the **Pattern** tab. Set the dialog options as shown below and click **OK**.

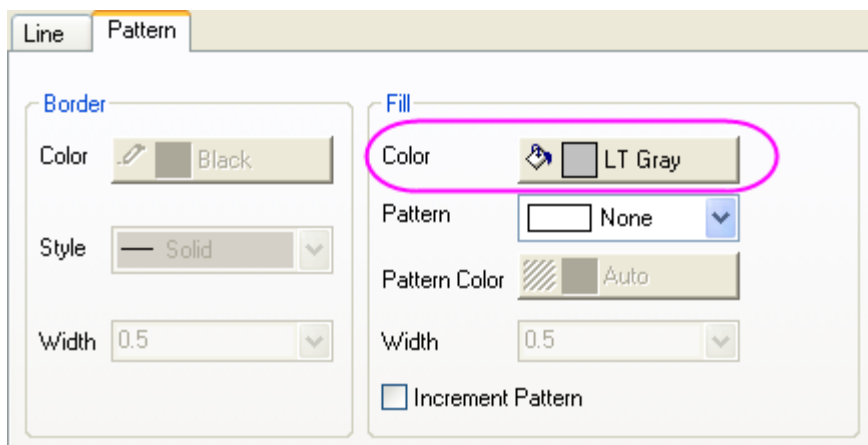

7. Ensure Layer 1 is selected in the top left corner of the graph and double-click on the bottom X axis to open the **Axis** dialog for Layer 1. On the **Scale** tab, change the dialog options as shown below and **Apply**.

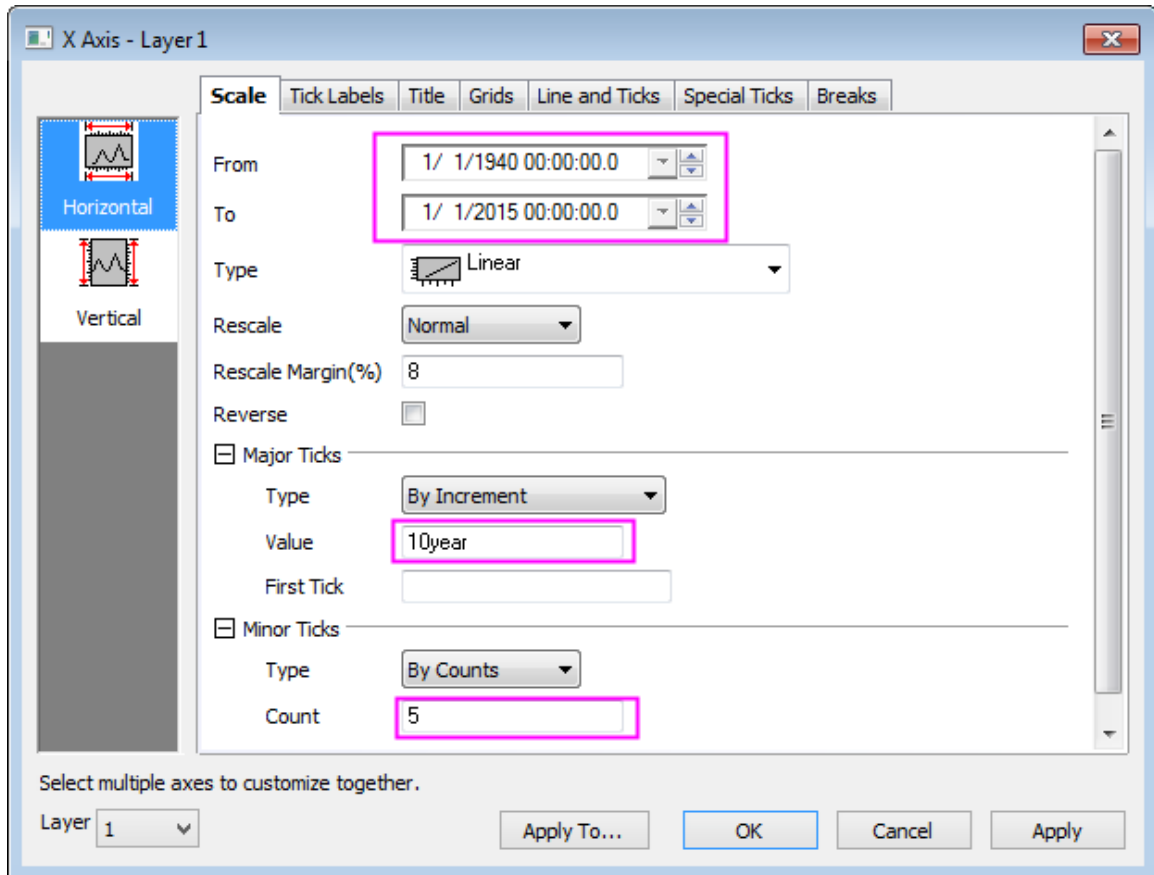

8. Go to **Tick Labels** tab, change the dialog options as shown below and **Apply**.

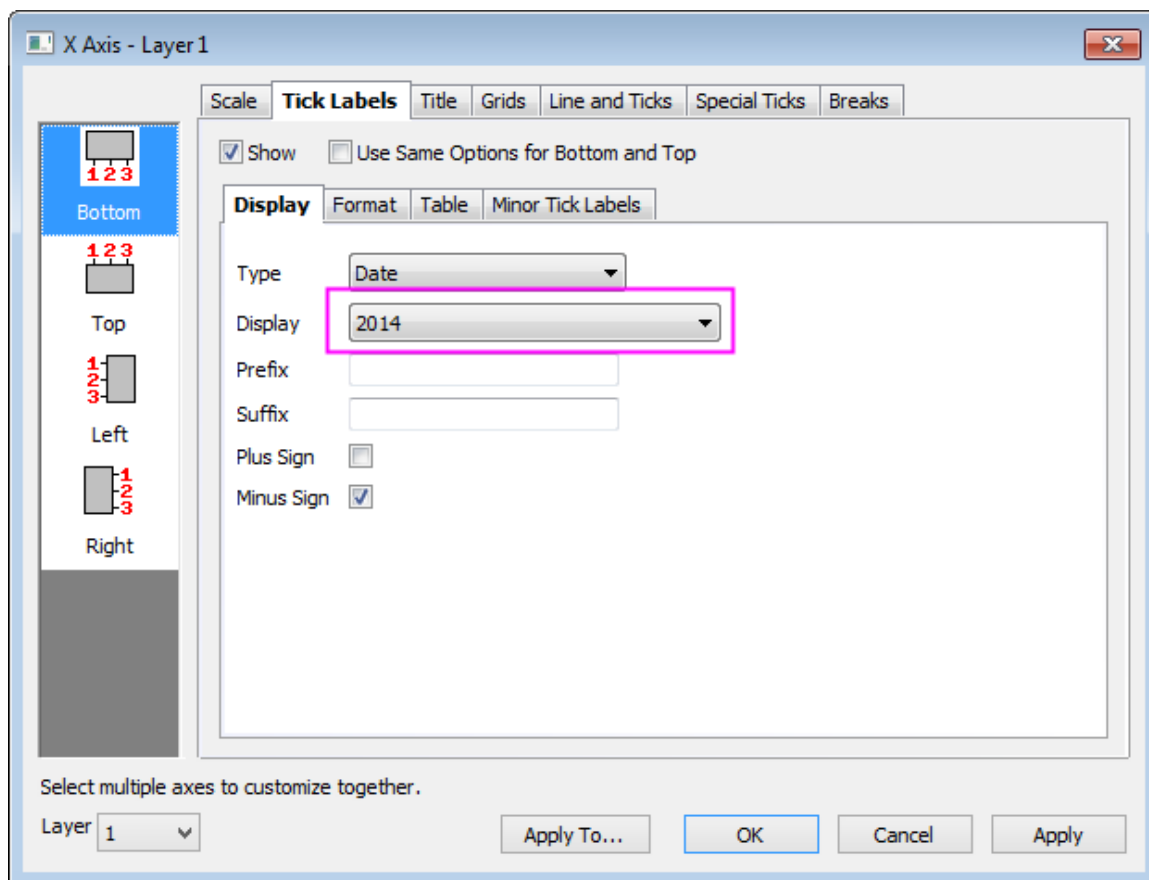

9. Go to **Line and Ticks** tab, click the **Top** icon on the left panel and check **Show Line and Ticks**. Then choose **In** for **Style** under **Major Ticks** and **None** for **Style** for **Minor Ticks** and click **OK** to apply settings.

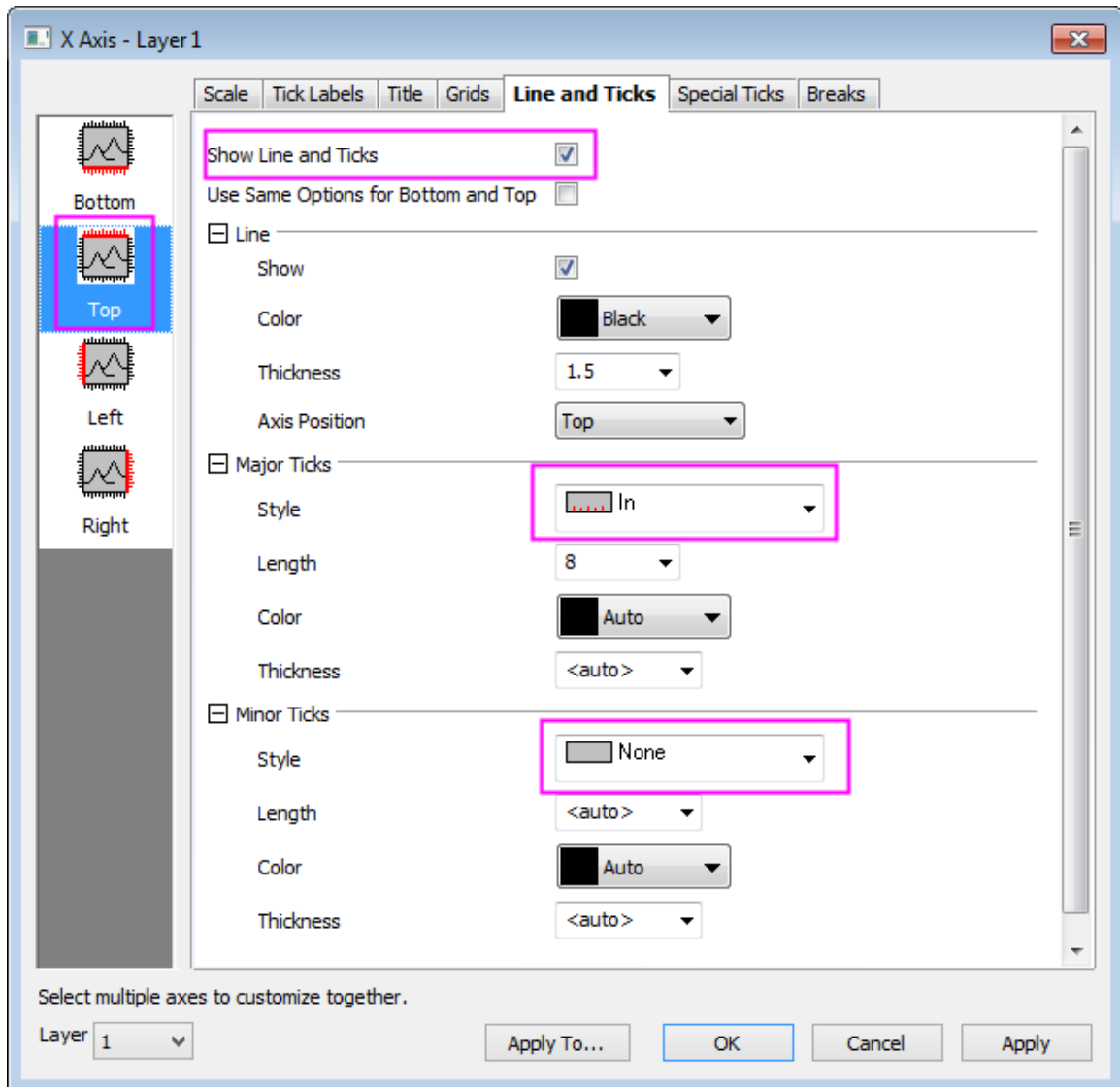

10. Click on the legend to select it and use the mouse to drag it to the desired position.

The final graph should appear as shown below:

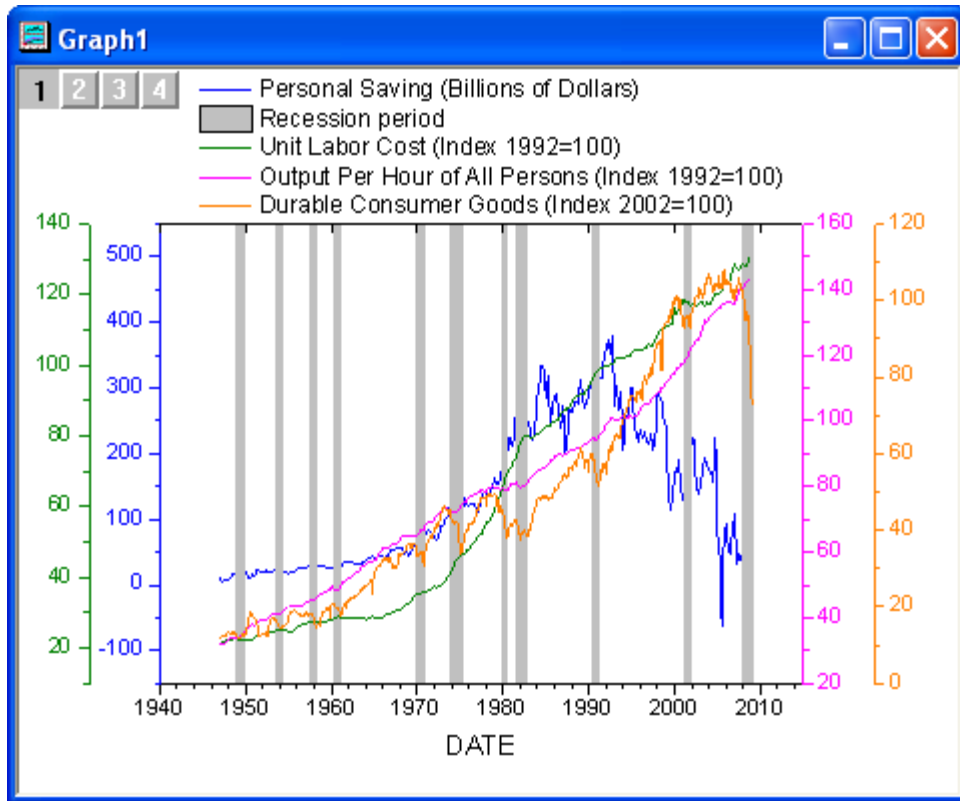

## 6.9.7 Energy-Level Structure of the Er<sup>3+</sup> Ion in A YAG Crystal

### 6.9.7.1 Summary

This tutorial will demonstrate how to create a graph showing the energy-level structure of the Er<sup>3+</sup> ion in a YAG crystal.



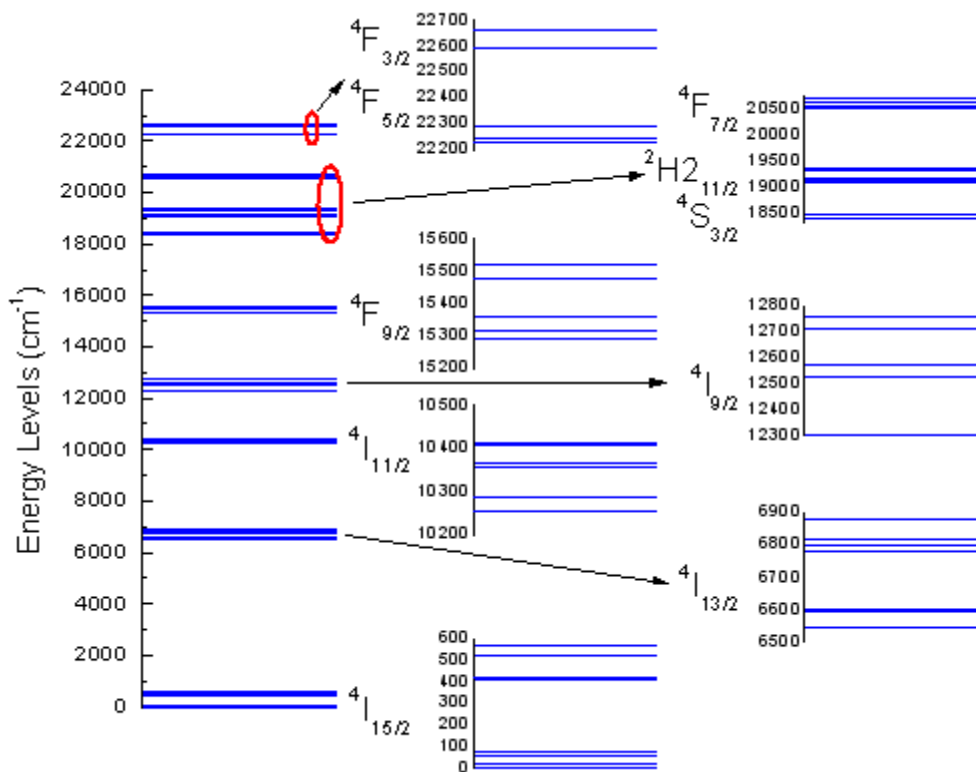

Minimum Origin Version Required: 2015 SR0

### 6.9.7.2 What you will learn

This tutorial will demonstrate how to:

- Create a graph by selecting part of the data from a column
- Set symbol properties
- Merge graphs
- Change the size and position of a layer

### 6.9.7.3 Steps

1. Start with an empty worksheet and use the **Single Import ASCII**  icon to browse to the `\Samples\Graphing` subfolder of the Origin program folder, and import the file **Van\_Rudd\_Er\_Energy\_Levels.txt**.
2. Highlight column B and create a symbol plot by selecting menu **Plot > Basic 2D : Scatter**.
3. Double click the data points scatter to open the **Plot Details** dialog. In the **Symbol** tab of the right panel, change the symbol and symbol color as shown below:

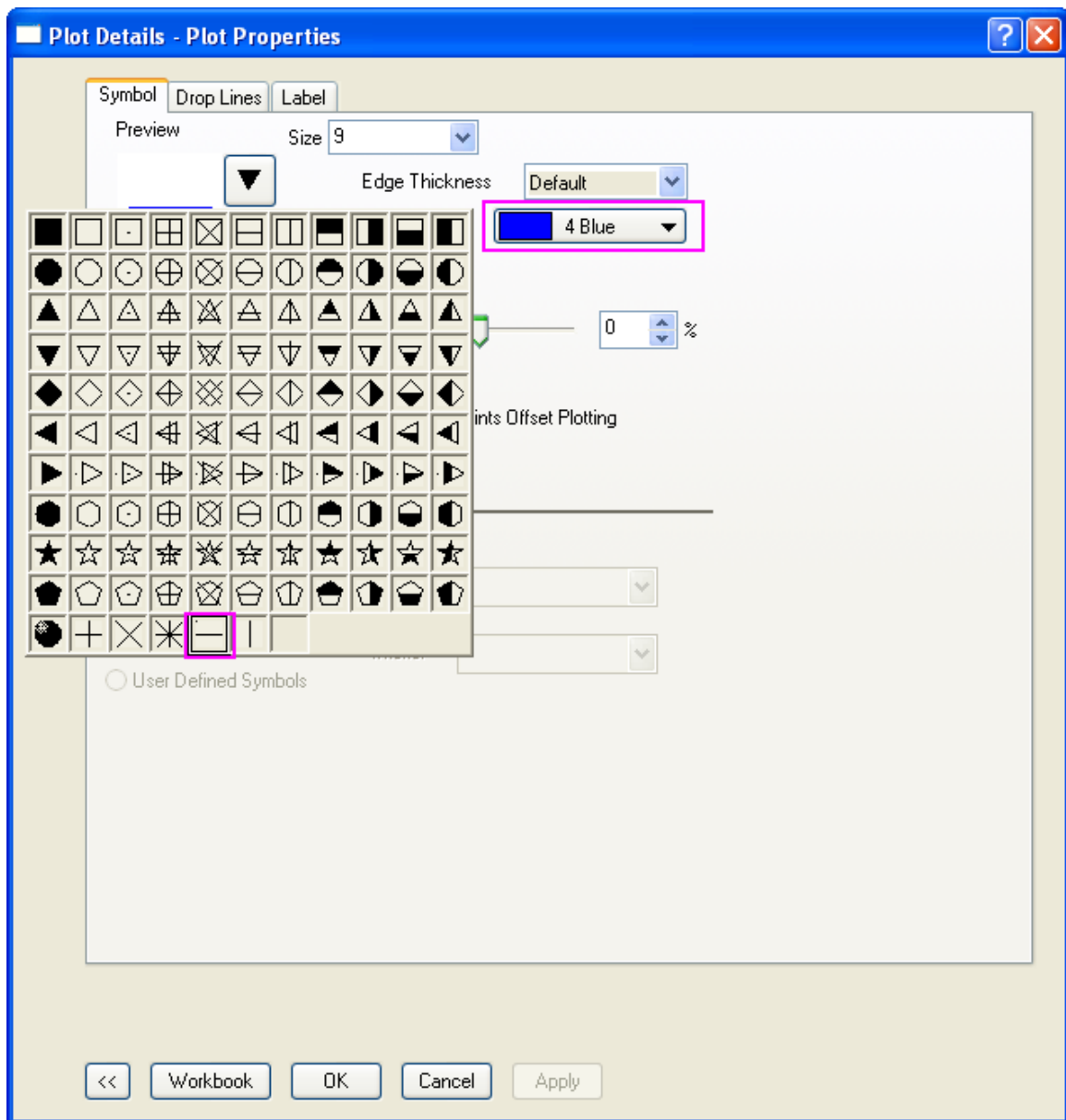

4. In the **Drop Lines** tab, check the **Horizontal** box and set **Width** to 1. Click **OK** to apply the changes.

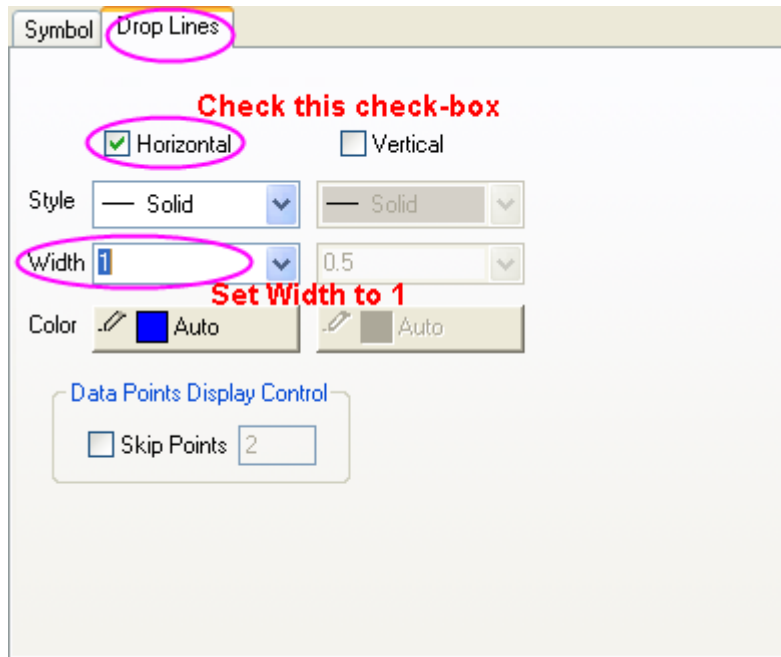

5. Double click on the X axis to open the **Axis** dialog. Set the X axis scale from 0 to 1 in the **Horizontal** icon in **Scale** tab :

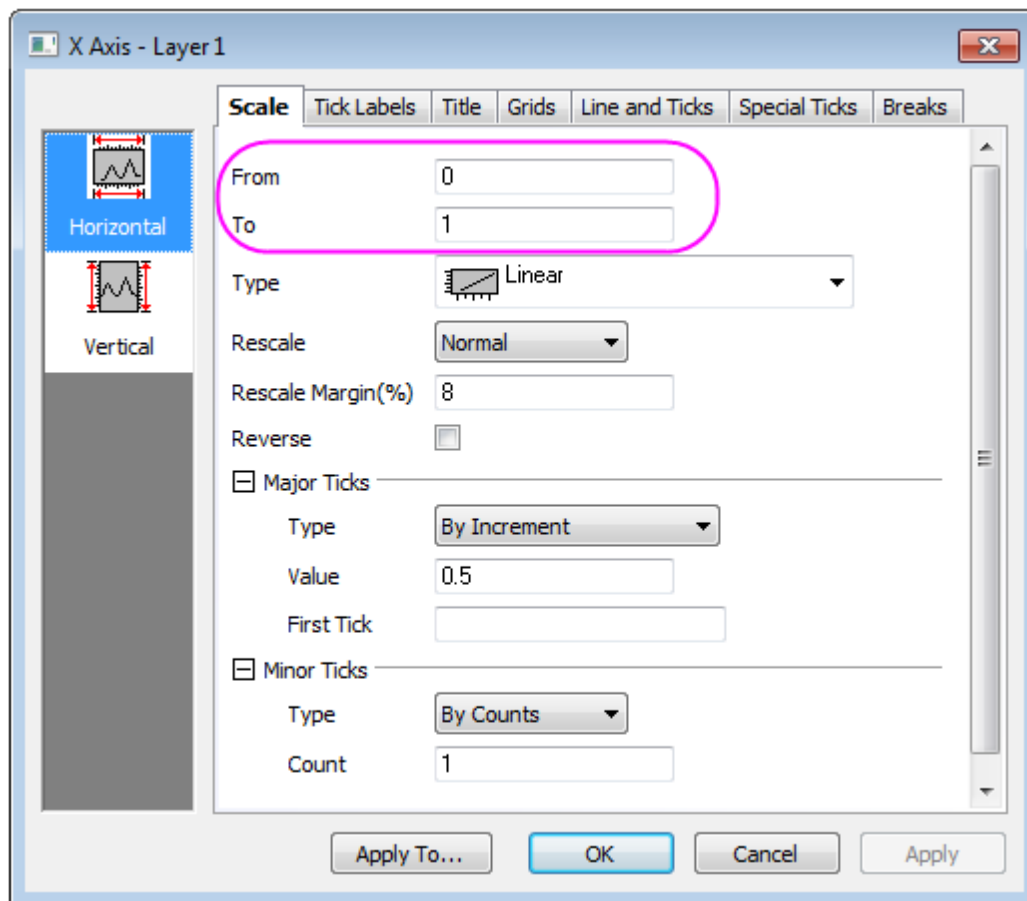

- Go to the **Line and Ticks** tab, **Tick Labels** tab, and **Title** tab respectively, make sure **Bottom** icon is selected and deselect the **Show Line and Ticks** or **Show** box to hide all elements in the bottom X axis including line & ticks, labels and title:

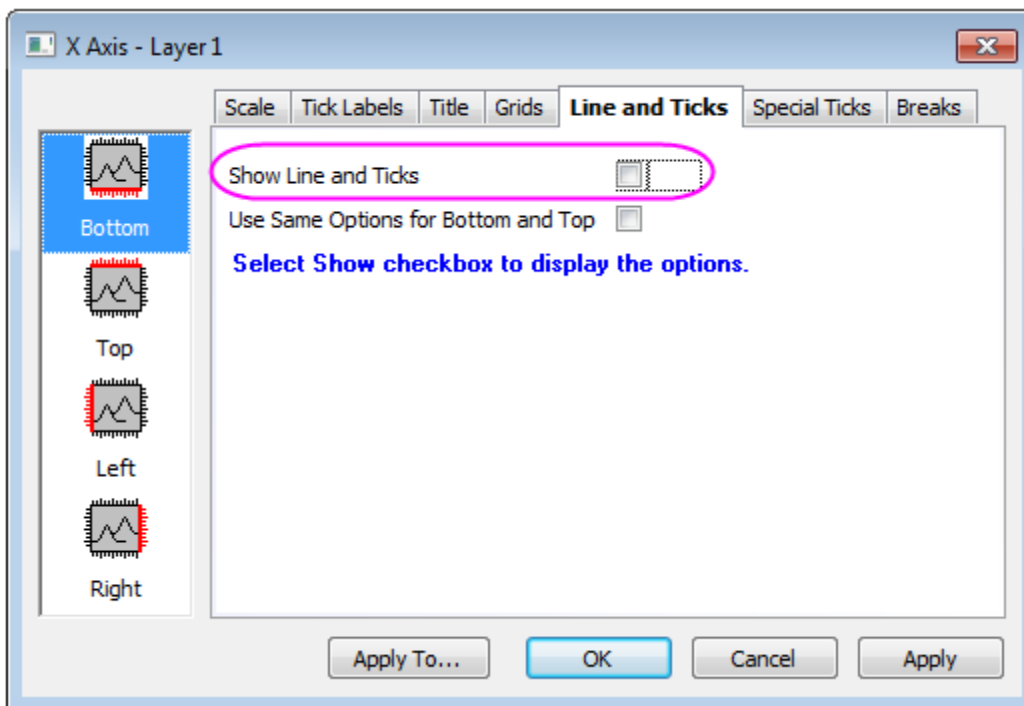

- In the **Vertical** icon in **Scale** tab, set the following for the Y axis scale: **From**: 0, **To**: 24000, **Value**(in *Major Ticks* Group): 2000.
- Go to **Left** icon in **Title** tab, change the **Text** for the Y axis title to *Energy Levels (cm<sup>-1</sup>)*:

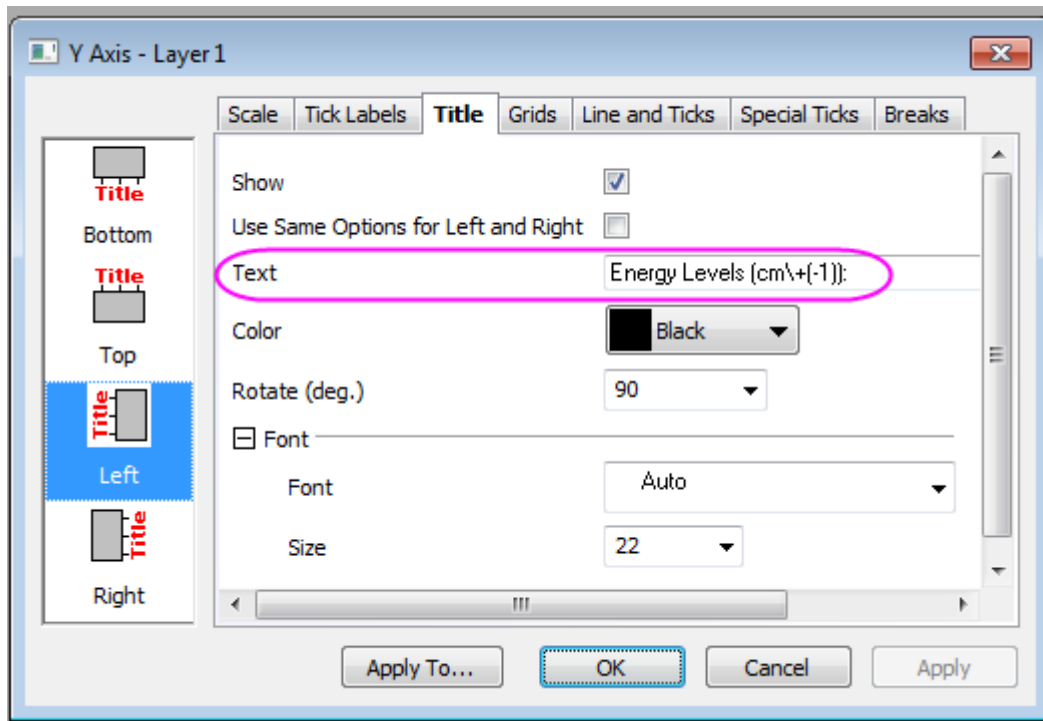

9. Go to the the **Left** icon in **Line and Ticks** tab, select **In** from the drop down menu for *Major Ticks* and *Minor Ticks*:

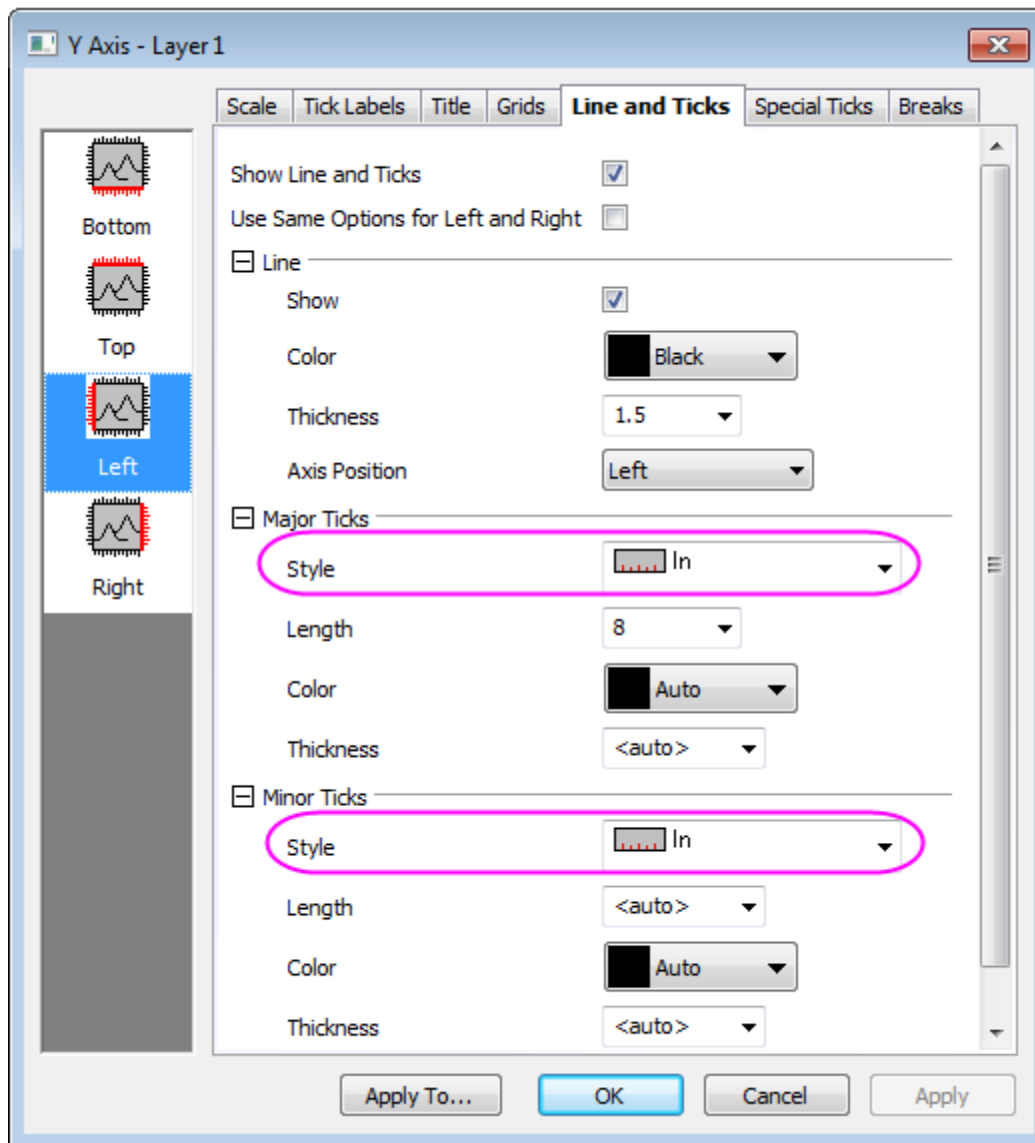

10. Use **OK** to save the axis settings. Delete the legend object in the graph by selecting it, right-clicking and choosing delete from the drop down menu. The graph should appear as shown below :

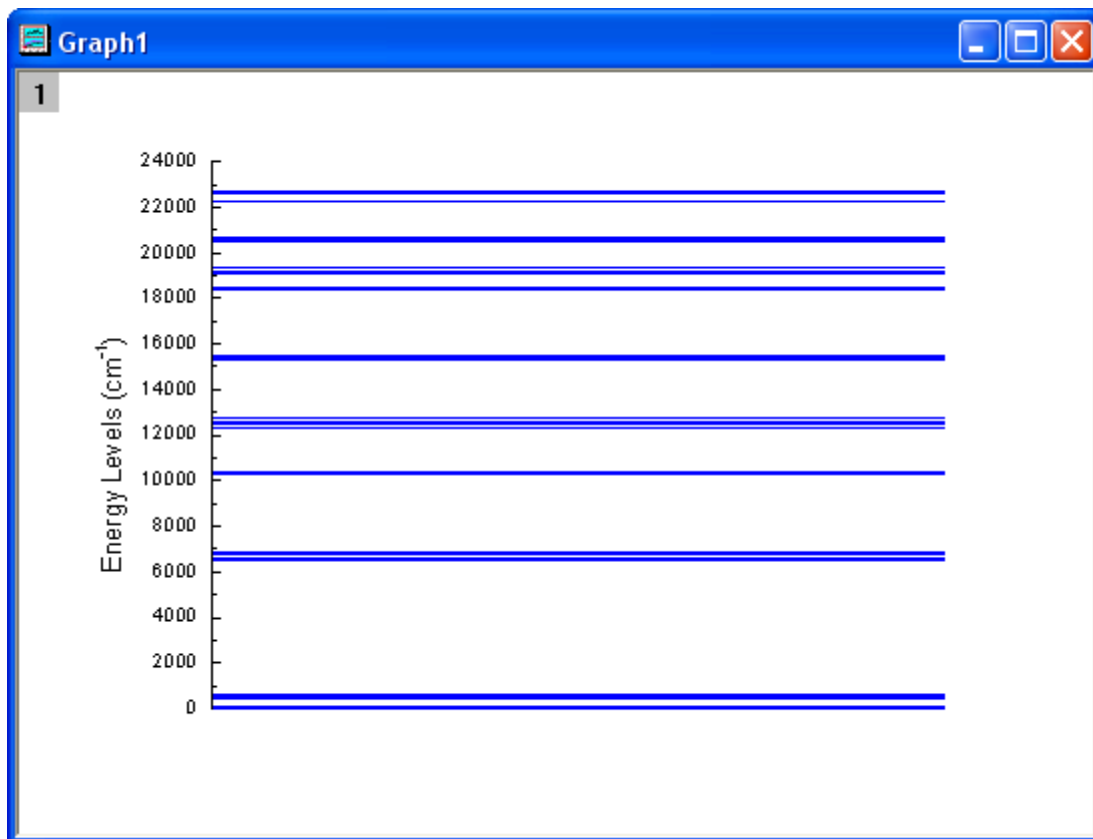

11. Highlight cell 1-8, cell 9-15, cell 16-21, cell 22-26, cell 27-31, cell 32-43, and cell 44-48 respectively, to plot scatter graphs by selecting menu **Plot > Basic 2D : Scatter** and then repeat step 3 through step 11 to make another 7 graphs. Set the increment value of the Y axis (step 7) to 100, and the **From** and **To** values as 0 to 600, 6500 to 6900, 10200 to 10500, 12300 to 12800, 15200 to 15600, 18300 to 20800, 22200 to 22700, respectively. The **Title in Y axis** (step 8) are also different and should be set as  $\psi^{(4)}I^{-(15/2)}$ ,  $\psi^{(4)}I^{-(13/2)}$ ,  $\psi^{(4)}I^{-(11/2)}$ ,  $\psi^{(4)}I^{-(9/2)}$ ,  $\psi^{(4)}F^{-(9/2)}$ ,  $\psi^{(4)}F^{-(7/2)}$ ,  $\psi^{(2)}H2^{-(11/2)}$ ,  $\psi^{(4)}S^{-(3/2)}$ , and  $\psi^{(4)}F^{-(3/2)}$   $\psi^{(4)}F^{-(5/2)}$ , respectively. Then set the Y axis **Major Ticks** and **Minor Ticks** to **None**.
12. In order to change the rotation angle of the Y title created in step 9, select the Y title, choose **Properties** from the right-click menu and set the **Rotate(deg.)** to 0 in the **Object Properties** dialog that opens.

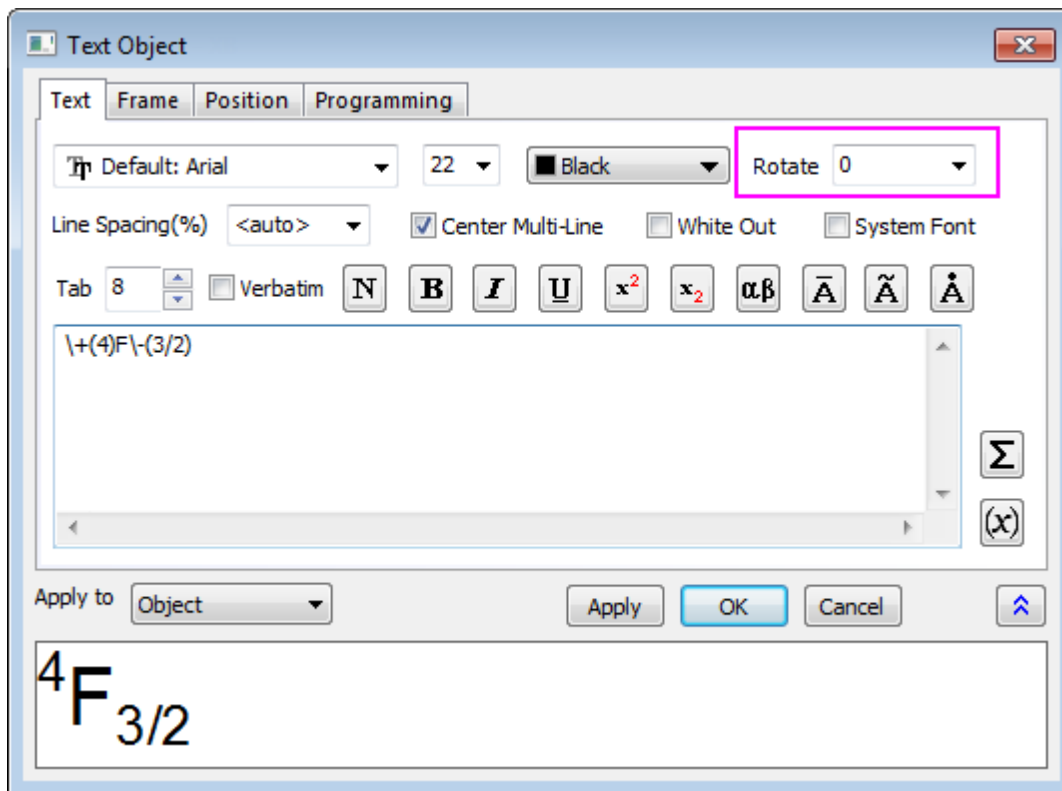

13. Activate one of the graphs and select menu **Graph: Merge Graph Window**. Change the settings as shown below and click the **OK** button to merge the 8 graphs previously created.

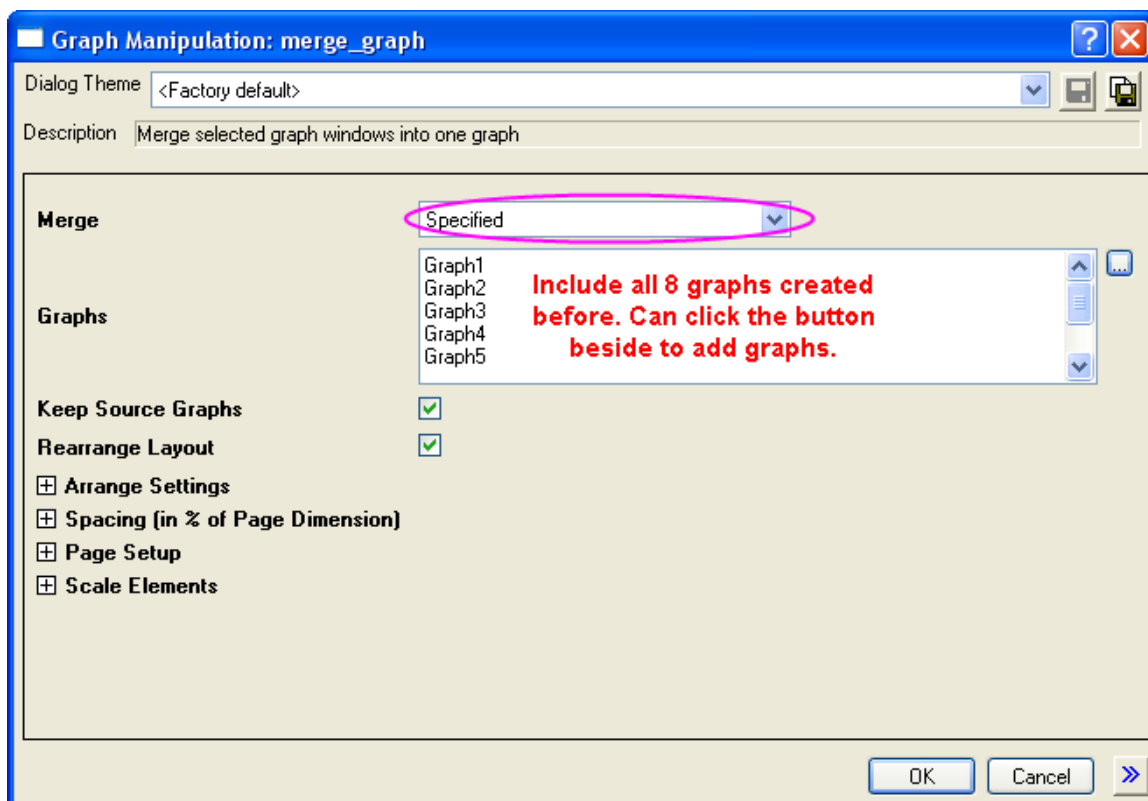



14. Double click on the merged graph to open the **Plot Details** dialog. In the **Size/Speed** tab of Layer 1, change the **Layer Area** as shown below:

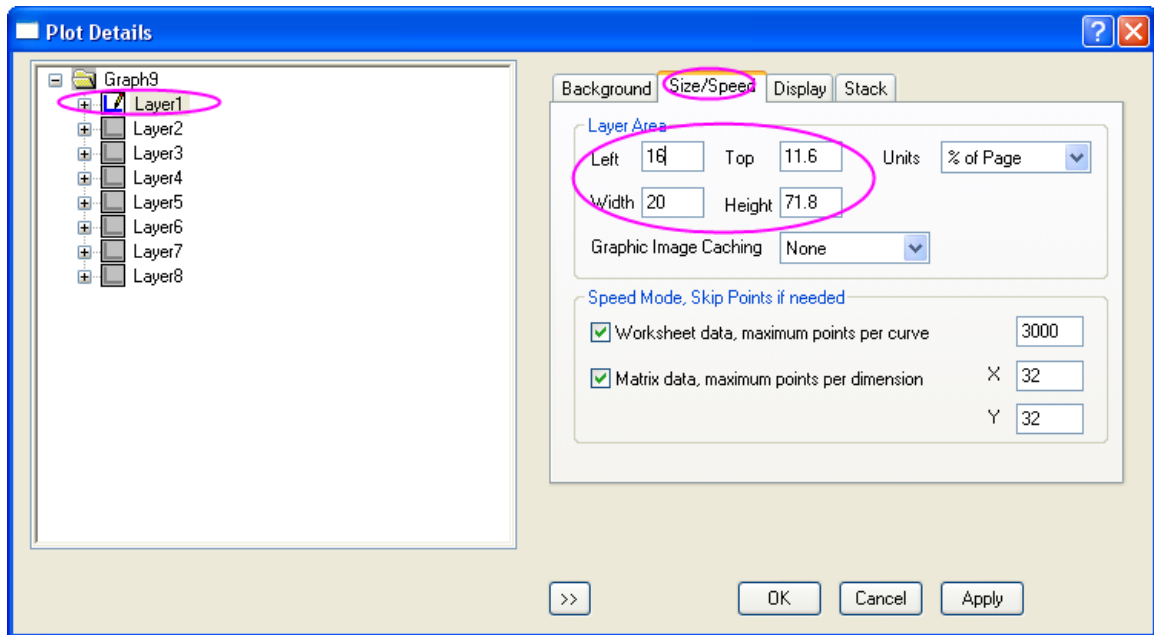

15. Set the other layers' sizes to 15 x 15 (Width and Height in step 15), and move them to the desired position. Adjust the size of the Y axis label and add the corresponding arrows and circles. The graph should appear as shown below:

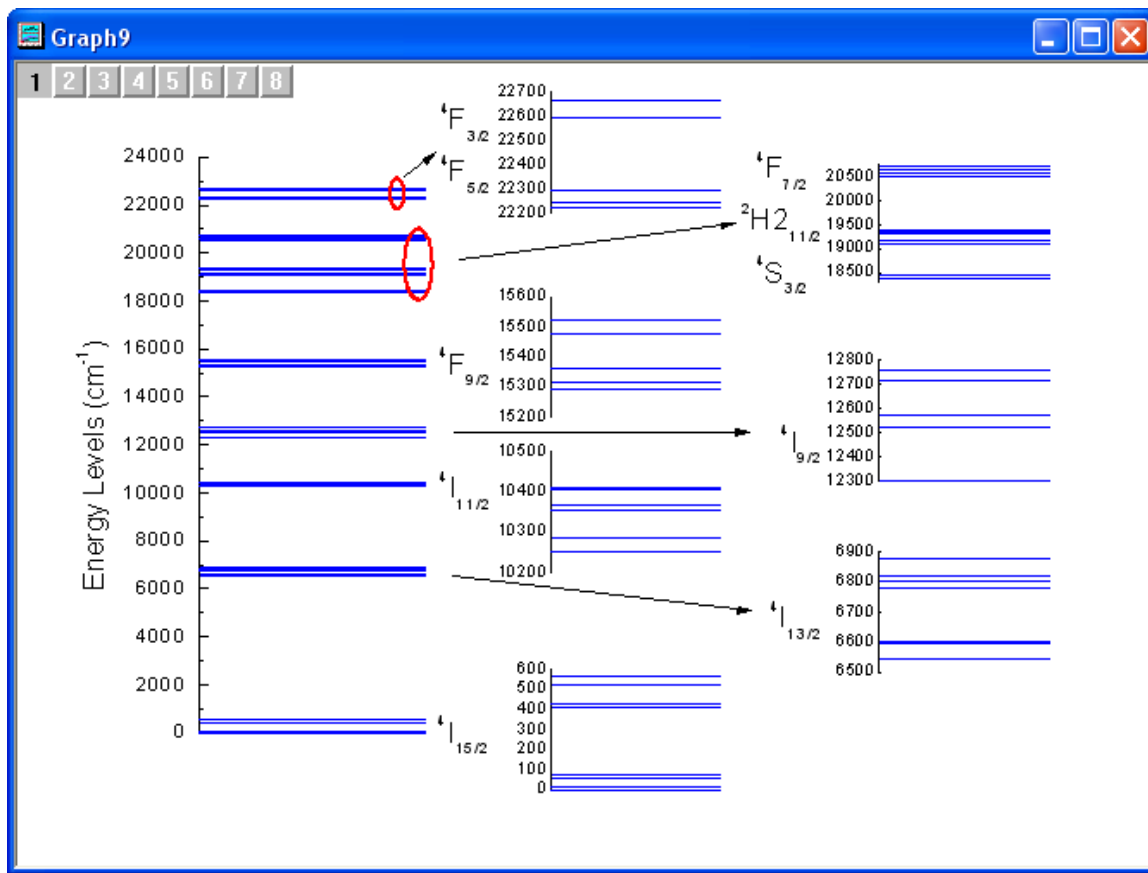

## 6.9.8 Create an 8 layer multi-panel plot template

### 6.9.8.1 Summary

All child windows in Origin, with the exception of the Notes window, are created from template files. These template files describe how to construct the window. For a graph window, the template file determines all page and layer characteristics, such as page size, number of layers, inclusion of text labels and data plot style information to name a few.

Minimum Origin Version Required: 2016 SR0

### 6.9.8.2 What you will learn

This tutorial will show you how to:

- Create an 8 layer multi-panel plot
- Apply axis settings from one axis to all axes
- Save a graph template
- Reuse the template with similar data

### 6.9.8.3 Steps

### 6.9.8.3.1 Choosing the Data Source

1. Click the **New Project** button on the Standard toolbar, to begin a new project.
2. Open **Import Wizard** using the Import Wizard button on the Standard toolbar. (Note that if this is the first time that you have started the Import Wizard, you will experience a slight delay as Origin compiles the necessary files.)
3. Verify that the **ASCII** radio button is selected in the **Data Type** group.
4. Click the browse button to the right of the File text box. Navigate to the Origin folder; browse to the Samples folder and then the Curve Fitting folder. Select Step01.dat from the list of files.
5. Click the **Add File(s)** button and save changes with **OK**.
6. Leave the **Import Filters for current Data Type** as **Data Folder: step**. (This filter has the settings to use when importing the file.)
7. Click the **Finish** button. The data file imports into the worksheet.

### 6.9.8.3.2 Plotting the Data

1. Highlight the entire worksheet of data. (Note that you can select an entire worksheet by placing your cursor in the blank area in the upper left corner of the worksheet. When the cursor becomes a downward pointing arrow, click once to select the entire worksheet.)
2. Select **Plot > Basic 2D :9 Panel**. A new 9 layer graph with 9 graphs is created.
3. Select the empty graph and ensure the 9th layer on the top left corner of the window is selected. Pressing the **Delete** key will now delete this graph and this layer leaving 8 graphs on 8 separate layers behind.
4. Select **Graph:Layer Management**. In the **Layer Management** dialog that opens select the **Arrange** tab.
5. Set **Number of Rows** to 4 and **Number of Columns** to 2.
6. Clicking the **Apply** button gives a preview in the small window on the right side of the dialog, showing a 2x4 arrangement.
7. Click **OK** to save the changes.

### 6.9.8.3.3 Editing the Graph

The goal is to save this 8 panel graph as a template; i.e. a new plot type, so that it can be used again with new similar data. Since the template will also save plot style information, we will customize the graph a bit further.

1. Double-click on the X axis in layer 1. The **Axis** dialog opens.
2. Select the **Grids** tab, check the **Show** boxes under both **Major Grid Lines** and **Minor Grids Lines** tree node to display major and minor grid lines for X axis.
3. Set the **Color** for both Major and Minor grids to **LT Gray**.
4. Click **Apply to...** button to open the **Apply To** dialog, make sure the **Apply From** is chosen as **Bottom**.
5. Select the check box **All Below** and then select **This Window** in the drop-down menu.
6. Click the **OK** button to apply the same setting to all axes in all layers of this graph page.

### 6.9.8.3.4 Saving as a new graph template

1. Select **File:Save Template As**. A dialog opens allowing you to choose the category that the template will be saved in as well as the name given to the new template.

2. Change the **Template Name** to **PAN8**. (Note that the **Template Name** that appears when the dialog opens is the name of the original template that was used to create the graph.)
3. Select the option **Mark as Cloneable Template**.
4. Click OK.

#### 6.9.8.3.5 Plotting into your new template

1. Click the **New Folder** button on the Standard toolbar.
2. Click the **Import Wizard** button on the Standard toolbar. The Import Wizard opens.
3. Click the browse button to the right of the File text box. Navigate to the Origin folder; browse to the Samples folder and then the Curve Fitting folder. Select Step02.dat from the list of files.
4. Click the **Add File(s)** button.
5. Click **OK**.
6. Leave the **Import Filters for current Data Type** as **Data Folder: step**. (This filter has the settings to use when importing the file.)
7. Click the **Finish** button. The data file imports into the worksheet.
8. Highlight the entire worksheet of data. (Note that you can select an entire worksheet by placing your cursor in the blank area in the upper left corner of the worksheet. When the cursor becomes a downward pointing arrow, click once to select the entire worksheet.)
9. Select **Plot: Templates: Template Library** to open **Template Library** to select **PAN8** to plot.

### 6.9.9 Panel Graph with Inset Plots of High-resolution Electron Energy-loss Spectra

#### 6.9.9.1 Summary

Origin can be used to create a three panel graph with inset plots similar to the image shown below:

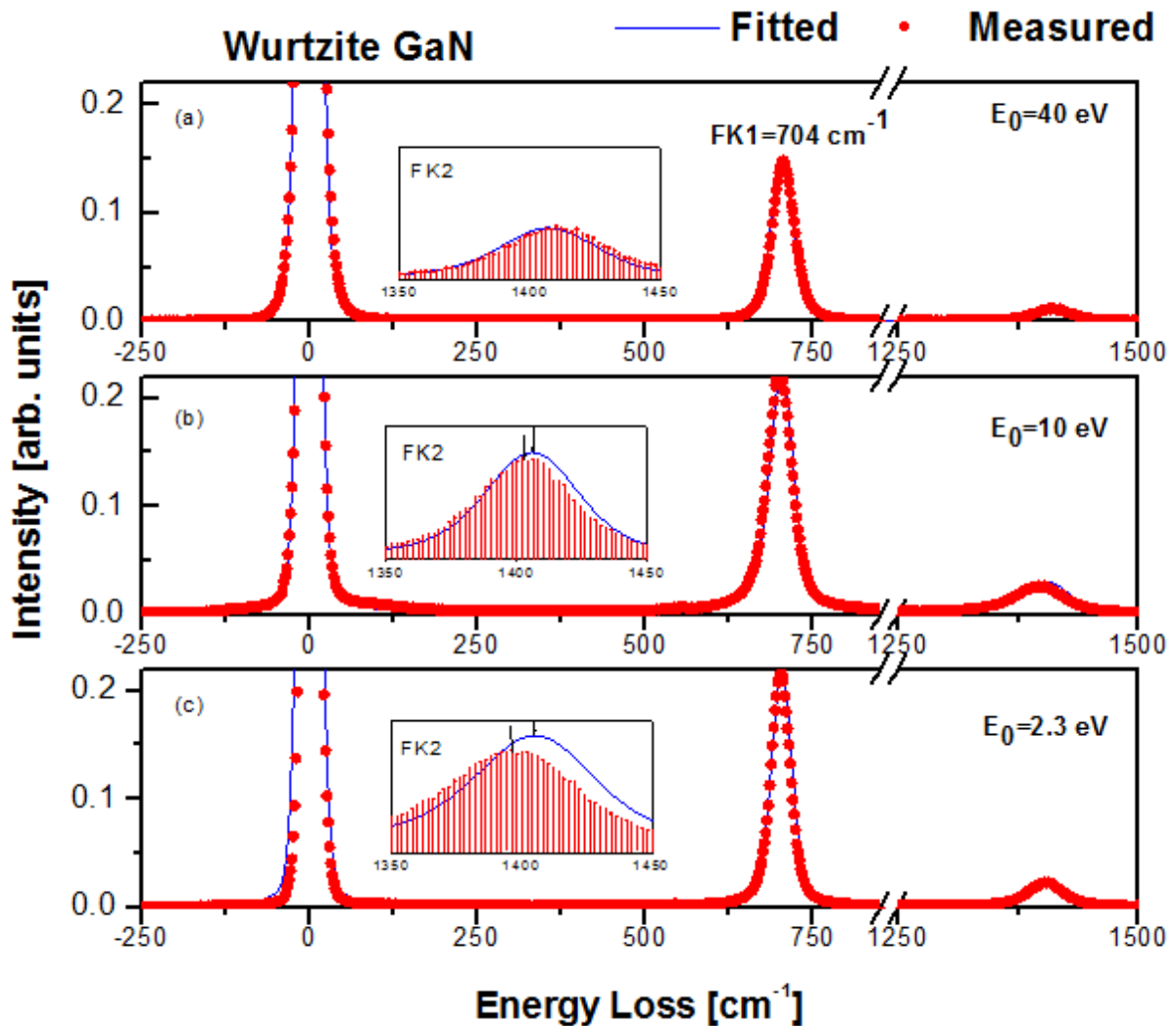

Minimum Origin Version Required: 2015 SR0

### 6.9.9.2 What you will learn

This tutorial will demonstrate how to:

- Use the **Plot Setup** dialog to create curves on one graph using data from multiple workbooks.
- Add Inset Graphs.
- Copy and Paste Style formats.
- Use the **Layer Management** dialog to link axes.



### 6.9.9.3 Steps

#### 6.9.9.3.1 Using the Plot Setup dialog

This tutorial is associated with <origin exe folder>\Samples\Tutorial Data.opj.

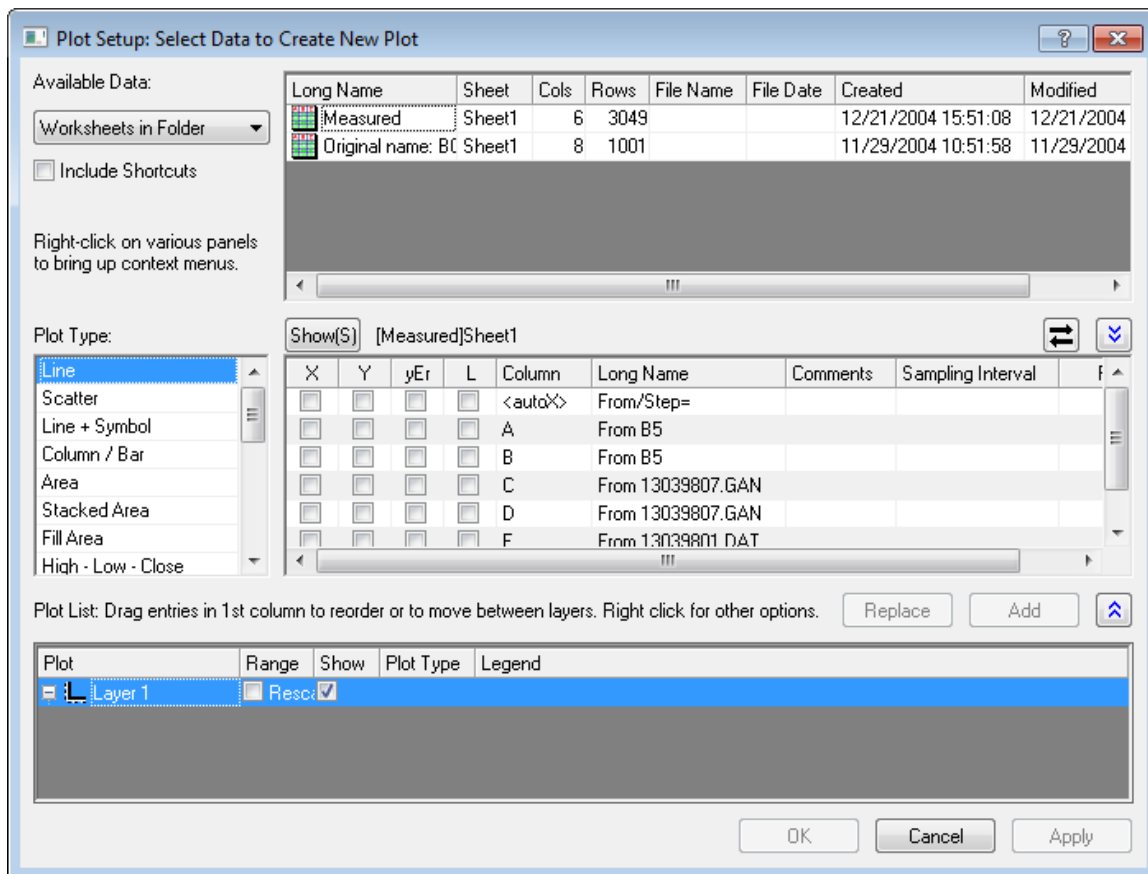
1. Open the Tutorial Data.opj and go to the folder *Three Panel Graph with Inset Graphs*.
2. Activate the workbooks **Measured** and **Original name: BOS**.
3. Ensure that nothing is selected in either workbook and click the line button  on the **2D Graphing** toolbar.
4. This will bring up the **Plot Setup** dialog box.



In order to show all three panels in **Plot Setup** dialog, please expand **Plot Type** panel by clicking  and expand **Available Data** panel by clicking  again.

Please refer to [Plotting using Plot Setup](#) for more information.

- Under **Available Data** select the **Worksheets in Folder** option from the drop-down list. This will ensure that in the panel to the right, data is available from all the workbooks in the current folder.

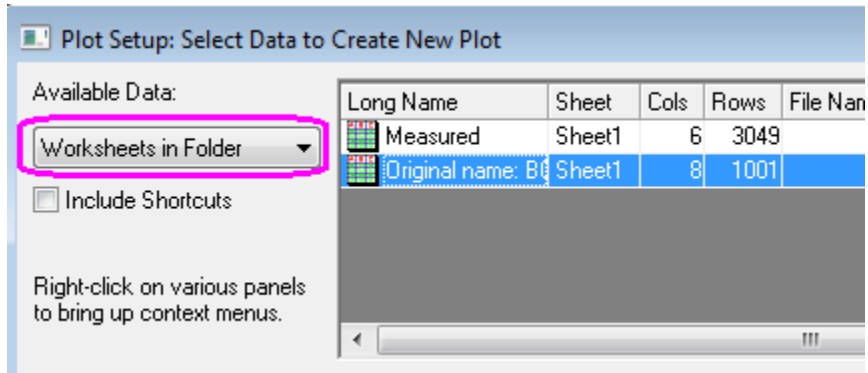

- Make sure that the **Original name: BOS** worksheet is selected as shown above. In the center panel enable the box corresponding to **X** and **A4** and the second box corresponding to **Y** and **B4**.
- This will set col(A4) as the X values and col(B4) as the Y values regardless of column designation in the workbook. Select **Add** and a new curve will be created in the pre-existing Layer on the third panel:

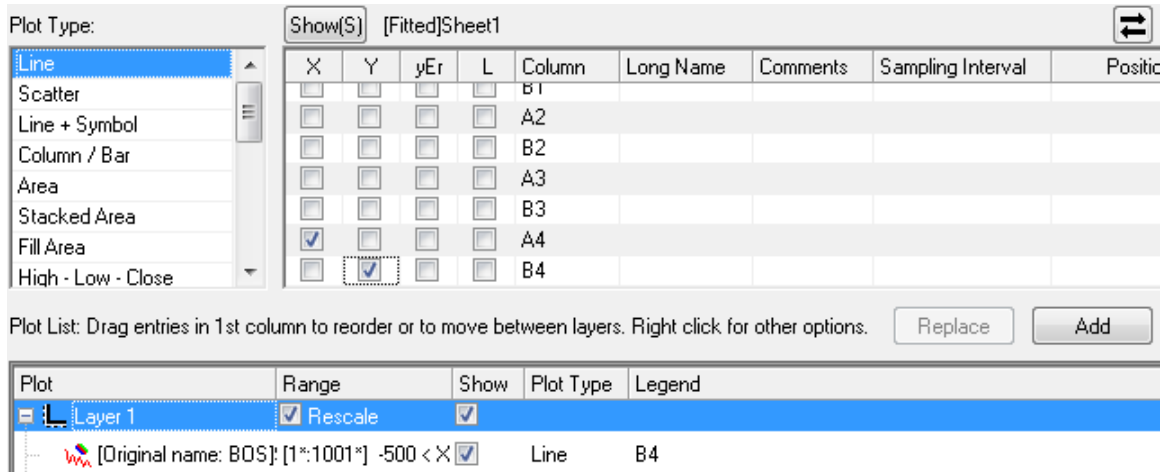

- On the first panel, change the highlighted workbook to **Measured**.
- On the left, set **Plot Type** to **Scatter**.

10. On the second panel, select the check boxes as shown below:

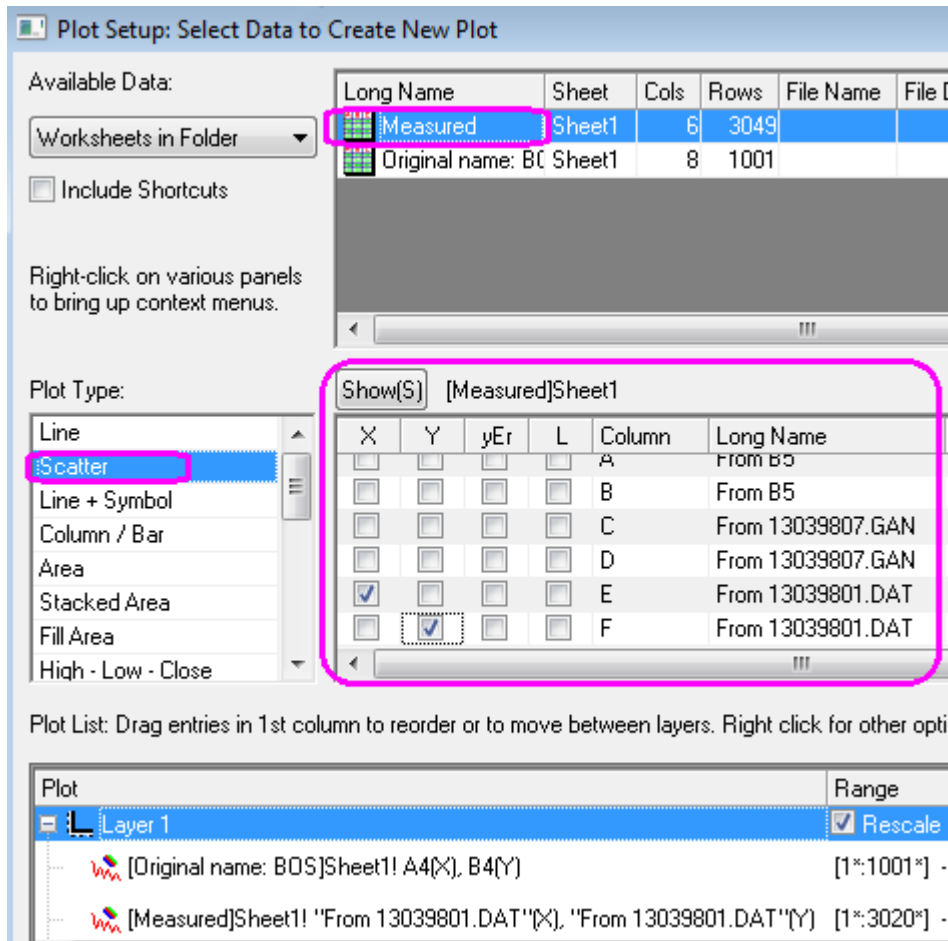

11. Select **Add** and the plot will be added to the Layer in the third panel. Select **OK** to close the dialog box. Your graph should look like the one shown below:

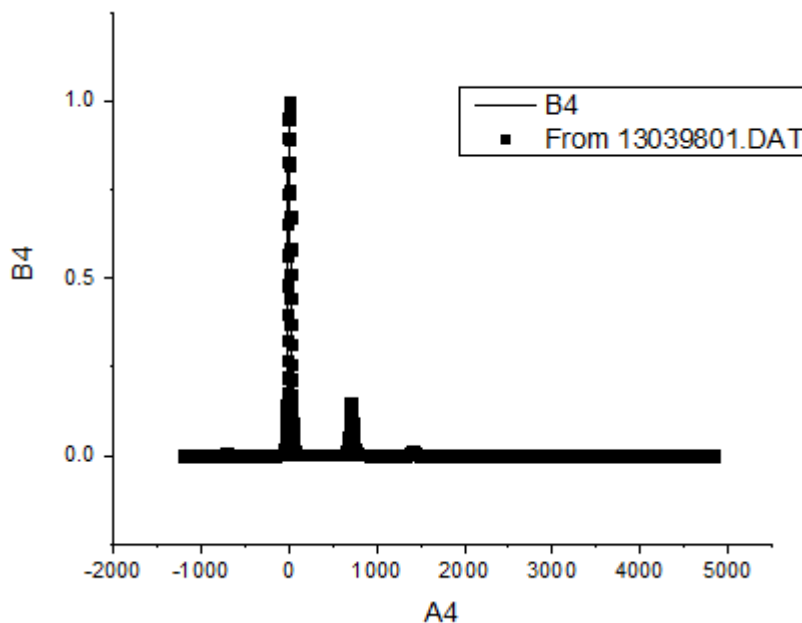



12. Activate one of the workbooks and follow the procedure above to create two more graphs using the following designations in the **Plot Setup** dialog (remember to change the plot type to Scatter for the data from *Measured*):

**Graph 2**

Worksheet Name	Set X as	Set Y as
Original name: BOS	A1	B1
Measured	C	D

**Graph 3**

Worksheet Name	Set X as	Set Y as
Original name: BOS	A2	B2
Measured	A	B

### 6.9.9.3.2 Adding Inset Graphs

1. Select the **Add Inset Graph With Data** button  on the **Graph** toolbar to add an inset graph to each graph. Each inset graph appears on its own layer and each graph can be customized, zoomed, panned and moved around like the full-size parent graph it was created from.
2. Select and drag each graph to the center:

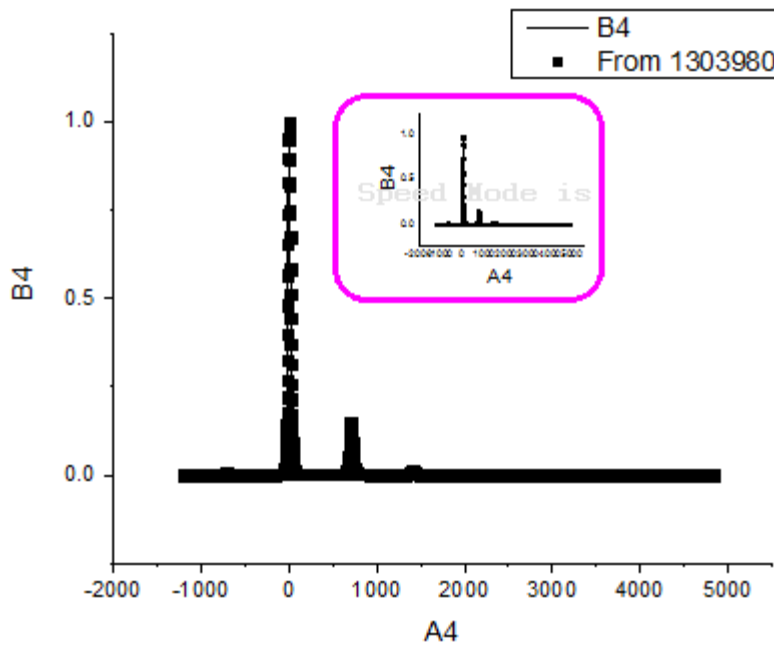

### 6.9.9.3.3 Merging Graphs

1. From the Origin menu select **Graph: Merge Graph Windows: Open Dialog**. Alternatively select the  button on the **Graphs** toolbar.
2. In the **Graph Manipulation: merge\_graph** dialog that opens, under **Arrange Settings**, set the **Number of Rows** as **3** and the **Number of Columns** to **1**. The Preview will appear on a panel to the right.
3. Enable the check box for **Treat Each Source Graph as a Unit**, to keep the graphs and the corresponding inset graphs linked.
4. Enable **Show Axes Frames** to add frames around each graph:

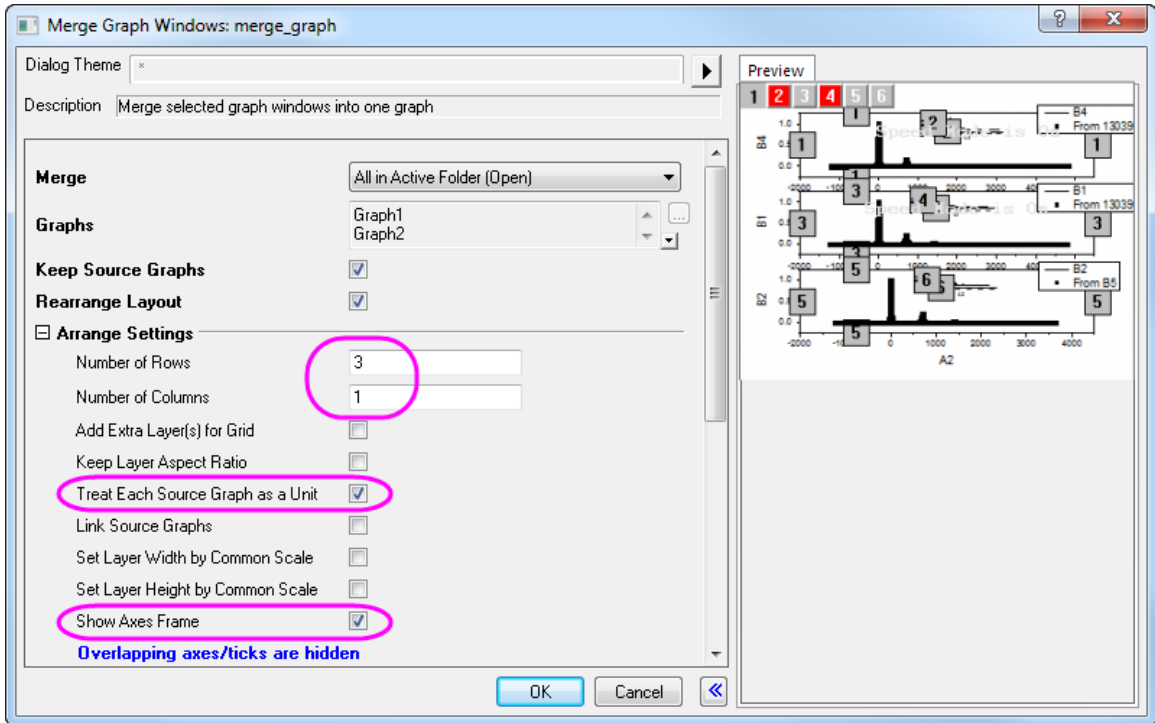

5. Click **OK** to exit the dialog.

#### 6.9.9.3.4 Customizing Plots and the Copy Format Feature

1. Double-click the first graph to open the **Plot Details** dialog box.
2. Use the  button to expand the left panel. Click on the arrow next to the **Layer1** icon to expand it and show the layer 1 contents.
3. Select the plot *[ Measured ]Sheet1!E[ X ]...* and on the **Symbol** tab, change the symbol to a circle, the **Size** as **5** and the **Symbol Color** to **Red** as shown below. Select **Apply**.

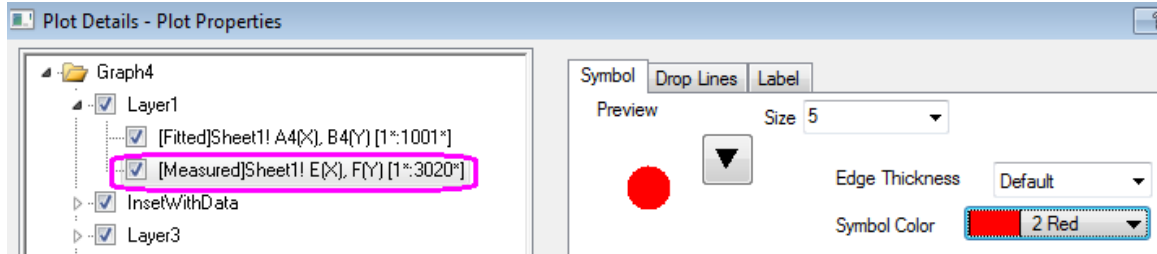

4. Select the plot [ *Fitted* ]Sheet1!A4[ X ],B4... and on the **Line** tab set the line color as **Blue**.
5. Click **OK** to exit the dialog box.
6. The next step is to apply this color scheme to all the parent graphs and inset graphs to avoid manually changing them all. Right-click on the customized graph and from the context menu select **Copy Format: All Style Format:**

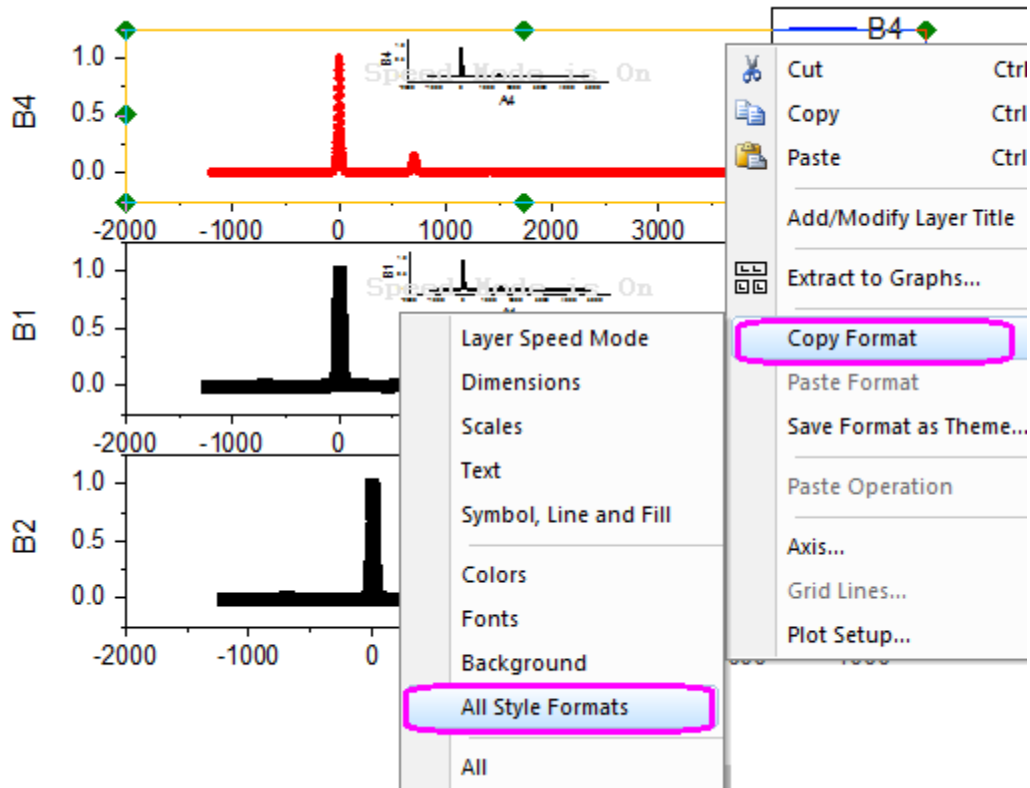

7. Right-click on each remaining graph and select **Paste Format** from the context menu.

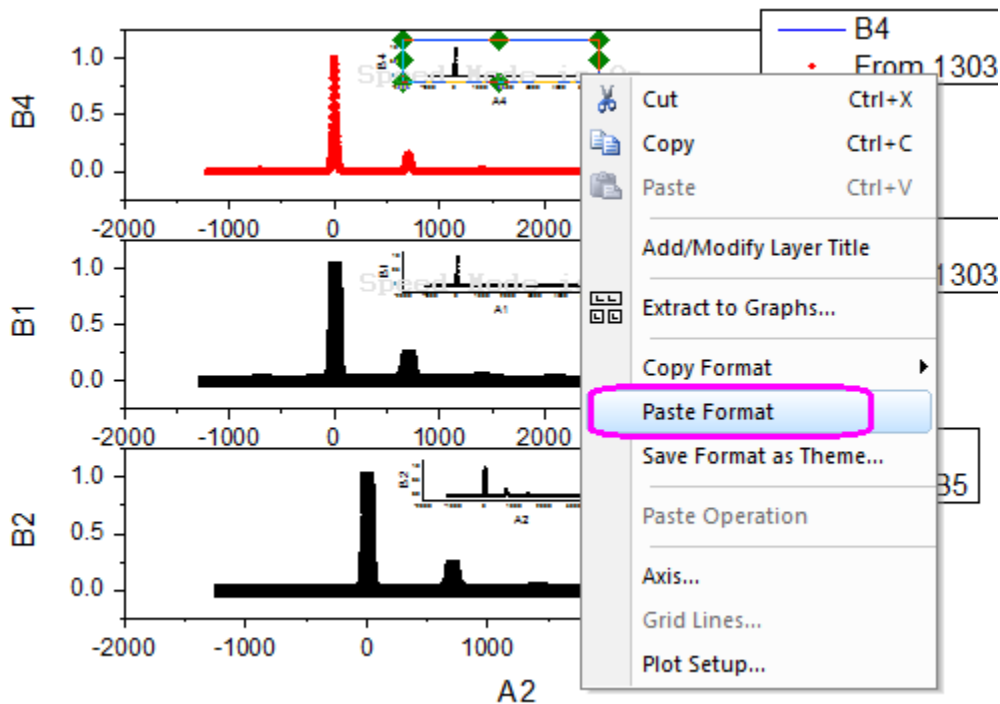

Beginning with Origin 2018b, you can use the Plot Details **Common Display** controls for simultaneous editing of layer, plot and axis properties in a multi-layer graph. For more information, see [The \(Plot Details\) Layers tab controls](#).

### 6.9.9.3.5 Using the Layer Management Dialog Box to Link and Customize Axes

The next step is to set the scales on the axes and add axis breaks to show the important parts of the graphs.

1. Select **Graph: Layer Management**. In the dialog box that opens there will be a panel named **Layer Selection** on the left. It lists all six of the layers in this graph - 3 for parent graphs and 3 for inset graphs.
2. In order to customize one parent graph axis and have the changes implemented on the other two parent graphs, the axes are linked in the **Link** tab. The first Layer cannot be linked so it is the one that is customized and the other graphs are linked to it. Select **Layer 3** and in the **Link** tab set **Link to** as **1** and set **X Axis Link** and **Y Axis Link** as **Straight[1 to 1]** as shown below:

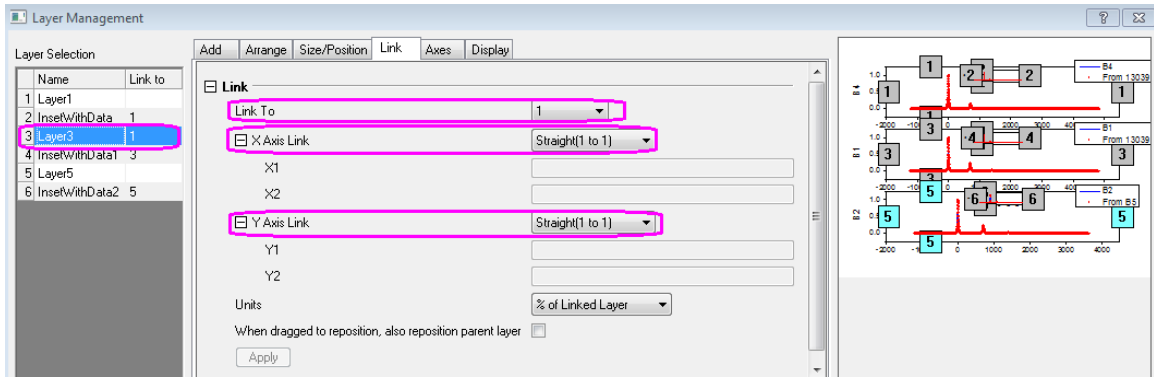

- Click **Apply**.
- Do the same for **Layer 5** and click **Apply**.
- Click **OK** to exit the dialog box.
- Double-click any axis on the first graph to open the **Axis Dialog**.
- Go to **Horizontal** icon in **Scale** tab, set **From** and **To** to **-250** and **1500**. Set the Increment Value on the **Major Ticks** section as **250**.

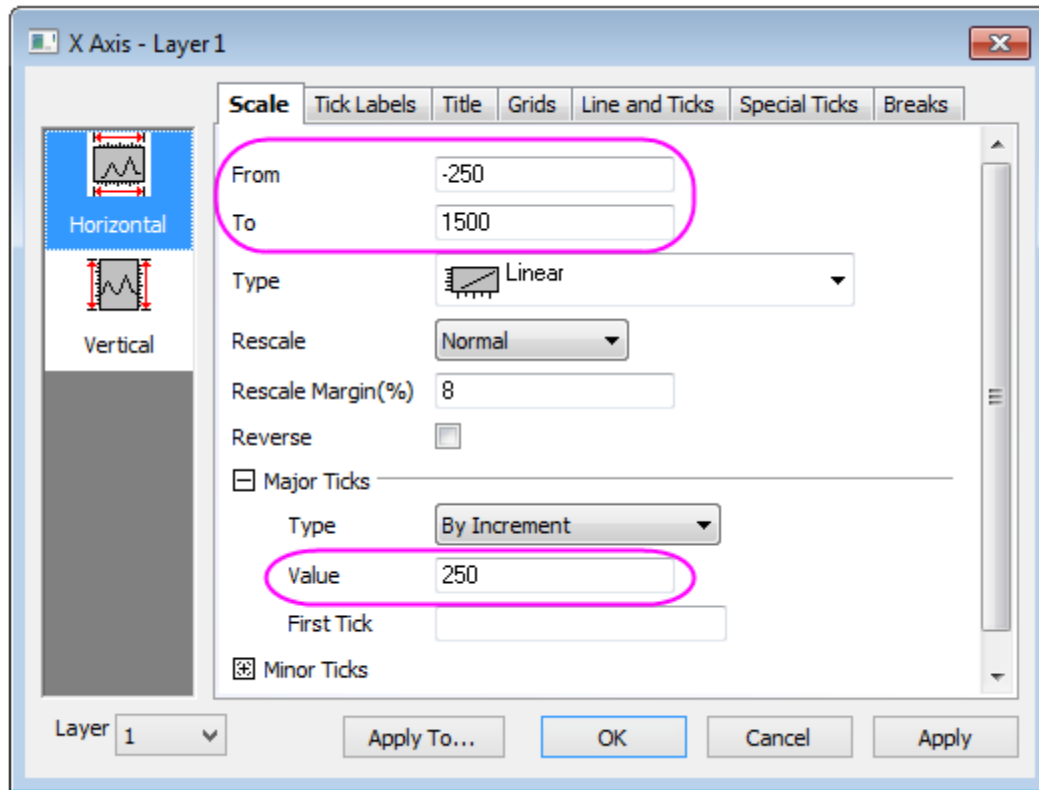

- Go to **Horizontal** icon in the **Breaks** tab, set **Number of Breaks** to **1**.
- Select **Break 1** under the **Breaks** node and create a break **From: 850, To: 1250**.
- On the same page, clear the **Auto** check box for **Position (% of Axis Length)** and set it as **75**.

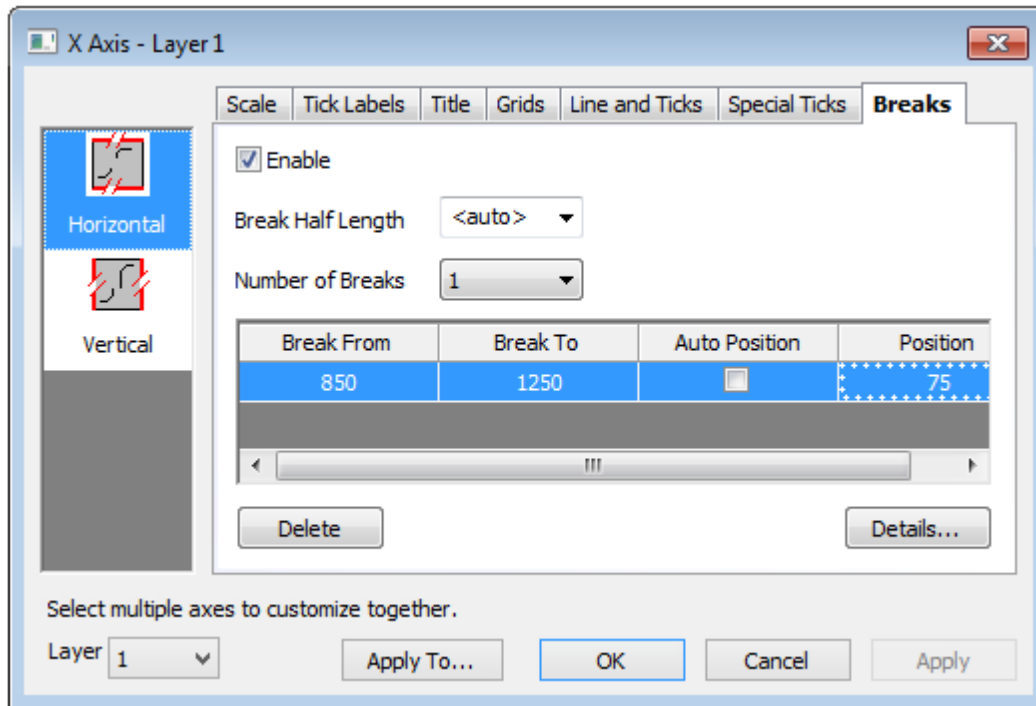

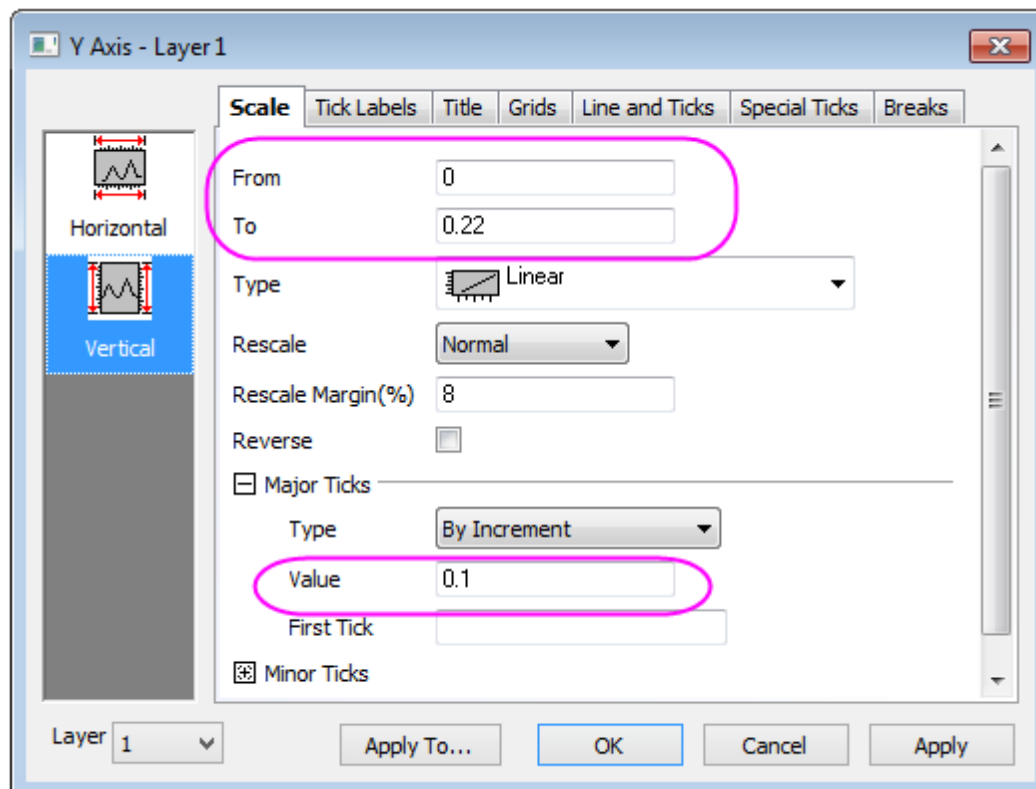

- Go to **Vertical** icon in **Scale** tab, set the scale as From: 0, To: 0.22 with increments of 0.1.

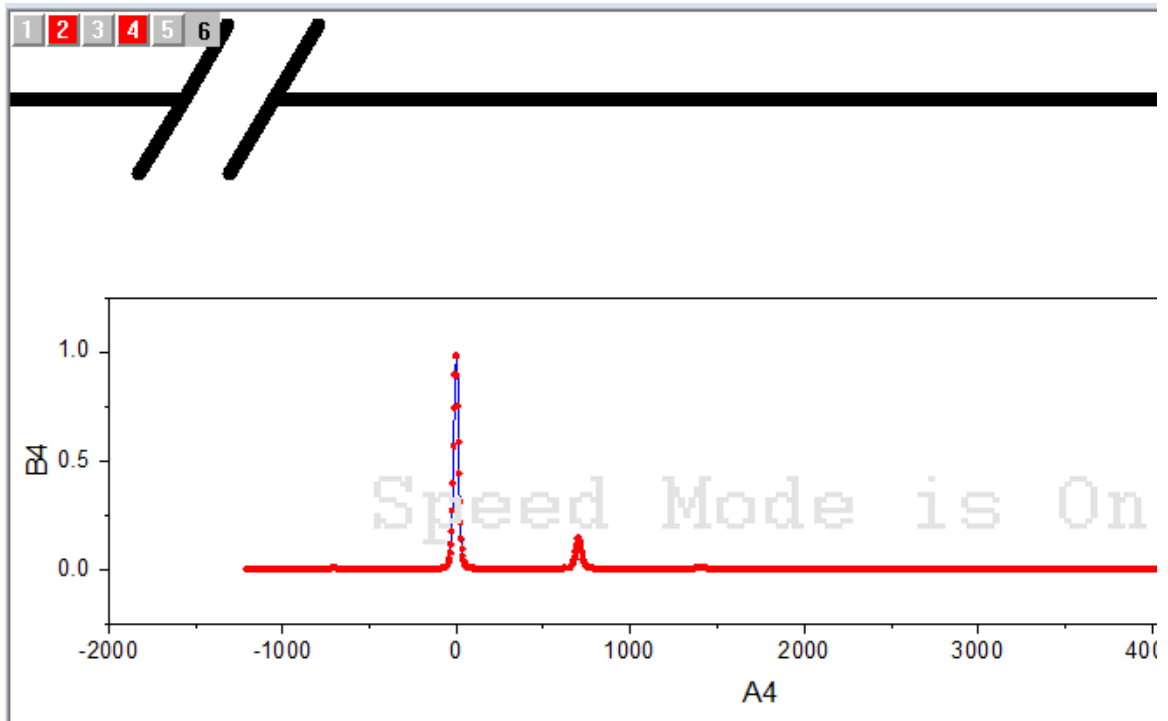

- Select **OK**. All three graphs will now reflect your changes.

13. To customize the Inset Graphs, zoom into the first one on Layer2 using the **Zoom Pan** button  on the **Tools** toolbar. Use the mouse wheel to zoom in.



14. Once zoomed in, select the **Pointer** button  on the **Tools** toolbar to exit the zoom mode. Double-click on the Inset Graph to open the **Plot Details** dialog. Select the `[Measured]Sheet1!E(X), F(Y) [1*:3020*]` graph and on the **Drop Lines** tab, check the **Vertical** box. Click **OK**.

The figure shows the Plot Details dialog box for a graph. The left pane shows a tree view of the graph structure with 'Graph4' expanded. Under 'Graph4', 'Layer1' is expanded, and 'InsetWithData' is selected. Under 'InsetWithData', '[Measured]Sheet1! E(X), F(Y) [1\*:3020\*]' is selected. The right pane shows the 'Drop Lines' tab with the 'Vertical' checkbox checked. The 'Horizontal' checkbox is unchecked. The 'Style' is set to 'Solid', 'Width' is 0.5, and 'Color' is 'Auto'. The 'Data Points Display Control' section has 'Skip Points' set to 2.

15. Double-click on any axis.
16. In the **Axis Dialog** that opens, set the scale for the **X Axis** on the **Scale** tab **From: 1350, To: 1450**, with increments of **50**.
17. Under the **Vertical** icon, set the scale **From: 0, To: 0.03**. Go to **Lines and Ticks** tab and on the **left** icon, set the *Major Ticks* to **None** and the *Minor Ticks* to **None**.

18. Select **OK** to exit the dialog box. Select the tick labels on the left Y axis and press **Delete** to remove them. Do the same with axis labels.
19. Press **CTRL+W** to zoom out and return to normal graph size.
20. Select the customized Inset Graph, right-click and choose **Copy Format: All Style Formats** from the context menu.
21. Select, right-click and **Paste Format** to the other two Inset Graphs, to duplicate the drop lines settings.
22. Repeat the last two steps, this time selecting **Copy Format: Scales** to duplicate the axis settings.

#### 6.9.9.3.6 Adding Titles, Legend and Text Objects

1. Activate the first Layer by clicking the layer icon on the top left corner of the graph. Right-click on the graph and from the context menu choose **Add/Modify Layer Titles**. Type **Wurtzite GaN** in the box that opens, change the font size and type face as desired and drag to an appropriate position:

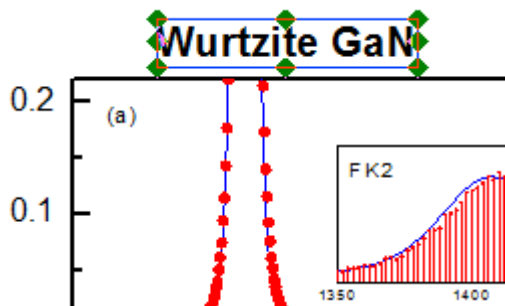

2. Select the legend objects for the second and third graphs and press **DELETE**.
3. Select the remaining legend, right-click and choose **Properties**. In the **Text** tab of **Object Properties** dialog box, type **Fitted** in place of **%(1)** and **Measured** in place of **%(2)**. Place both on the same line. Set the font size as desired. Go to **Frame** tab, and set the **Frame** to **None**. Click **OK** and drag the legend object to an appropriate place.



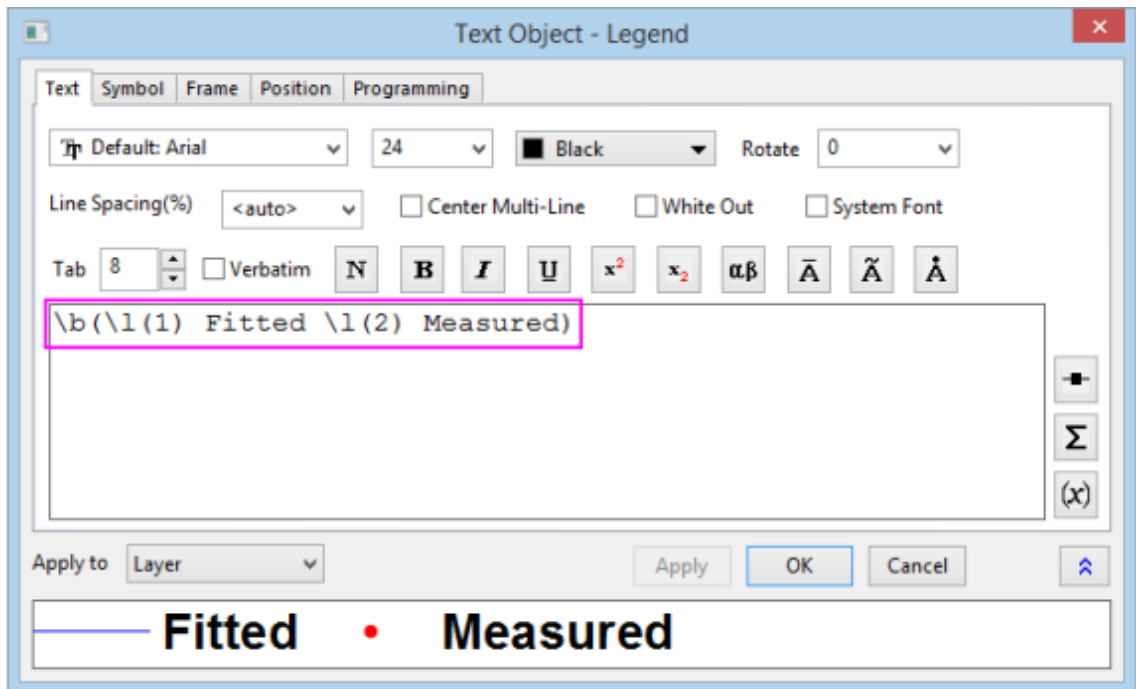

4. Delete the first and third Y-axis titles. Double-click the second one and type **Intensity [arb. units]**. Do the same for the single X-Axis title, labeling it **Energy Loss [cm<sup>-1</sup>]**.
5. Right-click on the graph and choose **Add Text** from the context menu or choose the **T** button on the **Tools** tool bar. Add text objects as shown below. Use the **x<sub>2</sub>** button for writing subscripts:

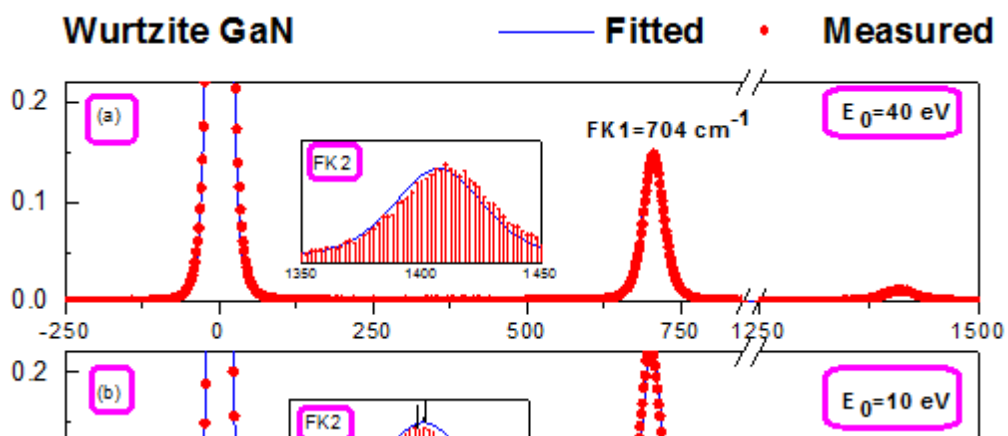

6. Select each of the inset graphs and change size or position as desired. Use the **↗** button on the **Tools** toolbar to create arrows where desired on the Inset Graphs:

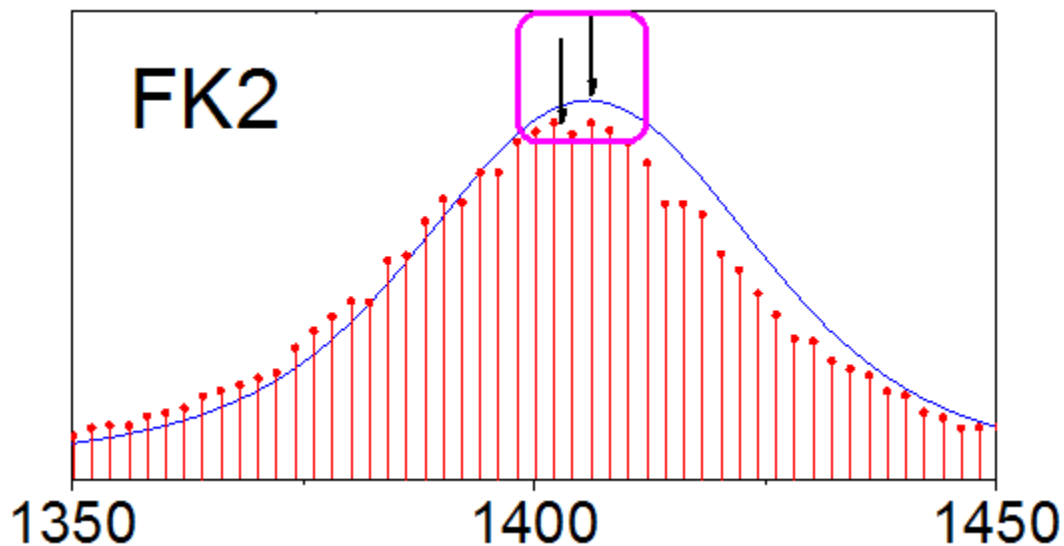

7. The final graph should appear as shown below:

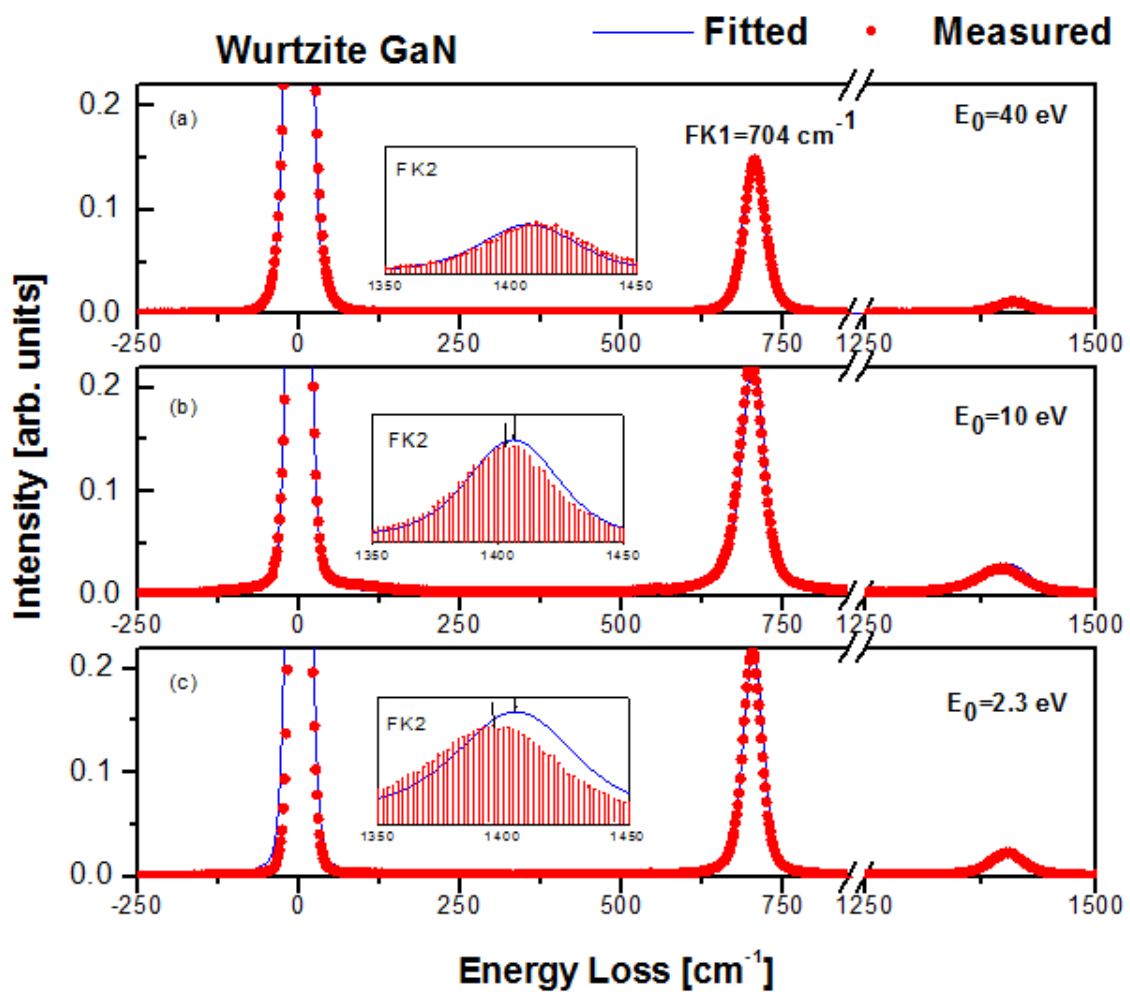

## 6.10 Contour

### 6.10.1 Contour

- [XYZ Contour](#)
- [Contour Plots and Color Mapping](#)
- [Ternary Contour](#)
- [Combining Line and Contour Plots](#)
- [Contour Graph with XY Data Points and Z Labels](#)
- [Contour Plot with Vector Overlay](#)
- [Create Heatmap with Virtual Matrix and Colormap Bar Plot](#)

### 6.10.2 XYZ Contour

#### 6.10.2.1 Summary

This tutorial will show you how to create a contour from XYZ data.

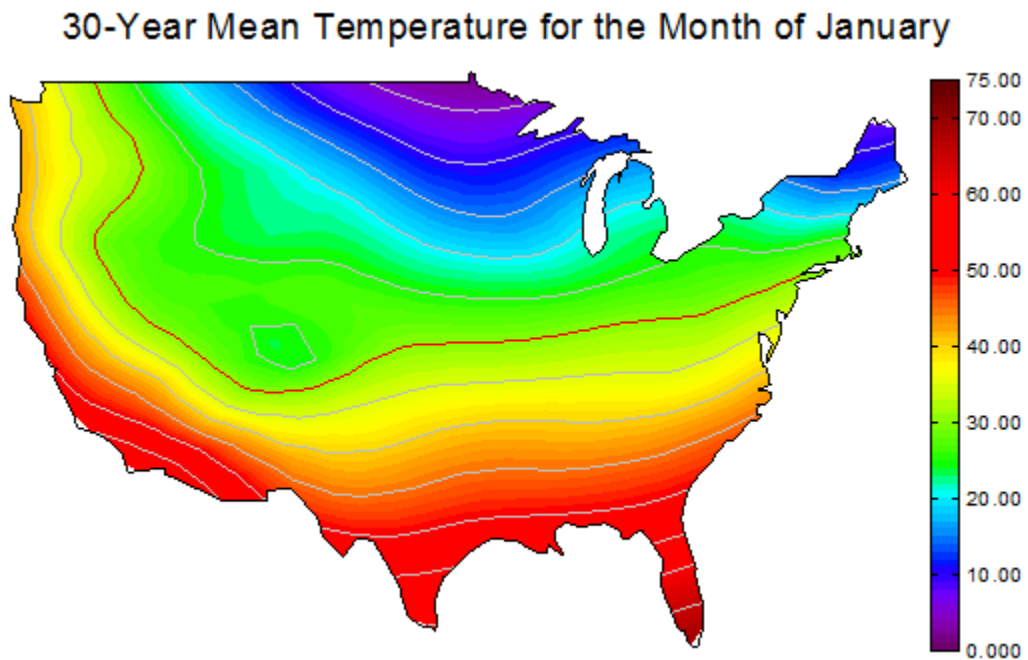

Minimum Origin Version Required: 2015 SR0



Prior to Origin 2018 SR0, the application of a custom boundary sometimes generated an imperfect fill at boundary margins. This has been improved in 2018. The user can restore the previous contour-fill behavior using [system variable @TCSM](#).

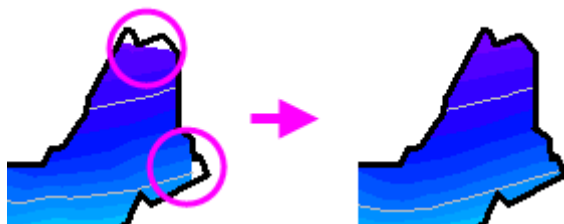

### 6.10.2.2 What will you learn

This tutorial will show you how to

- Create a Contour Plot from XYZ data
- Customize levels, lines, and color mapping
- Use a Custom Boundary
- Customize the Color Scale
- Customize the axes of the plot

### 6.10.2.3 Steps

This tutorial is associated with the 2D and Contour Graphs project: *\Samples\2D and Contour Graphs.opj*

(**Note:** Users with Origin 2017 and later will find this data in **Origin Central** (press F11 to open) under **Graph Samples > Contour Plots**).

1. Open the *2D and Contour Graphs: Contour: XYZ Contour* folder in the **Project Explorer**. Activate **Book1B** and highlight column **D** and then click **Contour-Color Fill** button from the **3D and Contour Graphs toolbar**.

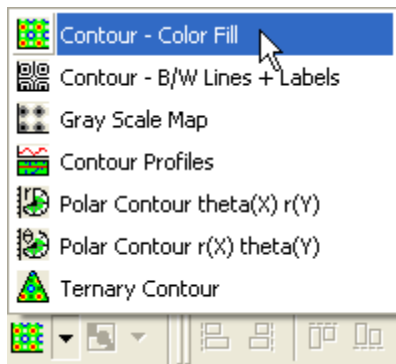

The graph should look like:

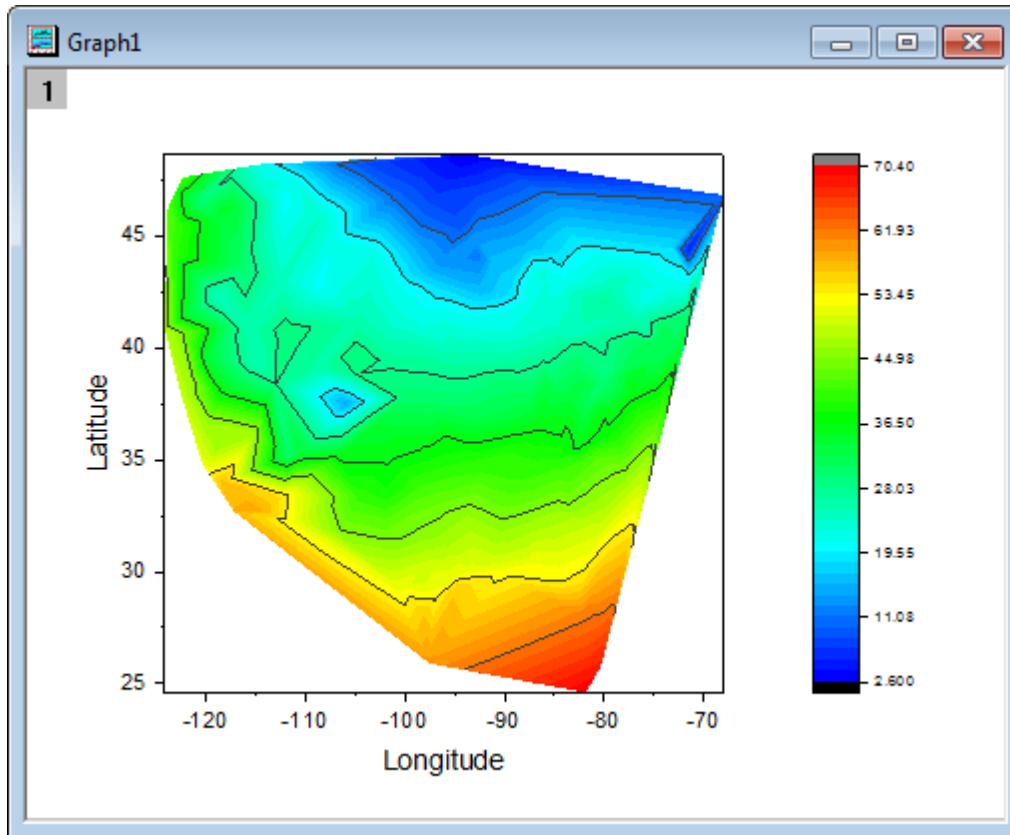

2. Double-click on the contour plot to bring up **Plot Details** dialog. Select the **Contouring Info** tab and set the options in the dialog as the screenshot below:

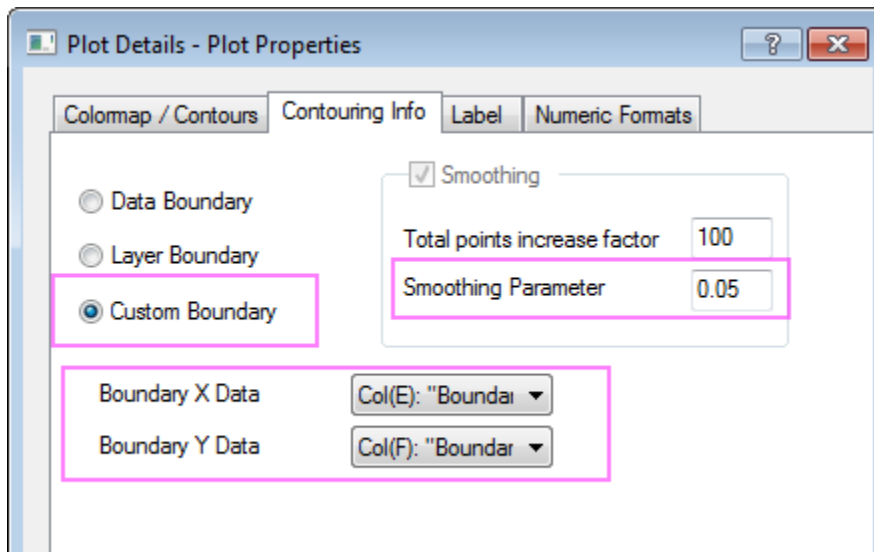

3. Select the **Color Map/Contours** tab, click the **Level** heading and set the dialog as the following screenshot shows:

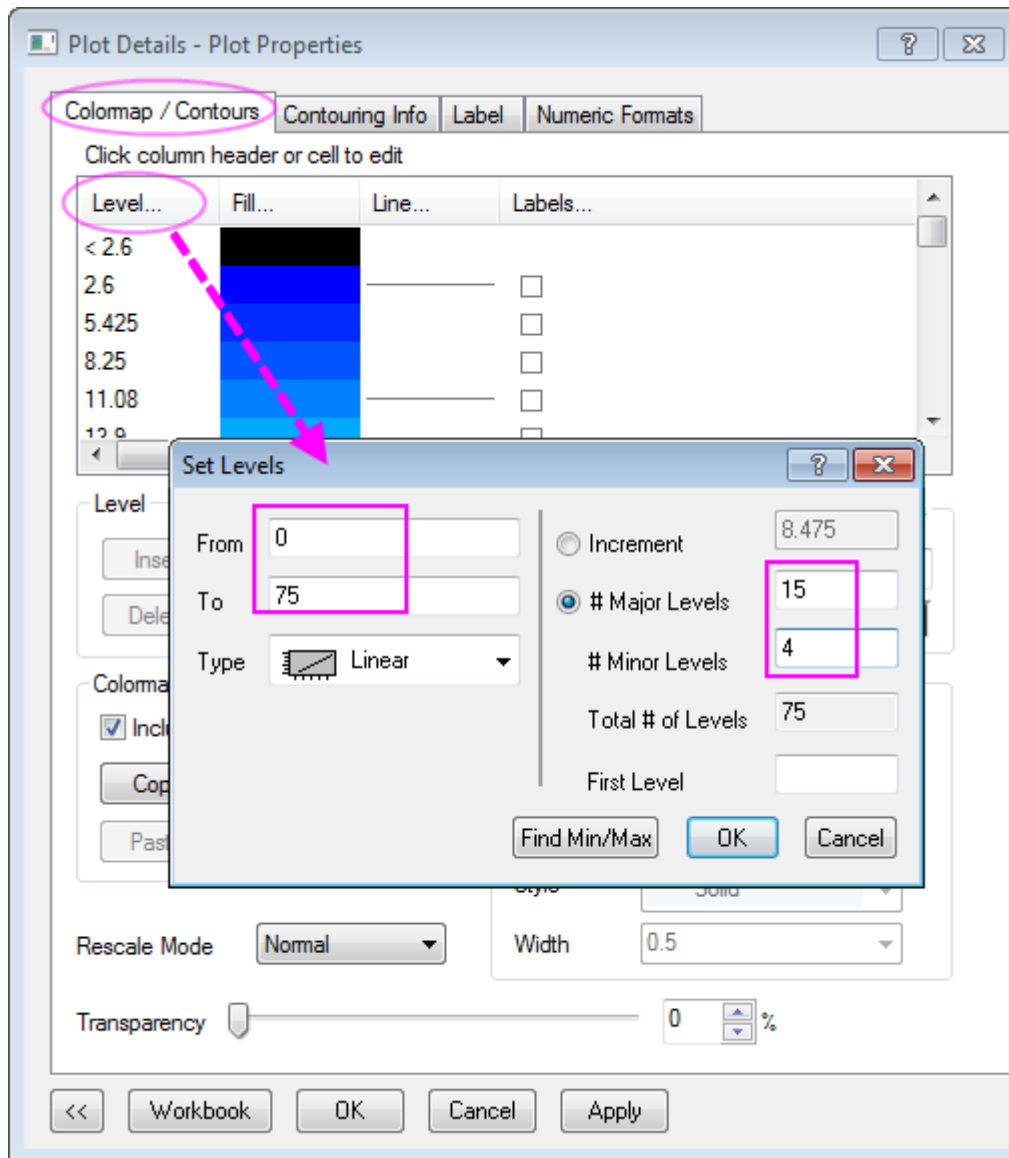

- Click the **Fill** heading, select **Load Palette** and then select **Rainbow** from the Palette list and click **OK** to close dialog.
- Click the **Lines** heading, make sure that **Show on Major Levels Only** is selected. Select the **Color** check box under **Apply to All** and choose **LT Gray** from the drop-down list as contour line color. Click **OK** to close dialog.
- Click on the line at value 30 to customize it separately and click **OK** to close dialog.

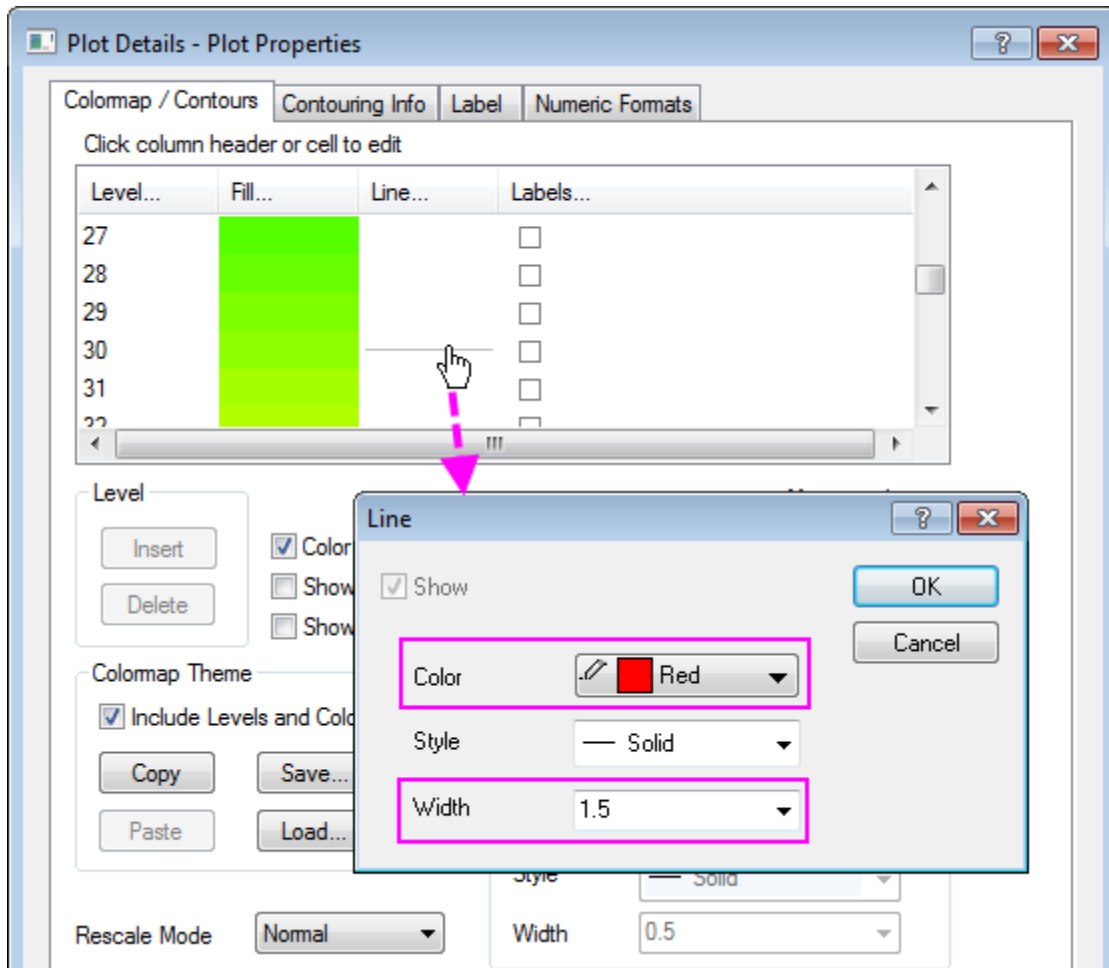

4. Then go back to the **Colormap / Contours** tab, clear the check box **Follow Contour Line** under **Boundary** so that the boundary line could have separate style.
5. Click **OK** to close the **Plot Details** dialog, then select **Format: Axes: X Axis...** to open the **Axis** dialog. Then do the following things.
  - o Select the **Scale** tab and make sure the **Horizontal** axis icon is selected so X axis scale is being updated, set **From, To** equal to **-127, -65**.
  - o Select the **Vertical** axis icon to customize the Y axis scale, set **From=23, To=50**.
6. Click **OK** to apply the setting and close the **Axis** dialog.
7. Now we are going to change the layer size/aspect ratio and turn off the XY axes and its frame. Make sure the graph window is active and select **Format:Layer** to open the **Plot Details - Layer Properties** dialog, first go to the **Size/Speed** tab and change the values in **Layer Area** as below:

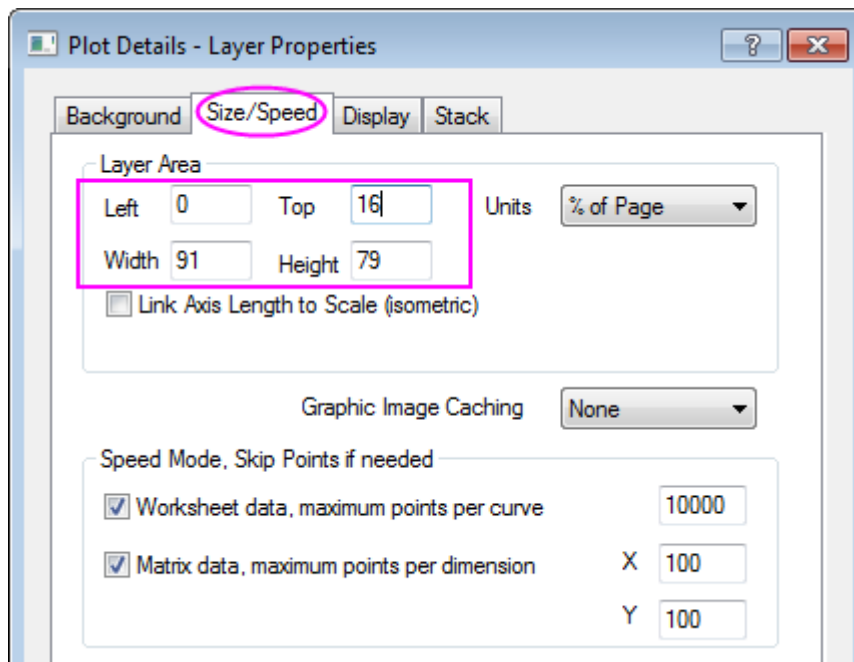

8. Go to the **Display** tab and clear the **X Axes** and **Y Axes** check boxes under **Show Elements**. Click **OK** to apply the setting and close the dialog.
9. Right click on the white space in graph layer and select **Fit Page to Layers**, accept the default dialog settings and click **OK** to make all elements visible.
10. In the graph, select the axis title object **Latitude** and **Longitude**, hit the **Delete** key to remove them from the graph.
11. Now we will customize the color scale object. Double-click on the color scale to bring up the **Color Scale Control** dialog. Then do the following settings:



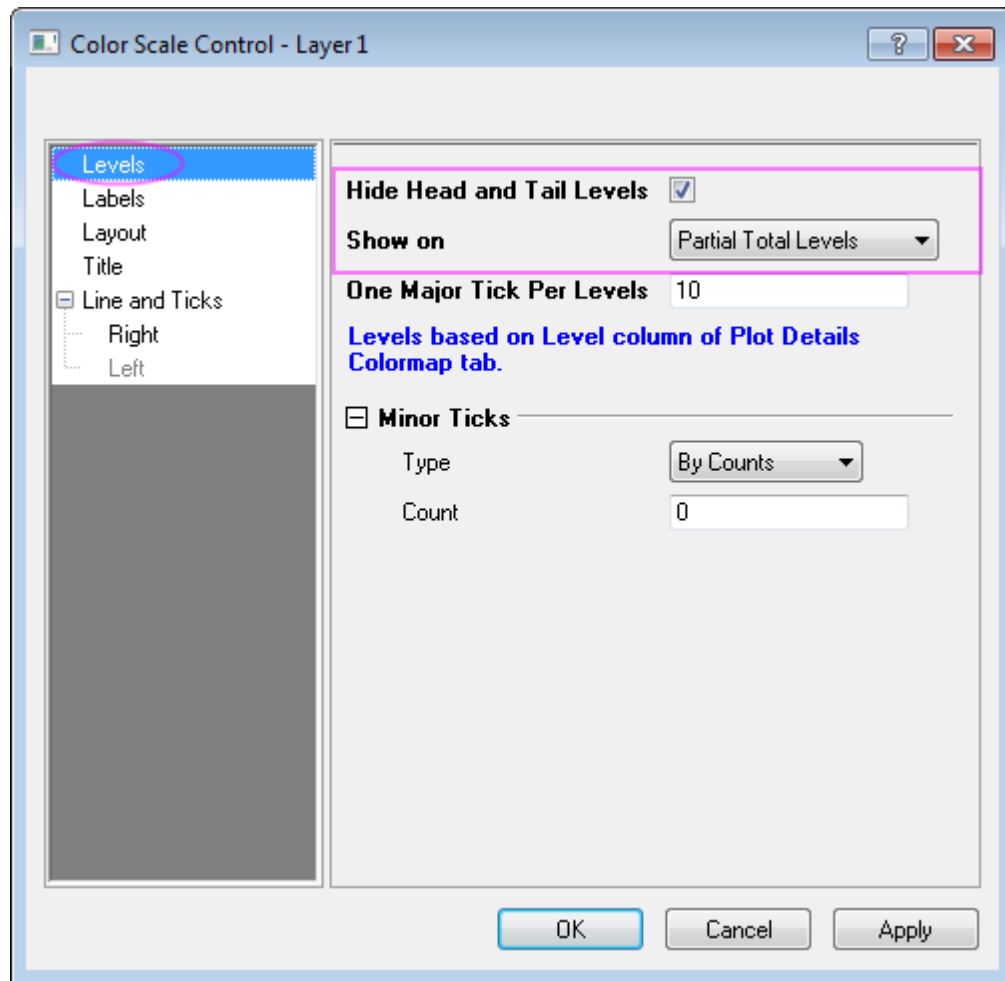

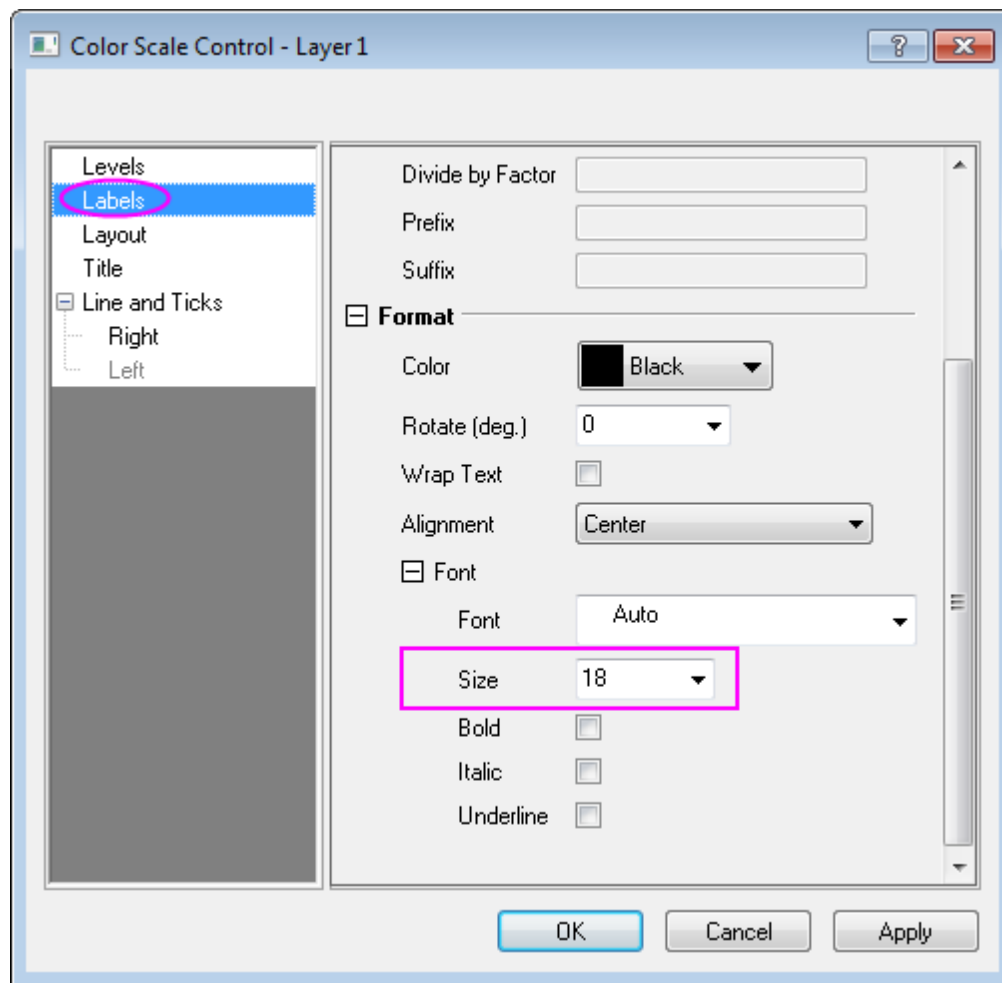

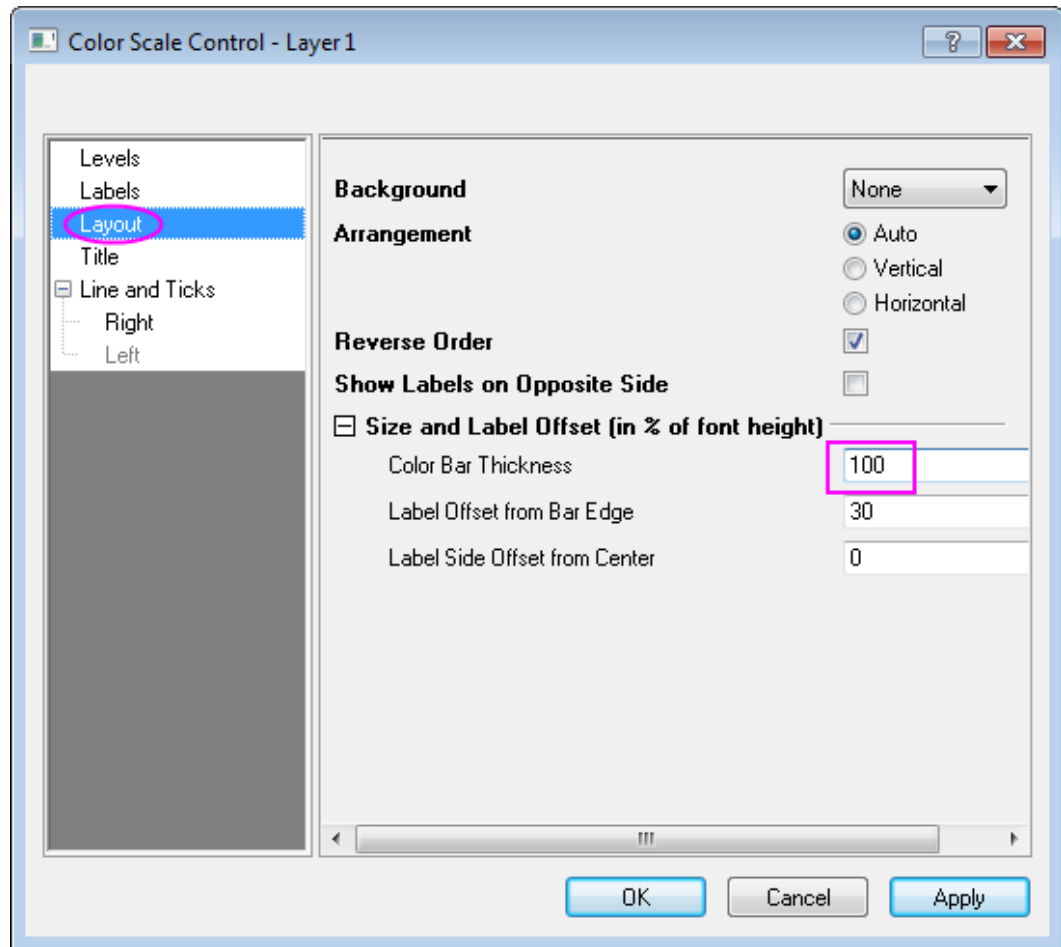

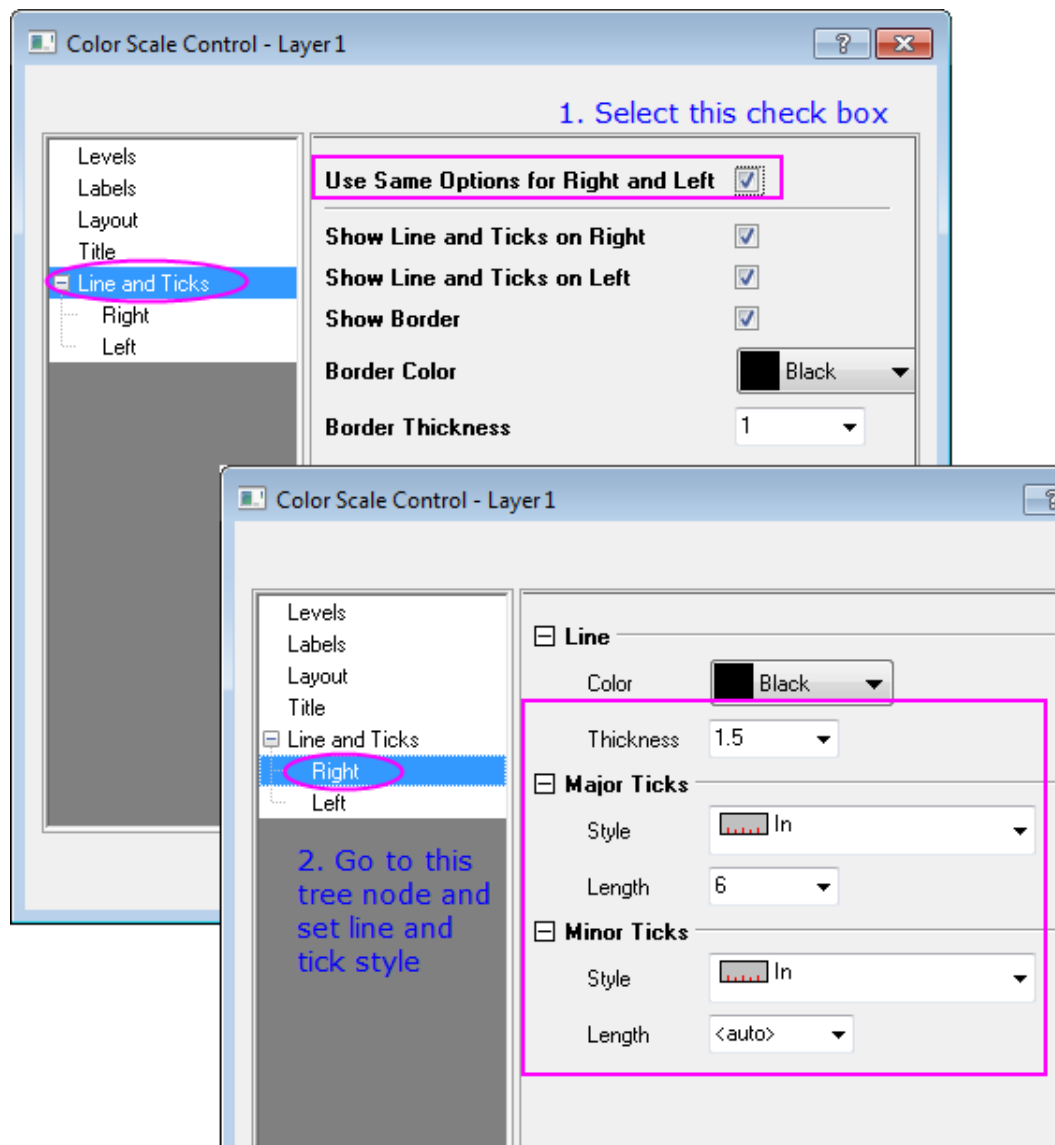

12. Click **OK** to apply the settings and close the **Color Scale Control** dialog.

13. Right-click above the contour plot and select **Add Text** to add a graph title *30-Year Mean Temperature for the Month of January*. Use the **Format** toolbar and/or double-click on the completed text label to update the font, font size, etc. The graph should look like

### 30-Year Mean Temperature for the Month of January

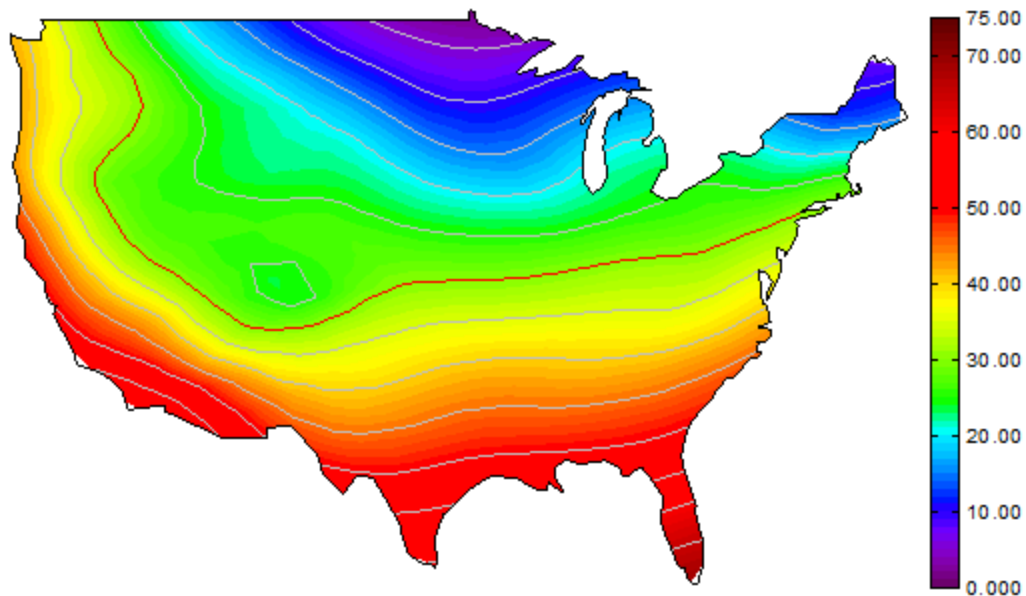

## 6.10.3 Contour Plots and Color Mapping

### 6.10.3.1 Summary

Origin offers rectangular, polar, and ternary contour plots. For **rectangular contour plots**, the data can be either in a matrix or in a worksheet in XYZ format. **Polar contour plots** can be generated from three columns of data in a worksheet, organized either as R  $\Theta$  Z or  $\Theta$  R Z. **Ternary contour plots** can be generated from worksheet data organized in X Y Z Z format where the 2nd Z-column contains the 4th parameter which is the height value at a given XYZ point in the ternary space.

Many options are available for customizing contour plots, such as setting different major and minor contour levels, displaying contour lines only at major levels, applying color palettes, and also control for a custom boundary in the case of contour plots created directly from the worksheet.

### 6.10.3.2 What You Will Learn

This tutorial will show you how to:

- Set values in a Matrix and create a Contour Plot
- Customize levels, lines, and color mapping
- Extract data from contour lines
- Create a Contour Plot directly from XYZ data
- Use a Custom Boundary

### 6.10.3.3 Create Contour Plot from Matrix

1. To create a new matrix click the **New Matrix button** . Move the cursor to the upper left corner of the matrix until the shape of the pointer changes as in the following image and click to select the entire matrix.

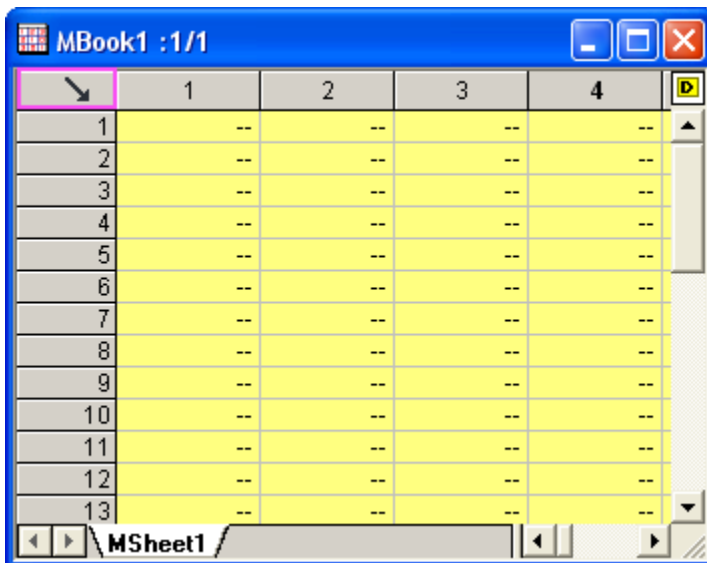

To set the dimensions, right-click and select **Set Matrix Dimension/Labels** in the context menu. On the XY Mapping tab, change setting as shown below .

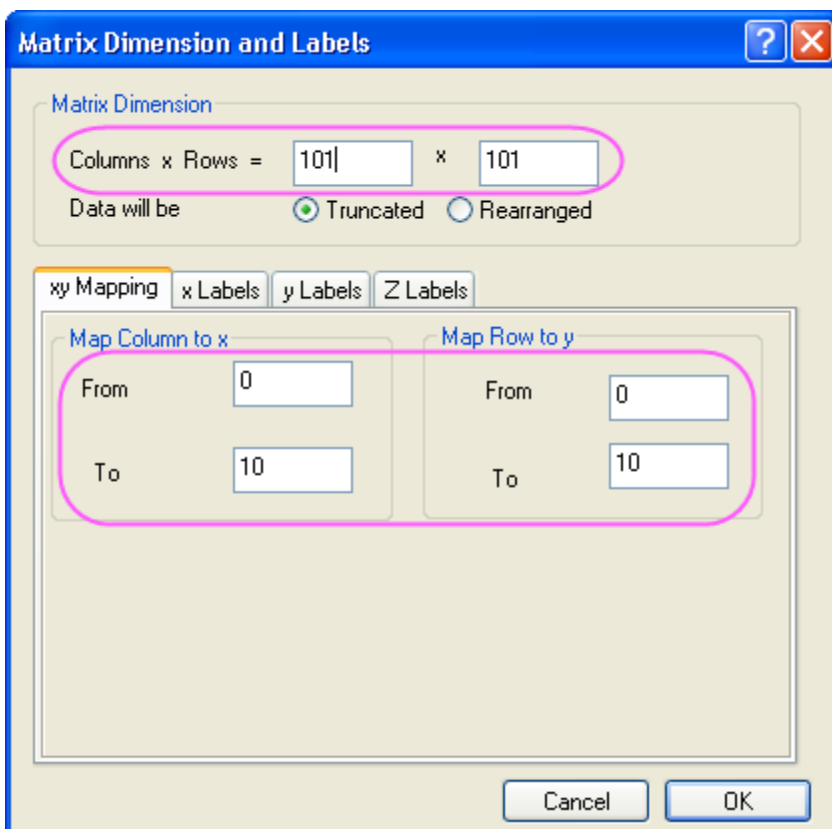

- Input data into the matrix by highlighting it and right-clicking. Select **Set Matrix Values** in the context menu to open the **Set Values** dialog. Type  $i*\sin(x) - j*\cos(y)$  in the **Formula** edit box and click the **OK** button to generate data. The matrix should look like this:

The column index

	1	2	3	4	5
1	-1	-1.90017	-2.80133	-3.70448	-4.61058
2	-0.995	-1.79034	-2.58767	-3.38898	-4.19618
3	-0.98007	-1.66063	-2.34419	-3.03371	-3.73208
4	-0.95534	-1.51134	-2.07133	-2.63927	-3.21901
5	-0.92106	-1.34295	-1.76984	-2.20664	-2.65821
6	-0.87758	-1.15616	-1.44073	-1.73721	-2.0514
7	-0.82534	-0.95184	-1.08532	-1.2327	-1.40075
8	-0.76484	-0.73102	-0.70517	-0.69521	-0.70886
9	-0.69671	-0.49491	-0.3021	-0.12714	0.02123
10	-0.62161	-0.24489	0.12186	0.46876	0.78613
11	-0.5403	0.01756	0.56446	1.08951	1.58209
12	-0.4536	0.29081	1.02324	1.73186	2.40504
13	-0.36236	0.57312	1.49563	2.39233	3.25065
14	-0.2675	0.86267	1.97887	3.06729	4.11436

The row index

- Each data point in the matrix corresponds to two different kinds of indices. One is the column and row indices. The other is the X and Y coordinates. Select **View: Show X/Y** from the main menu to see the X, Y coordinates:

The X coordinates

	0	0.1	0.2	0.3	0.4
0	-1	-1.90017	-2.80133	-3.70448	-4.61058
0.1	-0.995	-1.79034	-2.58767	-3.38898	-4.19618
0.2	-0.98007	-1.66063	-2.34419	-3.03371	-3.73208
0.3	-0.95534	-1.51134	-2.07133	-2.63927	-3.21901
0.4	-0.92106	-1.34295	-1.76984	-2.20664	-2.65821
0.5	-0.87758	-1.15616	-1.44073	-1.73721	-2.0514
0.6	-0.82534	-0.95184	-1.08532	-1.2327	-1.40075
0.7	-0.76484	-0.73102	-0.70517	-0.69521	-0.70886
0.8	-0.69671	-0.49491	-0.3021	-0.12714	0.02123
0.9	-0.62161	-0.24489	0.12186	0.46876	0.78613
1	-0.5403	0.01756	0.56446	1.08951	1.58209
1.1	-0.4536	0.29081	1.02324	1.73186	2.40504
1.2	-0.36236	0.57312	1.49563	2.39233	3.25065
1.3	-0.2675	0.86267	1.97887	3.06729	4.11436

The Y coordinates

- You can also select **View: Image Mode** to show the image form of the matrix:



5. Select **View: Data Mode** to exit the image mode. Create a contour plot by activating the matrix and selecting **Plot > Contour: Contour - Color Fill**. The graph should appear as shown below:

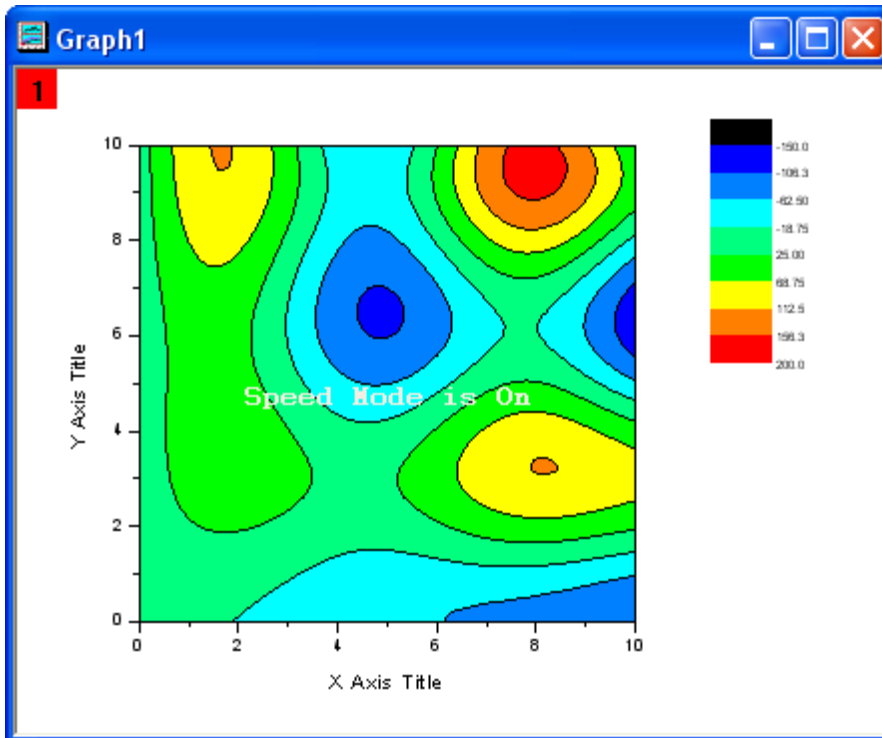

#### 6.10.3.4 Customize Levels, Lines and Color Map

Origin makes it easy to customize every aspect of the contour plot, including the color scale and adding labels:



1. Double click on the contour plot to open the **Plot Details** dialog. Make sure the left panel is expanded by clicking on the arrow button on the bottom left of the dialog. Click on **Layer1** in the left panel (leave the check-box checked, and click on the word itself), and select the **Size/Speed** tab in the right panel. Disable the **Matrix data, maximum points per dimension** box to turn off Speed Mode.
2. Expand the **Layer** option in the left panel and select **[MBook1]MSheet1!1(Z)(1:10201)** under it to open the matrix level options. Select **Colormap/Contours** in the right panel and click on the **Level** heading to open the **Set Levels** dialog. Click the **Find Min/Max** button and set **Major Levels** to **8** and **Minor Levels** to **32**. Click the **OK** button.

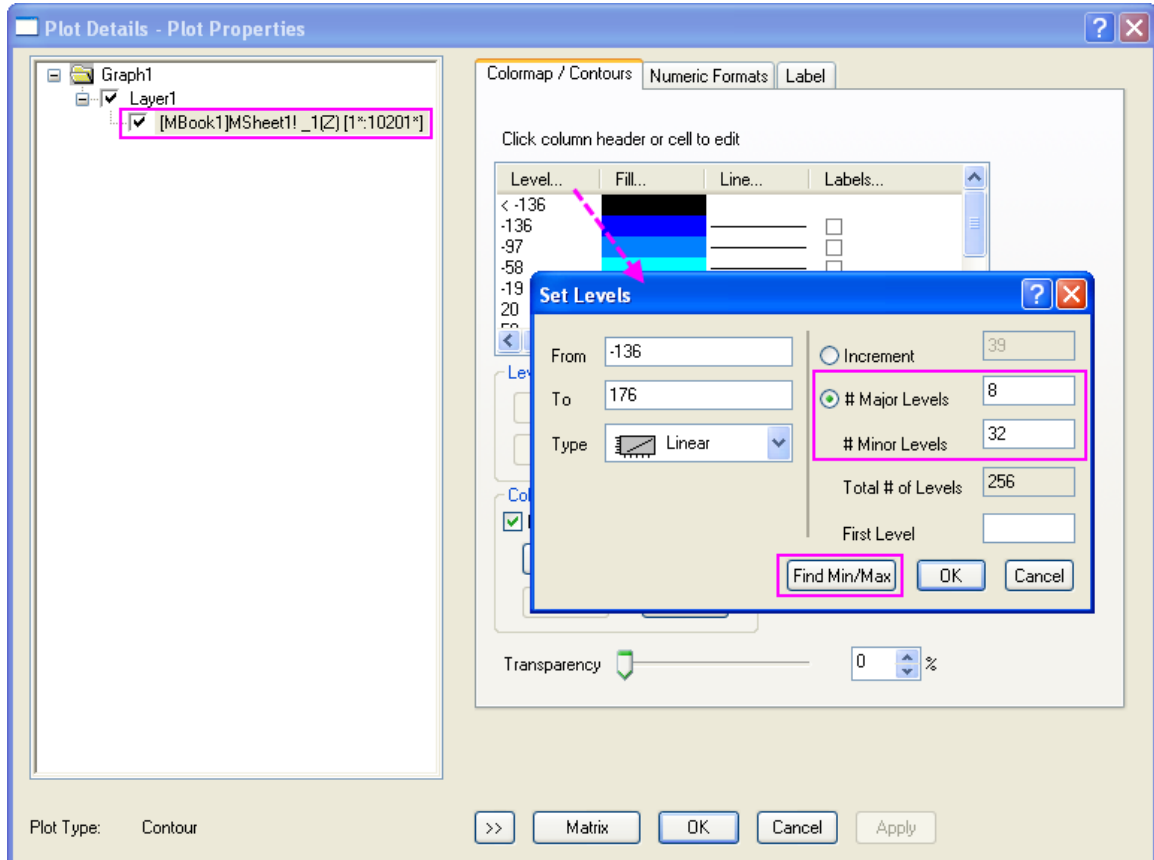

3. Now load a palette for the contour. Click on the **Fill** heading. In the dialog that opens, select the **Load Palette** radio box. Click the **Select Palette** button and select the **Rainbow** palette from the drop-down. Click **OK**.

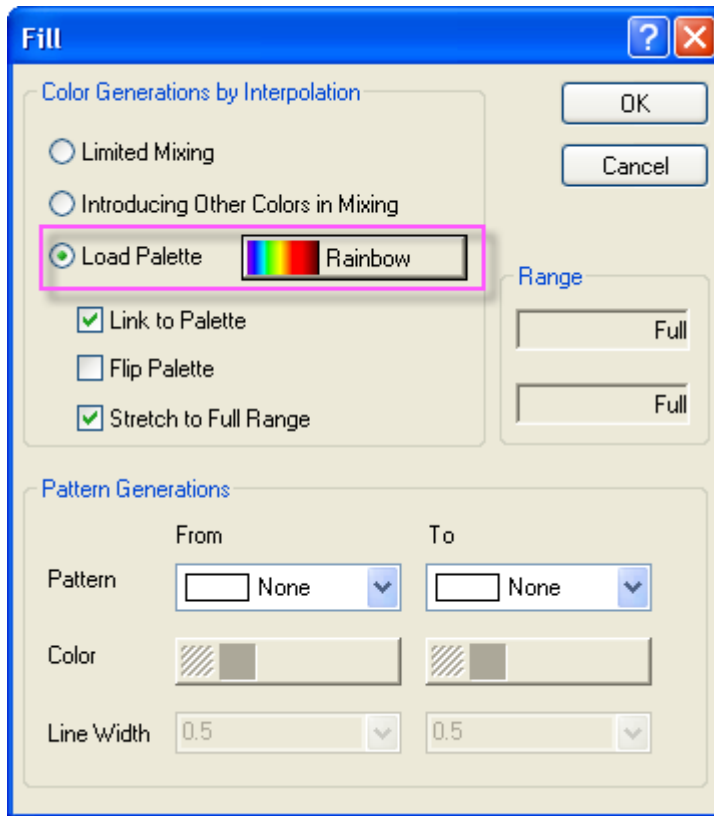

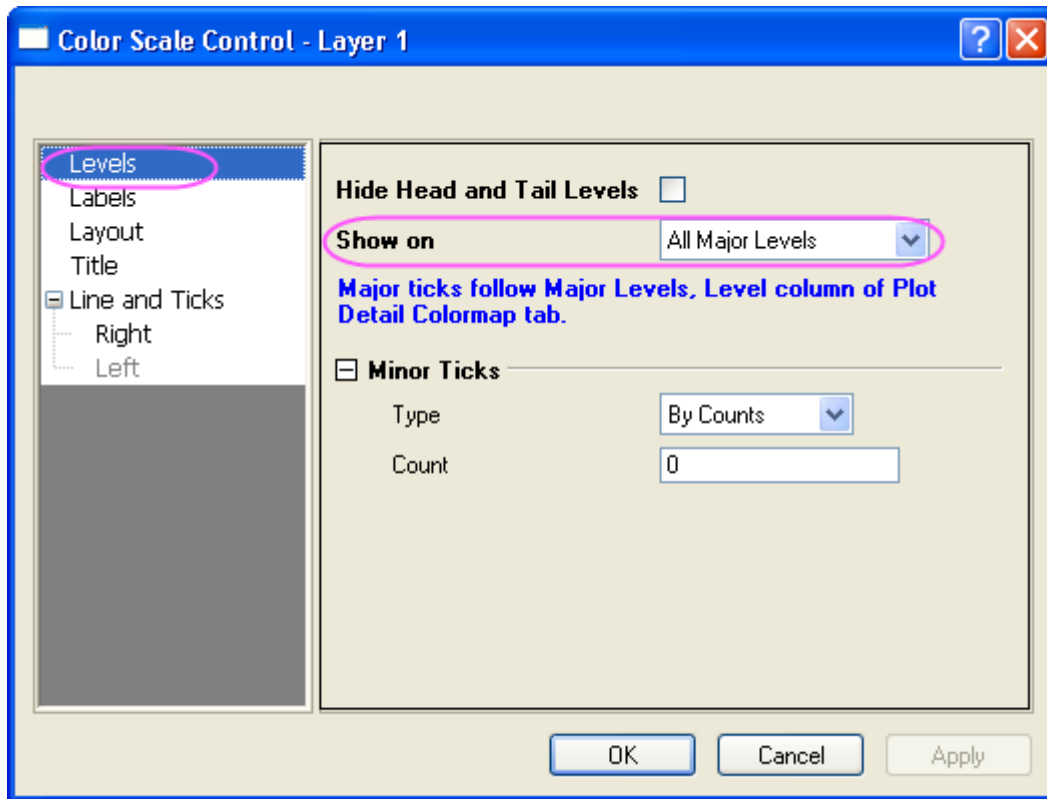

4. Click the **Line** heading to open the **Contour Lines** dialog. Check the **Show on Major Levels only** box and click **OK**. Then click the **OK** button to close the **Plot Details** dialog.
5. Set the properties for the color scale. Right click on the color scale and select **Properties** from the context menu to open the **Color Scales Control** dialog. Select **Levels** in left panel, select **All Major Levels** for the **Show on** drop-down list.

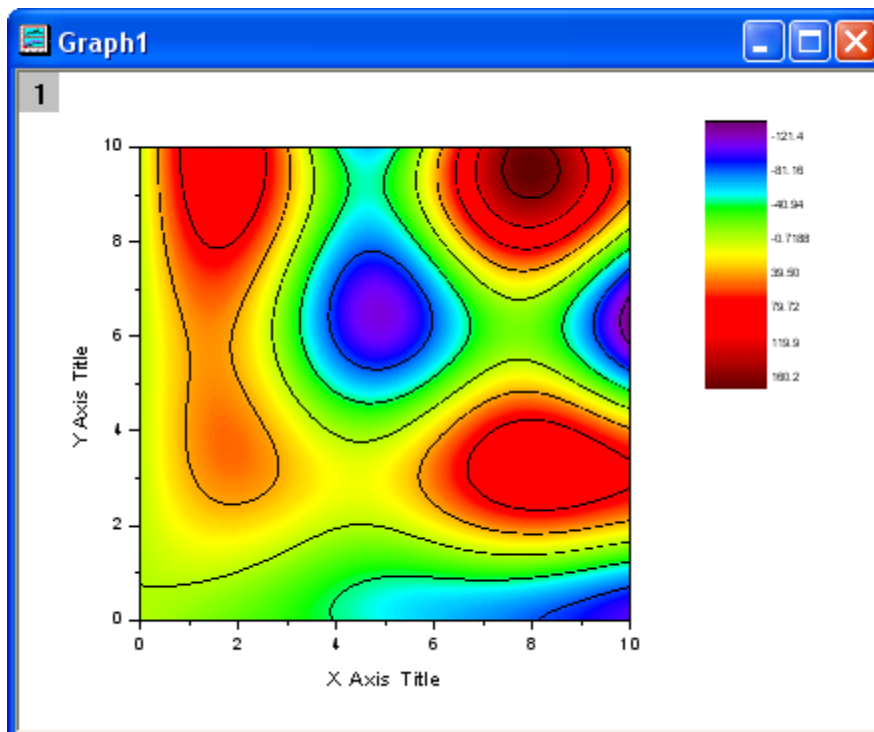

6. click **OK**. The contour should resemble the following image:



- Click twice on a contour line (two separate single clicks) to select all lines at that level. Change the color to **Green** by using the **Line/Border Color** button  in the **Font** toolbar. Change the width to **3** by using the **Line/Border Width** button  in the same toolbar.

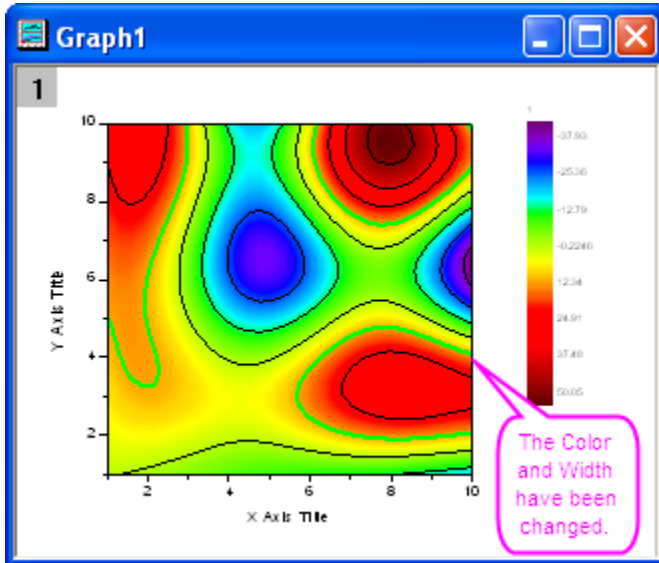

Make sure only one contour line is selected (not all the contour lines at that level) and right click on the selected contour line. Select **Add Contour Label** to add a label.

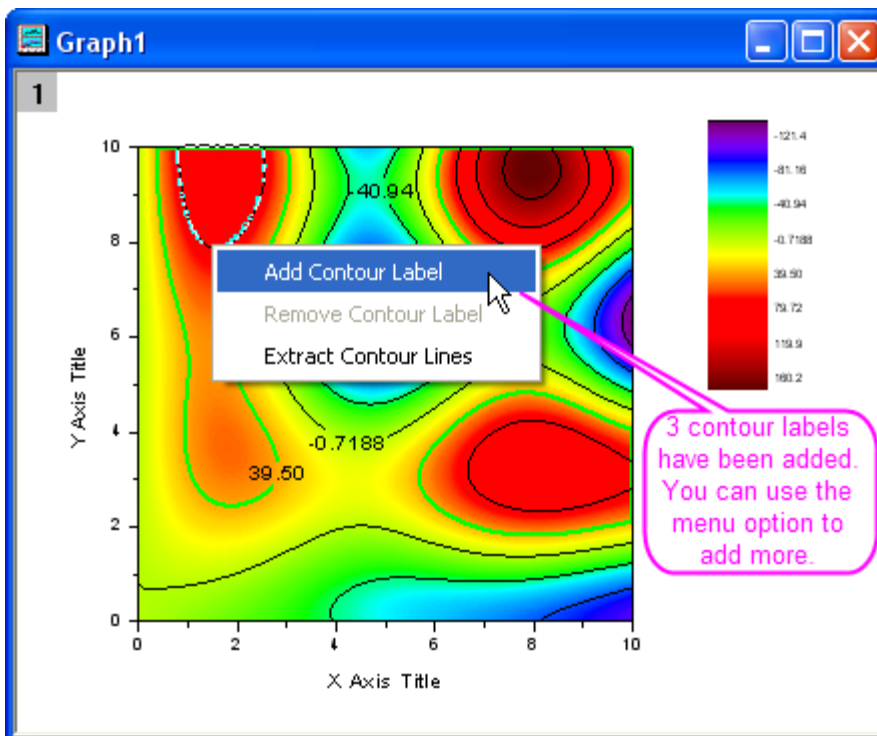

8. Click twice on a contour line to select it, right click and select **Extract Contour Lines**. Origin will extract the data for that contour line to a worksheet. The following image shows part of the data in the worksheet:

	A(X)	B(Y)
Long Name		
Units		
Comments		
F(x)=		
Z-Level	39.500000	39.500000
Area	12.70802	12.70802
	10.28145	10.28145
	6.06732	6.06732
	2.85618E-4	2.85618E-4
Sparklines		8 9
1	0.36099	10
2	0.36218	9.9
3	0.36377	9.8
4	0.36581	9.7
5	0.36832	9.6
6	0.37133	9.5
7	0.37487	9.4
8	0.37895	9.3
9	0.38362	9.2
10	0.38889	9.1
11	0.39479	9
12	0.4	8.92026
13	0.4014	8.9
14	0.40891	8.8
15	0.41716	8.7

#### 6.10.3.5 Create a Contour Plot from XYZ Data

Origin can create contour plots directly from XYZ data in a worksheet without the need for an intermediate matrix. Delaunay Triangulation is used to compute and draw the contour lines.

1. Create a new worksheet and import the **3D XYZ.dat** from the **\Samples\Matrix Conversion and**

**Gridding** folder by using the **Import Single ASCII** button .

2. Highlight the third column and right click on it to select **Set As: Z**. Select **Plot > Contour: Contour - Color Fill** to create a graph as in the following image:

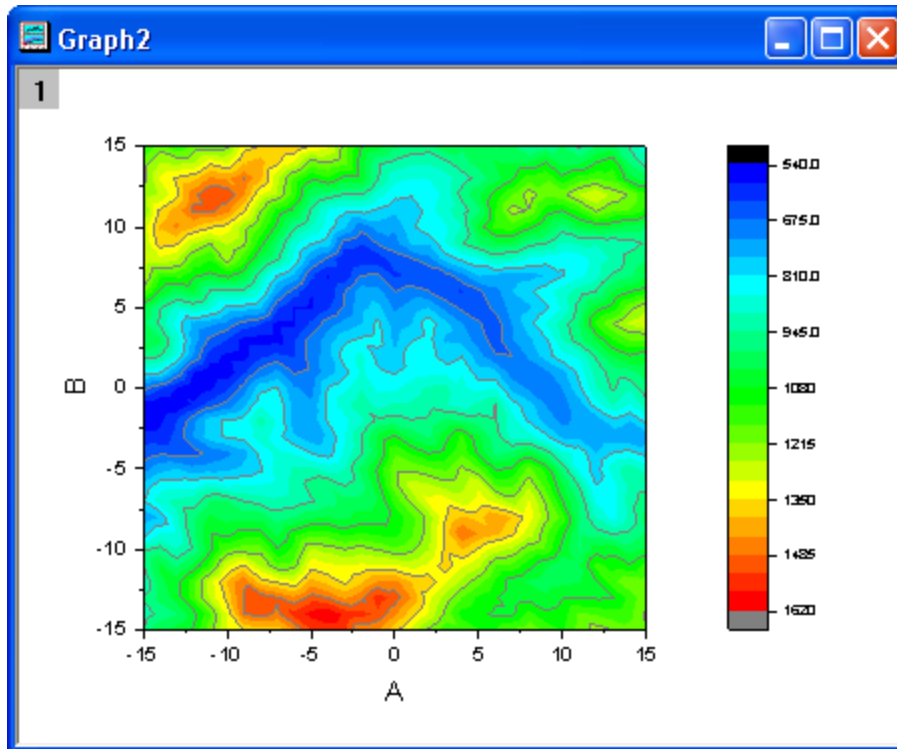

#### 6.10.3.6 Show the Triangulation Grid

1. Show the triangulation grid that is used to create a contour plot from the data. The individual data points are located at the nodes or vertices of the grid. Create a new worksheet and import the **XYZ Random Gaussian.dat** file from the **\Samples\Matrix Conversion and Gridding** folder by using the **Import Single ASCII** button  .
2. Highlight the third column and right click on it to select **Set As: Z**. Select **Plot > Contour: Contour - Color Fill** to create a graph.

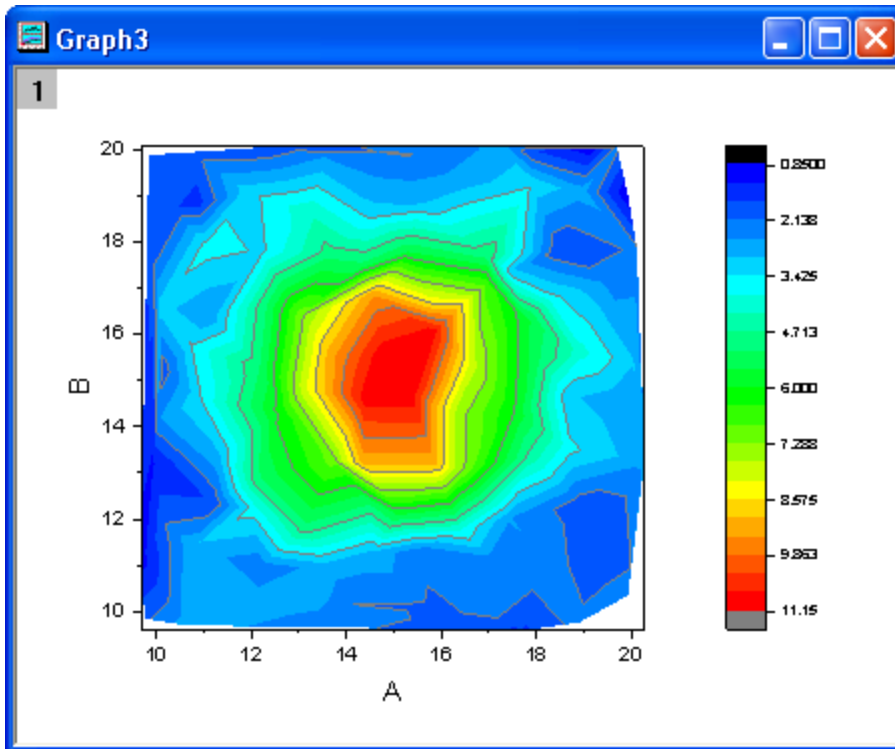

3. Double click on the contour plot to open the **Plot Details** dialog. On the **Colormap/Contours** tab, click on the **Line** heading to open the **Contour Lines** dialog. Deselect **Shown on Major Levels Only** and select **Hide All** to hide all the contour lines. Click **OK** to close this dialog. Then select the **Show Grid Lines** and **Show Data Points** check boxes. Click **OK** to close the **Plot Details** dialog.

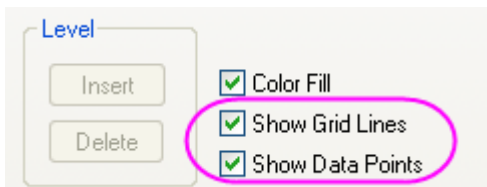

The contour plot with its superimposed grid should look like this:

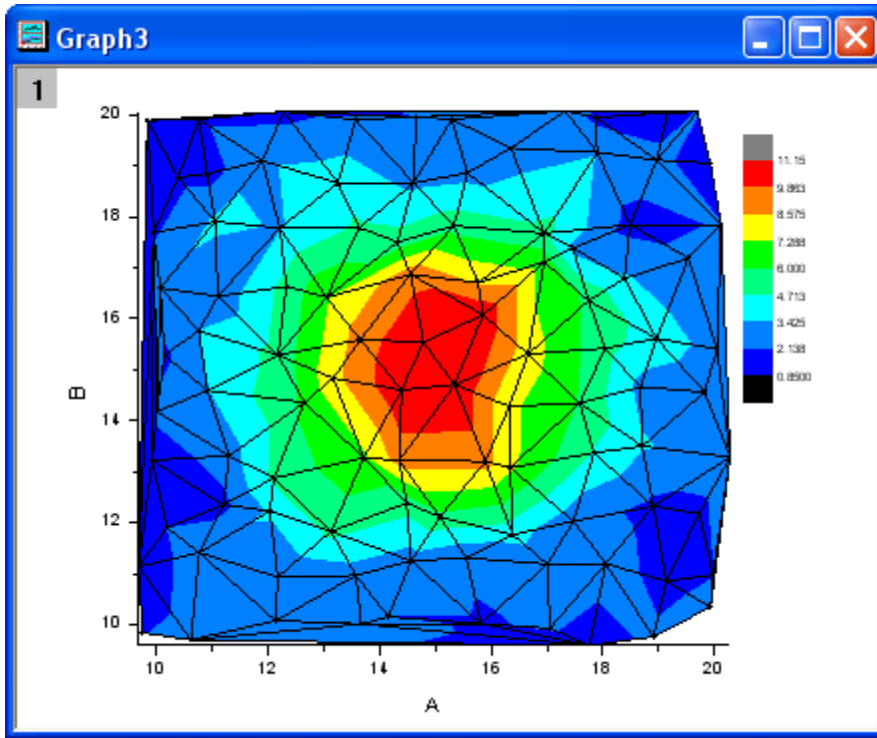

6.10.3.7 Apply Custom Boundary

A custom boundary can be applied to contour plots created directly from XYZ data where user provides the data points for the boundary in additional columns of the same worksheet. This feature is useful when there is a specific boundary data that defines the outline of an object, for example the profile of an engine where the contour shows engine temperature.

1. Continue to use the worksheet and the contour plot that was created with the **XYZ Random Gaussian.dat** in the previous example.
2. In the **XYZRandomGaus** workbook, click the **Add New Columns** button  twice to add two columns. Highlight the two columns and right click on them. Select **Set As: XY XY** from the context menu and enter four rows of data such as below:

12	10
18	12
16	18
14	16



3. Double click on the contour plot to open the **Plot Details** dialog. Select the **Contouring Info** tab in the right panel. Set the dialog as in the following image to customize the boundary for the contour plot. Remember to uncheck the **Show Grid Lines** and **Show Data Points** check boxes in the **Color Map/Contours** tab. Click **OK** to close the Plot Details dialog.

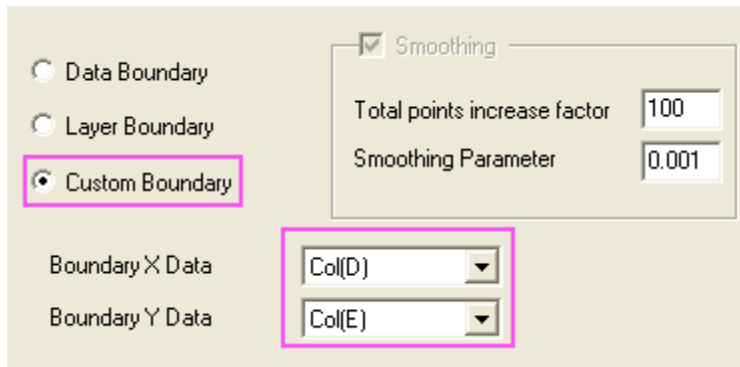

- 4.

The graph should resemble the following image:

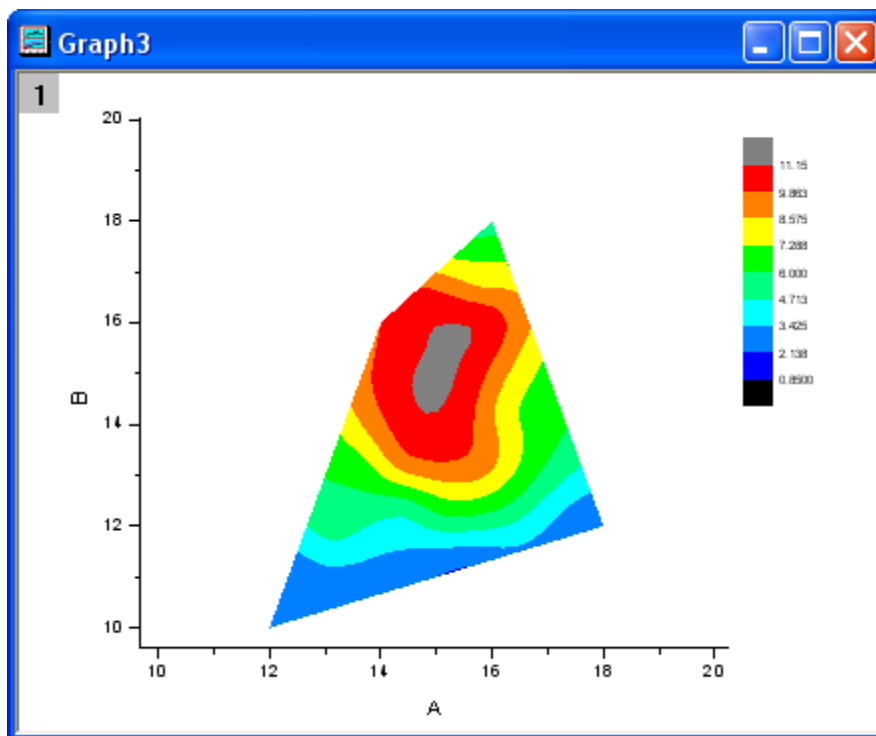

Prior to Origin 2018 SR0, the application of a custom boundary sometimes generated an imperfect fill at boundary margins. This has been improved in 2018. The user can restore the previous contour-fill behavior using [system variable @TCSM](#).

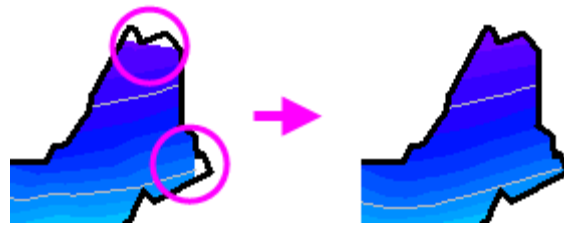

## 6.10.4 Ternary Contour

### 6.10.4.1 Summary

This tutorial will show you how to create a Ternary Contour graph and to overlay a scatter plot.

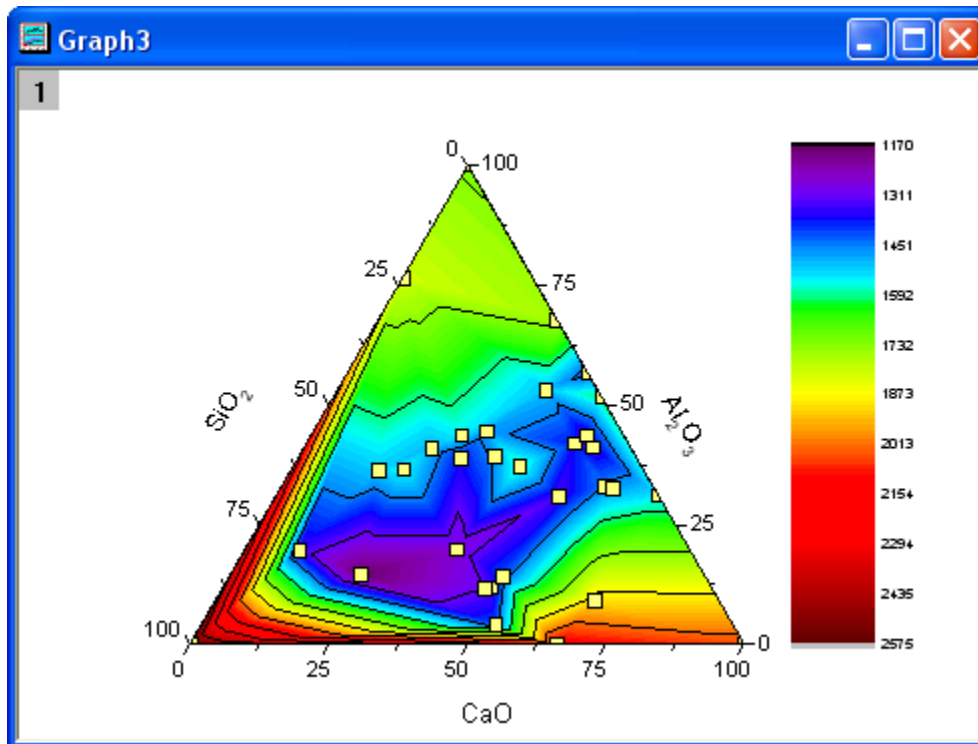

### 6.10.4.2 What will you learn

- Create the Ternary Contour graph
- Overlay a scatter plot using the Plot Setup dialog box.
- Customize the graph using the Plot Details dialog box.

### 6.10.4.3 Steps

This tutorial is associated with <Origin EXE Folder>\Samples\Tutorial Data.opj.

Also, you can refer to this graph in Learning Center. (Select **Help: Learning Center** menu or press **F11** key , and then open **Graph Sample: Contour**)

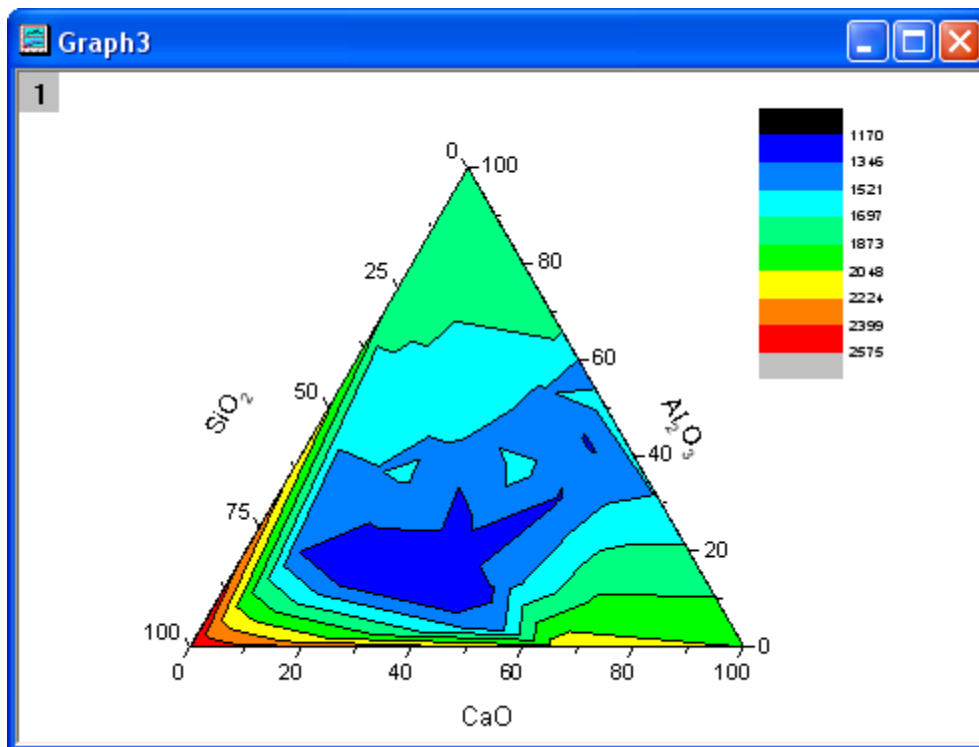

1. Open **Tutorial Data.opj** and browse to the **Ternary Contour** folder in **Project Explorer** (PE).
2. Activate **Book1A**, highlight the entire worksheet and select **Plot > Contour: Ternary Contour** to create a Ternary Contour graph. The graph should look like this:

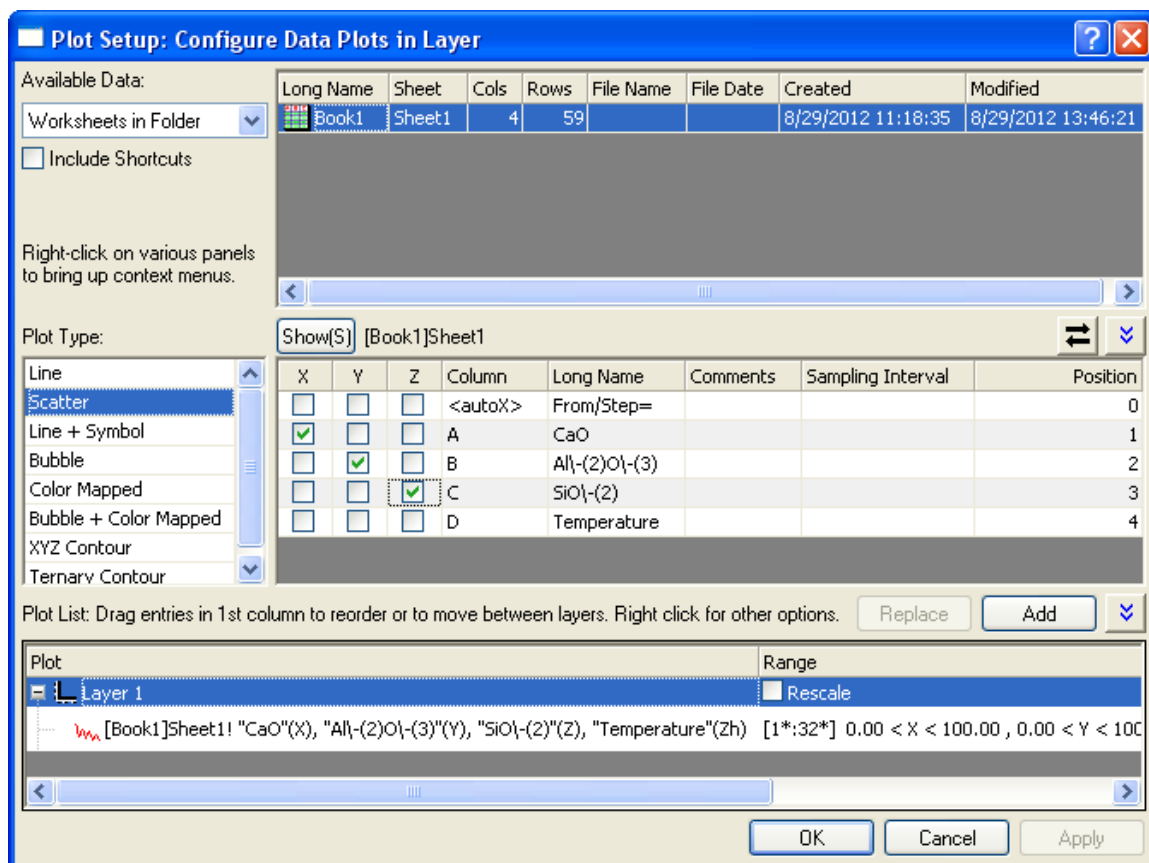

3. Now we will overlay a scatter plot on the ternary contour graph. Right-click on the layer icon and select **Plot Setup** from the context menu. This opens the **Plot Setup** dialog box.
4. In the upper-left corner of the dialog box, set **Available Data** to **Worksheets in Folder**. Select **Book1**, set **Plot Type** to **Scatter** and select check boxes to the left of columns A, B and C so that they plot as X, Y and Z, respectively. Click **Add** to add the scatter plot to Plot list at the bottom of the Plot Setup dialog

box. The settings should duplicate those shown in the following image:



In order to show all three panels in **Plot Setup** dialog, please expand **Plot Type** panel by clicking  and expand **Available Data** panel by clicking  again.

Please refer to [Plotting using Plot Setup](#) for more information.

- Now we will customize the contour graph and the scatter plot. Double-click on the contour plot to bring up the **Plot Details** dialog box.

6. Select the **Color Map/Contours** tab, click on the **Level** heading, then duplicate the settings as shown in the image.

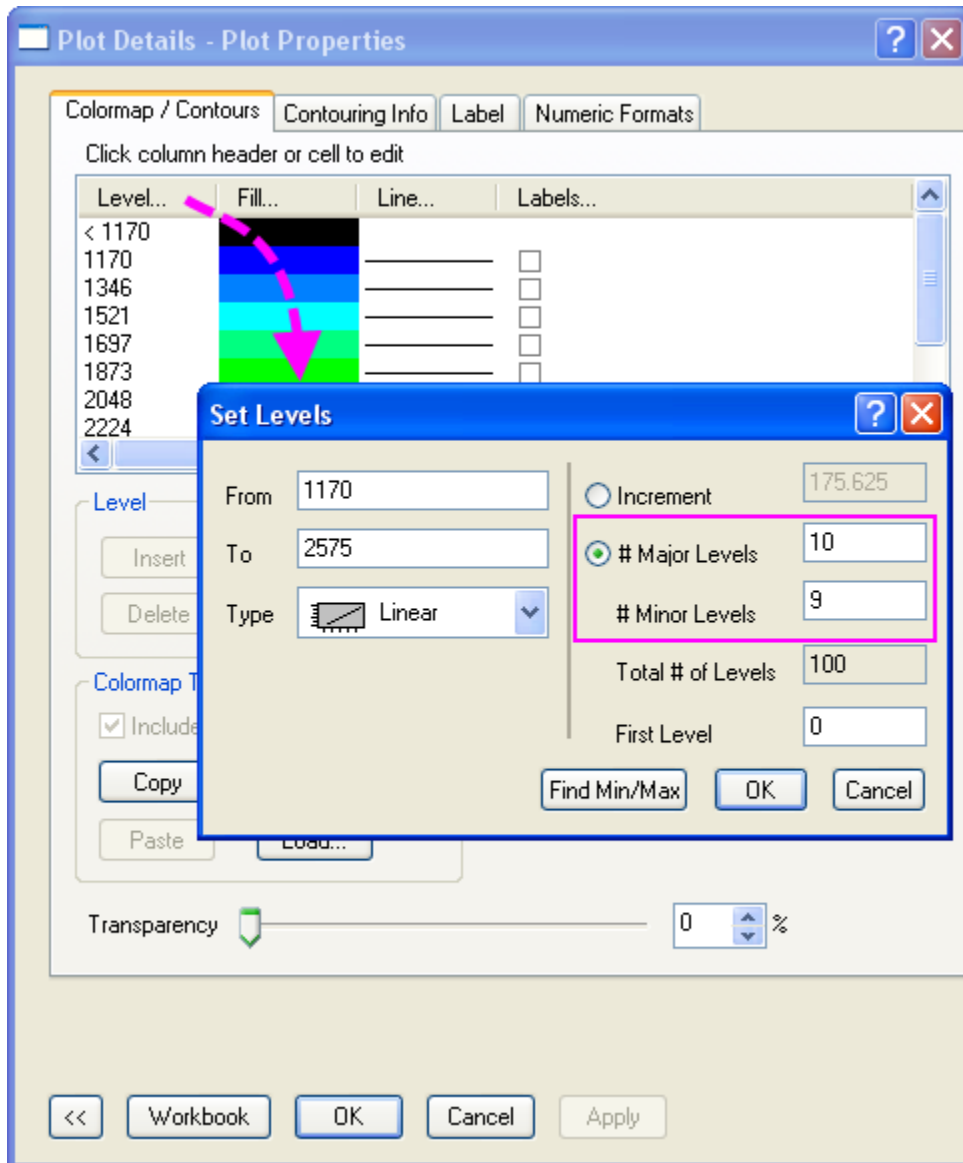

7. Click **OK** to close the **Set Levels** dialog box. Click on the **Fill** heading to open the **Fill** dialog box. Select **Load Palette**. Select **Rainbow** from the **Palette** list and click **OK**.
8. In the left panel of **Plot Details**, select the scatter plot and customize the symbols as follows (note that to enable the **Fill Color** list, you must click the downward-pointing arrow beside **Preview** and choose one of

the unfilled symbols from the gallery):

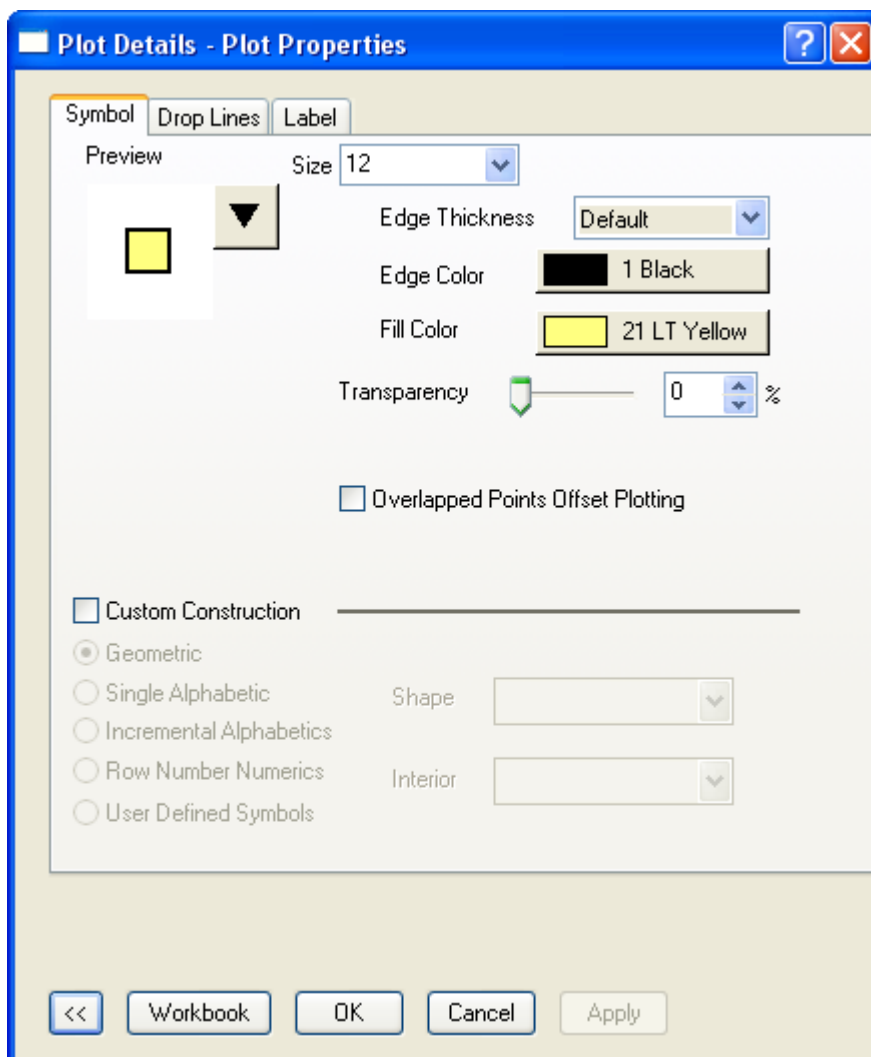

9. Click **OK** to close the **Plot Details** dialog box.

10. Drag the color scale to resize it and move it to a suitable place on the graph. The graph should now look something like this:

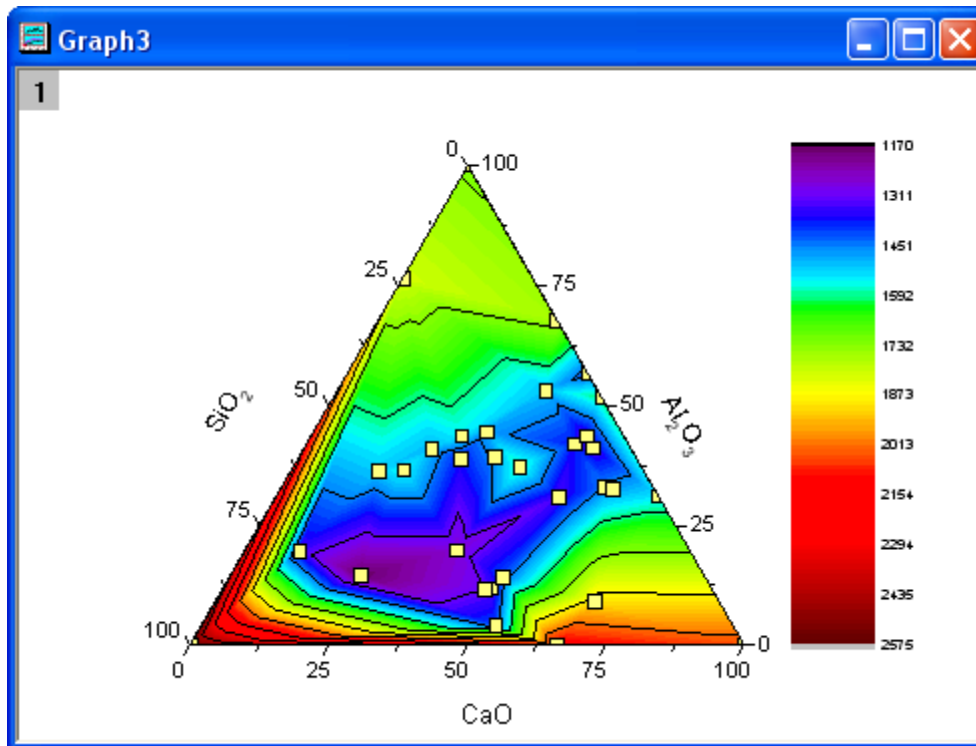

### 6.10.5 Combining Line and Contour Plots

#### 6.10.5.1 Summary

This tutorial will show you how to create a Word Map by combining Line Plot and Contour graph.

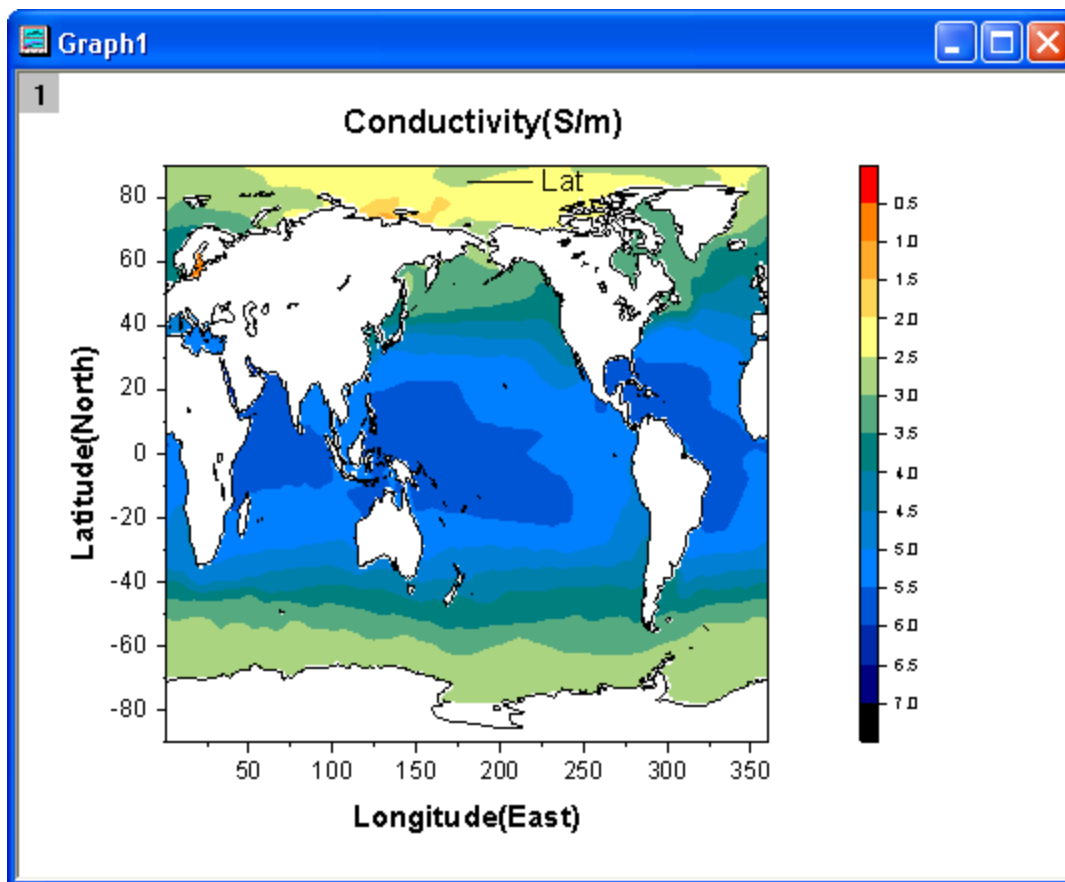

#### 6.10.5.2 What will you learn

- Create a contour graph
- Combine a Line Plot and a Contour graph
- Customize the contour graph

#### 6.10.5.3 Steps

This tutorial is associated with <Origin EXE Folder>\Samples\Tutorial Data.opj.

1. Open **Tutorial Data.opj** and browse to the **Map Combining Line and Contour Plots** folder in **Project Explorer** (PE).
2. Activate **MBook1A** matrix and highlight entire matrix. Select **Plot > Contour : Contour - Color Fill** to create a contour graph.



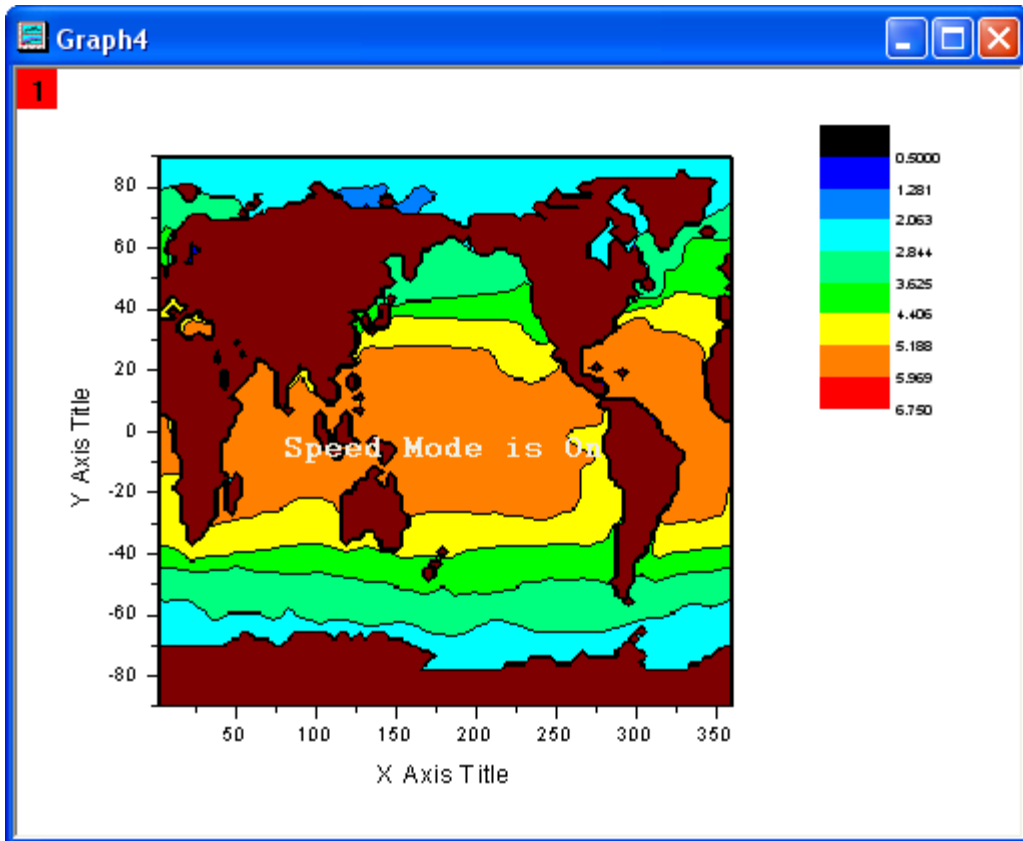

- At this step, we will add a Line plot to the contour graph. Select **Graph: Layer Contents** to open the dialog. In the top-right available data drop-down list of the dialog, choose **Worksheets in Folder**. Select B(Y) column of the Book5 in the left panel, choose **Line** plot type, and add to the right panel. Then click **OK** button. Delete the legend for the added line plot.

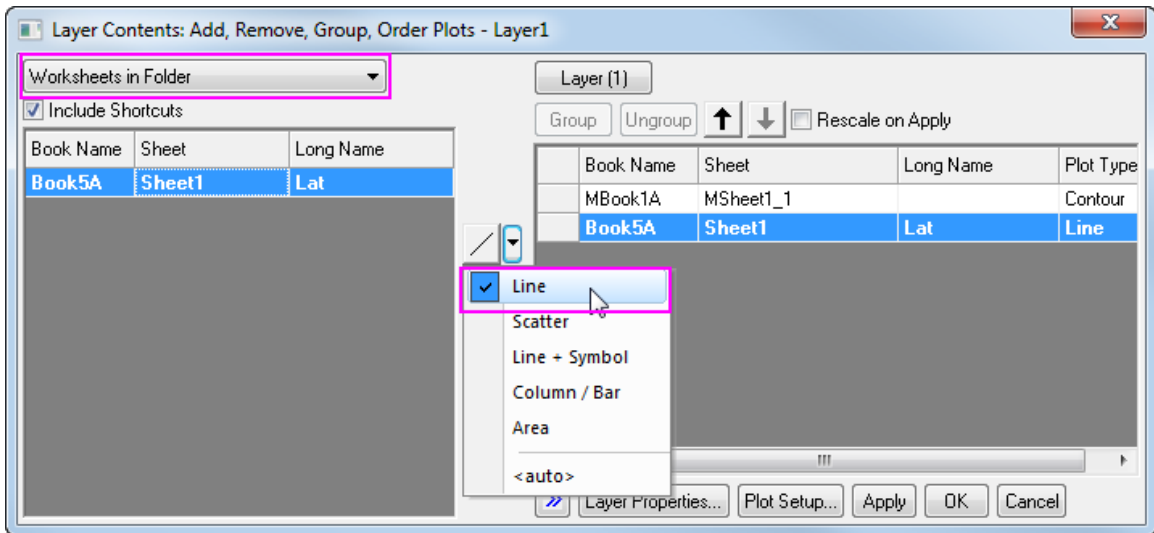

4. In the following steps, we will customize the graph. Select **Format: Layer** to open the Plot Details dialog. Select the **Size/Speed** tab, disable two checkboxes that in the **Speed Mode, Skip Points if needed** group.
5. Expand the **Layer1** branch and select contour plot in the left panel of the Plot Details dialog. Then do the following things:
  - o Go to the **Color Map/ Contours** tab, click the **Level** heading to open the **Set Levels** dialog. Set the dialog as the following image shows:

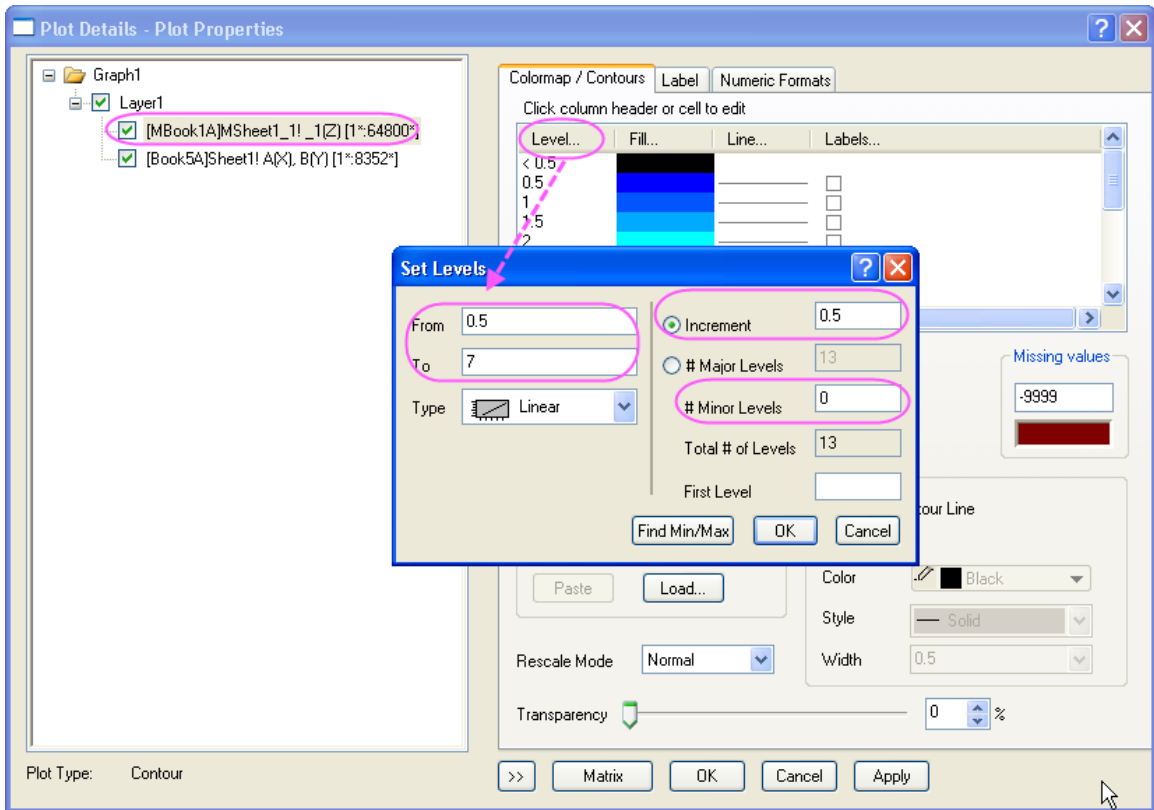

- o Click OK button to close the dialog. Click the **Fill** head to open the **Fill** dialog, select **Introduce Other Colors in Mixing** radio box. Then set **From** to **Orange** and **To** to **Navy**.
- o Click OK button to close the dialog. Click the cell the in the **Fill** column and **<0.5** row to set fill color to **Red**.

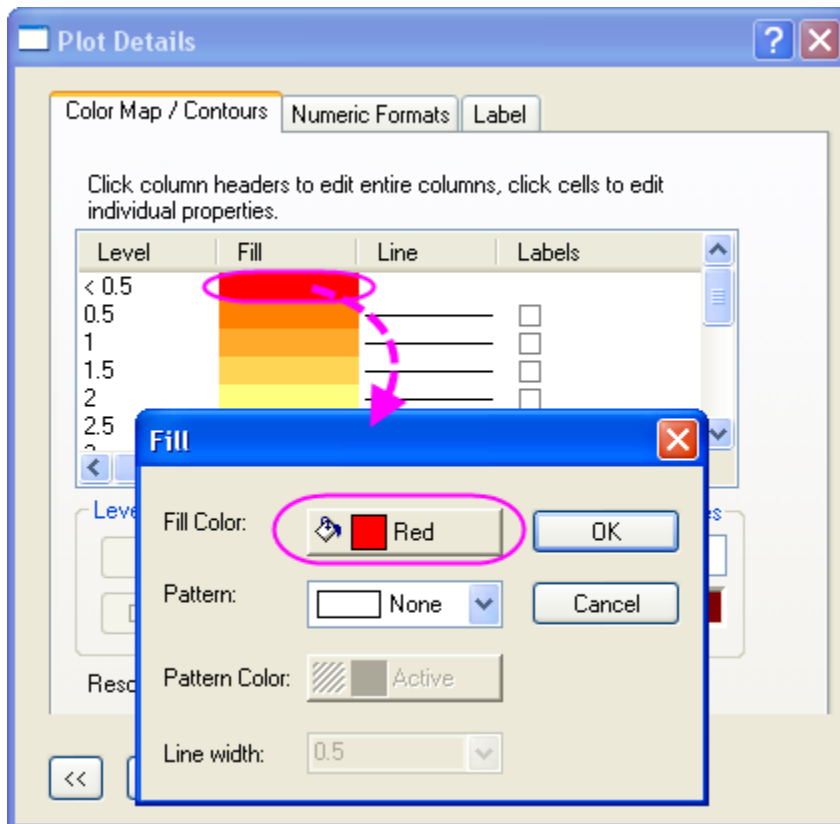

- Click OK button to close the dialog. Click the cell the in the **Fill** column and **>7** row to set fill color to **Black**.
- Click OK button to close the dialog. Click the **Lines** heading to open the Contour Lines dialog, uncheck the **Show on Major Levels only** check box and then select the **Hide All** option.
- Click OK button to close the dialog. Click the **Color** box that in the **Missing Value** group, set fill color to **White**. Click OK button.

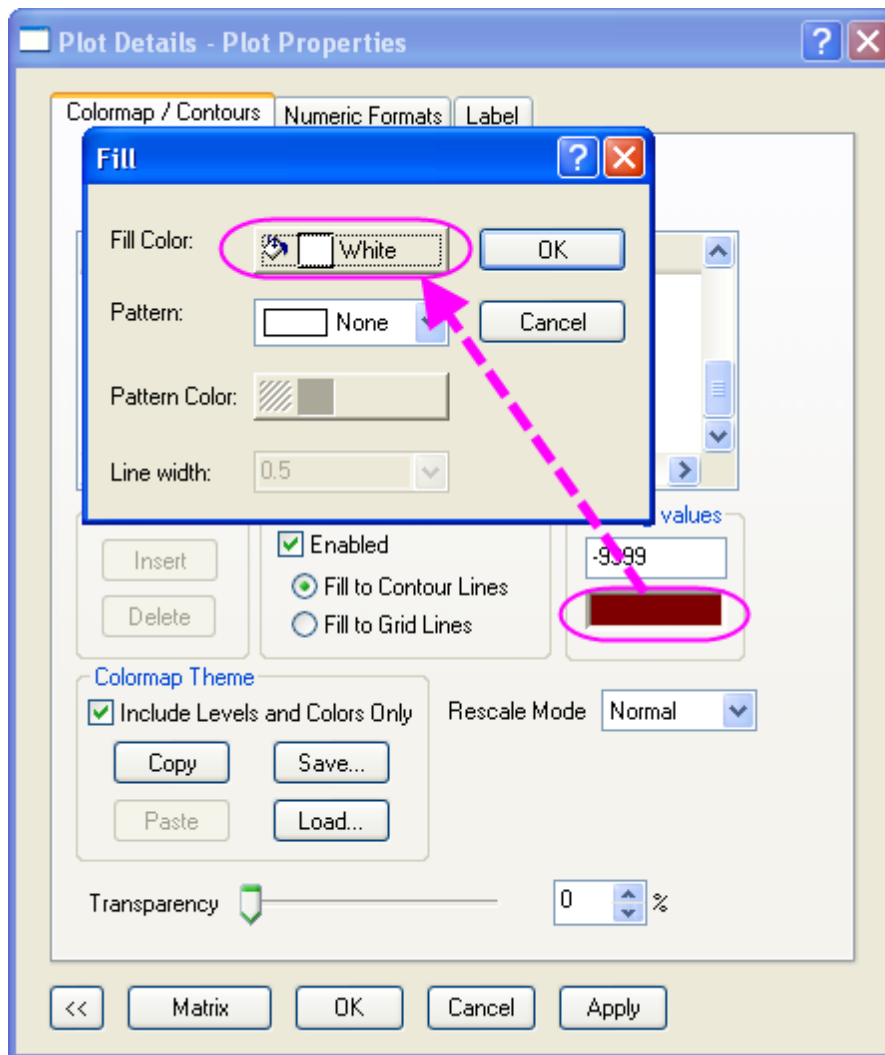

6. Go to **Numeric Formats** tab of **Plot Details** dialog, select **Decimal Places** radio box and keep the default value **1**.

7. Click **Ok** button to apply the settings to the graph. The graph should look like:

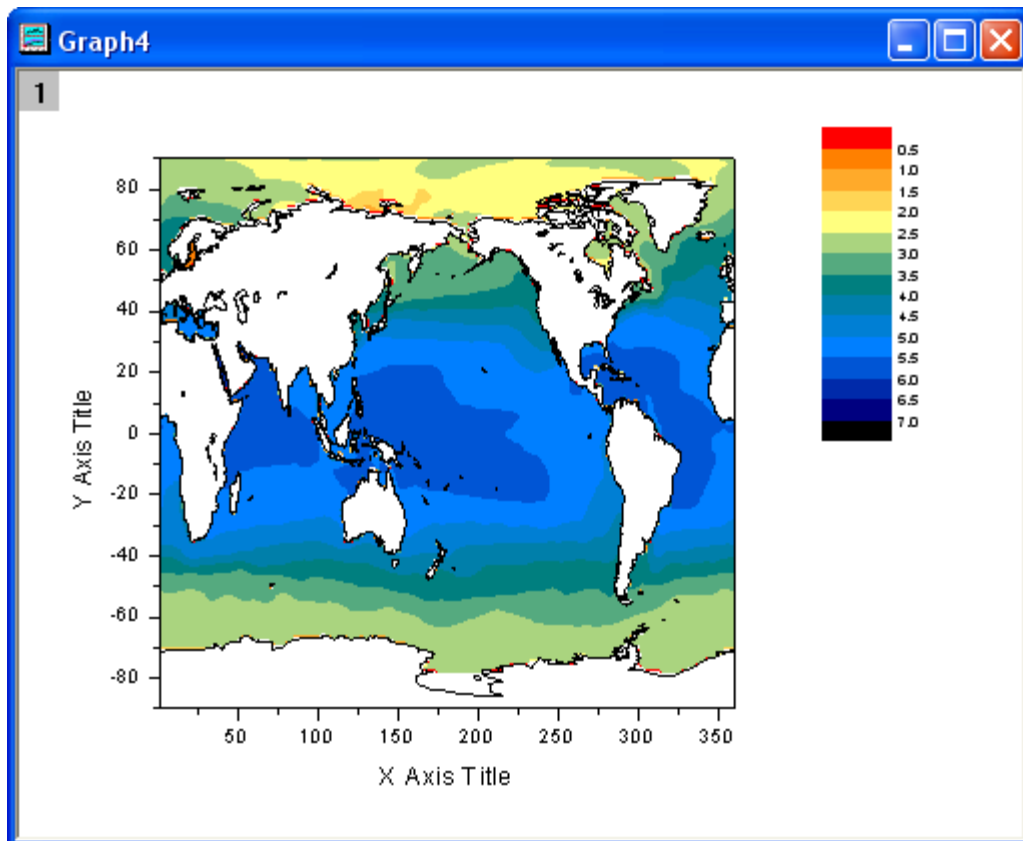

Double click on the **Color Scale** to open the **Color Scale Control** dialog and go to the **Layout** page, do the following setting:

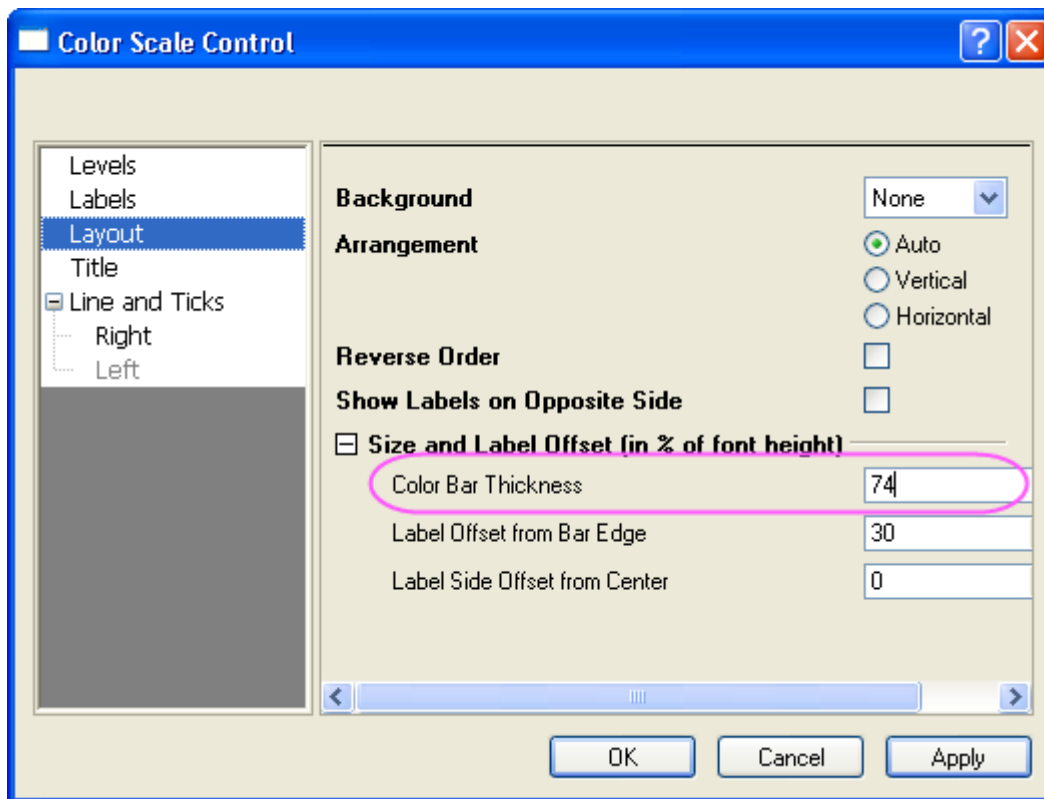

Go to the **Levels** page, do settings as below:

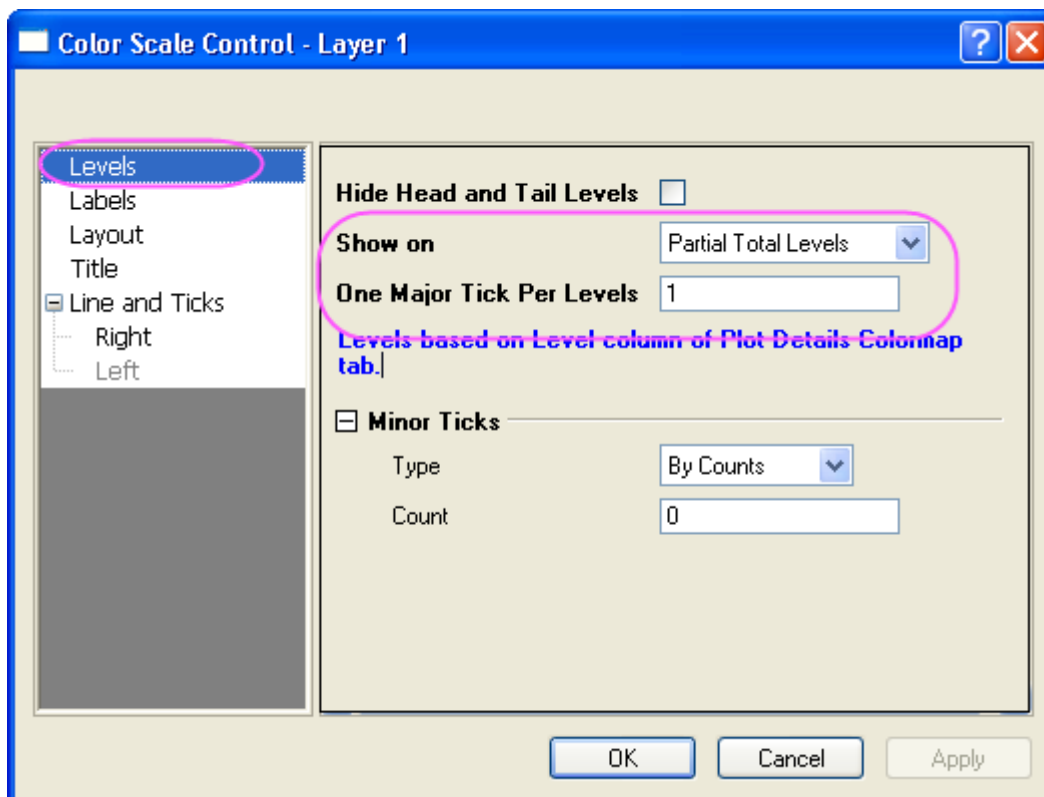

8. Resize and reposition of the color scale. Then modify the X, Y axis tick labels, titles and add the graph title as the example graph shows. The graph should look like

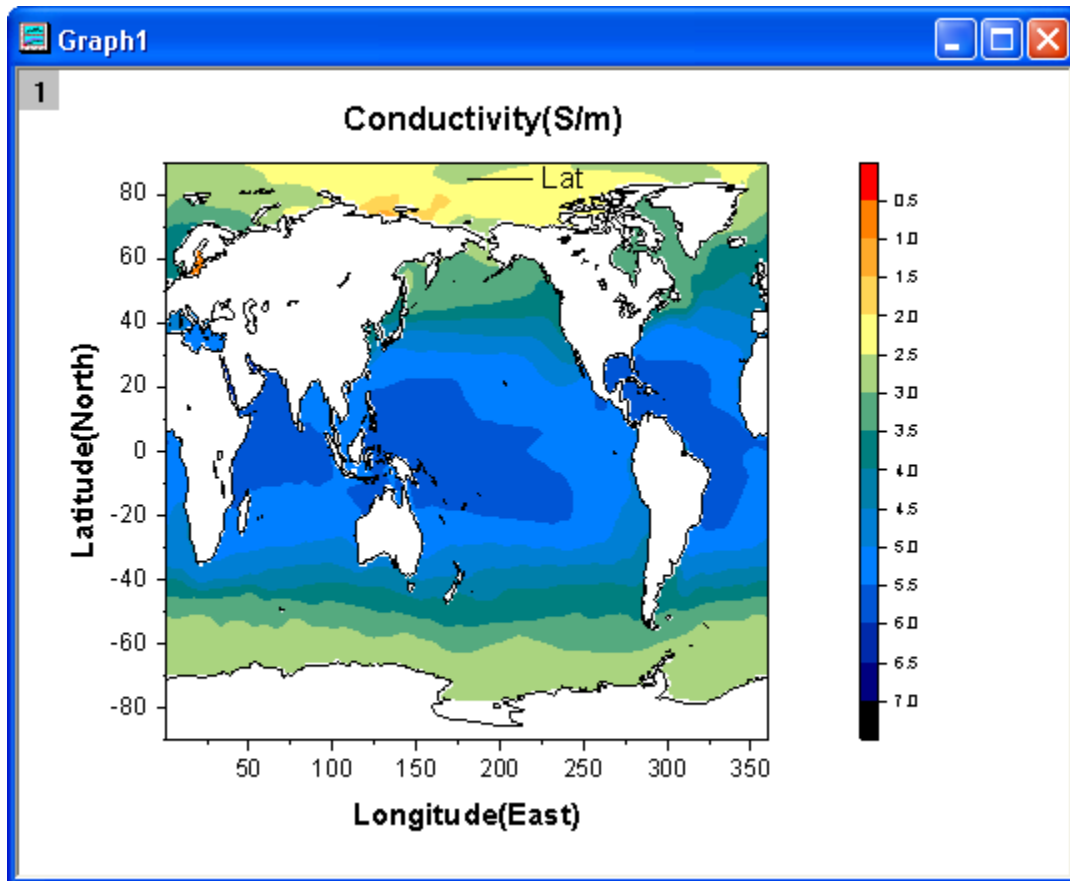

### 6.10.6 Contour Graph with XY Data Points and Z Labels

#### 6.10.6.1 Summary

This tutorial will show you how to create a contour from XYZ data and add Z value as label for each XY data point.

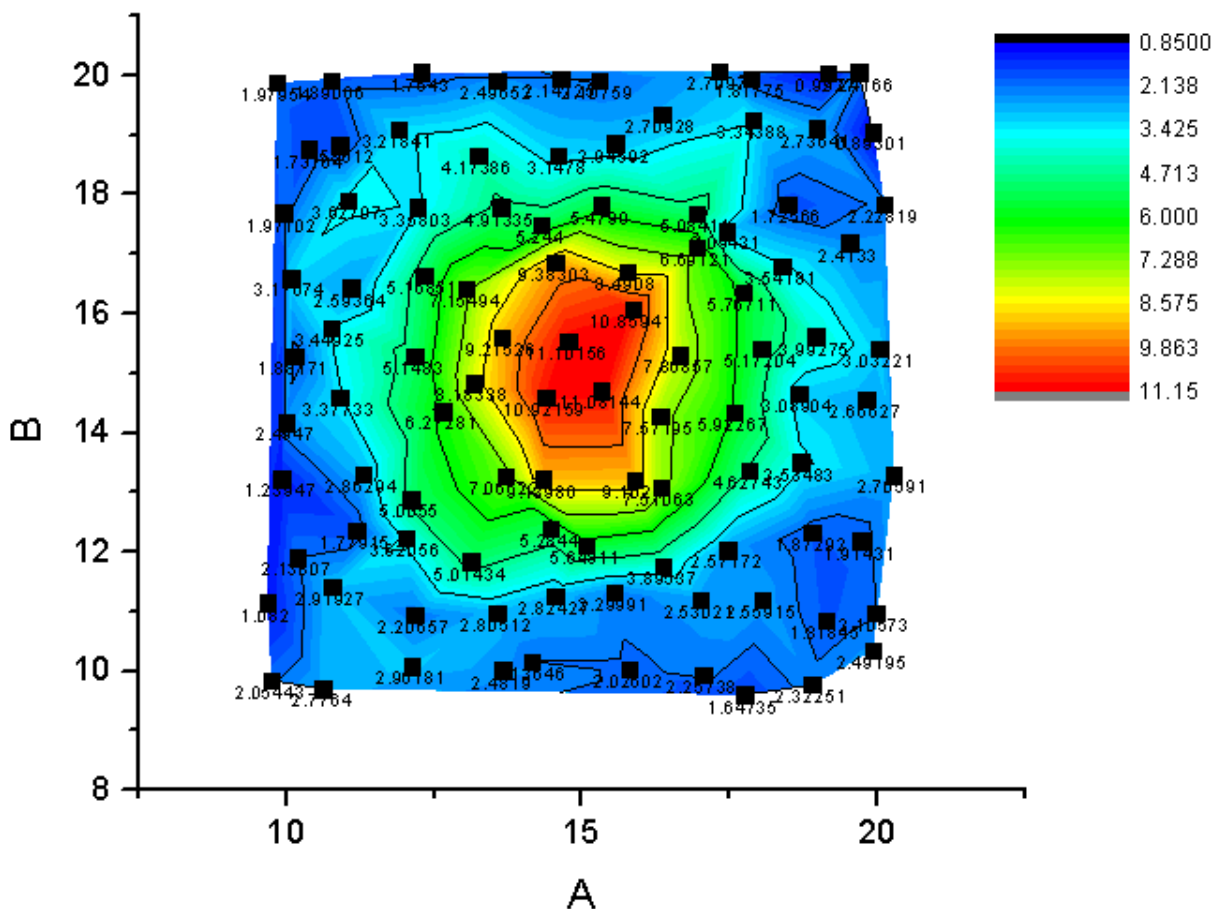

### 6.10.6.2 What will you learn

This tutorial will show you how to

- Create a Contour Plot from XYZ data.
- Customize levels, lines, and color mapping.
- Plot a scatter plot on a contour graph.
- Show the labels for scatter points.

### 6.10.6.3 Steps

1. Start a new workbook and import the file  
*Sample/Matrix\_Conversion\_and\_Grid/XYZ\_Random\_Gaussian.dat.*
2. Highlight col(C) and set it as Z. Then highlight all columns and select **Plot > Contour : Contour - Color Fill** from the main menu to plot a contour graph.



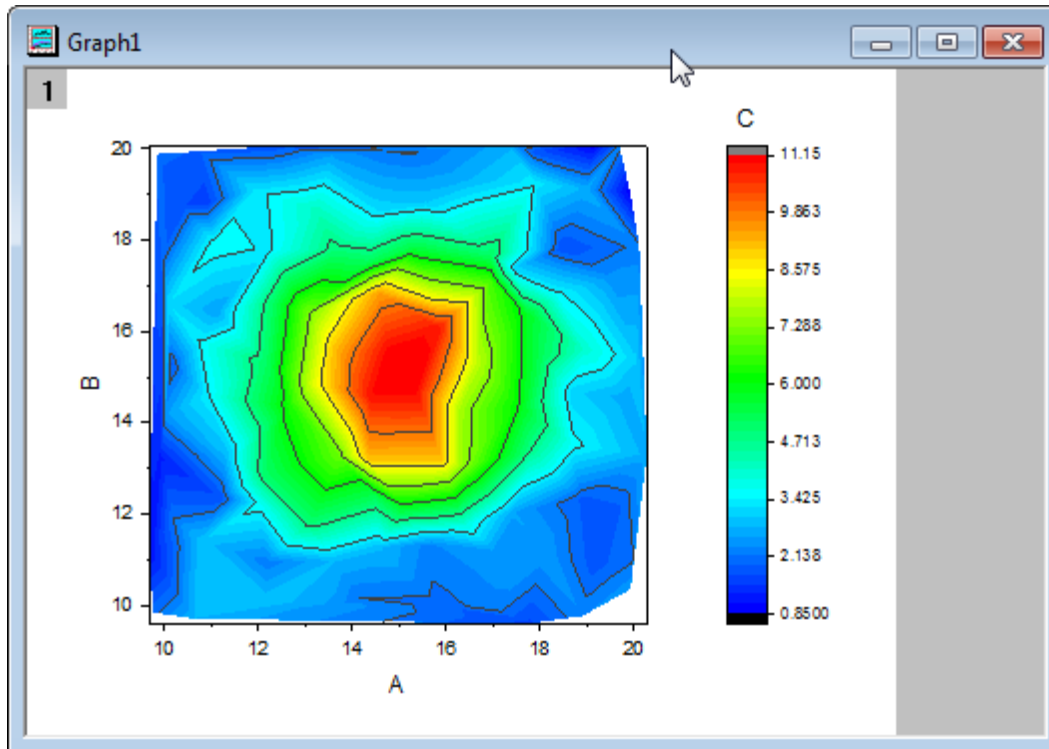

3. Double-click the layer icon to open the **Layer Contents** dialog. In this dialog, select col(B) in the left panel, set the **Plot Type** as *Scatter*, then add it to the right panel.

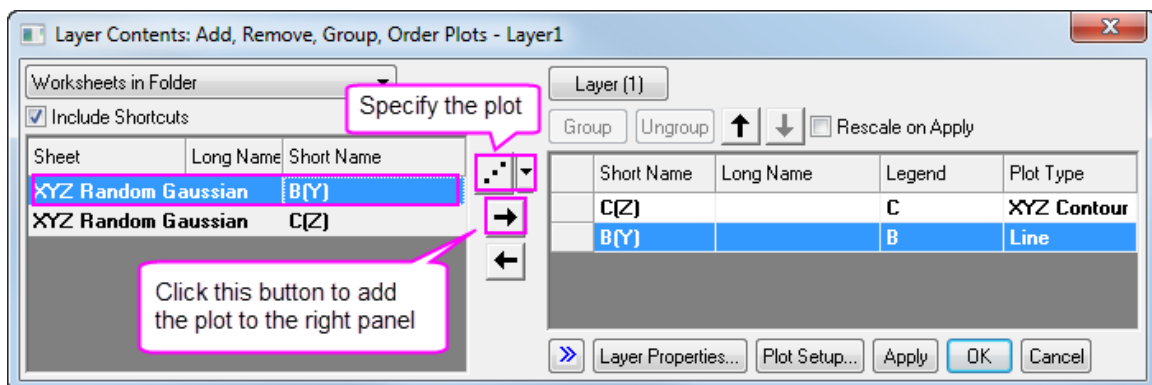

4. Click **OK** button to close the dialog. The scatter plot will be added to the contour graph.

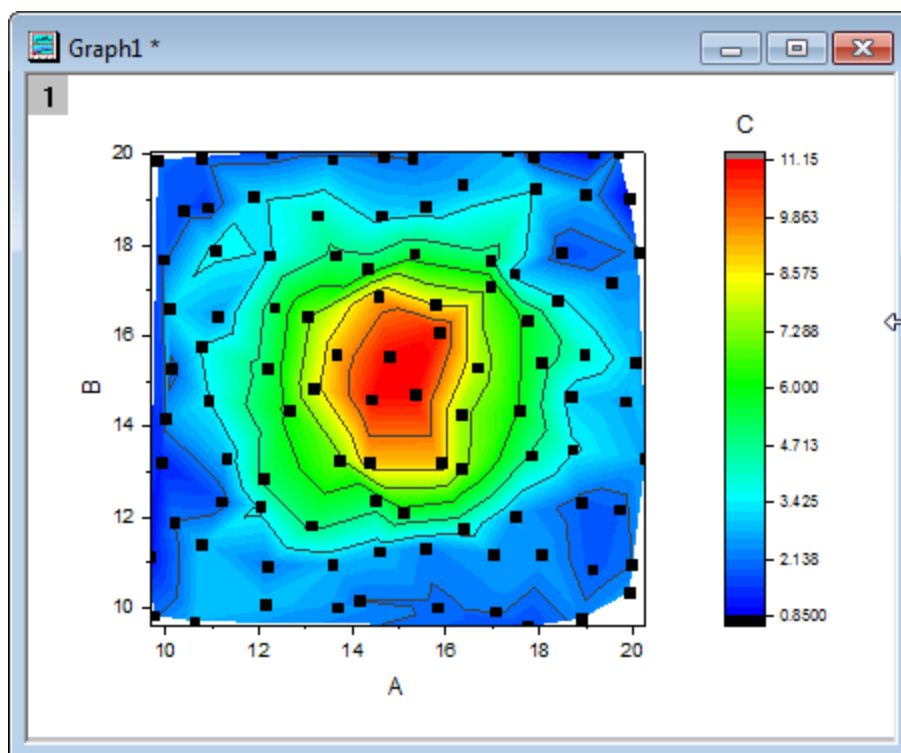

5. Double-click the graph to open the **Plot Details** dialog. In this dialog, go to the **Colormap/Contours** tab, the contour plot in the left panel is selected. Click the **Level...** header to open the **Set Levels** dialog to set the **Minor Levels** as 4.

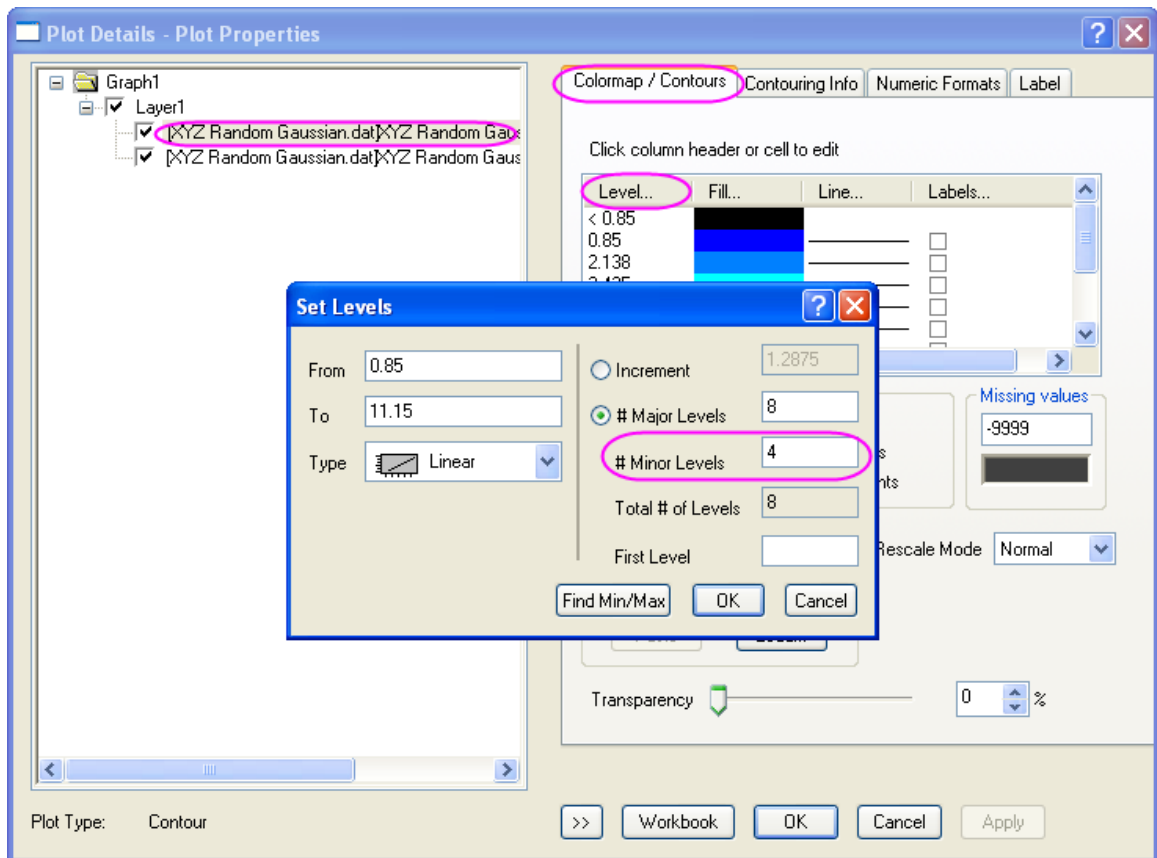

- Click **OK** button to go back the **Plot Details** dialog. Go to the **Label** tab while the scatter plot is selected in the left panel, check the **Enable** check box to activate this tab. Set the **Size** as 12, **Position** as *Below* and **Label Form** as *Col(C)*.

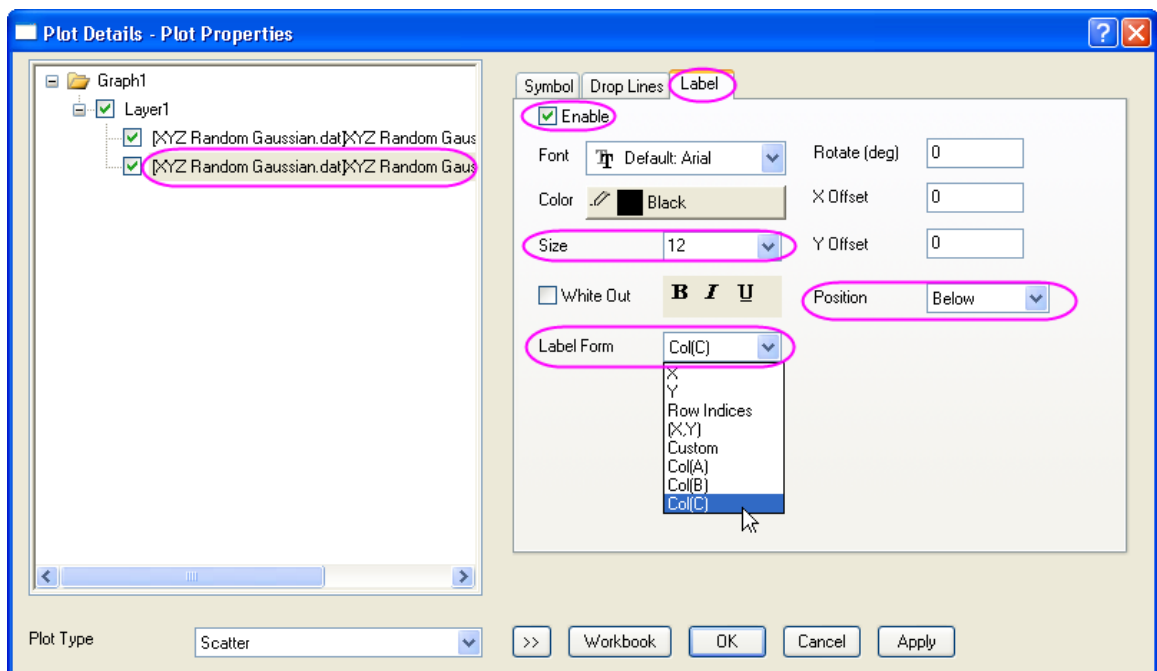

- Click **OK** button to close this dialog. The Z values will be added as labels to the graph. Click the **Rescale** button  to rescale the graph.

## 6.10.7 Contour Plot with Vector Overlay

### 6.10.7.1 Summary

This tutorial will demonstrate how to create a contour plot with vectors overlay.

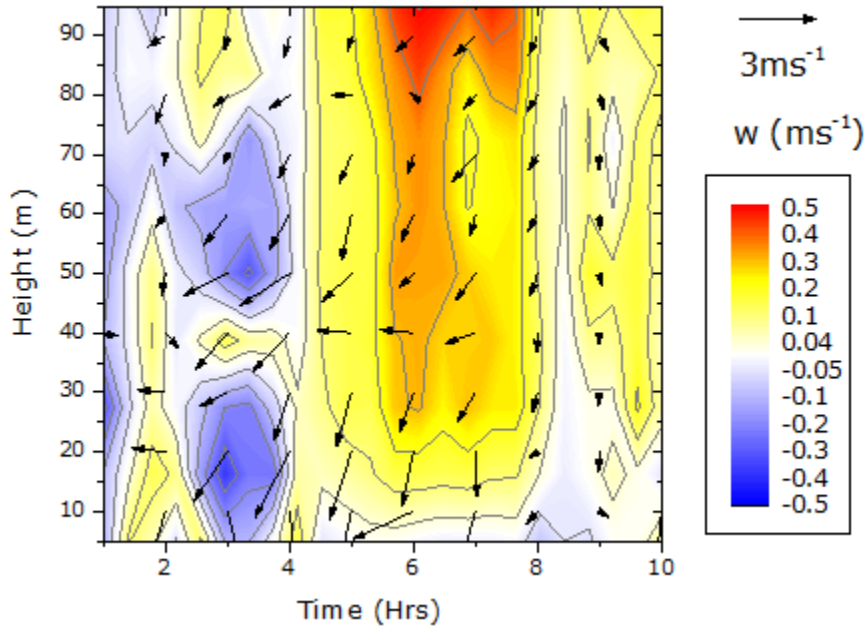

### 6.10.7.2 What you will learn

This tutorial will show you how to:

- Create and customize a contour graph and its color scale
- Create the XYAM vector graph
- Merge the two graphs

### 6.10.7.3 Steps

This tutorial is associated with <Origin EXE Folder>\Samples\Tutorial Data.opj.

Also, you can refer to this graph in Learning Center. (Select **Help: Learning Center** menu or press **F11** key , and then open **Graph Sample: Contour**)

#### 6.10.7.3.1 Create the Contour Graph

1. Open **Tutorial Data.opj** and browse to the **Contour Plot with Vector Overlay** folder in **Project Explorer** (PE).

2. Activate the **W147** matrix and select **Plot> Contour: Contour - Color Fill** in the menu. The graph below will be created:

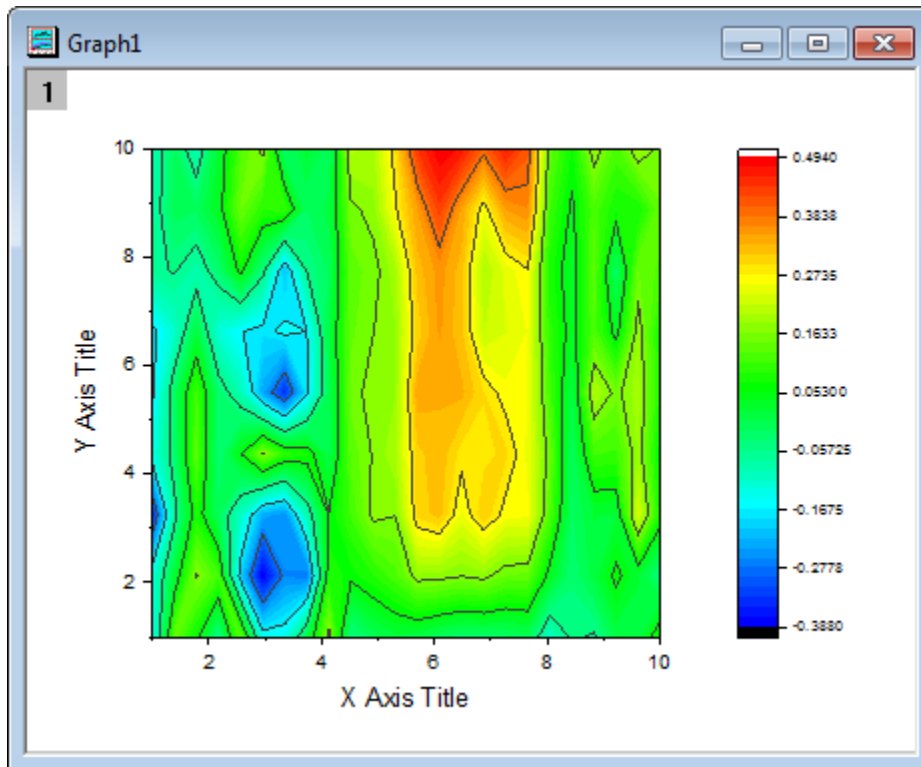

3. Select **Format: Plot** to bring up the **Plot Details** dialog. In the **Colormap/Contours** tab customize the Contour settings as shown below:
  - o Click the **Level** heading to set the following levels at the **Set Levels** dialog:

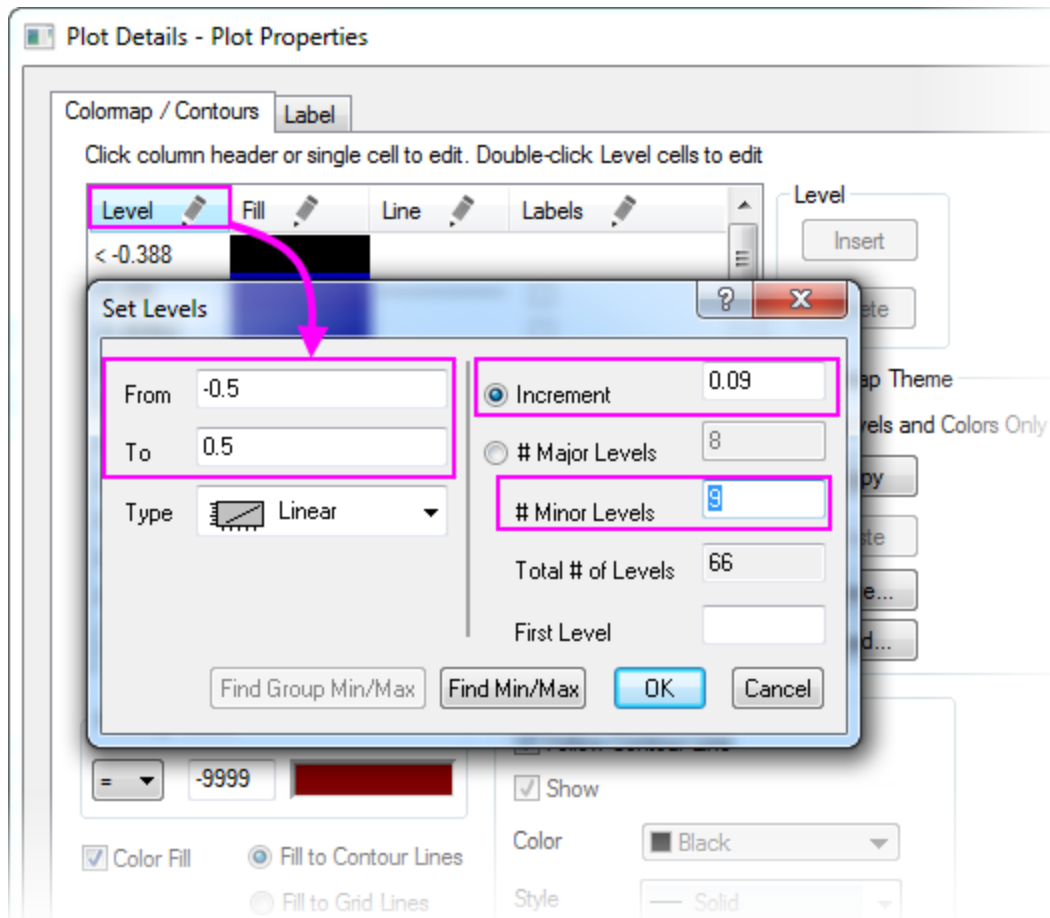

- o Click the **Fill** heading to select **Load Palette**, and choose **Temperature** from the **Palette** list in **Fill** dialog. Click **OK**.
- o Click the **Line** heading, enable the **Color** check box under **Apply to All** and choose **Gray** in the **Color** drop-down list. Click **OK**.

- Go to **Label** tab, select the **Significant Digits** radio button and set the value to **1**. Click **OK**.

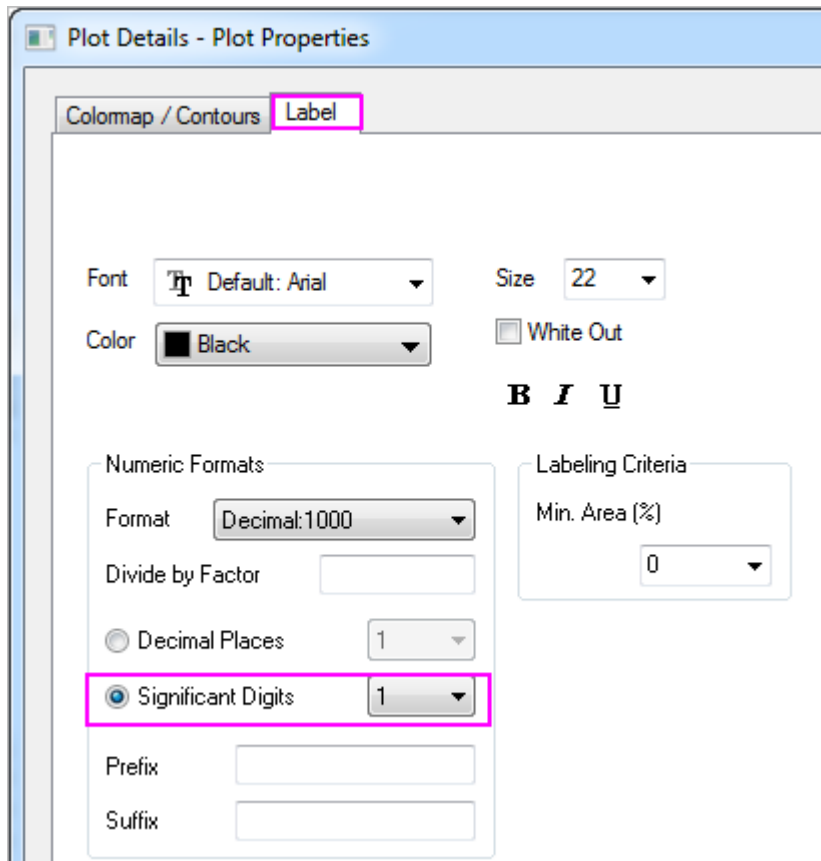

- Let's make preparations for [the third section Merge the Two Graphs](#). First, we are going to hide the axes. Select **Format: Layer** and in the **Display** tab deselect the **X Axes** and **Y Axes** check boxes. Click

OK.

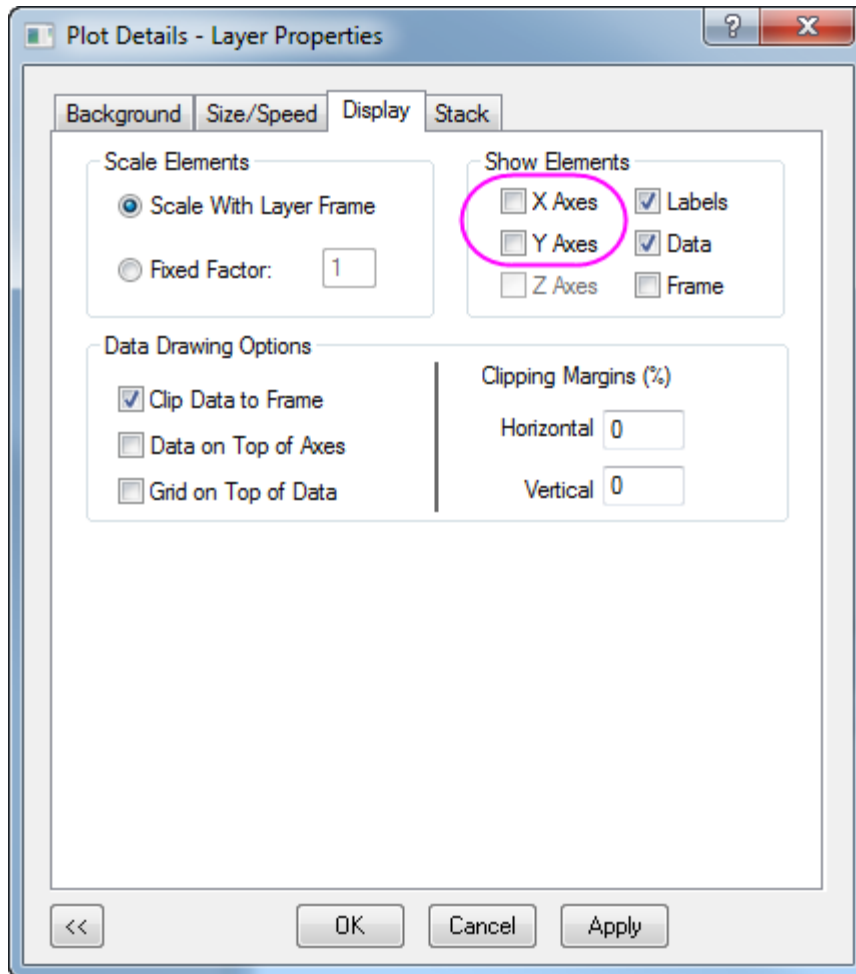

6. Delete X and Y Axis title.
7. To change the color scale, double-click on the scale object to open the **Color Scale Control** dialog. Do the settings below:
  - o In the **Labels** node,
    - Set the **Font** to **Verdana**.



- Set the **Size** to **22**.

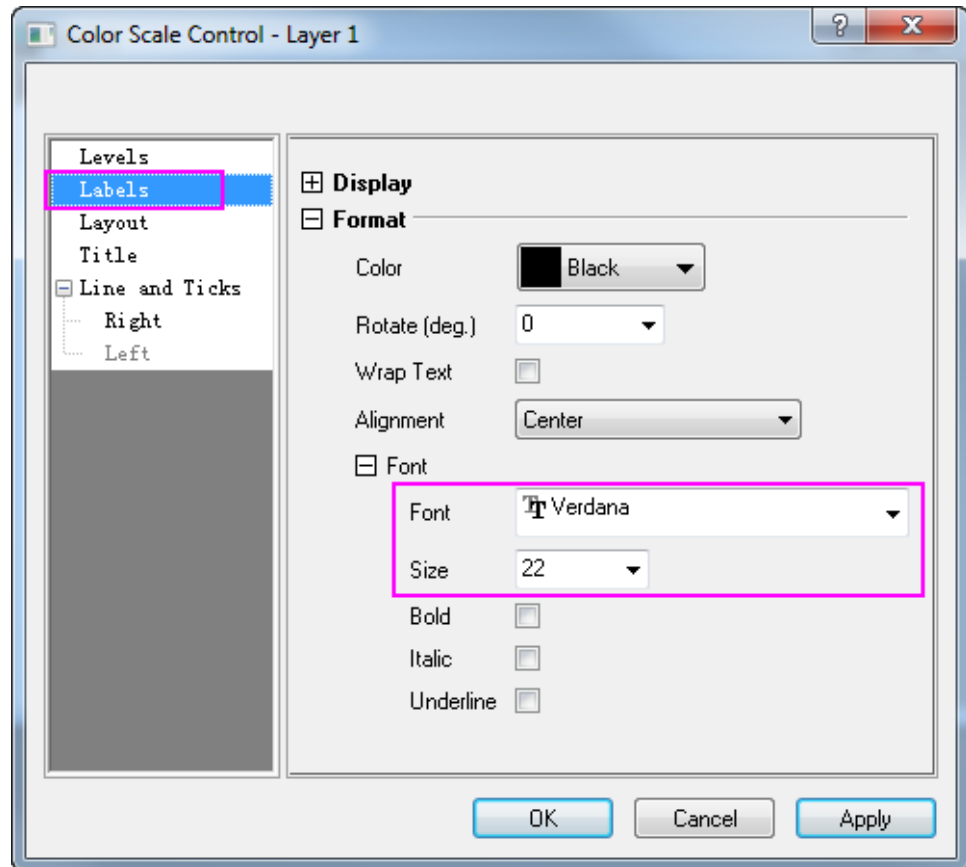

- In the **Layout** page,
  - Select **Black Line** from the **Background** drop-down list,
  - Set **Color bar thickness** to **100**.

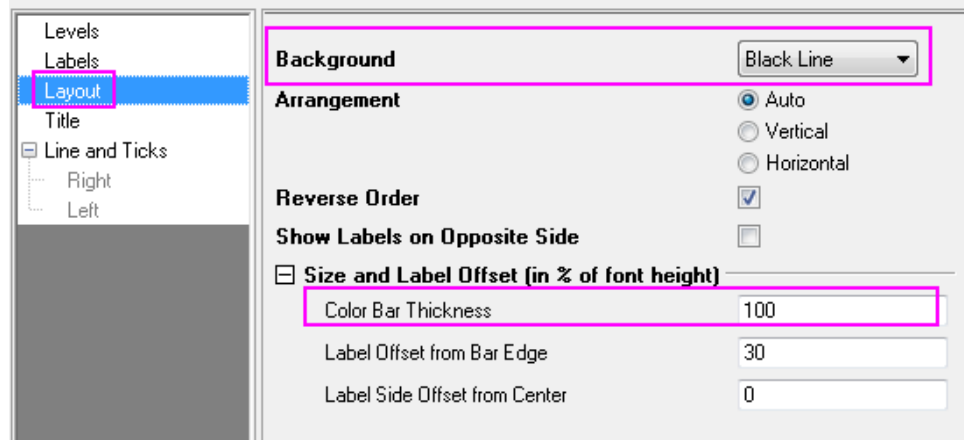

- In the **Title** page, enter  $w(ms\{+(-1)\})$  in the **Title** box and set Font Size to 26.

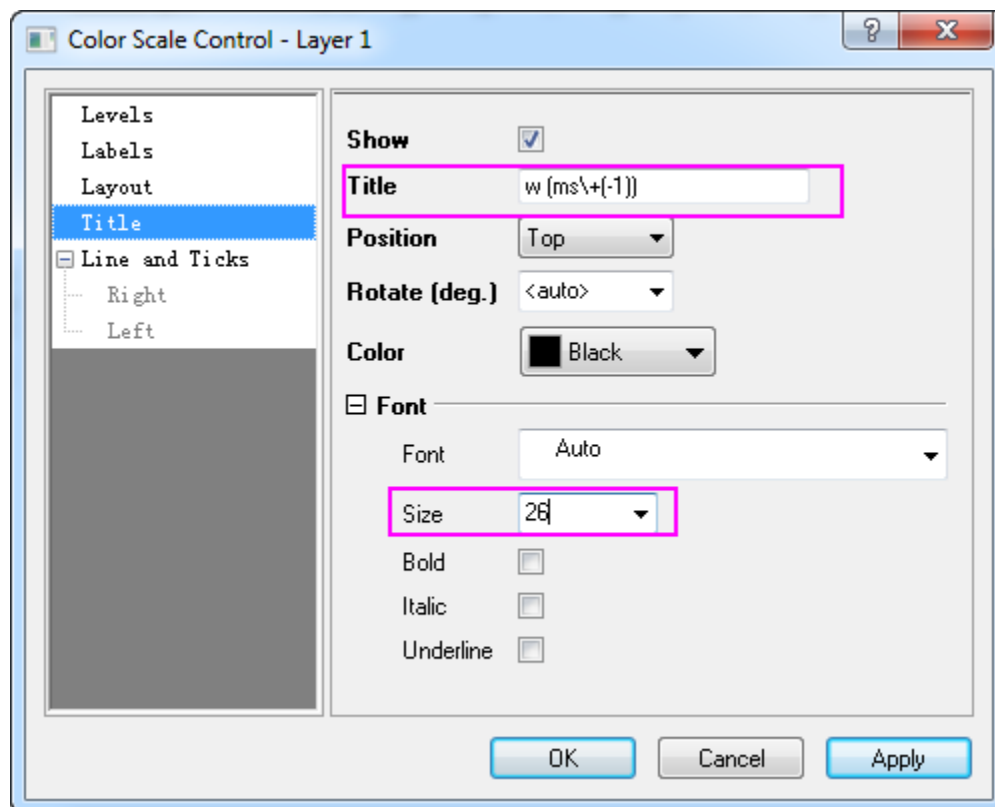

- In the **Line and Ticks** page, uncheck **Show Line and Ticks on Right** and **Show Border** check box

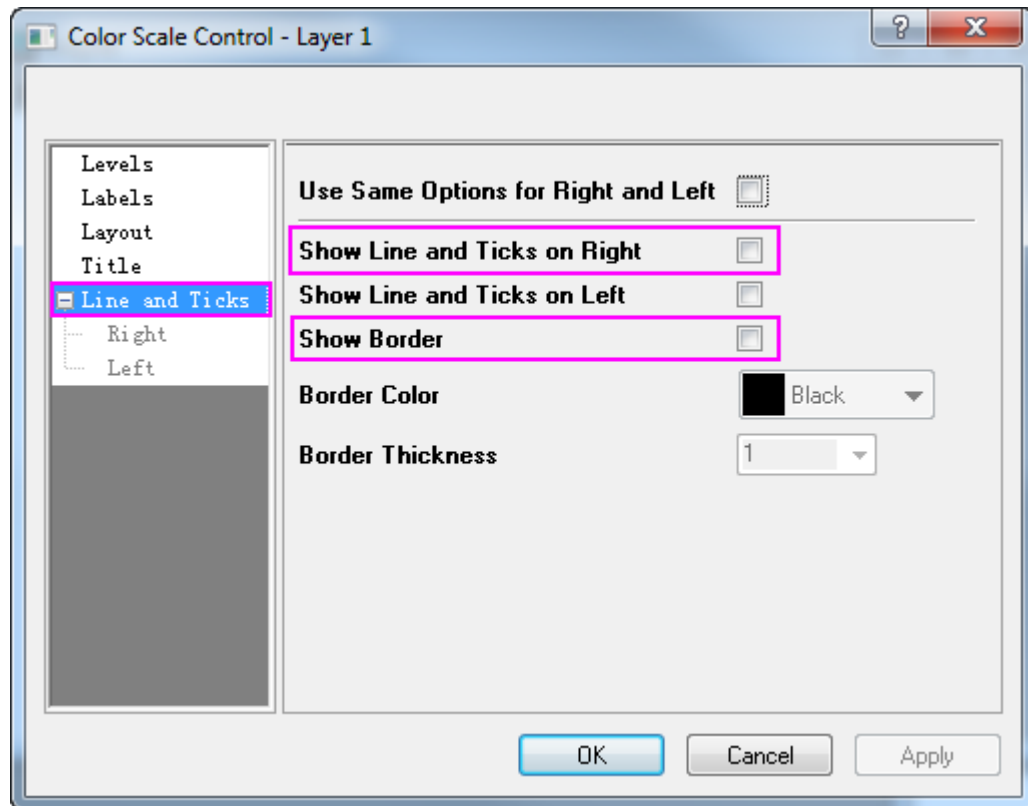

- Click **OK** and position the color scale in the desired location on the right side of the graph by selecting and dragging it.

The contour plot should now appear as shown below:

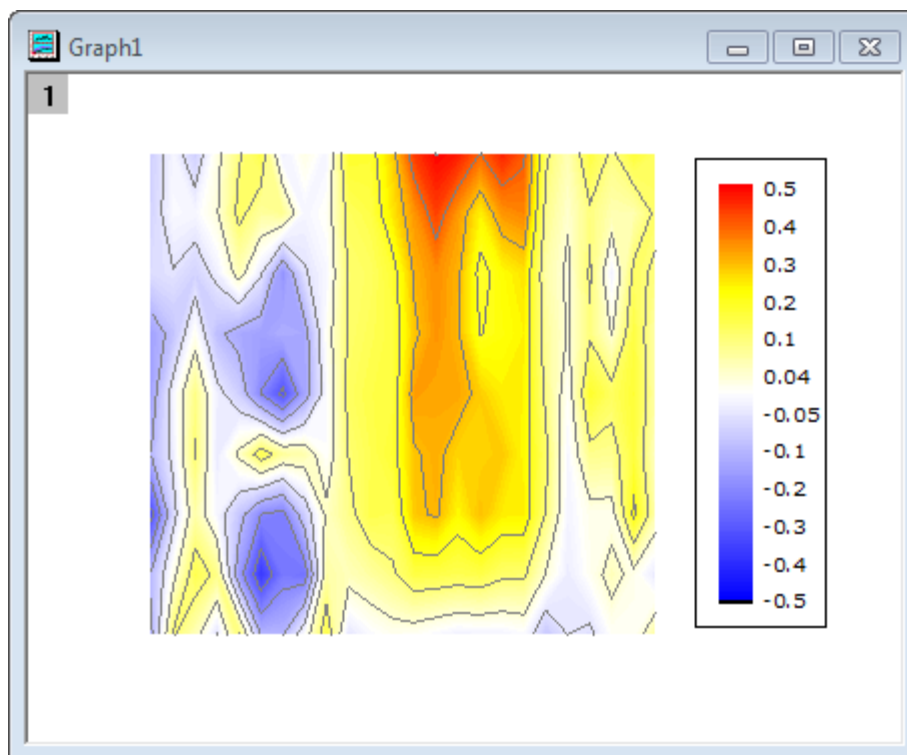

#### 6.10.7.3.2 Create the XYAM Vector Graph

1. Activate the **WOR81147** worksheet, highlight the last three columns and select **Plot > Specialized : Vector XYAM** in the menu.
2. Double-click on any vector to bring up the **Plot Details** dialog on the **Vector** tab. Use the settings shown below:

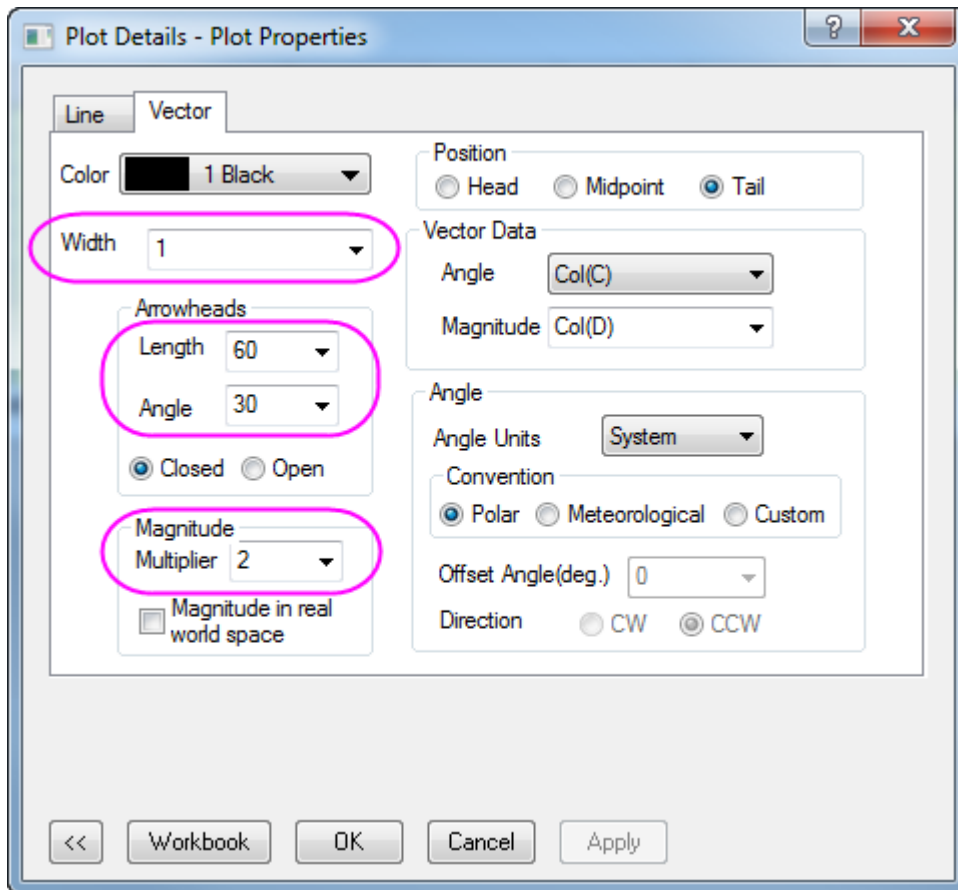

Then click **OK**.

3. To update the axis scales, select **Format: Axes: X Axis...** to open the dialog and complete the following:

- On the **Scale** tab, set X **From = 1, To = 10** and **Value of Increment = 2**.

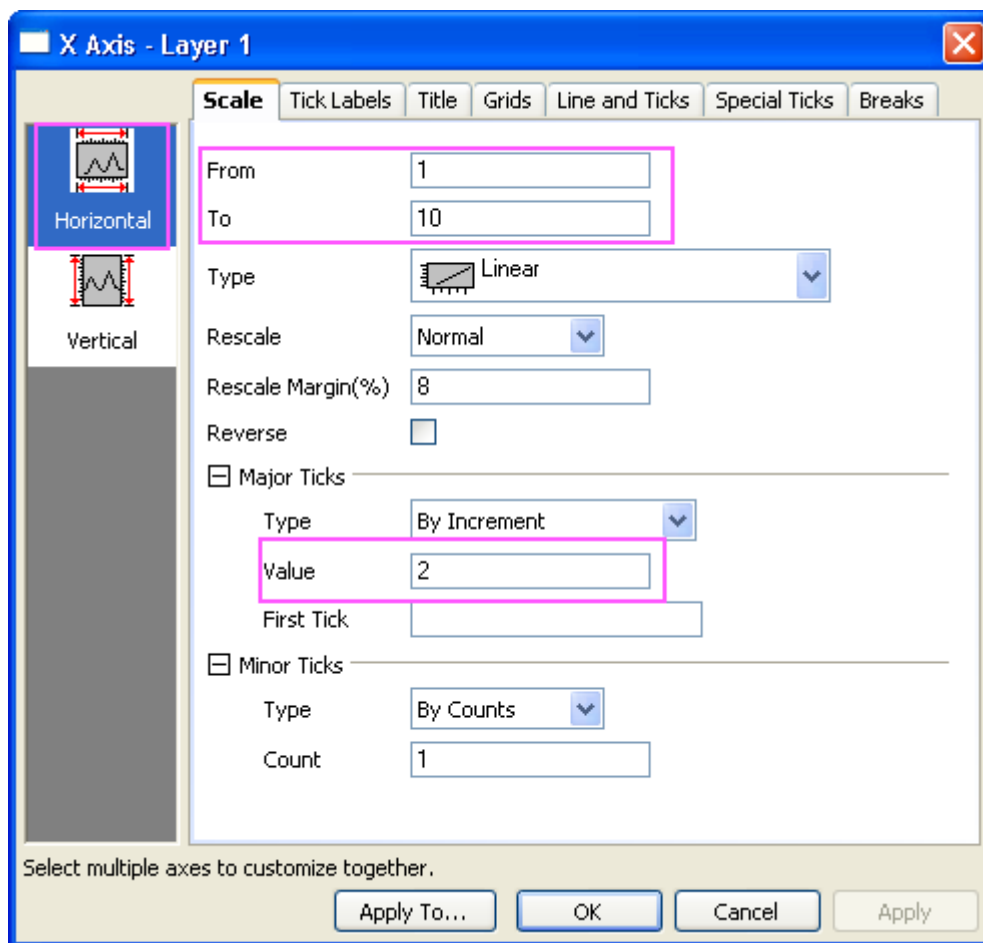

- On the **Scale** tab, choose **Vertical** icon in the left panel of **Axis** dialog. Set the scale of Y as **From = 5, To = 95**, and **Value of Increment = 10**.
- Go to the **Line and Ticks** tab in the **Axis** dialog. Press **Ctrl** key to select the **Top** and **Right** icon in the left panel. Then check **Show Line and Ticks** check box, and set the **Style of Major Ticks**

and **Minor Ticks** to **In**. The top X and right Y axis will be shown with line and ticks.

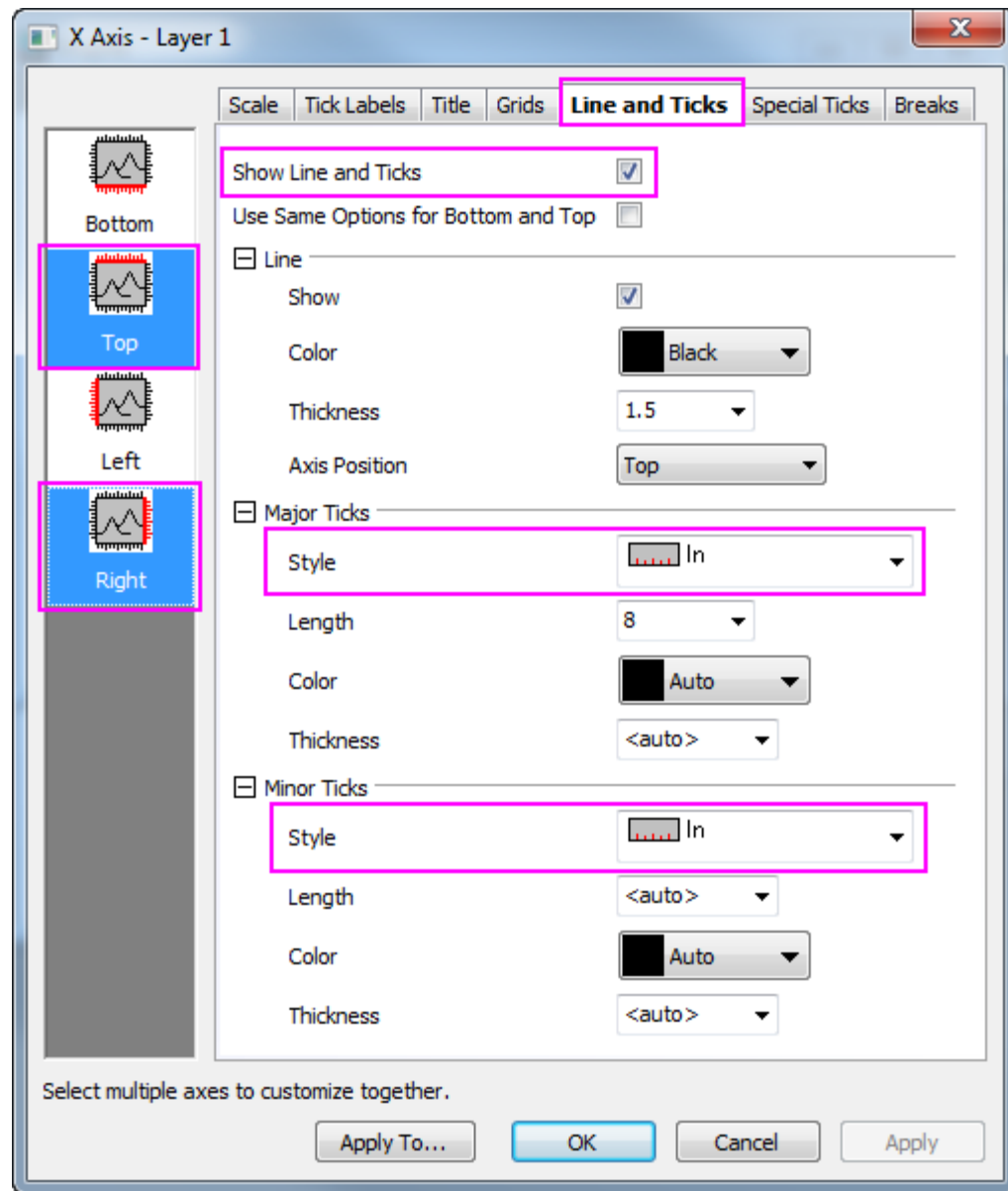

- Click **OK**.
4. At this stage, you may notice that the vectors extend outside the axes (layer frame). To make sure they display within the layer frame, select **Format: Layer** and in the **Display** tab check the **Clip Data to**

**Frame** box. Click **OK**.

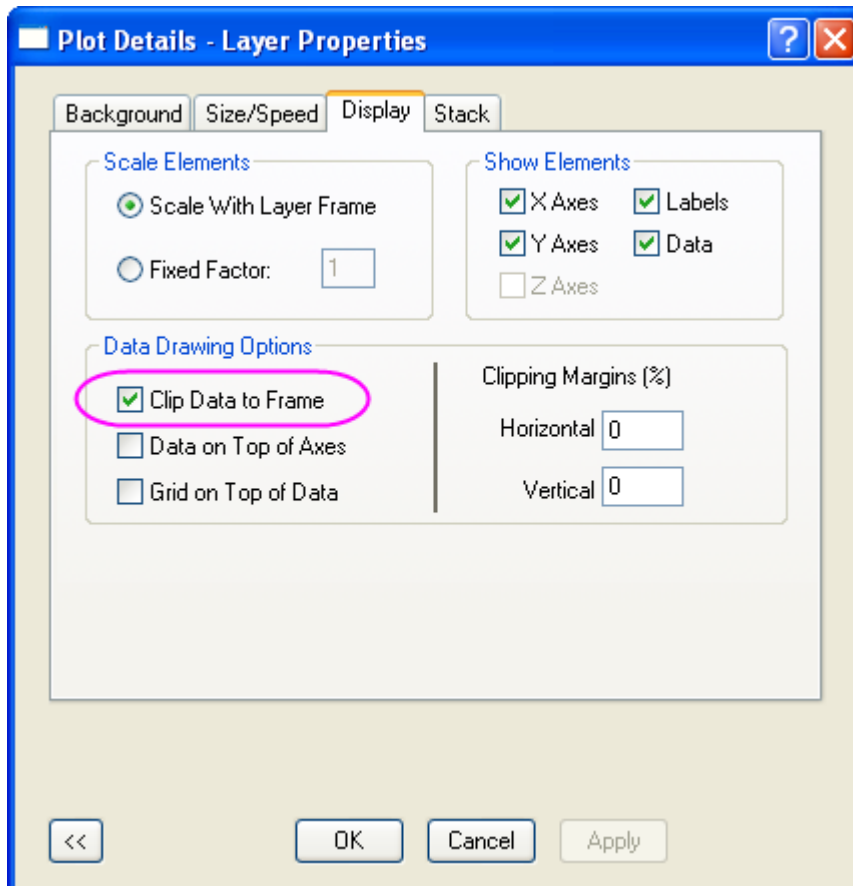

5. Right-click on the legend of the vectors graph, and select **Properties...** in the context menu to open the **Object Properties**. Set the dialog as shown below:



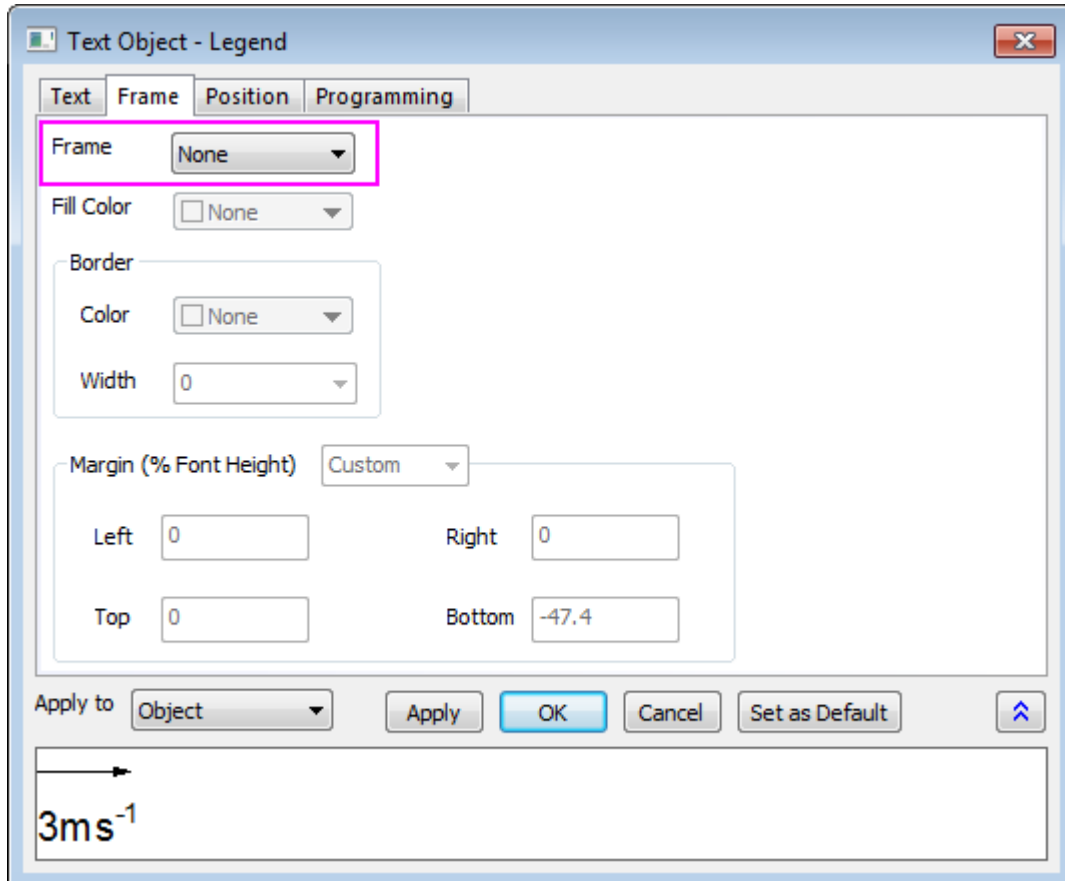
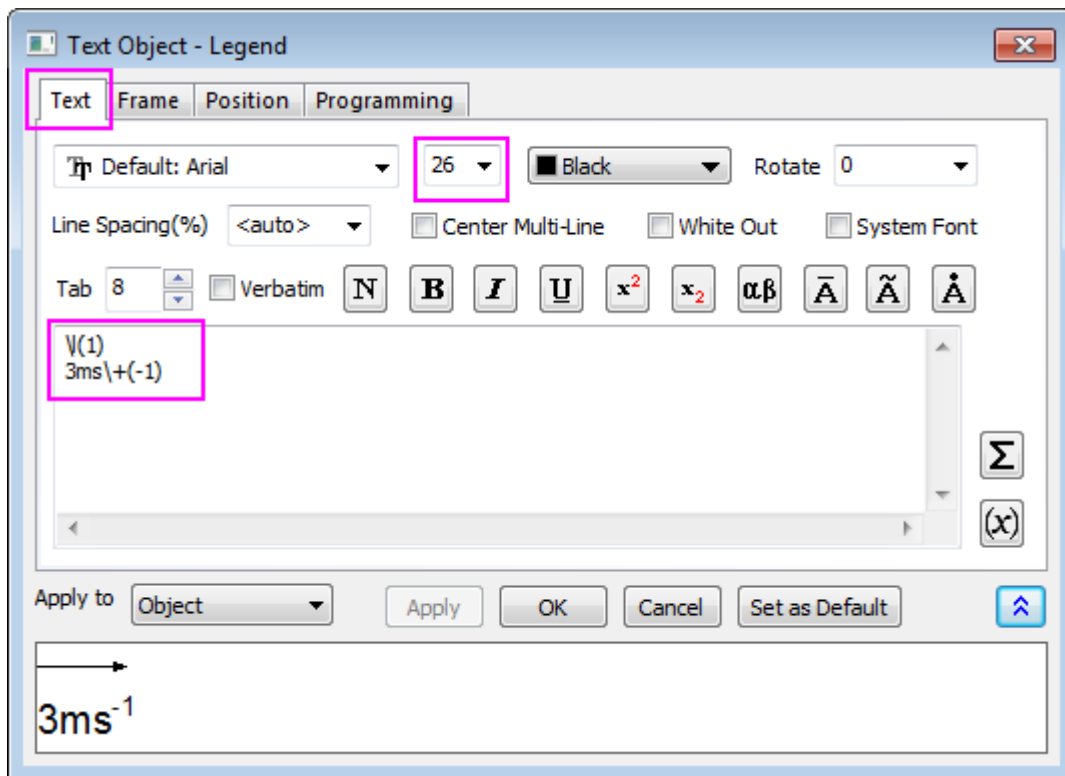



### 6.10.7.3.3 Merge the Two Graphs

The contour and vector graphs are generated by the steps above, and are ready to be merged into one.

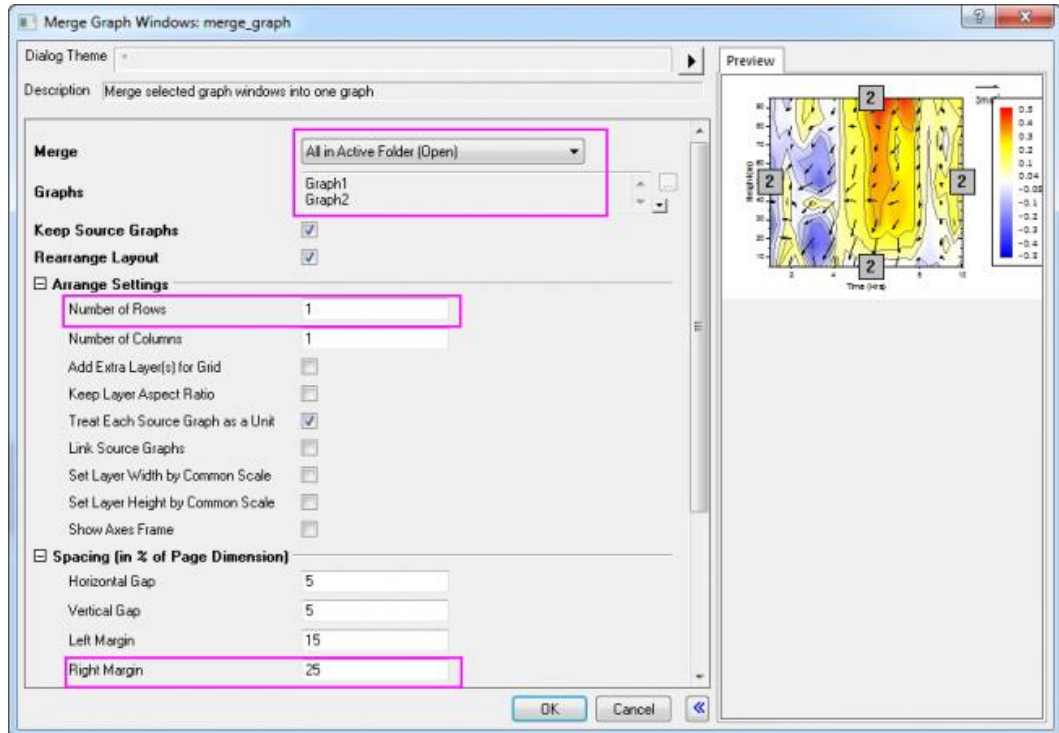
1. **Minimize** or **Hide** all other graphs except for the contour and vector graphs created using the instructions above. With one of the two graphs active, select **Graph: Merge Graph Window...** from the main menu.
2. In the **Merge Graph** dialog, specify the settings as the following:
  - o Expand the **Arrange Settings** node, and set the **Number of Rows** as **1**.
  - o Expand the **Spacing (in % of Page Dimension)** node, and enter a value of approximately "25" in the **Right Margin** text box to show the color scale legend from the contour plot. Click **OK**.



3. To set font type as **Verdana** for all the objects:
  - o Set the objects individually, by clicking on the object and selecting **Verdana** in the **Font** button  Default: Arial in the **Format** toolbar.

Or

- o Use [Theme Organizer](#) to create and apply a font theme to the current graph.

4. The final graph should look something like this:

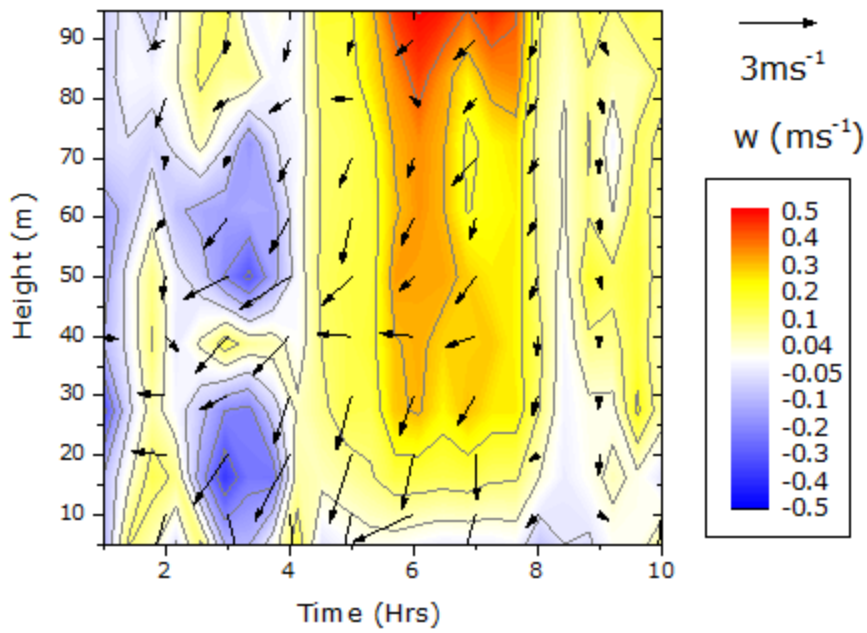

### 6.10.8 Create Heatmap with Virtual Matrix and Colormap Bar Plot

#### 6.10.8.1 Summary

This tutorial create two kinds of graph, a Heatmap Plot based on a virtual matrix together with a Bar Plot with Color Map, and merged them together.

1 2

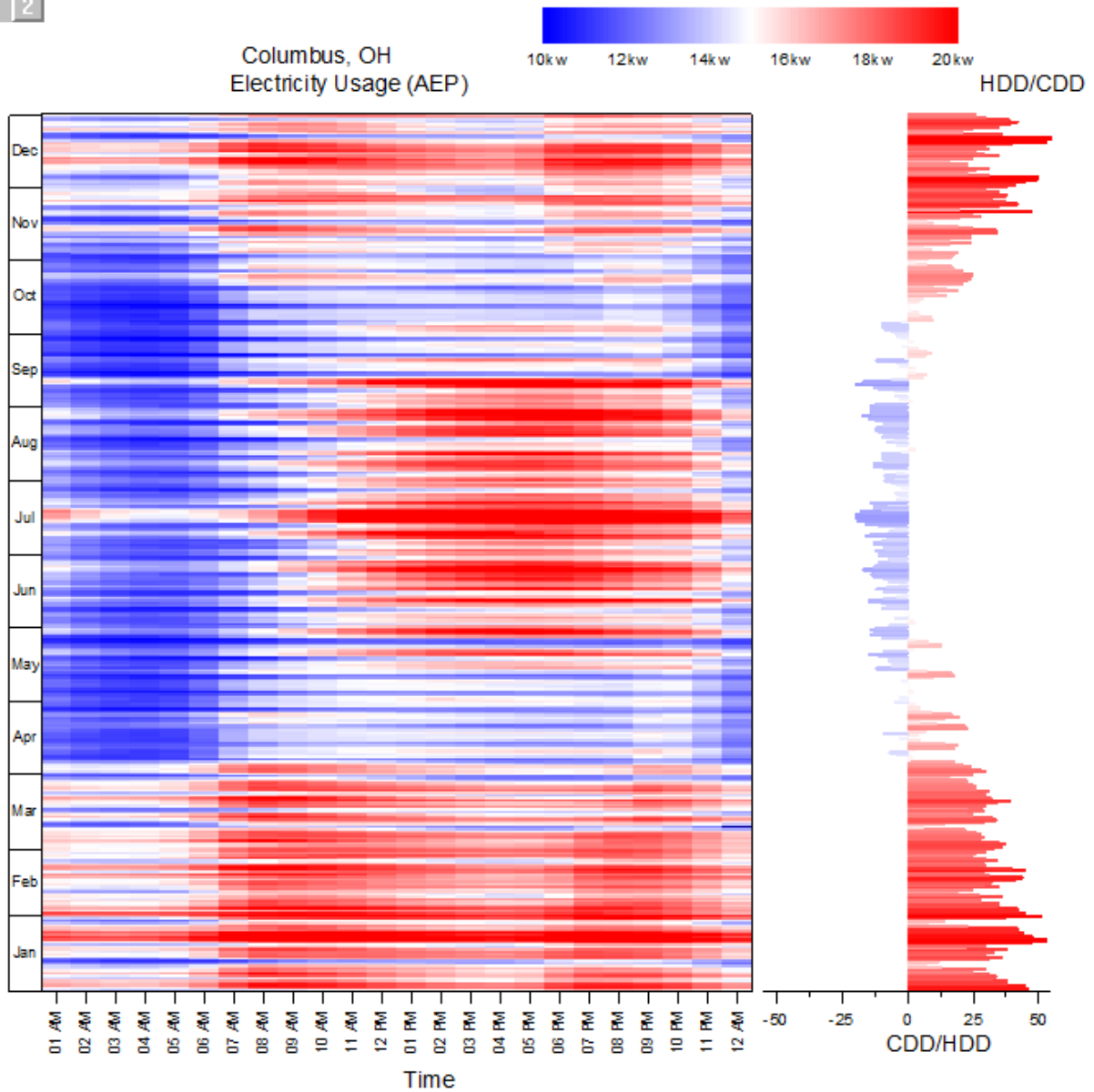

Minimum Origin Version Required: 2015 SR0

### 6.10.8.2 What you will learn

This tutorial will show you how to:

- Create Heatmap Plot based on an Virtual Matrix.
- Create Bar Plot with Colormap.
- Merge the Heatmap Plot and Bar Plot together.

### 6.10.8.3 Steps

### 6.10.8.3.1 Create Heatmap Plot from Virtual Matrix

This tutorial is associated with <Origin EXE Folder>\Samples\Tutorial Data.opj.

1. Open the **Tutorial Data.opj** and browse to the folder **Heatmap and Virtual Matrix Manager**. Open workbook *Electricity Usage* with first sheet active.
2. The XYZ mapping of workbook is shown in graph below, this will help you to understand how the Heatmap plot is created in next steps:

	Z1(Y)	A(X)	B(Y)	C(Y)	D(Y)	E(Y)	F(Y)
Long Name		X →	1:00	2:00	3:00	4:00	5:00
Units							
Comments							
F(x)=		↓ Y			Z		
1	Jan	1/1/2013	14327	14190	13785	13730	13820
2	Jan	1/2/2013	14919	14732	14721	14817	15098
3	Jan	1/3/2013	16864	16547	16361	16285	16649
4	Jan	1/4/2013	16547	16209	16083	16117	16513
5	Jan	1/5/2013	16298	16000	15870	15943	16107
6	Jan	1/6/2013	14175	13902	13747	13706	13828
7	Jan	1/7/2013	14805	14645	14549	14702	15082
8	Jan	1/8/2013	16355	16130	16160	16240	16614
9	Jan	1/9/2013	15391	15102	14967	14852	15143
10	Jan	1/10/2013	14337	14103	14100	14220	14555
11	Jan	1/11/2013	14175	13882	13595	13637	13815
12	Jan	1/12/2013	12831	12409	12272	12128	12250
13	Jan	1/13/2013	11632	11303	11073	11012	11008
14	Jan	1/14/2013	12501	12391	12352	12464	12951
15	Jan	1/15/2013	15090	14799	14724	14777	15008
16	Jan	1/16/2013	15450	15180	15053	14898	15145
17	Jan	1/17/2013	15088	14521	14448	14388	14710

3. Highlight all cells in Z region. In order to quickly select all, select the Cell in Column(B)-Row 1 and use the worksheet scroll bars to show the cell in last column and last row, hold **Shift** key and click this cell to select all. click **Plot > Contour: Heatmap** in main menu to open the plotvm dialog for Heatmap plot.

4. Specified the X, Y ranges as shown in graph below.

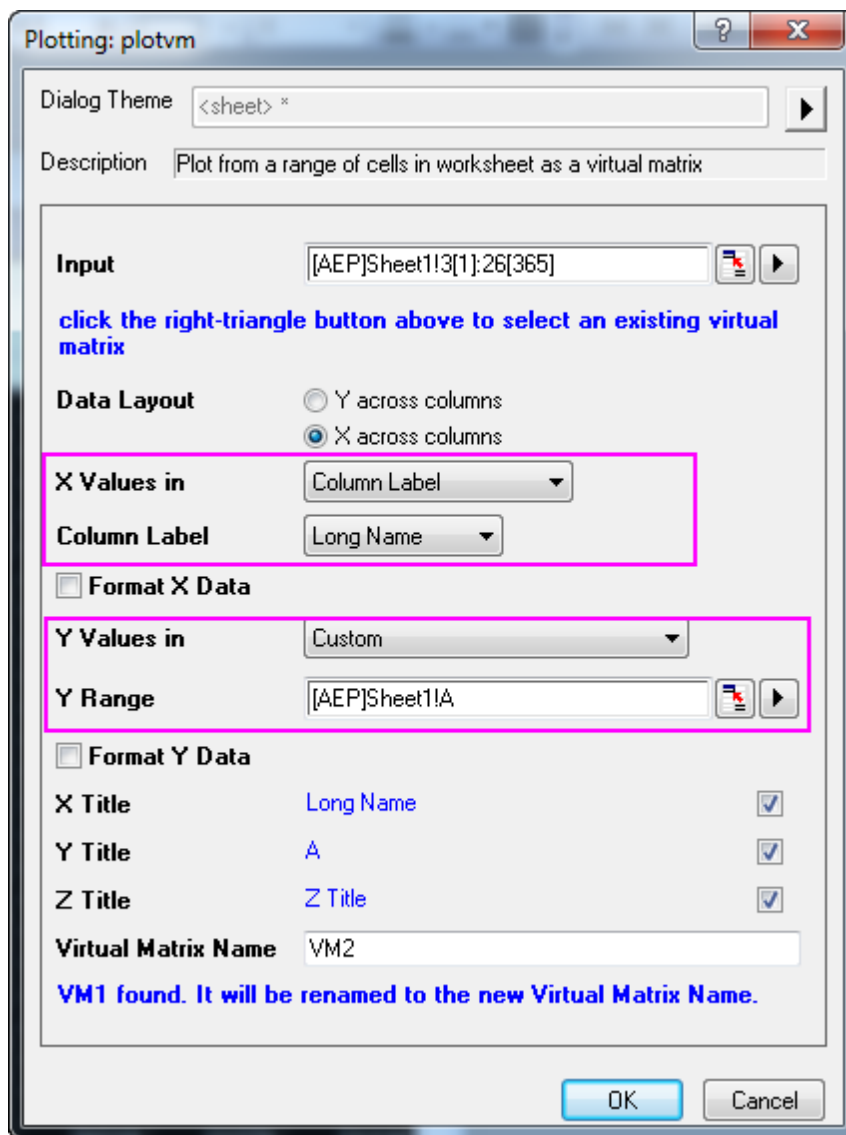

5. In this dialog, check **Format X Data** and **Format Y Data** check boxes, click the button  respectively to format X and Y data following the graph below:

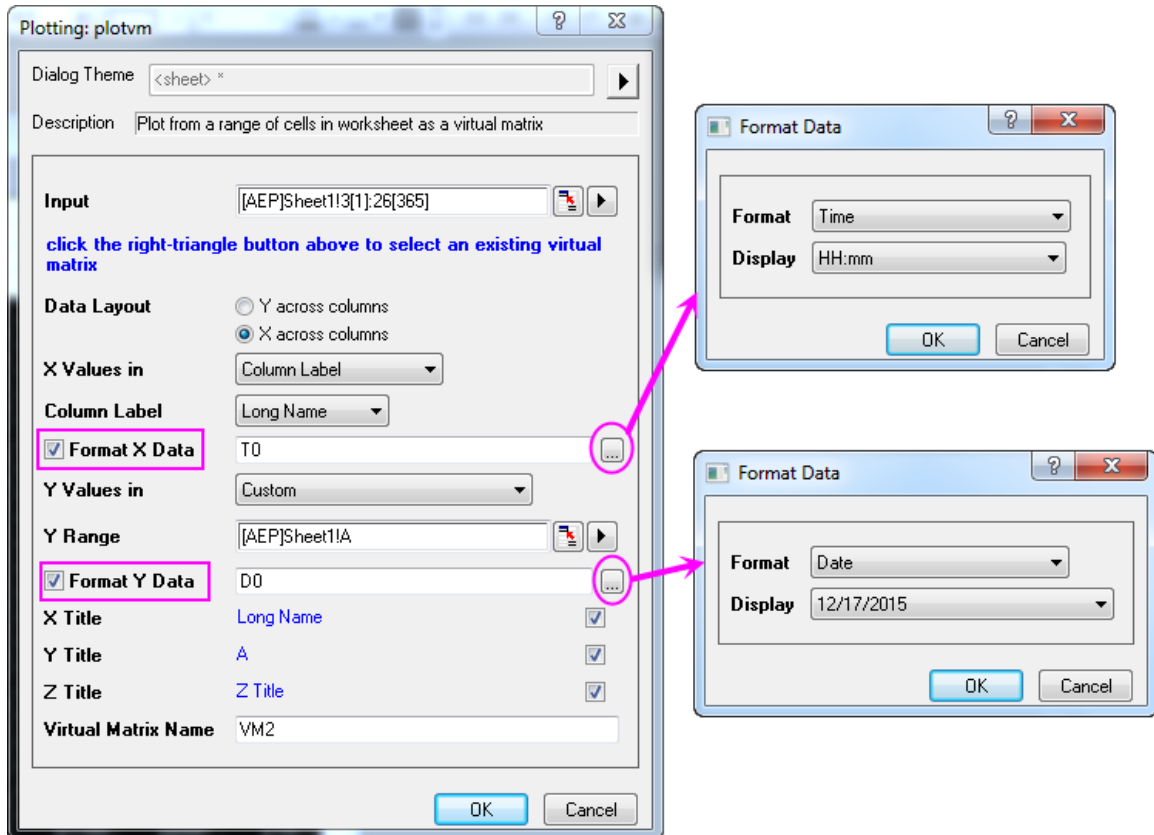

6. The tick labels in Y axis are too dense to be seen, so now we are going to change that. Double click the axis in the graph to open the **Axis** dialog:
- o Select **Left** icon in **Tick Labels** tab, go to **Display** tab, select **Date** as the **Type**, and set **Display** drop-down list to **Dec(Current Month)**, click **Apply** to save the setting.

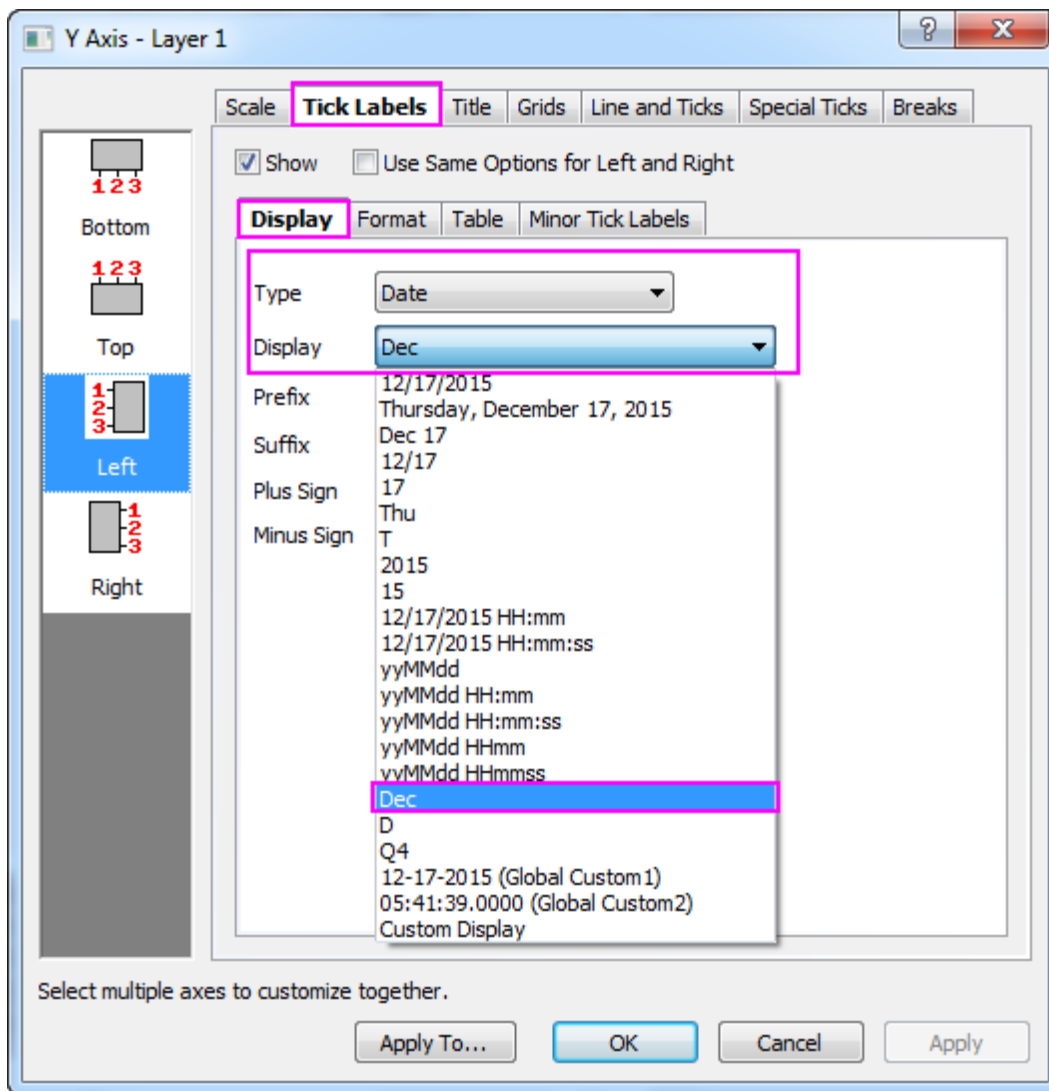

- Go to the **Table** tab, check on **Enable** box, click **Apply** to save. You will find that the month names are shown as tick labels for Y axis in the form of a table.



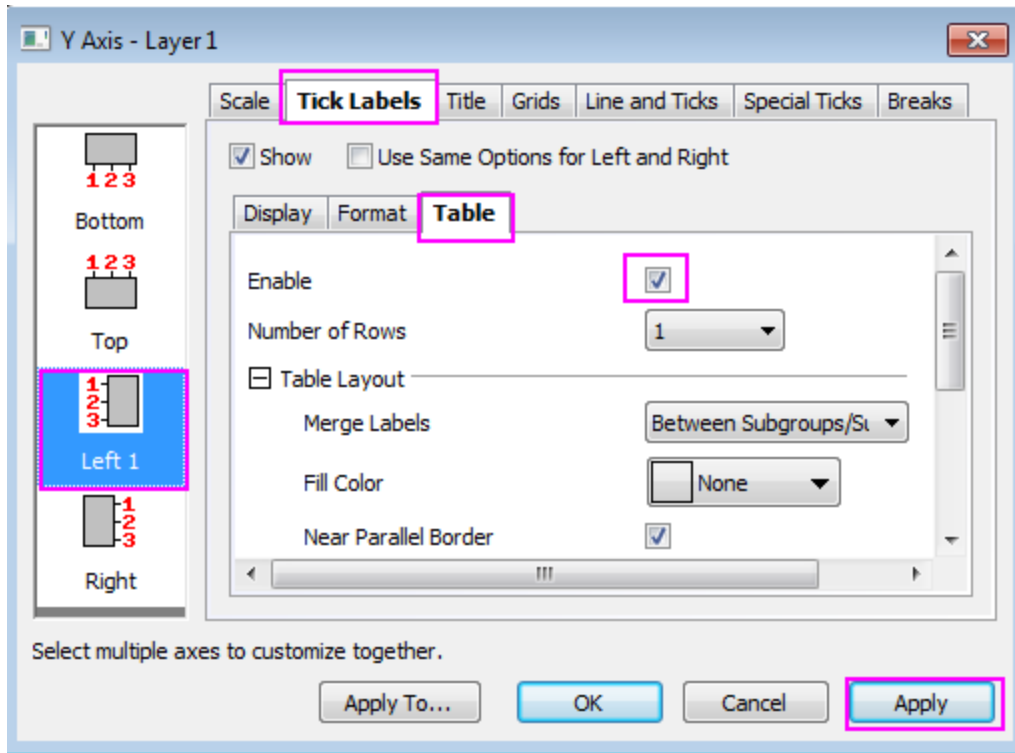

7. Next, we will specify the scale and tick labels for X axis:
  - Go to **Bottom** icon in **Tick Labels** tab, and make sure **Time** is selected as the Type in **Display** tab, change the **Display** to *hh pm*, click **Apply** to save the setting.

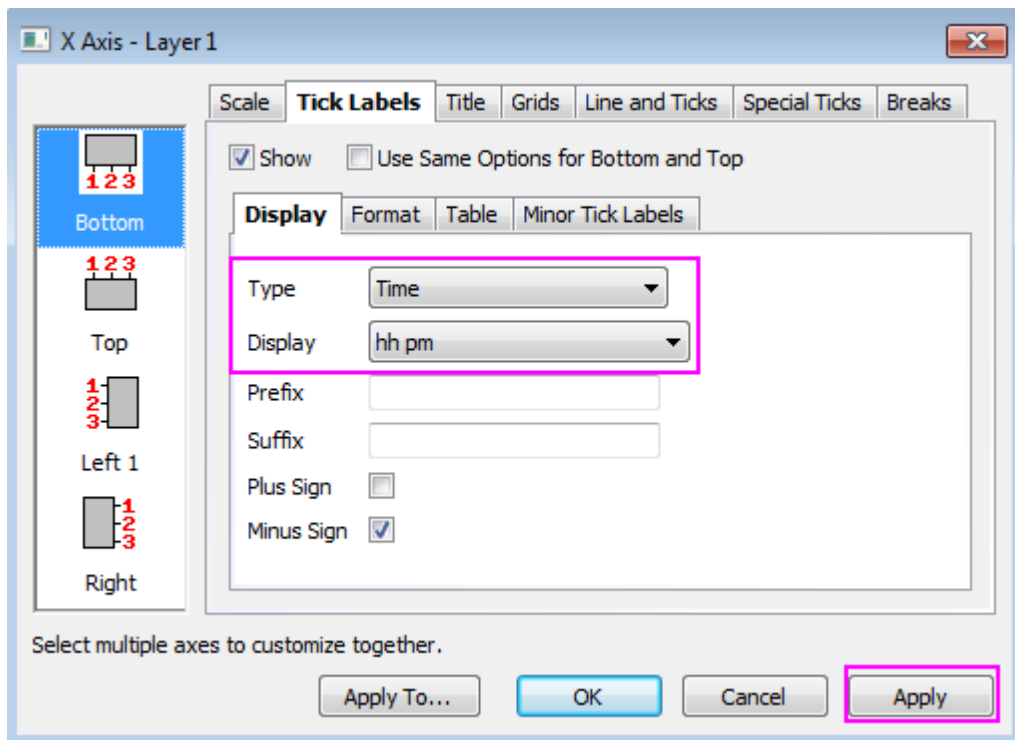

- o Go to **Horizontal** icon in **Scale** tab, make sure the settings resemble the screenshot below, click **Apply** to save the setting. Click **OK** to close the dialog. Remove the title for X axis.

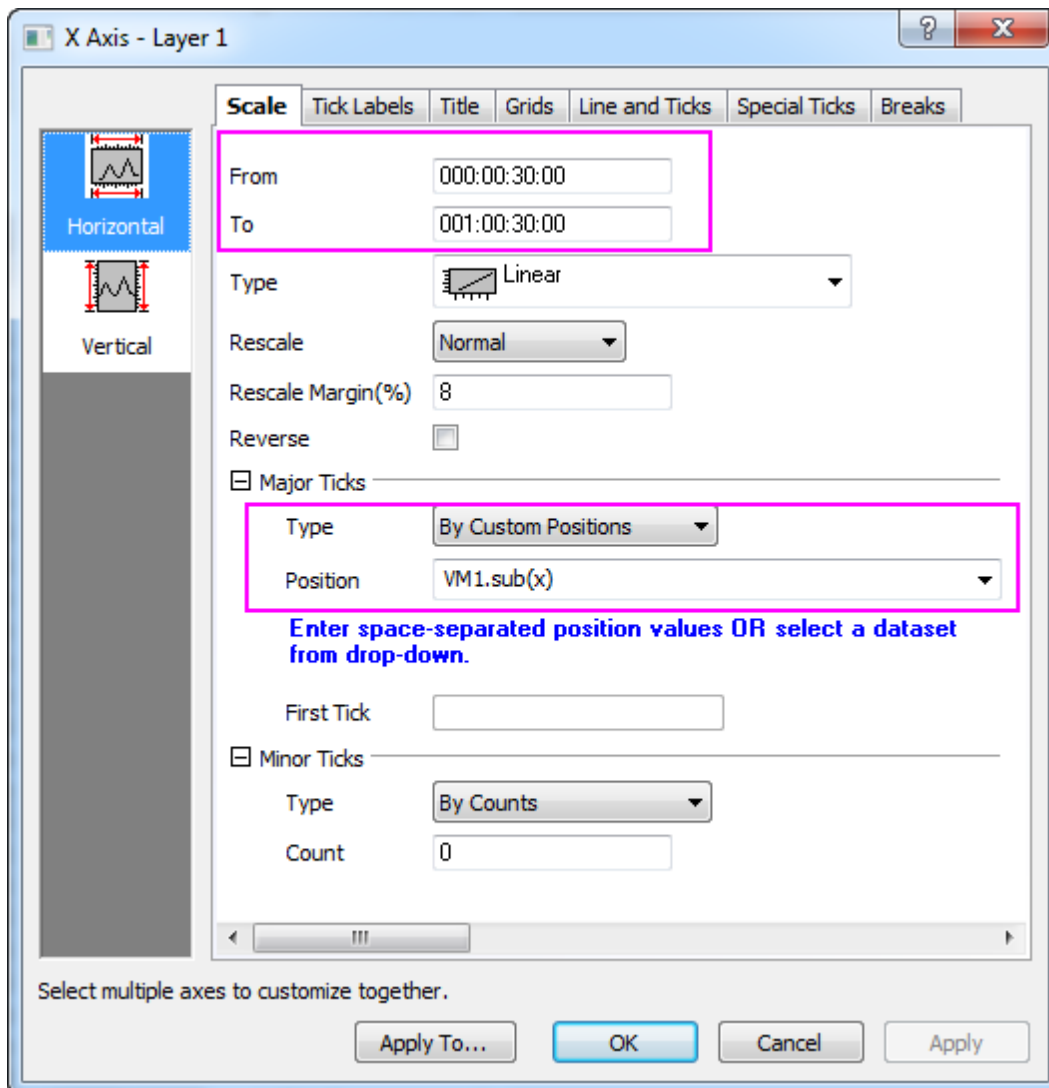

8. Click the tick labels for both XY axes in the graph, change the font size to 10 via **Format** Toolbar.
9. Select **Format: Plot** in main menu with Heatmap graph active.
  - o Set the Level for Colormap follows the graph below:

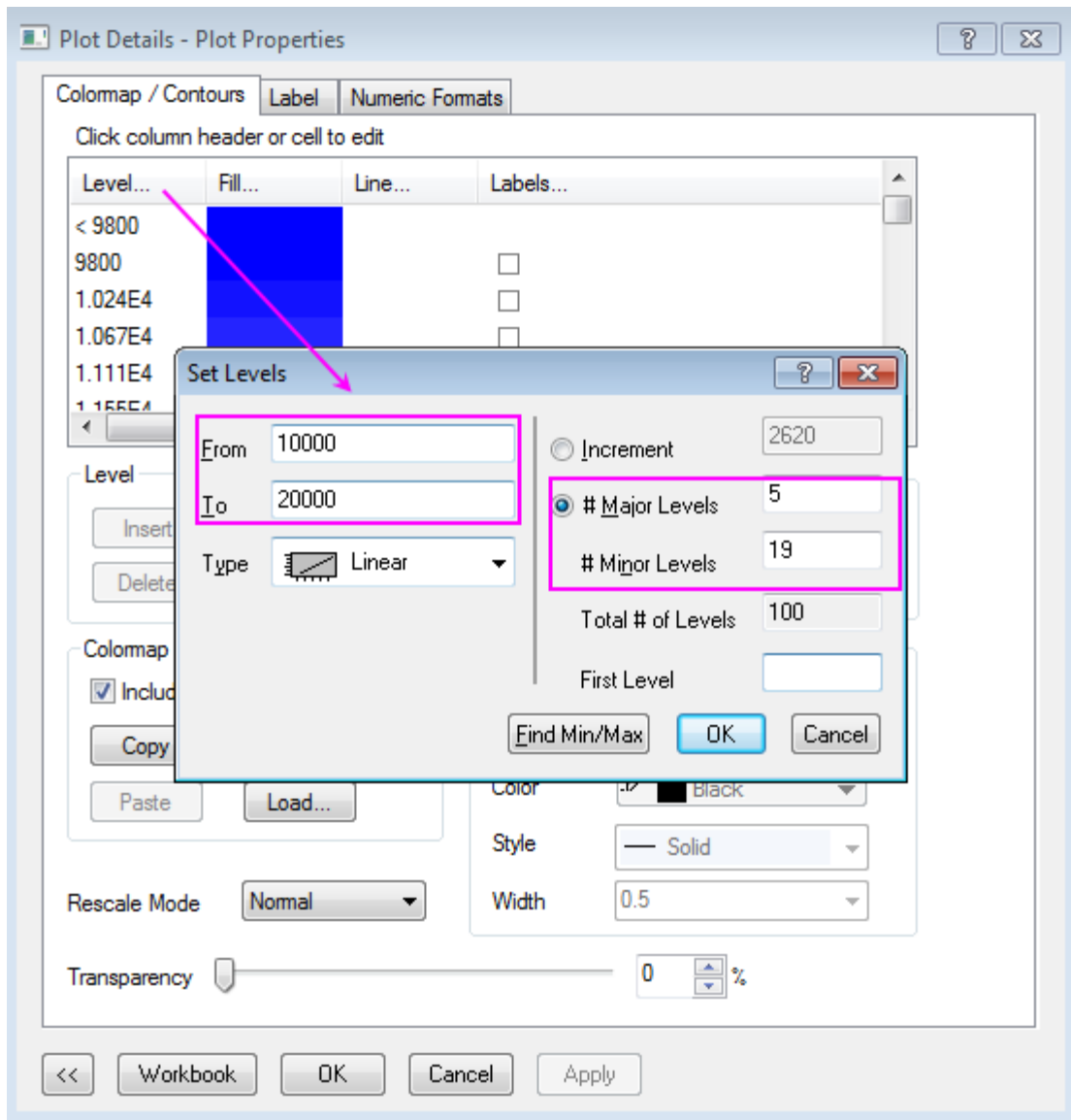

Click **OK** to close the Set Levels dialog

- Click the Fill color of the Colormap on head cell(blue area) to set Fills follows the graph below:

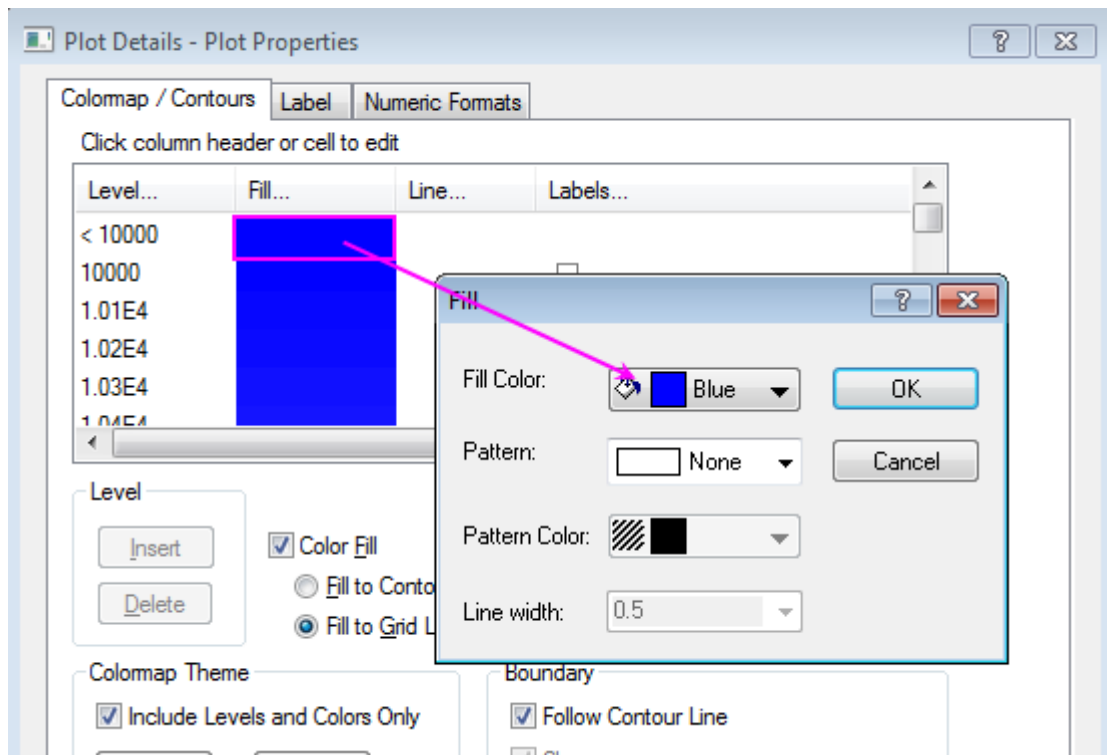

- Scroll down to the Colormap tail, set its fill color to red in the same way.
- Click **Save** in **Colormap/Contours** tab to save the pattern as heatmap.oth which will be used in the second parts of the graph.

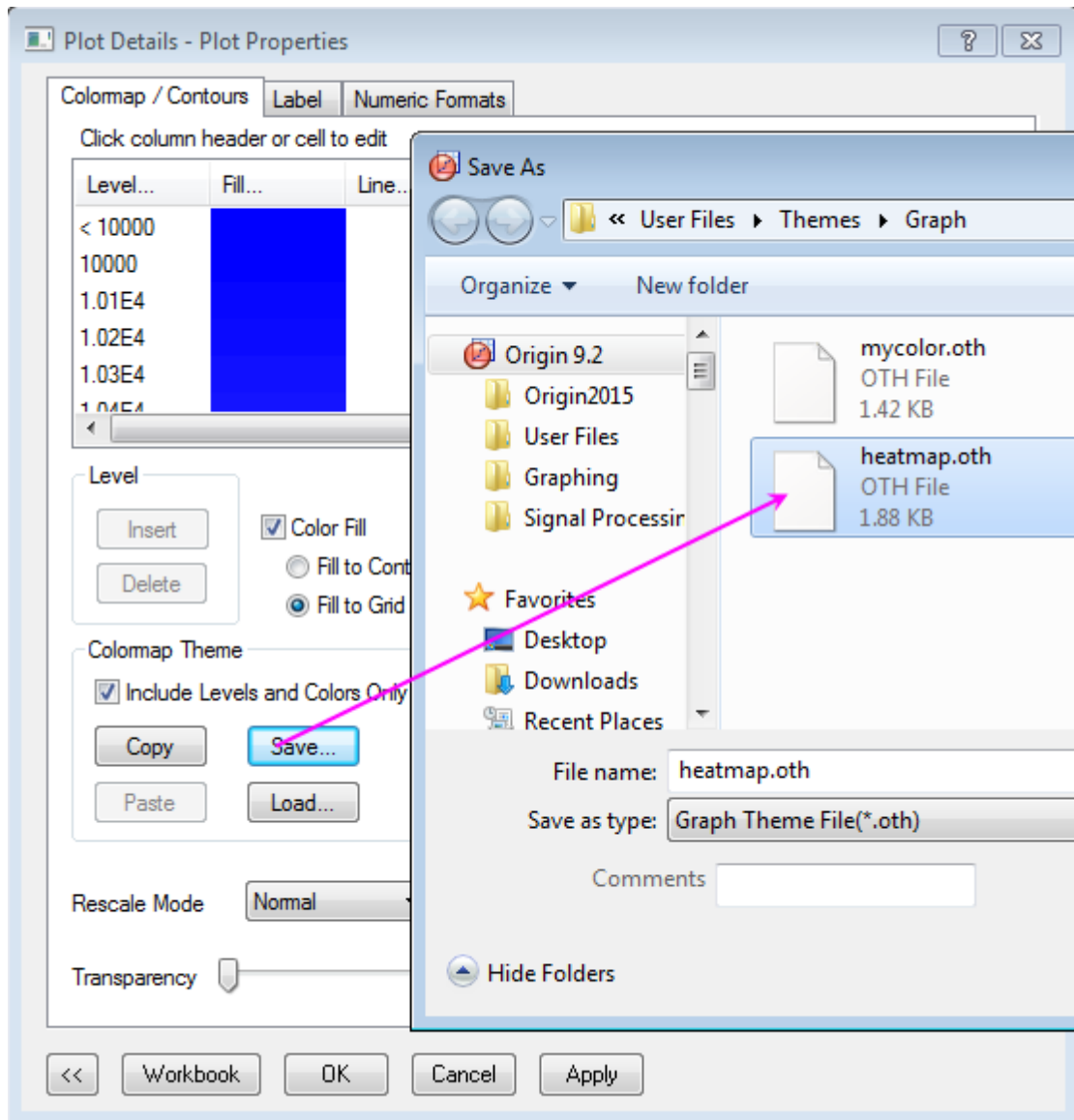

- In the **Plot Details** dialog, click the first tree node in left panel (should be **Graph1** by default), change page size to 11\*11 inch in **Print/Dimensions** tab, click **Apply**, then in the left panel, select the sub tree node for **Layer1**, go to the **Size/Speed** tab, change the Layer area follows graph below, click **OK** to apply the settings and exit the dialog:

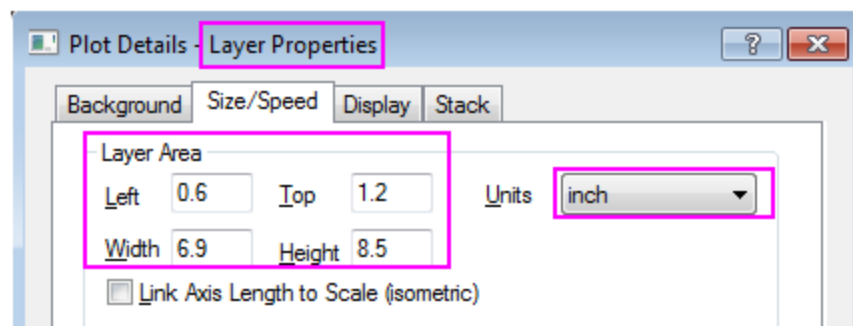
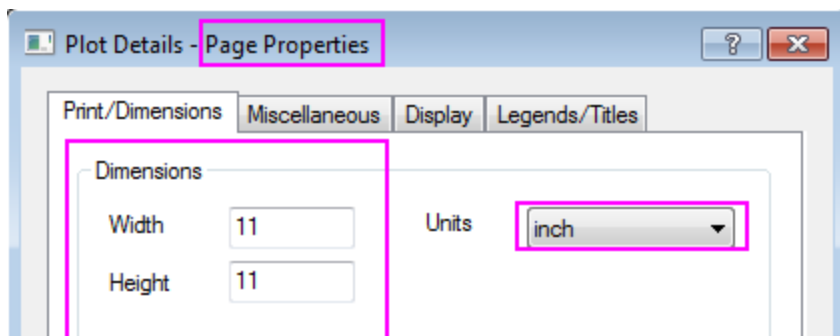

11. We will turn off the speed mode by click the  in Graph Toolbox to view the graph with higher resolution. The finished graph for Heatmap should be similar to the graph below:

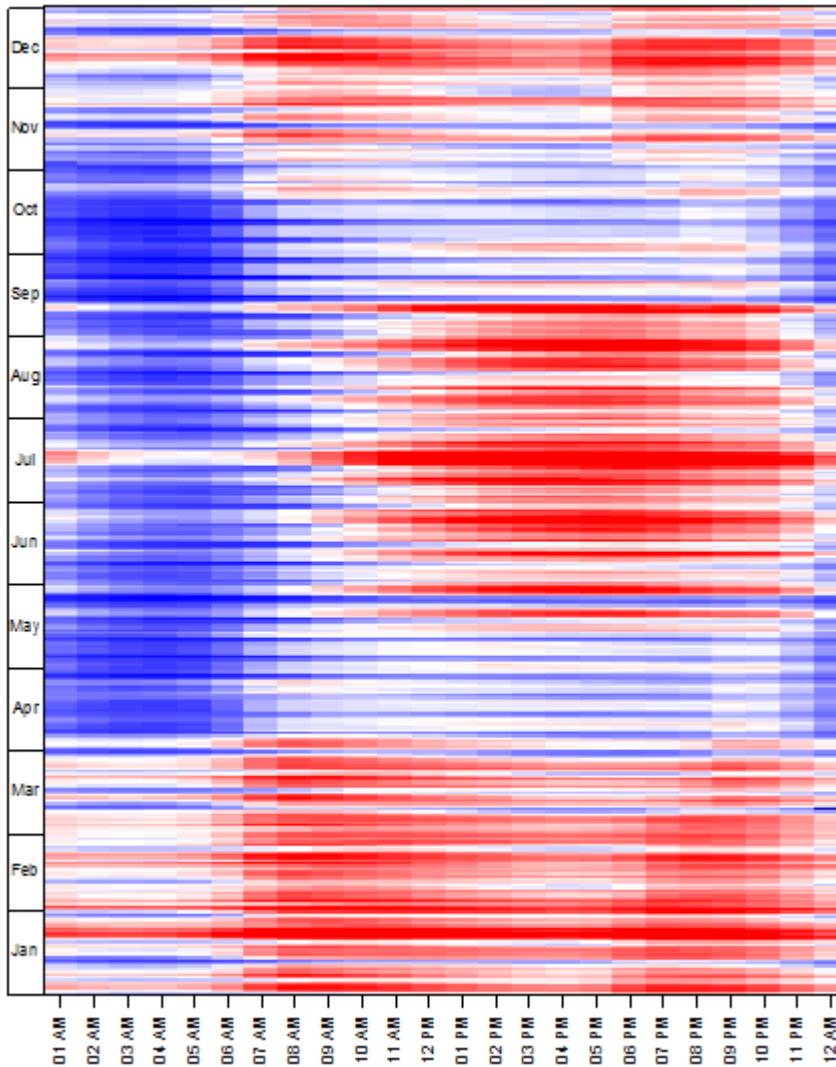

Once the Virtual Matrix were created, they will be saved internally. You can browse them in Virtual Matrix Manager. The saved Virtual Matrix can be used for Contour/Heatmap/3D surface plot directly, you can select the virtual matrix from the input box of the plot dialog as shown in graph below:

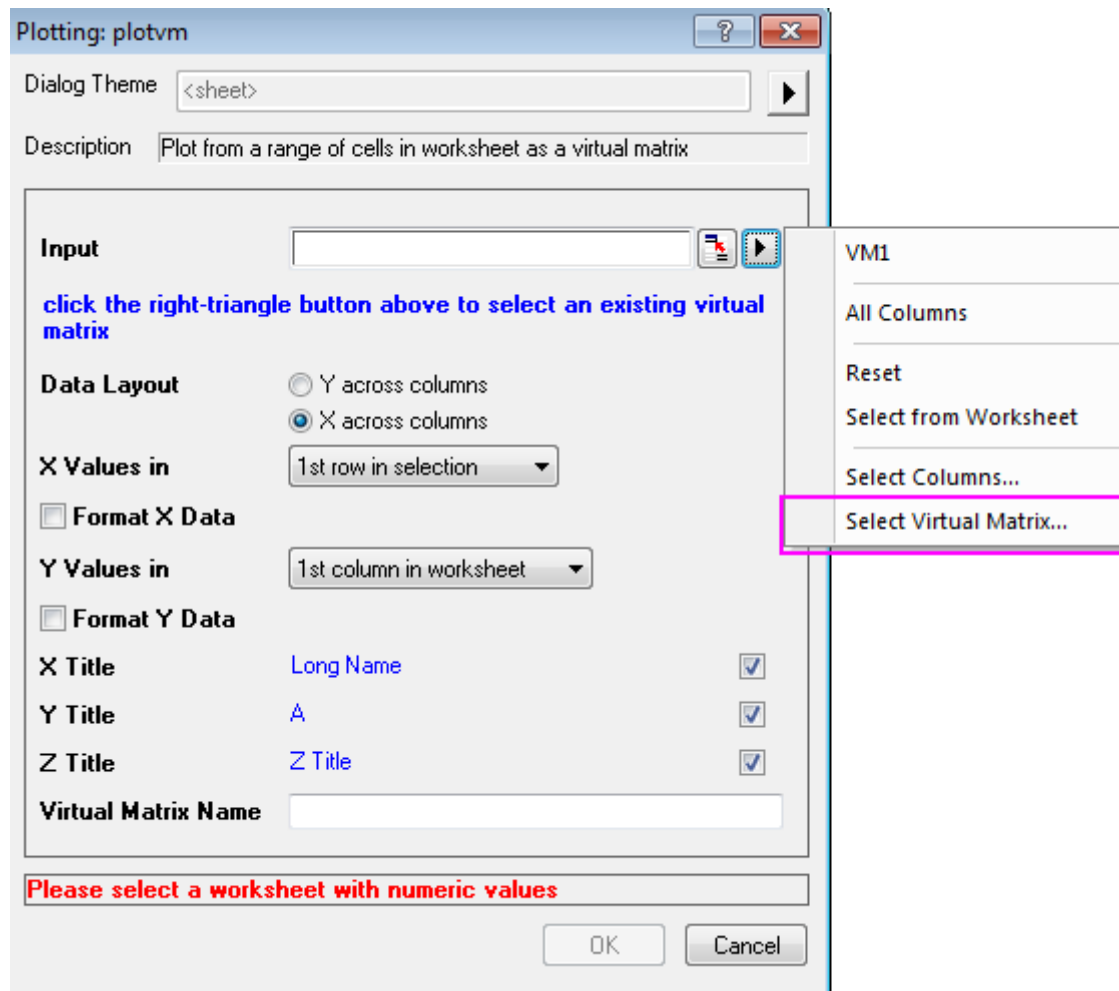

#### 6.10.8.3.2 Create the Bar Plot with Colormap

1. Go to the Temp sheet in Electricity Usage workbook, highlight the worksheet and select **Plot > Basic 2D : Bar** in main menu to create a Bar plot.
2. Now, we will defined the style of axis:
  - Double click the axis to open the **Axis** dialog, change the **Scale** of axis (X) follows the graphs below in Vertical page of the **Scale** tab.



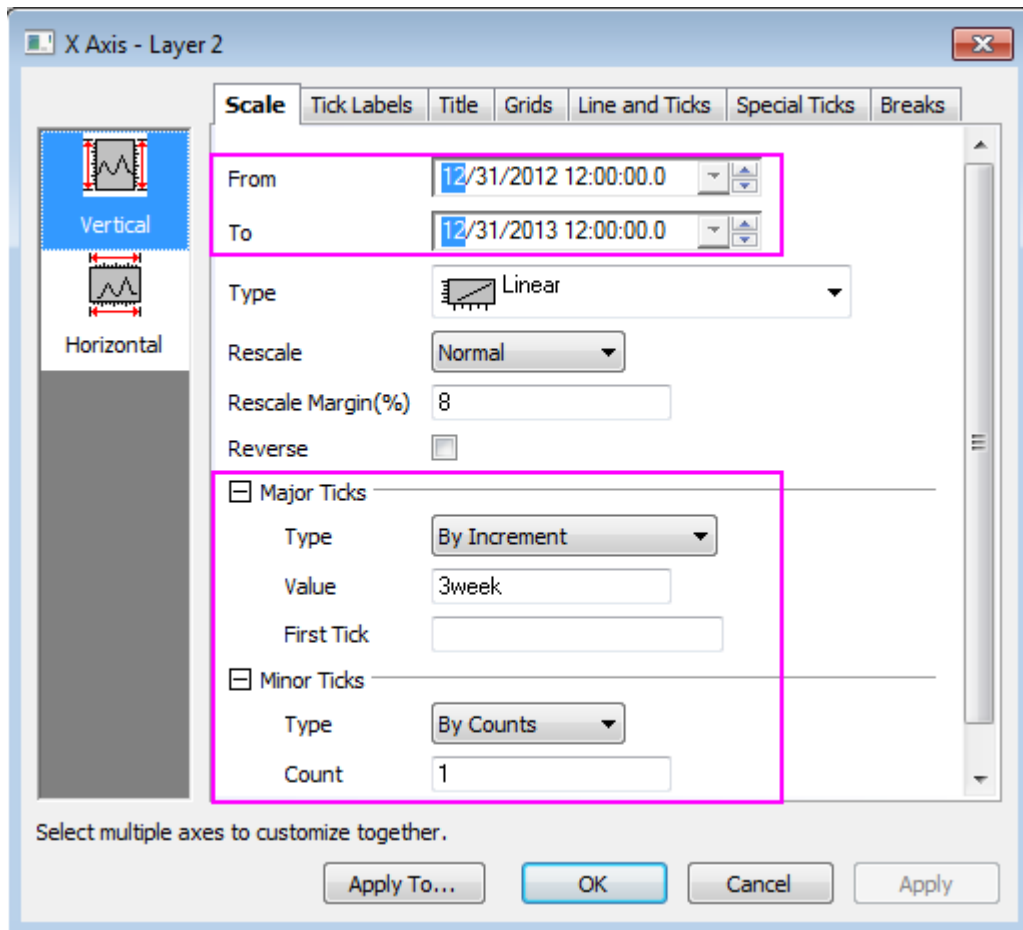

- Then, change the Scale for axis(Y) in Horizontal page from -55 to 55 with *Major Ticks* value 25 and *Minor Ticks* counts 1, then click **Apply**.

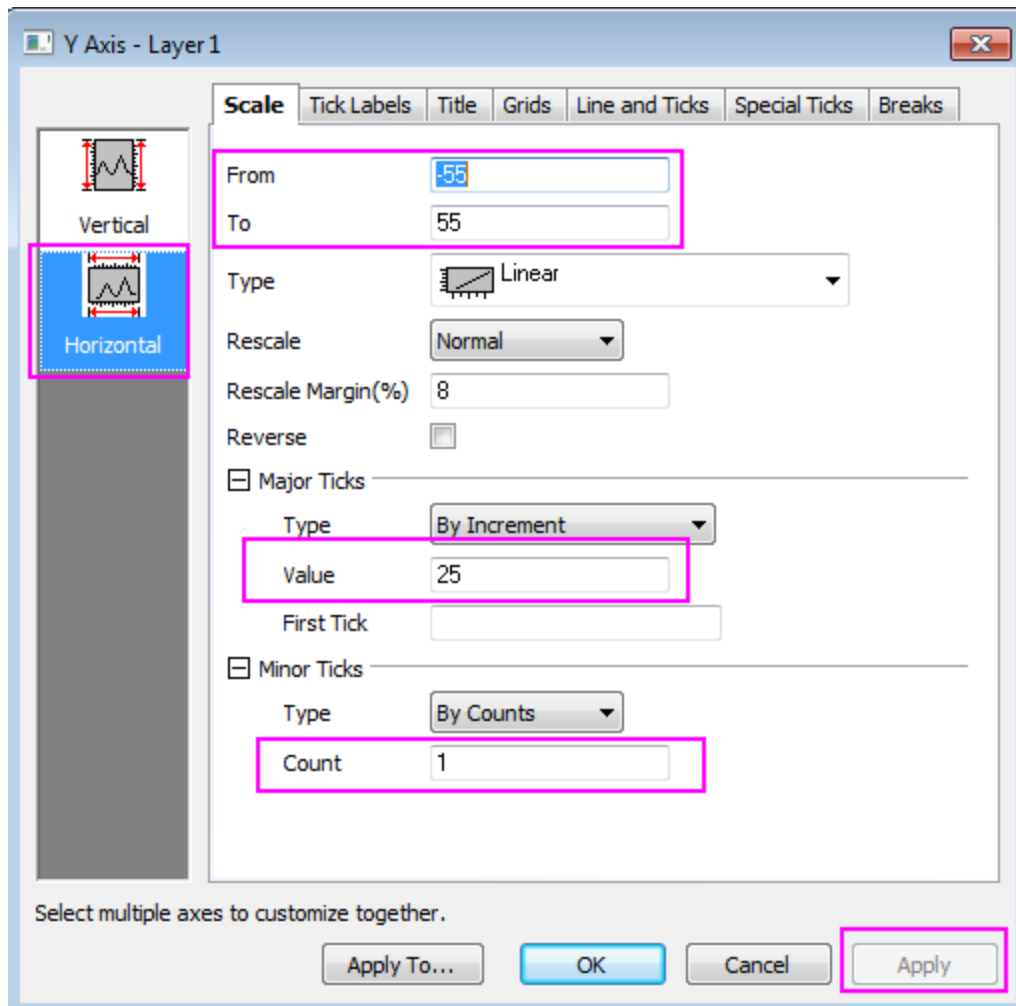

- We will also hide the line and ticks for X axis in **Line and Ticks** tab by uncheck the box of **Show Line and Ticks**. Besides, grids can be hide by using similar ways in **Grids** tab.
  - Click **OK** to close the dialog.
  - Change the Y axis title to *CDD/HDD* by double clicking on the Y title object and entering the in-place edit mode. Delete the ticks labels and axis title of X axis by select it and hit **Delete** key.
3. Next, we will create the Colormap for the graph, the Colormap theme should be identical to the Heatmap created before. Click the **Format: Plot** in main menu to open the **Plot Details** dialog:
- Set the color for both Border and Fill as **Map:Col(B)**.

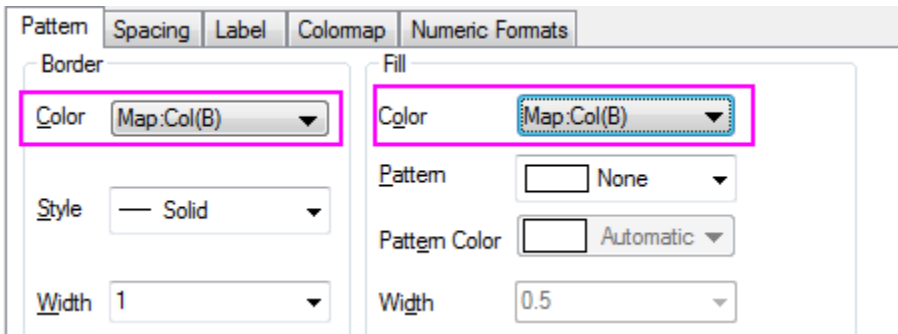

- Go to the **Colormap** tab, load the heatmap.oth as Colormap Theme.

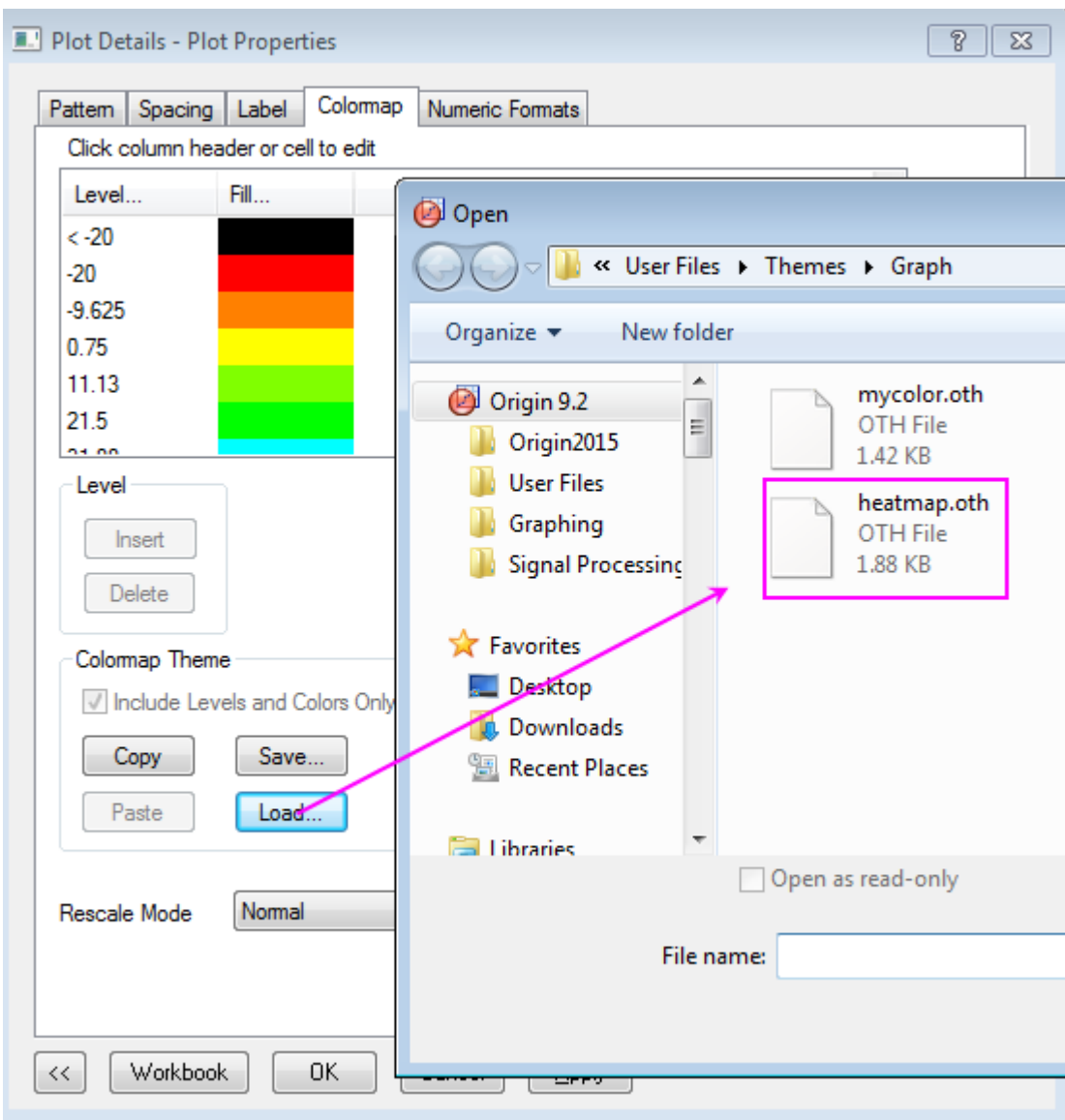

- Click the Level of the Colormap to set Levels follows the graph below:

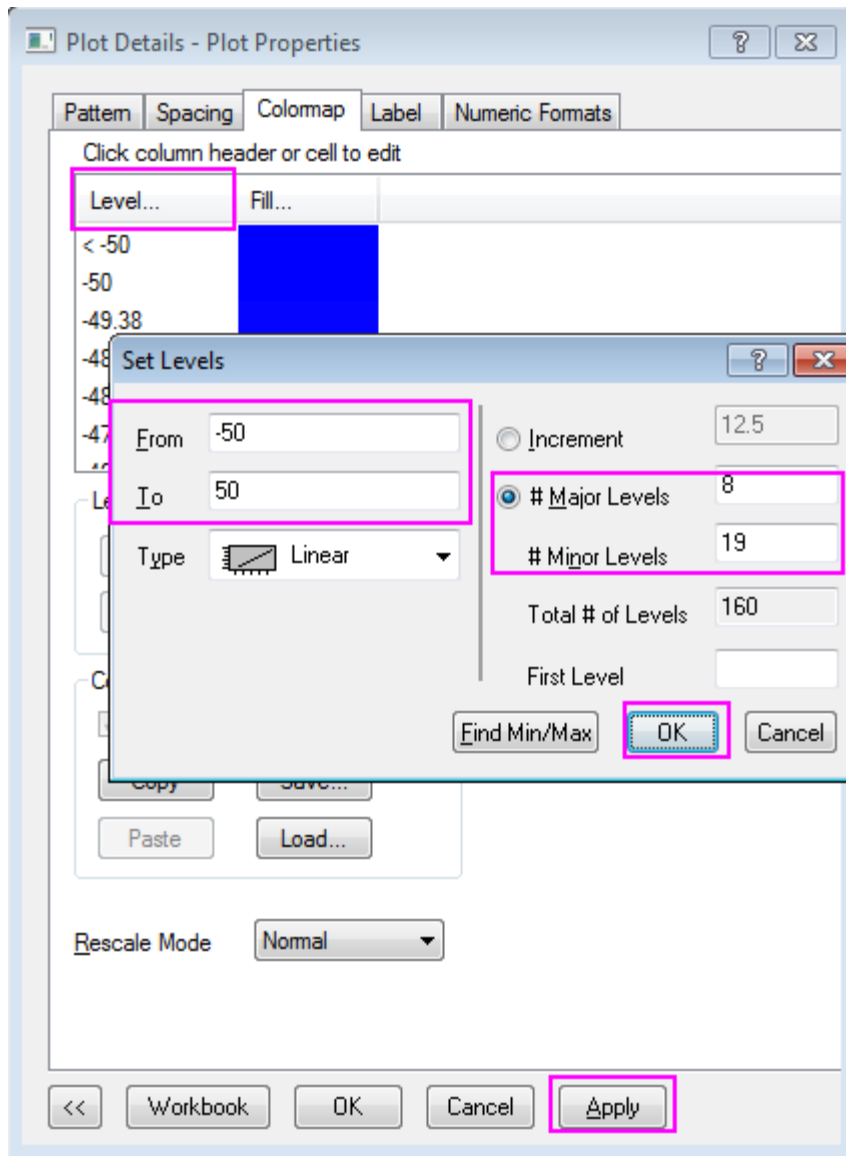

Click **OK** to close the **Set Level** dialog and Click **Apply** in Plot Properties dialog to save the settings.

4. In the left panel, select the first tree node (by default, **Graph2**), change page size to 11\*11 inch in **Print/Dimensions** tab, click **Apply**, then switch to the **Layer1** tree node and go to the **Size/Speed** tab, change the Layer area follows graph below, then,click OK to close dialog:

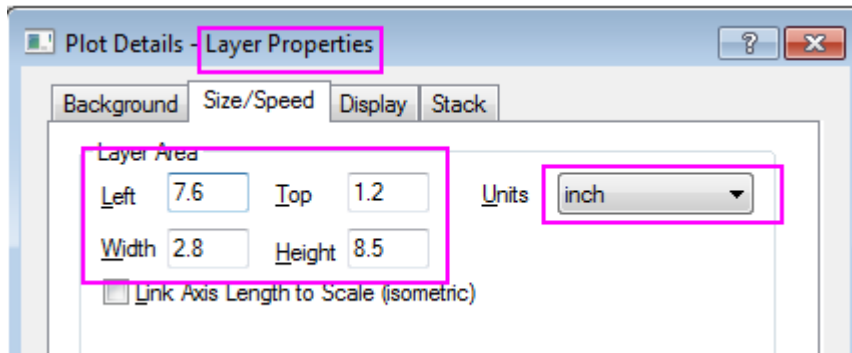
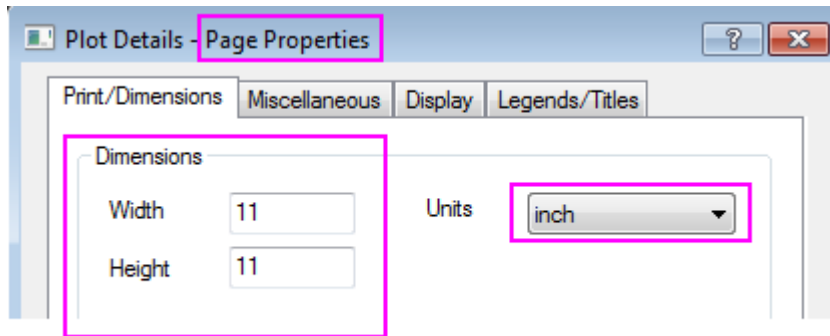

The finished bar plot is similar to the graph below:

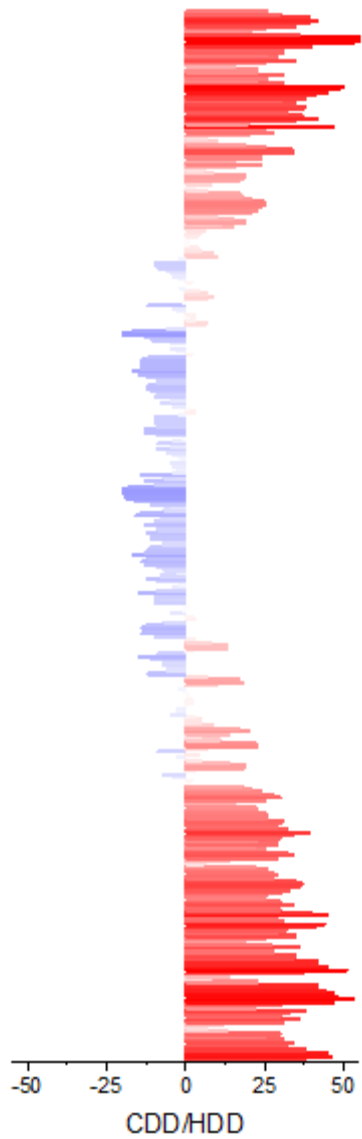

#### 6.10.8.3.3 Merge the Heatmap Plot with Bar Plot and More Customization Steps

1. Select **Graph: Merge Graph Window** in main menu with Heatmap graph active, merge Graph1 and Graph2 together, the **Rearrange Layout** should be unchecked, click **OK** to apply the setting.

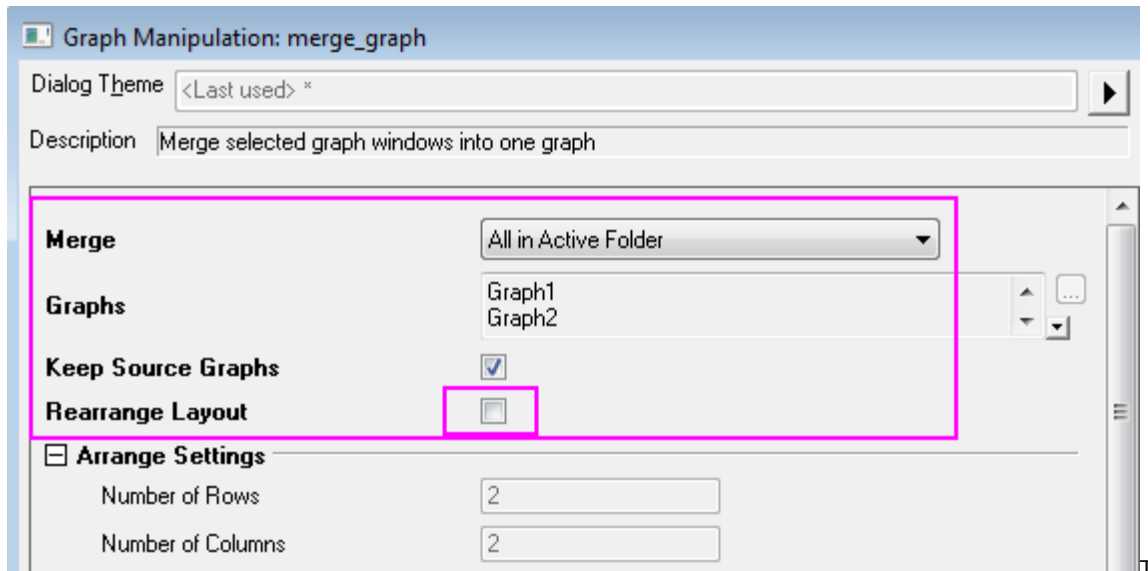

then, you will resize the size of the merged graph (Graph3), click **Format: Page >> Print/Dimensions** tab, change the page size to 11\*11 inch again, click **OK**. Click **CTRL+W** to adjust the graph view.

2. Specify the style of the color scale:
  - Double click the color scale to open the Color Scale Control dialog, set the Levels page as shown in graph below:

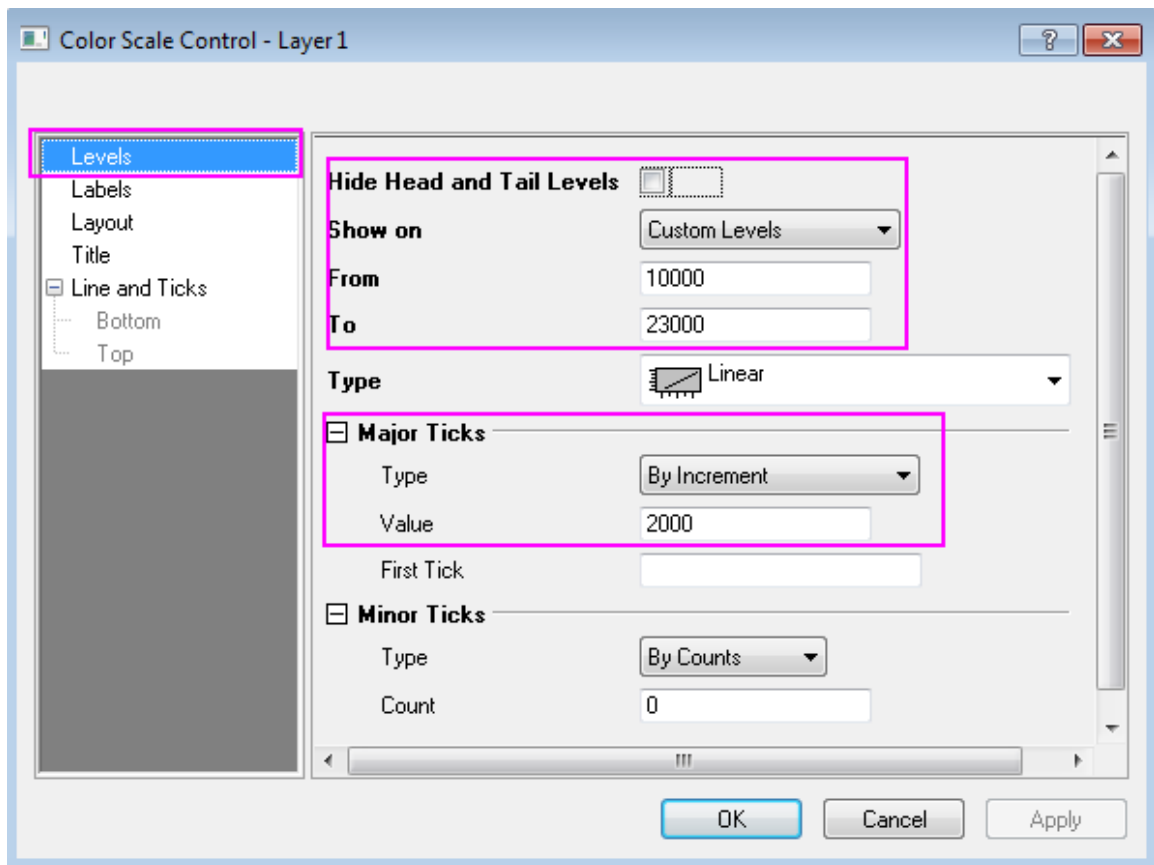

- Set the Labels page as shown in graph below:

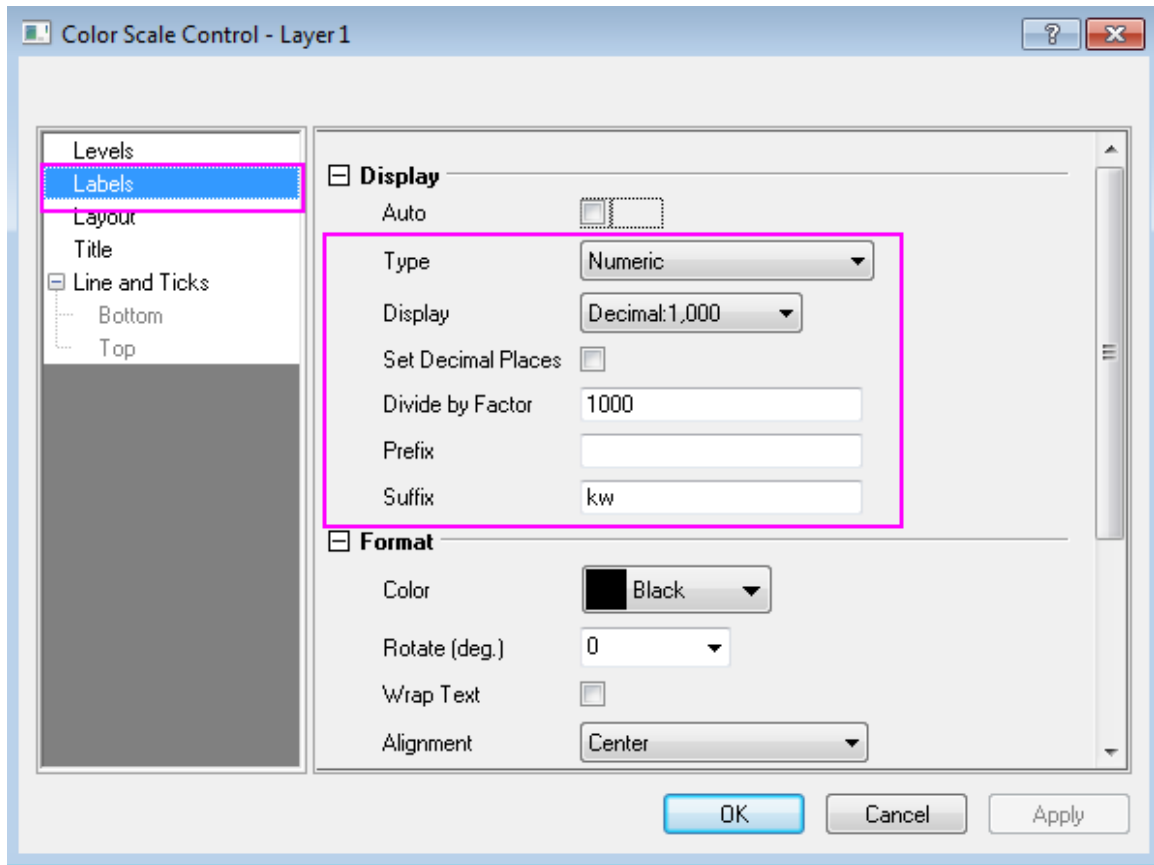

- Set the Layout page as shown in graph below:



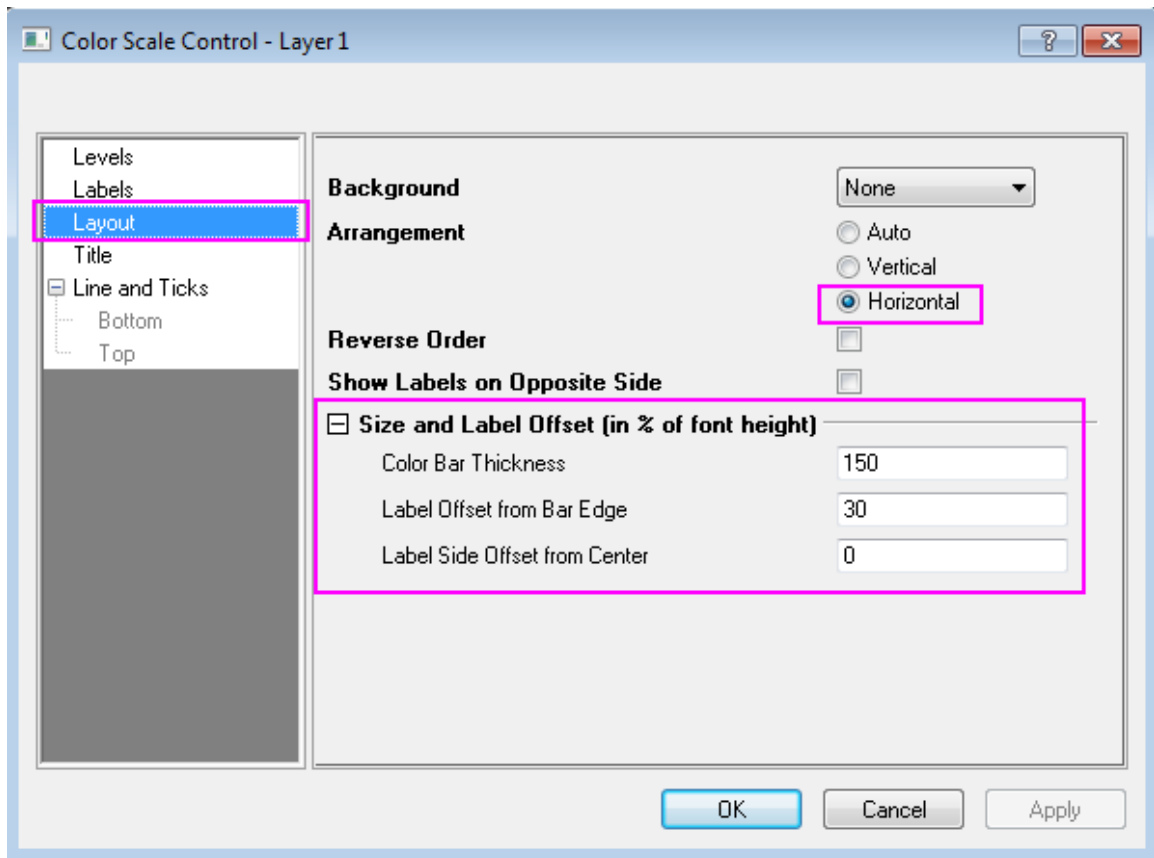

Click **OK** to apply the settings, drag the outline of the color scale in the graph to reach a proper size and location.

3. Select the unwanted axis title or legend and delete them, add text object with graph information by using text tool.

The finished graph is similar to the graph below:

1 2

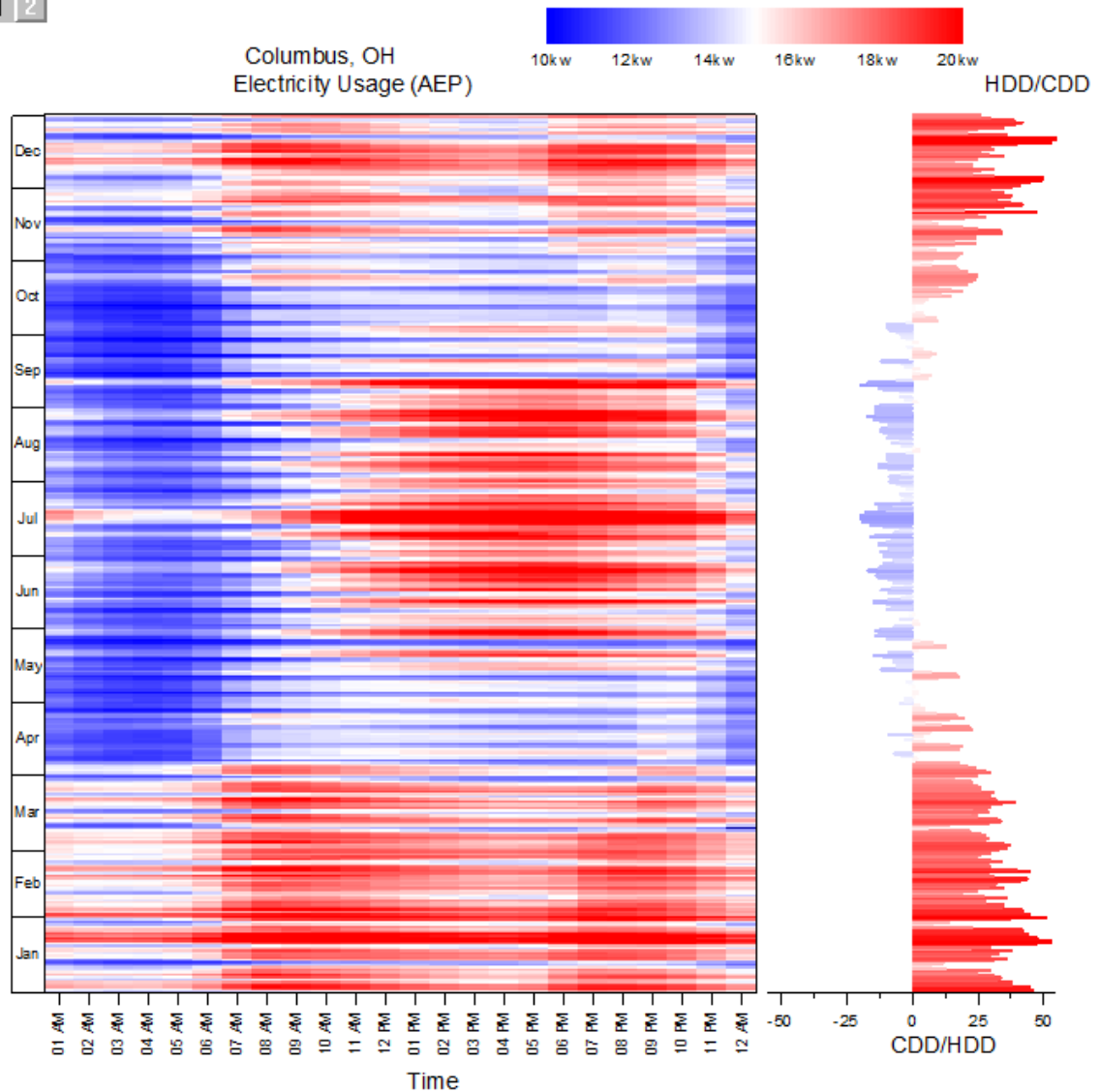

## 6.11 Statistics

### 6.11.1 Statistics

- [Box Plot](#)
- [Grouped Box Chart with Color Indexed Data Points](#)
- [I Shaped Box Plot](#)
- [Marginal Distribution Curve](#)
- [Overlapping Box Chart](#)
- [Two-Level Grouped Box Chart](#)
- [Unbalanced Grouped Box Chart](#)

- [Grouped Box Plot](#)
- [Notched Boxes with Variable Width Control](#)
- [Simple Dot Chart](#)
- [Multi-Data Dot Chart](#)
- [Add multiple fitted curves in a Histogram](#)
- [Weibull Probability Plot](#)
- [Q-Q Plot](#)
- [Scatter Matrix](#)
- [Histogram with Distribution Curve overlay](#)

## 6.11.2 Box Plot

### 6.11.2.1 Summary

This tutorial demonstrates how to create the following box plot with the data points and distribution curves both.

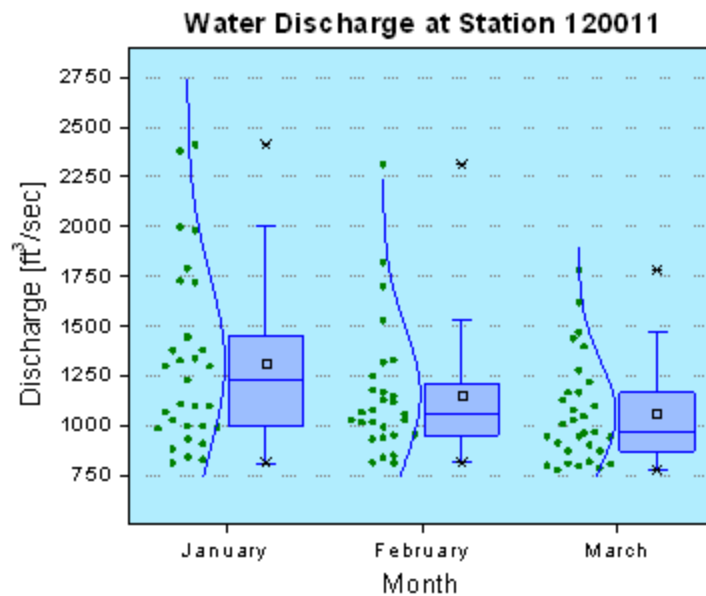

Minimum Origin Version Required: Origin 2015 SR0

### 6.11.2.2 What you will learn

This tutorial will show you how to:

- Create a data overlapped box plot
- Customize box plot settings
- Change the layer background

### 6.11.2.3 Steps

This tutorial is associated with : <Origin EXE Folder>\Samples\Tutorial Data.opj.

1. Open **Tutorial Data.opj** and browse to the **Box Plot** folder in **Project Explorer (PE)**.
2. Activate the **BoxData** worksheet, select the January(Y), February(Y), and March(Y) columns and plot them as a Box Chart using **Plot > Statistical: Box Chart**.
3. Double-click on one of the box charts to bring up the **Plot Details** dialog. In the **Group** tab select **None** from the **Border Color** drop-down list and use **Apply** to save the changes. This prevents the border colors of the box plots from automatically incrementing.
4. In the **Box** Tab, set as shown below to enable the data plot to the left of box:

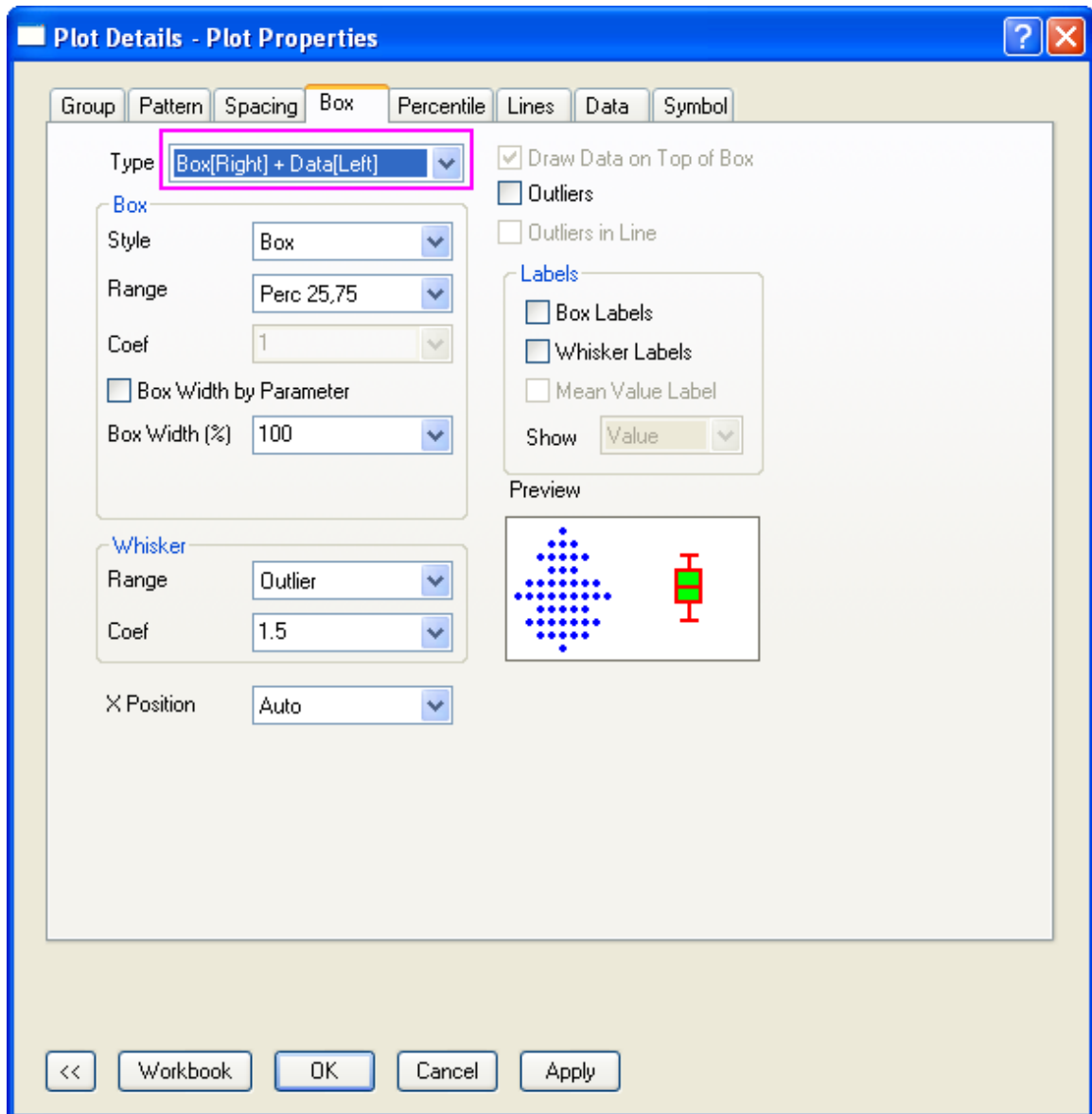

5. The **Data** tab shows up because data plot is also included in the plot. In this tab, change the settings as shown below to create a distribution curve and change the binning options:

Group Pattern Spacing Box Percentile Lines Data Symbol

Type **Dots**

Jitter Points

Single Block Barplot

Snap Points To Bin

Automatic Binning

Bin Size

Number of Bins

Begin

End

Bin Height (0-100)

Bin Worksheet

Add Distribution Curves

Distribution Curve

Type **Normal**

Scale to Maximum (%)

Bins Alignment

Center

Right

Left

Data Width (%) **Auto**

Preview



The Counts column in the Bin Worksheet can be used for fitting.

6. In the **Pattern** tab adjust the settings as shown below. To create a custom color, expand the **Color** option, click the vacant color under the **Custom** controls to open the **Colors** dialog. In the **Custom** tab of this dialog box, enter the **Red**, **Green** and **Blue** values to define your favorite color as below:

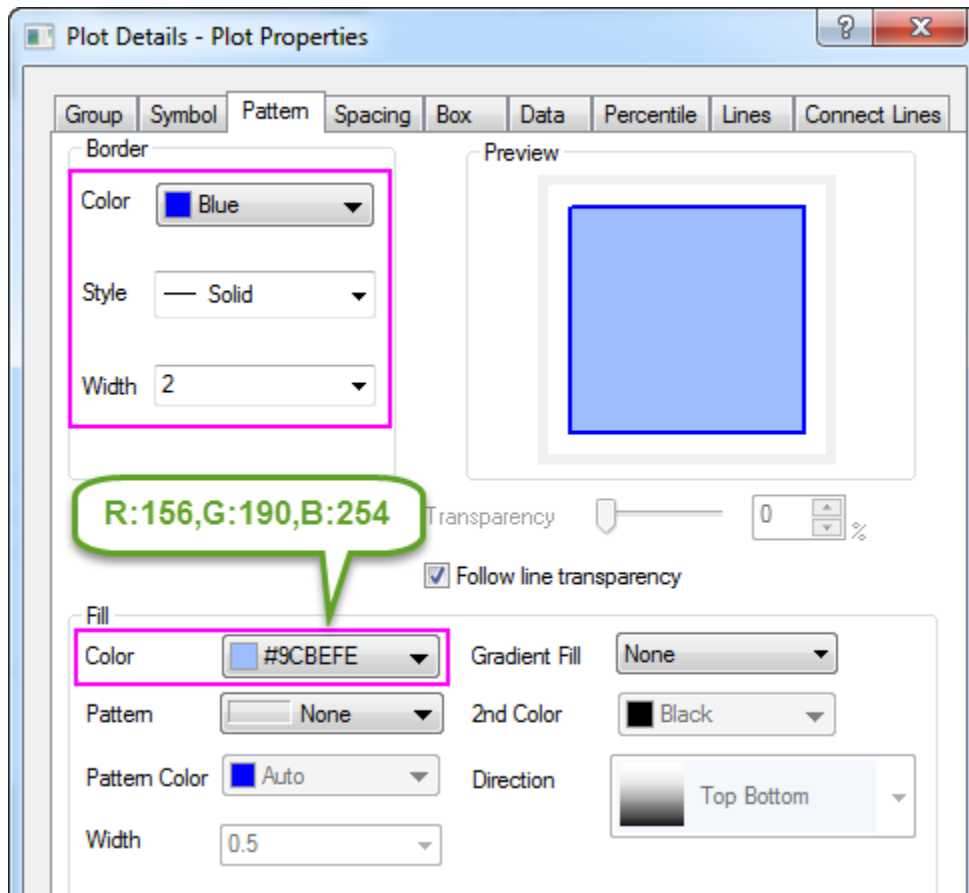

7. In the **Lines** Tab set the line style for Whisker. The style of caps is set to "Auto" so it follows the Whisker style, and the style for Median Line and Distribution Curve follows the box style set in the **Pattern** tab:

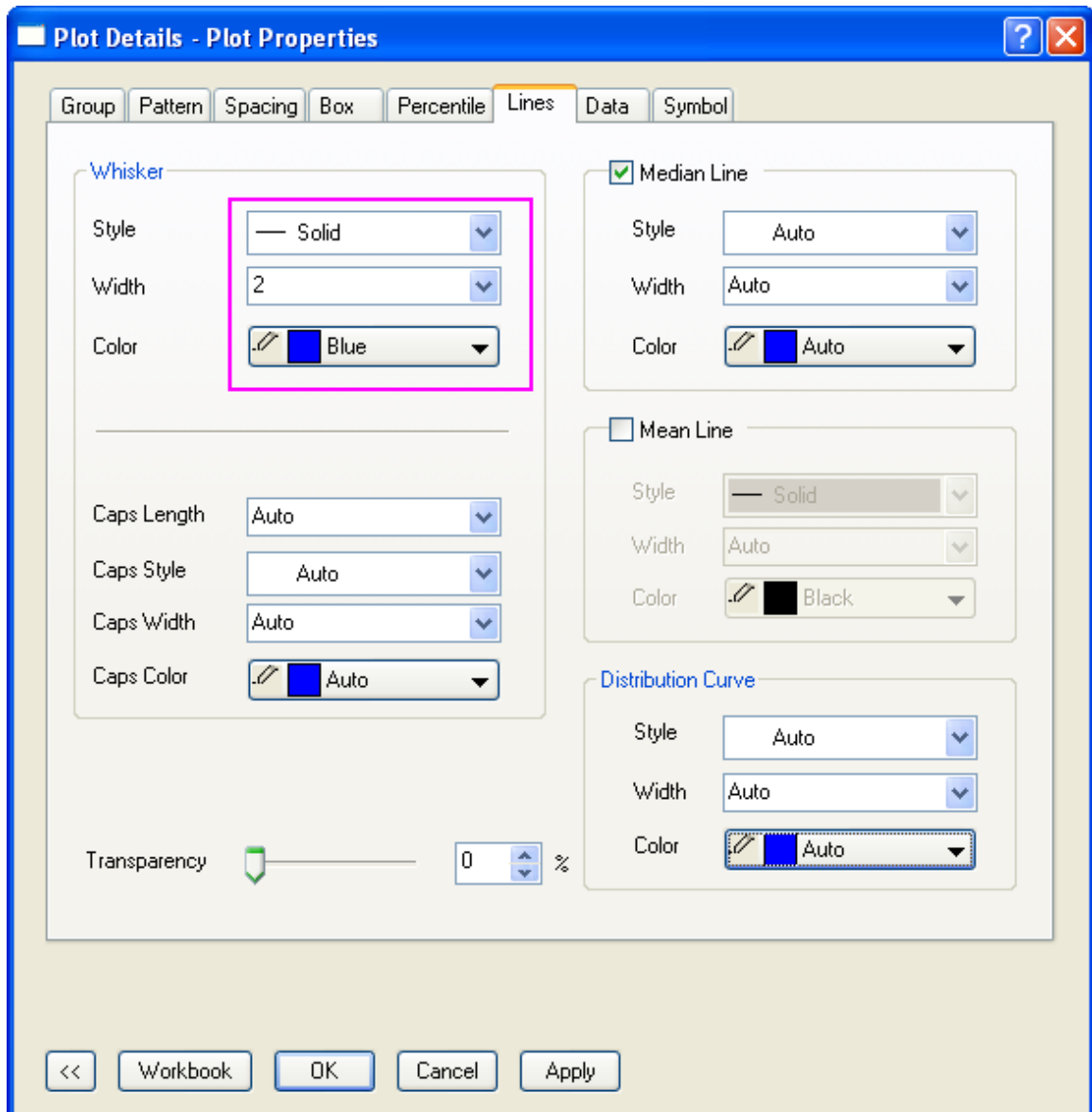

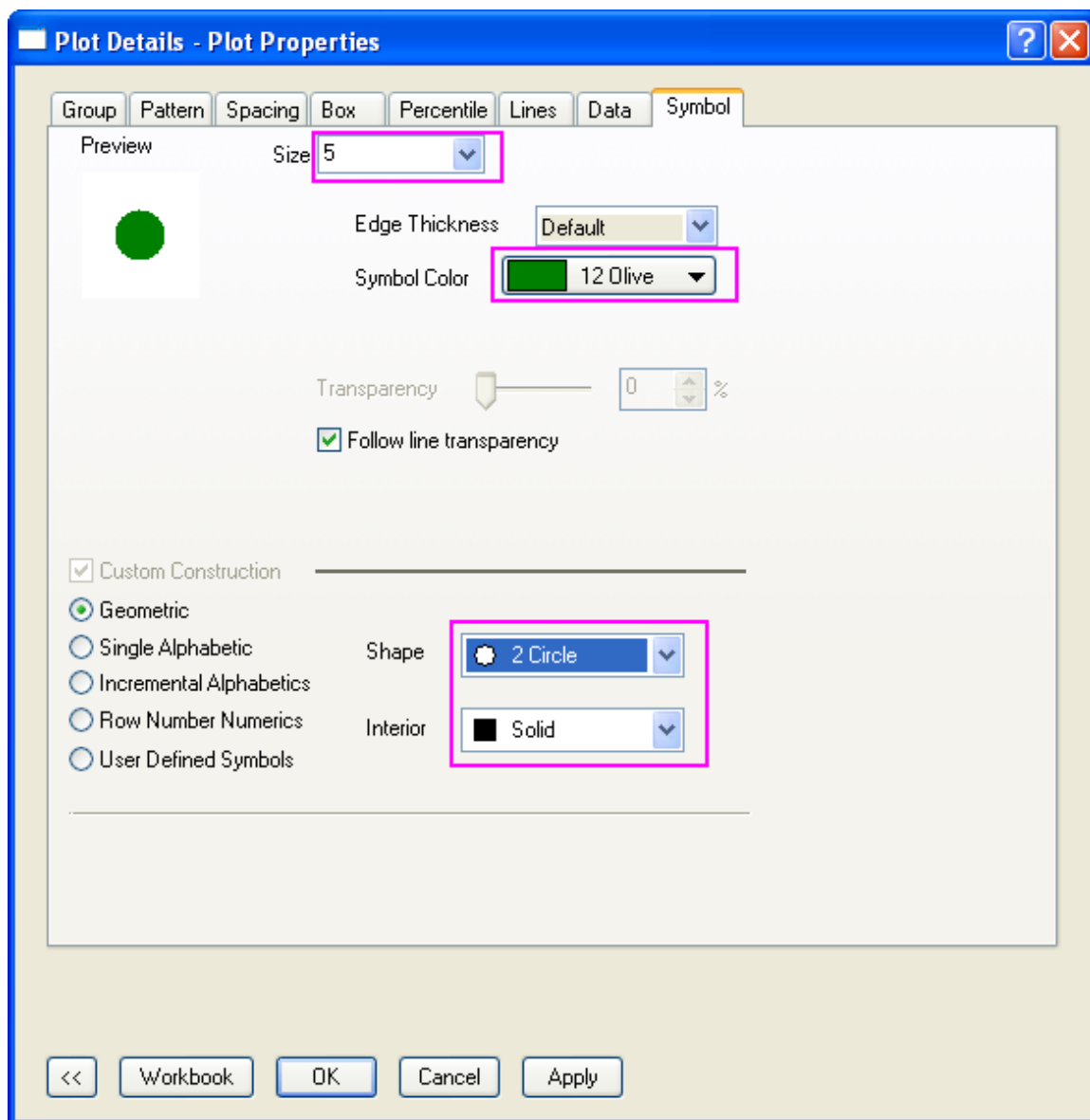

8. The next step is to customize the data symbols in the **Symbol** tab:



9. The style of the Percentile points is also changed in the **Percentile** tab:

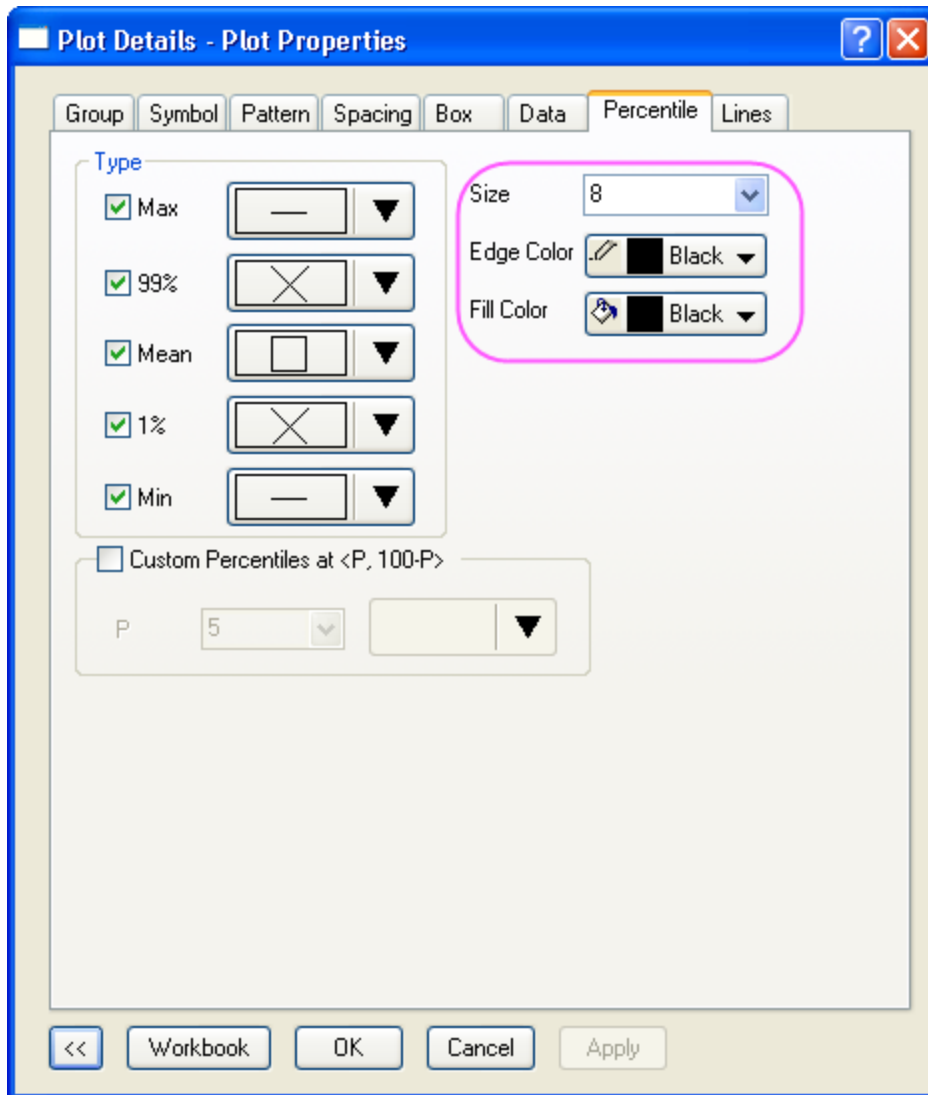



10. The next step is to change the background color. In the same **Plot Details** dialog, select **Layer 1** in the left panel to activate the tabs of layer level. If the left panel is not expanded use the  button on the bottom left of the dialog to expand it. In the **Background** tab, expand the **Color** option, click the vacant color under the **Custom** controls to open the **Colors** dialog. In the **Custom** tab of this dialog box, enter the **Red**, **Green** and **Blue** values to define your favorite color. Here, let us make the color(R:177, G:237, B:254). Click **OK** to accept the setting and close the dialog.
11. In order to customize the axes, double-click on the Y Axis to open a **Axes** dialog box and on the **Scale** tab, set the following axis scale specifications:

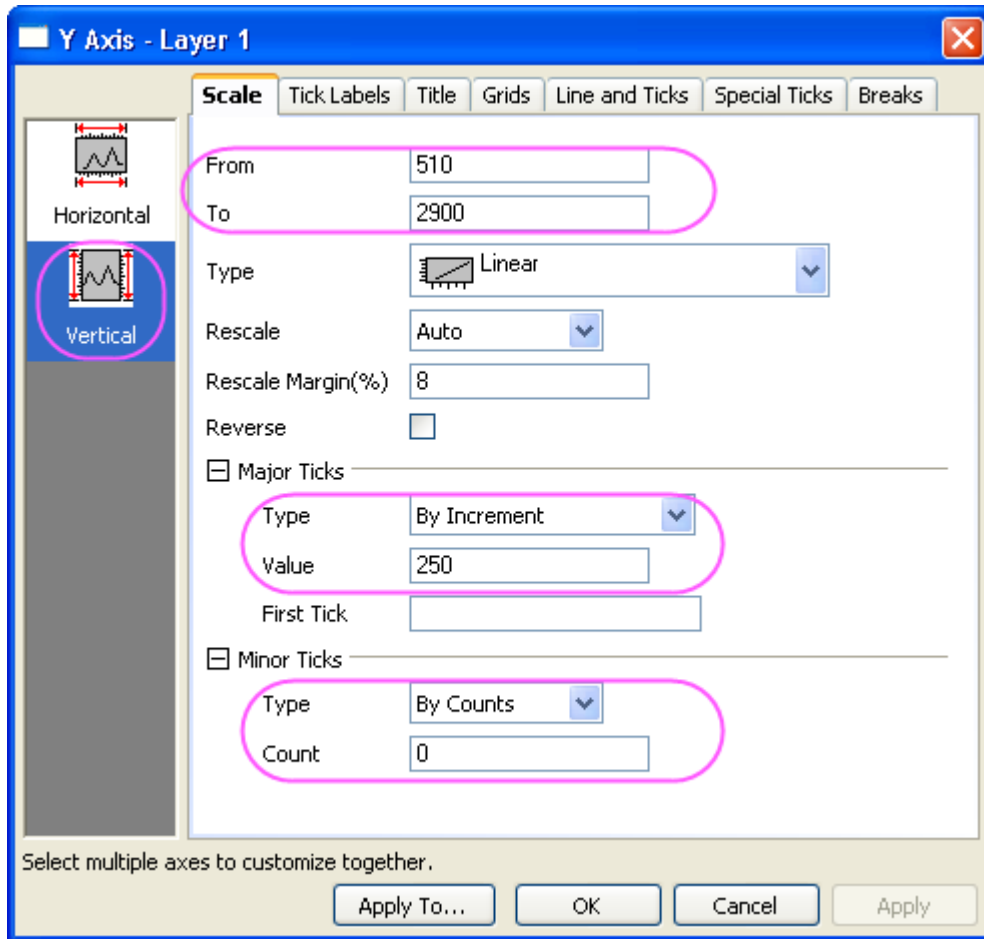

12. Go to the **Title** tab, select **Left'** icon in the left panel, change the Y axis title to *Discharge [ft<sup>3</sup>]/sec*:

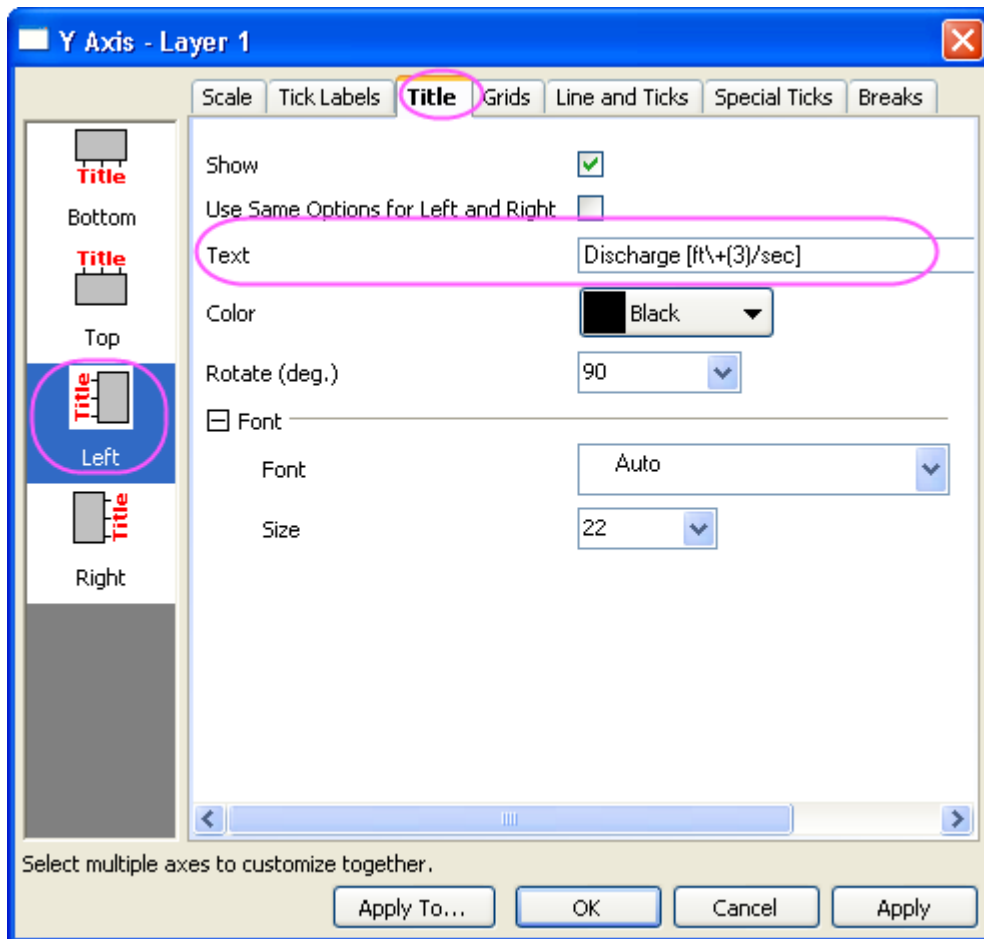

13. On the **Title** tab, choose **Bottom** icon in the left panel. Then check the **Show** check box, and change the X axis title to *Month*

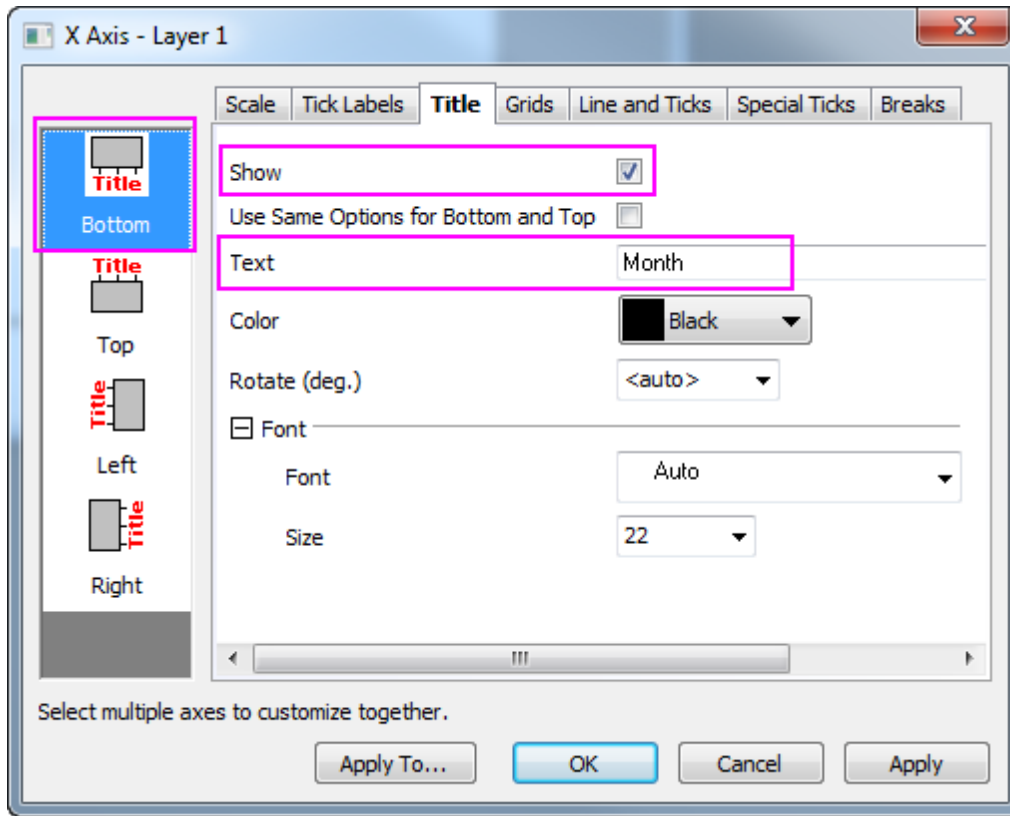

14. Open the **Grids** tab, select **Horizontal** icon in the left panel, enable the **Major Grid Lines** and set their styles as below:

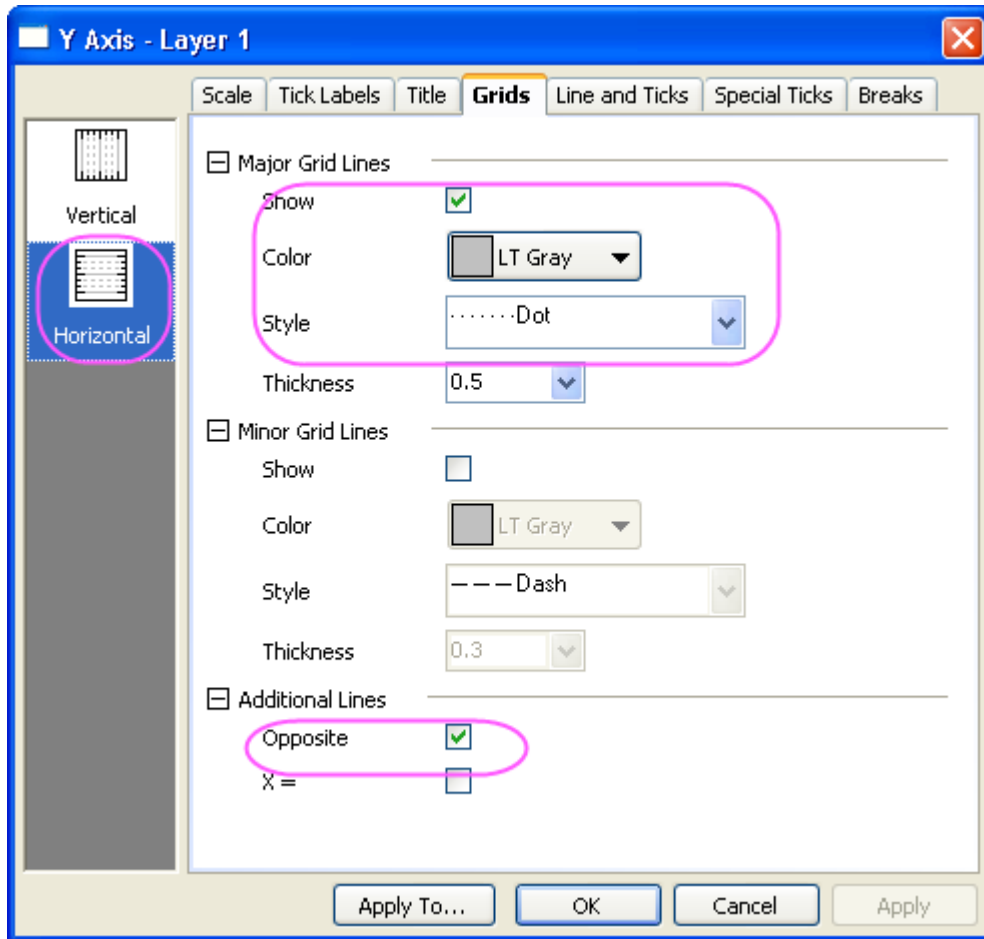

15. Click **OK** to save the settings and close the dialog. Select **View: Show: Frame** menu to add the frame to this graph.
16. The legend can be deleted if desired by selecting it and pressing the delete key.
17. Right-click the layer and select **Add/Modify Layer Title** from the menu that appears. Enter the text *Water Discharge at Station 120011* in the edit box. Existing layer titles and axes titles can be modified by double clicking on them till the text cursor appears.

### 6.11.3 Grouped Box Chart with Color Indexed Data Points

#### 6.11.3.1 Summary

Origin can be used to create grouped box plots from raw data with data points and distribution curves.

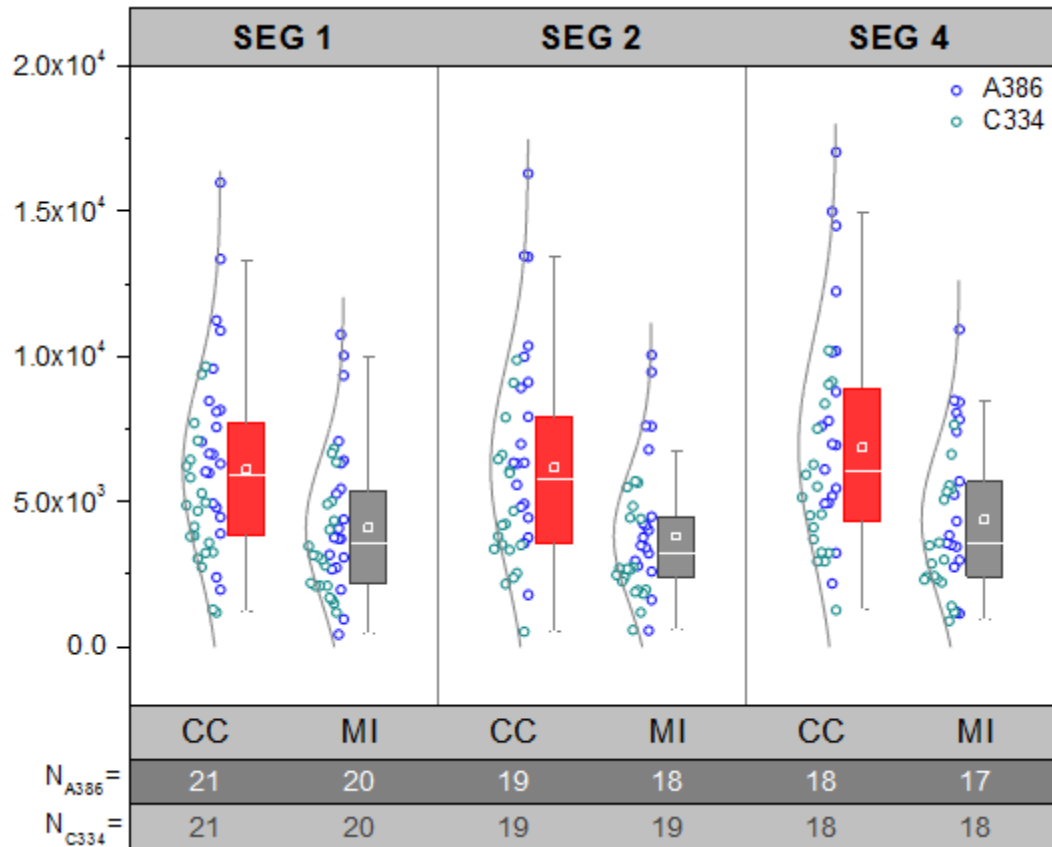

Minimum Origin Version Required: 2015 SR0

### 6.11.3.2 What you will learn

This tutorial will demonstrate how to:

- Create a grouped box plot from raw data
- Add a data plot with indexed symbol color
- Add and customize a distribution curve
- Customize the table-axes

### 6.11.3.3 Steps

#### 6.11.3.3.1 **Creating the Box Plot from Raw Data**

This tutorial is associated with <Origin EXE Folder>\Samples\Tutorial Data.opj.

1. Open **Tutorial Data.opj** and browse to the folder *Grouped Box with Index Color DataPoint*.
2. Activate the workbook **Book 5**.
3. Highlight col(E) - col(J):

	A(X)	B(Y)	E(Y) ↓	D(Y)	H(Y)	G(Y)	K(Y)	J(Y)
Long Name	ID	Machine	CC	MI	CC	MI	CC	MI
Units								
Comments			SEG 1	SEG 1	SEG 2	SEG 2	SEG 4	SEG 4
Filter								
1	AW390-0004	A386	4452.104	3071.058	4450.663	2589.701	5455.25	2979.168
2	AW390-0006	A386	6292.571	4381.999	4904.638	3202.871	5190.99	3454.301
3	AW390-0060	A386	10878.101	10025.173	9108.109	--	14491.19	10921.643
4	AW310-0139	A386	11236.832	6416.926	16297.672	10051.399	14981.875	8422.052
5	AW200-0040	A386	13334.318	9335.14	13429.485	9453.363	12235.172	8046.704
6	AW220-0009	A386	7562.084	--	7909.844	4473.576	10180.23	7816.758
7	AW170-0015	A386	8144.457	6306.148	9991.454	7582.644	10140.814	7416.709
8	AW098-0011	A386	1969.712	954.747	3752.383	1617.506	3237.382	1147.074
9	AW098-0047	A386	8094.329	5437.389	8912.438	6785.827	8785.203	5694.113
10	AW098-0127	A386	6629.159	3712.809	4808.346	4007.431	4957.694	2748.815
11	AW080-0020	A386	4798.724	4063.268	3556.263	3416.191	4933.238	--
12	AW080-0032	A386	3890.026	1969.526	6330.462	4160.389	6933.1	3504.334
13	AW080-0058	A386	6647.061	3728.53	6982.513	3753.326	6973.886	4319.772

- On the **2D Graphs** toolbar click the small triangle at the bottom of the sixth button to reveal the fly out menu. Select **Grouped Box Charts - Raw Data** as shown below:

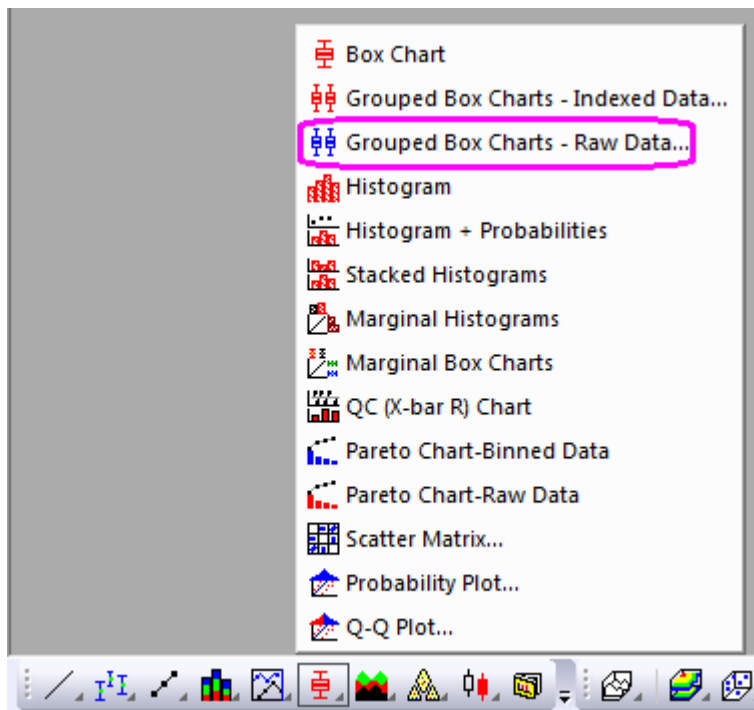

- In the **Plotting: plotboxrow** dialog, set the **Group Number** to **2**, the **1st Group Row** to **Comments** and the **2nd Group Row** to **Long Name**. This will create a box chart with the column data arranged in three groups of two, with X axis row names derived from the Comments and the Long Names on the worksheet:

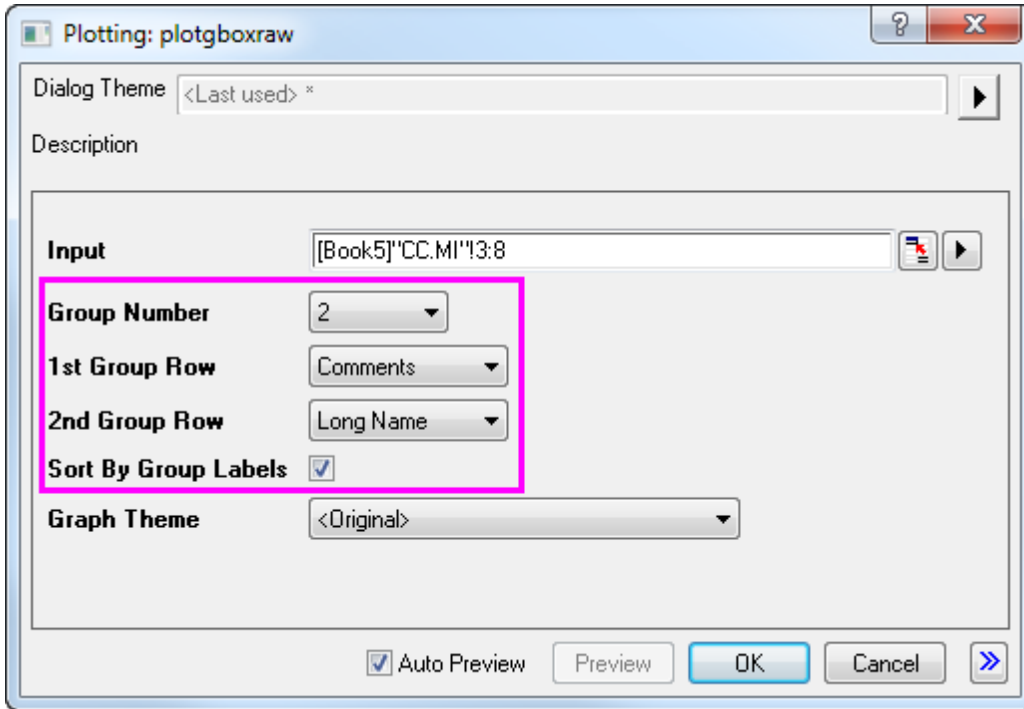

- Click the **OK** button. The grouped box chart from raw data is created with two grouping levels as shown below:

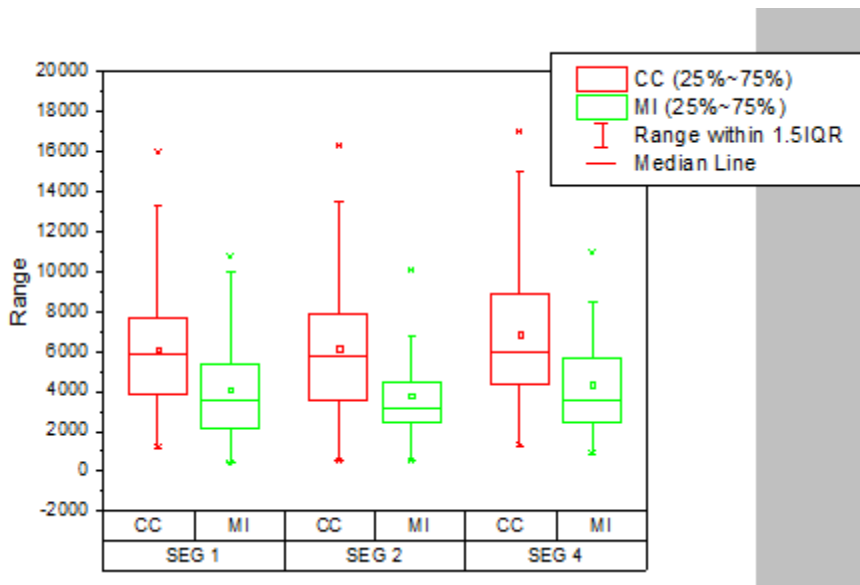

- To add data points in the graph, double click the plot to open the **Plot Details** dialog. Expand the **Layer1** option on the left panel and select the first plot under it.
- On the **Box** tab, set **Type** to **Box[Right] + Data [Left]**. Click the **Apply** button. This will add two new tabs to the dialog: **Data** and **Symbol**



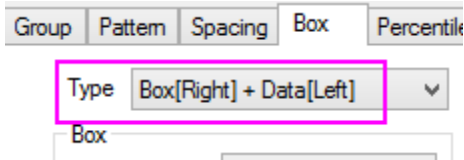

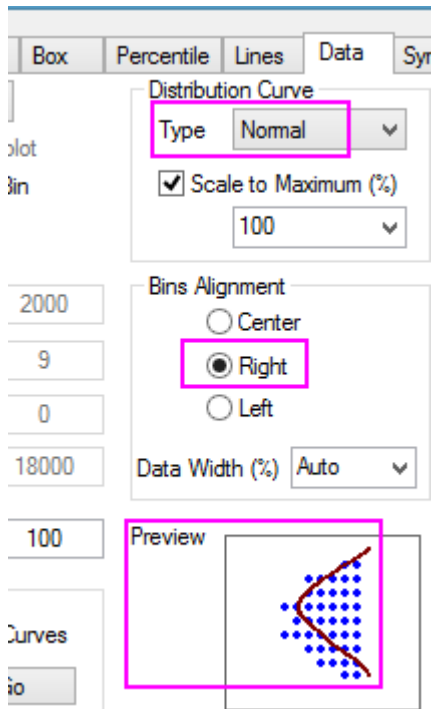

- To add a Distribution Curve, on the **Data** tab, set Distribution Curve **Type** to **Normal**. Set **Bins Alignment** to **Right** to orient the curve.

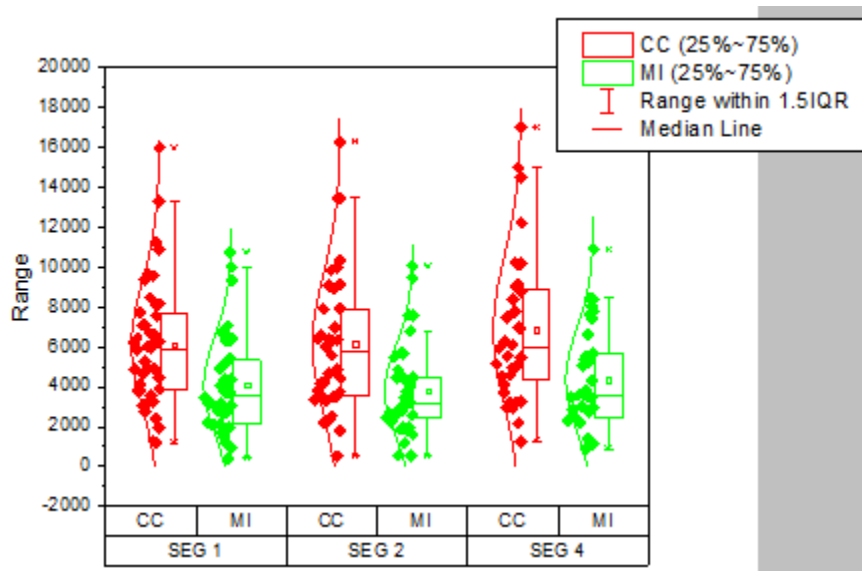

- Click the **OK** button. The data points and distribution curves will appear on the graph as shown below:



### 6.11.3.3.2 Customizing the Boxes and Statistical Markers

1. Double click on the any one of the boxes to re-open the **Plot Details** dialog.
2. On the **Group** tab set both **Border Color** and **Box Color** to increment **By One** so each box in subgroup has a different color.
3. Click the  button on the **Details** section of **Border Color**. In the **Increment Editor** dialog that opens, click the first color and change it to be **Red**. Change the second color to **Gray**. Click OK.
4. Click the  button on the **Details** section of the **Box Color** to open the **Increment Editor** dialog. Click 1st color and click **Define Custom Color** button.

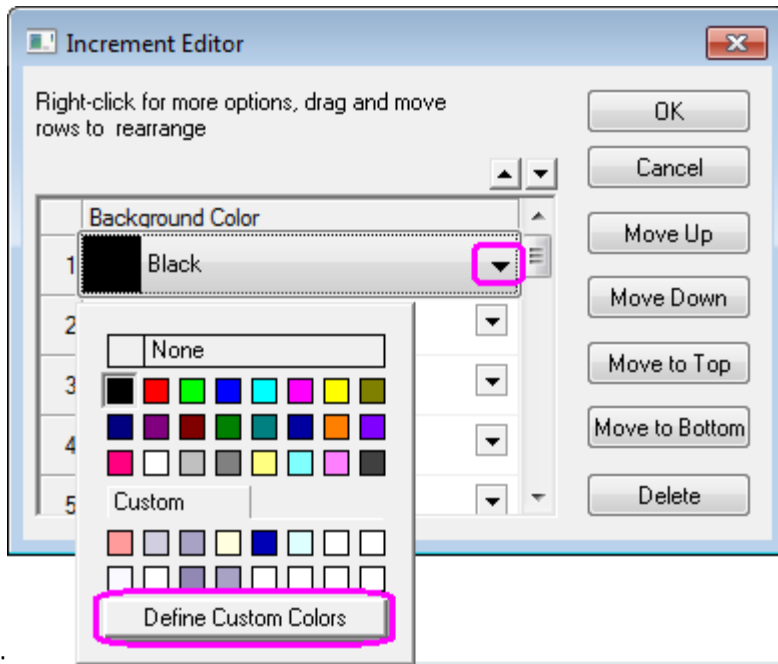

5. Set **RGB** values in **Red, Green, Blue** boxes on bottom right to be **255, 51** and **51**, and click **OK** to close dialog.
6. Do the same for the 2nd color. Set Define **RGB** value to be **143, 143** and **143**, and click **OK** to close dialog. Then click **OK** to close **Increment Editor** dialog and apply settings.
7. This step is to customize the descriptive statistic markers whether to show on the plot such as the **99%, 1%, Max** and **Min** marks.  
Go to the **Percentile** tab, and set the **Edge Color** to **White** and click **Apply** button. Since background of the graph is also white, **Max, Min, 99%, 1%** will look like disappeared in graph.



On **Percentile** tab, users can also hide a Marker by setting the **Type** as **None**(the last shape) in the dropdown list.

- On the **Lines** tab set the **Color** for the **Whisker** and the **Caps** to **Gray** and **Median Line** to **White**. Click **OK**. The plot should appear as shown below:

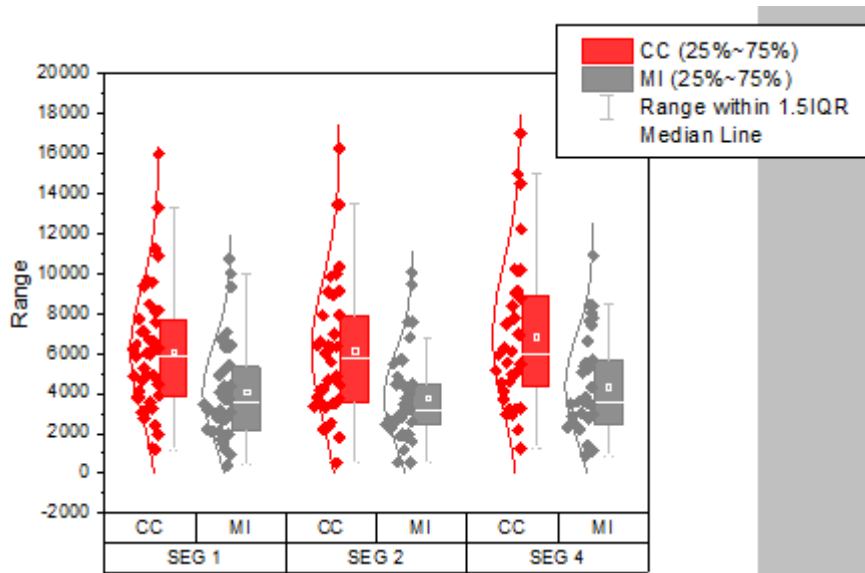

### 6.11.3.3.3 Customizing Data Symbols and Distribution Curves

- Double click any box in the graph to open the **Plot Details** dialog.
- On the **Symbol** tab. Set the **Size** to **5**, the **Shape** to **2 Circle** and the **Interior** to **Open**.
- Click the **Edge Color** dropdown list and choose **Indexing: Col(B):Machines**. The symbol's edge colors will be indexed to column B. All symbols with Machine value **A386** will be one color and the ones with **C334** will be a different color:

The screenshot shows the 'Symbol' tab of the 'Plot Details' dialog. The 'Size' is set to 5, 'Shape' is '2 Circle', and 'Interior' is 'Open'. The 'Edge Color' is set to 'Index.Col(B): "Ma...'. The background shows a data table with columns A(X) and B(Y). The B(Y) column contains values A386 and C334, which correspond to the edge colors of the symbols in the plot.

	A(X)	B(Y)	
Long Name	ID	Machine	
Units			
Comments			SI
Filter			
15	AW080-0115	A386	23
16	AW078-0092	A386	49
17	AW192-0095	A386	84
18	AW560-0069	A386	159
19	AW480-0118	A386	59
20	AW340-0079	A386	60
21	AW287-0138	A386	70
22	AW390-0004	C334	32
23	AW390-0006	C334	35
24	AW390-0060	C334	70
25	AW310-0139	C334	77
26	AW200-0040	C334	96

- When symbol color is indexed, another tab **Color List** will appear in the dialog. To set a user defined color increment list, go to the **Color List** tab. Enable the **Use custom increment list** box and set the first two **Color Values** as **Blue** and **Dark Cyan**.

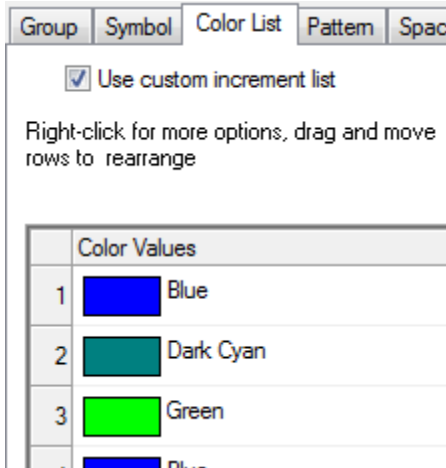

- To customize the distribution curve color, on the **Lines** tab, set the Distribution Curve **Color** to **Gray**.
- Click **OK** to close the dialog.

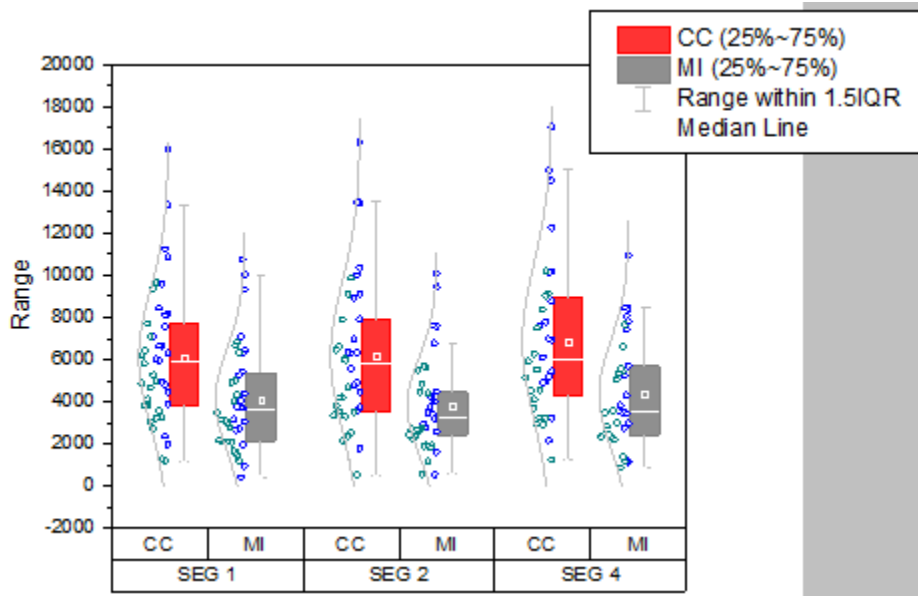

#### 6.11.3.3.4 Customizing the Axes

For grouped plots support multi-row tick label tables. The corresponding axis icons in the **Tick Labels** tab of **Axis dialog** starts from the last table row, e.g. **Bottom 1**, **Bottom 2**, ..., **Bottom N**. This means the first row from the bottom will correspond to **Bottom1** and so forth.

- To move the tick label row with **SEG 1**, **SEG 2** and **SEG 3** to the top X axis, double click on this tick label row.

- This opens the **Axis Dialog** with the **Bottom 1** axis icon selected. Right click the **Bottom 1** icon on the left panel and choose **Move to Opposite**.

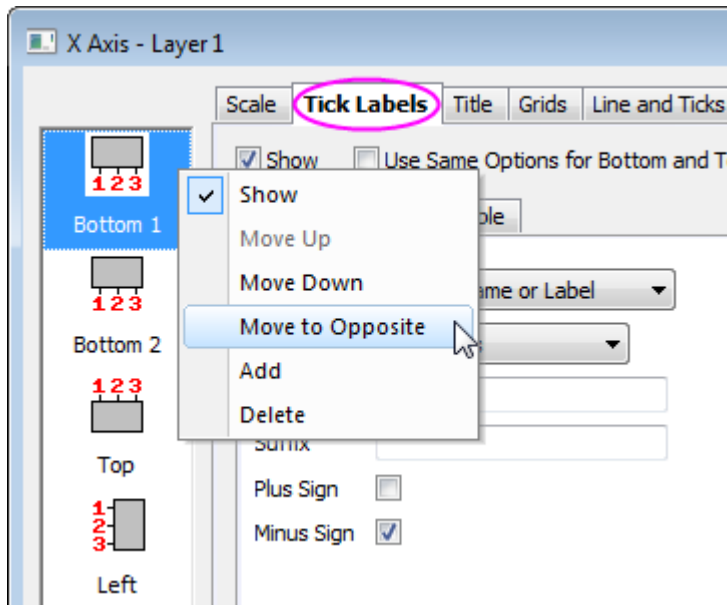

- Click the **Apply** button. The **SEG 1**, **SEG 2** and **SEG 3** tick label row will now appear at the top X axis on the graph, and as the axis icon is renamed as **Top 1** on the left panel in the dialog.
- The previous **Bottom 2** icon will become the **Bottom 1** icon. Select the **Bottom 1** icon. Go to the **Table** tab. Set the **Number of Rows** to **3**. Click the **Apply** button. Three identical bottom tick label tables will appear on the graph and they are **Bottom 1**, **Bottom 2** and **Bottom 3**.
- To fill first bottom tick label row with light gray, select the **Bottom 3** icon on the left panel, make sure you are still at the **Table** tab and clear the **Auto** check box to enable separate control of tick label table layout. Set **Fill Color** as **LT Gray** and deselect the **Inside Border** check box under Table Layout node.
- The second row derives the labels from col(C) of the second worksheet **A386\_CC.MI**. Select the **Bottom 2** icon and go to the **Display** tab, set the **Type** to **Text from dataset** and set the **Dataset Name** from the drop down as **[Book5]"A386\_CC.MI"!C"N"**.
- Go to the **Format** tab and clear the **Auto** check box, change the **Color** to **White**. Then go to the **Table** tab and set as the following:

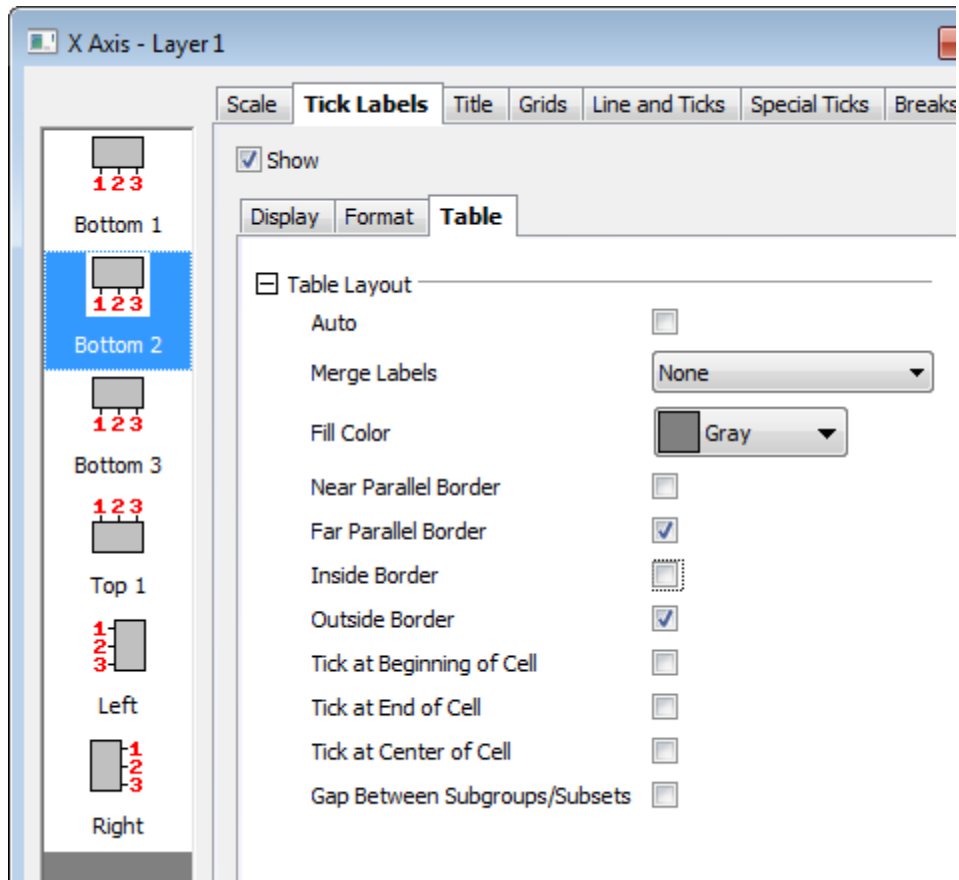

8. Select the icon **Bottom 1**, go to the **Display** tab, set the **Type** to **Text from dataset** and then set the **Dataset Name** as **[Book5]"C334\_CC.MI"!C"N** since it uses col(C) from the third worksheet **C334\_CC.MI**.
9. Go to the **Table** tab and set the table layout as below:

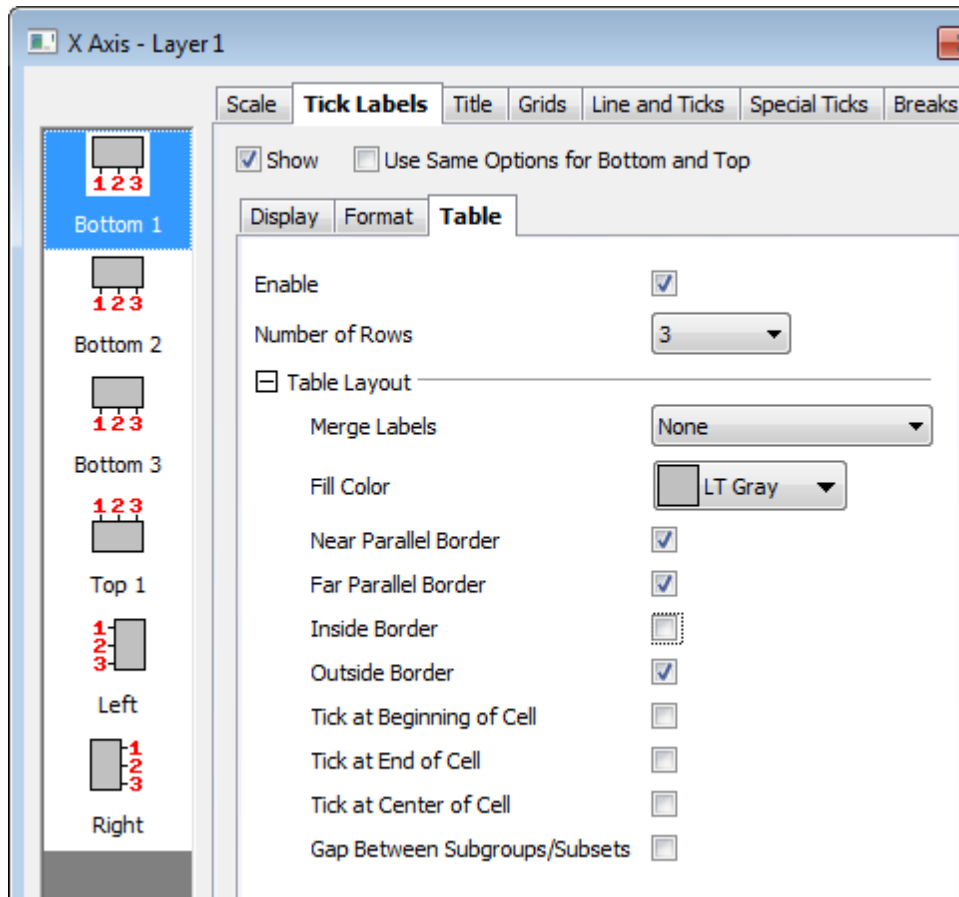

10. Select the **Top 1** icon, go to the **Table** tab and set the table layout for top axis as below:

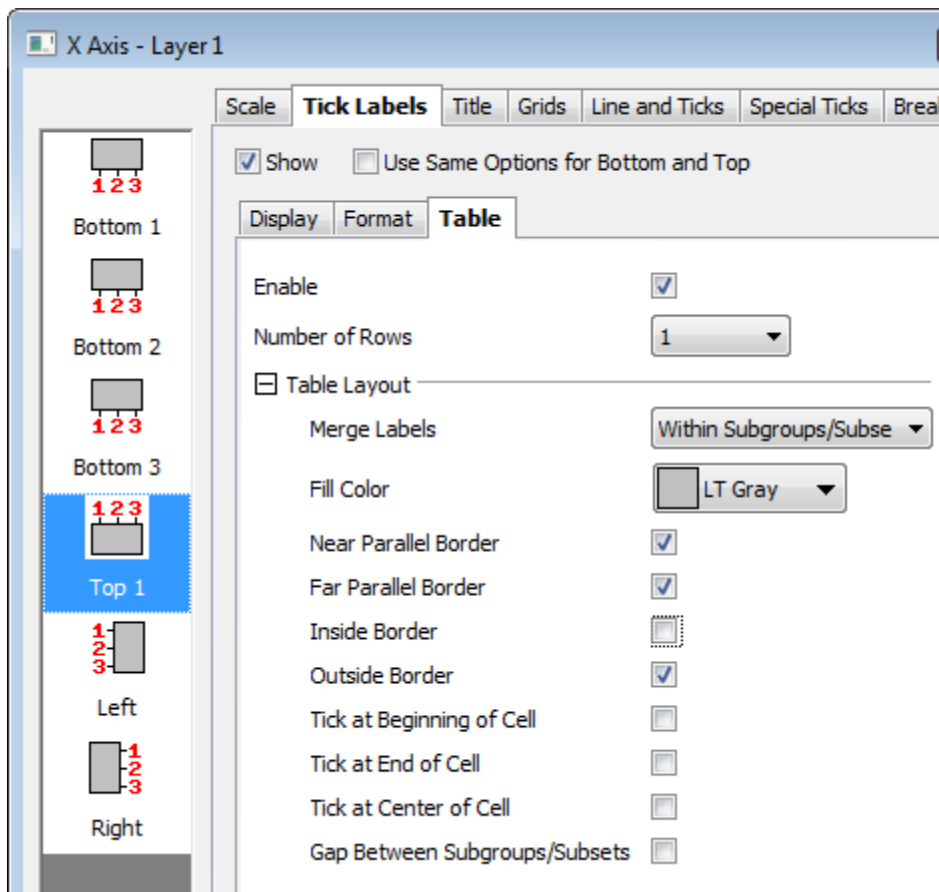

11. Then go to the **Format** tab, set **Font Size** to 22 and change the tick labels to **Bold**:

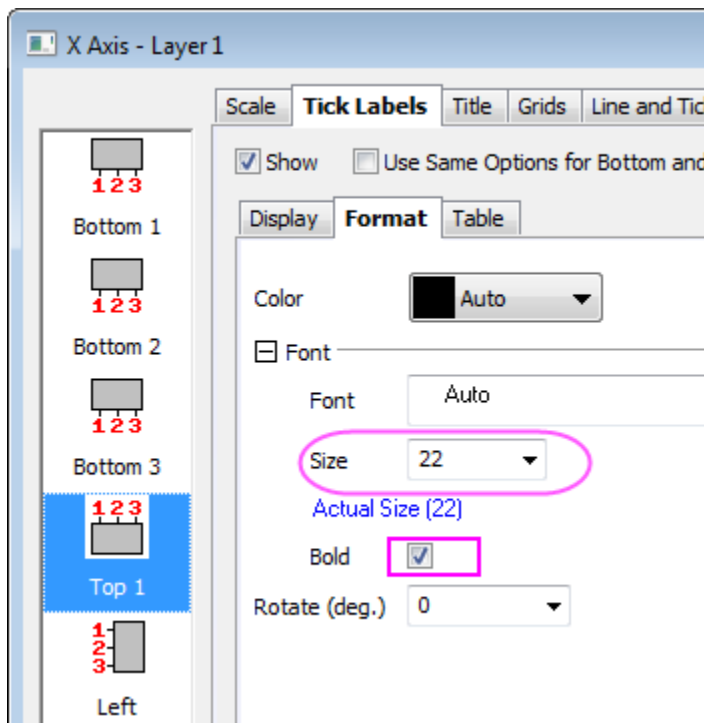





12. For the Y Axis change to the following settings:
  - o **Scale** tab (**Vertical** icon): Set **Increment** to **5000**
  - o **Tick Labels** tab >> **Display** tab (**Left** icon): Set **Display** to **Scientific 10<sup>3</sup>**
13. Click **OK** to close the dialog.
14. Select Y axis title **Range** and press the **Delete** key to remove it.

#### 6.11.3.3.5 Updating the Legend and Adding Text Objects

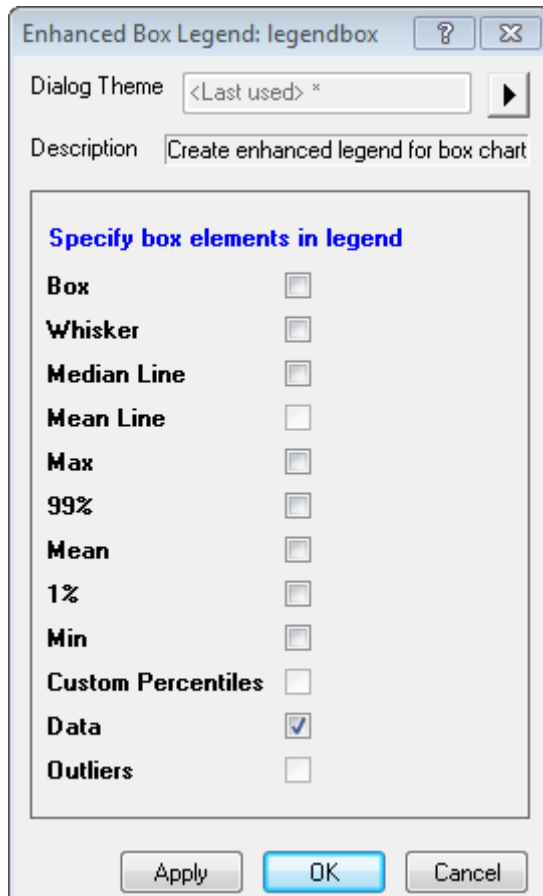
1. Right click the box chart legend and select **Legend: Box Chart Components...** to open the **Enhanced Box Legend: legendbox** dialog. Deselect all the components except for **Data**:



2. Click the **OK** button. The legend will show only the data symbols. Double click the legend text to go into in-place edit mode. Delete the first row of the legend. Select and drag to move the legend object to a better location.
3. To remove the black line around the legend, right click the legend object and choose **Properties...**. In the **Object Properties** dialog, go to **Frame** tab to set **Frame** to **None**.
4. Origin doesn't support tick label table titles yet. But users can add text objects manually. Right click on the white space to the left of the second bottom tick label row and choose **Add Text...** from the context menu that appears. Type **NA386=**. Then, still in in-place edit mode, highlight A386 and click the  button on the **Format** toolbar to change it into subscript. Select and drag to adjust the positioning.

5. Add another text object NC334= to the left of the third tick label row and change C334 into subscript.

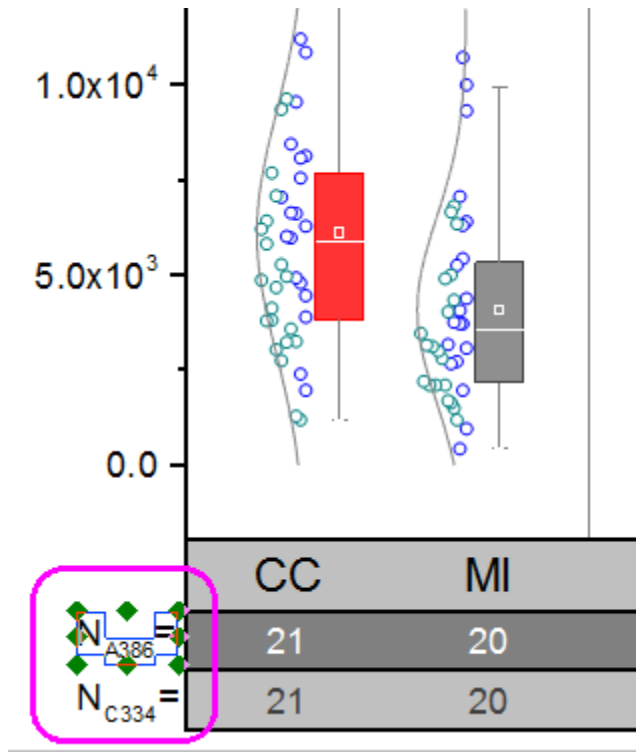

The final graph should appear as shown below:

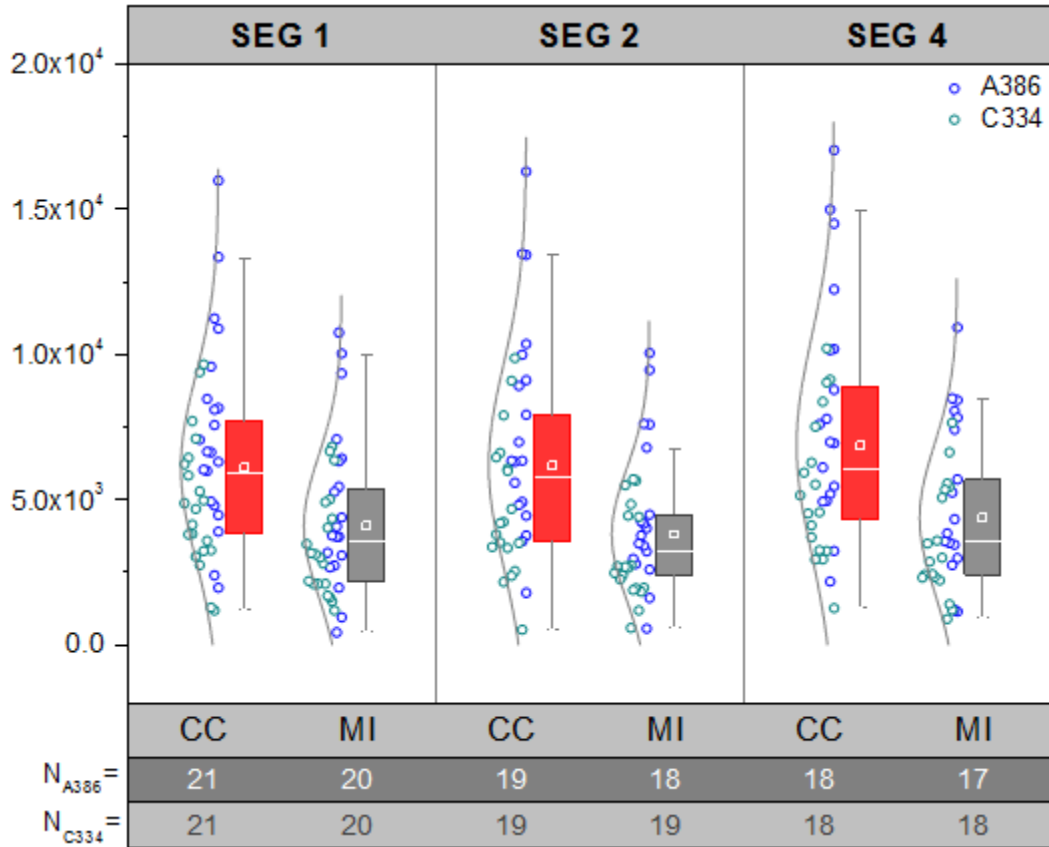

You can click to select table labels and nudge them using the arrow keys on your keyboard.

### 6.11.4I Shaped Box Plot

#### 6.11.4.1 Summary

Origin's box plot is highly customizable. This tutorial shows how to create a I-Shaped box chart with overlapping data points and customized percentiles.

## Weather History for Boston, Fall (Sep, Oct, Nov)



Minimum Origin Version Required: 2015 SR0

### 6.11.4.2 What you will learn

- Customize box plot settings
- Customize the axis dialog for box plots
- Add a line object to a box plot

### 6.11.4.3 Steps to Create a I-Shaped Box Chart with Data Point

This tutorial is associated with <Origin EXE Folder>\Samples\Tutorial Data.opj.

1. Open the Tutorial Data.opj and browse to folder *I-Shaped Box*.
2. Activate workbook **Book1, Sheet1**. Highlight columns A through K and then select **Plot > Statistical: Box Chart**. Next, select and delete the legend object from the graph.
3. Double-click on one of the plot boxes to bring up the **Plot Details** dialog box. Go to the **Box** tab and set **Type** to **Box + Data Overlap**, **Style** to **I-shaped Box** and **Whisker Range** to **Min-Max**, and check **Outliers** box.

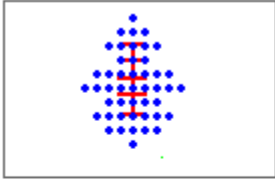
Group	Pattern	Spacing	Box	Percentile	Lines	Data	Symbol
Type		Box + Data Overlap		<input checked="" type="checkbox"/> Draw Data on Top of Box			
Box		Style I-shaped Box		<input checked="" type="checkbox"/> Outliers			
				<input checked="" type="checkbox"/> Outliers in Line			
Range		Perc 25,75		Labels			
Coef		1		<input type="checkbox"/> Box Labels			
<input type="checkbox"/> Box Width by Parameter				<input type="checkbox"/> Whisker Labels			
Box Width (%)		100		<input type="checkbox"/> Mean Value Label			
				Show		Value	
Whisker				Preview			
Range		Min-Max					
Coef		1.5					
X Position		Auto					

- Go to the **Data** tab and set **Data Width (%)** to 0.

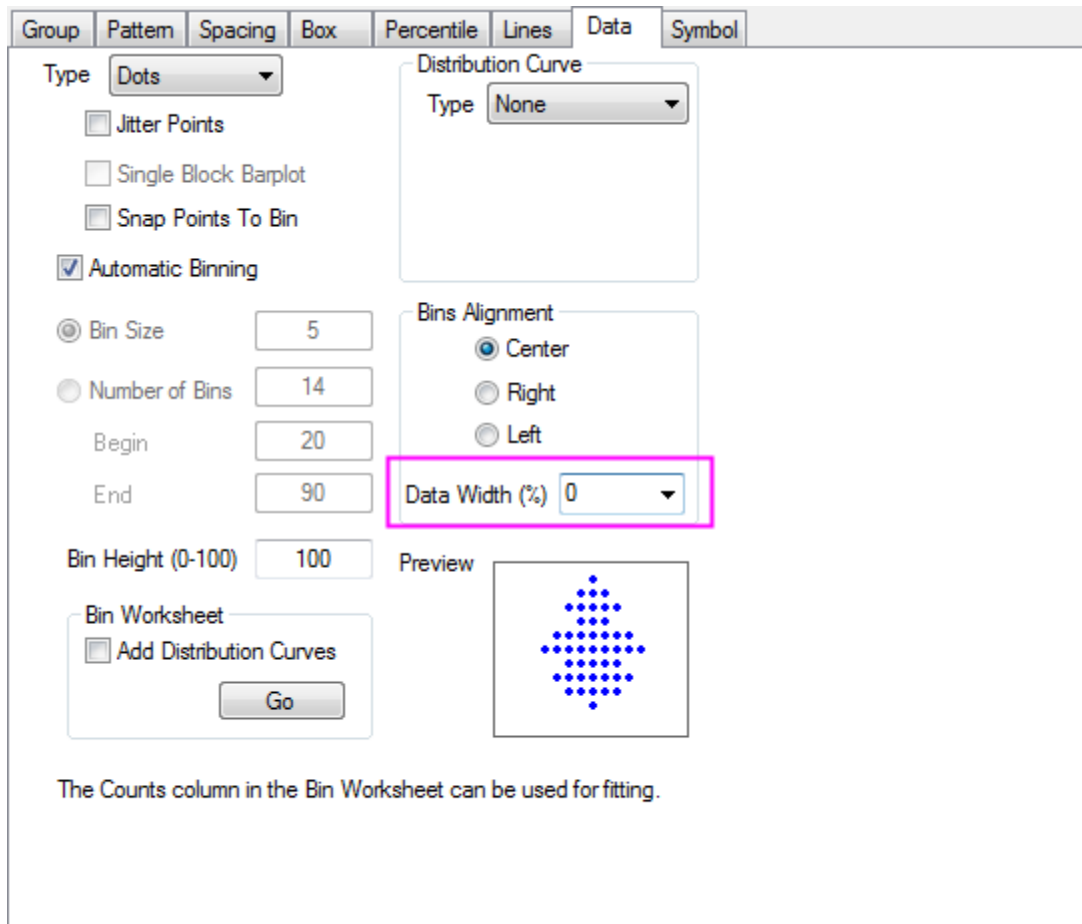

- Click **OK** to apply the settings.

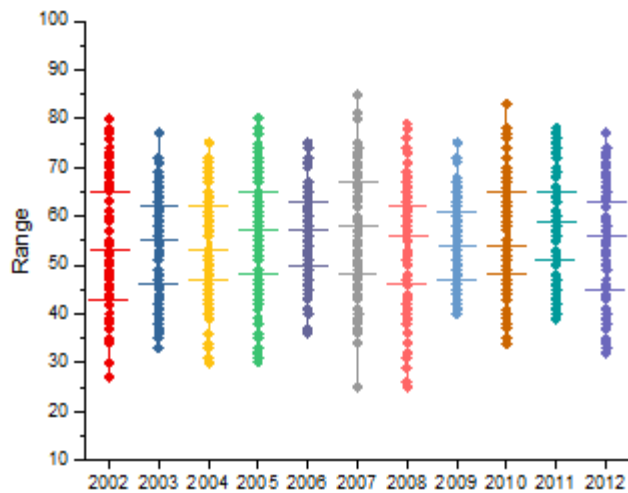

#### 6.11.4.4 Further Customizations to Box Style

1. Double-click on one of the plot boxes to bring up the **Plot Details** dialog box again. Go to the **Group** tab and set **Border Color Increment** to **None**.

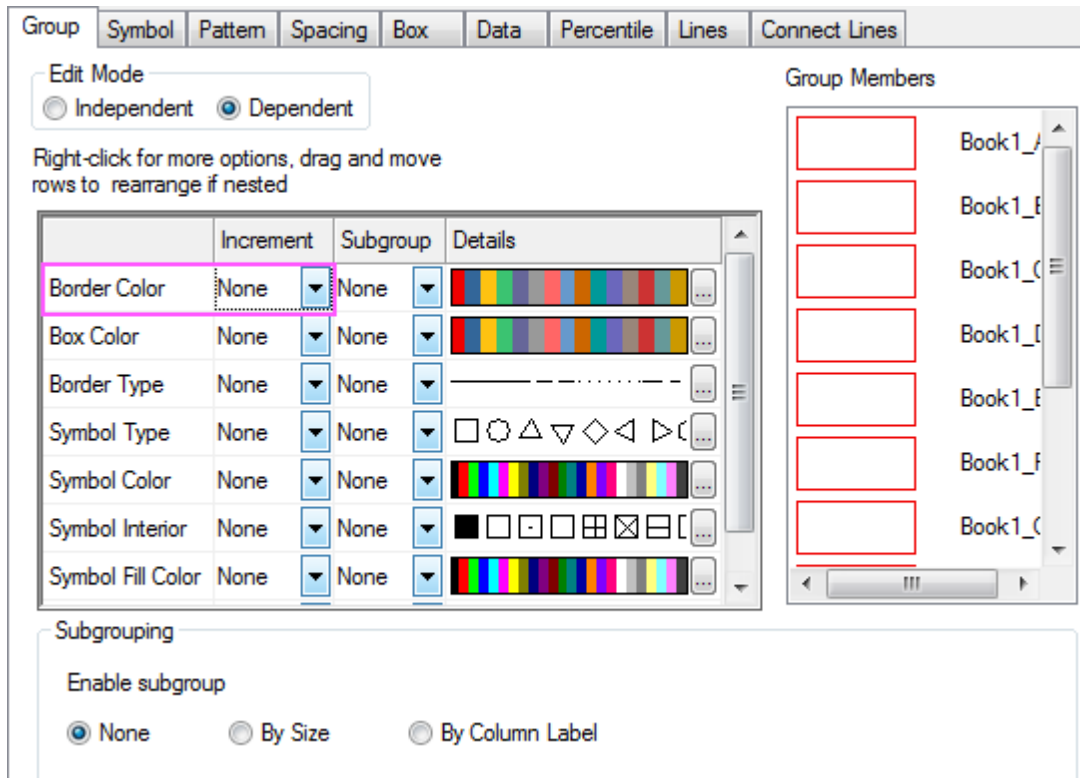

2. Go to the **Symbol** tab, set symbol **Shape** as **1 Square** and **Interior** as **Open**, then set both **Edge Color** and **Fill Color** to **15 Orange**. Clear **Follow line transparency** and set the **Transparency** slider to 80%.

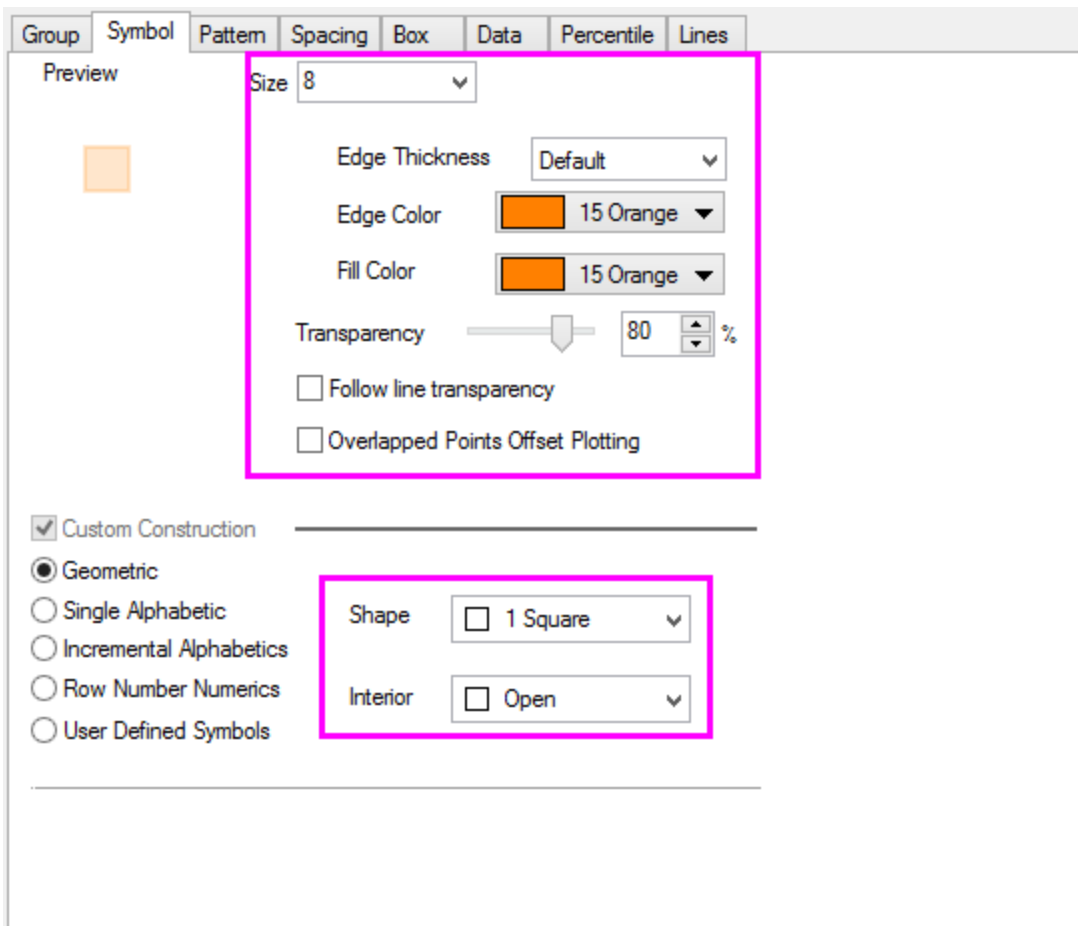

3. Go to the **Pattern** tab and set **Border Color** to **Purple** and **Width** to 1.5.



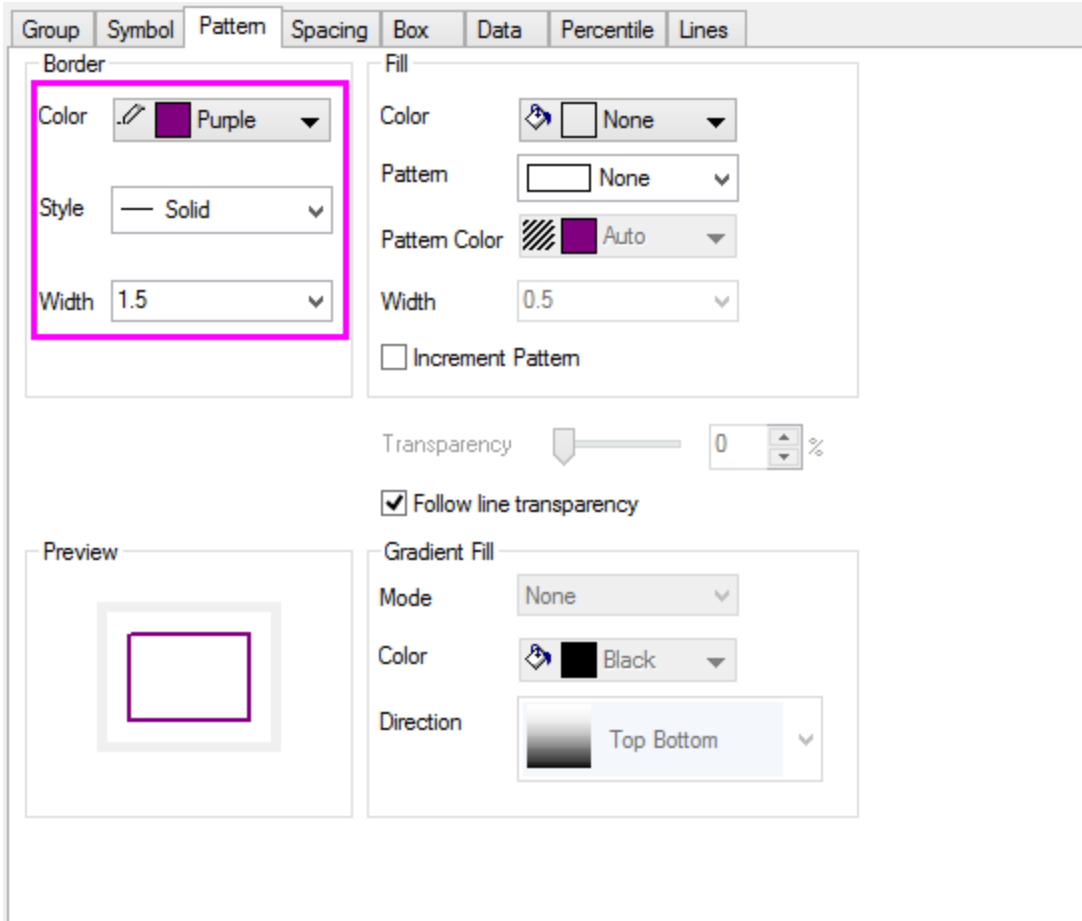

- Go to the **Spacing** tab and set **Gap Between Boxes(in %)** to 0.
- Go to the **Percentile** tab and duplicate the settings as shown below for **Type** and check **Custom Percentiles at <P, 100-P>** box.

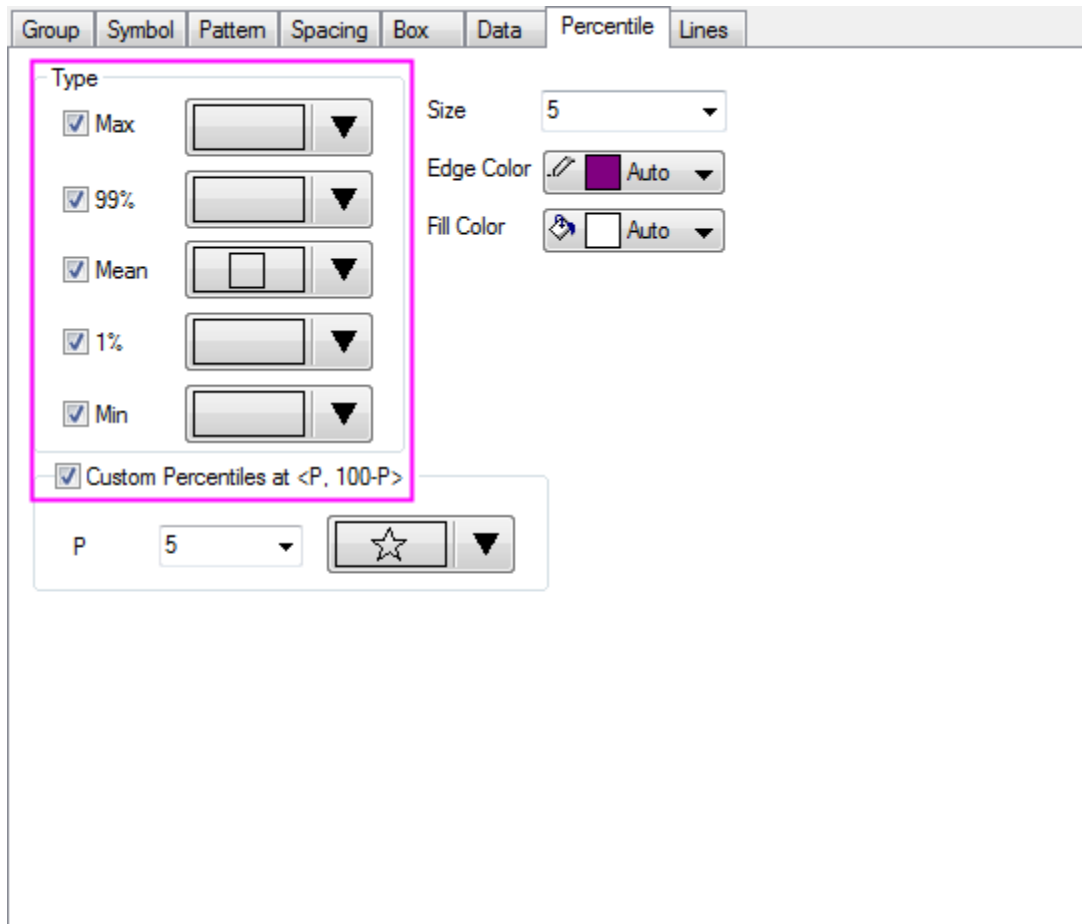

6. Go to the **Lines** tab and duplicate settings as shown below.

Group Symbol Pattern Spacing Box Data Percentile **Lines**

**Whisker**

Style  ▼

Width  ▼

Color  ▼

---

Caps Length  ▼

Caps Style  ▼

Caps Width  ▼

Caps Color  ▼

**Median Line**

Style  ▼

Width  ▼

Color  ▼

**Mean Line**

Style  ▼

Width  ▼

Color  ▼

**Distribution Curve**

Style  ▼

Width  ▼

Color  ▼

Transparency  %

7. Click **OK** to apply the settings.

#### 6.11.4.5 Further Customizations to Axes

1. Double-click on the X axis to open the Axis Dialog box. Go to the **Scale** tab and set **Minor Ticks Count** to 1.

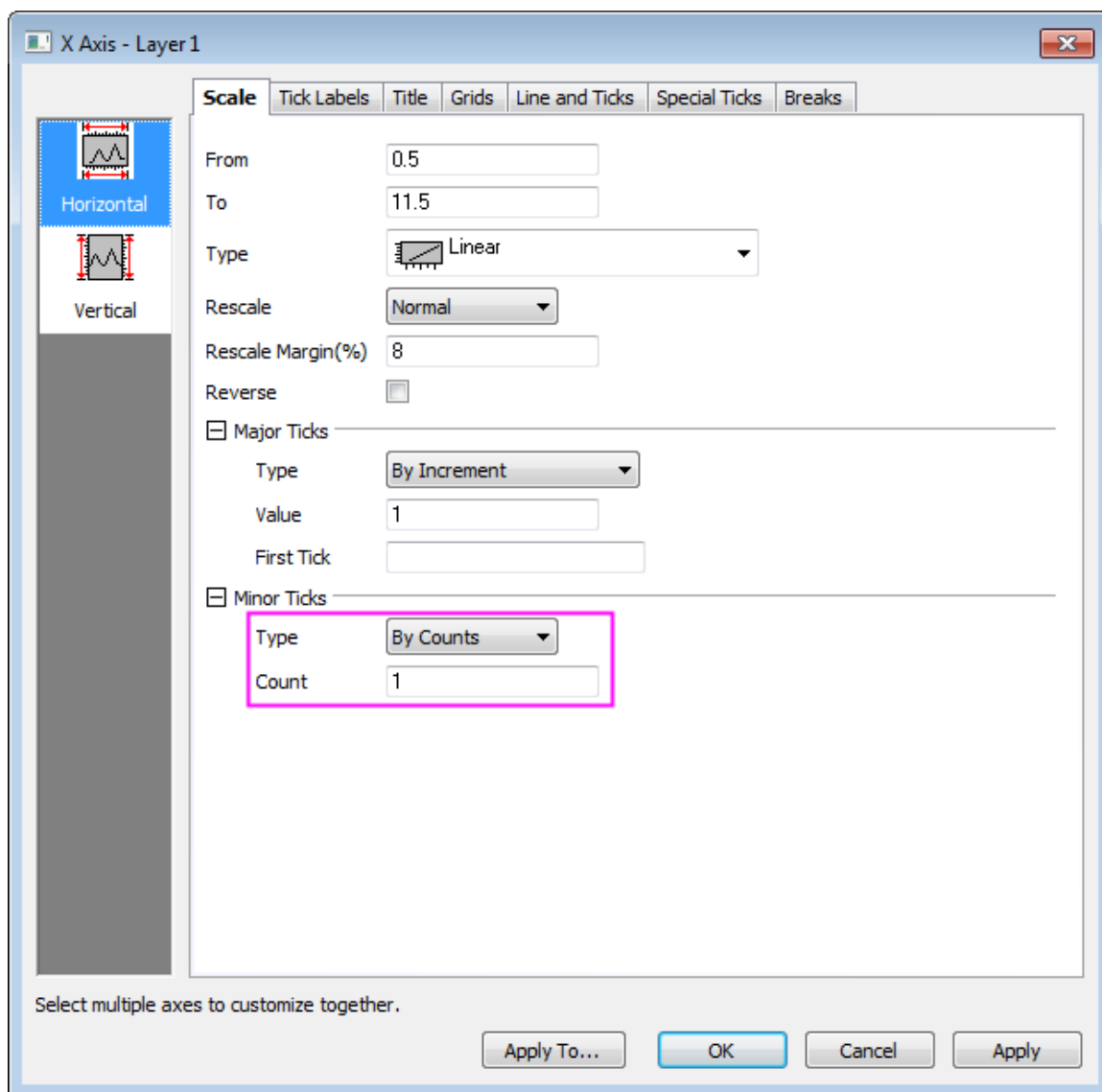

2. Go to the **Format** tab under **Tick Labels** page and hold Ctrl key to select both **Bottom** and **Left** icons on left panel and set label **Color** to **Black**.

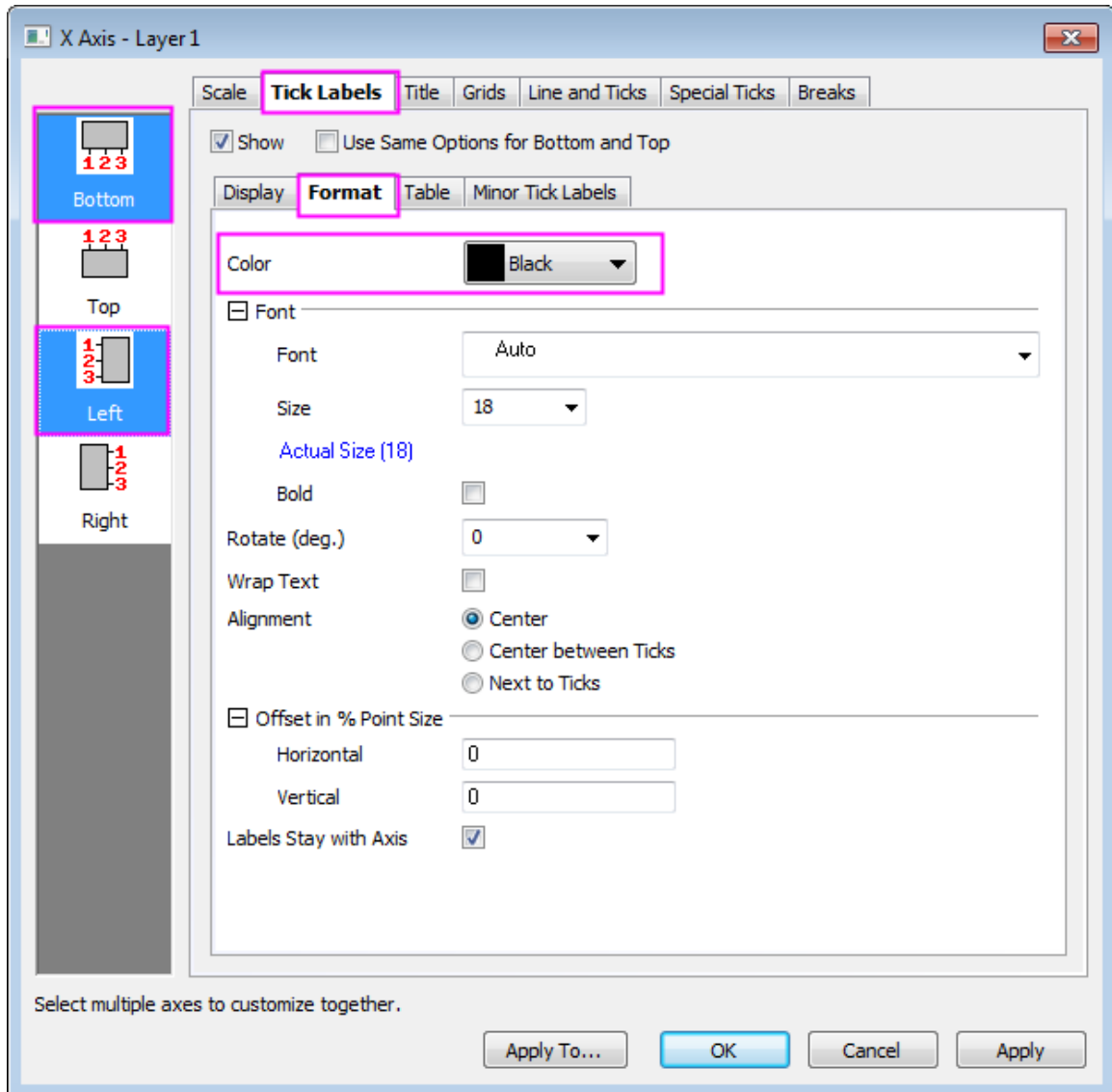

3. Go to the **Grids** tab and click to select only **Vertical** icon on left panel and duplicate **Minor Grid Lines** settings as shown below.

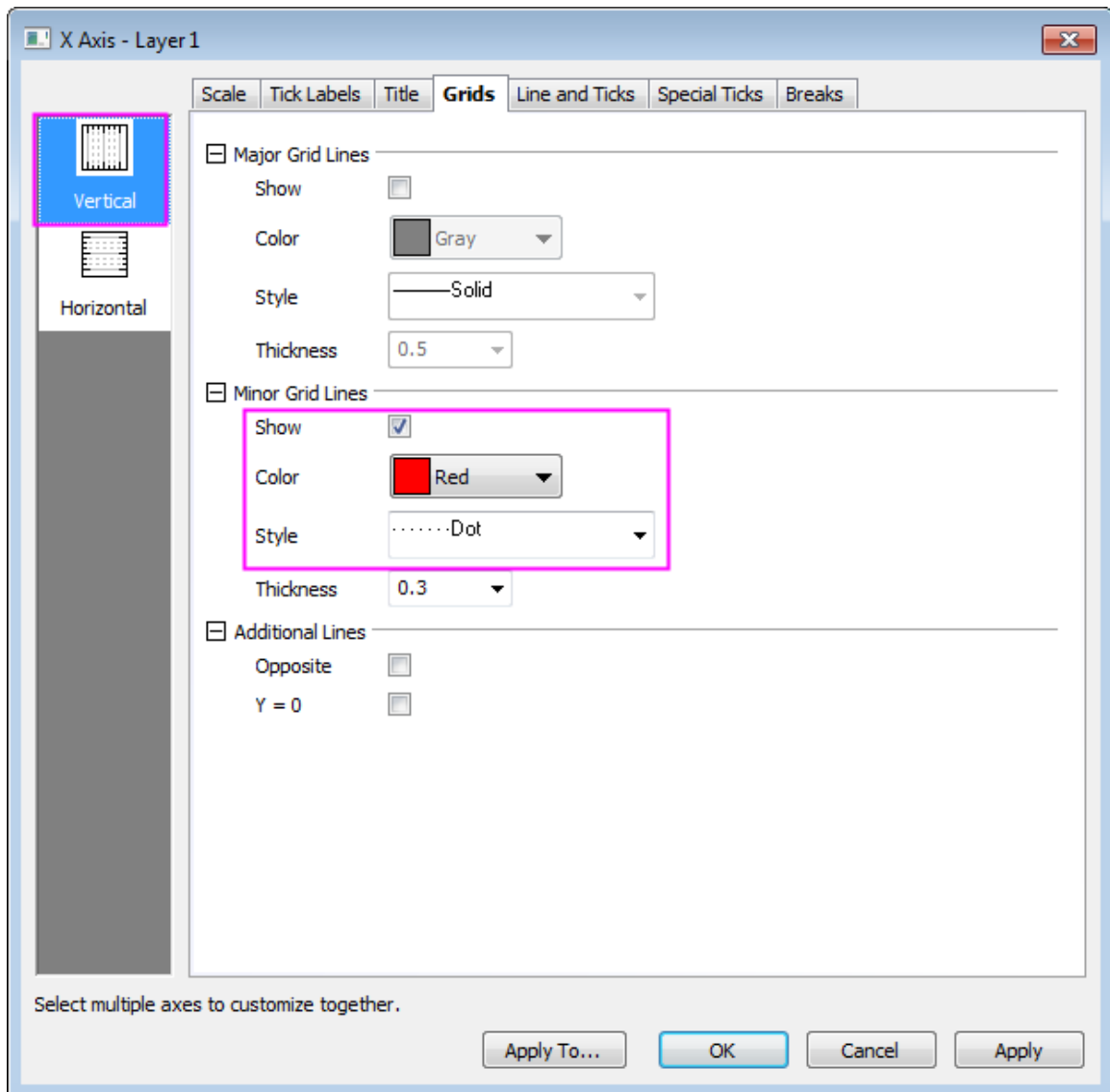

4. Go to **Line and Ticks** tab and click on the **Top** icon on left panel and check the **Show Line and Ticks** box to show top axis.
5. Hold Ctrl key to select both **Bottom** and **Top** icons on left panel, duplicate settings as shown below and click **Apply** to see your changes.

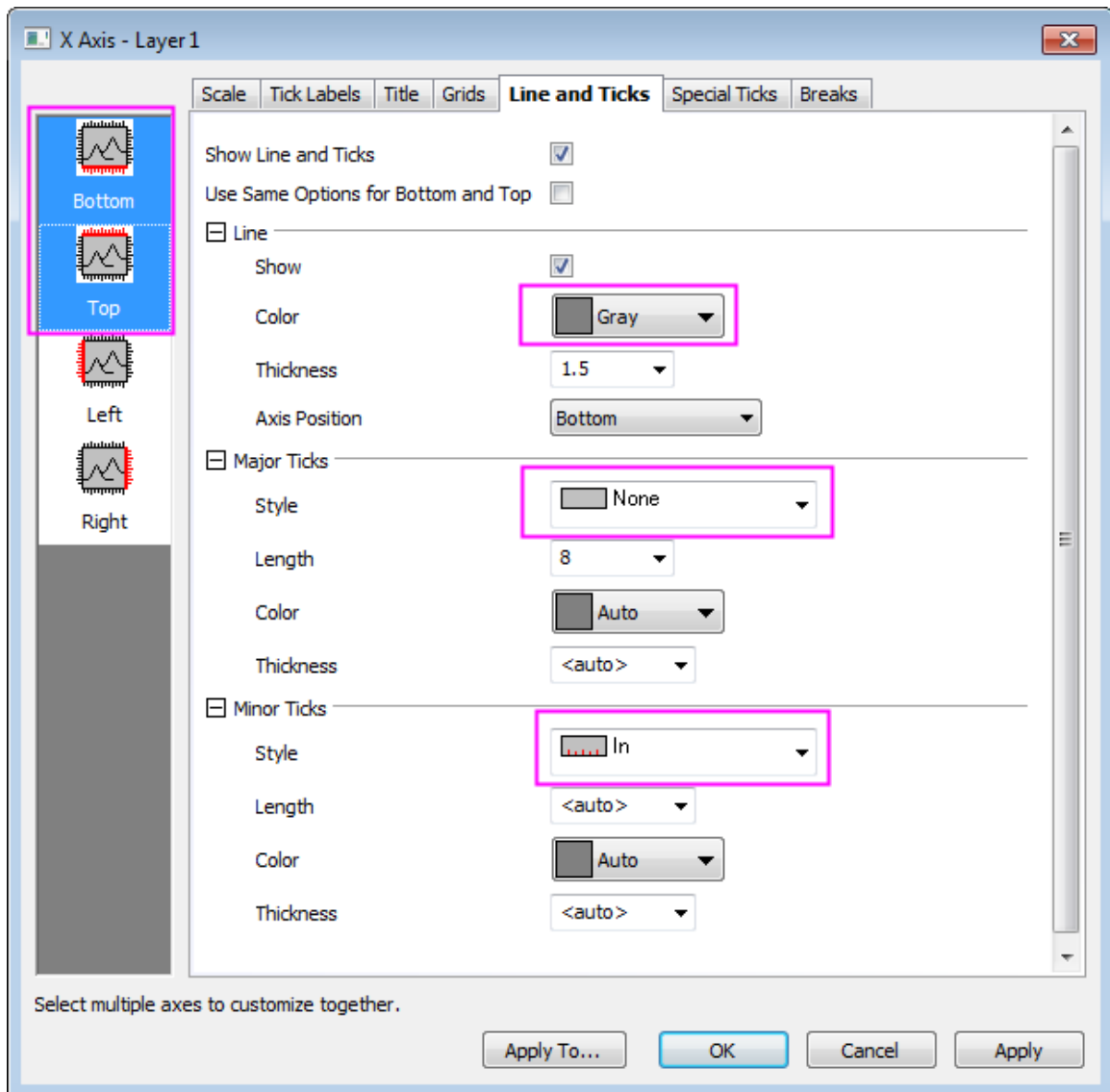

- To customize the Y Axis, go to **Scale** tab and click **Vertical** icon on left panel and duplicate the settings as shown below.

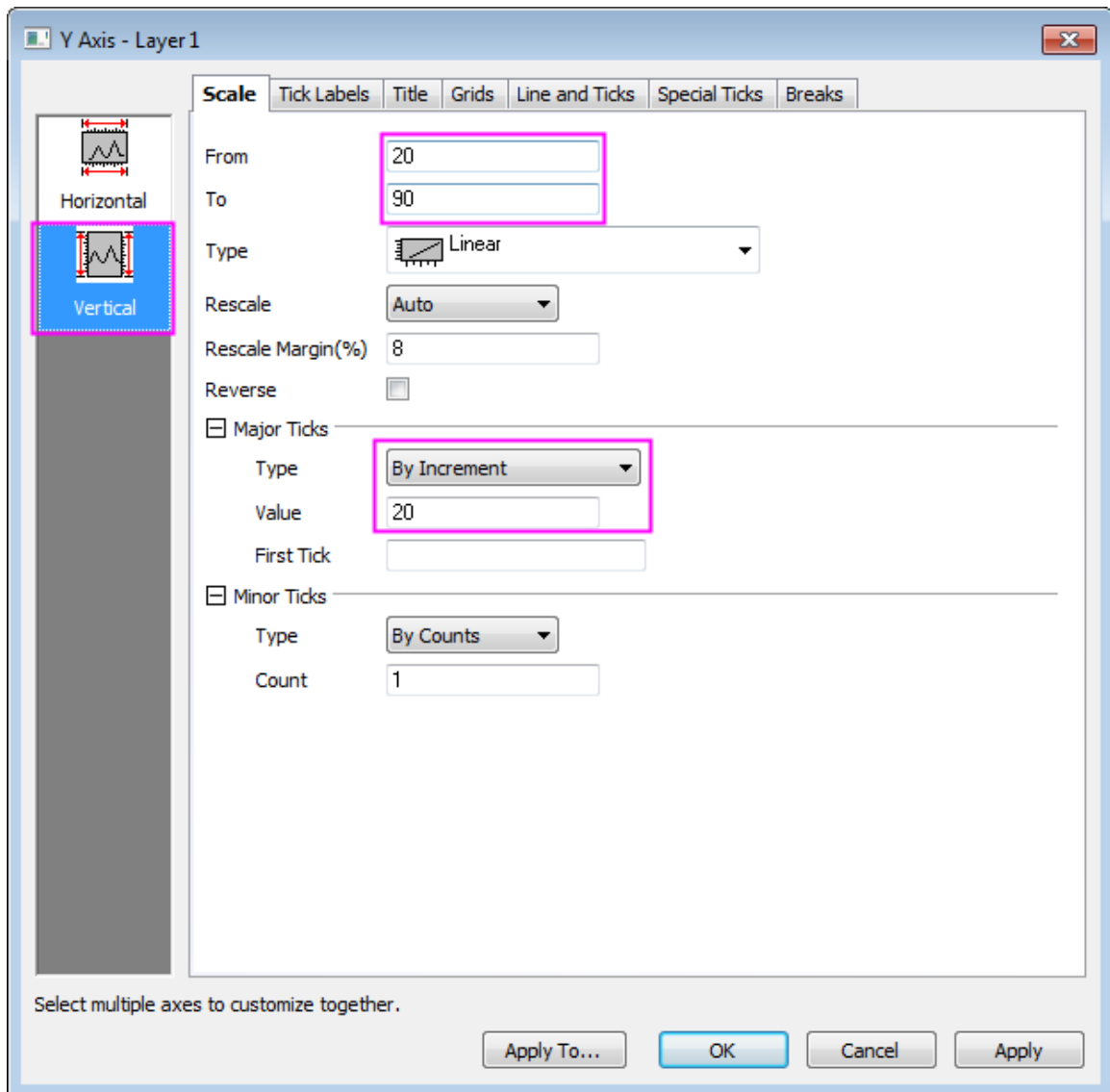

7. Go to the **Title** tab and type **Temperature (\+(o)F)** into the **Text** box.

8. Go to **Grids** tab and check the **Opposite** box under **Additional Lines** node.



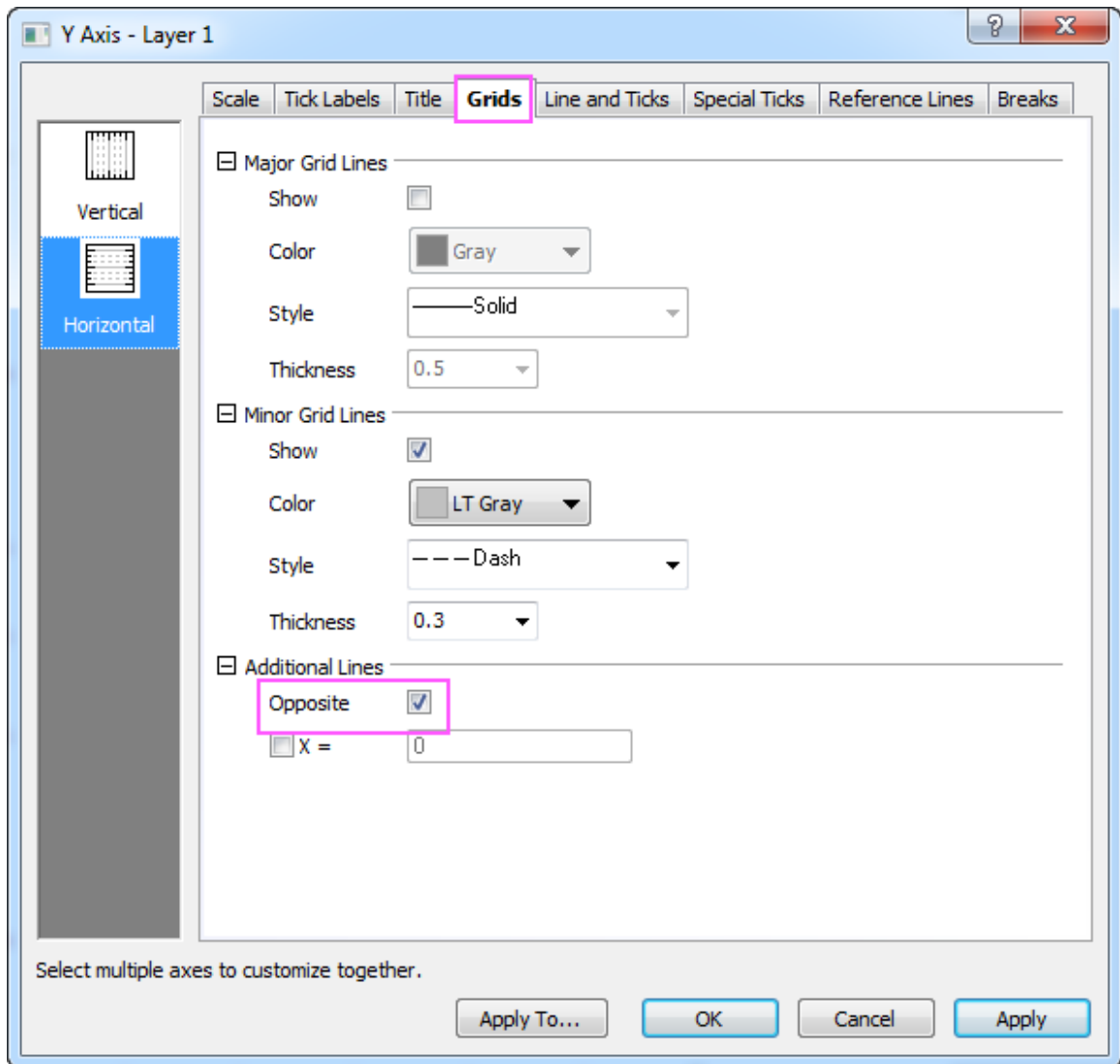

9. Go to **Line and Ticks** tab and set **Color** under **Line** node to be **Gray**.

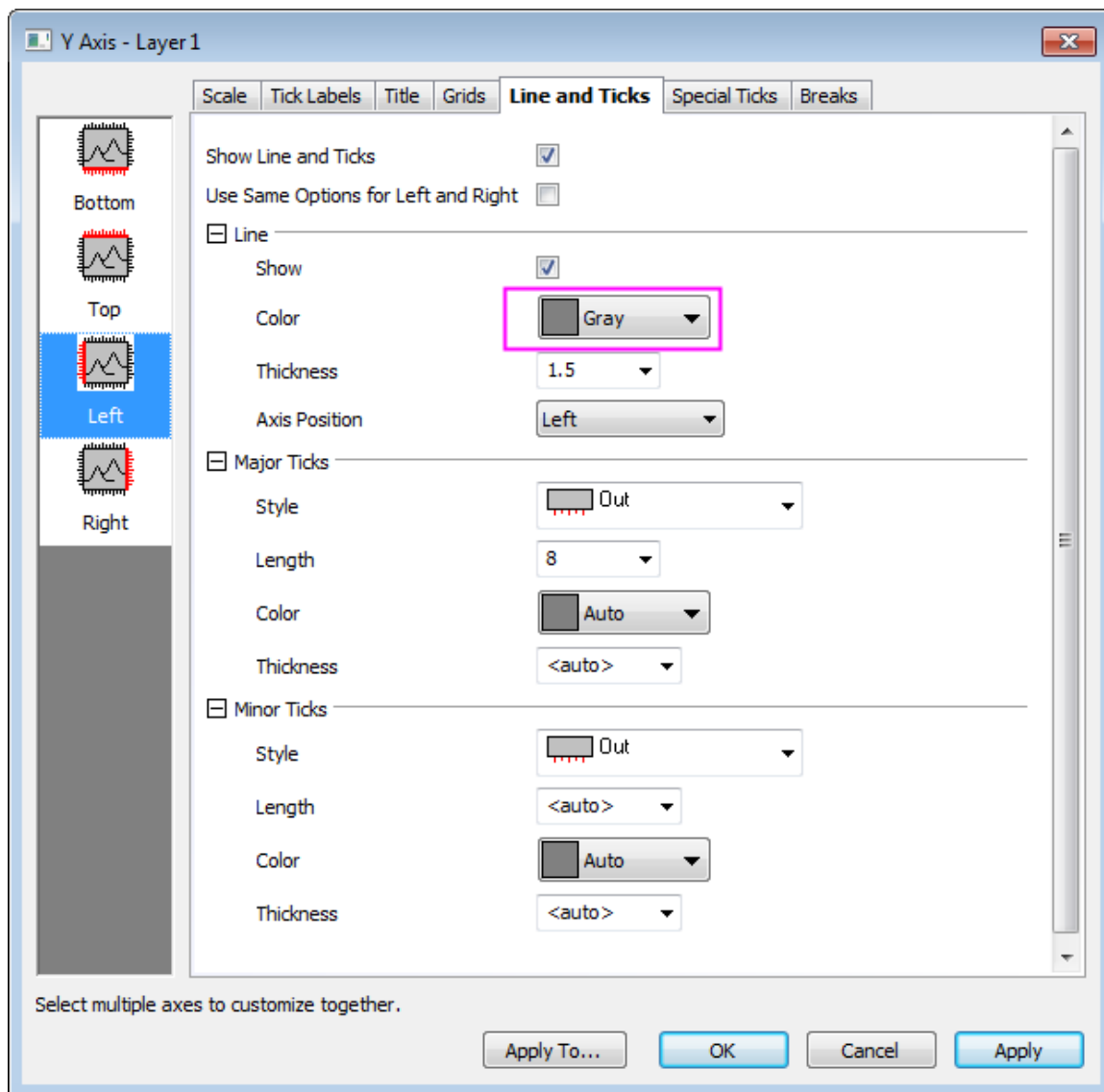

10. Click **OK** to apply your settings.

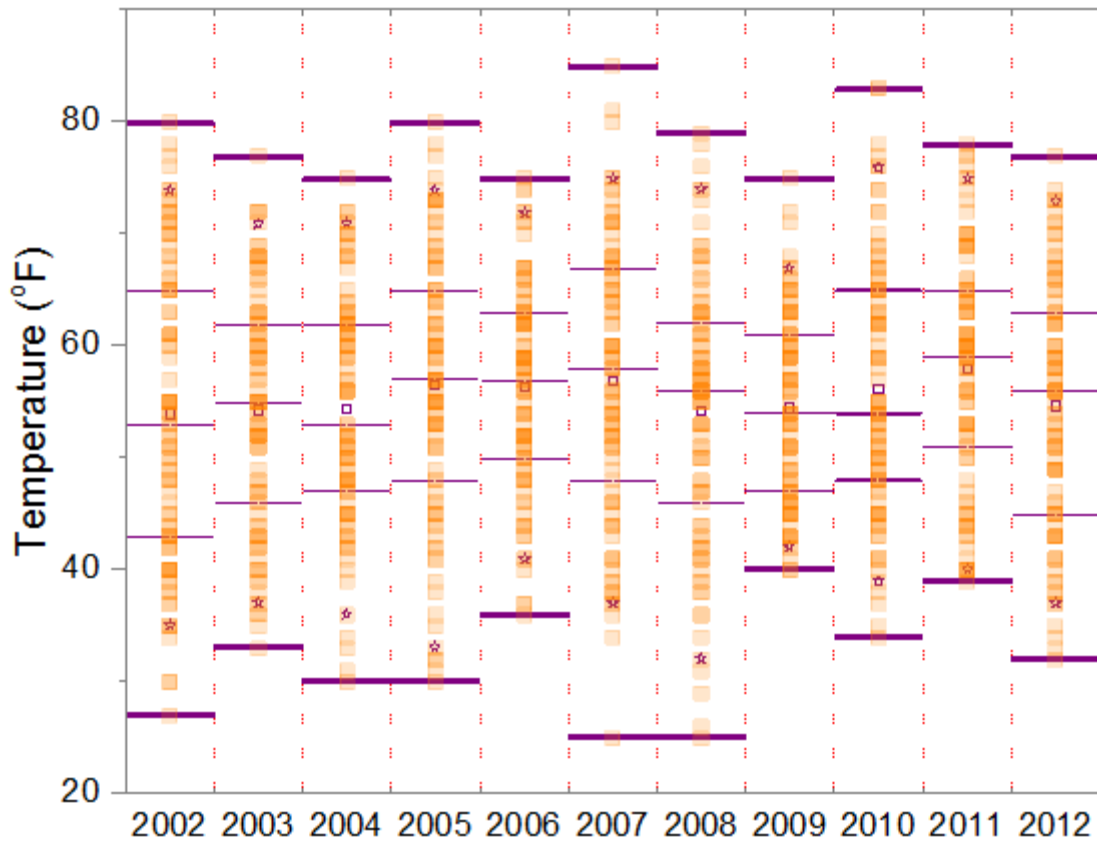

#### 6.11.4.6 Adding a Line to Mark the Mean

1. Highlight all the columns in Book1. The global mean value will be calculated automatically and shown on the Status bar.

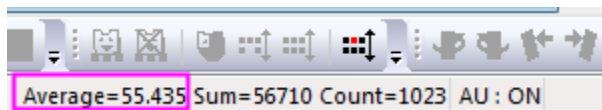

2. Activate the graph window and select **Insert: Straight Line** from the menu. In **addline** dialog, duplicate settings as shown below.

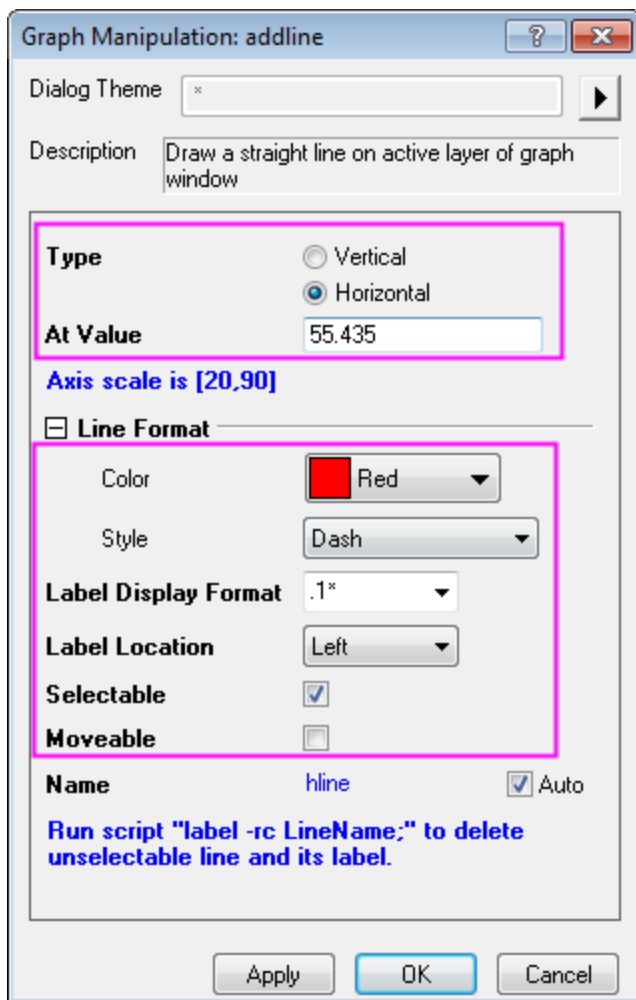

3. Right-click on an empty portion of the graph and select **Add/Modify Layer Title**. Type **Weather History for Boston, Fall (Sep, Oct, Nov)**
4. Drag and re-position the axis and layer titles as needed.



There are another two approaches to add such a horizontal line at specified Y value in **Axis** dialog:

- Go to the **Grid** tab, select **Vertical** in the left panel and then enter the Y value in the **Y=** text box under the Additional Lines branch. Please note, this option only adds the line, you need add a special tick or just a simple text object to mark this line.

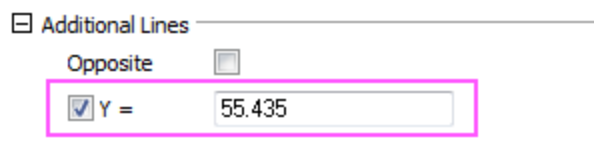

- Go to the **Reference Lines** tab, select **Horizontal** icon in left panel, add a reference line at  $Y=55.435$  with the label, click **Details** button to set the style of this line. You might need use the Style toolbar to change the color of the text label.



## 6.11.5 Marginal Distribution Curve

### 6.11.5.1 Summary

Graphs in Origin are highly customizable. This tutorial will show how to customize the marginal histogram to display distribution curves instead of columns.

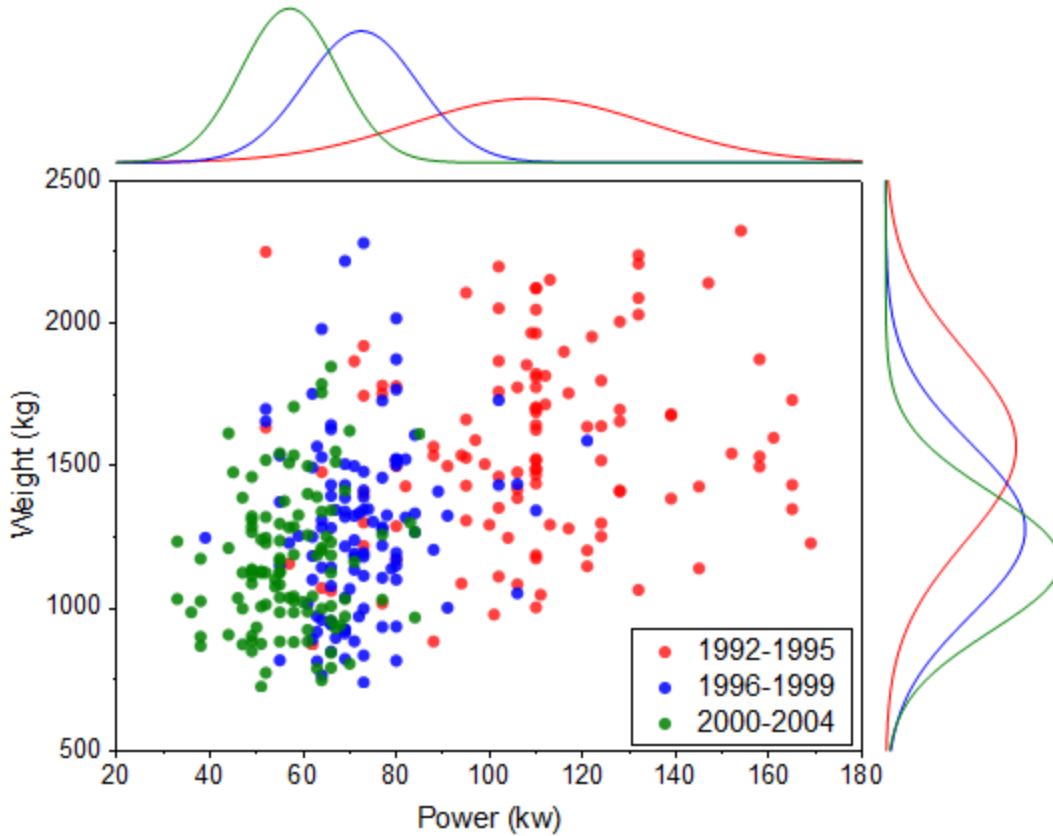

Minimum Origin Version Required: 2015 SR0

6.11.5.2 What you will learn

- Create marginal histogram
- Use filter lock to create plots with different filter conditions.
- Group plots manually

6.11.5.3 Steps to Use the Filter Lock

Origin9.1 includes a special feature that allows you to set up different data filters in a single source worksheet and to, for instance, graph data for each filter condition without destroying the previous plot. This is made possible by copying filtered data to a new sheet and placing a "filter lock" on the filtered data.

1. Import <Origin EXE Folder>\Samples\Statistics\automobile.dat to a new blank workbook.
2. Highlight col(A), right click and select **Filter: Add or Remove Filter**.
3. Click the filter icon in the column header and select **Between....**
4. In the **Between** dialog, set **From** to 1992, **To** to 1995 and press **OK**.
5. Highlight Col("Power") and Col("Weight"), right-click and select **Copy Columns to....**
  
6. In the **colcopy** dialog, enter **1992~1995!<new>** in the **Destination Columns** text box as shown below and click **OK**.

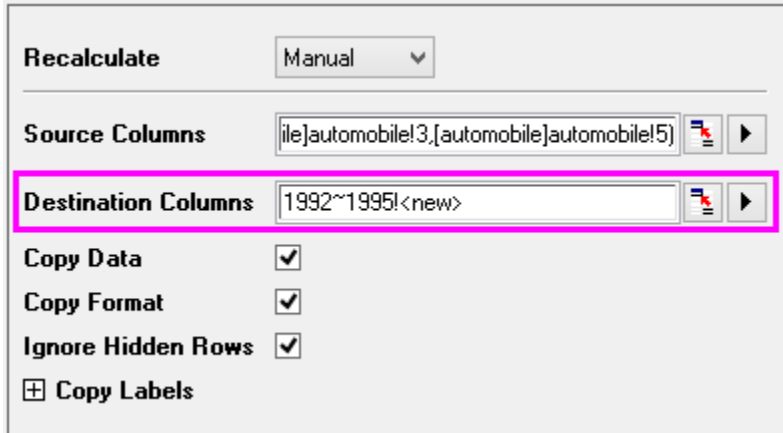

- In the newly created sheet, click the green lock in the Col(A) heading and select **Worksheet Filters: Lock**.

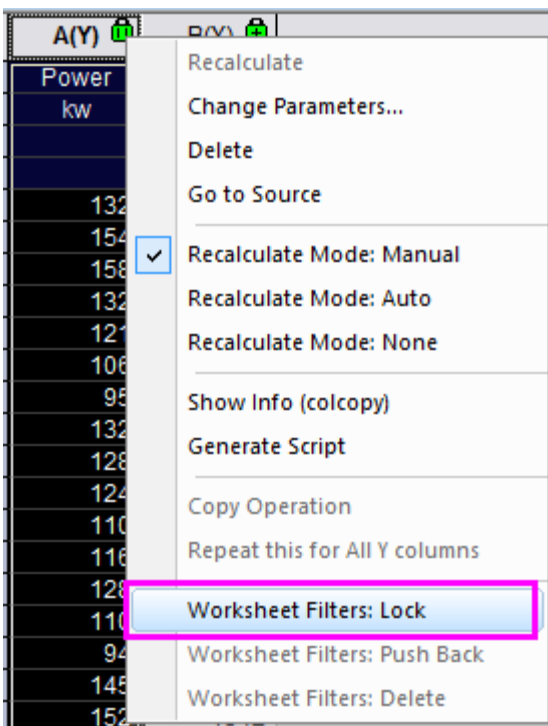

- Go back to the "automobile" sheet and repeat steps 4~7 twice more with Col("Year")'s filter conditions set to 1996~1999 and 2000~2004, respectively. You need to type a sheet name in **colcopy** dialog manually each time. The filter conditions are locked with each sheet, you can push them back using **Worksheet Filters: Push Back**.

#### 6.11.5.4 Steps to Create a Plot with Marginal Distribution Curves

- Go to sheet "1992~1995", highlight all columns and select **Plot > Statistical: Marginal Histograms**

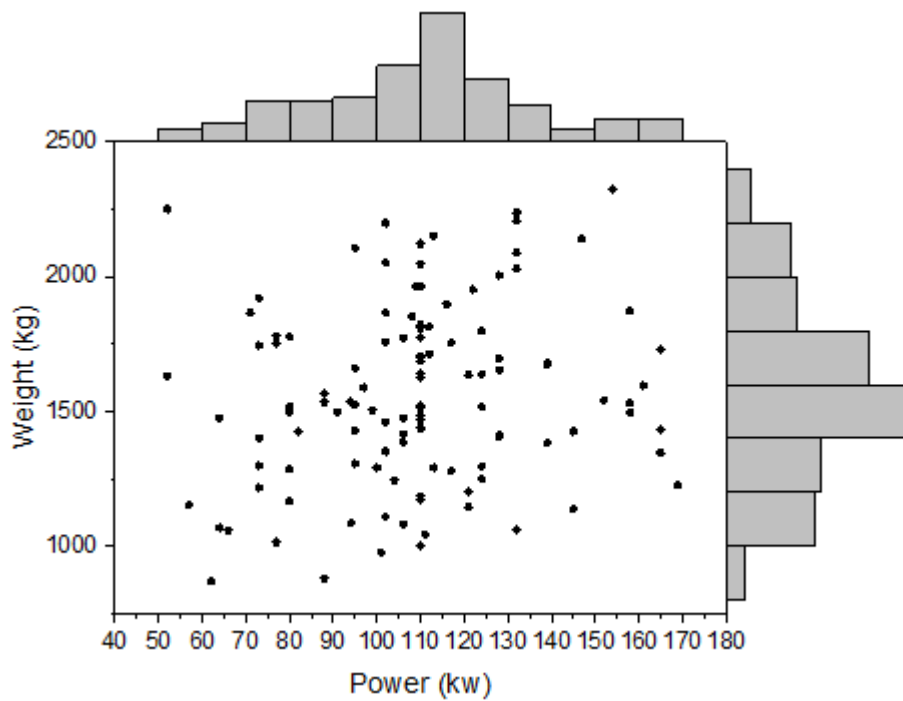

2. Double-click any on any bar in the top histogram to open the **Plot Details** dialog. Go to the **Data** tab and set **Distribution Curve: Type** as **Normal**. This is for **Layer 2**.

Pattern Spacing Data Line

Type: Dots

Jitter Points

Single Block Barplot

Snap Points To Bin

Automatic Binning

Bin Size: 10

Number of Bins: 13

Begin: 50

End: 180

Bin Height (0-100): 100

Bin Worksheet

Add Distribution Curves

Go

Distribution Curve

Type: Normal

Scale to Maximum (%)

Bins Alignment

Center

Right

Left

Data Width (%): Auto

Preview

The Counts column in the Bin Worksheet can be used for fitting.



3. Go to the **Pattern** tab and reproduce the settings shown below to hide bin bars.

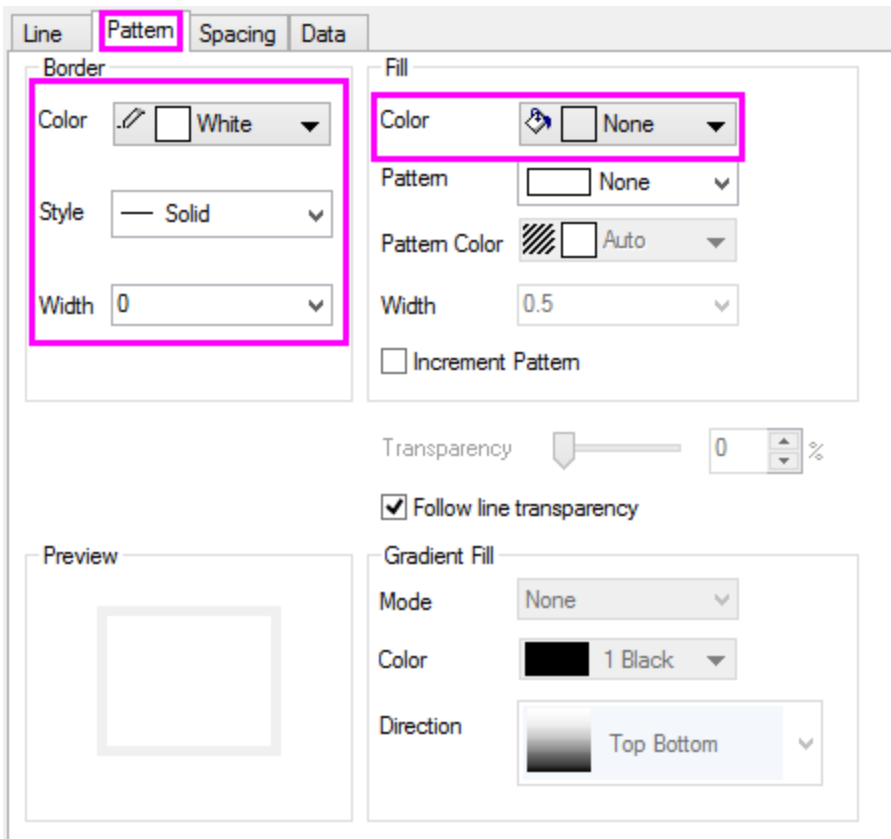

4. Go to the **Line** tab and set **Color** to Black. Click **Apply** to see the changes.

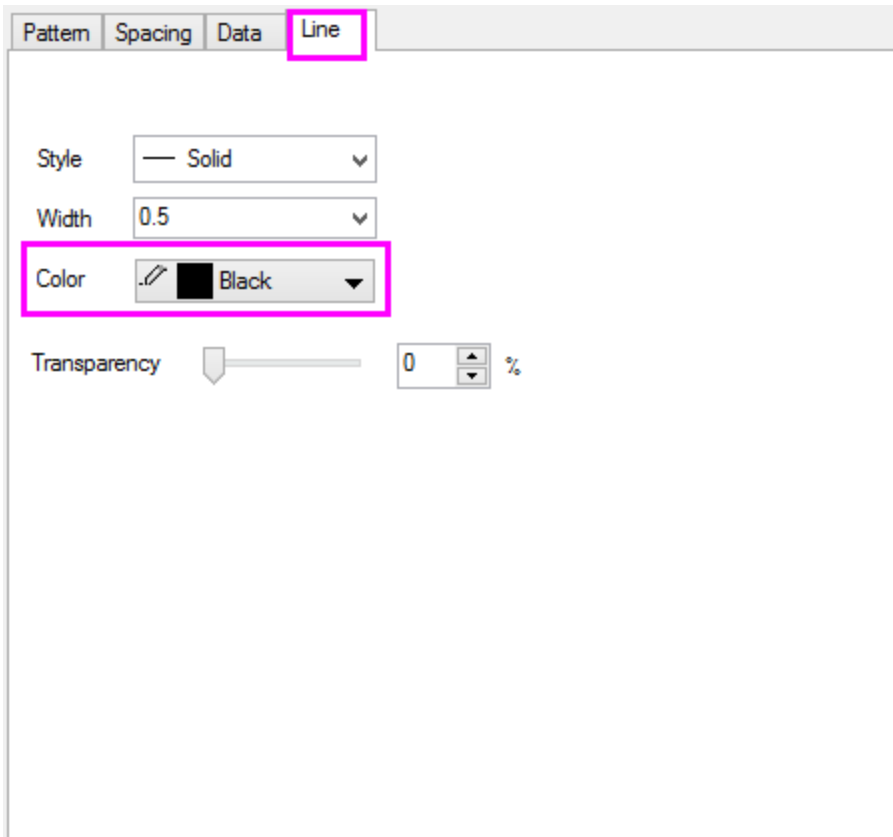

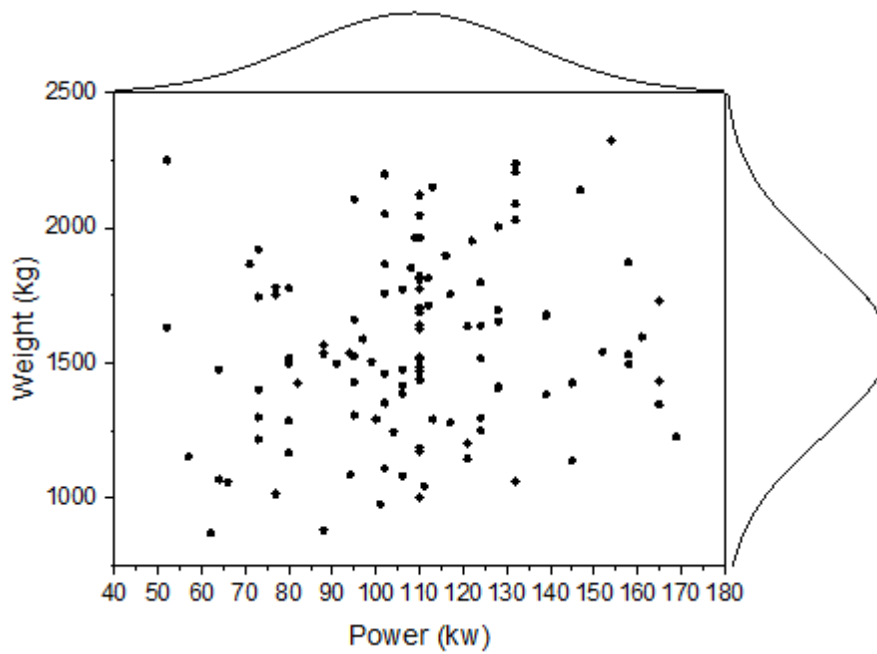

5. Repeat steps 2~4 for Layer3 (right histogram).



6.11.5.5 Steps to Plot Grouped Marginal Distribution Curves

1. Select **Graph: Plot Setup** from menu.



In order to show all three panels in **Plot Setup** dialog, please expand **Plot Type** panel by clicking  and expand **Available Data** panel by clicking  again.

Please refer to [Plotting using Plot Setup](#) for more information.

2. Select **Layer 1** in lower panel. Set controls as shown below and click **Add**.

Available Data:

Worksheets in Folder

Include Shortcuts

Right-click on various panels to bring up context menus.

Long Name	Sheet	Cols	Rows	File Name	File Date	Created	Modified
automobile.d automobile	automobile	7	360	automobile.dat	9/4/2014	9/5/2014 17:53:18	9/5/2014
automobile.d 1992~1995	1992~1995	2	360	automobile.dat	9/4/2014	9/5/2014 17:53:18	9/5/2014
automobile.d 1996~1999	1996~1999	2	360	automobile.dat	9/4/2014	9/5/2014 17:53:18	9/5/2014
automobile.d 2000~2004	2000~2004	2	360	automobile.dat	9/4/2014	9/5/2014 17:53:18	9/5/2014

Plot Type:

Show(S) [automobile]1996~1999

X	Y	yEr	L	Column	Long Name	Comments	Sampling Interval	Position
<input type="checkbox"/>	<input type="checkbox"/>	<input type="checkbox"/>	<input type="checkbox"/>	<autoX>	From/Step=			0
<input checked="" type="checkbox"/>	<input type="checkbox"/>	<input type="checkbox"/>	<input type="checkbox"/>	A	Power			1
<input type="checkbox"/>	<input checked="" type="checkbox"/>	<input type="checkbox"/>	<input type="checkbox"/>	B	Weight			2

Plot List: Drag entries in 1st column to reorder or to move between layers. Right click for other options.

Replace **Add**

Plot	Range	Show	Plot Type	Legend
Layer 1	Res	<input checked="" type="checkbox"/>		
[automobile.dat]1992~1995! "Power"[X], "Weight"[Y]	[1*:116*]	<input checked="" type="checkbox"/>	Scatter	Weight
Layer 2	Res	<input checked="" type="checkbox"/>		
Layer 3	Res	<input checked="" type="checkbox"/>		

3. Add the "Power" histogram to layer2.

The screenshot shows the Origin software interface. At the top, the 'Available Data' table lists several data sheets. The sheet 'automobile.d 1996~1999' is selected. Below this, the 'Plot Type' dropdown menu is open, and 'Histogram' is selected. The 'Plot List' dialog box is also visible, showing a list of plots for Layer 1, Layer 2, and Layer 3. The 'Add' button is highlighted.

Long Name	Sheet	Cols	Rows	File Name	File Date	Created	Modifie
automobile.c automobile	7	360	automobile.dat	11/11/2013	11/11/2013 14:39:25	11/11/	
automobile.c 1992~1995	2	360	automobile.dat	11/11/2013	11/11/2013 14:39:25	11/11/	
automobile.d 1996~1999	2	360	automobile.dat	11/11/2013	11/11/2013 14:39:25	11/11/	
automobile.c 2000~2004	2	360	automobile.dat	11/11/2013	11/11/2013 14:39:25	11/11/	

Column	Long Name	Comments	Sampling Interval	Position
<input checked="" type="checkbox"/>	A	Power		1
<input type="checkbox"/>	B	Weight		2

Plot	Range	Show	Plot Type	Legend
Layer 1	<input type="checkbox"/> Rescale	<input checked="" type="checkbox"/>		
[automobile.dat]1992~1995! "Power"(X), "Weight"(Y)	[1*:116*]	<input checked="" type="checkbox"/>	Scatter	Weight
[automobile.dat]1996~1999! "Power"(X), "Weight"(Y)	[1*:112*] 39 < X < 121 , 739 < Y < 2281	<input checked="" type="checkbox"/>	Scatter	Weight
Layer 2	<input type="checkbox"/> Rescale	<input checked="" type="checkbox"/>		
[automobile.dat]1992~1995! "Power"(Y)	[1*:116*]	<input checked="" type="checkbox"/>	Histogram	Power
Layer 3	<input type="checkbox"/> Rescale	<input checked="" type="checkbox"/>		
[automobile.dat]1992~1995! "Weight"(Y)	[1*:116*]	<input checked="" type="checkbox"/>	Histogram	Weight

4. Add the "Weight" histogram to Layer3.
5. Repeat steps 2~4, to add 2000~2004 data to each layer. The plot list should look like the following.

The screenshot shows the 'Plot List' dialog box with the updated plot list. The 'Add' button is highlighted.

Plot	Range	Show	Plot Type	Legend
Layer 1	<input type="checkbox"/> Rescale	<input checked="" type="checkbox"/>		
[automobile.dat]1992~1995! "Power"(X), "Weight"(Y)	[1*:116*]	<input checked="" type="checkbox"/>	Scatter	Weight
[automobile.dat]1996~1999! "Power"(X), "Weight"(Y)	[1*:112*] 39 < X < 121 , 739 < Y < 2281	<input checked="" type="checkbox"/>	Scatter	Weight
[automobile.dat]2000~2004! "Power"(X), "Weight"(Y)	[1*:112*] 33 < X < 85 , 724 < Y < 1847	<input checked="" type="checkbox"/>	Scatter	Weight
Layer 2	<input type="checkbox"/> Rescale	<input checked="" type="checkbox"/>		
[automobile.dat]1992~1995! "Power"(Y)	[1*:116*]	<input checked="" type="checkbox"/>	Histogram	Power
[automobile.dat]1996~1999! "Power"(Y)	[1*:112*] 39 < Y < 121	<input checked="" type="checkbox"/>	Histogram	Power
[automobile.dat]2000~2004! "Power"(Y)	[1*:112*] 33 < Y < 85	<input checked="" type="checkbox"/>	Histogram	Power
Layer 3	<input type="checkbox"/> Rescale	<input checked="" type="checkbox"/>		
[automobile.dat]1992~1995! "Weight"(Y)	[1*:116*]	<input checked="" type="checkbox"/>	Histogram	Weight
[automobile.dat]1996~1999! "Weight"(Y)	[1*:112*] 739 < Y < 2281	<input checked="" type="checkbox"/>	Histogram	Weight
[automobile.dat]2000~2004! "Weight"(Y)	[1*:112*] 724 < Y < 1847	<input checked="" type="checkbox"/>	Histogram	Weight

6. Click **OK** to close the **Plot Setup** dialog box and rescale the graph.

6.11.5.6 Steps to Group the Plots

1. Right-click the layer icon **1** at the upper-left corner of the graph window and select **Layer Contents....**
2. Highlight all three plots and click **Group**, then click **OK**.

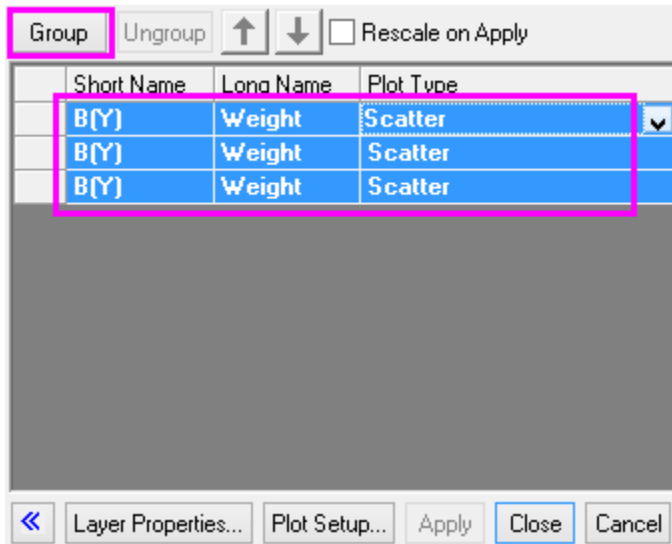

3. Repeat step 2 for layer2 and layer3.

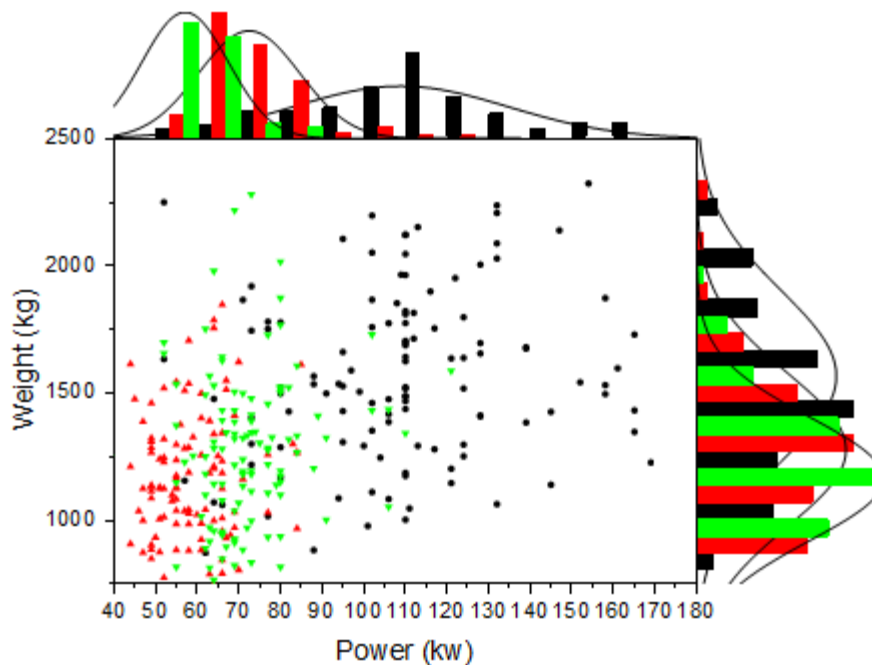
6.11.5.7 Steps to Further Customization

1. Double click the bottom axis to open the **Axis Dialog** for layer 1, then go to the **Scale** tab, and set the axis scale for the **Horizontal**(X axis) and **Vertical**(Y axis) as below respectively:

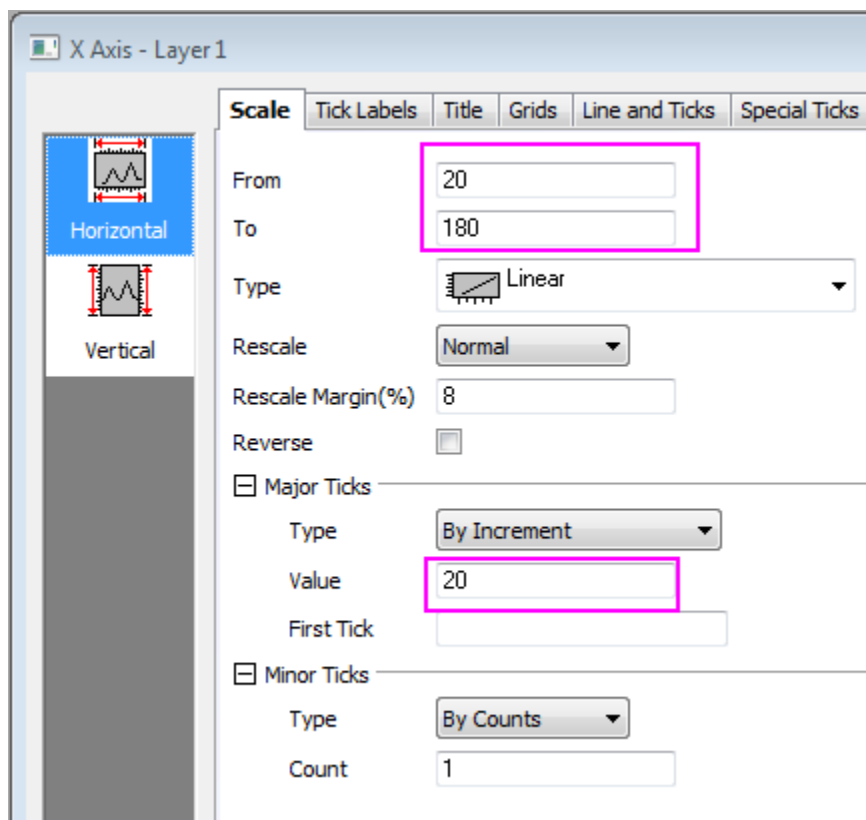

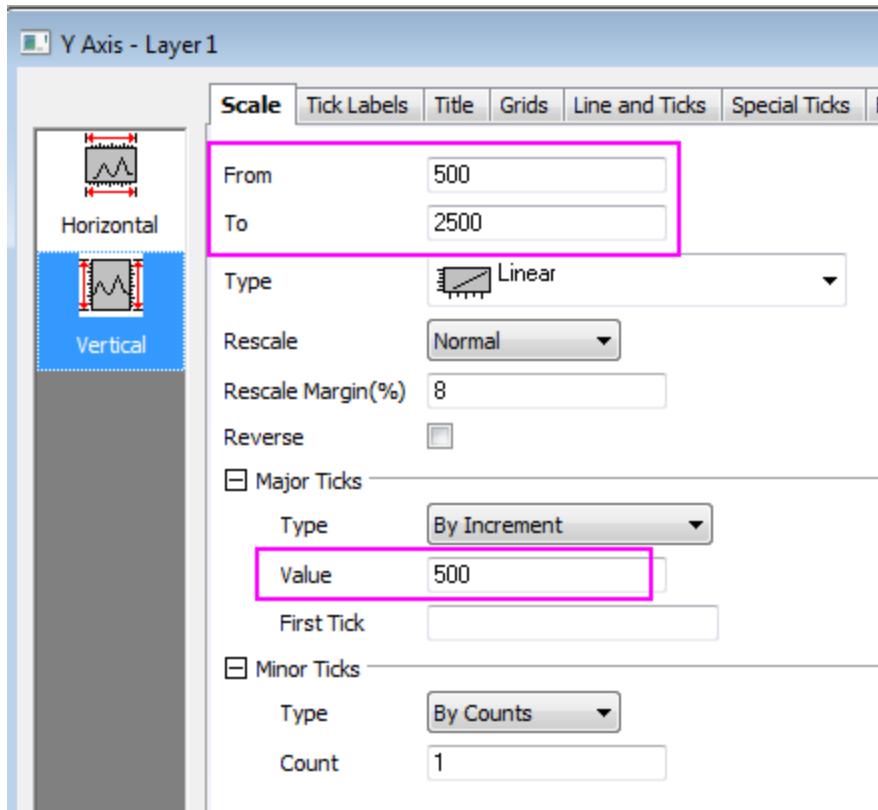

- Click **OK** to close axis dialog. Double click on the graph to open the **Plot Details** dialog box and select the first dataplot in **layer 1** to go to **Group** tab. Set **Symbol Type** as **None** and duplicate the following settings:

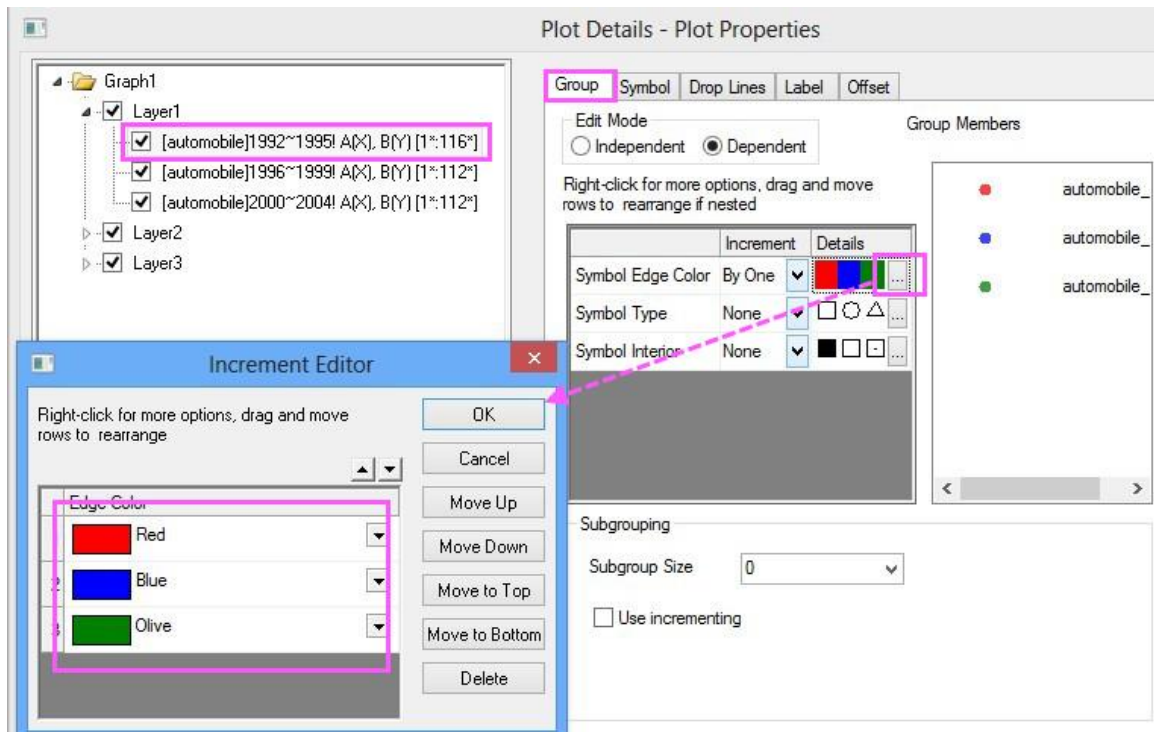

3. Click **Ok** to close the dialog. Go to the **Symbol** tab and duplicate the following settings.

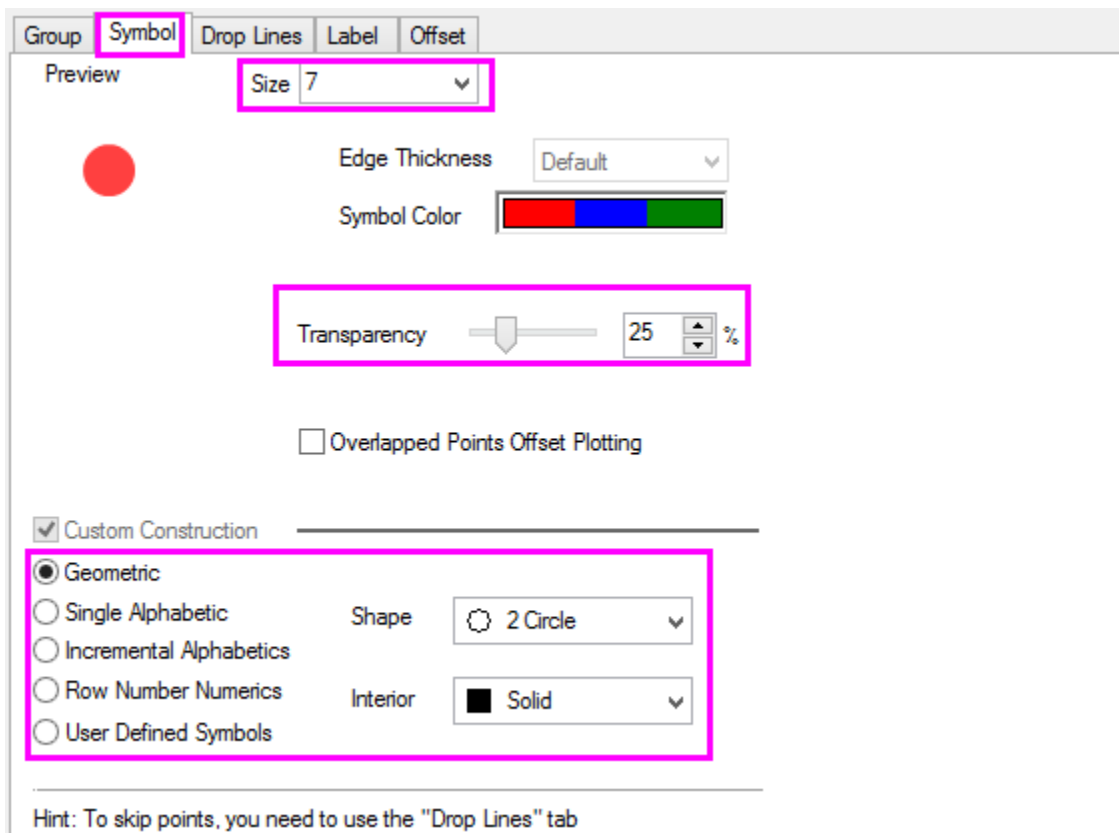

4. Go to **Layer 2, Data** tab and set the bin scale to be the same as the X scale, then click **Apply**.



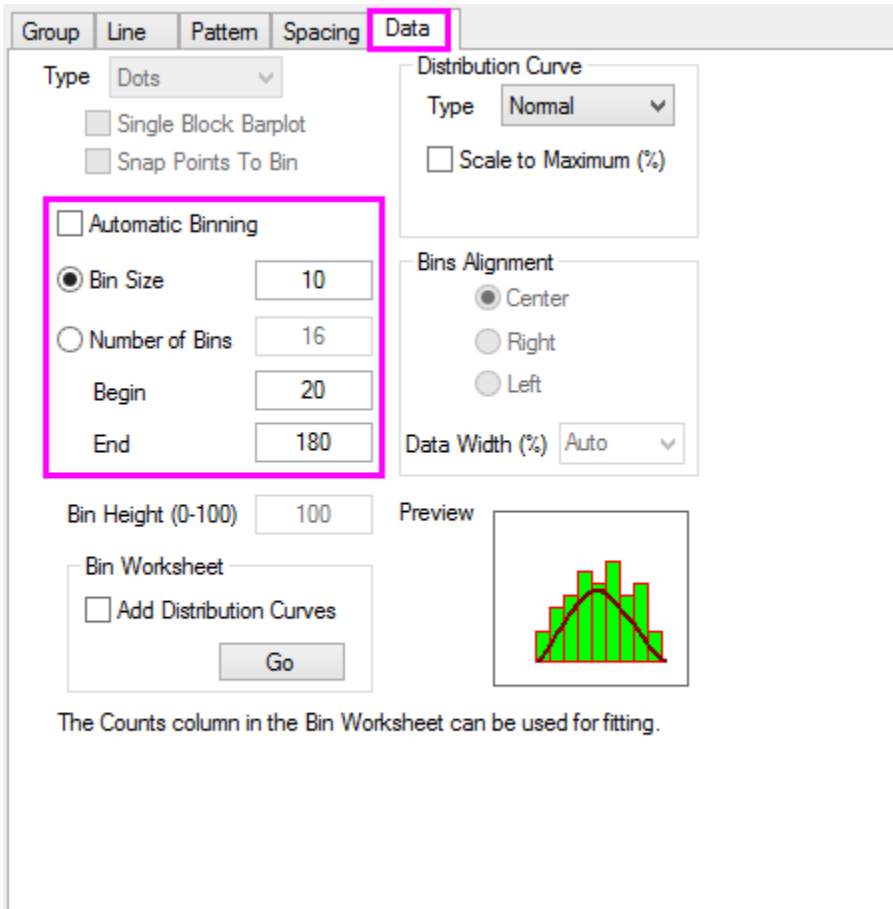

5. Go to the **Group** tab for plots in Layer 2 and set the **Edit Mode** to **Independent** so that we can individually customize the plot styles, click **Apply**.

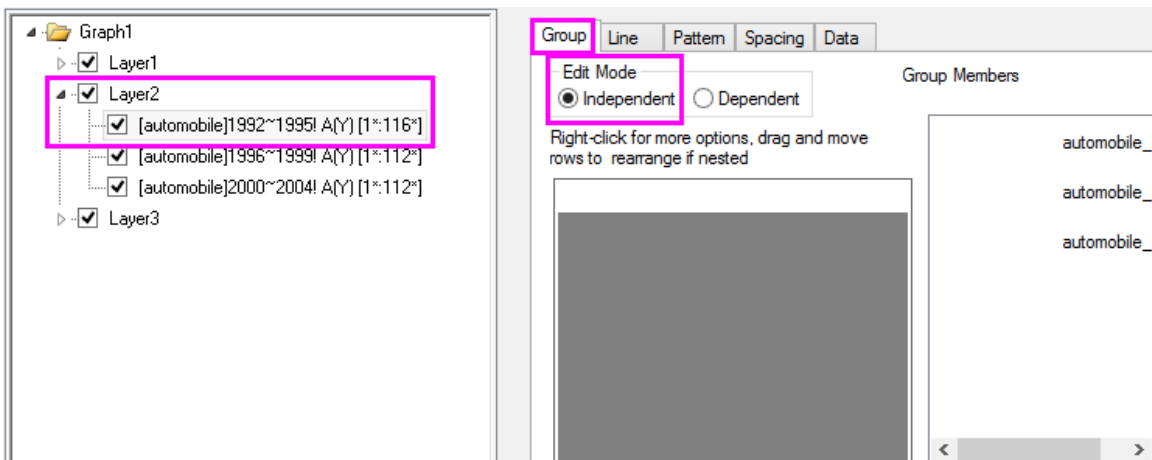

6. Go to the **Pattern** tab and hide bars for all three dataplots in Layer2 as what we did in [Steps to Create a Plot with Marginal Distribution Curves, Step3](#).
7. Go to **Line** tab of the 1992~1995 data plot and set as below.

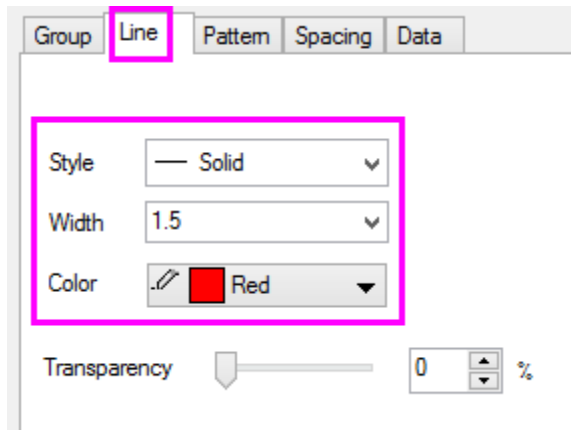

8. Repeat step 7 for the other two plots in Layer2 and set line color to the corresponding symbol color in Layer1.
9. Repeat steps 5~8 for Layer3, click **OK** to close **Plot Details** dialog and apply settings.
10. Activate Layer1 and select **Graph: Legend: Data Plots** from the menu.
11. Right click the legend object and click **Properties...**, set **Background** to **Black Line**, and font Size to be **18**. Click **OK**.
12. Use **Format: Page** to open the **Plot Details - Page Properties** dialog, go to **Legends/Titles** tab and set as the following so that worksheet name will be used as legend text:

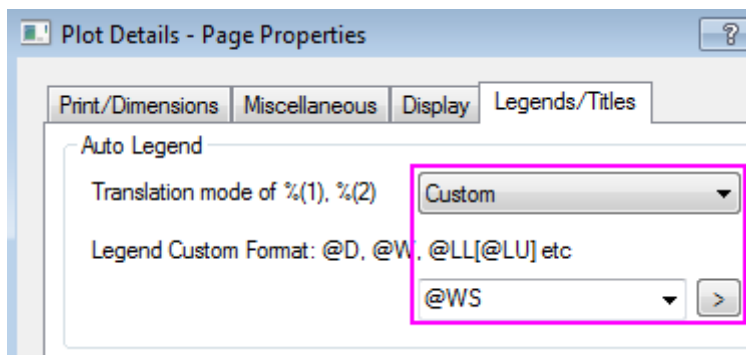

13. Drag and move the legend to a new position as needed. At this stage the graph should look like below:

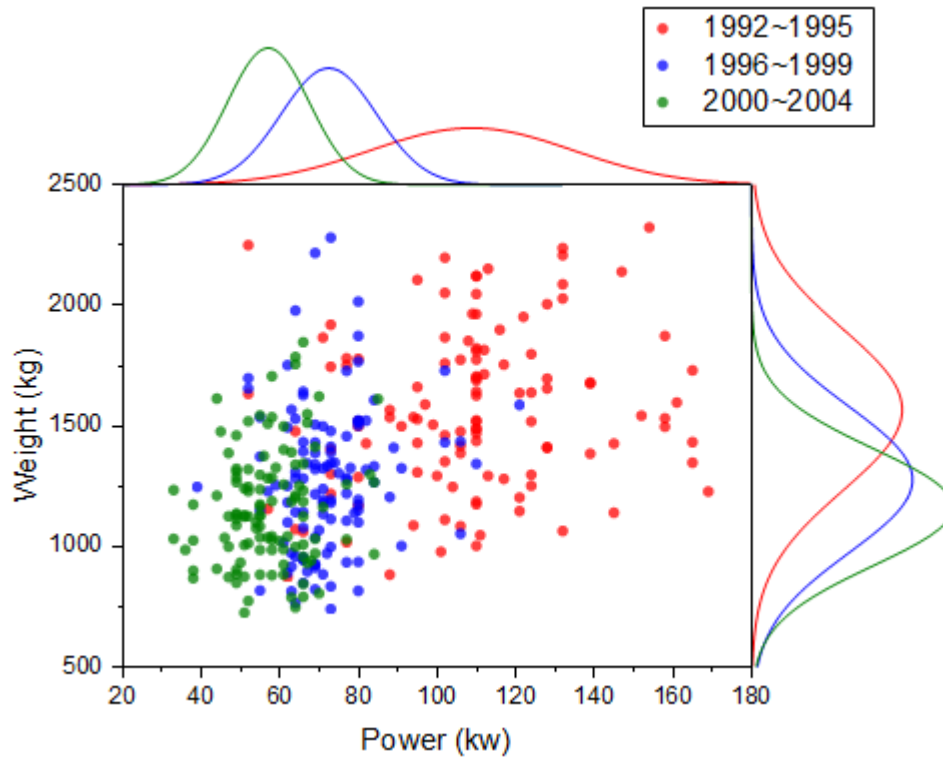

#### 6.11.5.8 Steps to Reposition the Graph Layers

1. Double click bottom axis to open **Axis Dialog** for layer 1, go to the **Grids** tab, hold **Ctrl** key to multiple select **Vertical** and **Horizontal** icon and set the following:

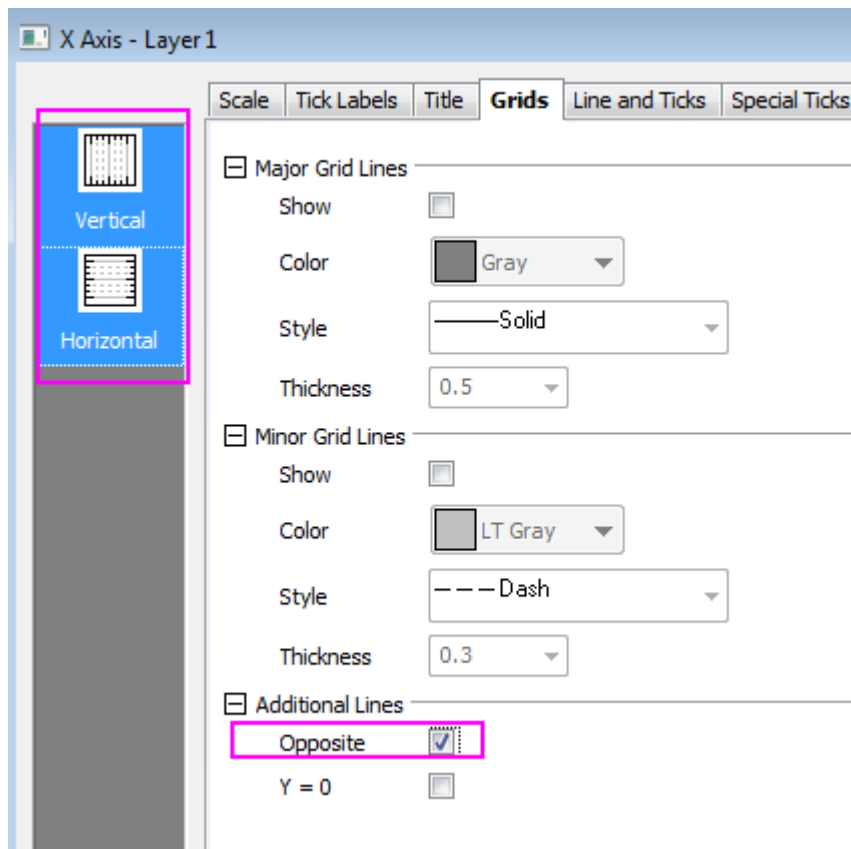

2. Click **OK** to close dialog. Open the **Axis Dialog** for layer 2. Go to the **Line and Ticks** tab, make sure **Bottom** axis icon is selected and clear the **Show Line and Ticks** check box to hide the bottom axis line. Do the same for the axis line of **Left** in layer 3.
  
3. Open the **Layer Management** dialog box, highlight Layer2 then go to the **Size/Position** tab, select **Move** and set **Top** to be -35. Click **Apply**.

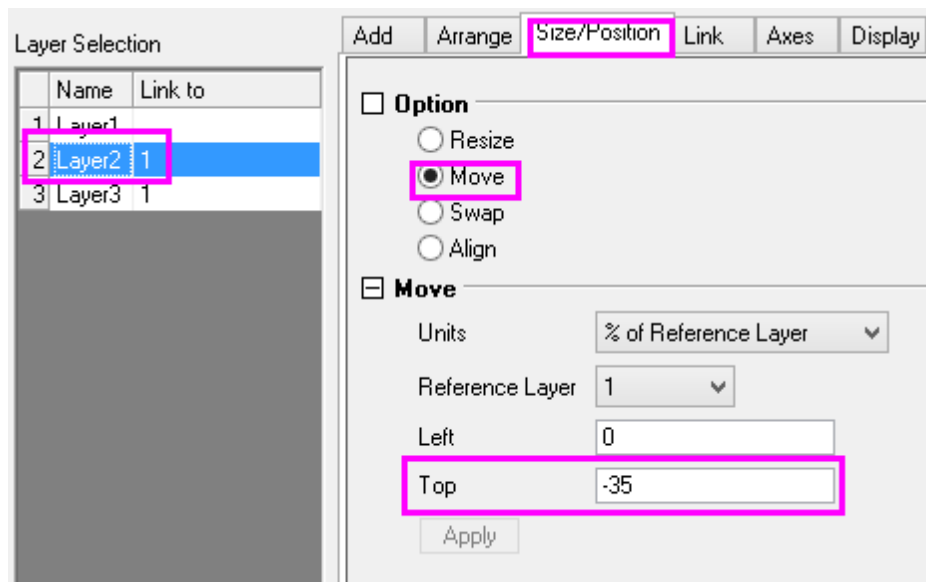

- Set **Left** for Layer3 to be 102. Click **Apply**. Then click **OK** to close the dialog box.

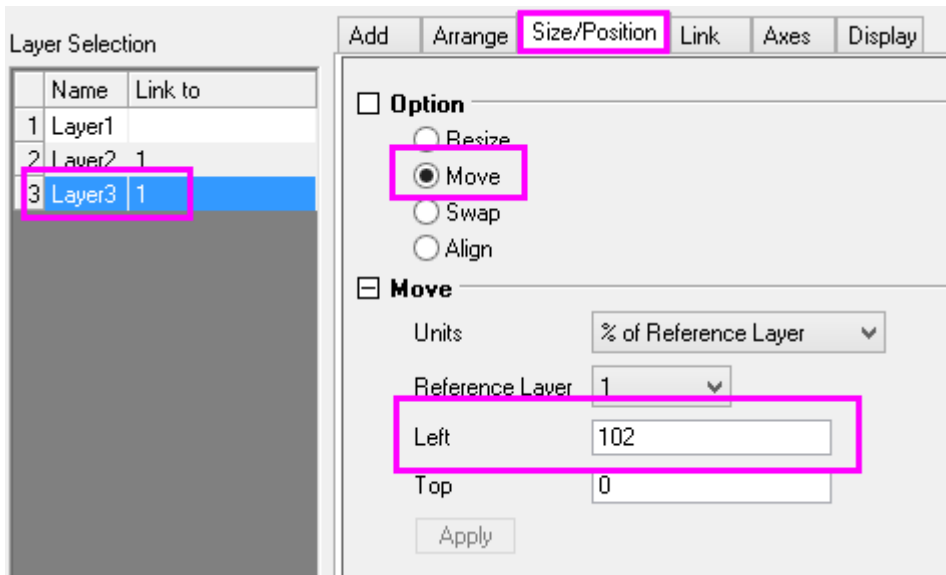

### 6.11.6 Overlapping Box Chart

#### 6.11.6.1 Summary

All Origin graphs are created from a graph template. Templates serve to recall previous customizations but they also serve as a starting point for new customizations. This tutorial will show you how to create the following highly-customized box chart:

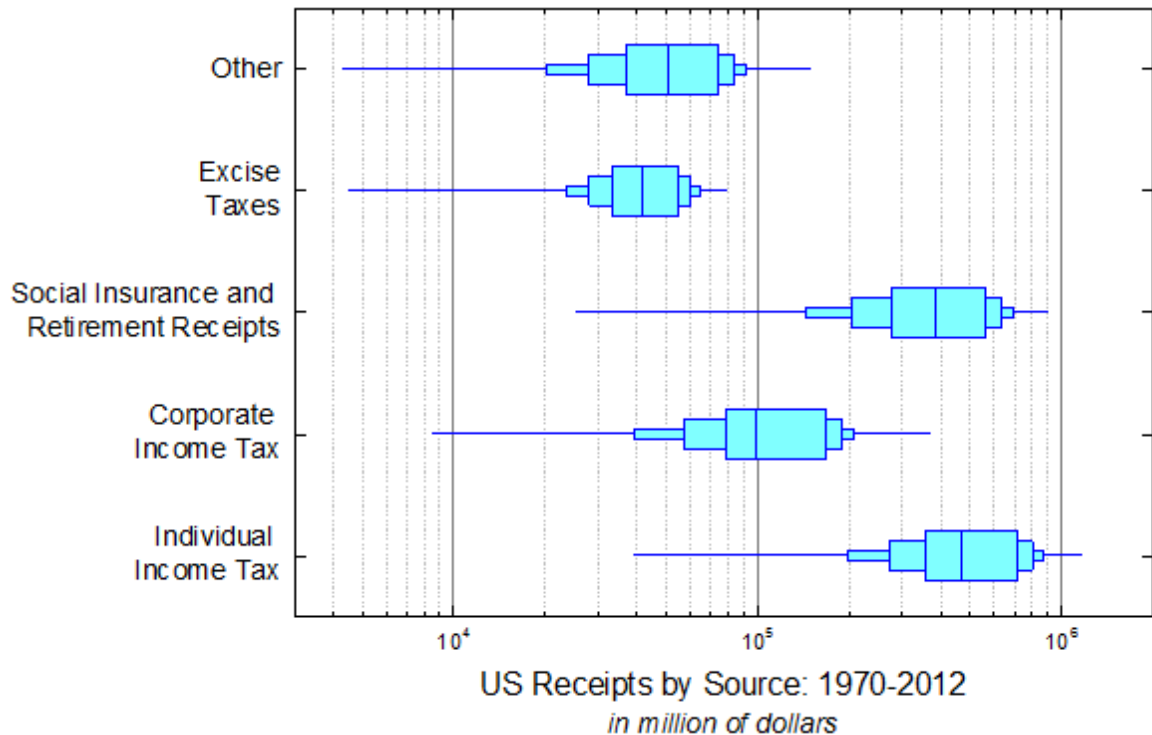

Minimum Origin Version Required: 2016 SR0

### 6.11.6.2 What you will learn

- Customize box plot settings
- Customize the axis dialog for box plots
- Merge and link several graphs
- Exchange X-Y axis

### 6.11.6.3 Steps

This tutorial is associated with <Origin EXE Folder>\Samples\Tutorial Data.opj.

#### 6.11.6.3.1 Create the First Box Chart

1. Open the Tutorial Data.opj and browse to folder *Overlapped Box Chart*.
2. Activate workbook **Book1B** and **Sheet1**. Highlight columns B through F, then click **Plot>Statistical: Box Chart**. A box chart is created.
3. Select and delete the legend object from the graph.
4. Double-click on any box in the plot to open the **Plot Details** dialog box. Go to the **Group** tab and set the **Increment** for **Border Color** to **None** (other elements should already be set to **None**).

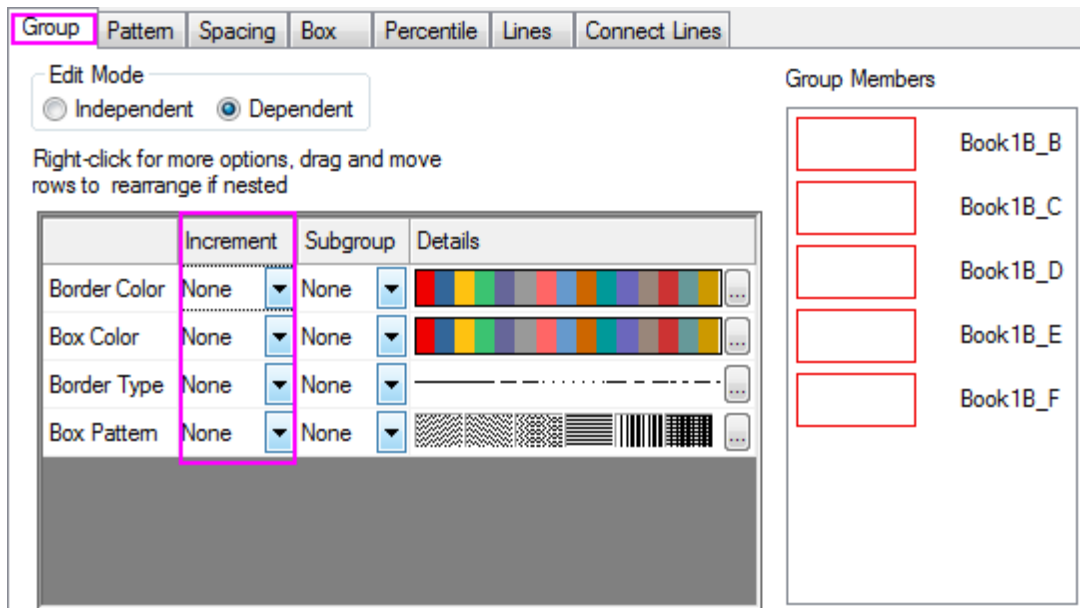

5. Go to the **Pattern** tab and duplicate settings as shown below.

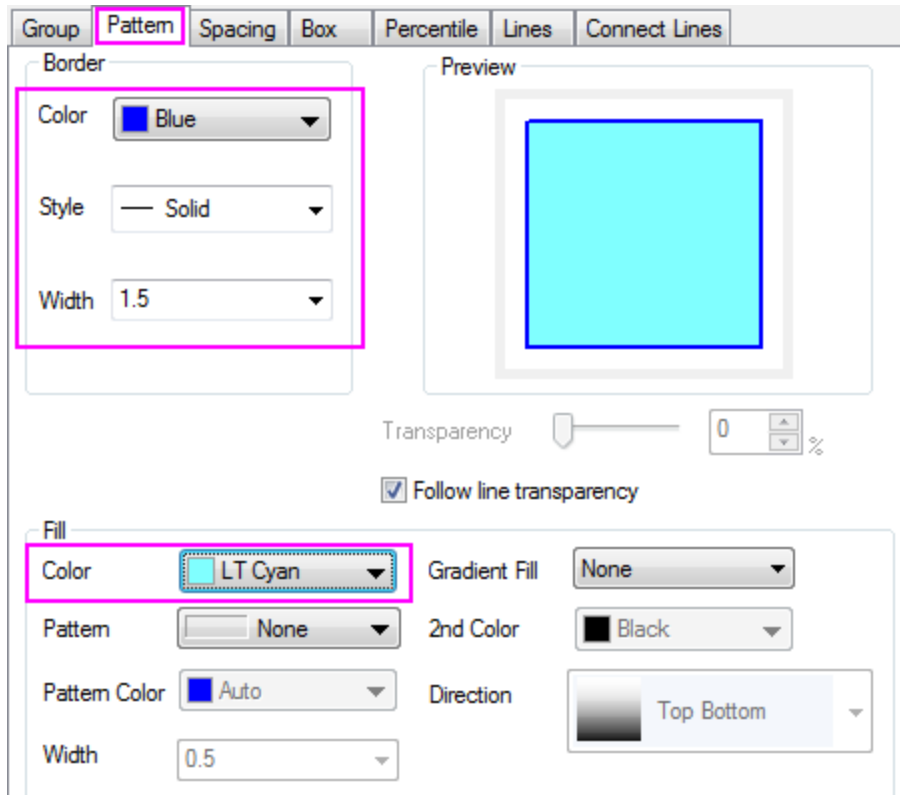

6. Go to the **Spacing** tab and set **Gap Between Boxes (in%)** to be 40.

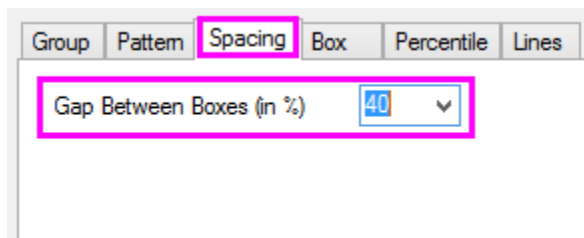

7. Go to **Box** tab and duplicate settings as shown below.

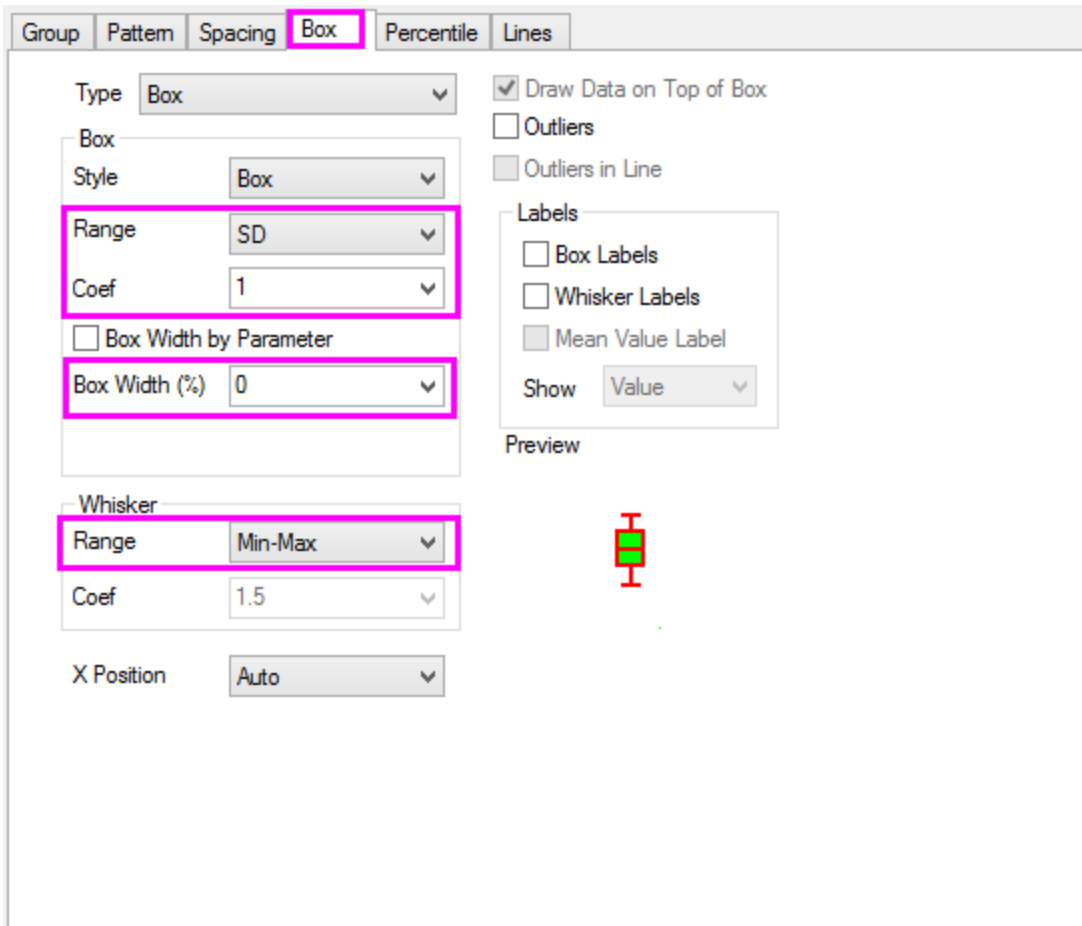

8. Go to **Percentile** tab and clear all symbols. Click **OK** to close the dialog.

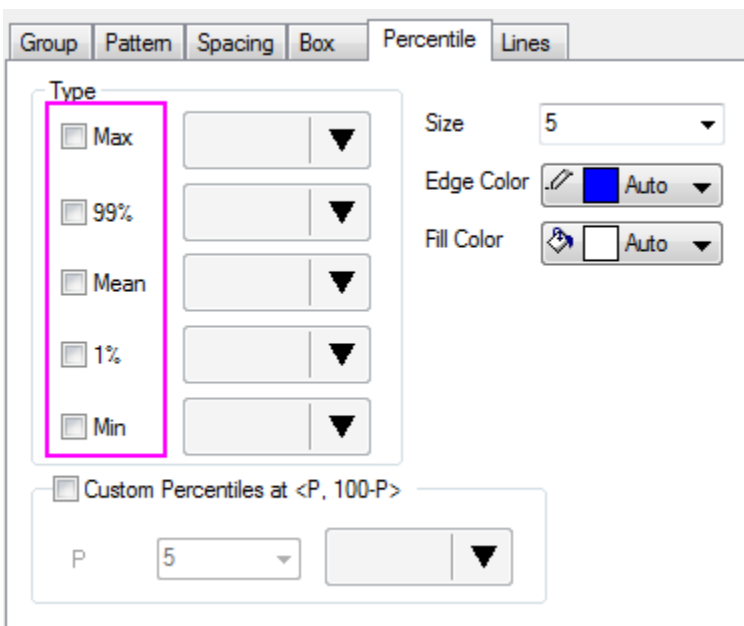

### 6.11.6.3.2 Create the Overlapped Box Chart



1. Right click the graph window title bar and select **Duplicate**. Repeat twice more. You should now have four identical graph windows.

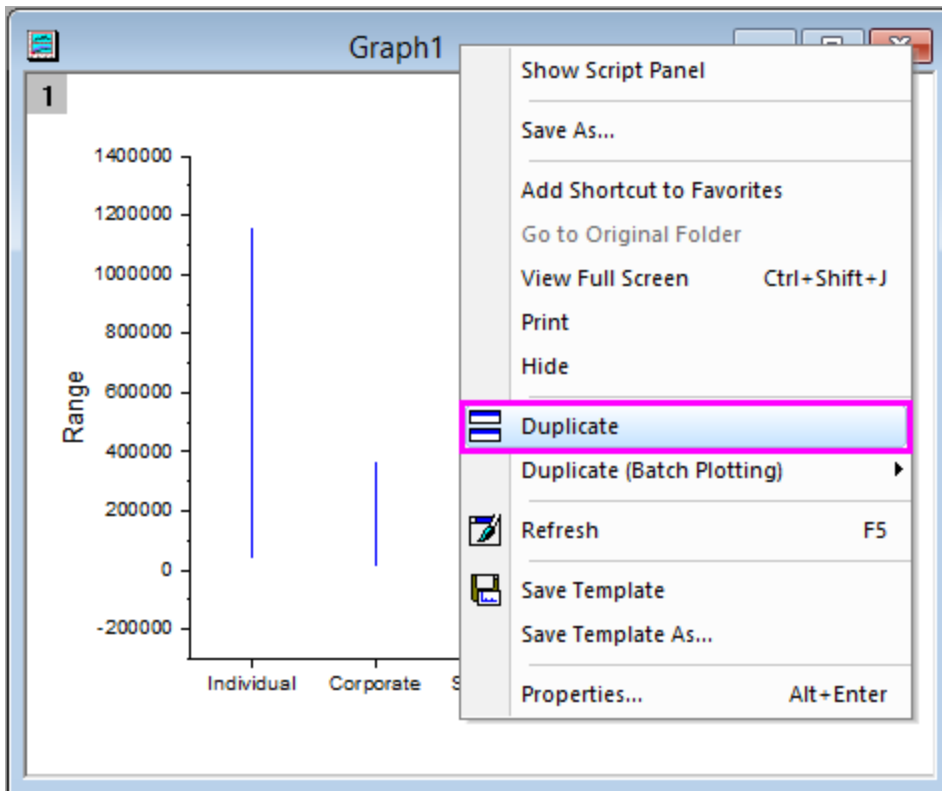

2. Double-click any box in Graph2 to open **Plot Details**. Go to the **Box** tab and set the **Coef** value to be 0.95, **Box Width (%)** to be 15 and no Whisker.

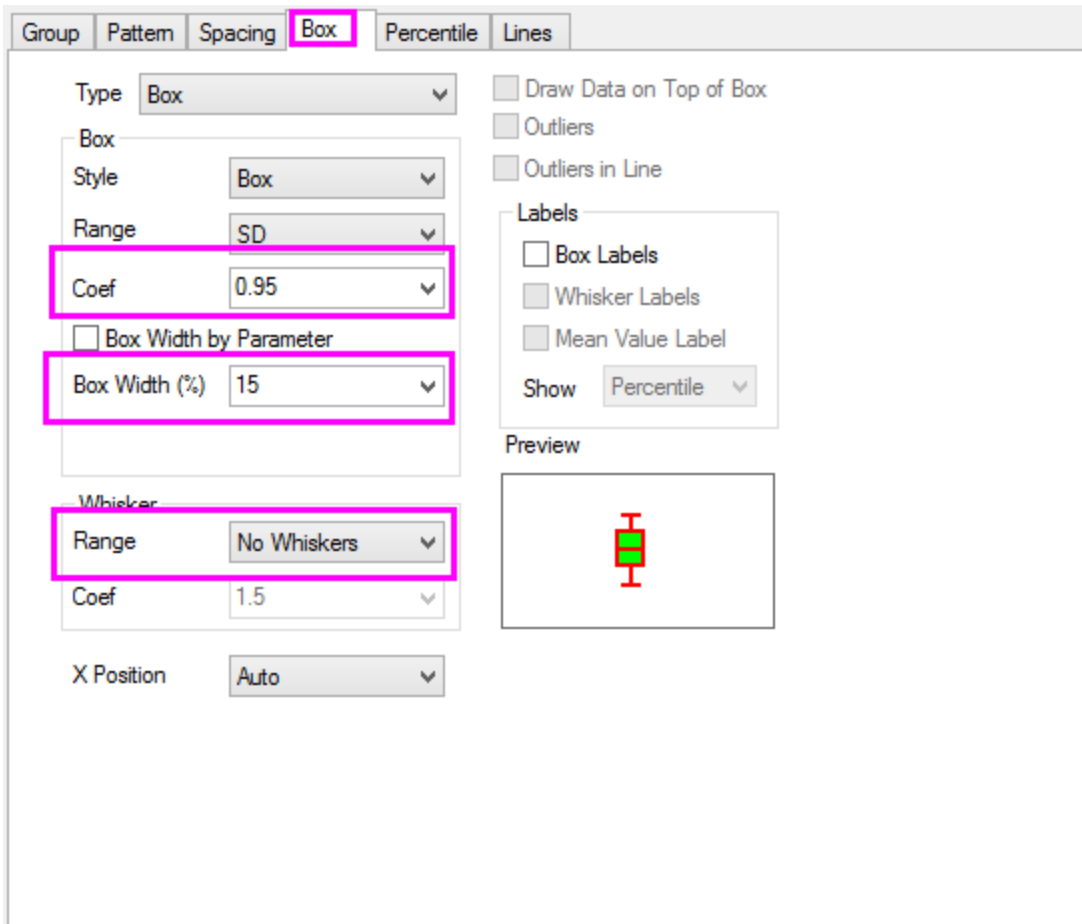

3. Repeat step2 for Graph3 with **Coef** = 0.75, **Box Width (%)** = 40 and no whiskers .
4. Repeat step2 for Graph4 with **Coef** = 0.5, **Box Width (%)** = 70 and no whiskers.

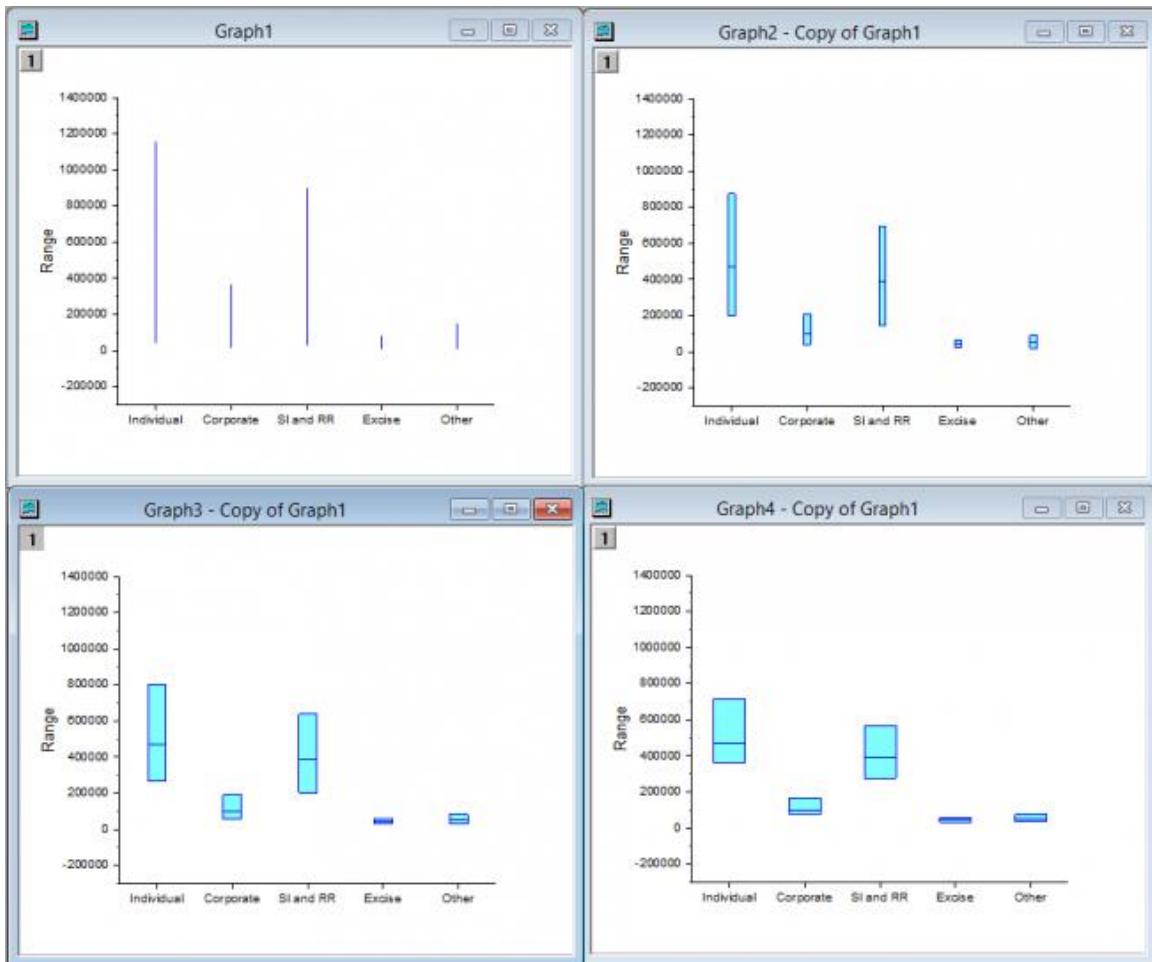

5. Select **Graph: Merge Graph Windows** to open the **merge\_graph** dialog box. Duplicate the settings as shown below and click **OK**.

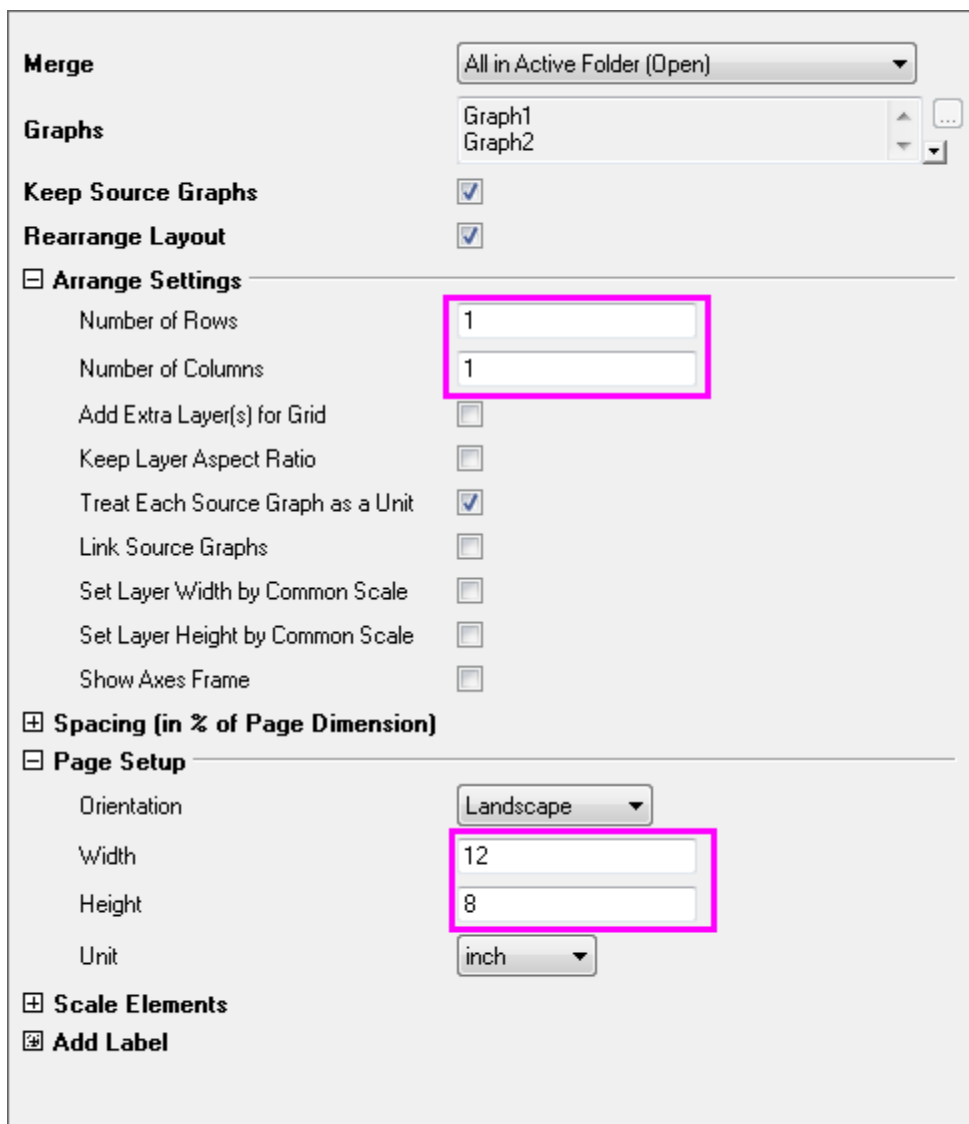

6. Select **Graph: Layer Management** from the menu to open the dialog box.
7. Select **Layer2** and go to the **Link** tab. Duplicate settings as shown below and click **Apply**.

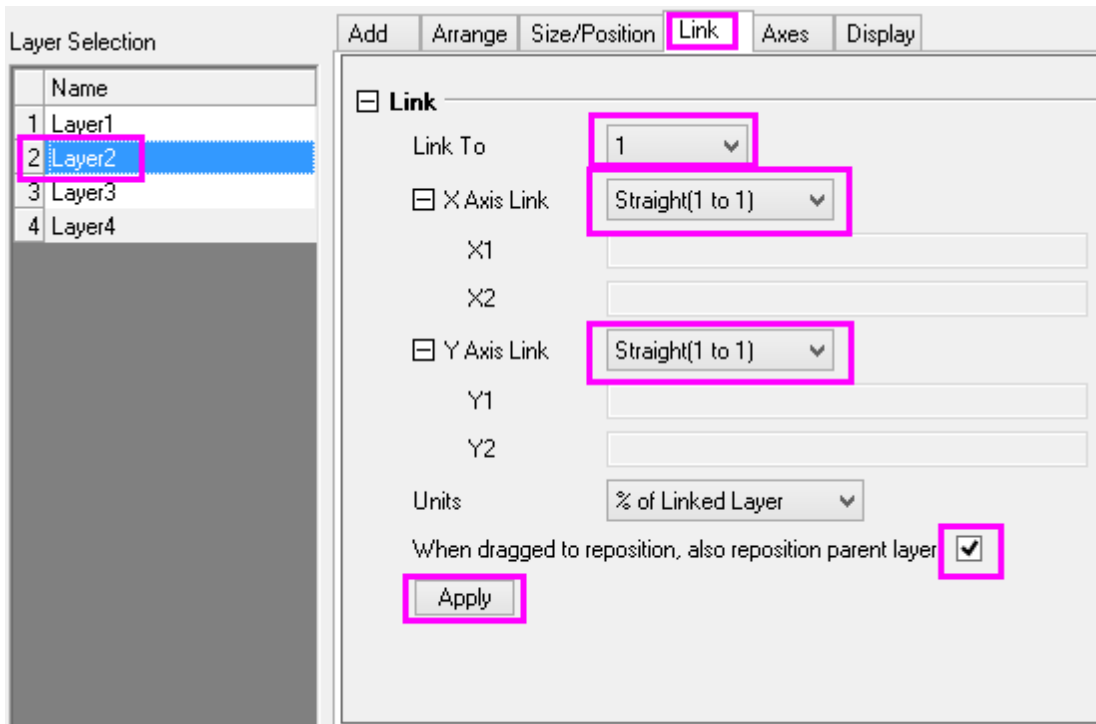

- Go to the **Axes** tab, clear all checkboxes and click **Apply**.

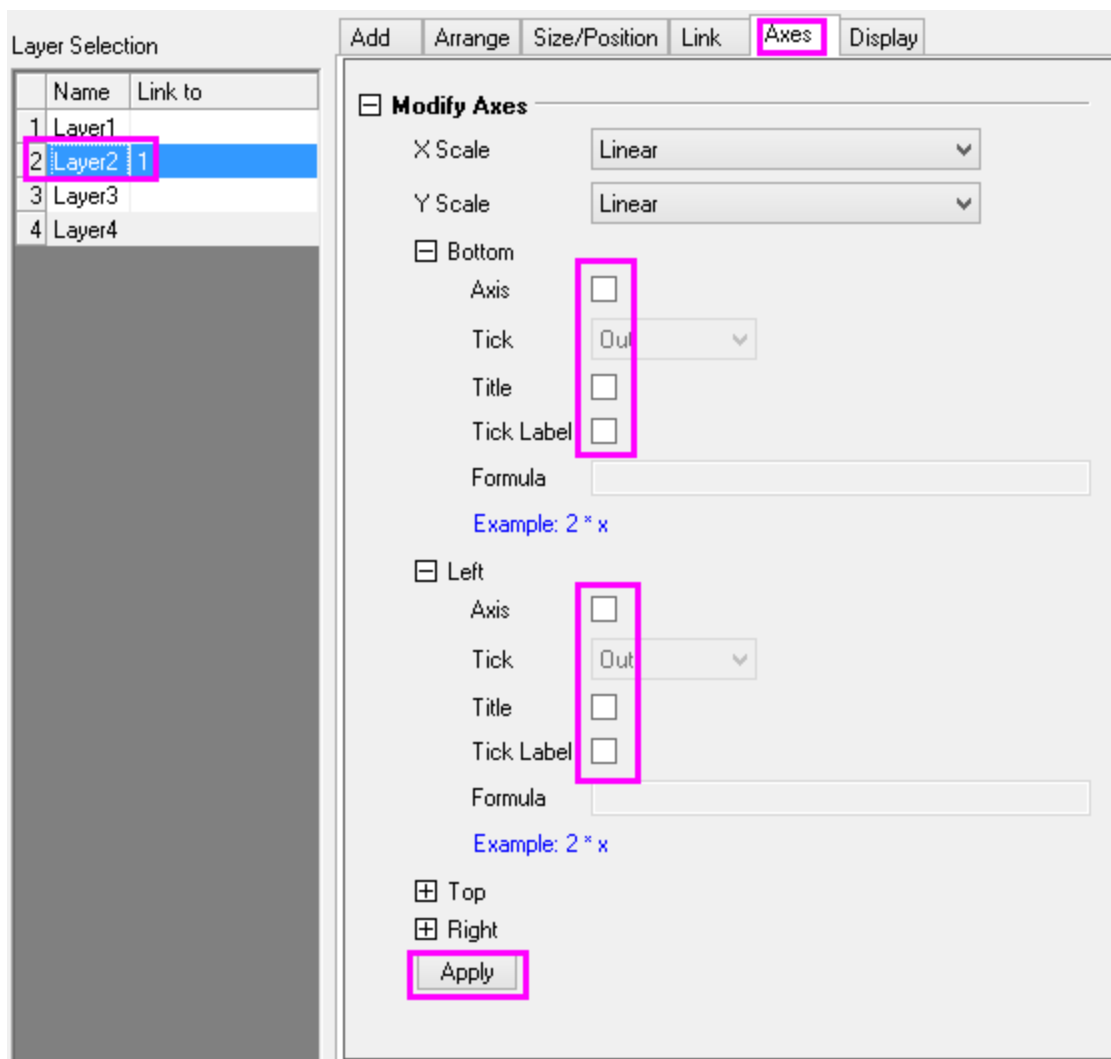

- Repeat Steps 7~8 for **layer3** and **Layer4**. Click **OK** to close the dialog box.

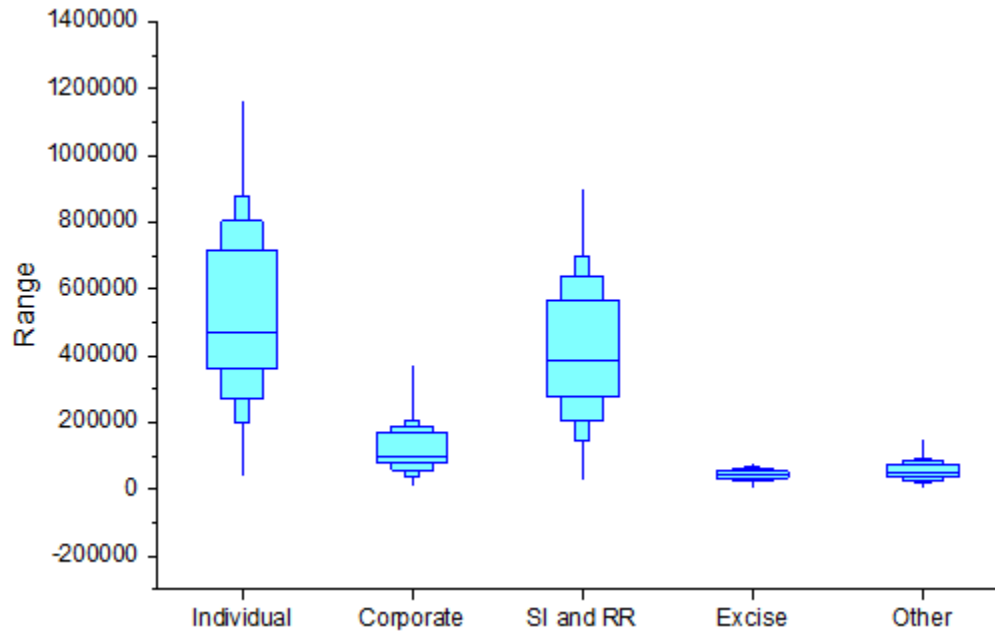

### 6.11.6.3.3 Do Further Customizations

1. Double-click the Y axis to open **Axis Dialog** box. Go to the **Scale** tab and duplicate settings as shown below for the Y axis (**Vertical**).

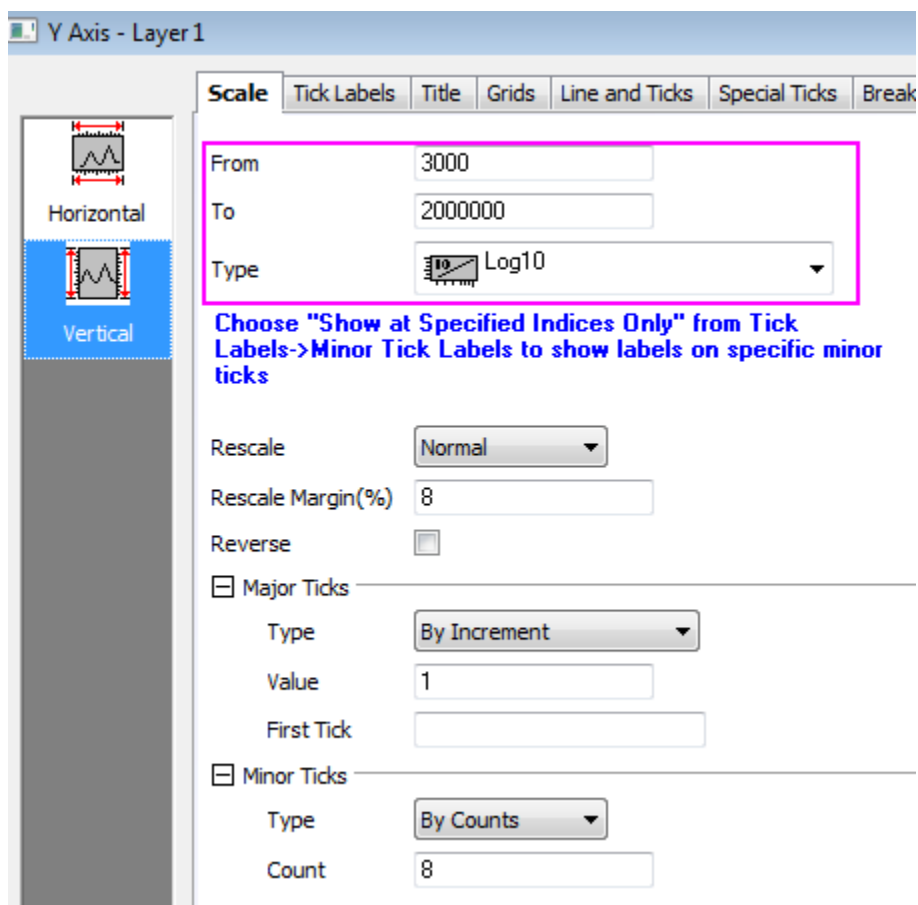

2. Go to the **Tick labels** tab and duplicate settings as shown below.



Y Axis - Layer 1

Scale **Tick Labels** Title Grids Line and Ticks Special Ticks

Show  Use Same Options for Left and Right

**Display** Format Table Minor Tick Labels

Type Numeric

Display Scientific:10^3

Set Decimal Places

Divide by Factor

Formula

**Example:  $2 * x$ .**  
**"Divide by Factor" is ignored when a "Formula" is used.**

Prefix

Suffix

Plus Sign

Minus Sign

Y Axis - Layer 1

Scale **Tick Labels** Title Grids Line and Ticks Special Ticks

Show  Use Same Options for Left and Right

Display **Format** Table Minor Tick Labels

Color Auto

Font

Font Auto

Size 16

Actual Size (16)

Bold

Rotate (deg.) 0

Wrap Text

Alignment  Center  Center between Ticks

- Go to the **Grids** tab and duplicate settings as shown below.

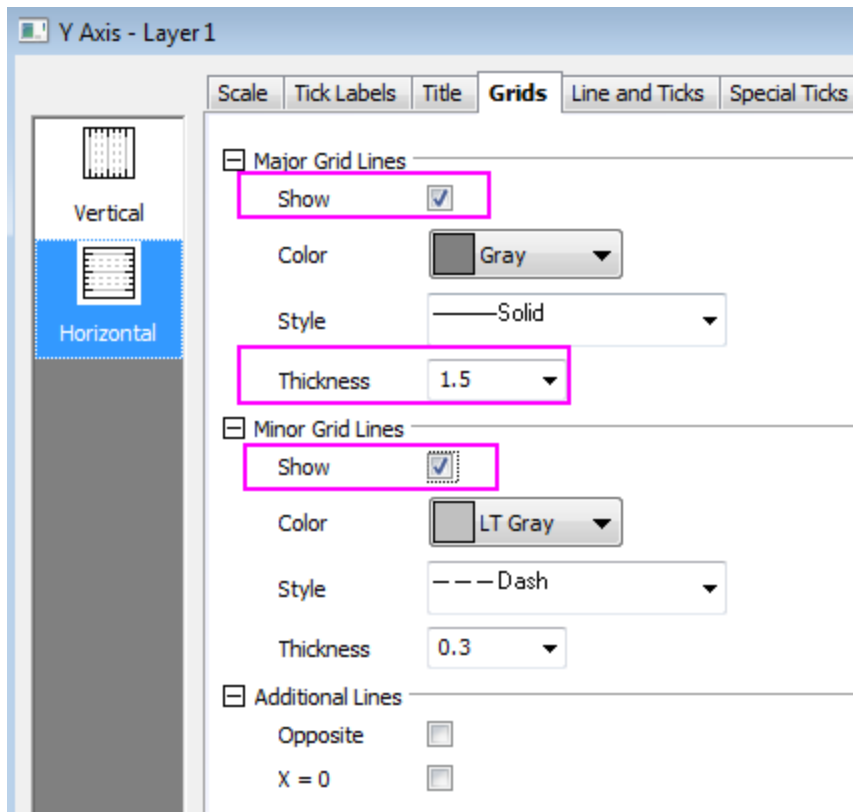

4. Go to the **Line and Ticks** tab, hold **Ctrl** key to select both **Bottom** and **Left** icons, then select **Use Same Options for Bottom and Top**, and change the line and ticks setting as below.

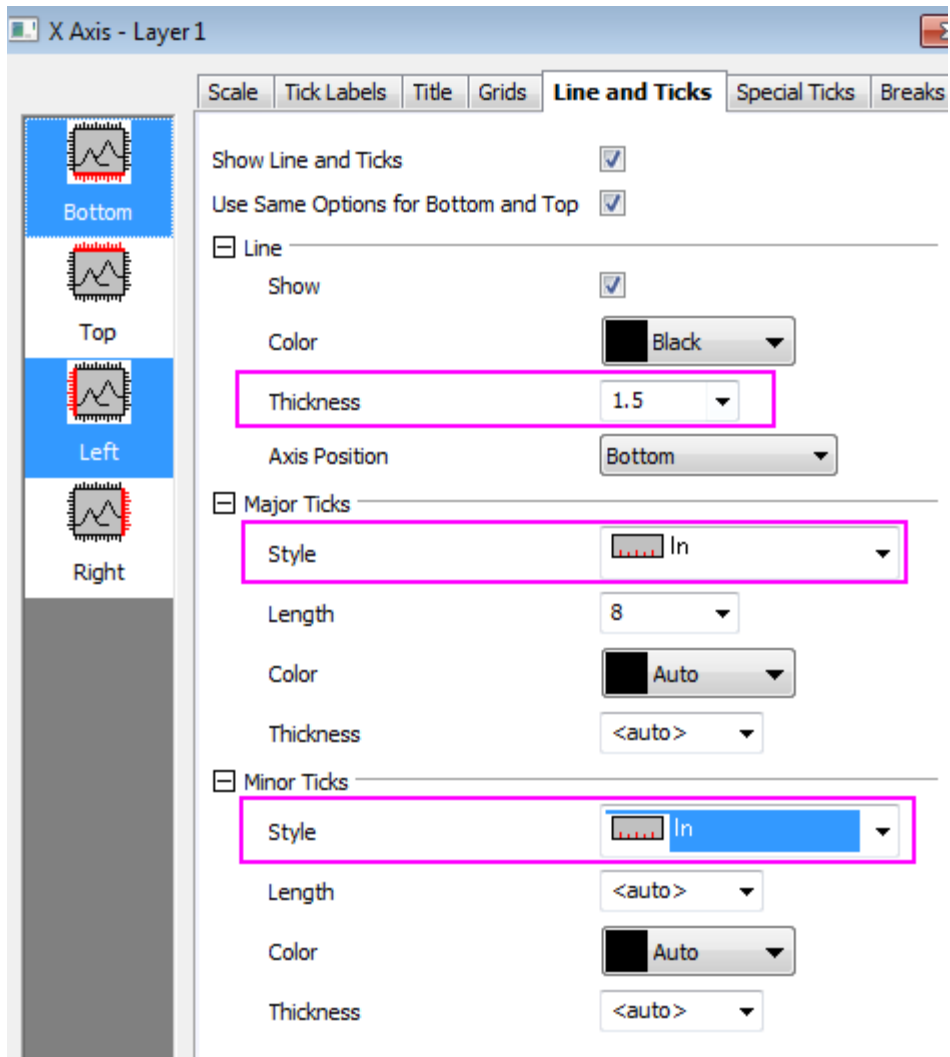

5. Go to the **Tick labels** tab again. Duplicate settings as shown below for X axis, after this, click **OK** to close the **Axis** dialog and apply all settings:

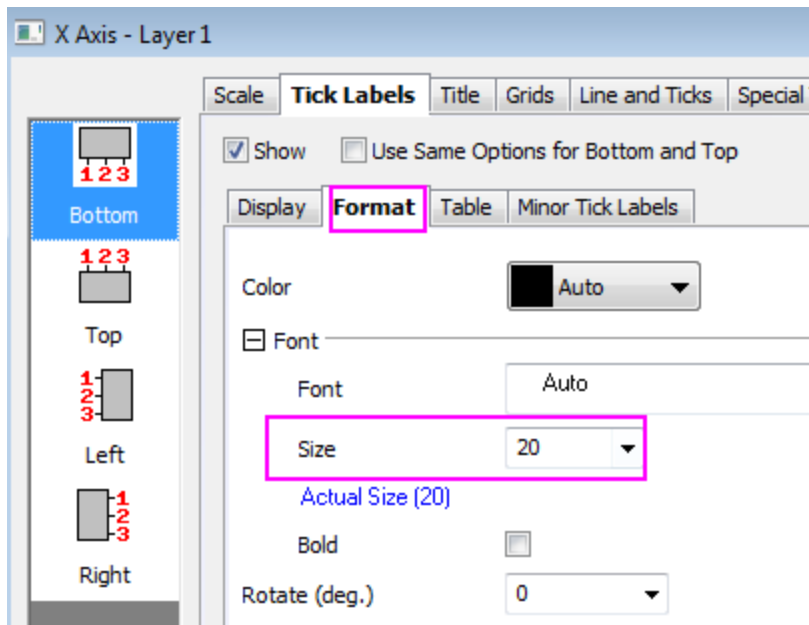
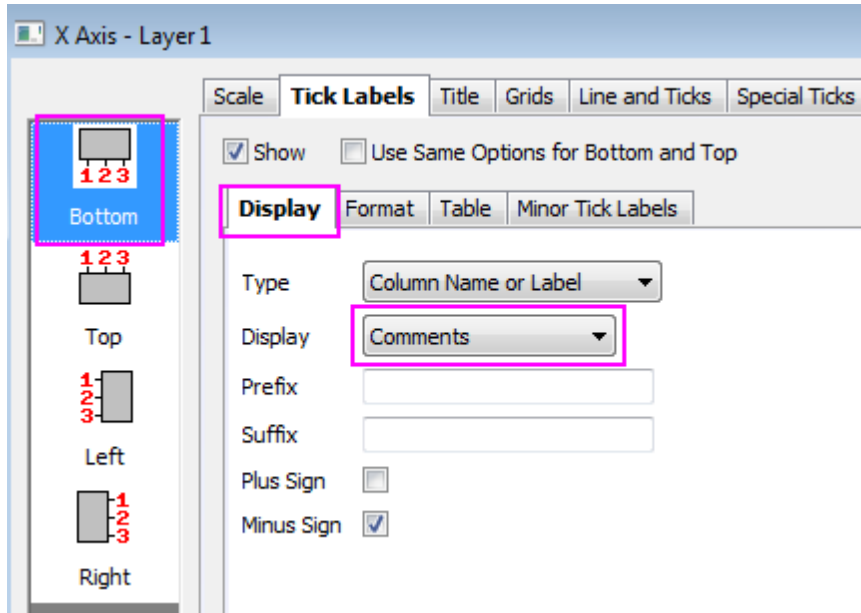

6. Right-click the Y axis title and select **Properties....** Duplicate settings as shown below and click **OK**.

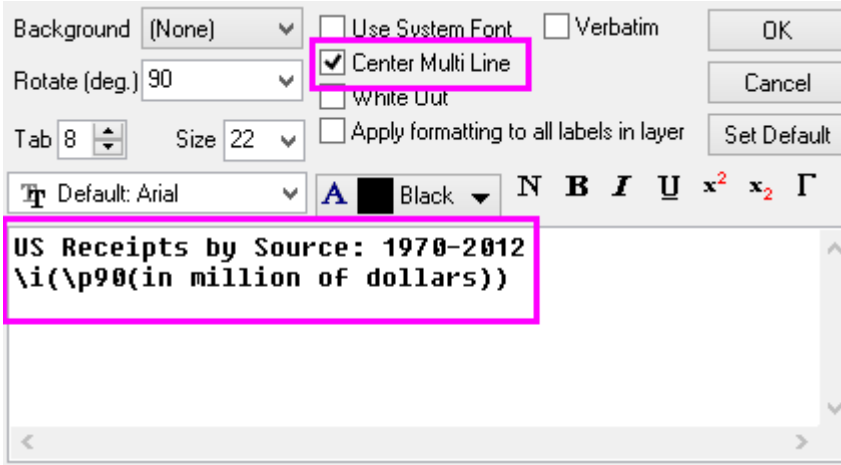

7. Activate Layer1 by clicking on the layer icon at the upper-left corner of the graph window. Select **Graph: Exchange X-Y Axes**.
8. Resize and/or reposition the graph layer as needed, so that everything fits comfortably within the graph window.

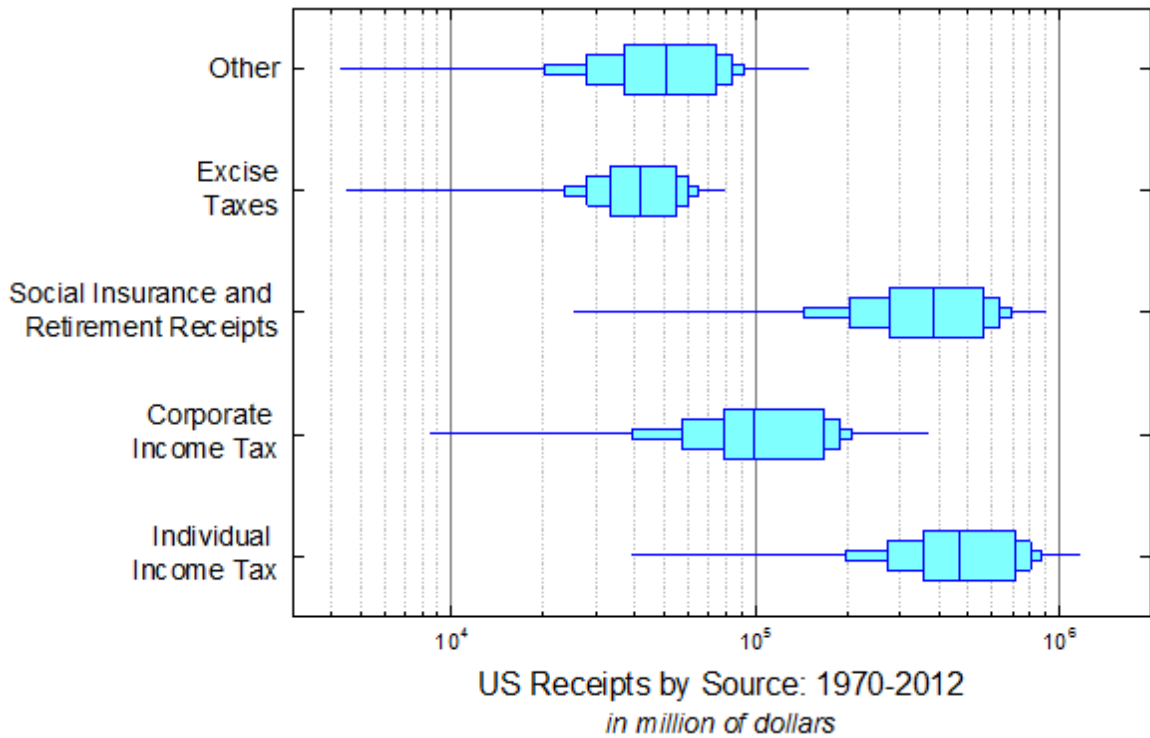

### 6.11.7 Two-Level Grouped Box Chart

#### 6.11.7.1 Summary

Origin's box chart is advanced and customizable, this tutorial shows how to create a two-level grouped box chart from indexed data in Origin.

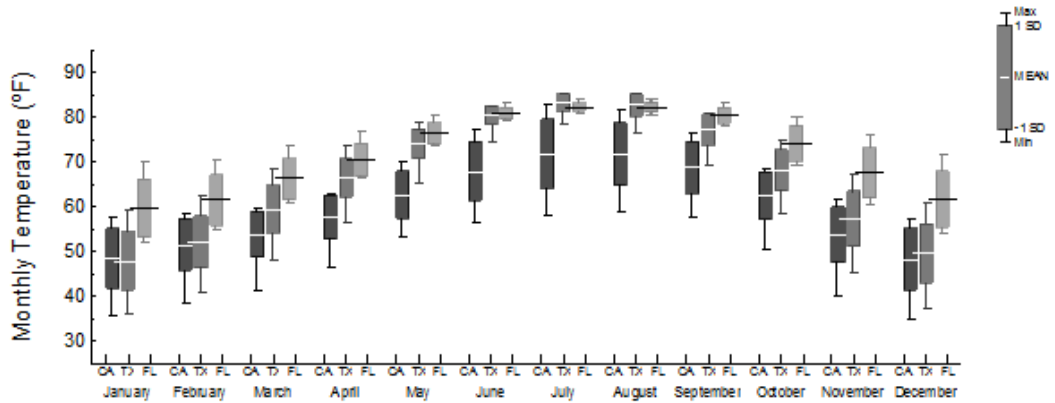

Minimum Origin Version Required: 2015 SR0

### 6.11.7.2 What you will learn

This tutorial will demonstrate how to:

- Use the data filter to select worksheet data.
- Stack column for box chart.
- Controlling the categorical values.
- Create a grouped box chart from indexed data.
- Customize box chart settings.
- Customize the axis dialog for box charts.
- Add a graph into box chart.

### 6.11.7.3 Data Preparation

This tutorial is associated with <Origin EXE Folder>\Samples\Tutorial Data.opj, so you should open **Tutorial Data.opj** and browse to the folder *Two-Level Grouped Box Chart* at first.

#### 6.11.7.3.1 **Using data filter to select worksheet data**

In the following steps, you can select the data you want to analyze by data filter:

1. Active the worksheet **US Mean Temperature** and then highlight **Column B**.
2. Click the **Add/Remove Data Filter** button  on the **Worksheet Data** toolbar to add empty data filter to **Column B**.
3. Click the Filter icon on the column header of **Column B**, clear the check boxes before **Select All**, and check CA, FL and TX again.

- Click **OK** to apply the filter.

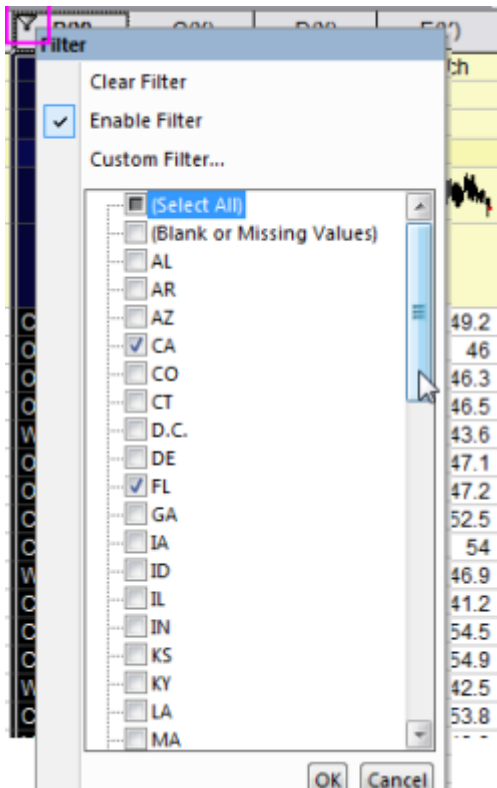

#### 6.11.7.3.2 Stacking columns to convert data into index mode

In the following steps, you can convert data from the raw mode into index mode:

- Highlight **Column E** to **Column P** (from **January** to **December**), and then select **Worksheet: Stack Columns** from the main menu to open the **Stack Columns** dialog
- Check the box before **Include Other Column(s)**, click the **Select from Worksheet** button, and select Column **A** and **B** in the worksheet.
- Change the **Group Column Long Name** to "Month" and **Data Column Long Name** to "Temperature"

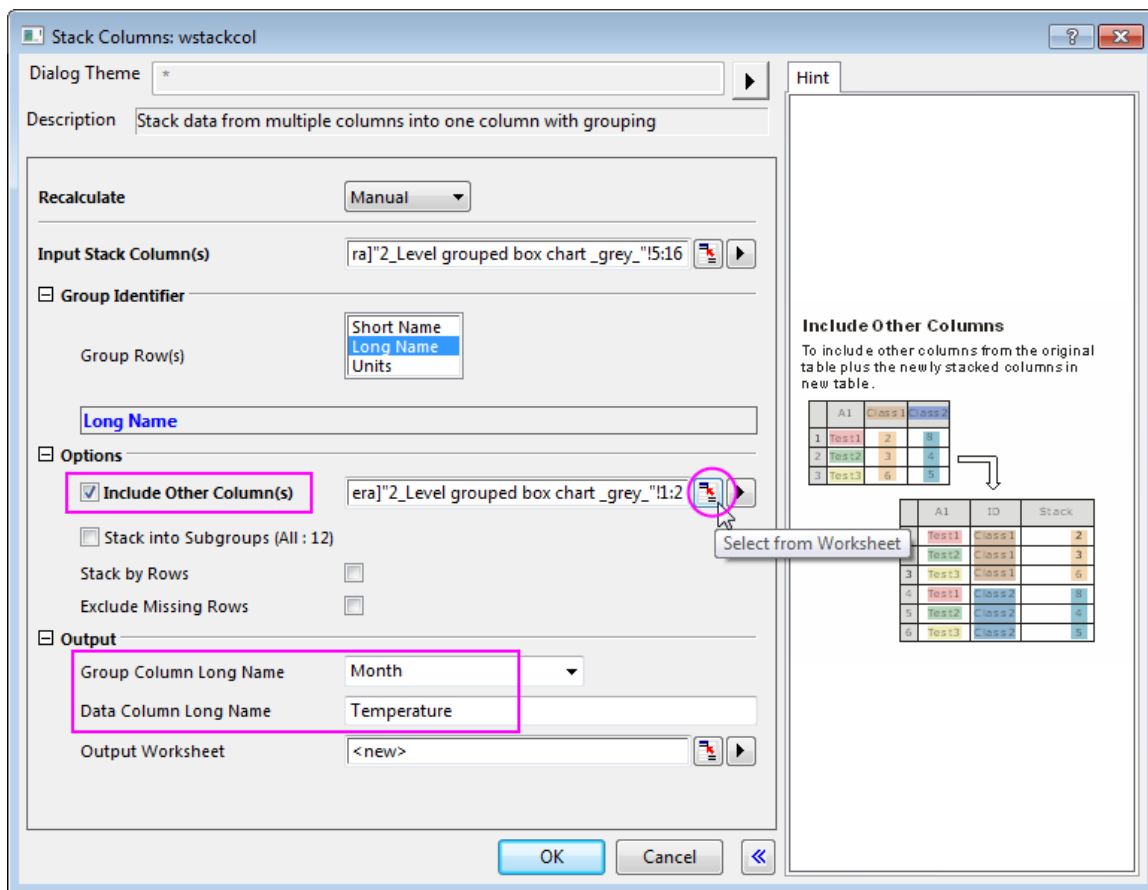

- Click **OK** to launch the new worksheet **StackCols1**
- Click the **Lock** icon on the column header, and select **Recalculate Mode: None** in the context menu.

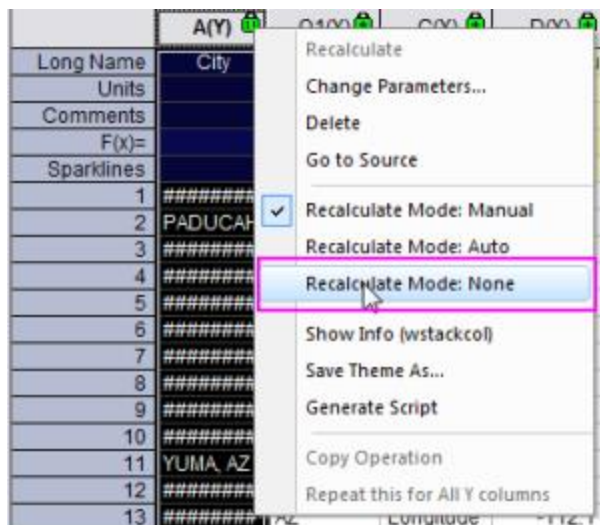

### 6.11.7.3.3 Controlling the categorical values



In the following steps, you can customize the order of values shown in the graph but not change the source data:

1. Highlight **Column B** in Worksheet **StackCols1**, and then right click to select **Set as Categorical**.

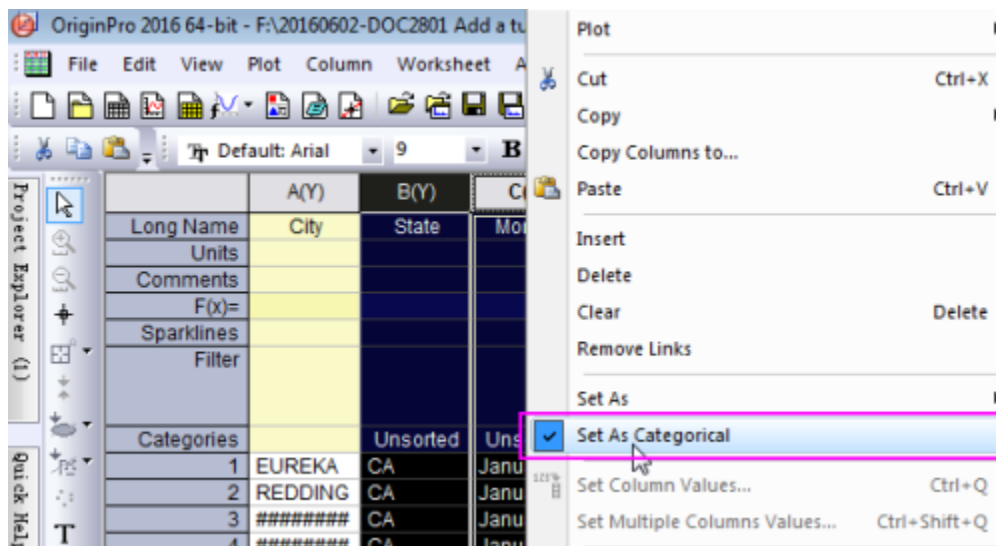

2. Double click the Categories cell "unsorted" of **Column B** to open the **Categories** dialog.
3. Uncheck the **<auto>** checkbox, and then specify the order of items into: CA-TX- FL by using **Move**

**to Top button** , **Move up button** , **Move Down button**  and **Move to Bottom button** .

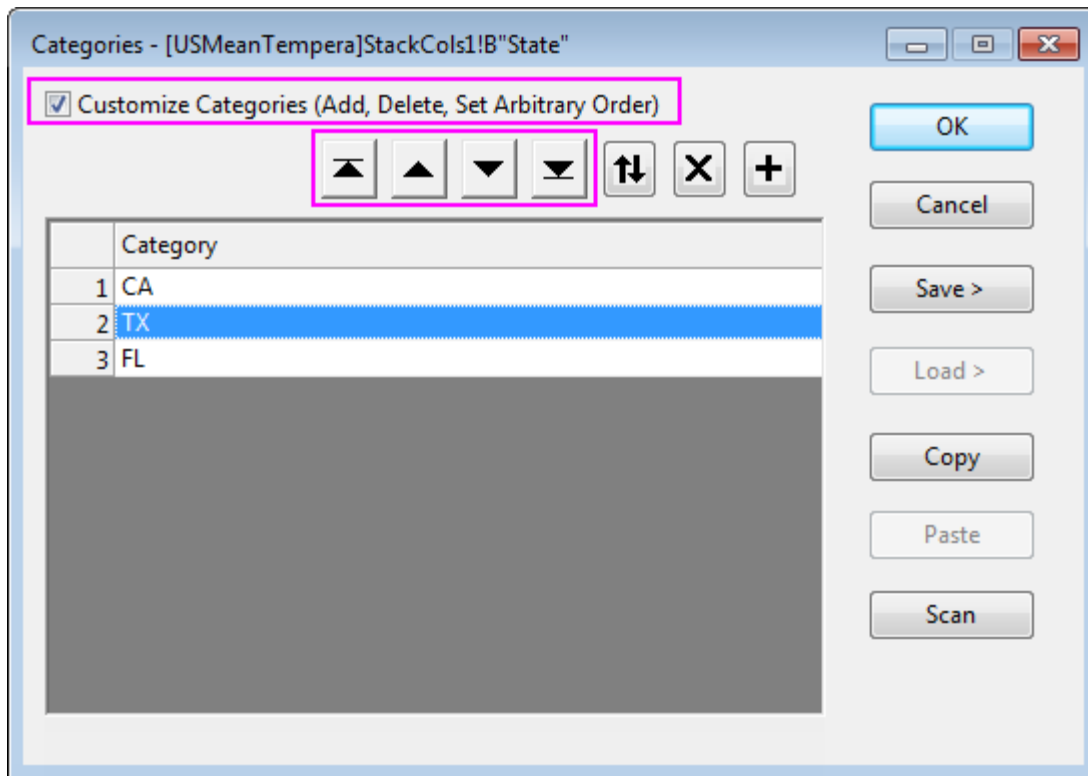

4. Redo step2 and step3 in **Column C** to specify the order of items into: January to December.

#### 6.11.7.4 Create a grouped box chart from indexed data

1. Highlight **Column D** in Worksheet **StackCols1**, and then select **Plot > Categorical : Grouped Box Chart – Indexed Data...** in the main menu.
2. In the open dialog **Plotting: gboxindexed**, click the triangle button at the top right corner in **Group Column(s)** section, and then select **C(Y): Month** and **B(Y): State** in order in the context menu item.

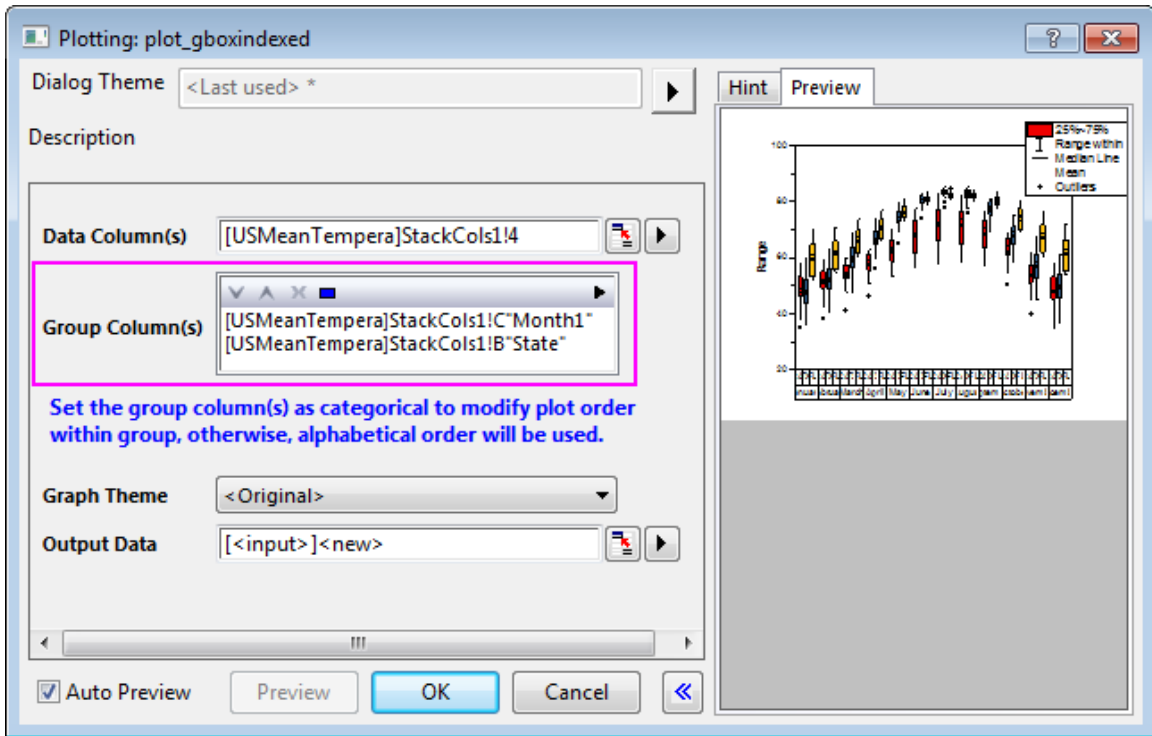

3. Click **OK** to create a grouped box chart with two levels.

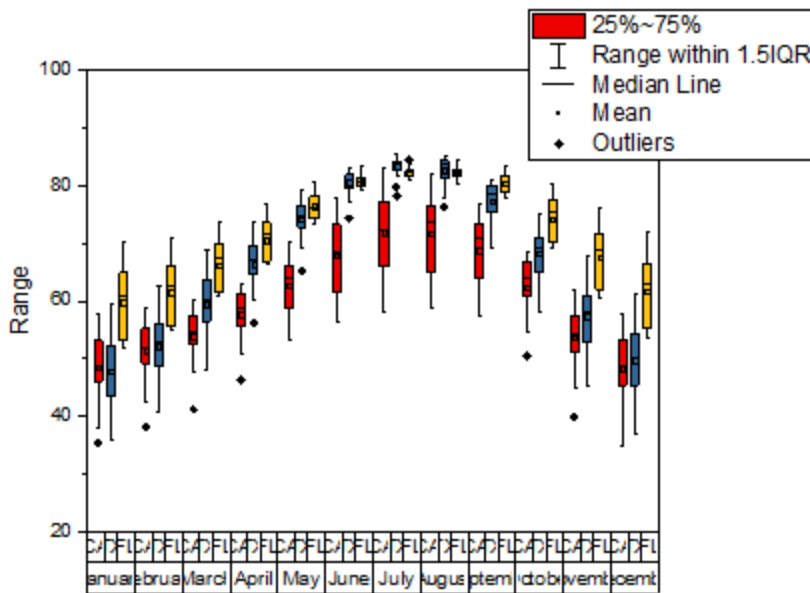

#### 6.11.7.5 Customize box chart settings

1. Select the graph layer (click somewhere in the lower-middle portion of the layer seems to work best ), and then drag the control handle to resize it as you want (put the cursor on the control handle, and drag it

when the cursor becomes a two-headed arrow).

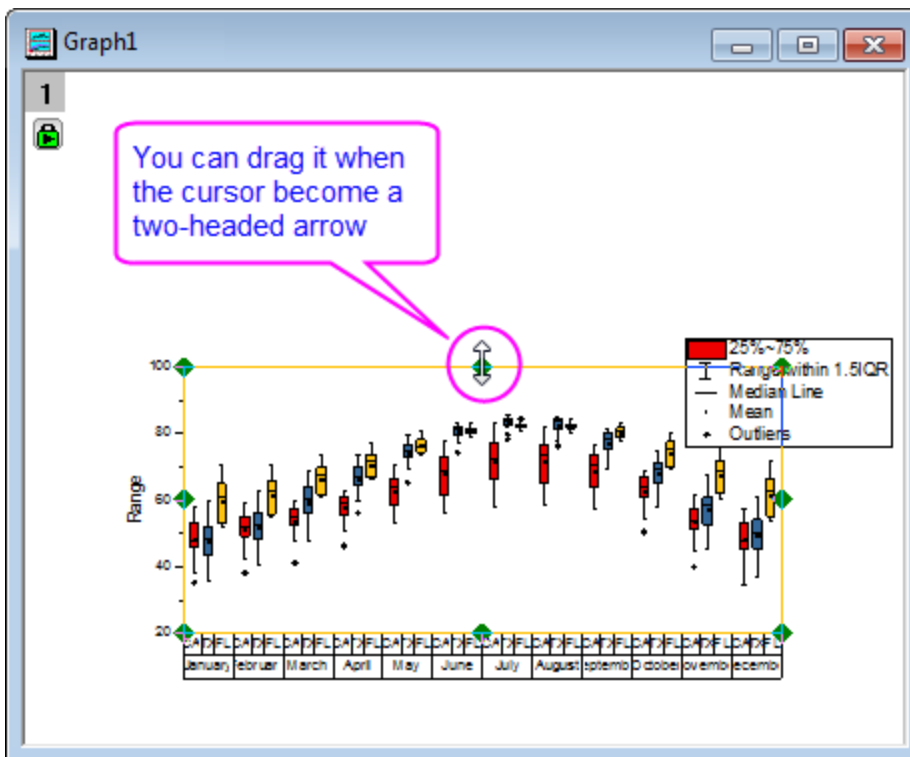

2. Select **Graph:Fit Page to Layers** in the main menu to open the dialog, and then select **Height Only** in the drop-down list of **Adjust Direction** to match the page width to that of the bounding box.

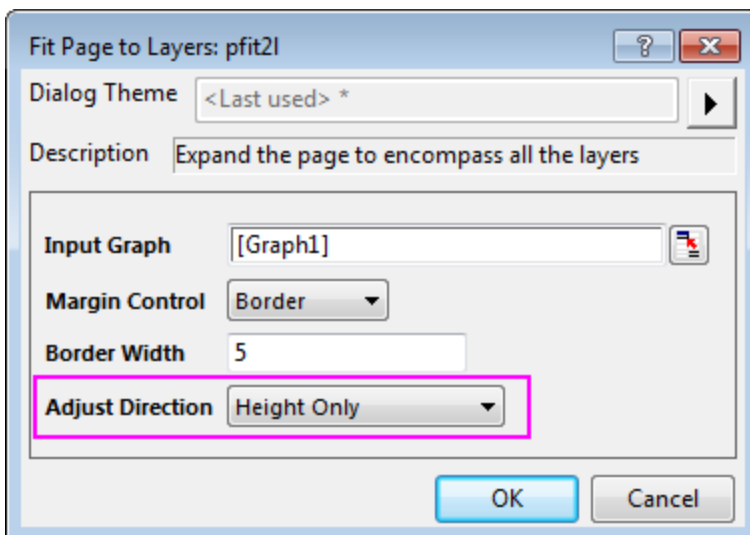

The graph will look like as below:

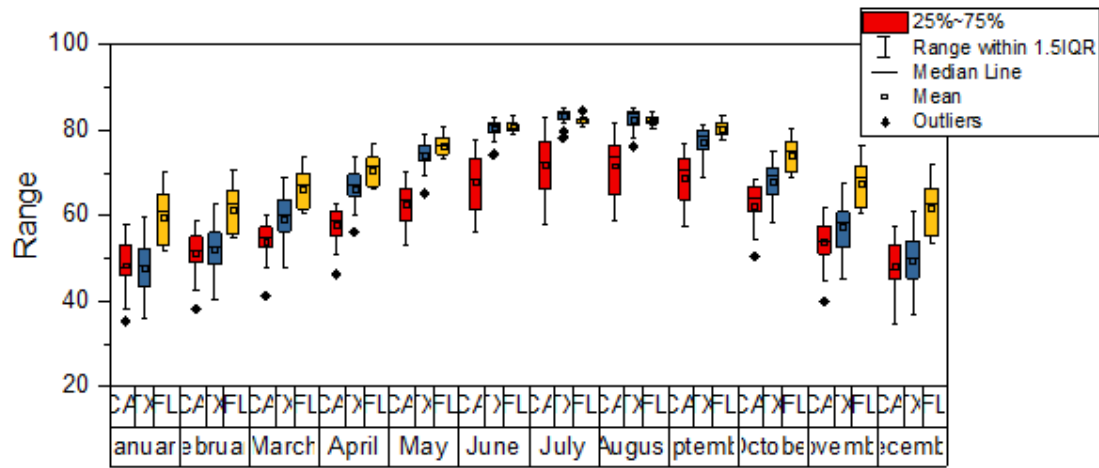

3. Double click on any one of the boxes to open **Plot Details** dialog, go to **Group** tab. For both **Border Color** and **Boxed Color**, set **Increment** to **By One** and **Subgroup** to **With Subgroup**, so each subgroup has a different color. Click the color scale on the **Details** section, and select **S01 Gray Scale** in

the drop down list for both **Border Color** and **Boxed Color**.

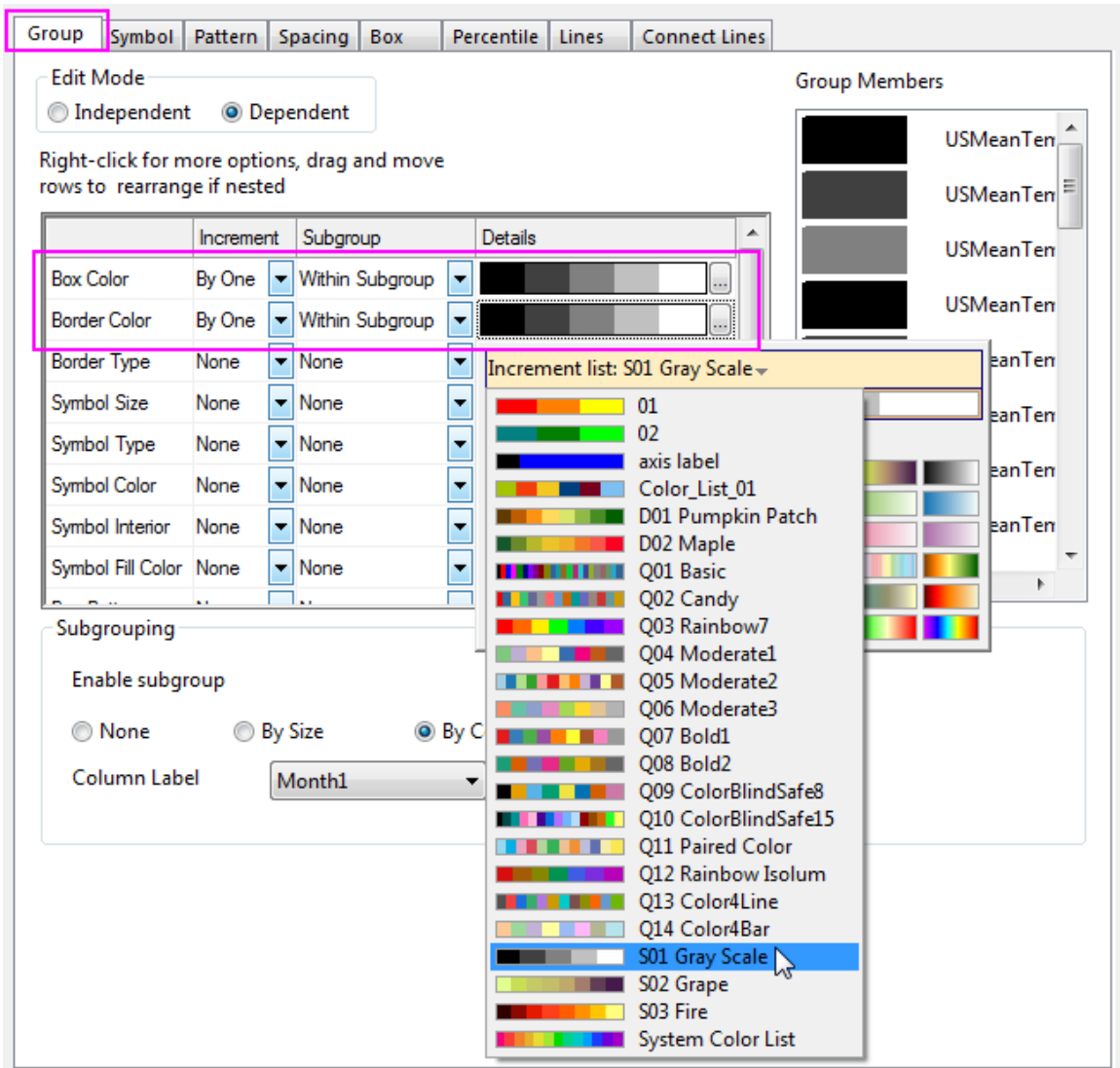

4. Go to **Pattern** tab, uncheck the checkbox **Follow the line transparency** and set transparency to 30%.

The screenshot shows the 'Pattern' tab selected in a software interface. The 'Border' section is visible, with 'Color' set to 'S01 Gray Scale', 'Style' set to 'Solid', and 'Width' set to '1.5'. A 'Preview' window shows a dark gray square. Below the preview, the 'Transparency' slider is set to 30%, and the checkbox 'Follow line transparency' is unchecked. The 'Fill' section is also visible, with 'Color' set to 'S01 Gray Scale', 'Gradient Fill' set to 'None', 'Pattern' set to 'None', 'Pattern Color' set to 'Auto', 'Width' set to '0.5', '2nd Color' set to 'Black', and 'Direction' set to 'Top Bottom'.

5. Go to **Spacing** tab to set the gap value between and within subgroup.

The screenshot shows the 'Spacing' tab selected in a software interface. The 'Gap Between Subgroups (in %)' is set to 35, and the 'Gap Within Subgroups (% Negative for Overlap)' is set to 20.

6. Go to **Box** tab to set the range of box and whisker.

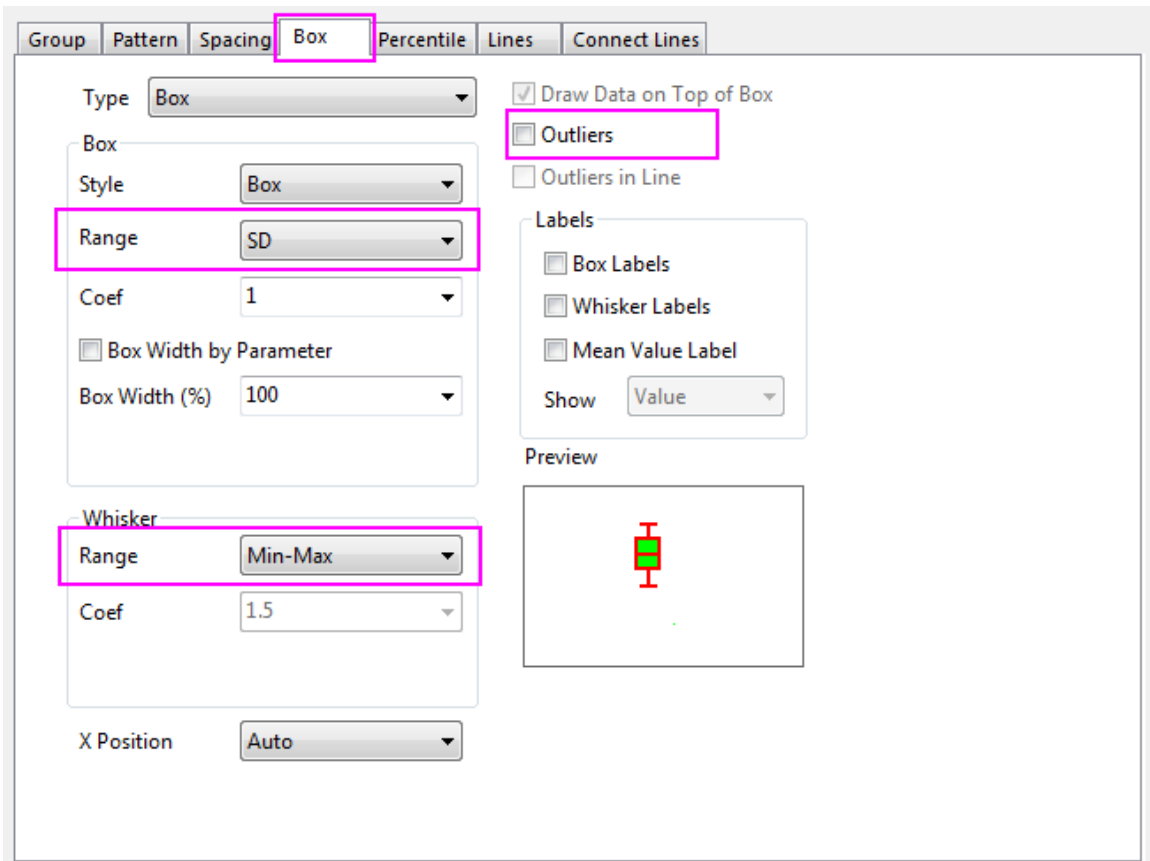



7. Go to **Percentile** tab, clear the check box before the **99%**, **1%**, **Max** and **Min**, and then select the shape and size of **Mean** marker.

The image shows a software interface with several tabs: Group, Pattern, Spacing, Box, Percentile, Lines, and Connect Lines. The Percentile tab is active and highlighted with a pink box. Under the 'Type' section, there are five options: Max, 99%, Mean, 1%, and Min. Each option has a checkbox and a corresponding marker icon. The 'Mean' option is selected, with its checkbox checked and its marker icon highlighted by a pink box. To the right of the 'Type' section, there are three settings: 'Size' (set to 17), 'Edge Color' (set to Auto), and 'Fill Color' (set to Auto). At the bottom, there is a section for 'Custom Percentiles at <P, 100-P>' with a 'P' dropdown set to 5 and a star icon.

- Go to **Line** tab to customize the caps of whisker and uncheck the **Median** checkbox.

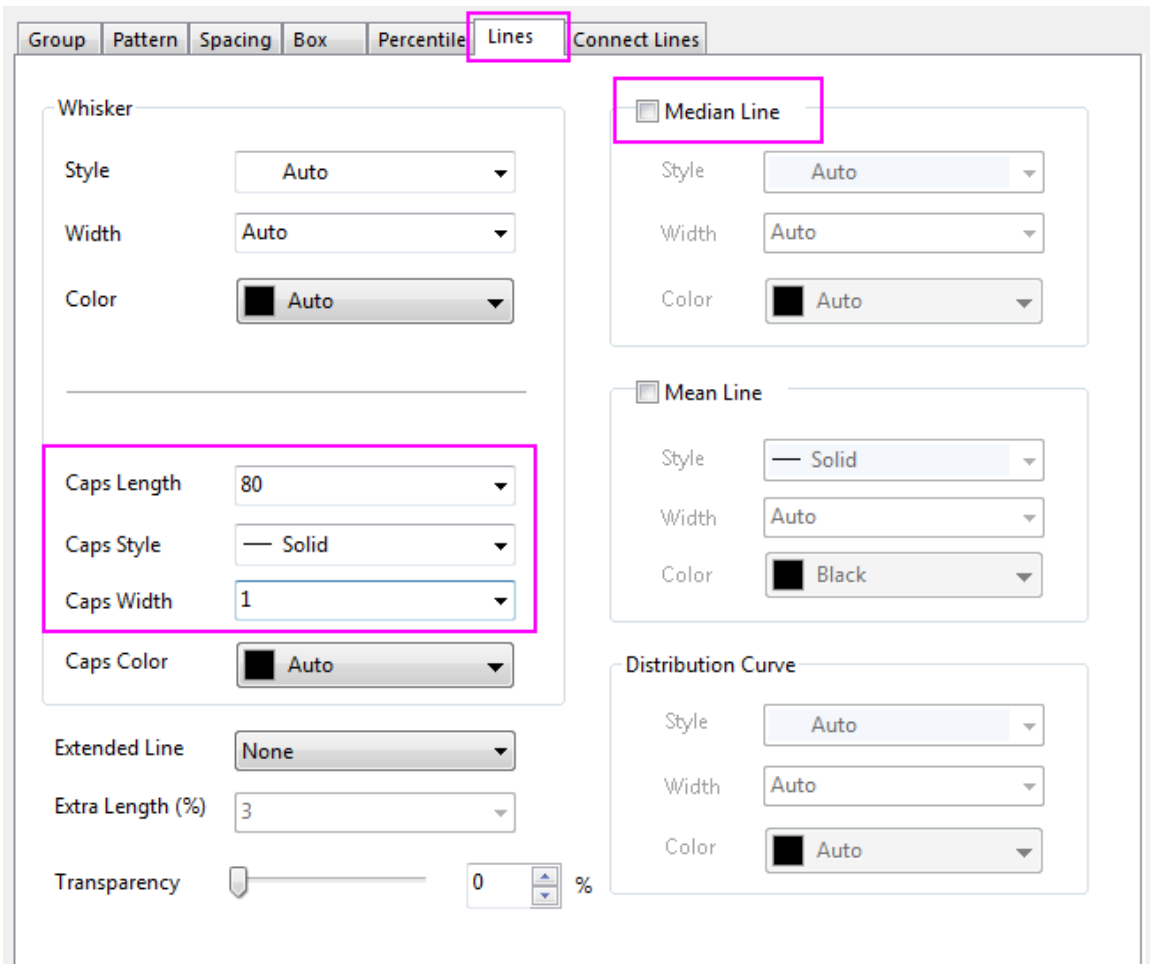

- Click **OK** button to apply the setting.
- Right-click the legend, and select **Legend: Box Chart Components...** in the context menu. In the '**Enhanced Box Legend: legendbox** dialog, select **State** in the **Box Identifier** dropdown list.

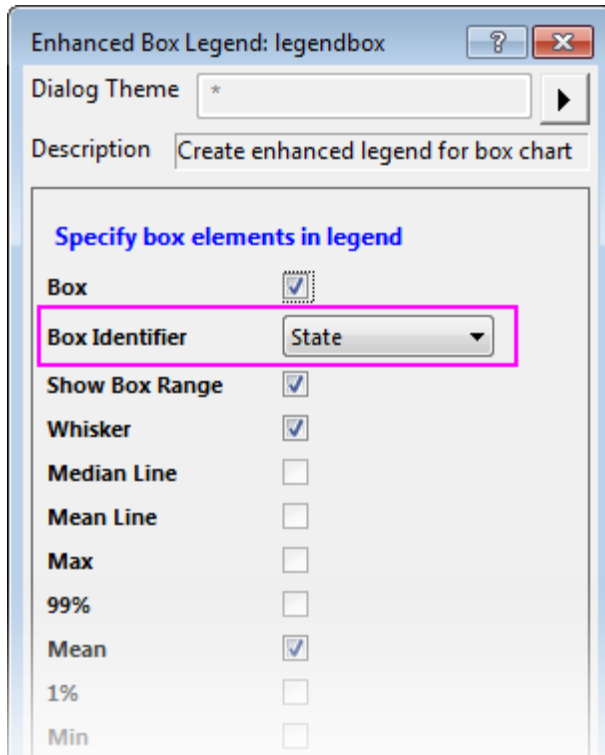

The graph will look like as below:

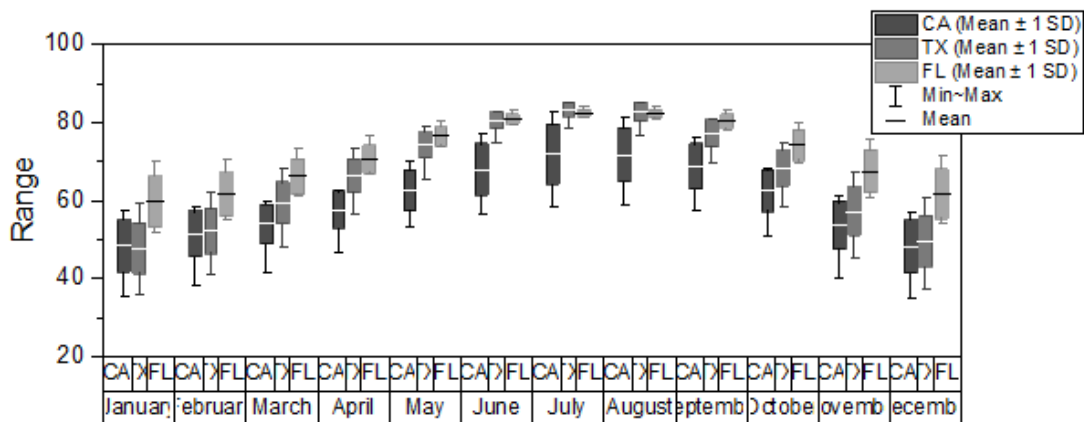

6.11.7.6 Customize the axis dialog for box charts

1. For the **X Axis**, change as the following steps:
  - Double click **X Axis** to open the **Axis Dialog**, and then select **Bottom1** on the left panel
  - Go to **Tick Labels** tab, set the font size of **Bottom1** with 14 in **Format** tab, and duplicate settings as shown below in **Table** tab.

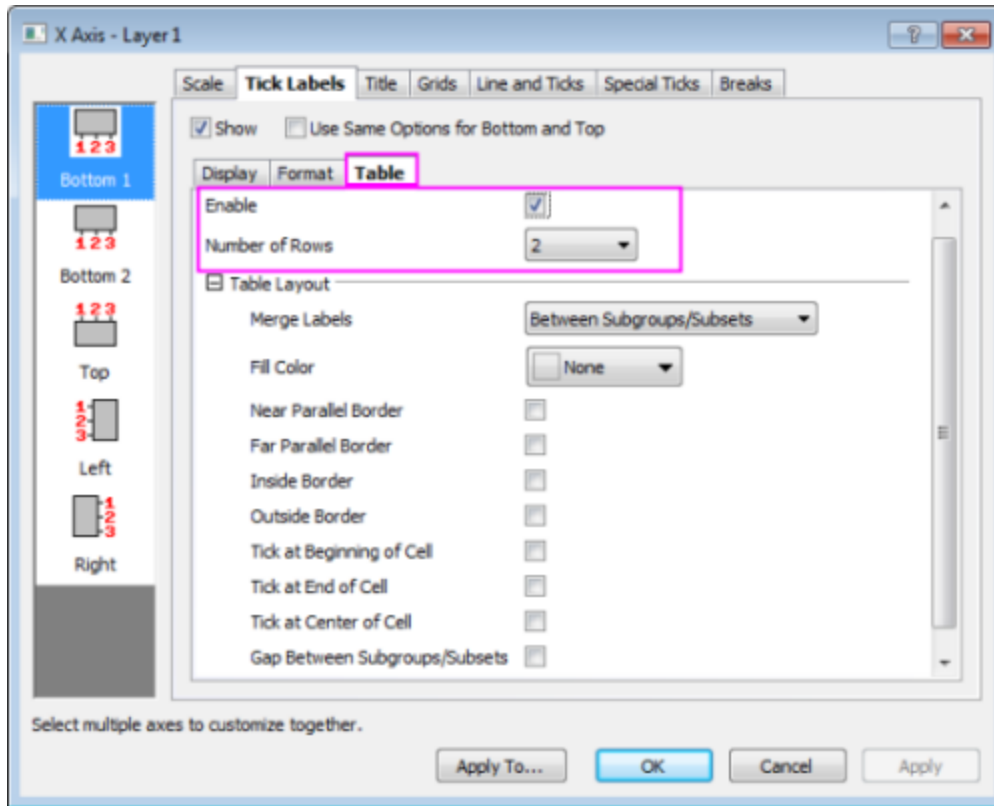

- Select **Bottom2** on the left panel, uncheck the **<Auto>** checkbox and set the font size of **Bottom2** with 11 in **Format** tab, and duplicate settings as shown below in **Table** tab.

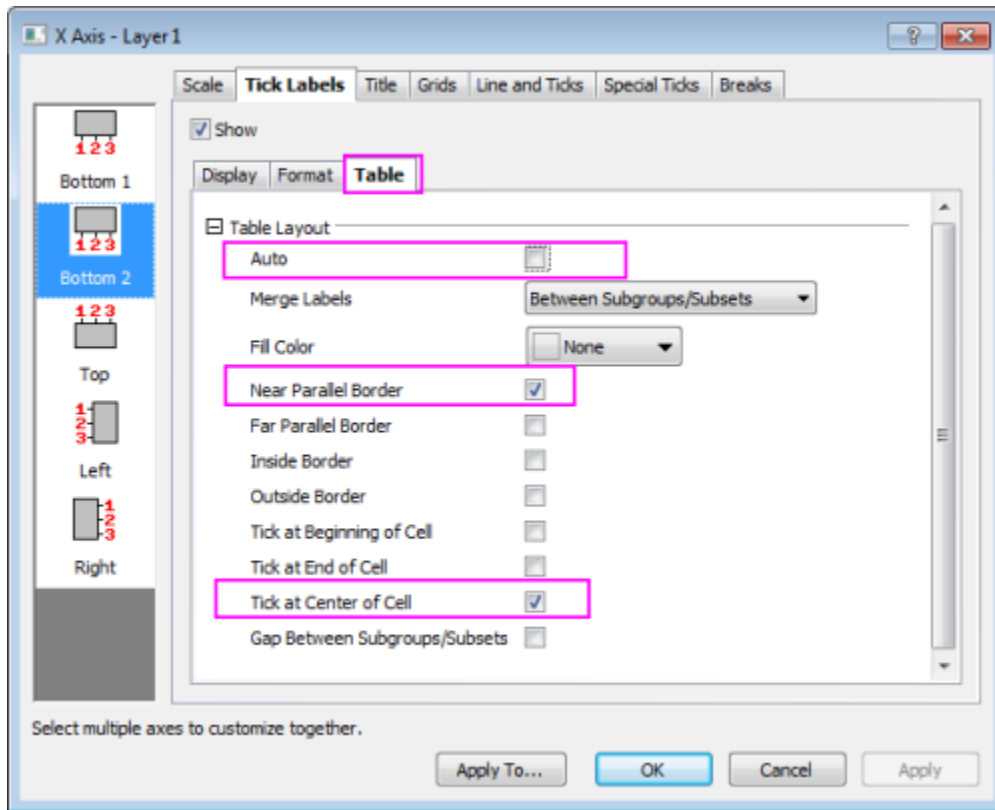

The elements of table layout are shown as below:

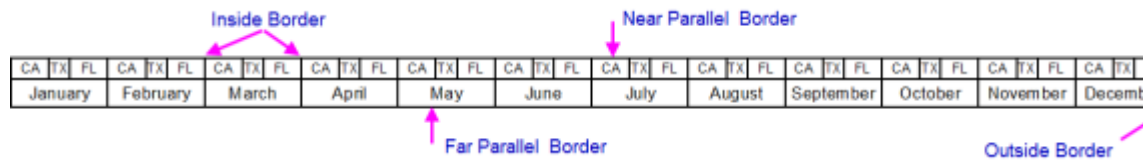

- Go to **Line and Tick** tab, and change the style of major ticks into **In**.

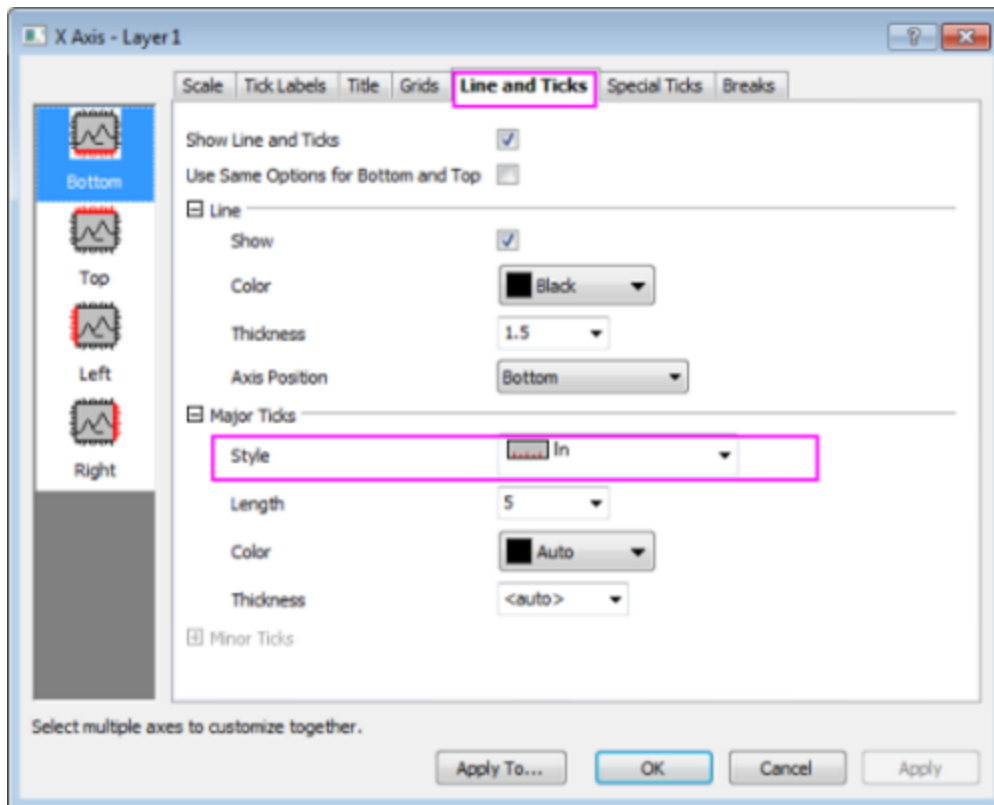

2. For the **Y Axis**, change scale, title, font size of label tick and the style of ticks as shown below:

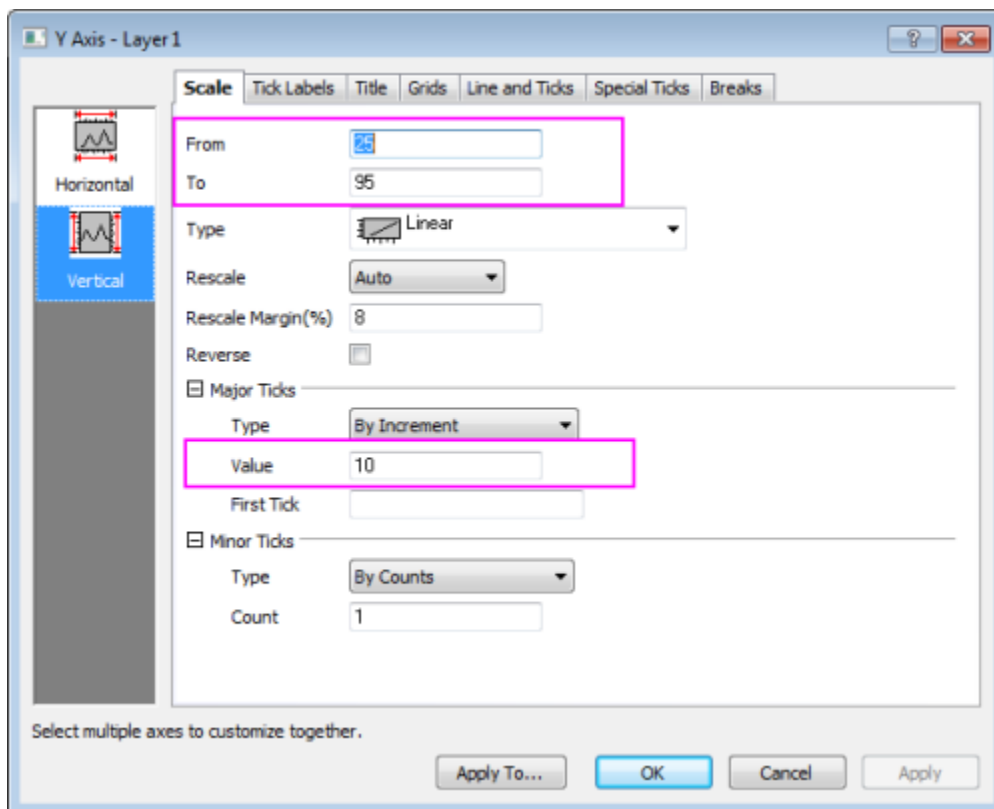

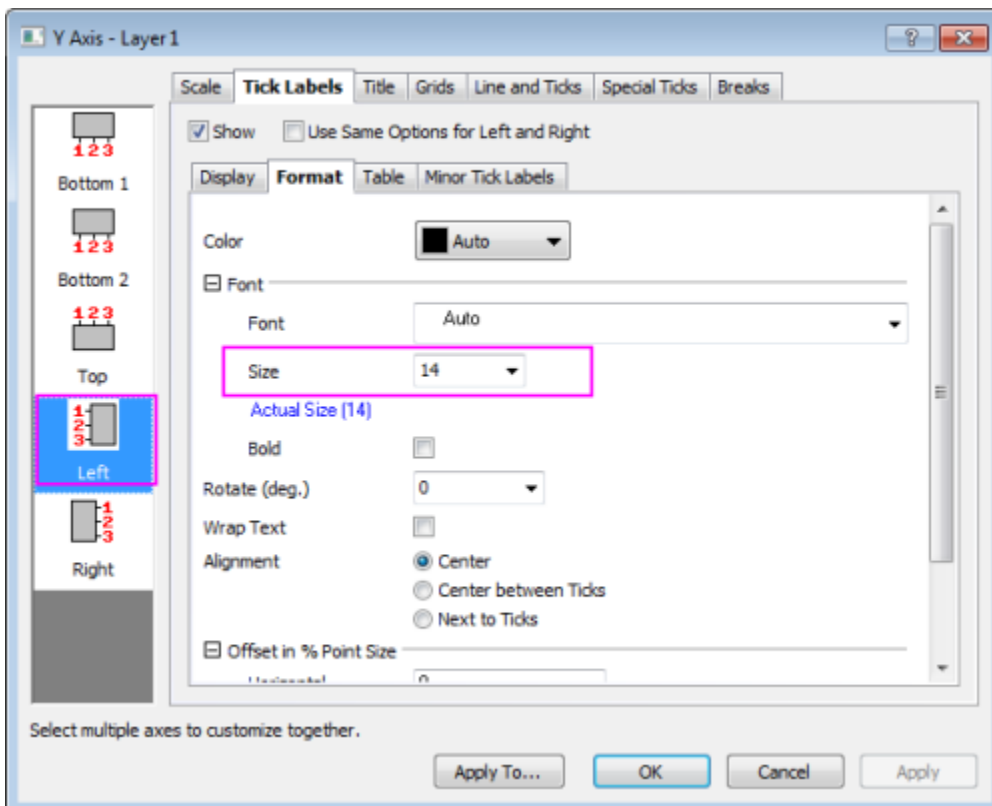
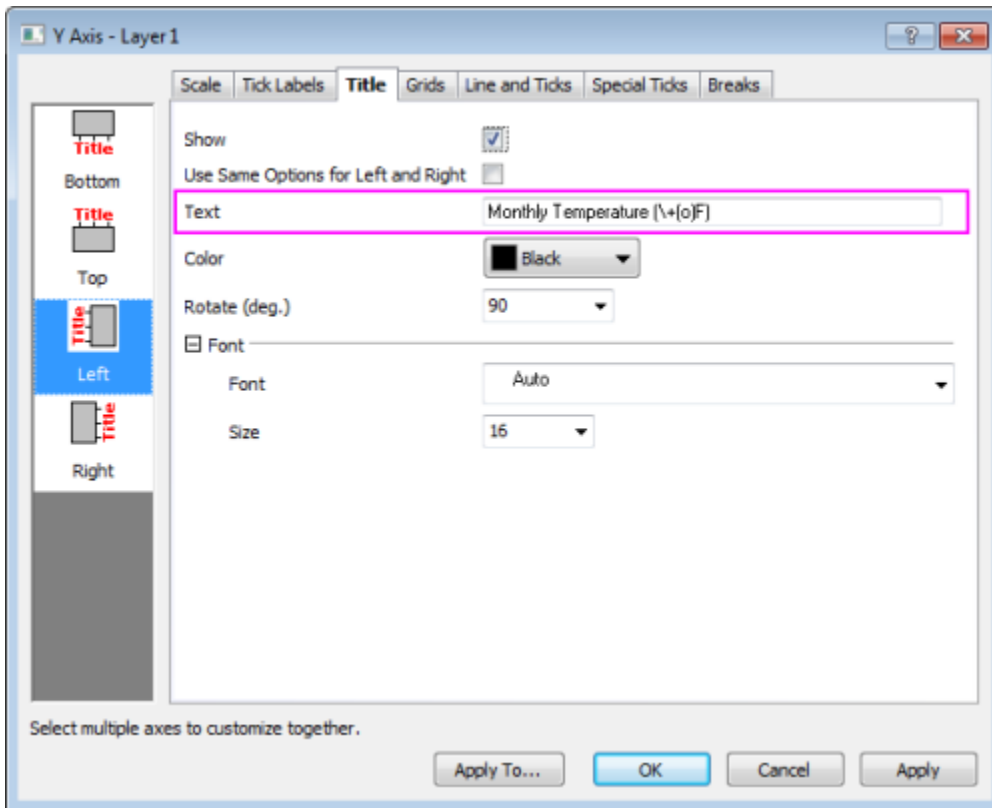

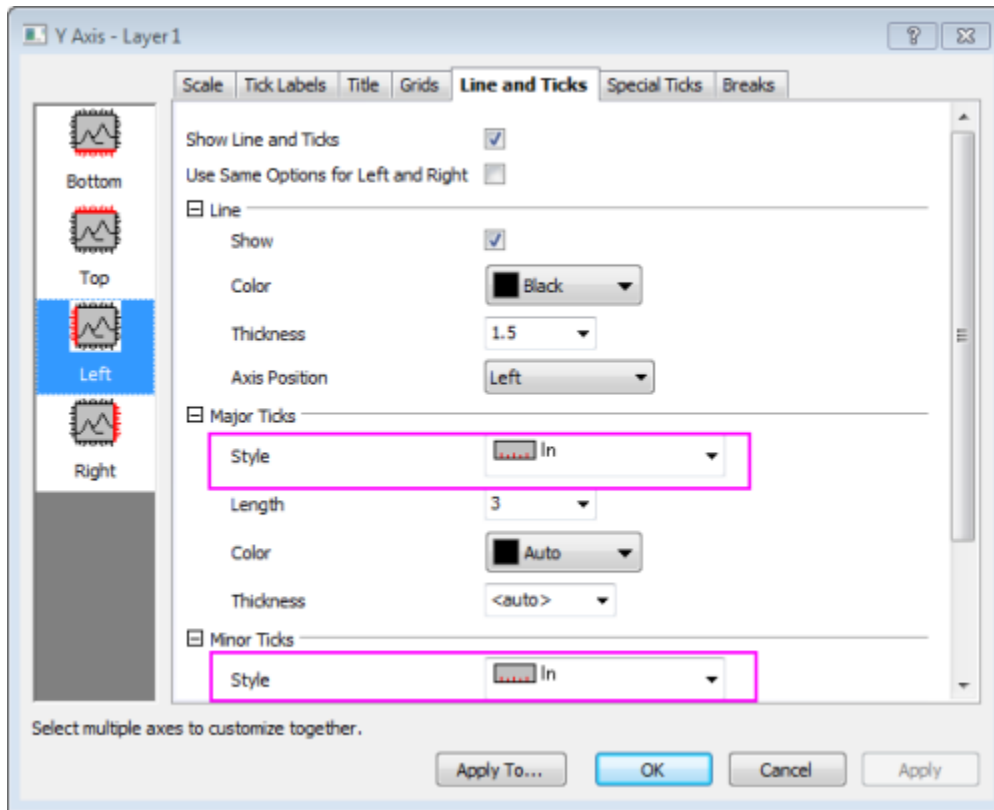

3. Hide the top and right axis of the plot:  
Press CTRL and select both **Top** and **Right** in the left panel, and then go to **Line and Ticks** tab to



uncheck **Show Line and Ticks**.

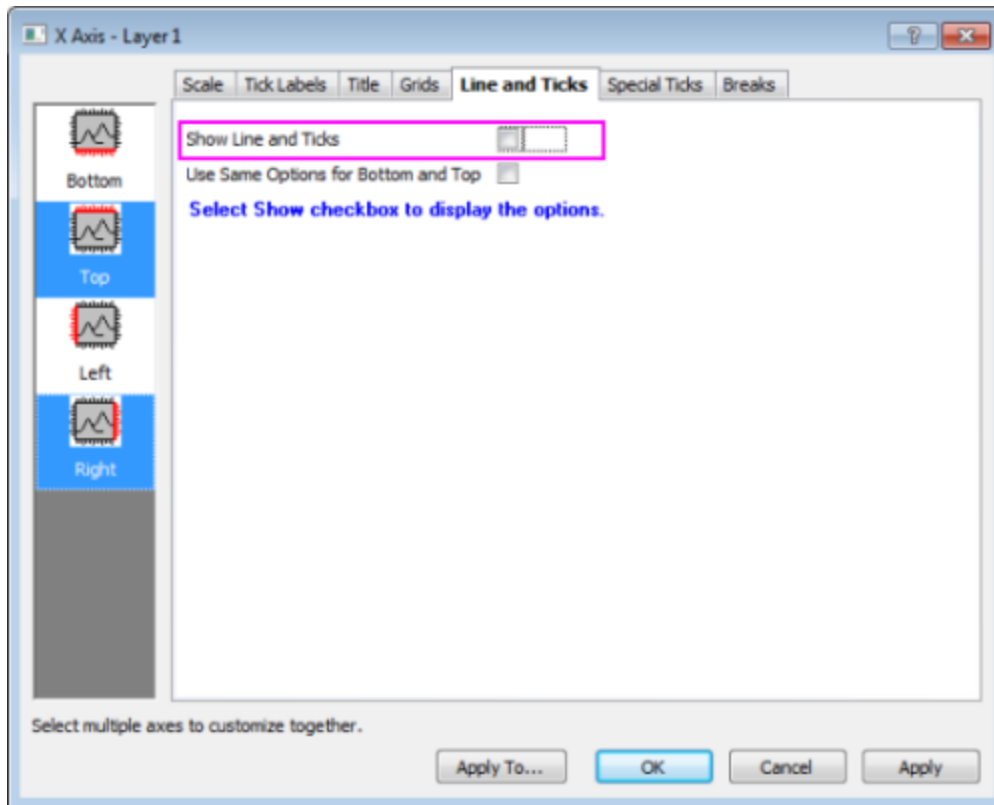

4. Click **OK** to apply your setting.
5. Select **Legend** and press **Delete** to remove it, the graph should appear as below

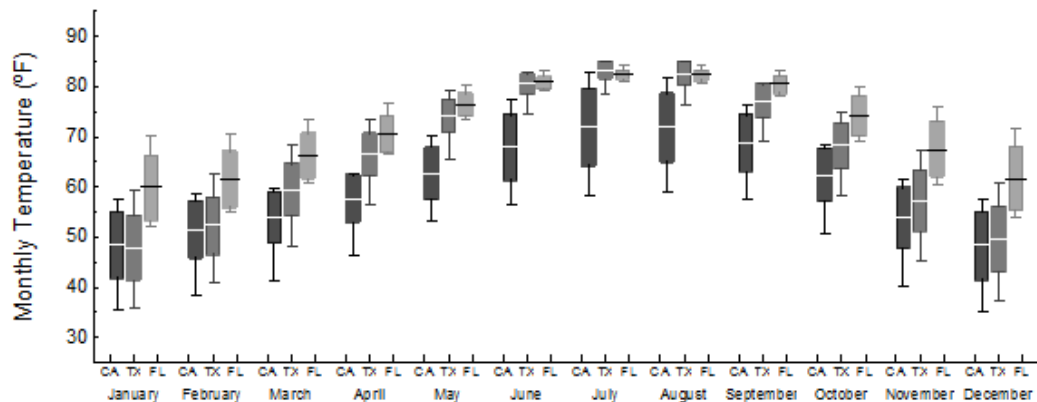

#### 6.11.7.7 Add a graphical symbol of the box into box chart

If you want to add a graphical symbol of to tell the meaning of each line in box, you can follow these steps:

1. Active Workbook **US Mean Temperature**, right click the label of worksheet below and select **Add** to add a new worksheet into workbook.

- Enter 1 to 5 in each row respectively in **Column A**.

	A(X)	B(Y)
Long Name		
Units		
Comments		
F(x)=		
1	1	
2	2	
3	3	
4	4	
5	5	
6		
7		
8		
9		
10		
11		
12		

- Highlight **Column A** and then select **Plot > Statistical: Box Chart** to create a simple box chart.

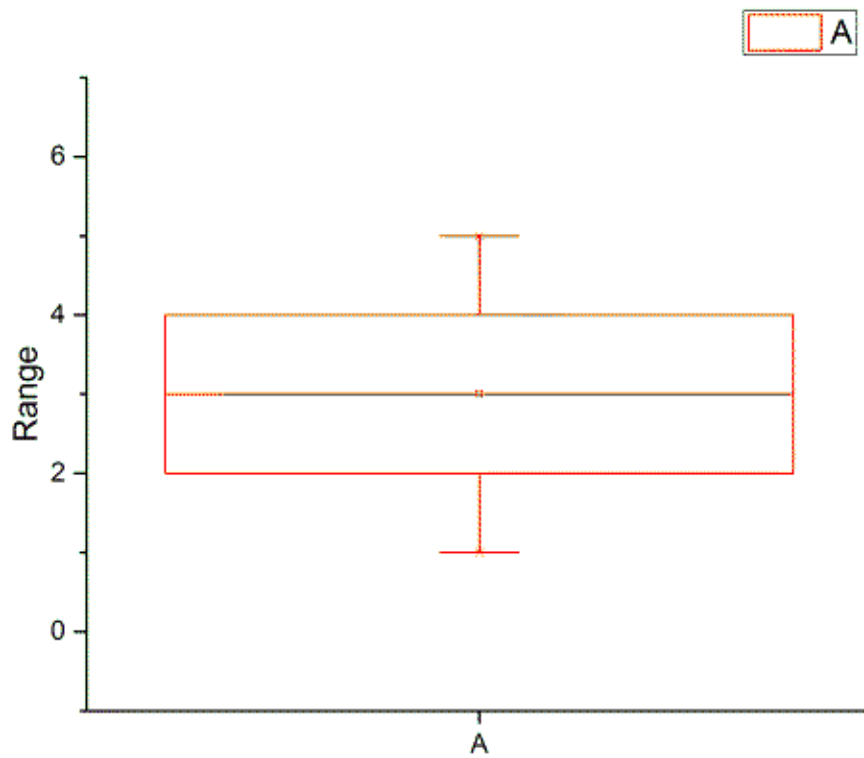

- Double click the plot to open the **Plot Details** dialog.

5. To object **Graph2**, set the width and height of page on **Print/Dimension** tab.

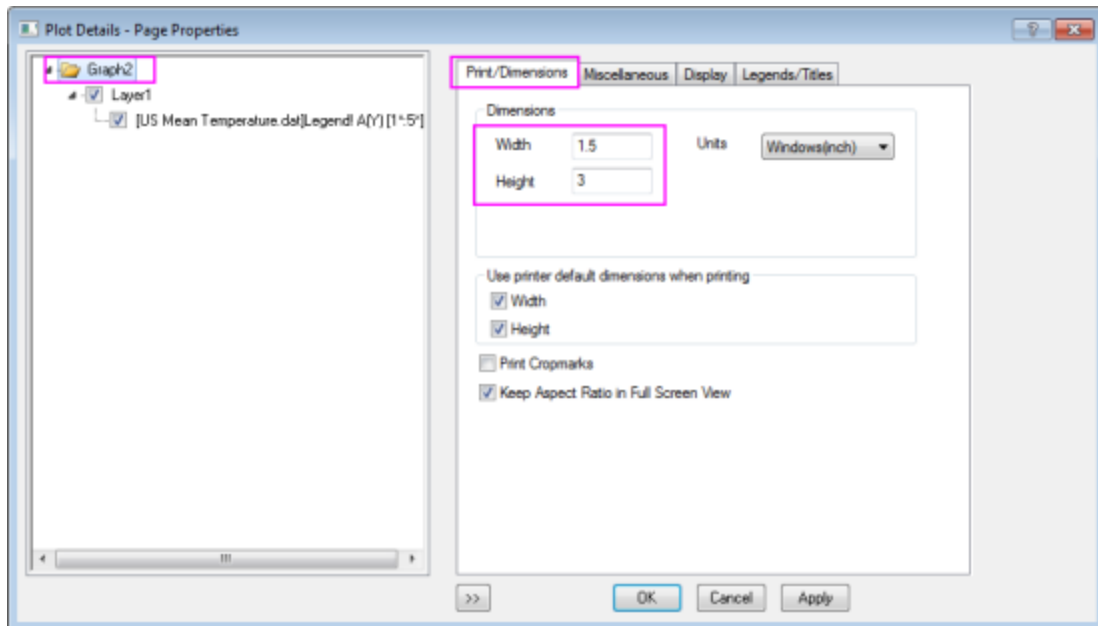

6. To object **Layer1**, go to **Size/Speed** tab and set the size of **Layer1**.

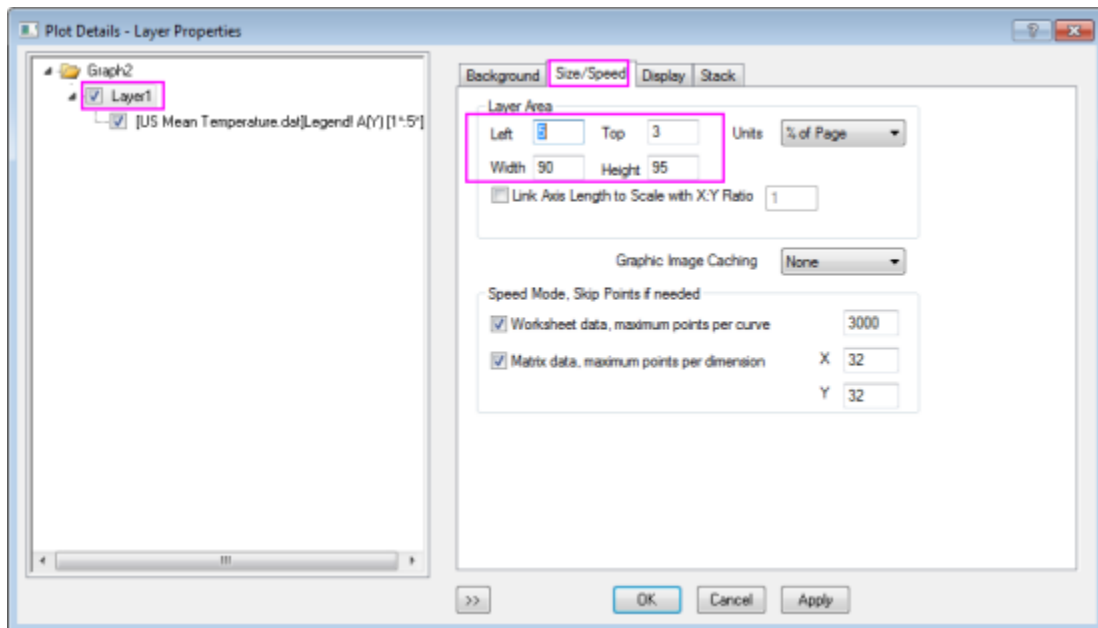

- To object box, go to **Pattern** tab and set as shown below.

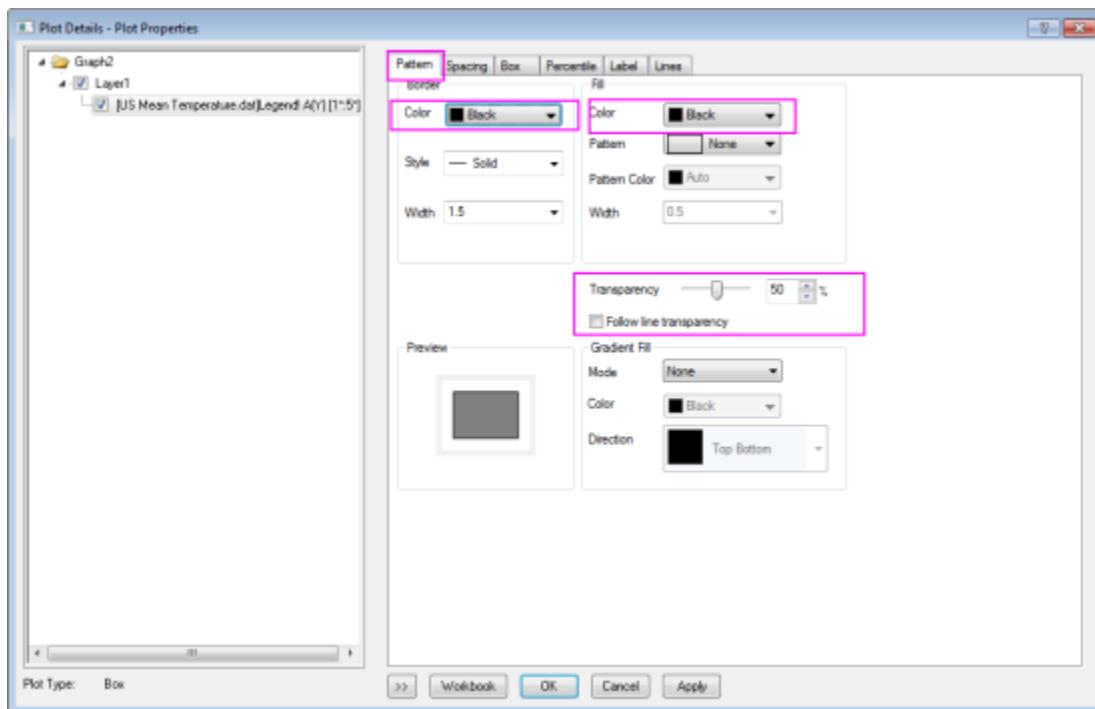

- Go to **Percentile** and **Line** tab, and select the same setting of grouped box chart **Graph1**.

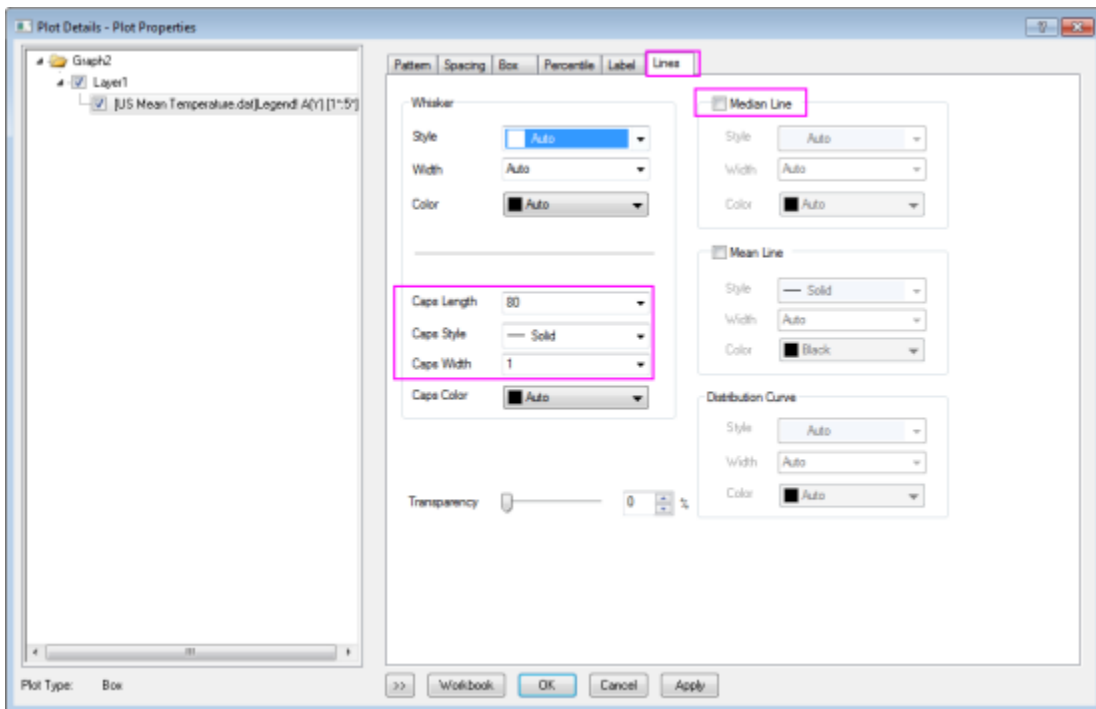
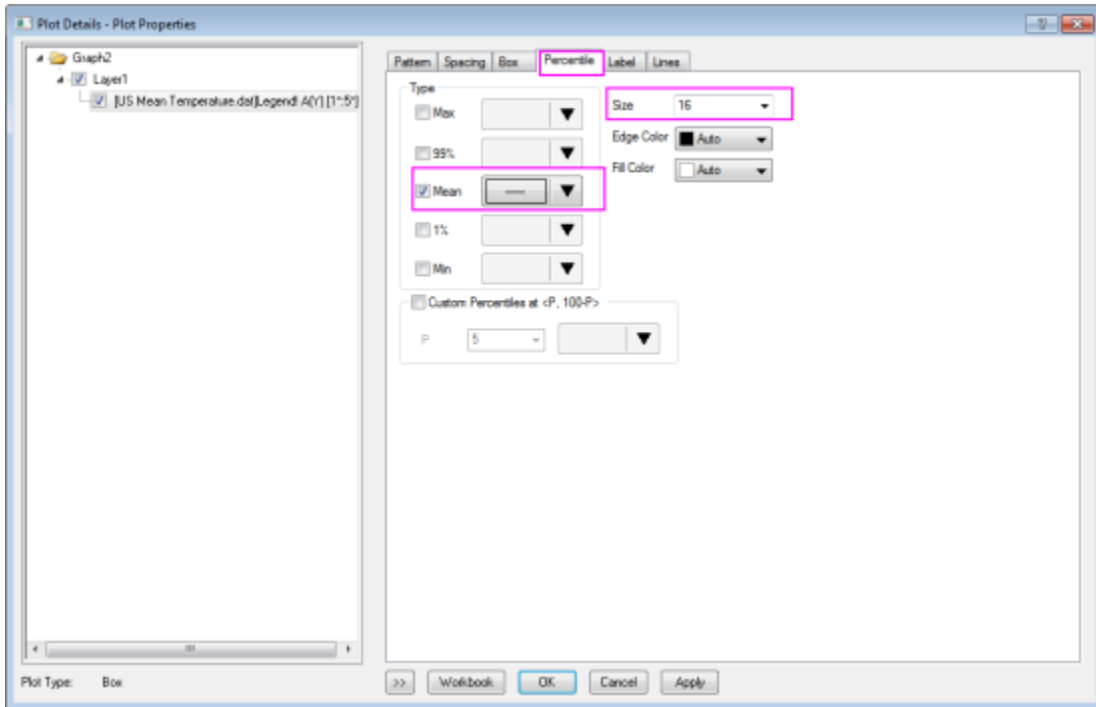

- Go to **Box** tab, check the box before **Box Label**, **Whisker Label** and **Mean Value Label**, and shown them in **Percentile**, and then change the width of box into 20%, besides set the range of box and

whisker.

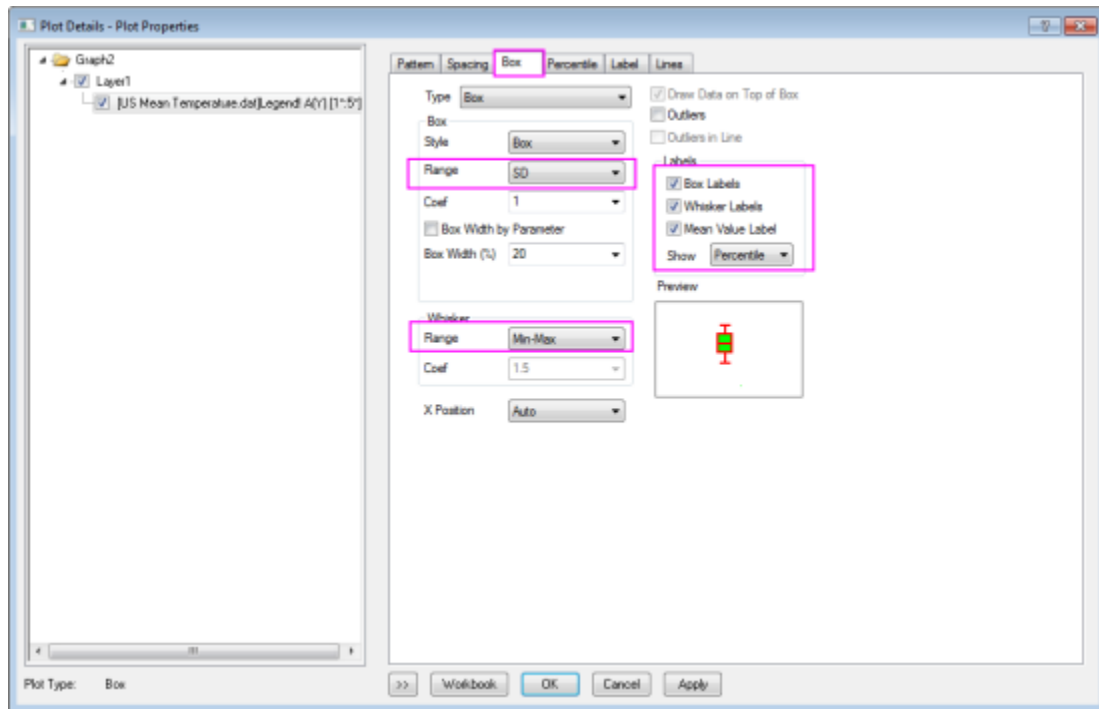

10. Click **OK** to apply your setting.

11. Select and delete X axis, Y axis, Y axis title **Range** and **Legend** of **Graph2**.

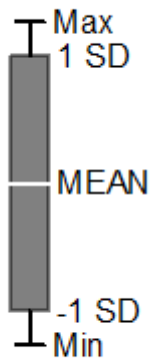

12. Press CTRL + C in **Graph2**, and then press CTRL + V in **Graph1** to copy the graphical symbol into the box chart.

13. Select the graphical symbol in **Graph1**, and then resize it and move it to a nice location.

At last, you will get the final graph.

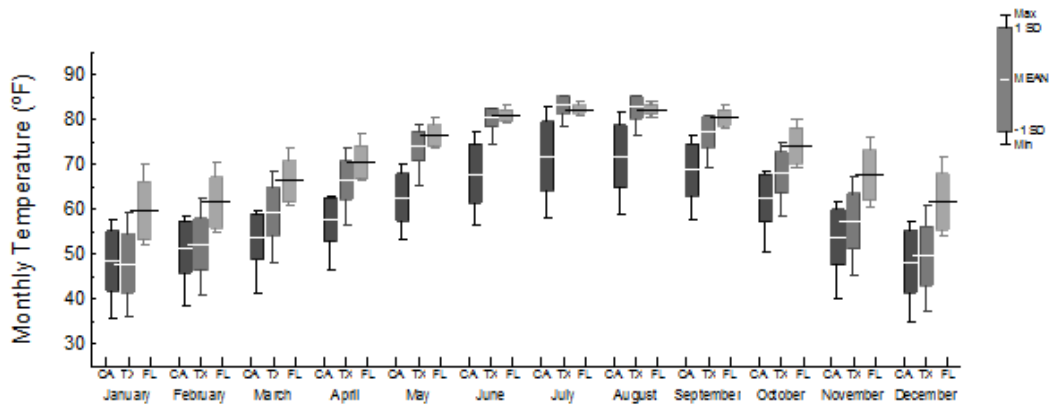

### 6.11.8 Unbalanced Grouped Box Chart

#### 6.11.8.1 Summary

Origin can be used to create unbalanced grouped box plots from raw data with custom table axis.

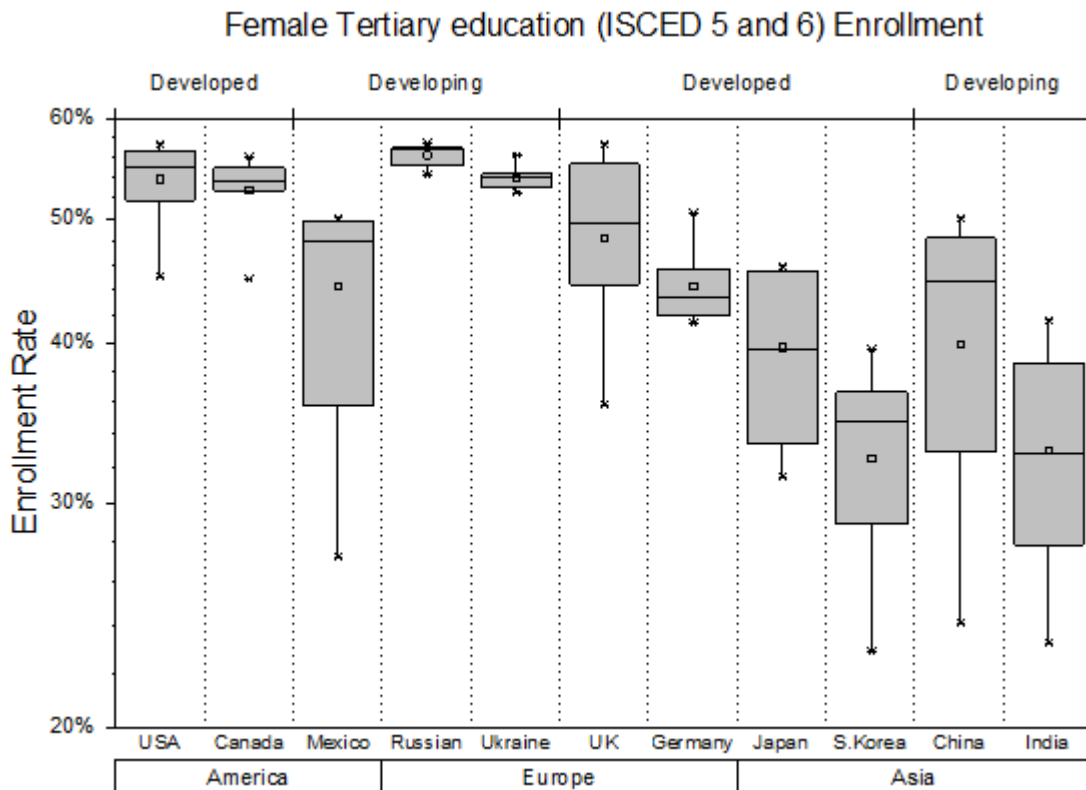

Minimum Origin Version Required: 2015 SR0

#### 6.11.8.2 What you will learn

This tutorial will demonstrate how to:

- Create a unbalanced grouped box plot from raw data
- Add a top axis table row with additional grouping information
- Customize the table-axes

### 6.11.8.3 Steps

#### 6.11.8.3.1 Creating the Box Plot from Raw Data

This tutorial is associated with <Origin EXE Folder>\Samples\Tutorial Data.opj.

1. Open **Tutorial Data.opj** and browse to the folder *Unbalanced Grouped Box Chart*.
2. Activate the workbook **Book 3**.
3. Highlight all the columns except col(A), select **Plot> Categorical: Grouped Box Charts - Raw Data** menu to open the **Plotting: plotgboxraw** dialog. In the dialog, set the **Group Number** to **2**, the **1st Group Row** to **Continents** and the **2nd Group Row** to **Country**. This will create a box chart with the column data arranged in three groups, with X axis row names derived from the two selected label rows on the worksheet:

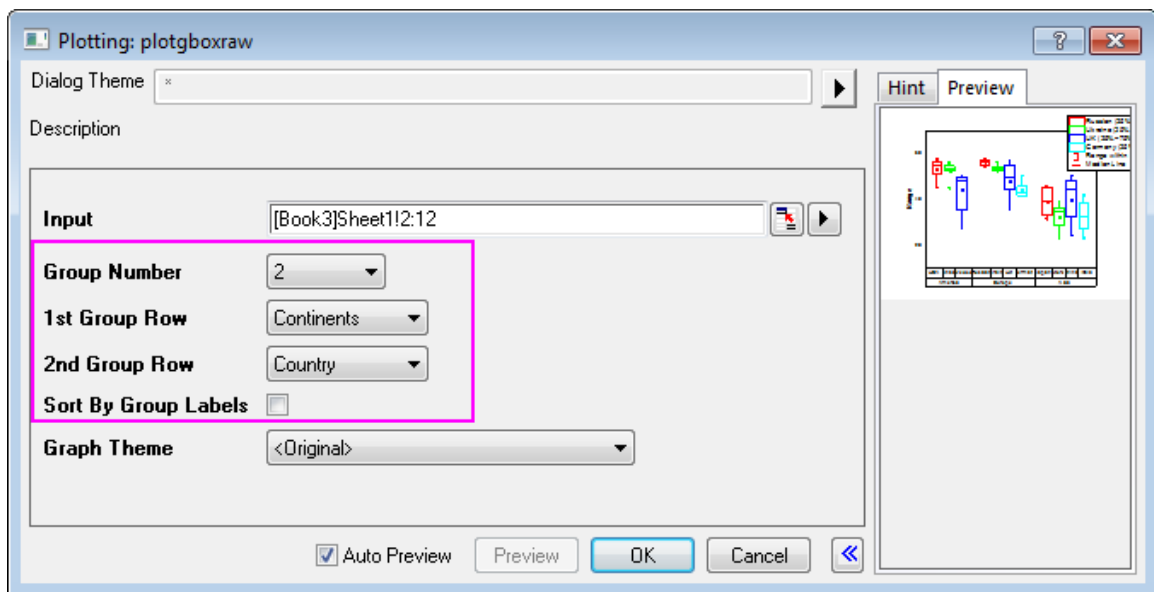

4. Click the **OK** button. Select the legend and delete it and the grouped box chart from raw data is created with two grouping levels as shown below:



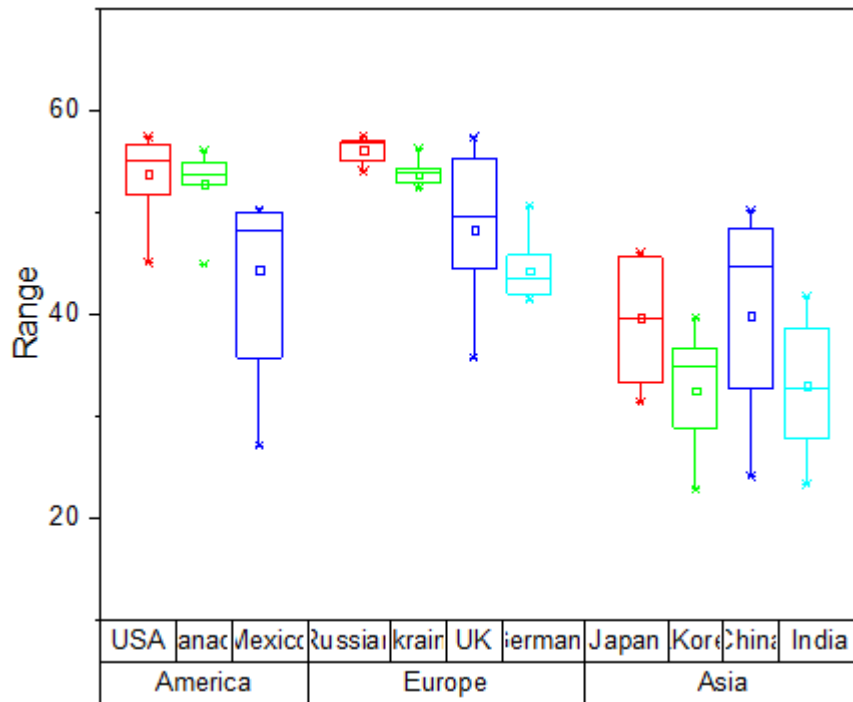

### 6.11.8.3.2 Customizing the axis table to display unbalanced groupings

1. The color and sub-group gap need some work. So, begin by changing all boxes to gray. Select **Format: Plot** from the menu. In the **Plot Details** dialog box, click the Group tab. Set **Border Color Increment** to **None** and **Subgroup** to **None**, so that box border color does not increment by dataset.

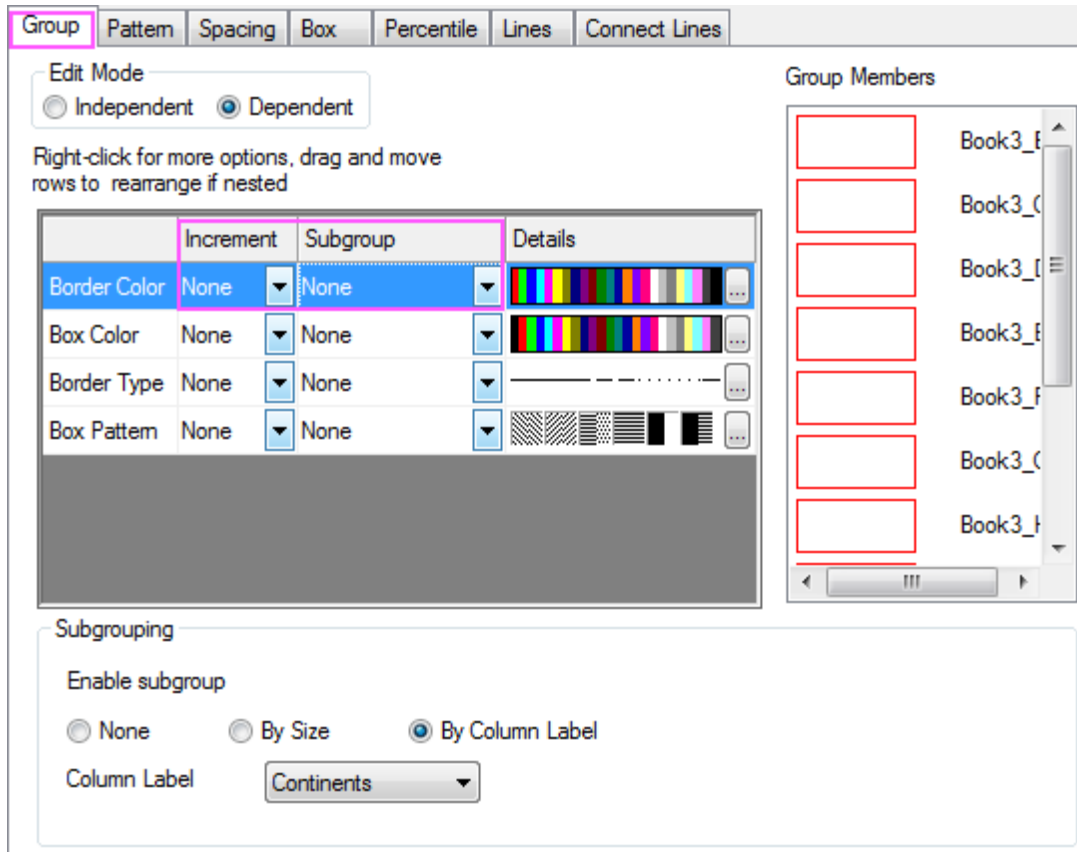

2. Go to the **Pattern** tab and duplicate the settings as shown below:

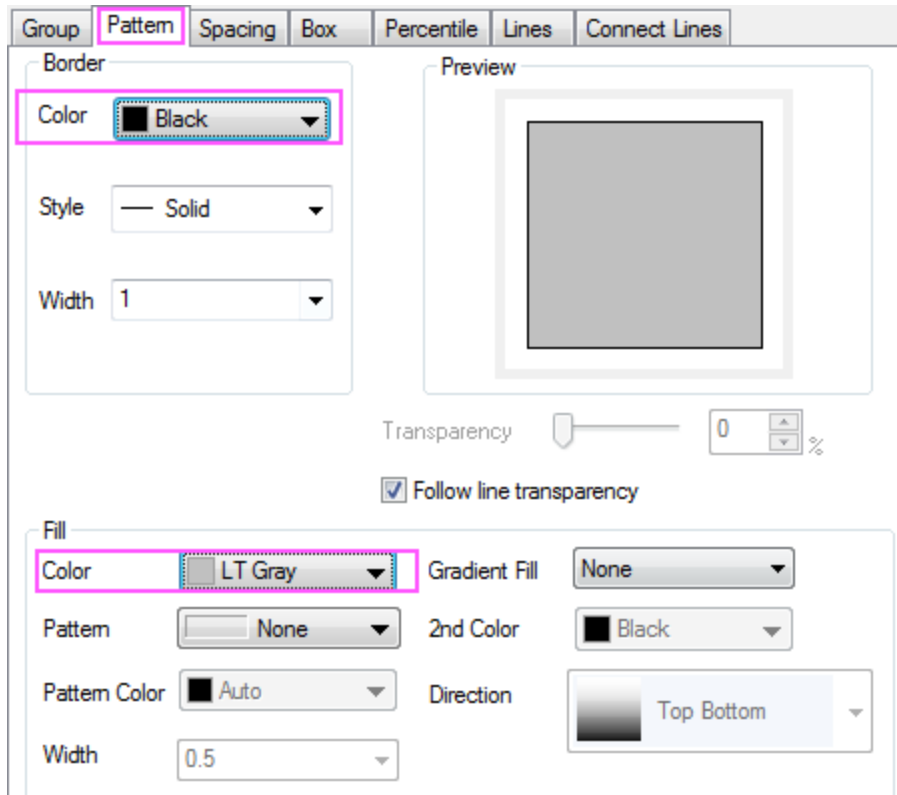

- Go to the **Spacing** tab and set **Gap Between Subgroups (in%)** to **0** to remove the gap between sub-groupings.

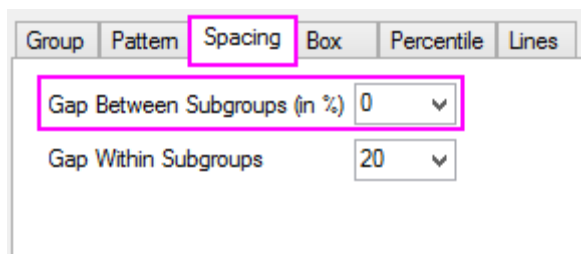

- Click **OK** to apply the settings. Now our unbalanced grouped box chart is correctly drawn (we will adjust the labels later).

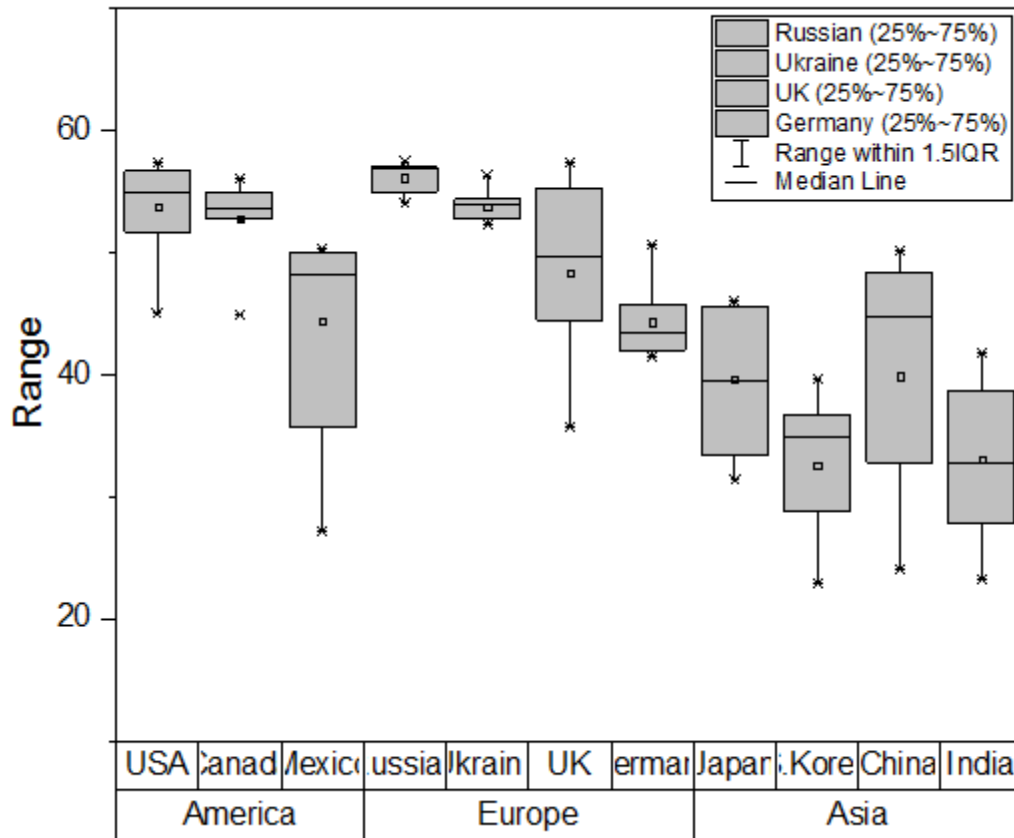

### 6.11.8.3.3 Add a top axis table row

We will now add an axis table top of the graph to display extra grouping information.

1. Open the **Axis Dialog** again (**Format: Axes: X-Axis**). Go to **Tick Labels** tab and click to highlight the **Bottom 1** icon only on the left panel.
2. Go to **Table** tab in **Tick Labels** page and change **Number of Rows** to **3**.

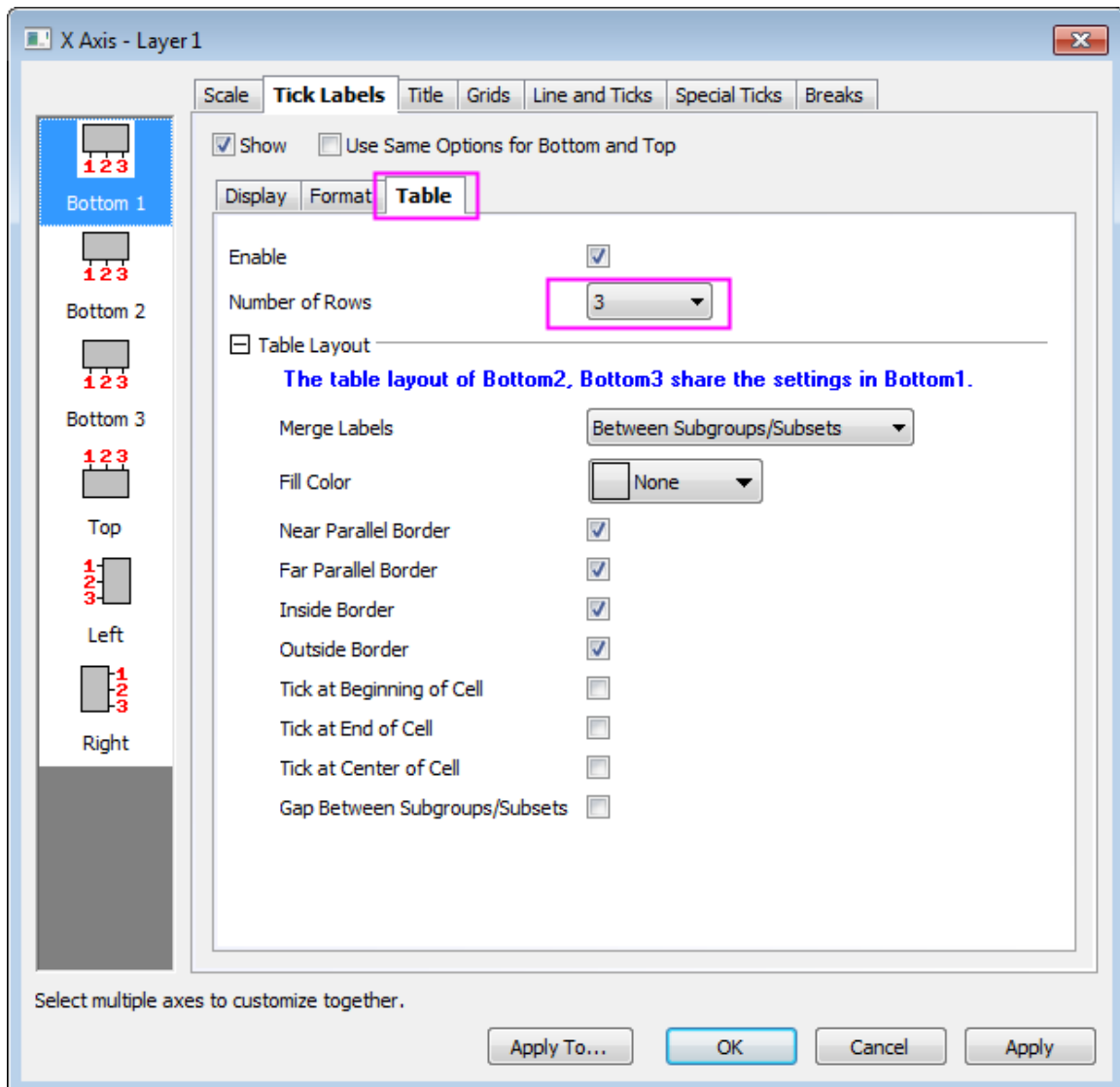

3. Click to select the newly added **Bottom 3** icon on the left panel and go to **Display** tab to set the **Display** list to **Rank** (note that this is another worksheet label row).

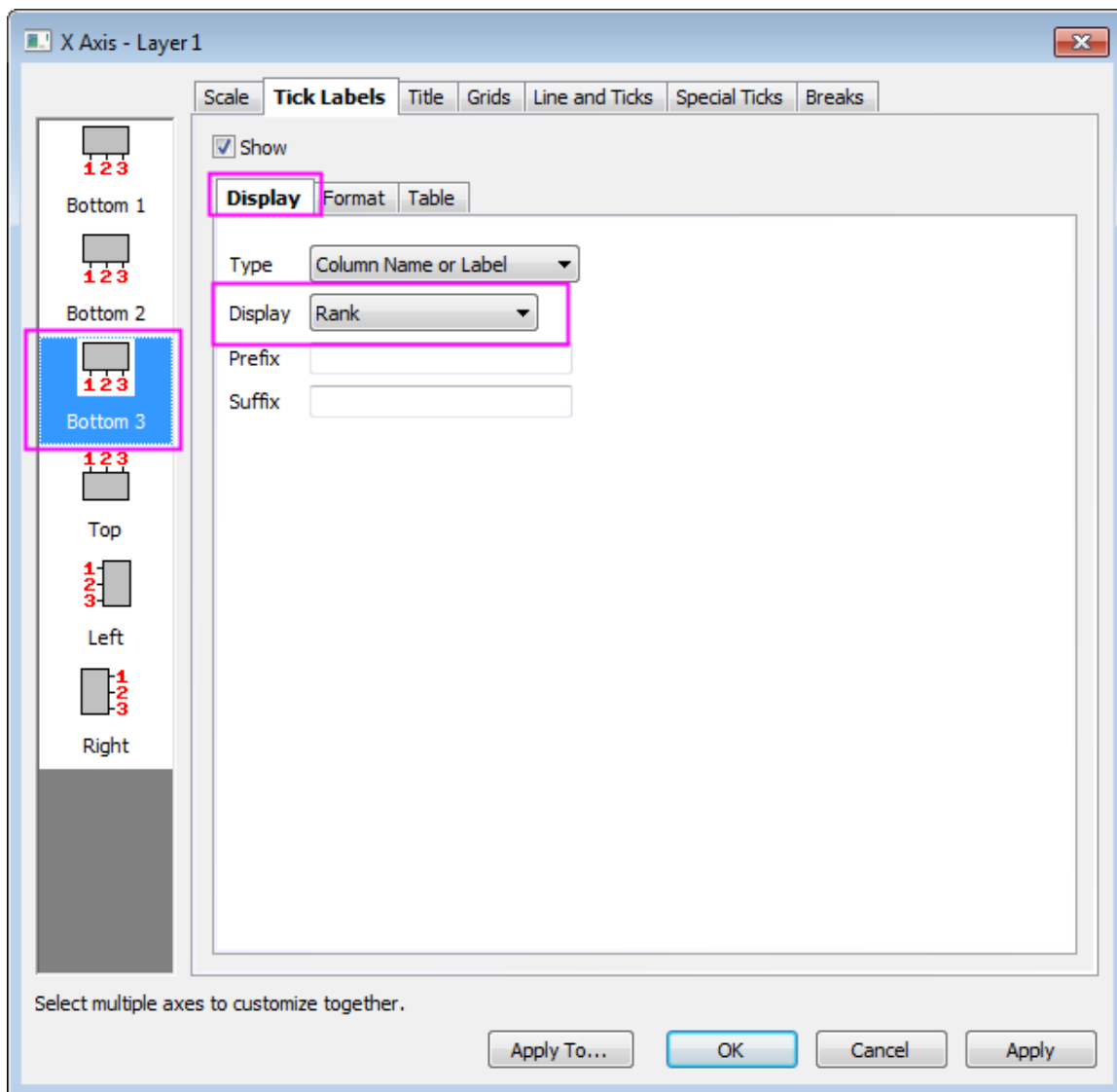

4. Click **Apply** to see the changes. A new table row is added to the bottom X axis. Next, we will move it to the top of the graph.

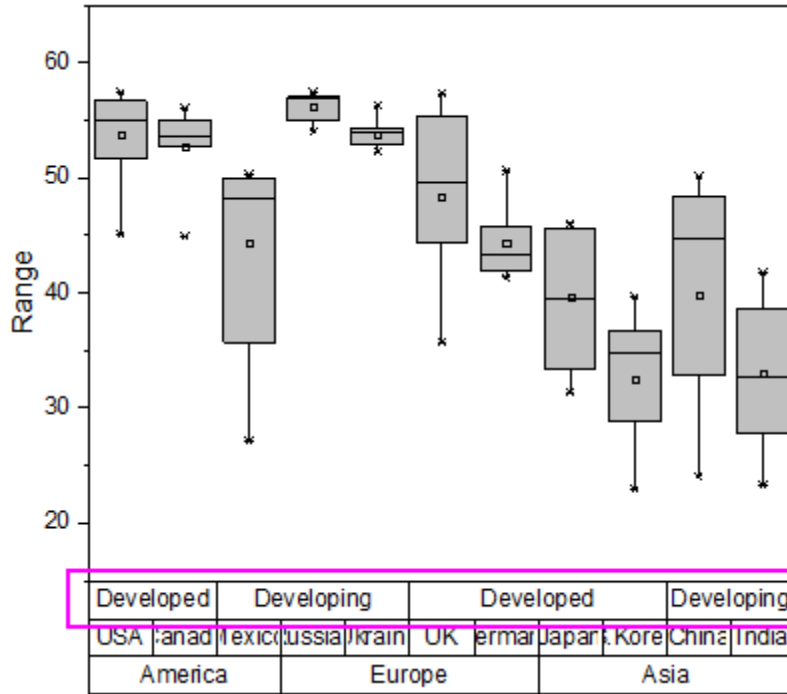

- Right click the **Bottom 3** icon on the left panel and select **Move to Opposite**.

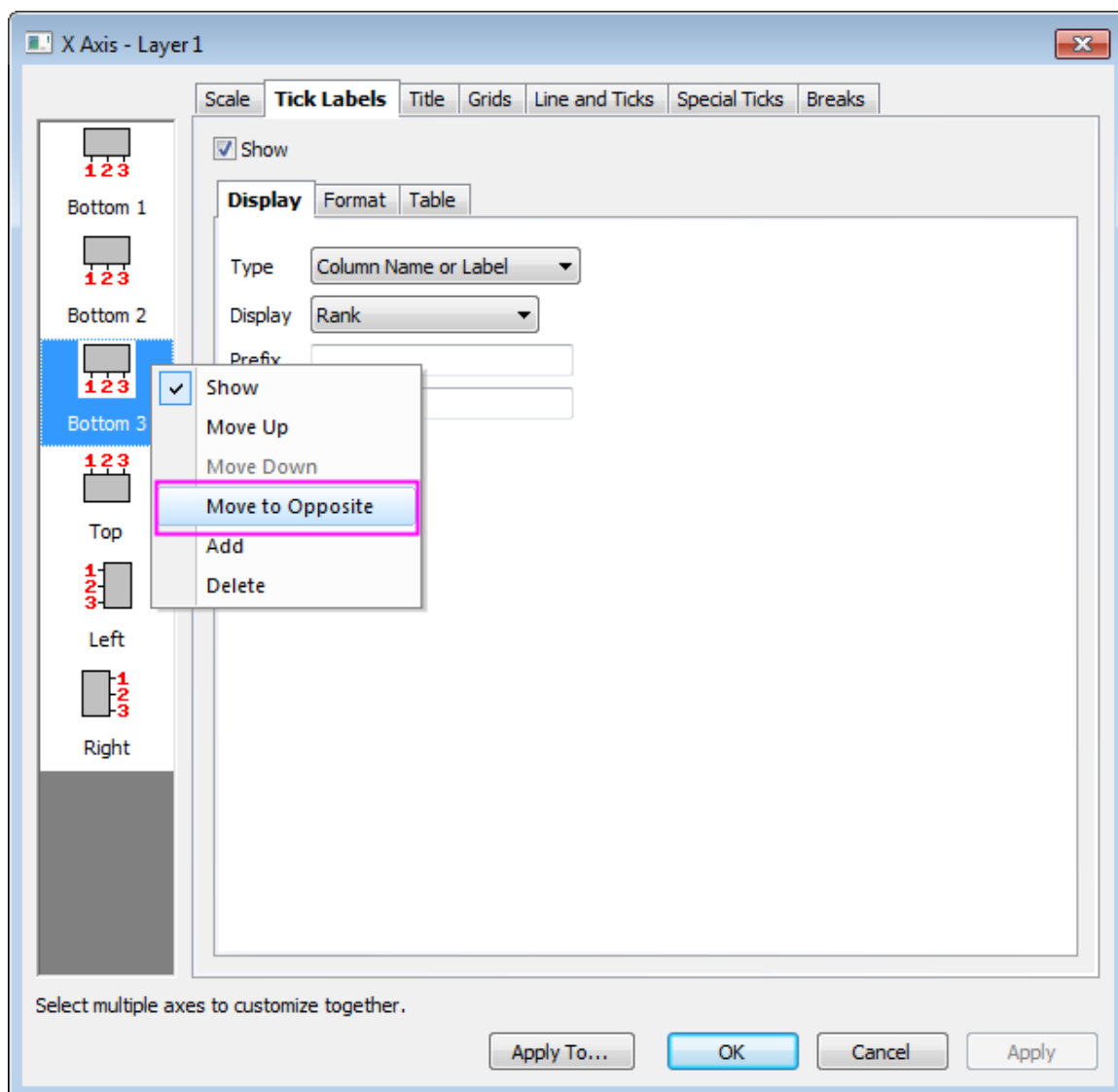

6. Click **OK** to apply the change.



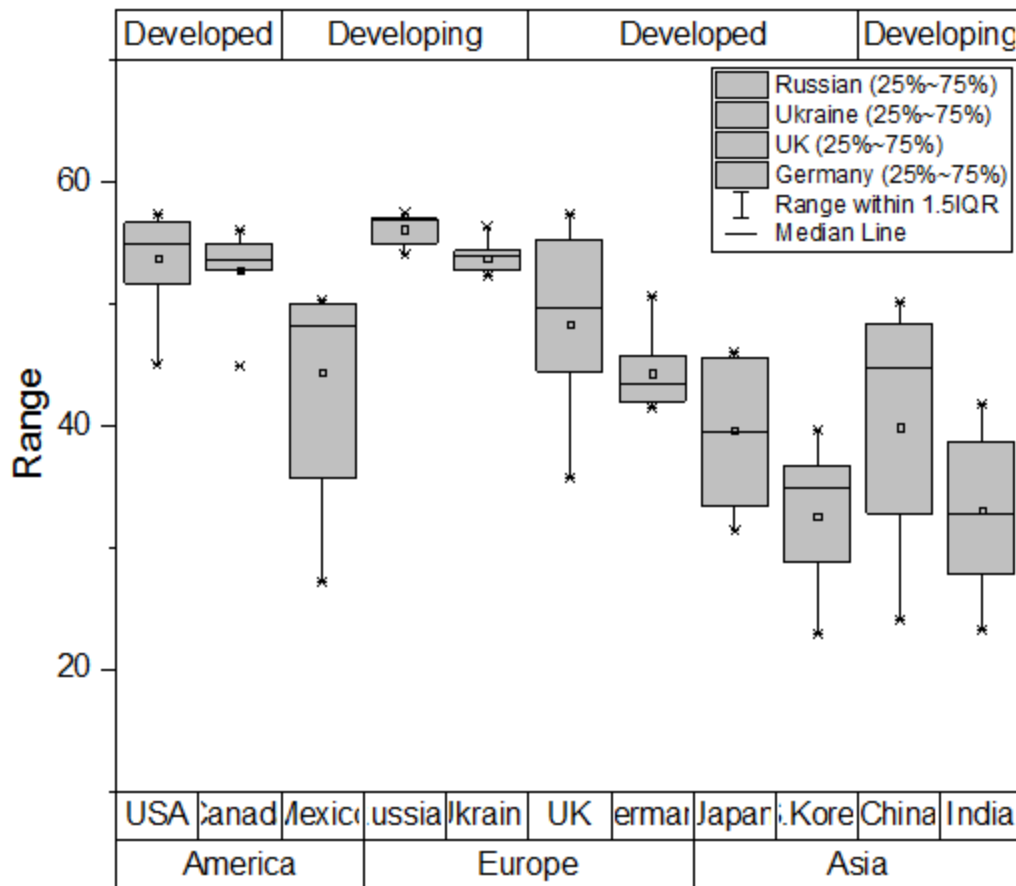

6.11.8.3.4 Further customization

Now, let's do some further customization so that our graph looks like the one pictured in the introduction to this tutorial.

1. Double click on the grouping table on the bottom of graph to bring up **Axis Dialog**, go to **Tick Labels** tab and click to select **Bottom 1** icon only again.
2. Go to **Table** tab, clear the **Far Parallel Border** check box for **Bottom 1**.

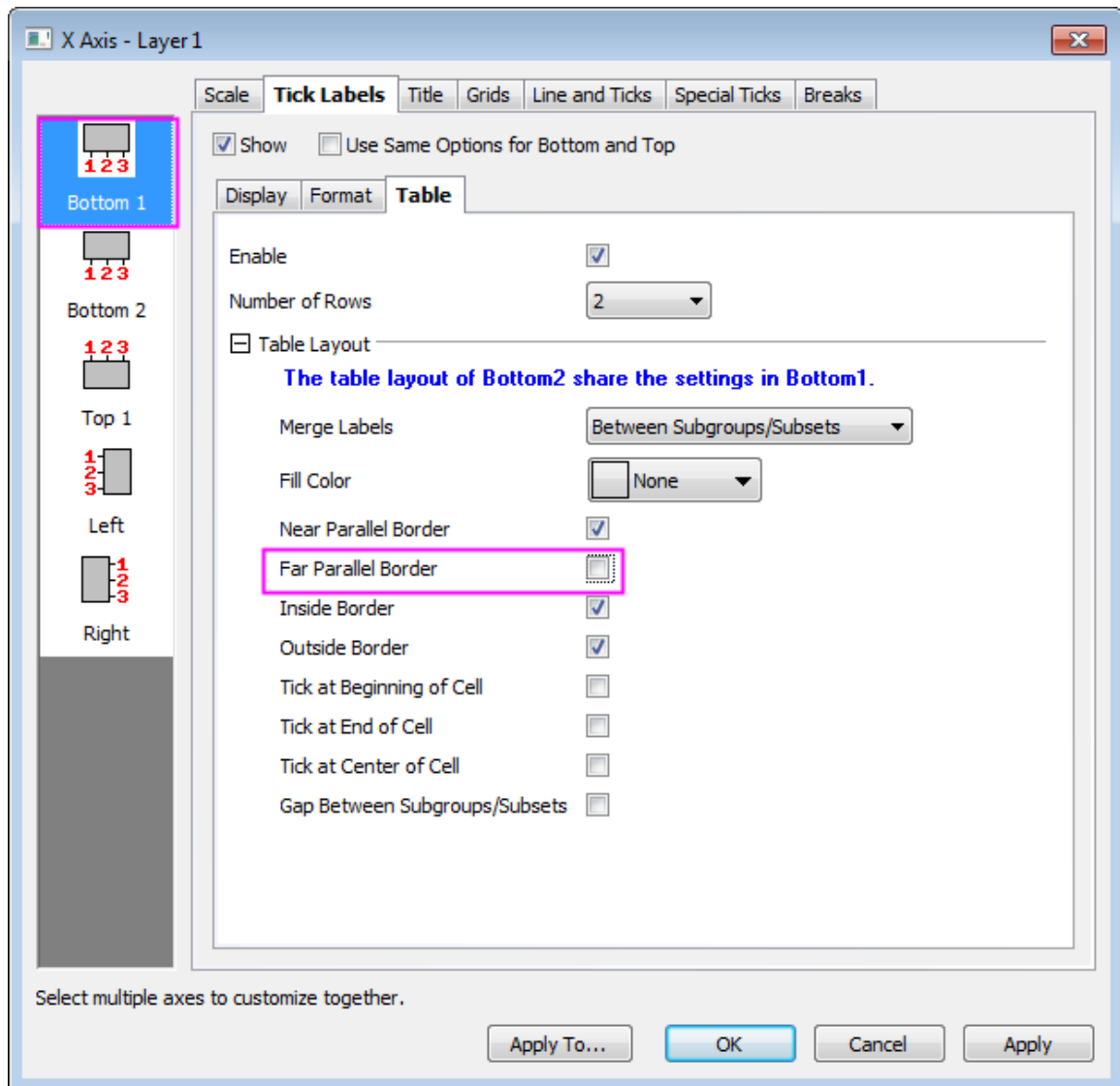

3. Click to highlight the **Bottom 2** icon on left panel, uncheck **Auto** box and clear the **Inside Border** and **Outside Border** check boxes.
4. Click to highlight the **Top 1** icon on left panel and clear the **Far Parallel Border**, **Inside Border** and **Outside Border** check boxes. Select the **Tick at Beginning of Cell** and **Tick at End of Cell** check boxes.

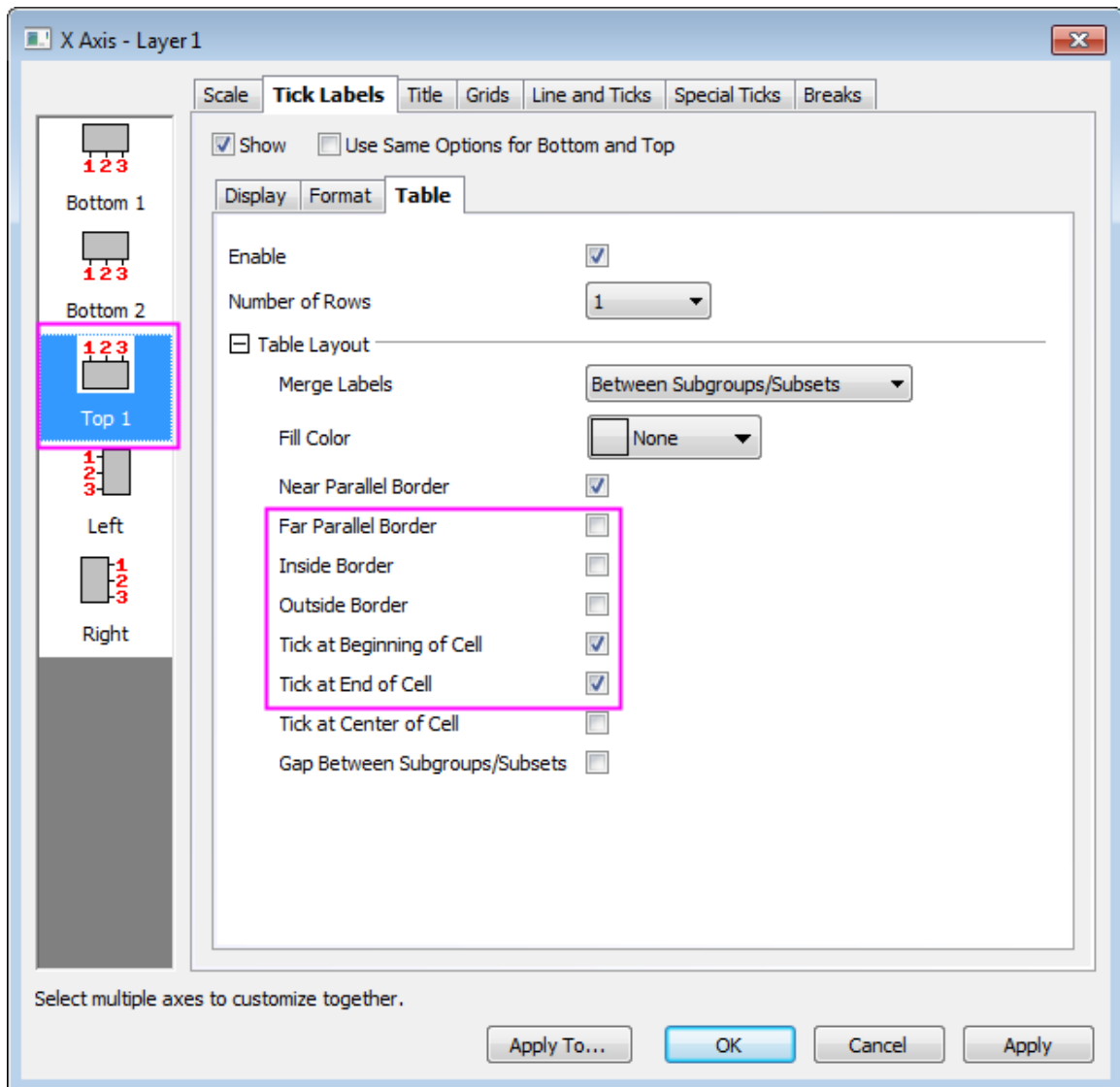

5. Click **Apply** and then go to **Line and Ticks** tab and set **Style** under **Major Ticks** node to be **In & Out**.

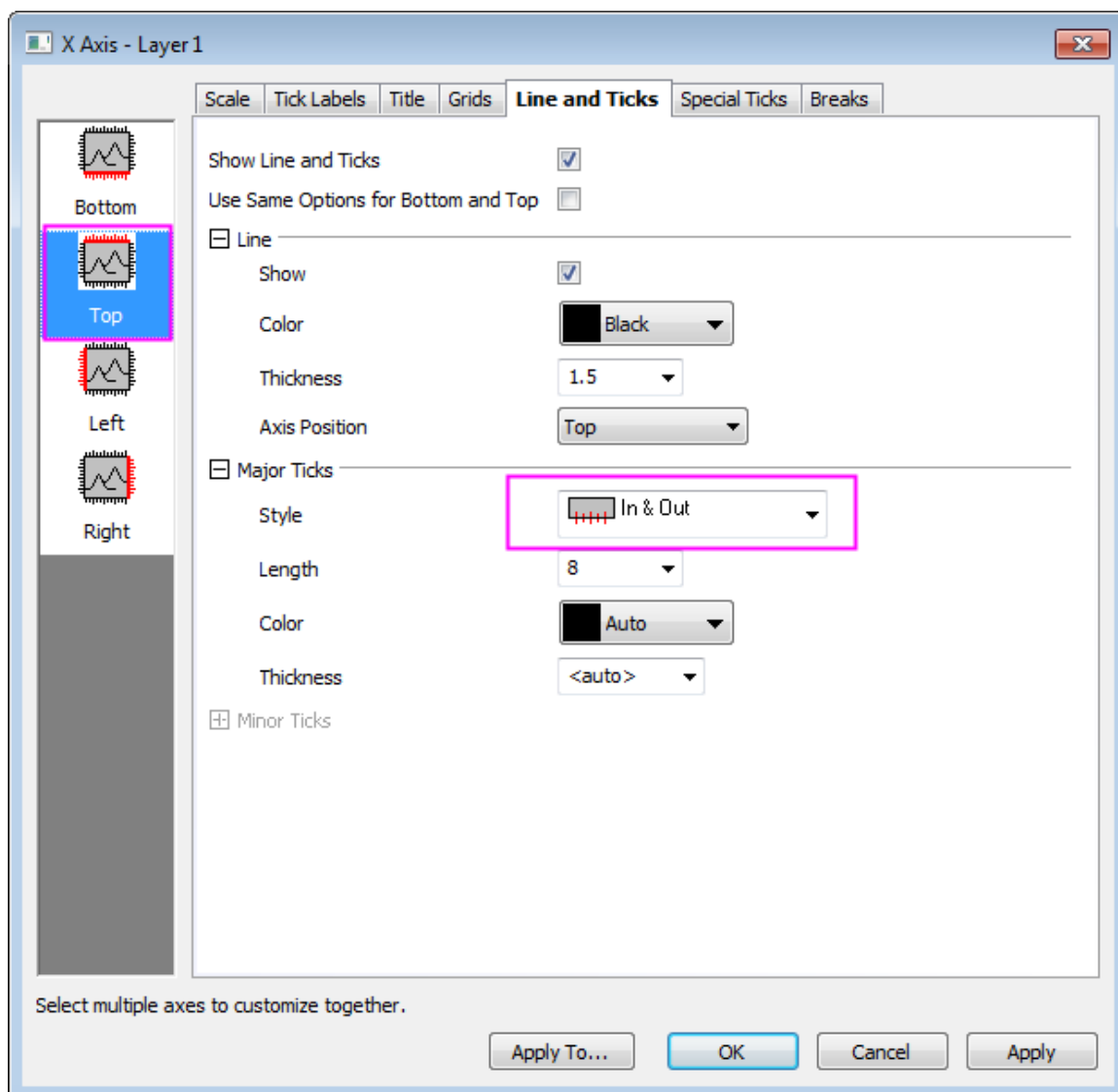

6. Go to **Grids** tab and customize both major and minor grid lines settings as **Color = Black**, **Style = Dot** and **Thickness = 0.5**.

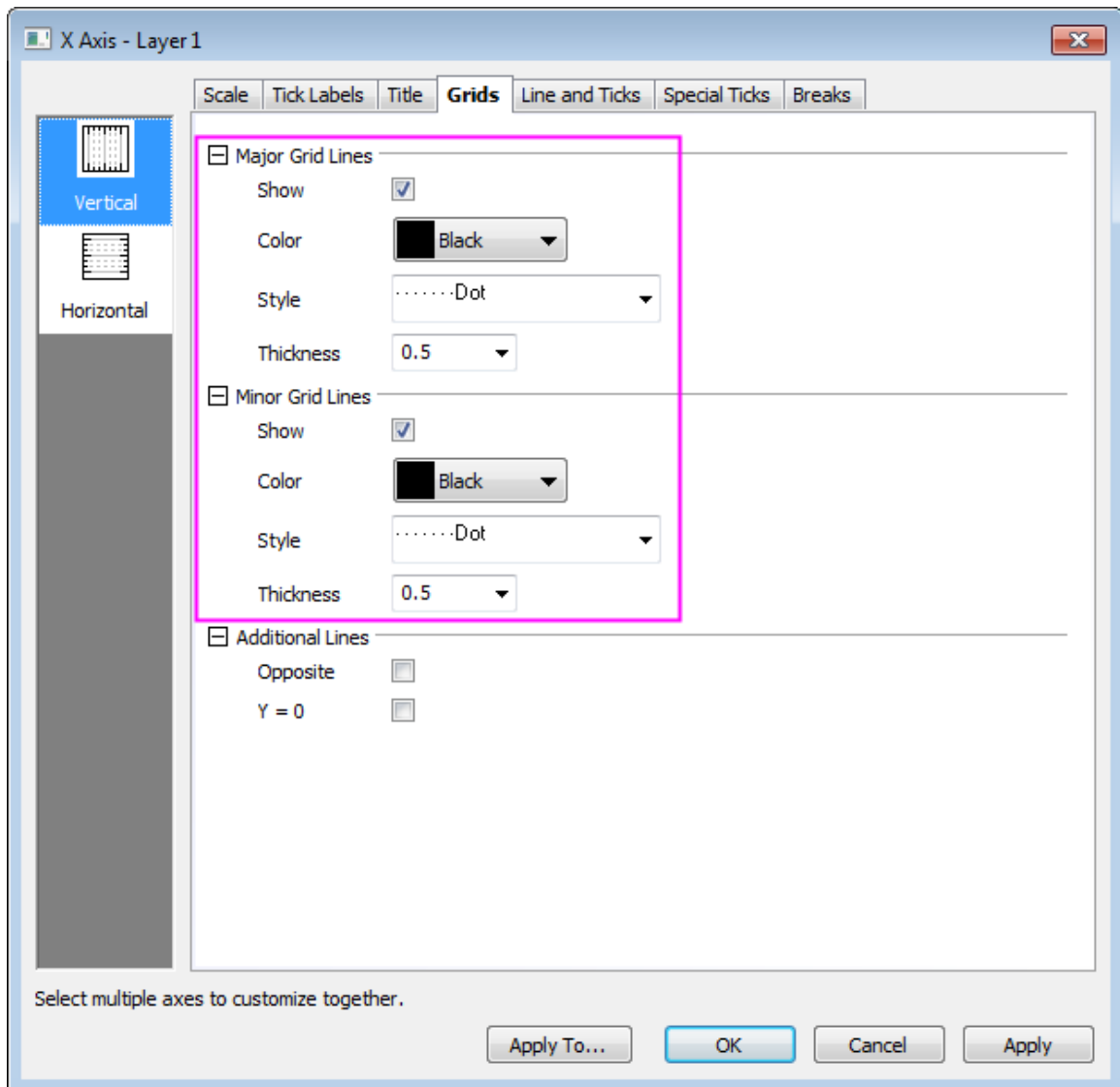

7. Click **Apply** and go to **Scale** tab, click **Vertical** icon on left panel and change scale **Type** to **Log10**, and adjust the other settings as shown below.

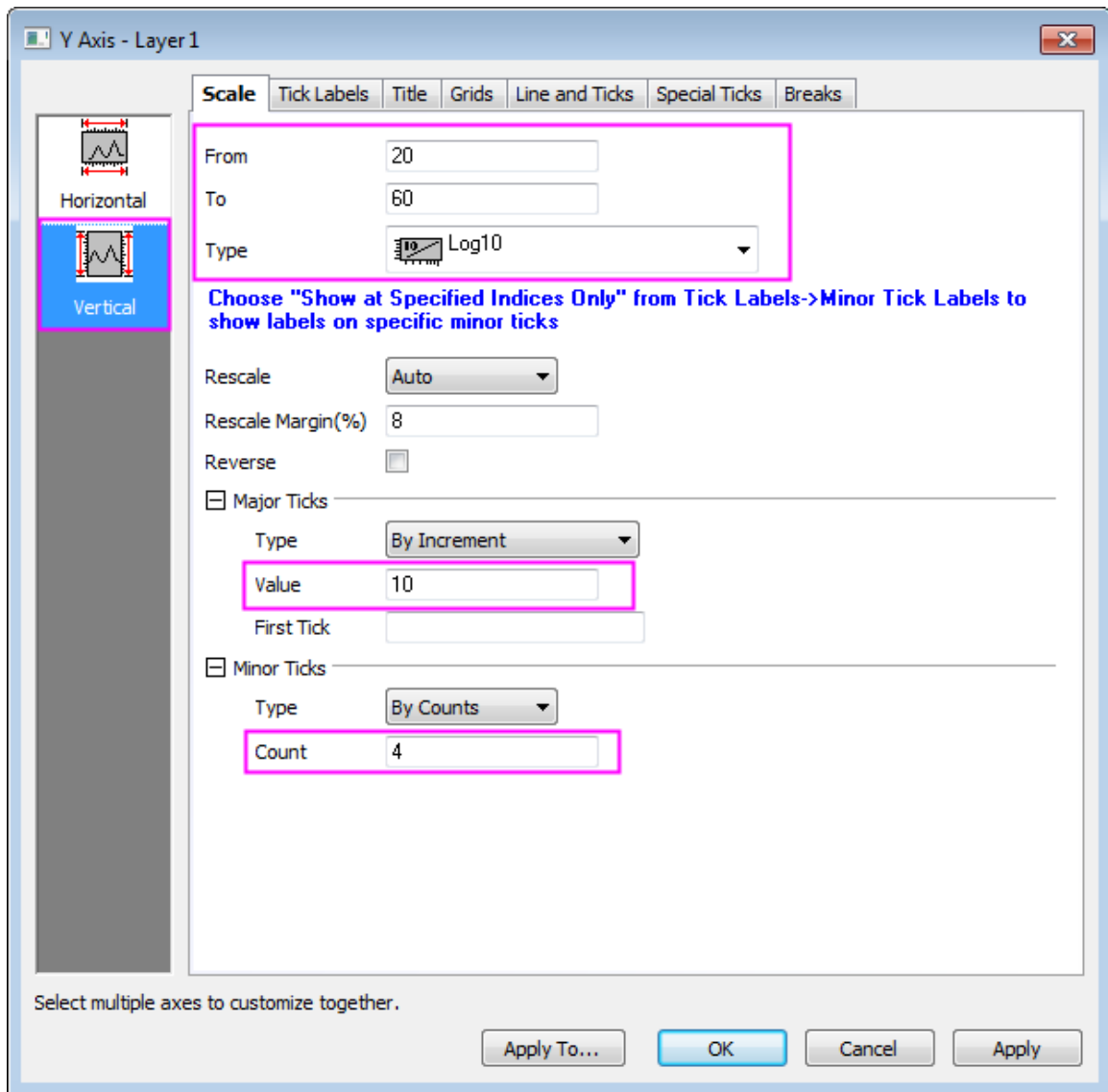

8. Go to **Tick Labels** tab and enter a **Suffix** of % to apply this character to each of the Y axis labels.

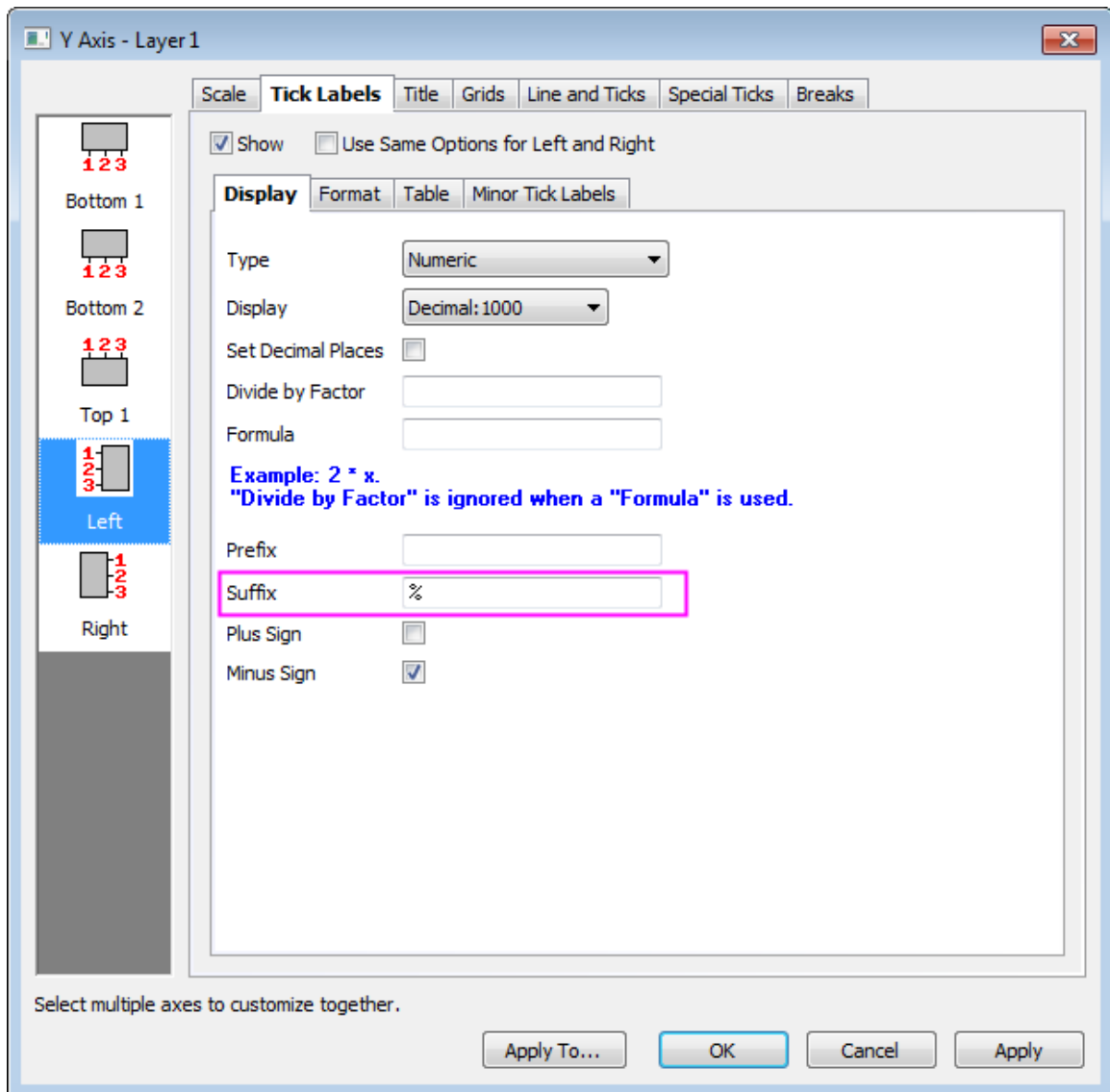

9. Click **OK** to apply the above changes.

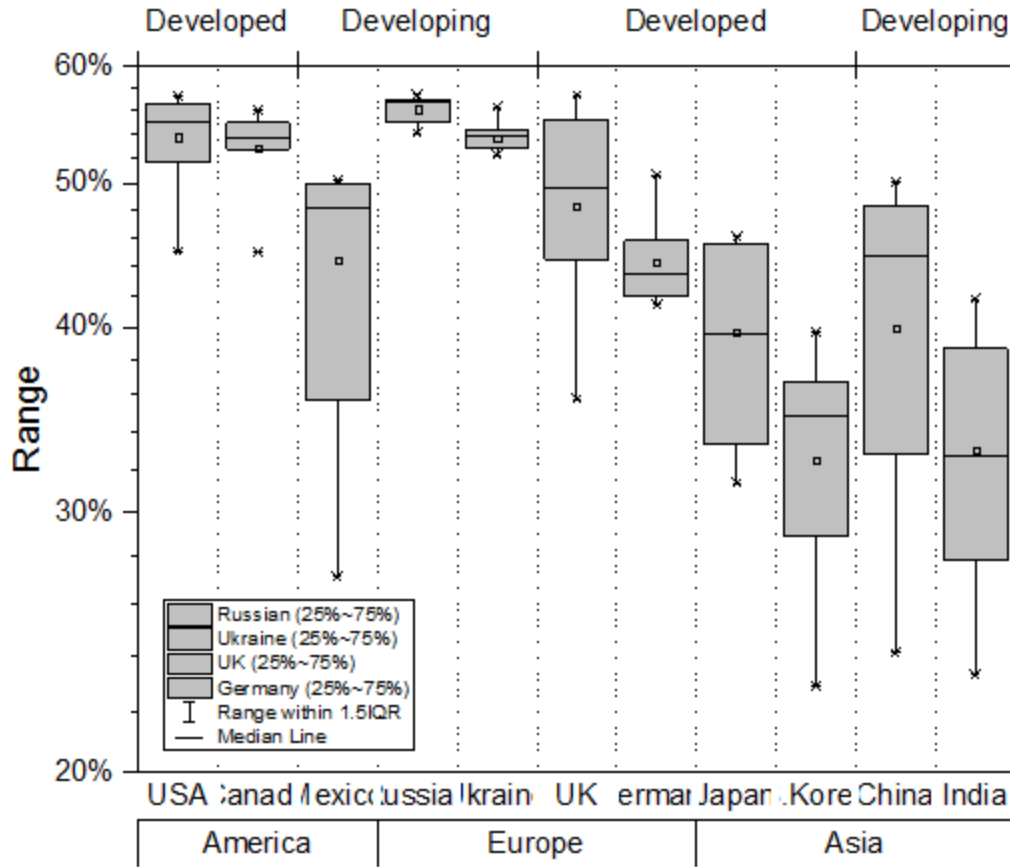

10. Click **Format: Page** and set **Width = 14.0** (you can leave the **Height** setting, as it is).
11. Double-click on the **Country** labels in the graph and set font **Size = 14**.
12. To add a graph title, click the **Text** tool, click somewhere in the heading of the graph and enter *Female Tertiary Education (ISCED 5 and 6) Enrollment*, and change Y axis title to be *Enrollment Rate*.

### 6.11.9 Grouped Box Plot

#### 6.11.9.1 Summary

In Origin, a grouped box chart can be created from either indexed data or raw data. The indexed data is arranged as one data column and one or more group columns, while the raw data is arranged as multiple data columns grouped according to the column label row(s).

Once a grouped box plot has been created there are many options to customize the box plots and the axes. The customization options are the same for grouped box plots created from raw data as well as those created using indexed data.



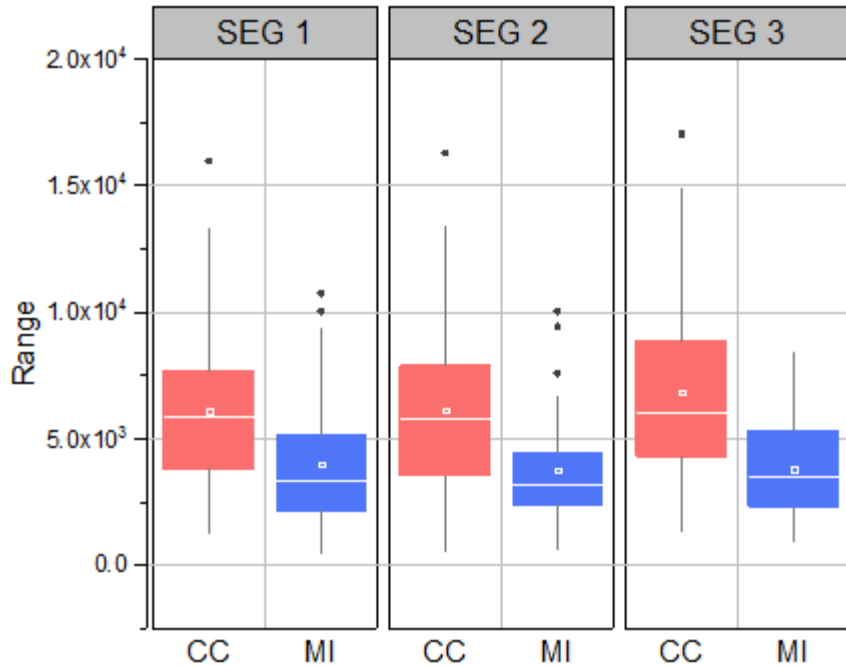

Minimum Origin Version Required: 2015 SR0

#### 6.11.9.2 What You Will Learn

This tutorial will show you how to:

- Create a grouped box plot from indexed data
- Create a grouped box plot from raw data
- Customize the box plot using the **Plot Details** dialog
- Customize the table-style axis tick labels

#### 6.11.9.3 Steps

This tutorial with the *Grouped Box Plot and Axis Tick Table* folder in the project <Origin EXE Folder>\Samples\Tutorial Data.opj.

Note: You can also access this sample graph by double-clicking on its thumbnail under the **Box Plots - Grouped** graph sample in the **Learning Center** dialog(select **Help: Learning Center** menu or press **F11**) .

##### 6.11.9.3.1 **Create Grouped Box Plot from Indexed Data**

1. Open the **Tutorial Data** project, browse to the folder *Grouped Box Plot and Axis Tick Table* and activate the workbook **Book4G-CC.MI-Index**.
2. The data in the **CC.MI-Index** worksheet is indexed data. Column E is the data column and columns C and D can be used as grouping columns.
3. Highlight column E and select **Plot > Categorical : Grouped Box Charts - Indexed Data** to open the **plot\_gboxindexed** dialog.

4. Beside **Group Column(s)**, click the triangle button at the top right corner and click the context menu item **Select Columns**. This opens the **Column Browser** for selecting grouping ranges.
5. In the column browser, highlight columns C and D simultaneously by holding down the **Ctrl** key while selecting them. Click the **Add** button to add them to the bottom panel. Click **OK** to apply the selection and close the column browser.
6. Make sure the dialog settings the same as the image below:

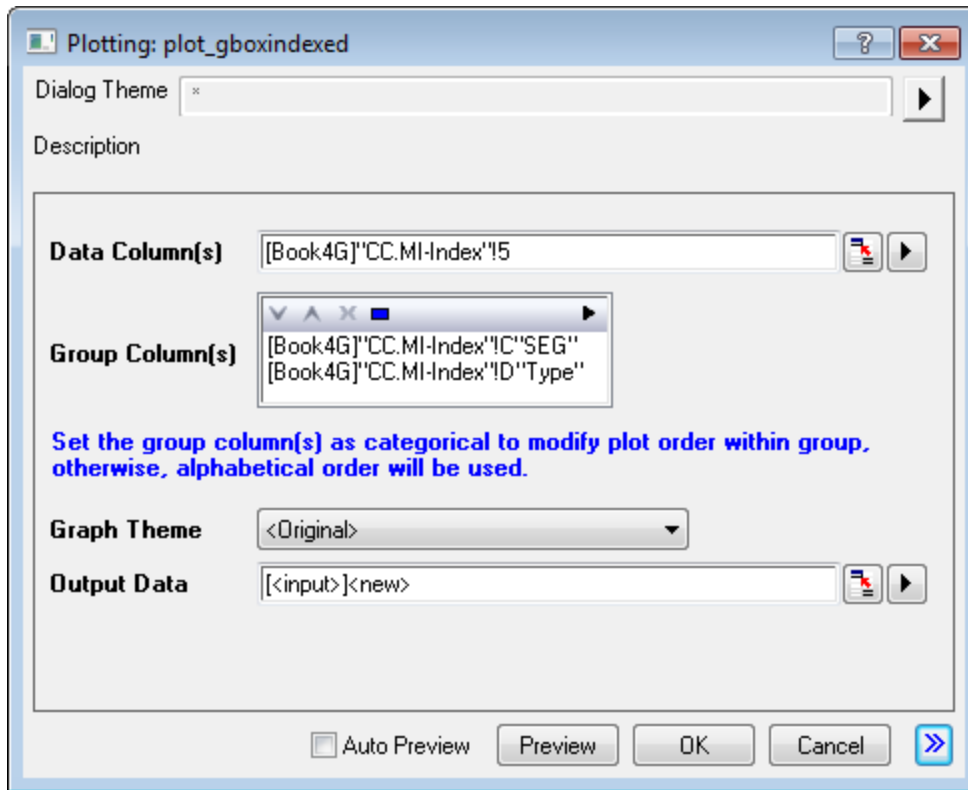

7. Click **OK** to create a grouped box plot, the plot will resemble the image below:

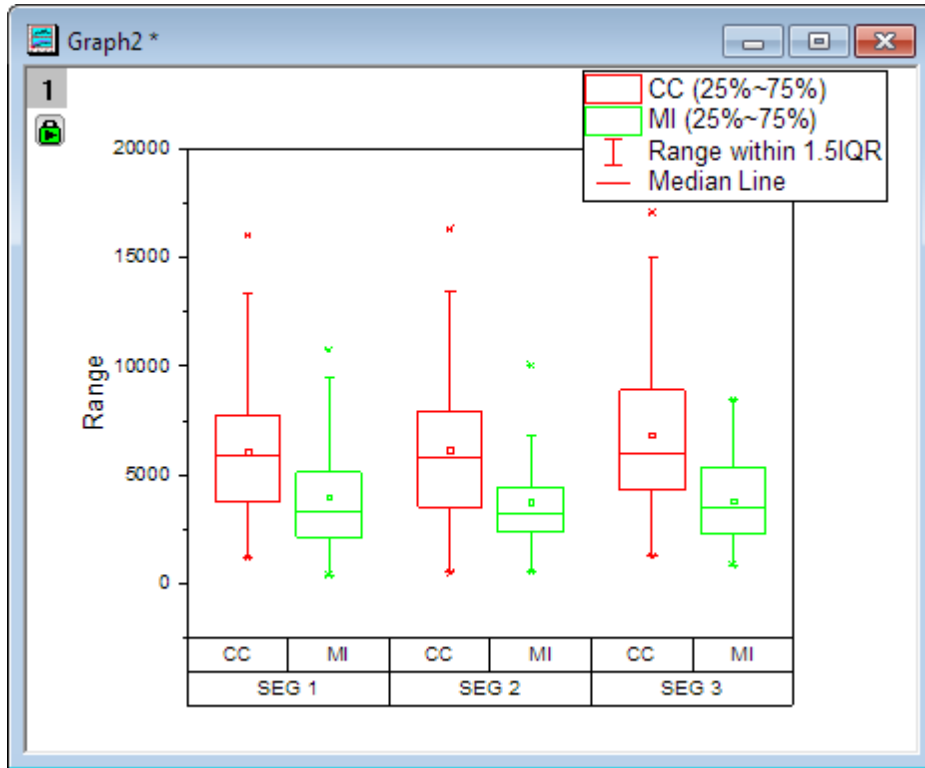

For another short tutorial on creating grouped box plots from indexed data, see [Example 2](#).

### 6.11.9.3.2 Create Grouped Box Plot from Raw Data

In the previous section, when the grouped box plot was created, an **Output Data** worksheet was generated as well. The data in this worksheet is arranged as raw data. A box plot graph will be created from the raw data as well.

1. Highlight all the columns in the worksheet **Output Data**. Select **Plot > Categorical : Grouped Box Charts - Raw Data** from the main menu to open the **plotgboxraw** dialog.
2. We will use the labels in the SEG and Type label rows to group our data into 2 subgroups: Set **Group Number** to **2**, **1st Group Row** to **SEG** and **2nd Row Group** to **Type**.
3. Enable, **Sort by Group Labels** and accept the default Graph Theme.

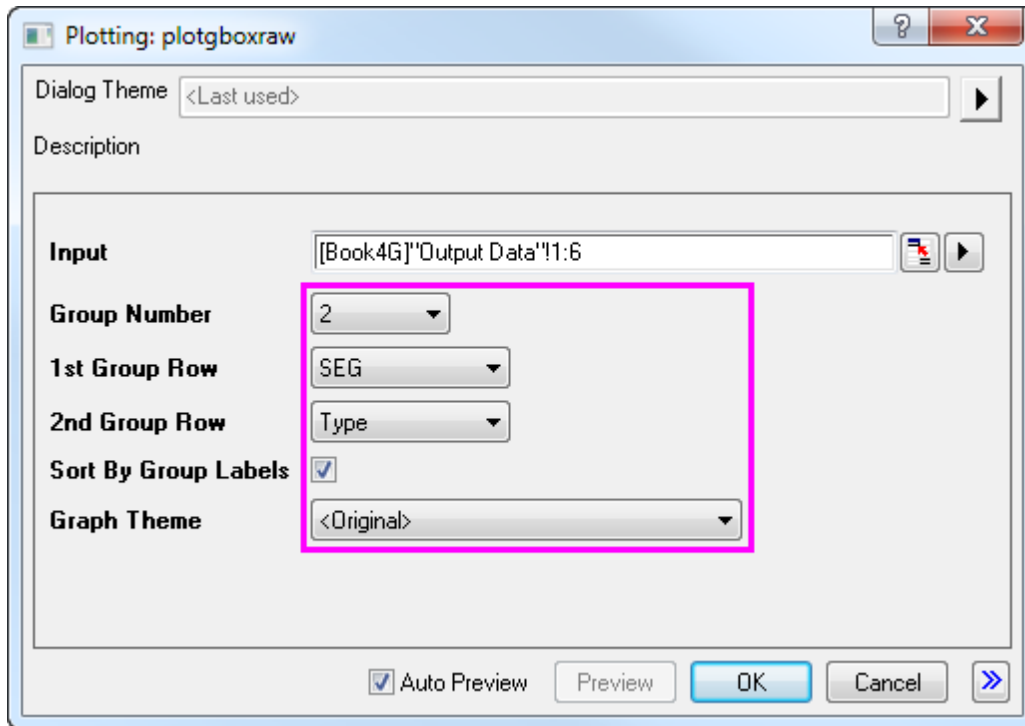

- Click **OK** to create another grouped box plot, the plot should resemble the image below:

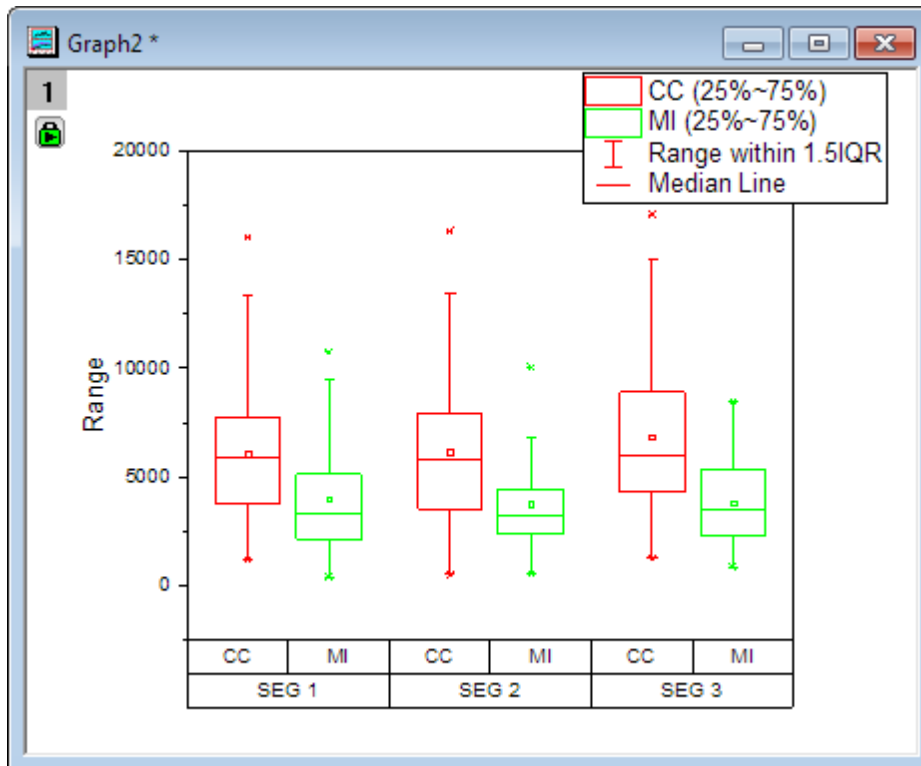

### 6.11.9.3.3 Customization by Plot Details Dialog

Both the graphs created in the previous two sections can be customized in the same manner. In the following sections, the graph created from the indexed data will be used as an example for customization.

1. Activate the graph window created from the indexed data. Select and delete the legend object.
2. Select **Format:Plot** to open the **Plot Details** dialog.
3. On the **Box** tab, check the **Outliers** box. Note that **Outliers in Line** will also be checked automatically. Outlier points will be shown in the graph. Click **Apply** to apply settings first and the **Symbol** tab will appear.
4. To customize Symbol style select the **Symbol** tab and set the following:

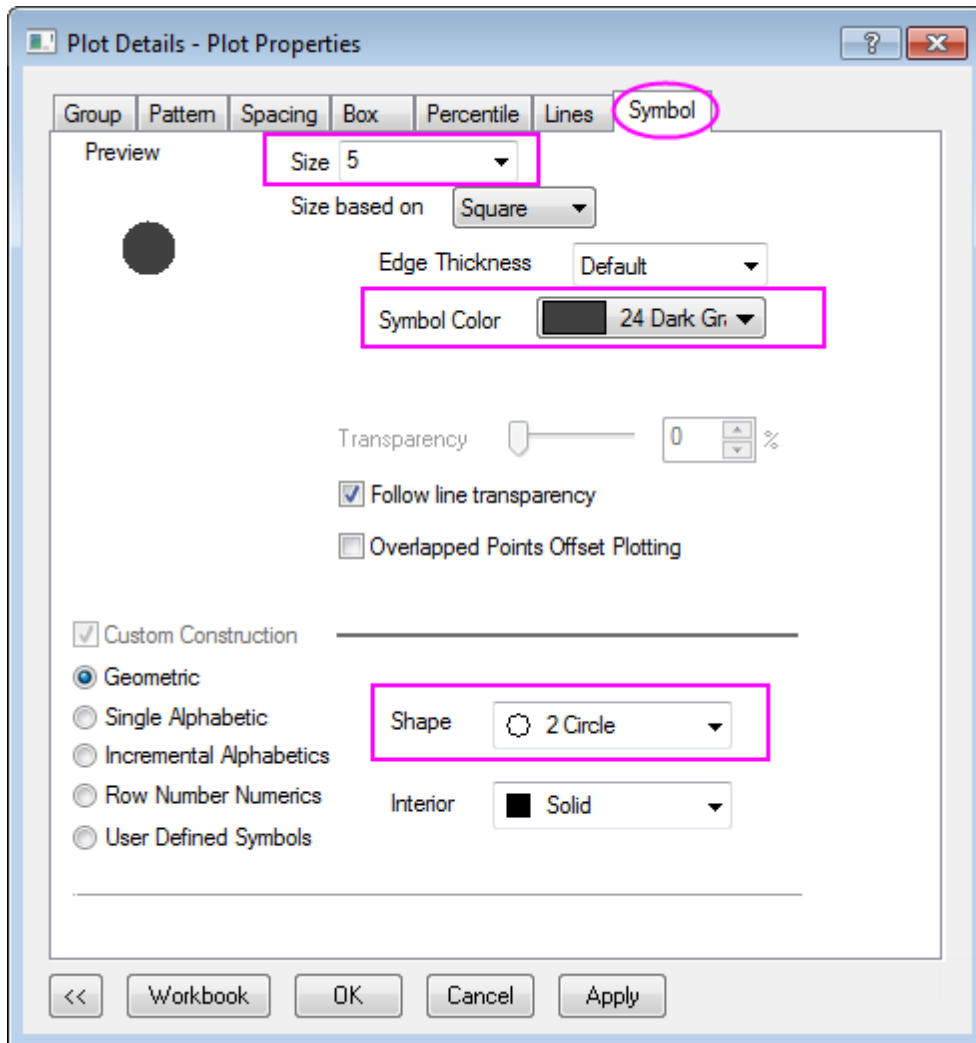

5. On the **Spacing** tab change **Gap Between Subgroups (in %)** to **5**.
6. On the **Lines** tab change the line colors as shown below:

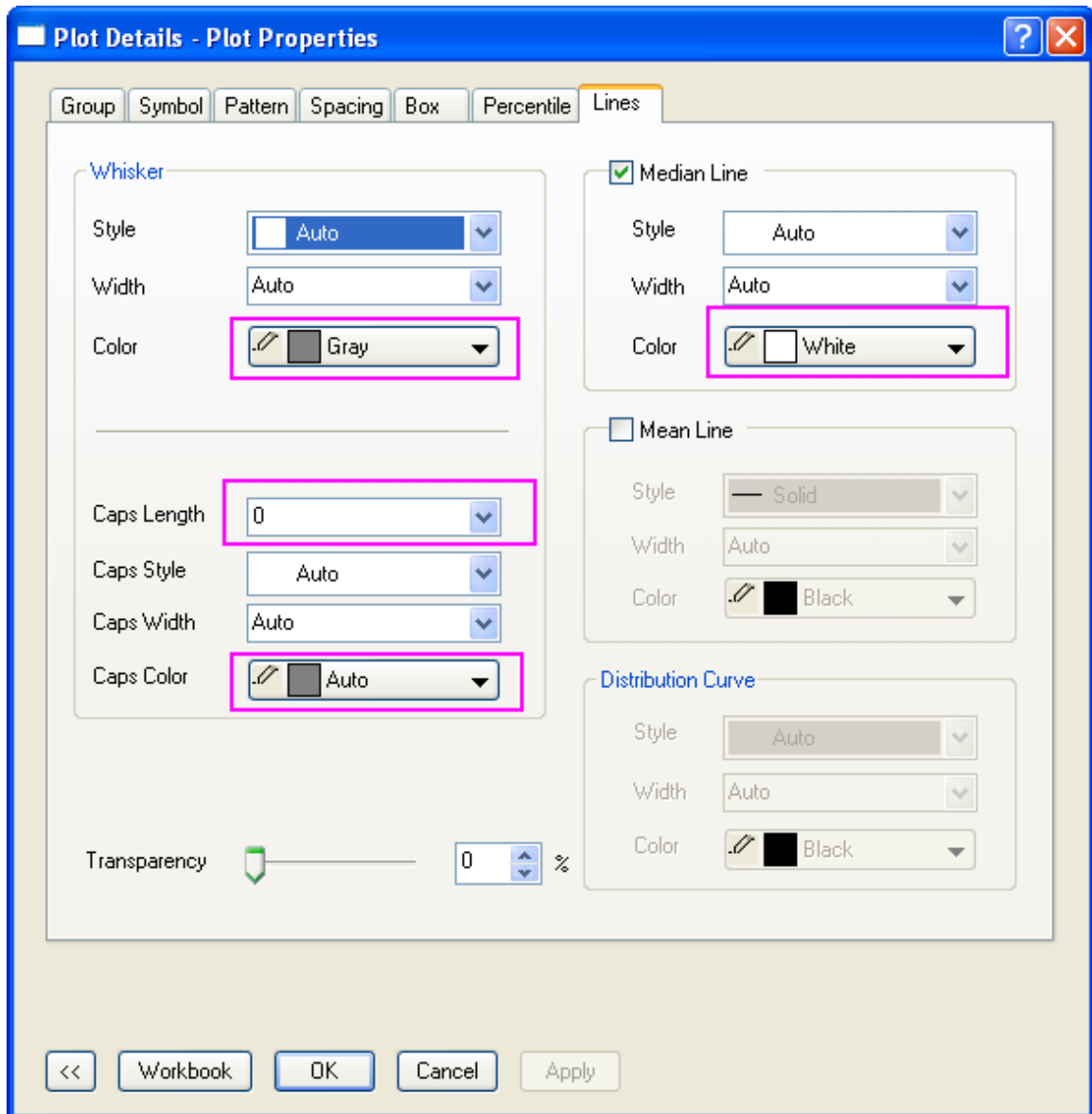

7. On the **Percentile** tab in order to set the **Max/99%/1%/Min** to none, select the last option in the symbol map. Set the rest of the options as shown below:

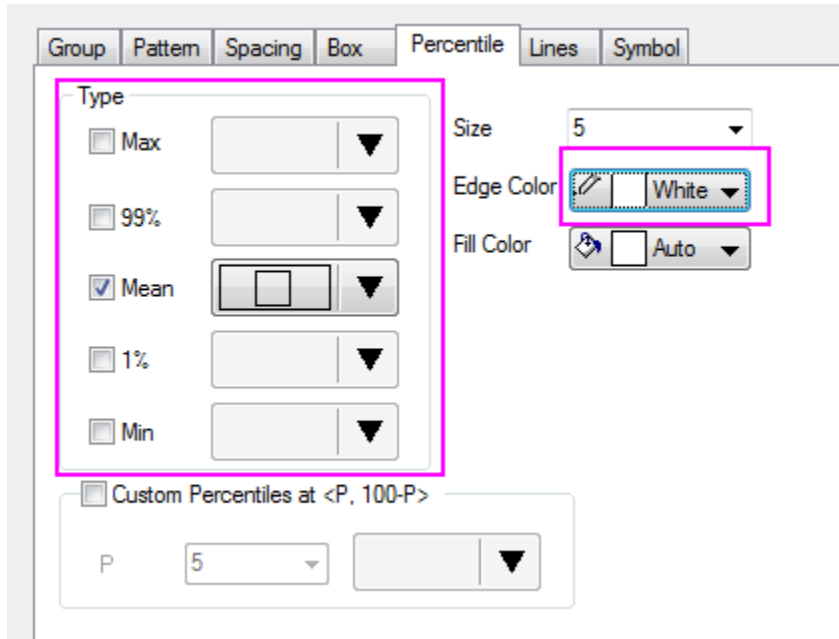

8. On the **Group** tab, for the **Border Color** row, set the **Increment** as **By One** and **Subgroup** as **Within Subgroup** .
9. Next, click the ... button on the right end of the **Details** column to open the **Increment Editor**. Click the first color to expand the color chooser, then click the last vacant color under **Custom** control to open the **Colors** dialog. In the dialog that opens, you can [define a custom color](#) by entering the HSL values (Hue=0, Sat=240, Lum=180). **OK** to close the dialog. Follow the same procedure for the second color in the **Increment Editor** dialog with the settings Hue=160, Sat=240, Lum=164. **OK** out of the **Increment Editor**:

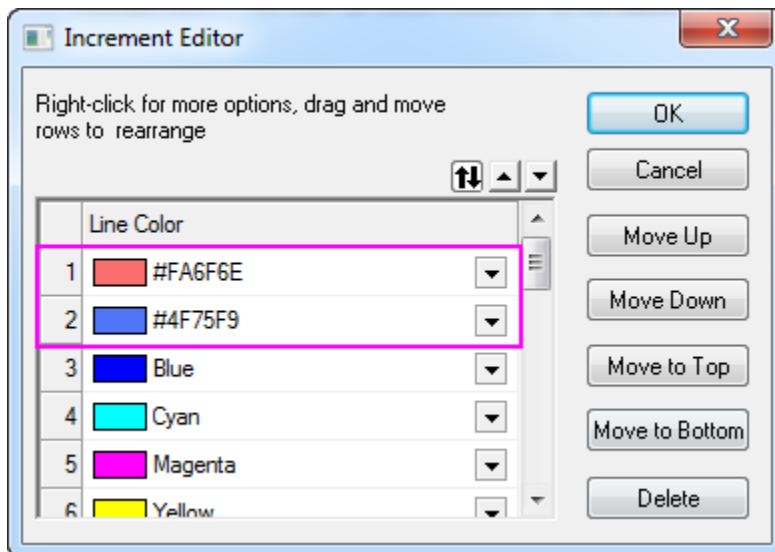

10. In regard to the **Box Color**, select the first color list we just defined under the Details drop-down list, and then select **By One** for **Increment** cell and **Within Subgroup** for **Subgroup** cell:

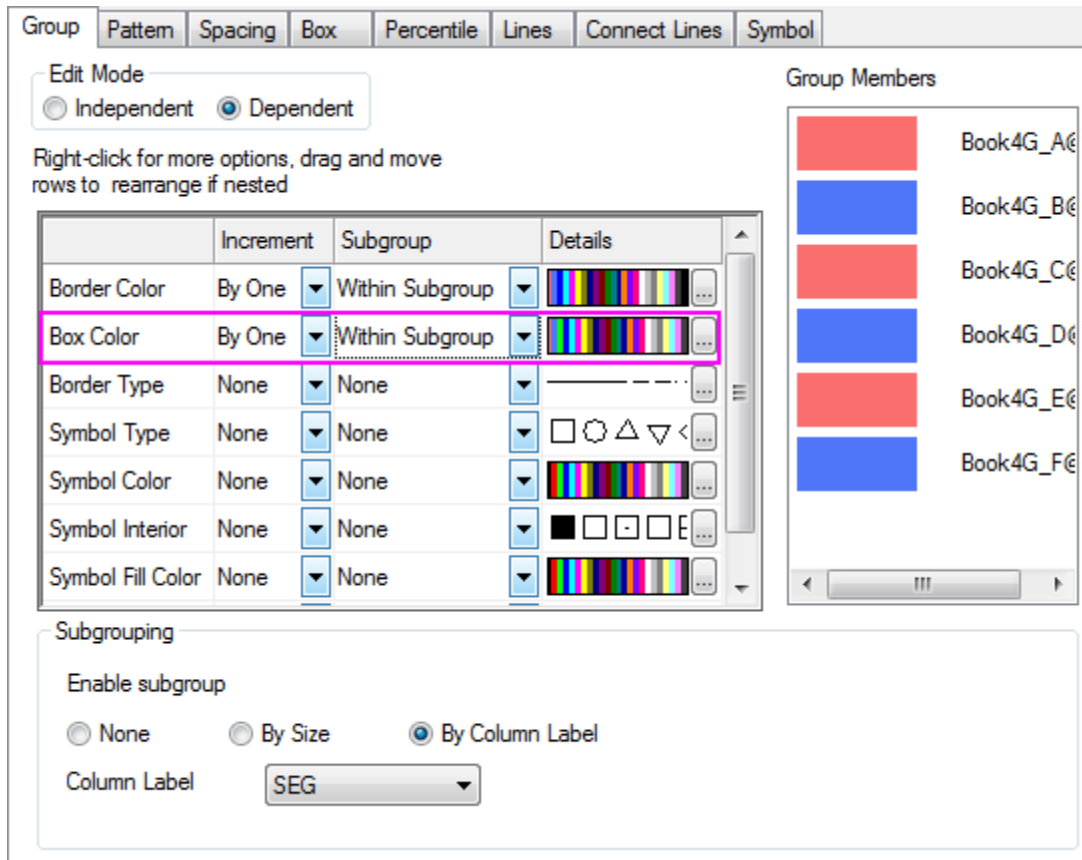

- Click **OK** to apply all the previous settings and close the **Plot Details** dialog. The graph should resemble the image below:



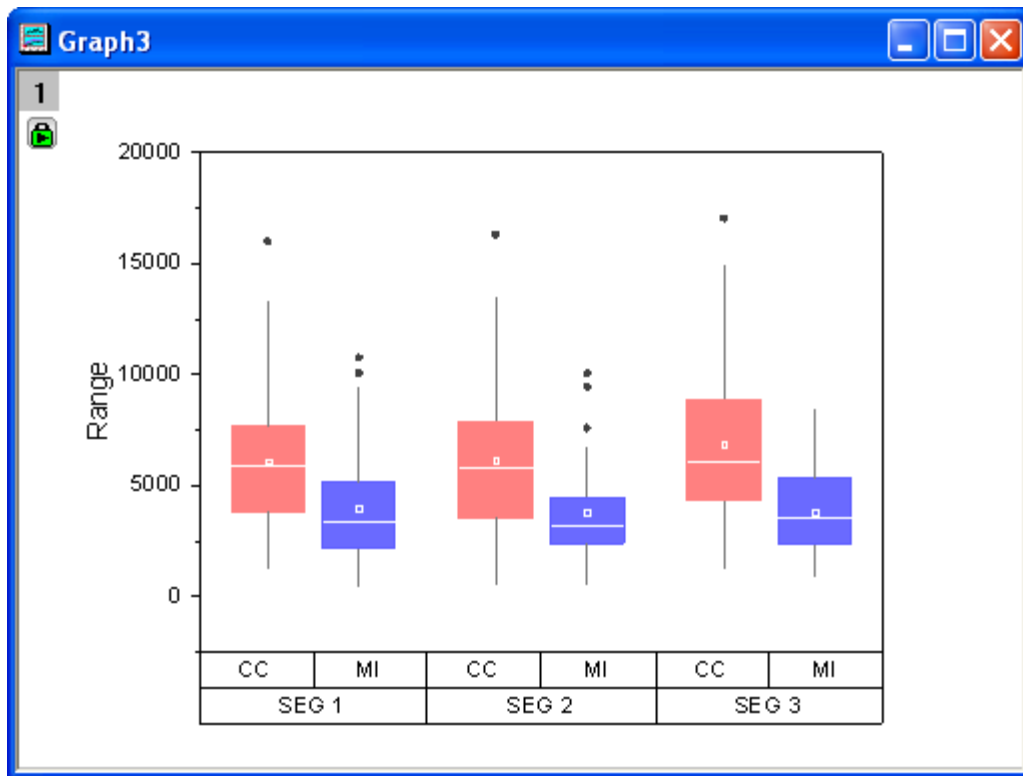

#### 6.11.9.3.4 Customization by Axis Dialog

1. Continue with the graph from the previous section. Select **Format:Axes:X Axis** to open the **Axis** dialog.
2. Go to the **Tick Labels** tab, right click on the **Bottom 1** icon and select **Move to Opposite** to move it to the top axis.

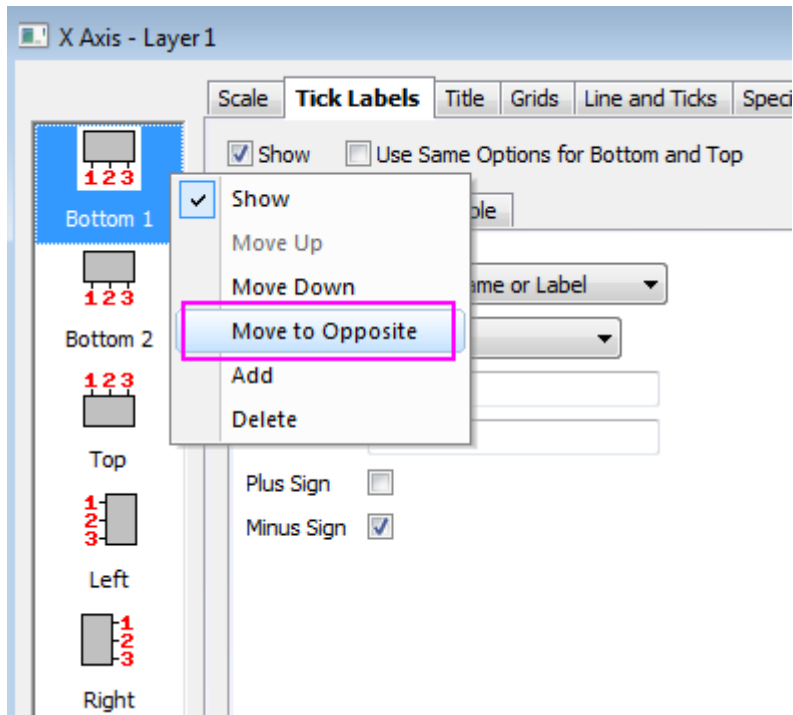

3. Now the previous **Bottom 1** becomes **Top 1**, and **Bottom 2** becomes **Bottom 1**.

4. Click the new **Bottom 1** icon and set the tick label format and table layout as shown below:

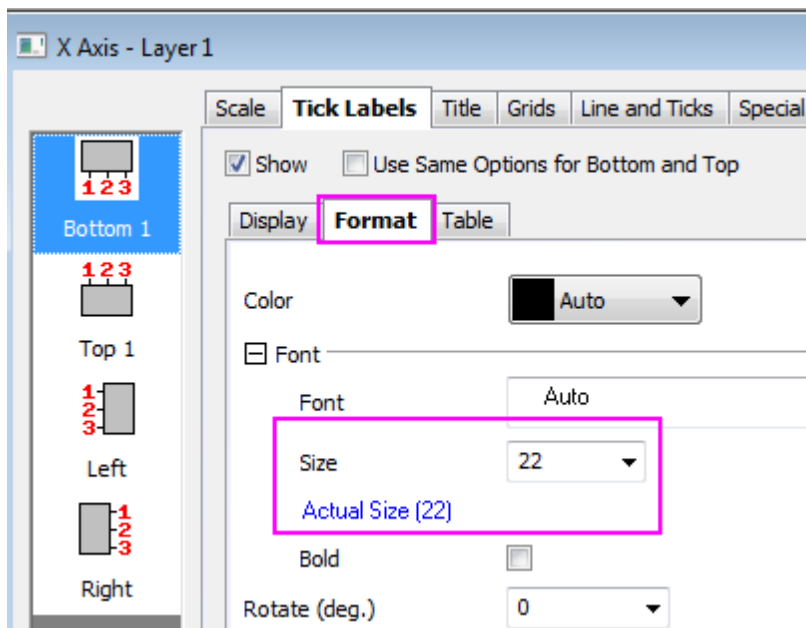

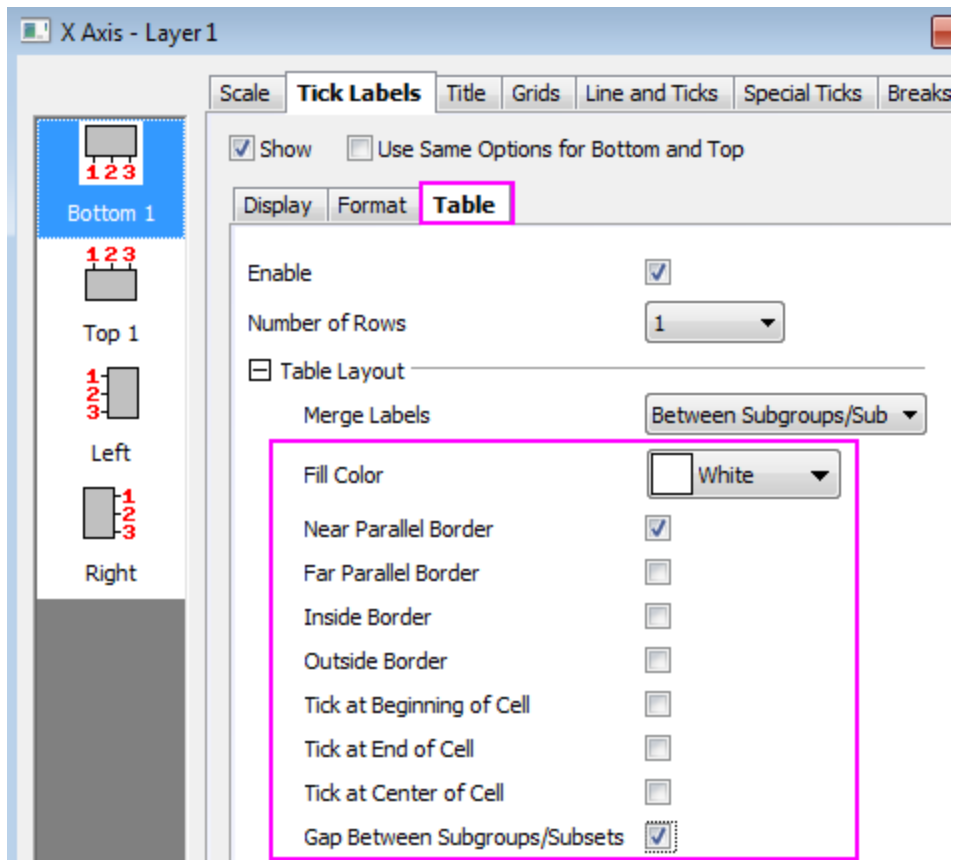

5. Click the **Top 1** icon and set the following:

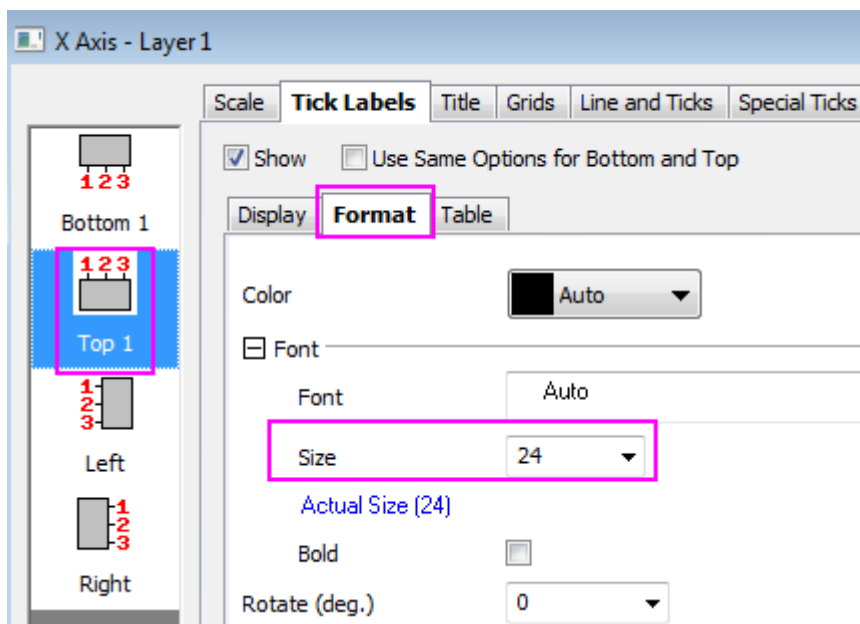

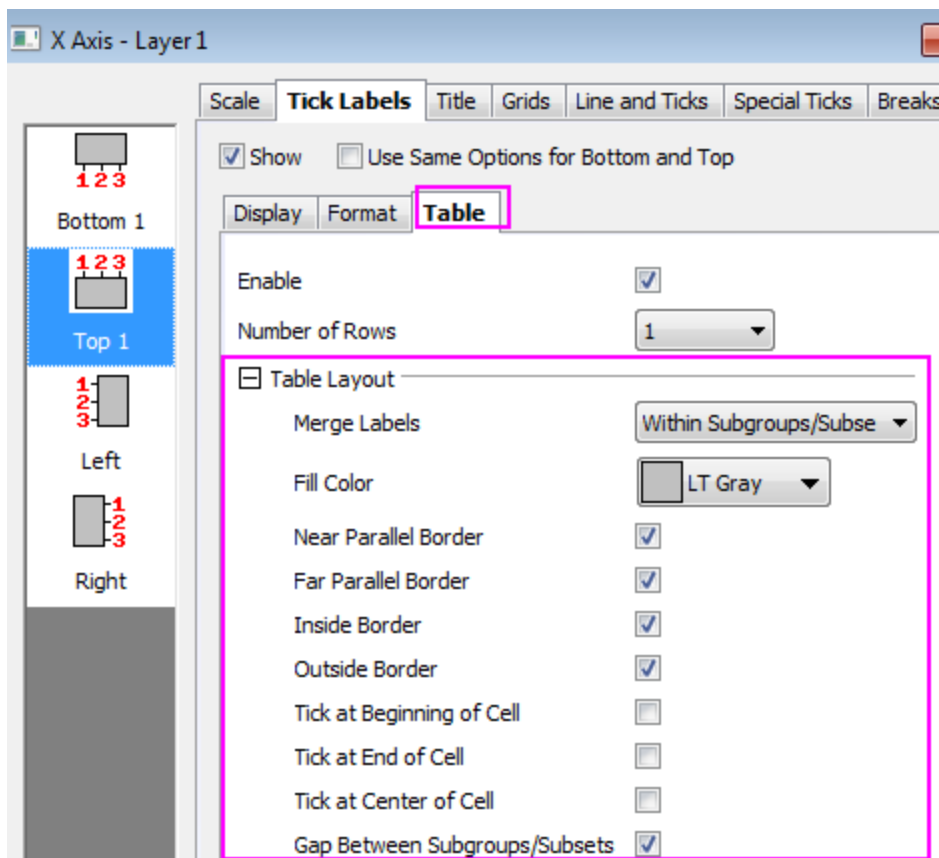

6. Click the **Left** icon (for Y axis) and change the display format for the Y tick labels:

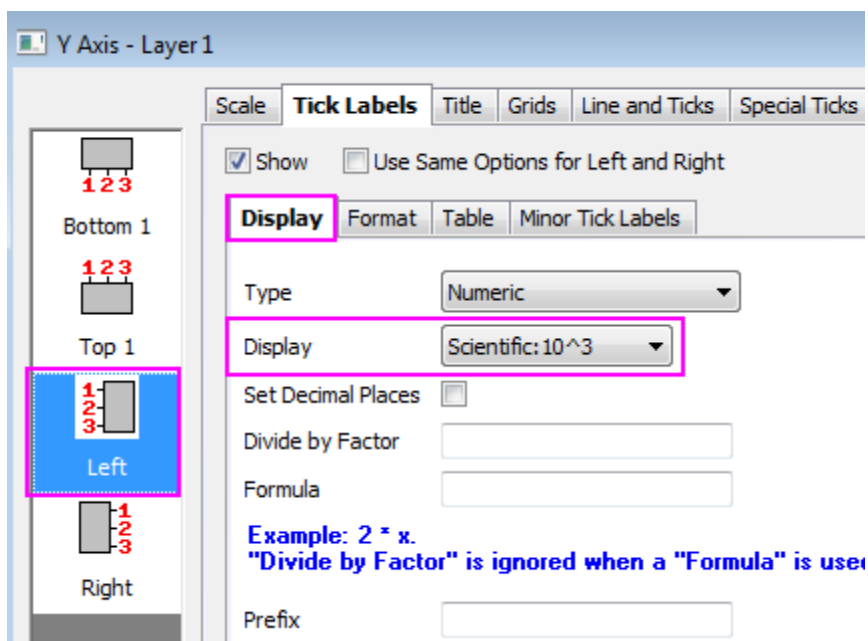

7. To turn on major and minor grid lines, go to the **Grids** tab and set as following for X(**Vertical**) and Y(**Horizontal**) grids respectively:

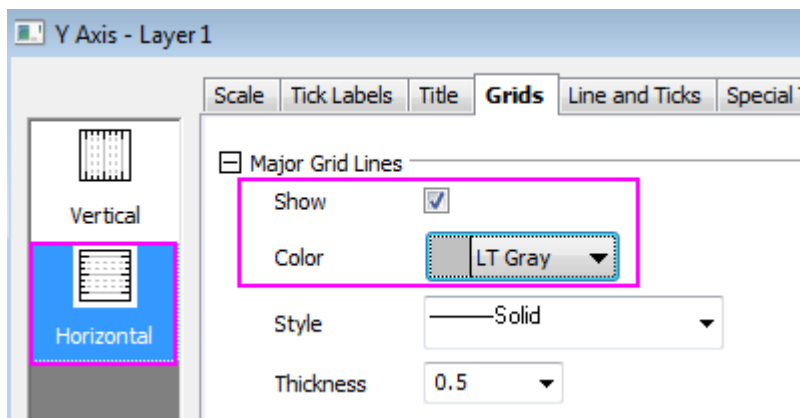
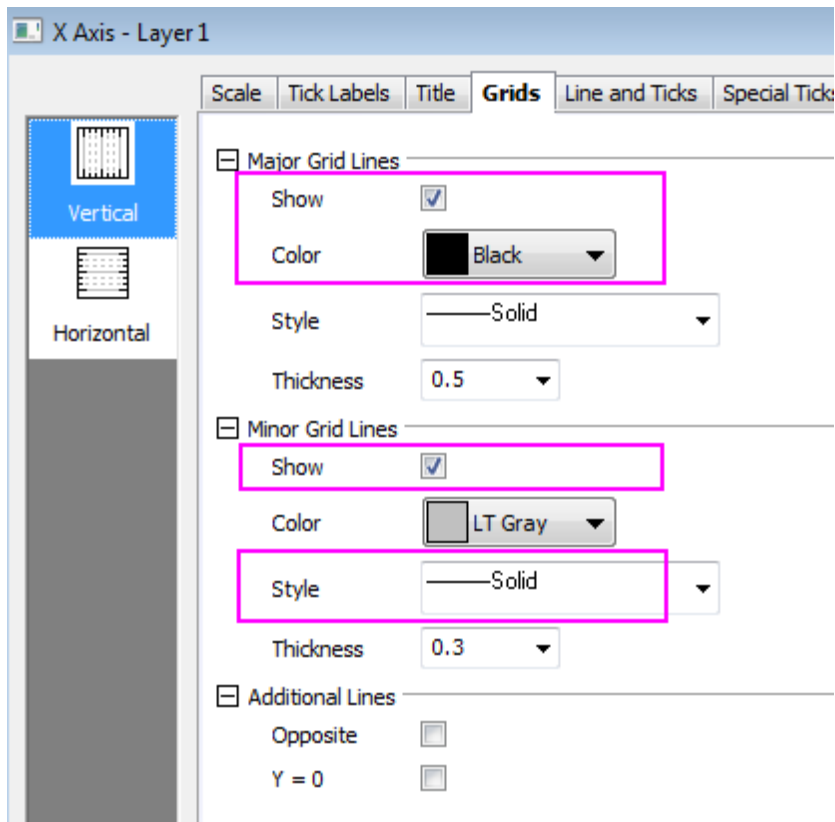

8. Click **OK** to apply the settings and close the **Axis** dialog. The final graph should appear as shown below:

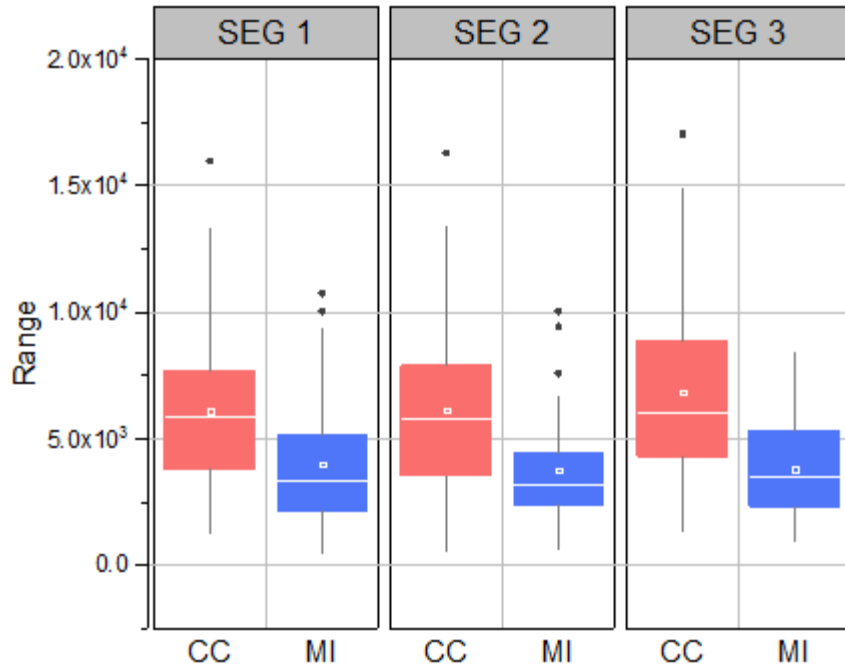

You can click to select table labels and nudge them using the arrow keys on your keyboard.

### 6.11.10 Notched Boxes with Variable Width Control

#### 6.11.10.1 Summary

Origin's box plot is highly customizable. This tutorial shows how to create a notched box plot and control the box width by another dataset.

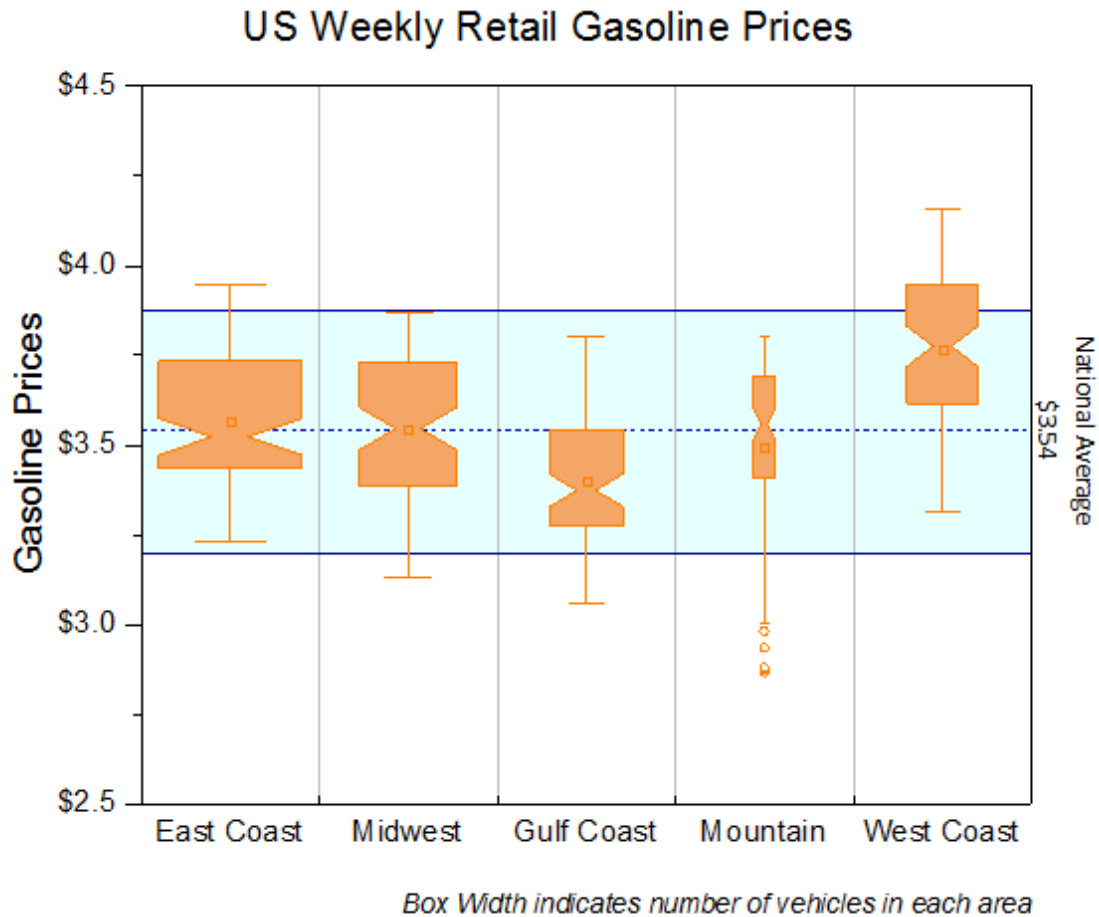

Minimum Origin Version Required: 2015 SR0

#### 6.11.10.2 What you will learn

- Customize box plot settings
- Use a dataset to control the box width
- Customize the axis dialog for box plots
- Add a fill area plot to a box plot as background

#### 6.11.10.3 Steps to Control Box Width by Variable

This tutorial is associated with <Origin EXE Folder>\Samples\Tutorial Data.opj.

Also, you can refer to this graph in **Origin Central**. (Select **Help: Origin Central** menu or press **F11** key , and then select **Graph Sample** tab, select **Box Charts** under the drop-down list)

1. Open the **Tutorial Data.opj** and browse to the *Box Variable Width* folder.
2. Activate workbook **Book7**, highlight columns **A~F** and then select **Plot > Statistical: Box Chart**. Next, select and delete the legend object from the graph.

- Double-click on one of the boxes to open the **Plot Details** dialog and go to the **Box** tab. Set **Style** to **Notched Box**. Select the **Box Width by Parameter** box and then set **Box Width (%)** to **Number of Vehicles (in million)** and enter **1.2** for **Scaling Factor**. Select the **Outliers** box. **Outliers in Line** is automatically checked.

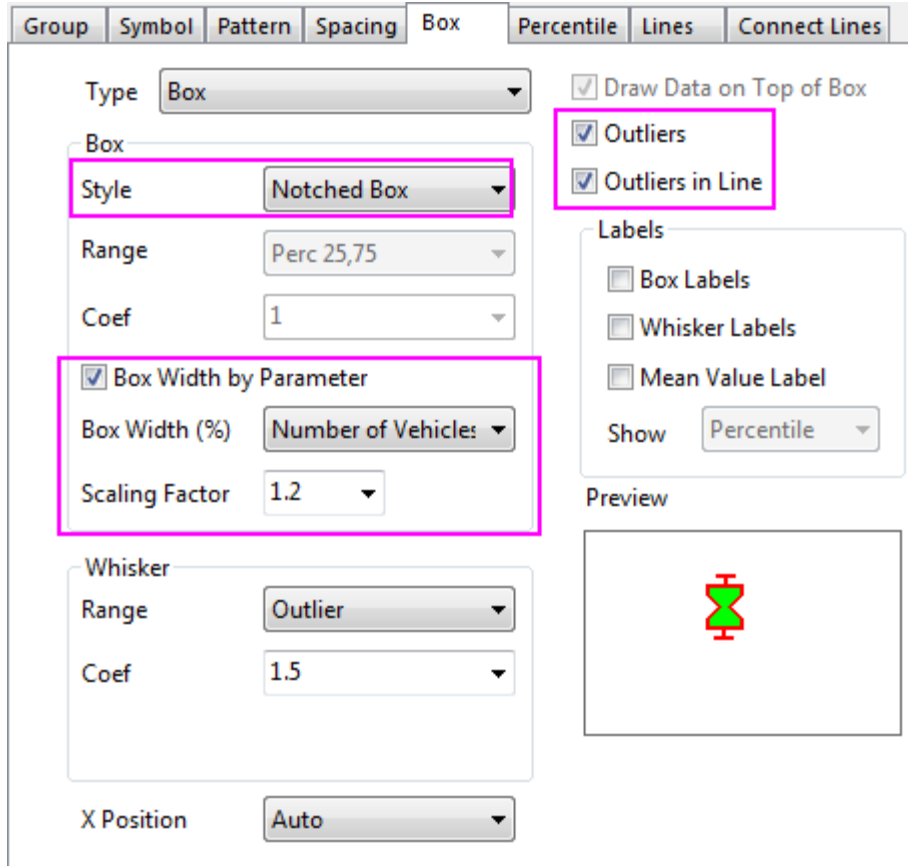

- Click OK to close the dialog. Go to the **Object Manager**, which is docked to the right edge of Origin workspace, uncheck the last plot. And the click on the **Rescale** button  to rescale the graph.

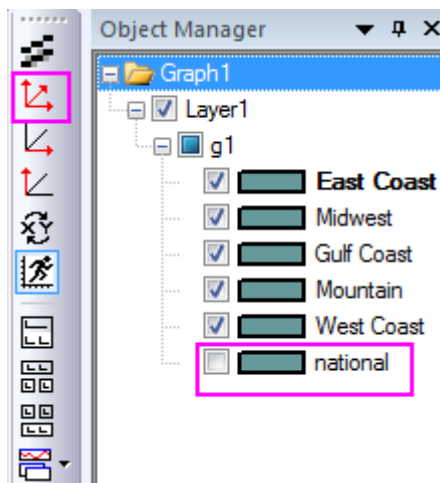



The graph will look as below.

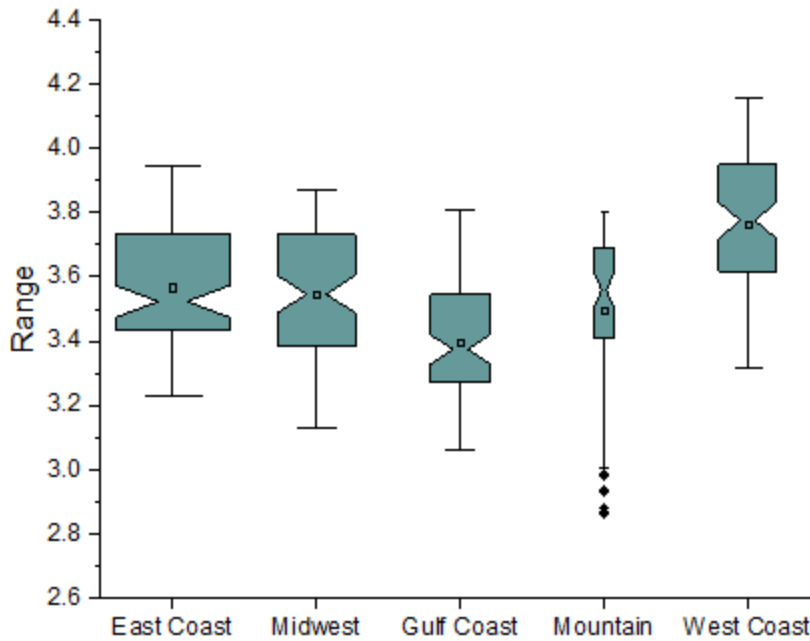

#### 6.11.10.4 More Box Style Customization Steps

The following steps can further customize the box plot.

1. To use the same color for each box, double-click on any box to open the **Plot Details** dialog box. Go to the **Pattern** tab. Set **Border Color** as **Orange**. Set **Width** as **1.5**.
2. To fill the boxes with color, expand **Fill Color** drop down list, and in the Single tab choose a lighter orange as below:

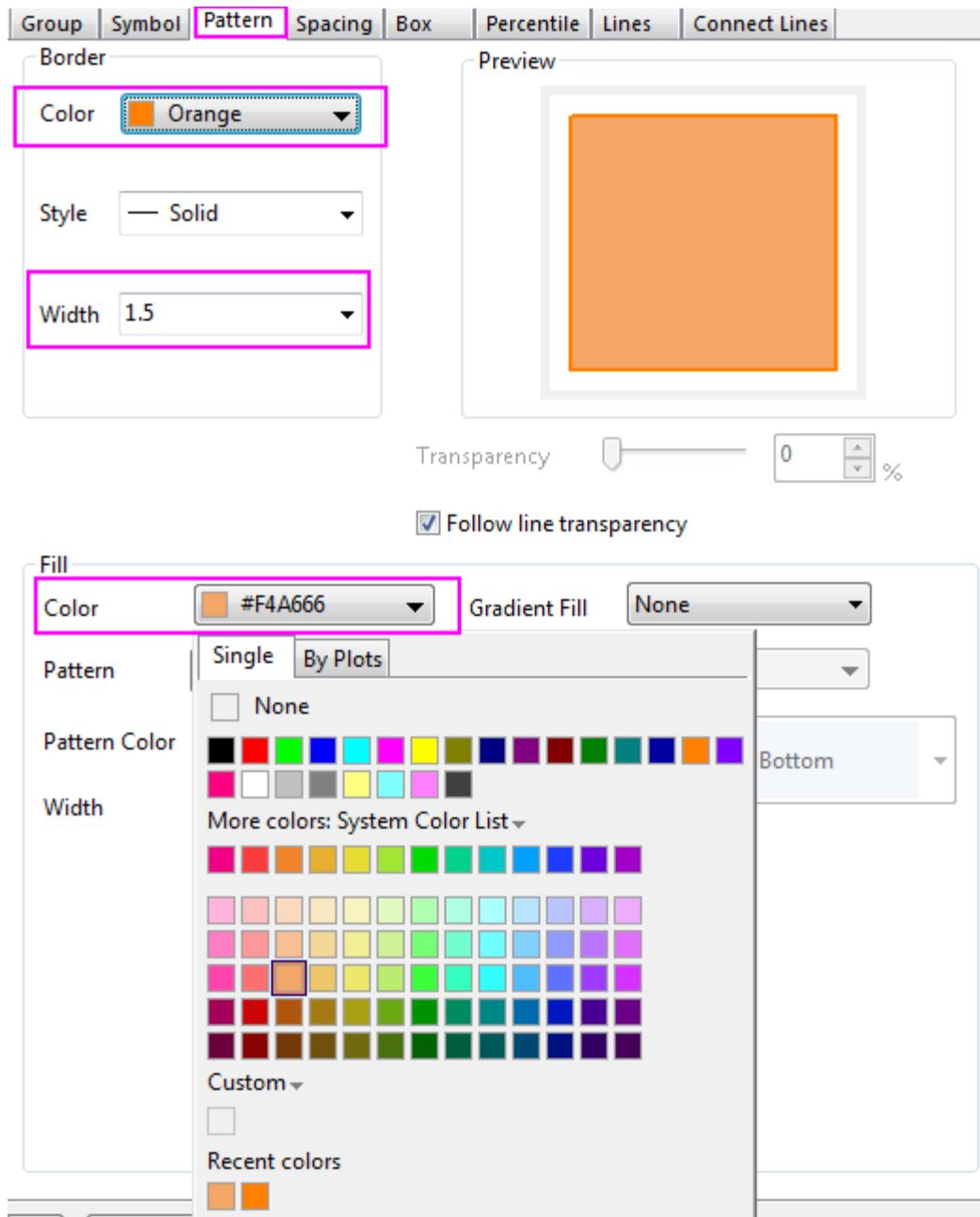

3. Note that checking **Outliers** checkbox in **Box** tab added a **Symbol** tab. Use controls on this tab to customize the outlier symbol as shown below:

Group **Symbol** Pattern Spacing Box Percentile Lines Connect Lines

Preview

Size 5

Size based on Square

Edge Thickness 20

Edge Color Auto

Fill Color Auto

Transparency 0 %

Follow line transparency

Overlapped Points Offset Plotting

---

Custom Construction

Geometric

Single Alphabetic

Incremental Alphabetic

Row Number Numerics

User Defined Symbols

Shape 2 Circle

Interior Open

4. To hide the 99% and 1% symbols, go to the **Percentile** tab and clear the symbol for both **99%** and **1%**. Select the 2nd symbol in the first row for **Mean**:

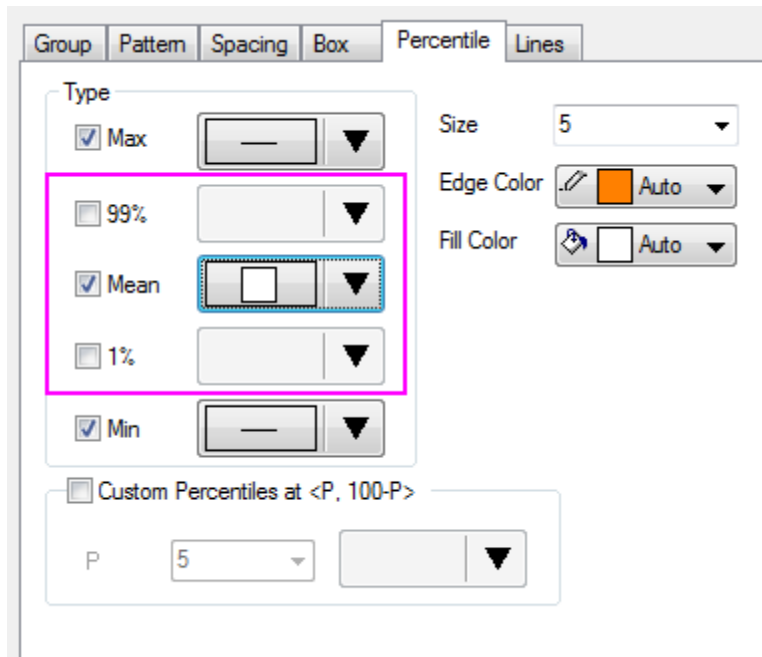

5. Click **OK** button to accept all the changes.

#### 6.11.10.5 More Axis Customization Steps

1. To show solid grid lines between each boxes, double click on the X axis to open the **Axis** dialog box. Go to the **Scale** tab with **Horizontal** icon selected and set the **Count of Minor Ticks** to **1**:

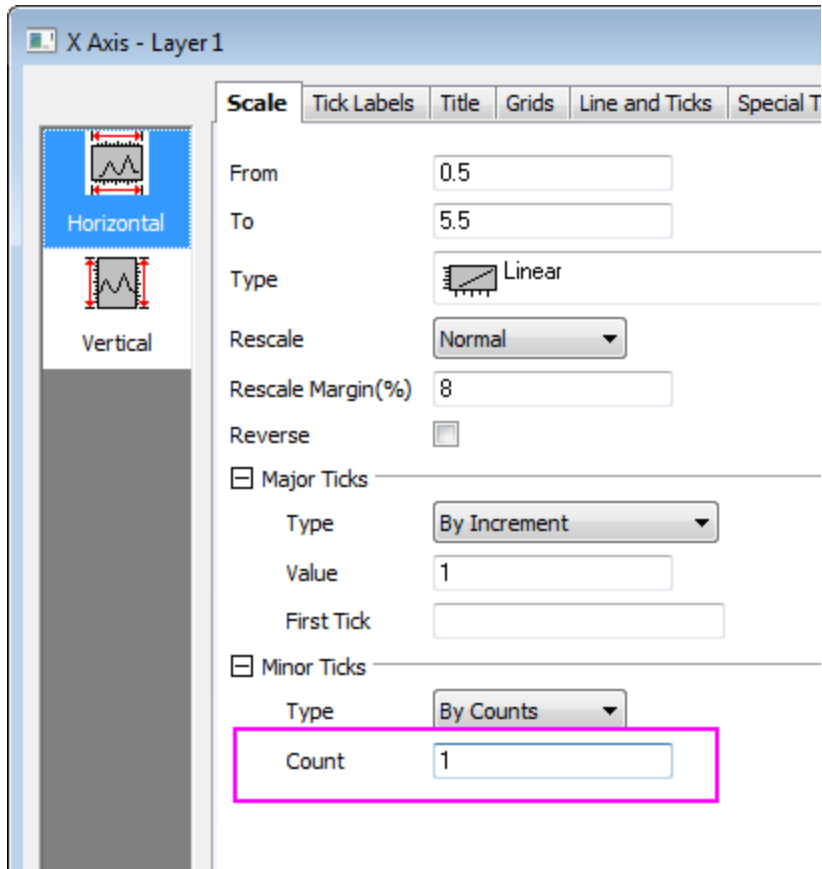

2. Select the **Grids** tab and select the **Vertical** icon. Check **Show** under **Minor Grid Lines** branch and set the **Style** as **Solid**.

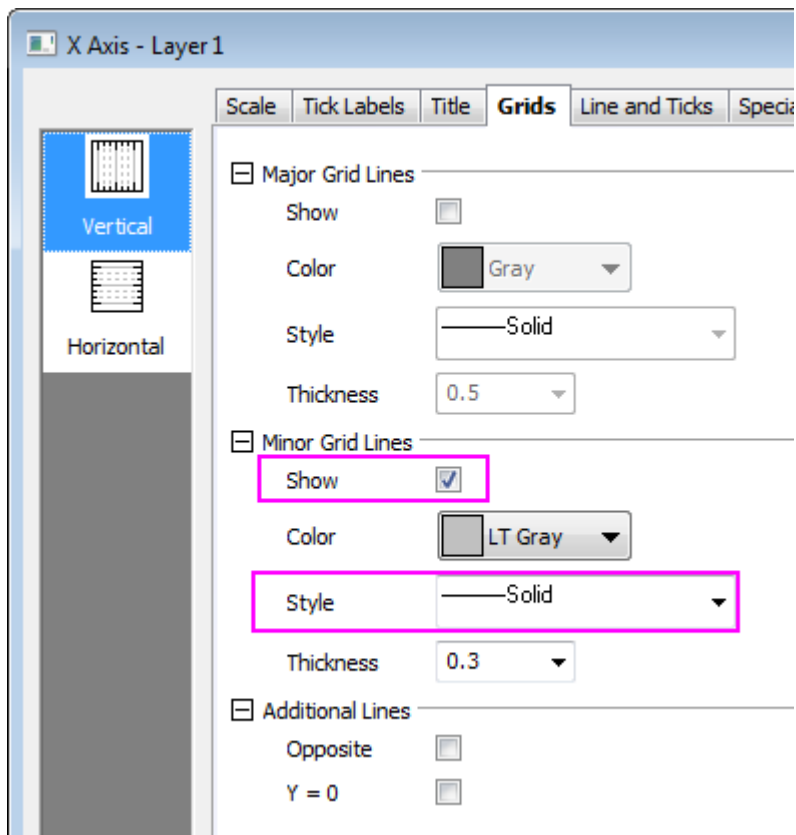

3. Go to the **Line and Ticks** tab and set the tick styles for X axis (**Bottom**):

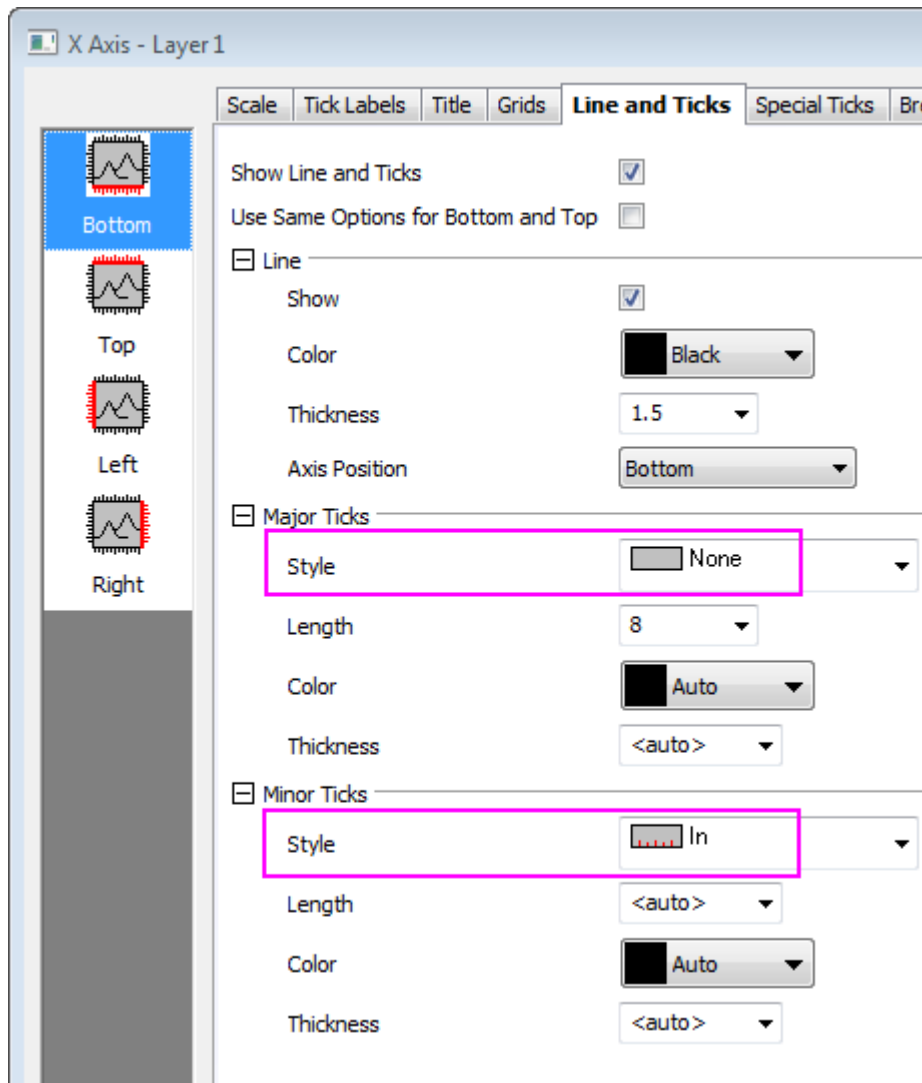

4. Hold **Ctrl** key and multiple select the **Top** and **Right** icons. Check the **Show Line and Ticks** box to also display line and ticks of top X and right Y axis, and set the tick style to **None**:

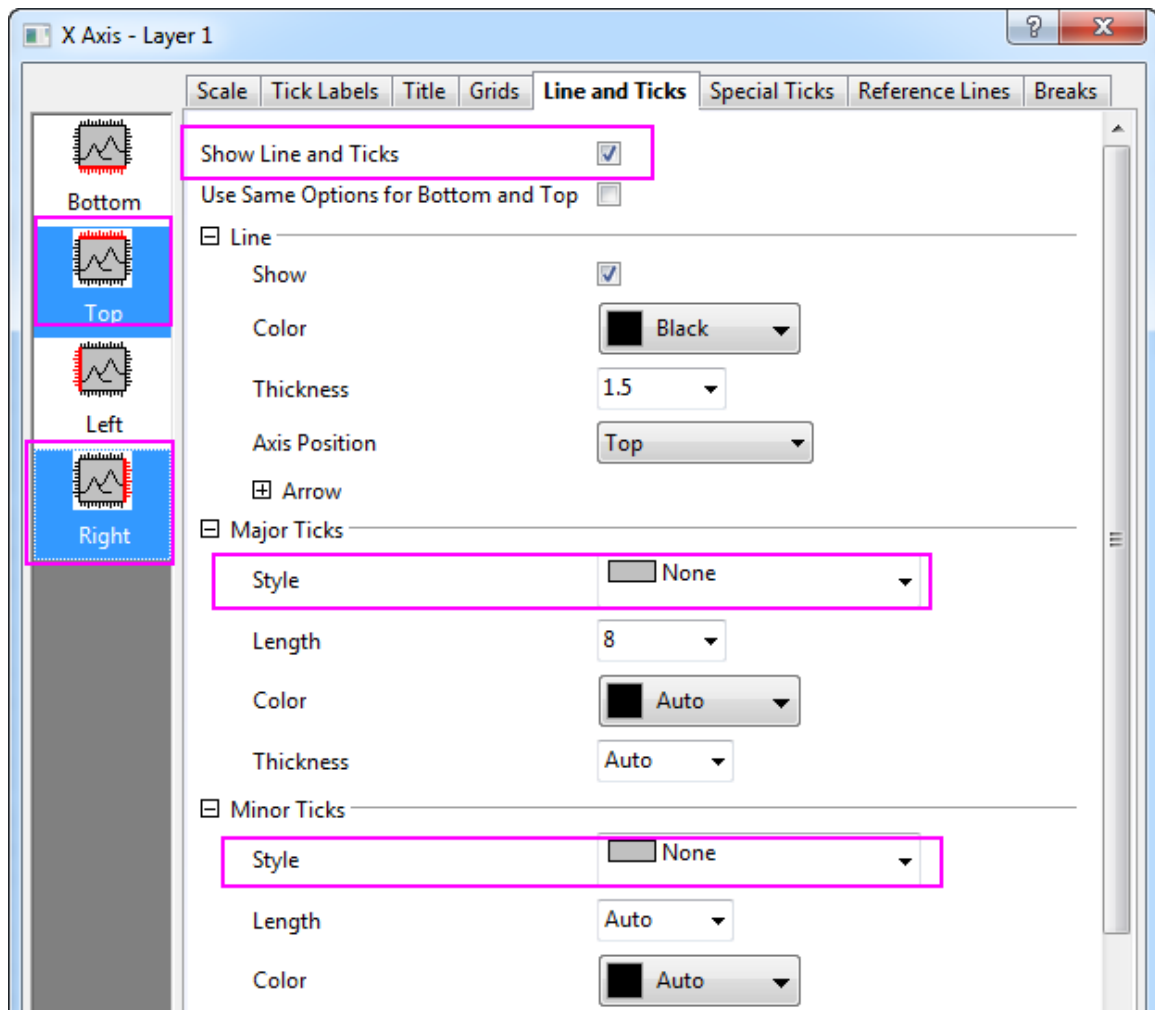

5. Go to the **Scale** tab again and select **Vertical** icon. Set the following:



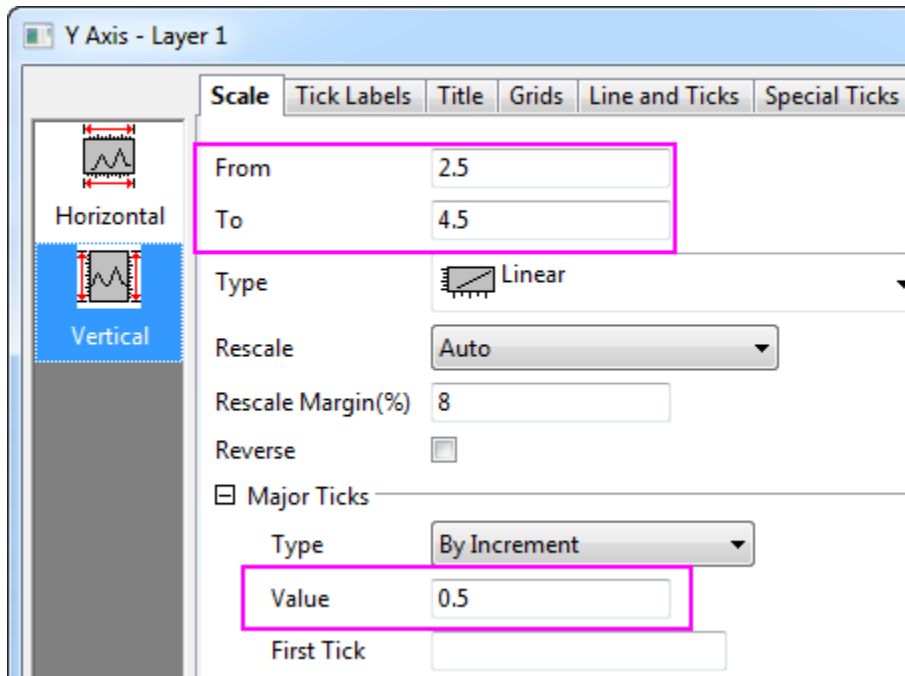

6. Go to the **Tick Labels** tab, make sure **Left** icon is selected and enter a prefix of \$.

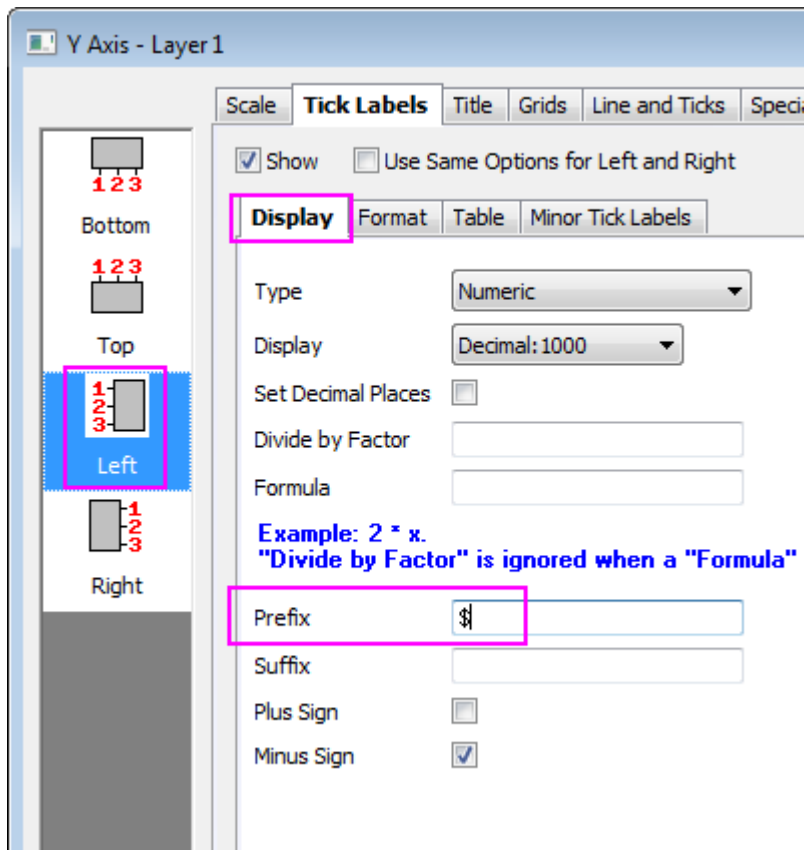

7. Go to the **Title** tab, make sure **Left** icon is selected and change the text of Y axis title to *Gasoline Prices*.

8. Click **OK** to close the **Axis** dialog.
9. To add a title and footnote in the graph, right click in white area of the graph and select **Add/Modify Layer Title** context menu. Type *US Weekly Retail Gasoline Prices*. Select the title and use the **Format** toolbar to set font size as **26**. Right click below the X axis tick labels and choose **Add Text...** context menu. In in-place edit mode, click **I** button on **Format** toolbar and then type *Box width indicates number of vehicles in each area* as a footnote. It will show in italics.

6.11.10.6 Steps to Add National Average Line and Min&Max Range

Now, we are going to add three reference lines at Y axis to show the national average and minimum-maximum range of national gasoline price.

1. Double-click on Y axis to open the Axis dialog again. Go to **Reference Lines** tab, click **Details...** button to open the Reference Lines dialog.

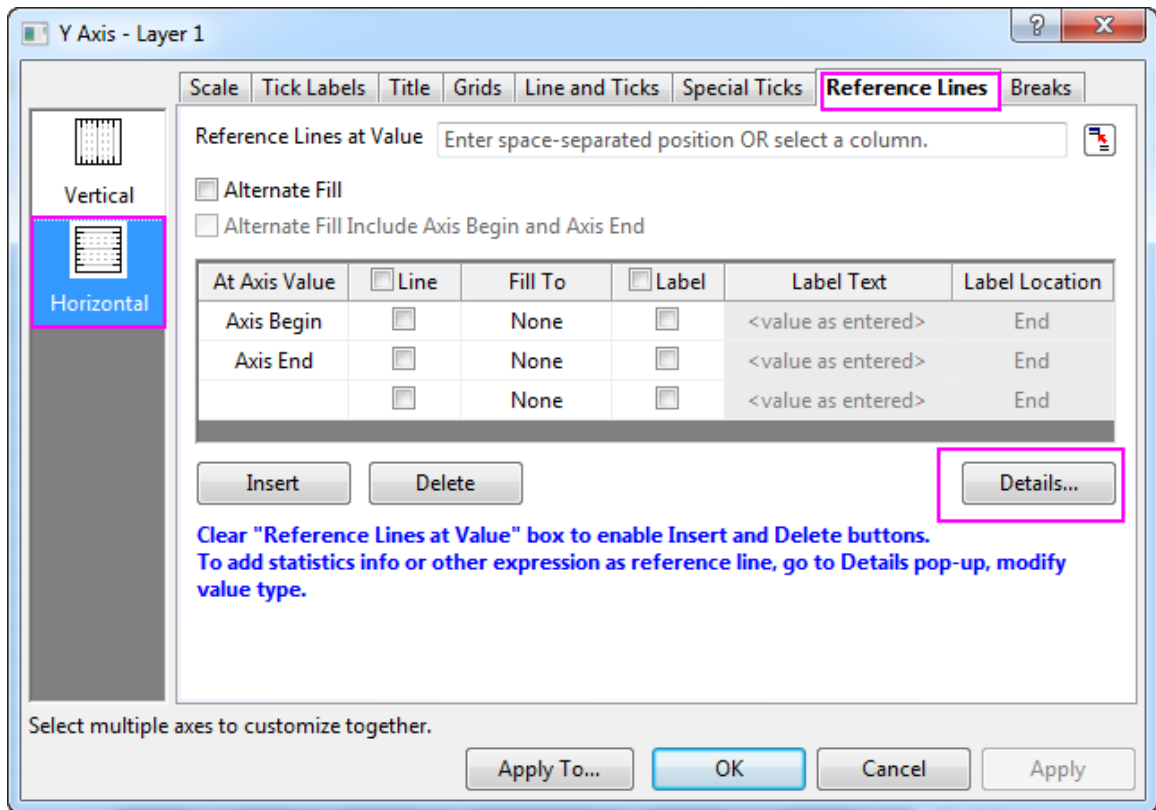

2. Click **Add** button at the bottom of **Reference Lines** dialog to add a reference line. Select this new line, set **Value Type** to **Statistics**, and enter  $Mean(plotdata(6, Y))$  in the **At Axis Value** box (You can click the arrow at the end of this box to select a built-in pattern). Change the line style to **Royal** and **Dash**, and

check **Show** box under the **Label** node.

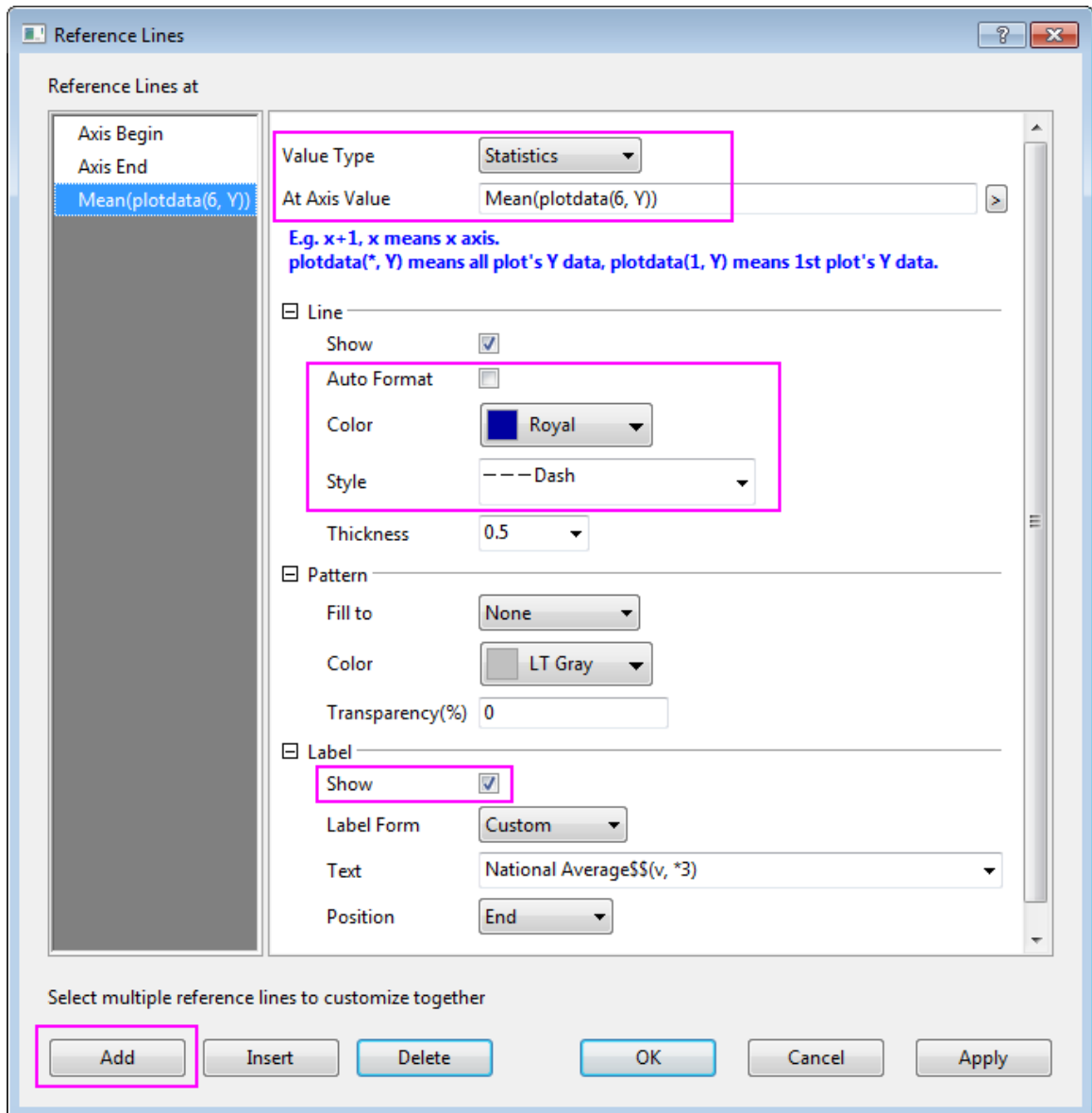

3. Click **Add** button again to add second reference line. With this line selected at the **Reference Lines at** panel, set **Value Type** to **Statistics**, and enter  $\min(\text{plotdata}(6, Y))$  in the **At Axis Value** box. Set Line

Style to **Royal** and **Solid**.

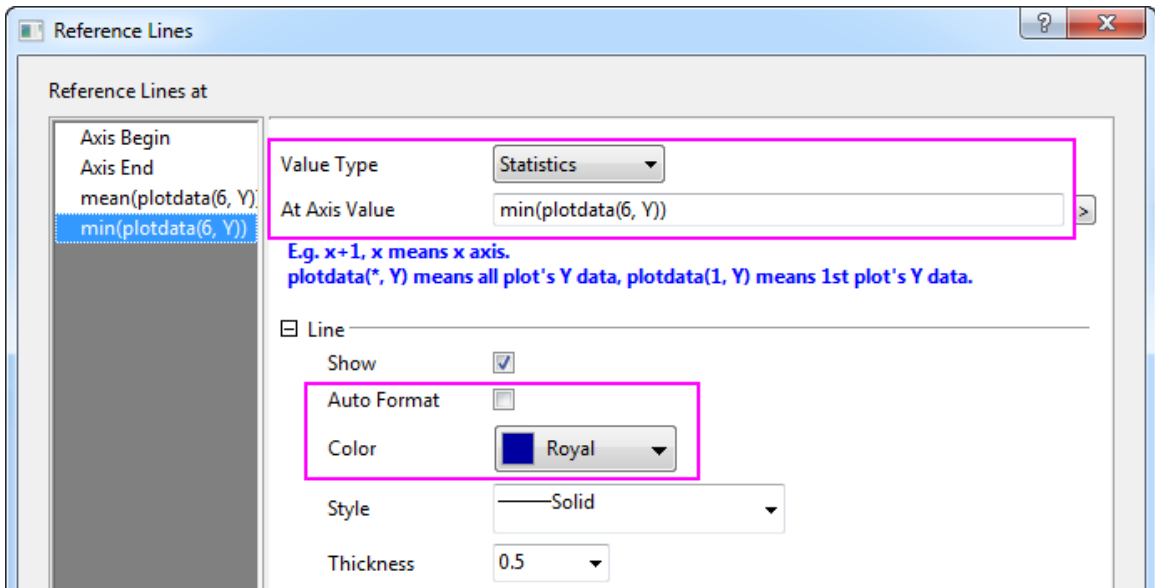

4. Click **Add** button again to add third reference line. With this line selected at the **Reference Lines at** panel, set **Value Type** to **Statistics**, and enter  $max(plotdata(6, Y))$  in the **At Axis Value** box. Set Line Style to **Royal** and **Solid**.
5. Click OK button to close the dialog and add the reference lines to the line table.

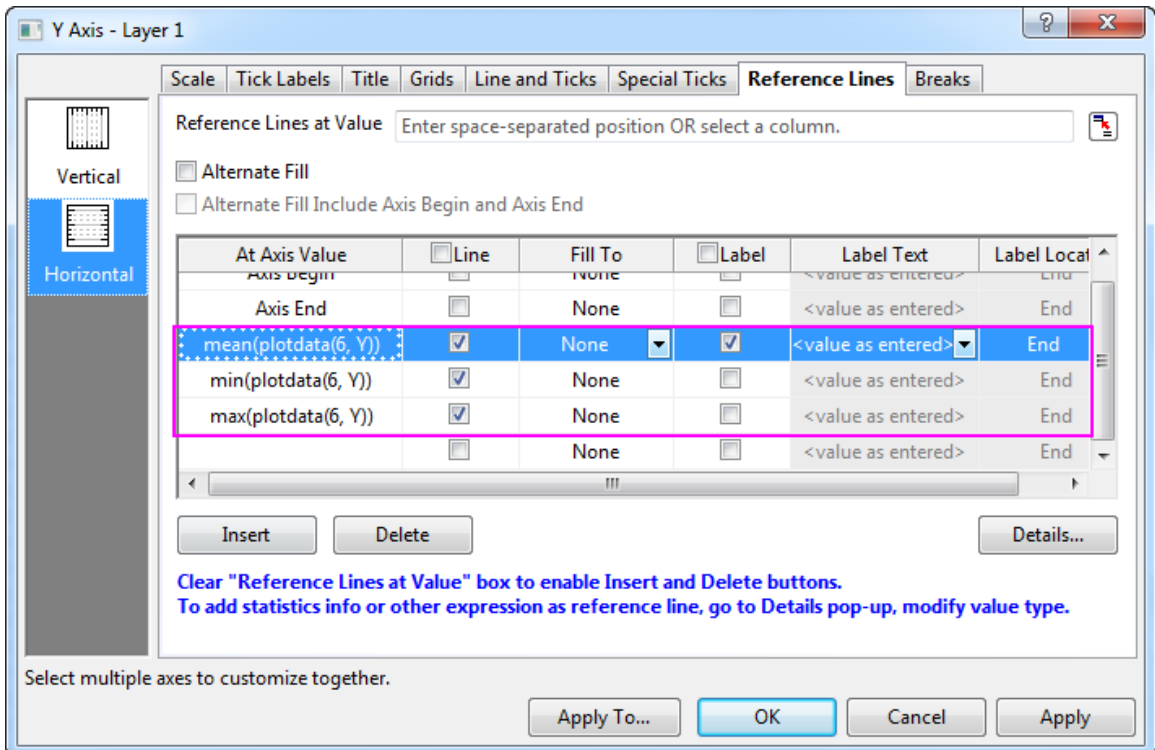

6. Enter **National Average** at the **Label Text** cell of first added line. And select the **Fill To** line for the second and third reference line as below:

At Axis Value	<input type="checkbox"/> Line	Fill To	<input type="checkbox"/> Label	Label Text	Label Loc
Axis Begin	<input checked="" type="checkbox"/>	None	<input type="checkbox"/>	<value as entered>	End
Axis End	<input type="checkbox"/>	None	<input type="checkbox"/>	<value as entered>	End
mean(plotdata(6, Y))	<input checked="" type="checkbox"/>	None	<input checked="" type="checkbox"/>	<b>National Average</b>	End
min(plotdata(6, Y))	<input checked="" type="checkbox"/>	max(plotdata(6, Y))	<input type="checkbox"/>	<value as entered>	End
max(plotdata(6, Y))	<input checked="" type="checkbox"/>	min(plotdata(6, Y))	<input type="checkbox"/>	<value as entered>	End
	<input type="checkbox"/>	None	<input type="checkbox"/>	<value as entered>	End

7. Click **Apply** button to add the reference lines to the graph. Click **Details...** button again to open the **Reference Lines** dialog, select the second line at right panel, and then set **Fill Color** under **Pattern** node to **Cyan** and **Transparency** to 90. Click OK button.

Reference Lines

Reference Lines at

- Axis Begin
- Axis End
- mean(plotdata(6, Y))
- min(plotdata(6, Y))
- max(plotdata(6, Y))

Value Type: Statistics

At Axis Value: min(plotdata(6, Y))

E.g. x+1, x means x axis.  
plotdata(\*, Y) means all plot's Y data, plotdata(1, Y) means 1st plot's Y data.

Line

Show:

Auto Format:

Color: Royal

Style: Solid

Thickness: 0.5

Pattern

Fill to: max(plotdata(6, Y))

Color: Cyan

Transparency(%): 90

8. Click OK button again to close the dialog. Go back to the graph, right-click on the label of the mean line to select **Properties...** from context menu to open the **Text Object** dialog. Enter the text below and do the format settings:

National Average

\$\$ (v, \*3)

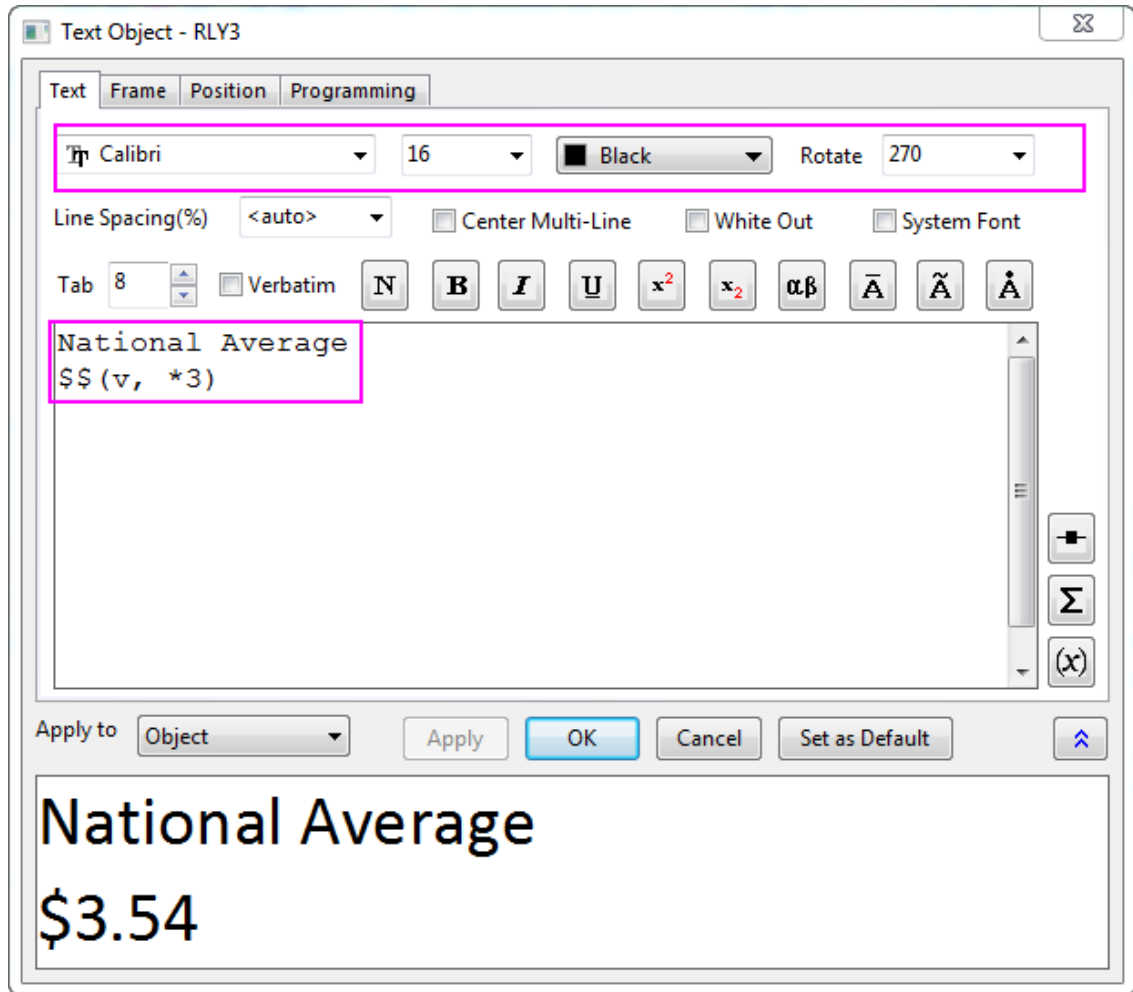

9. Click OK button. At the end, you will get the final graph.

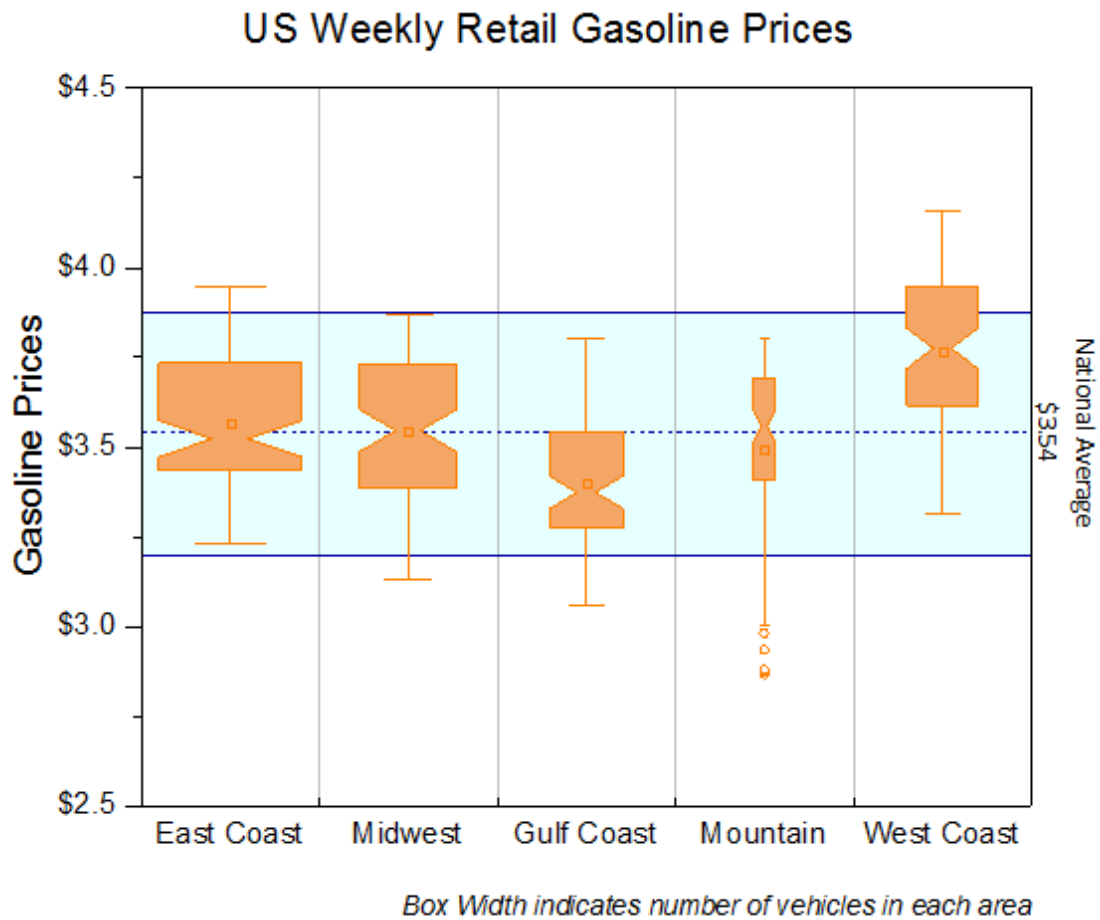

## 6.11.11 Simple Dot Chart

### 6.11.11.1 Summary

Dot chart is a statistical chart which consists of data points plotted on a simple scale. It is often used as a substitute for the pie chart, as it allows for quantities to be compared easily. This tutorial will teach you how to create a simple dot chart plot:

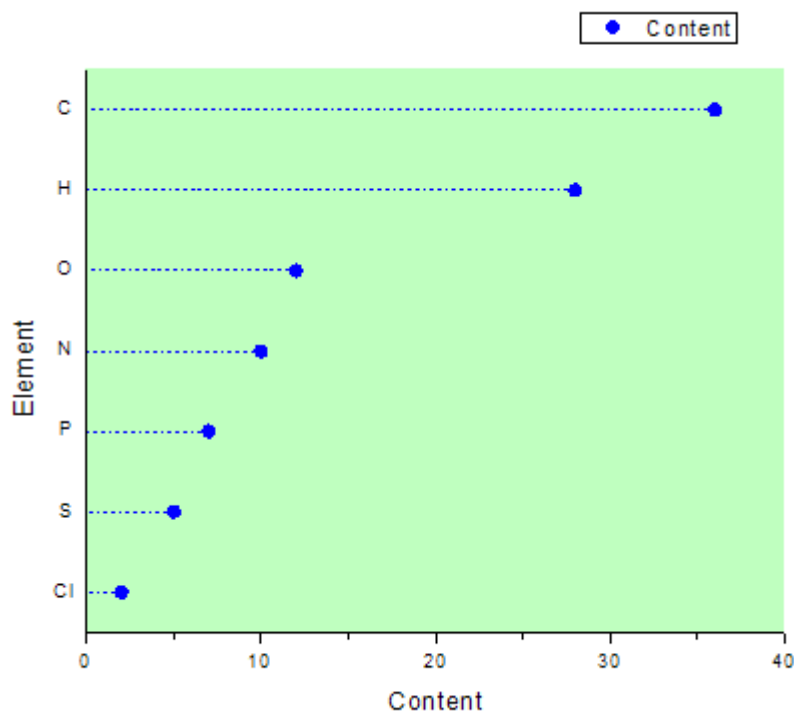

Minimum Origin Version Required: Origin 2015 SR0

#### 6.11.11.2 What you will learn

This tutorial will show you how to:

- Create a scatter graph
- Change the X-Y Axis
- Use the Plot Details dialog to customize your graph

#### 6.11.11.3 Steps

Start with the following data which represents various elements in a compound:

Element	Content
C	36
Cl	2
H	28



N	10
O	12
P	7
S	5

1. Create a new workbook using the **New Workbook** icon in the **Standard** toolbar, and input the data:

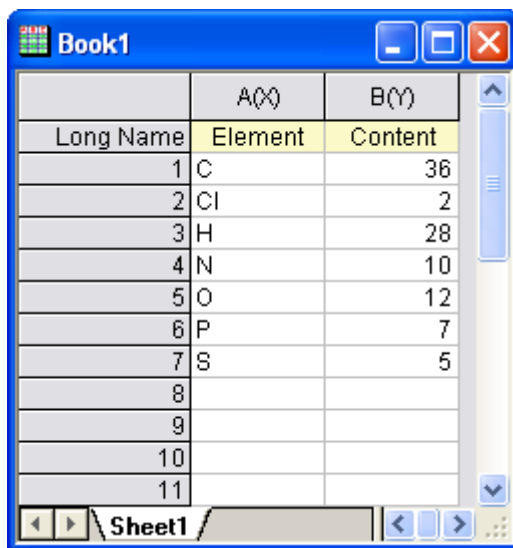

	A(X)	B(Y)
Long Name	Element	Content
1	C	36
2	Cl	2
3	H	28
4	N	10
5	O	12
6	P	7
7	S	5
8		
9		
10		
11		

2. Highlight Col(A) and Col(B). Select the **Plot > Basic 2D : Scatter** menu item from the main menu to create a scatter plot as shown below:

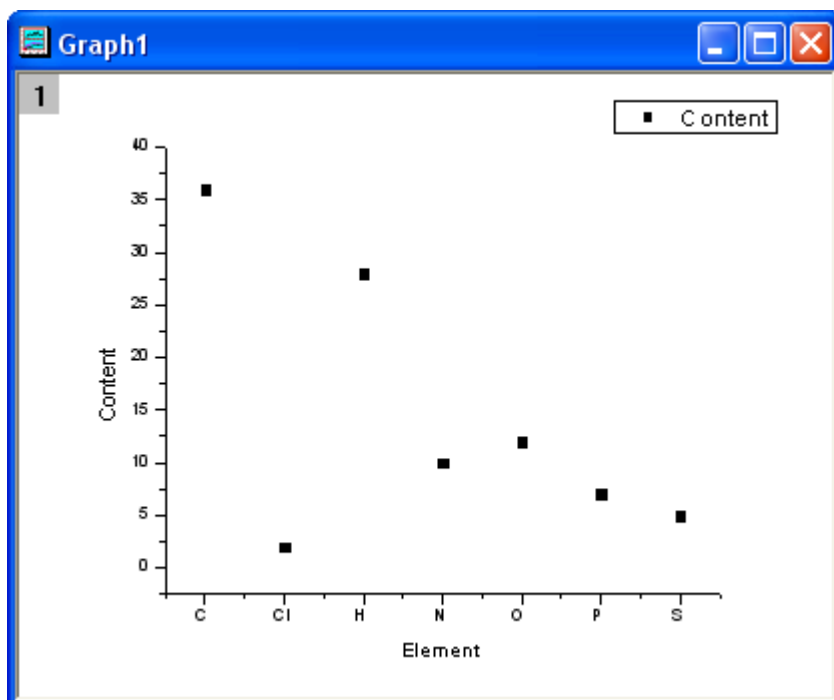

3. Select **Graph: Exchange X-Y Axis** from the menu.

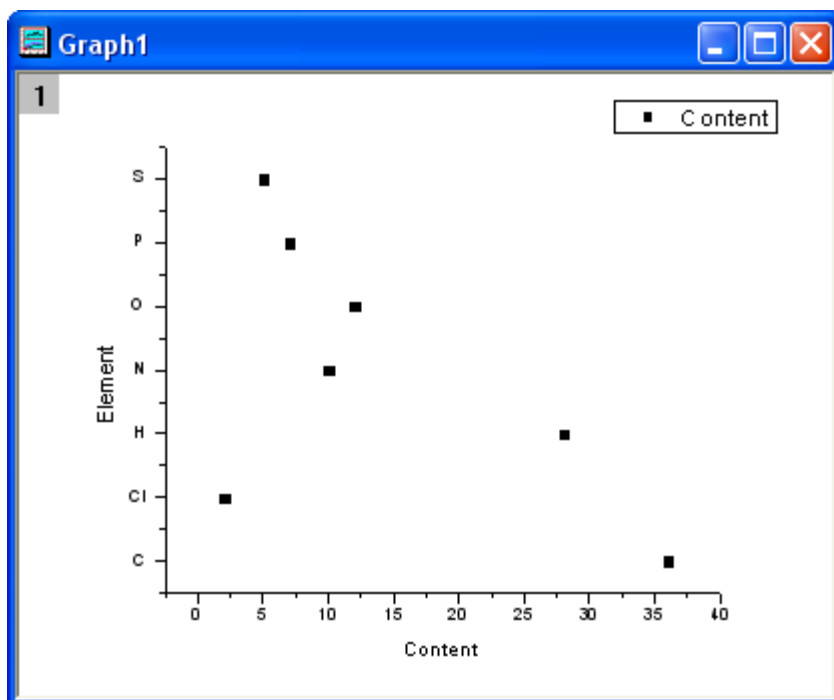

4. Double-click on the graph to bring up the **Plot Details** dialog, change the symbols and the symbol color using the different tabs as shown below:

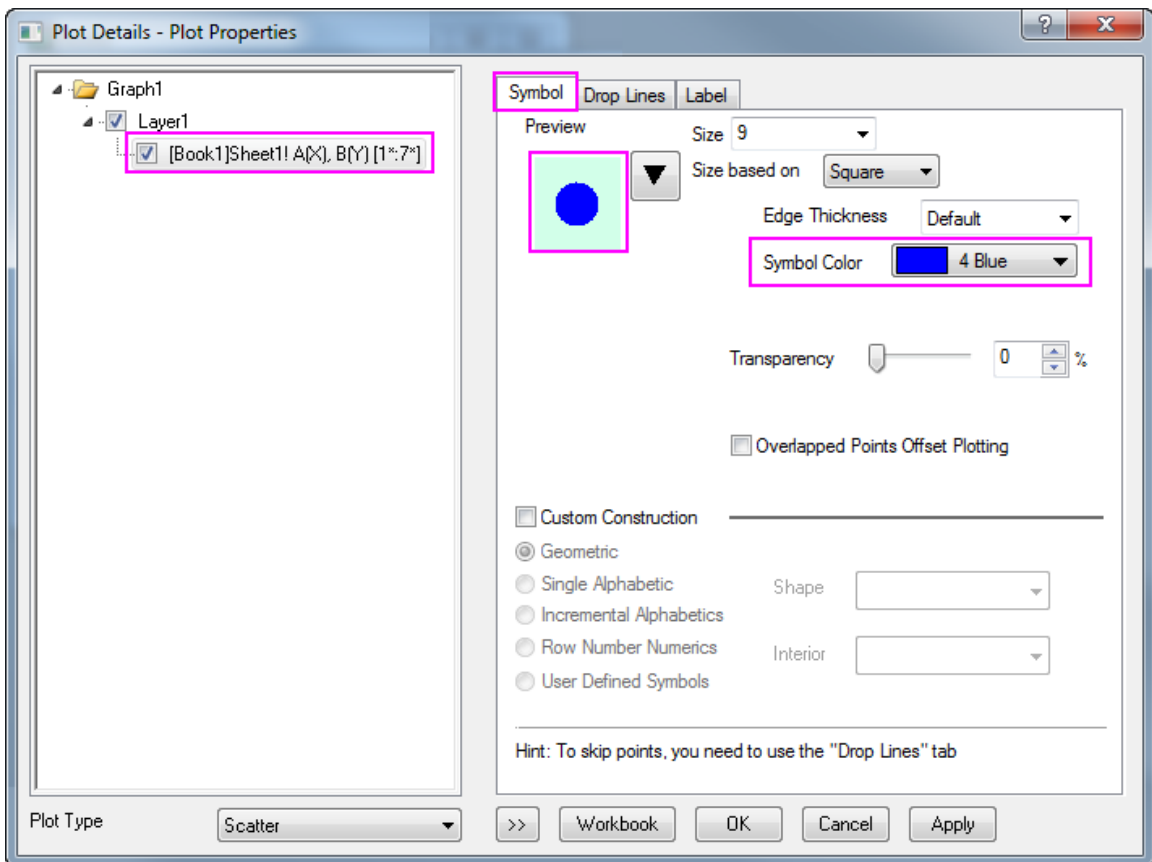
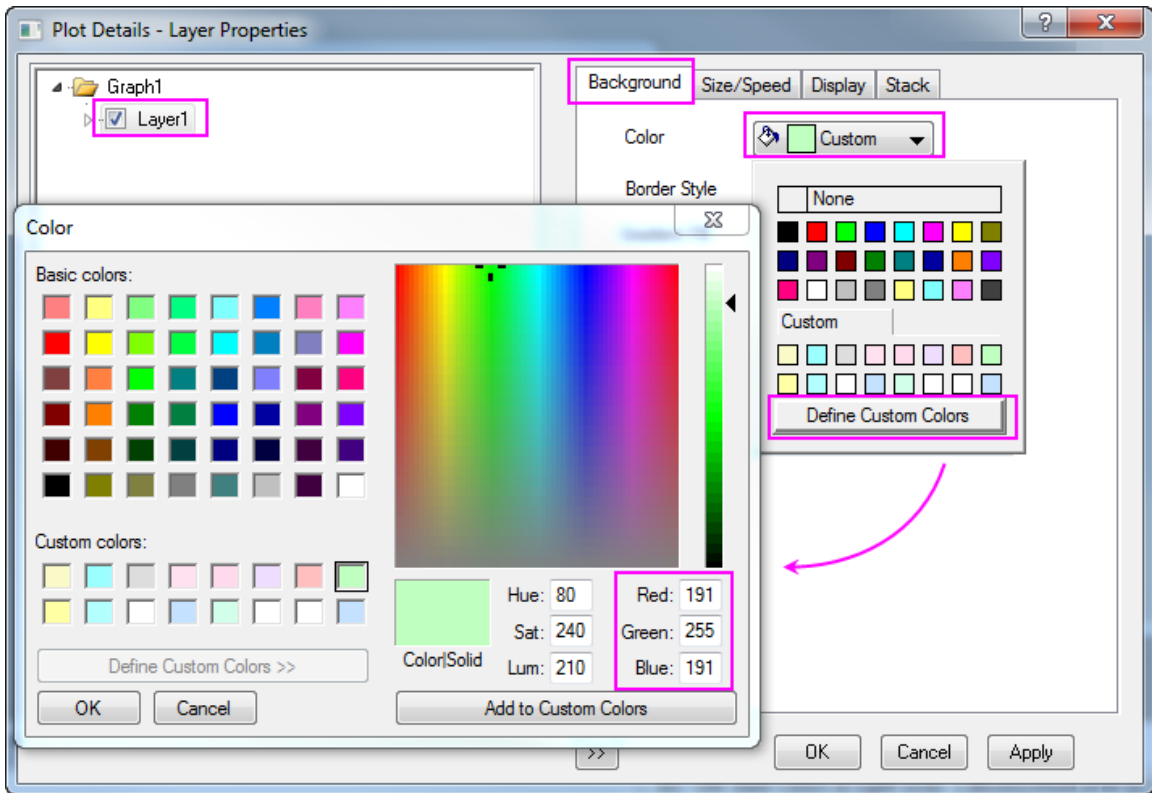

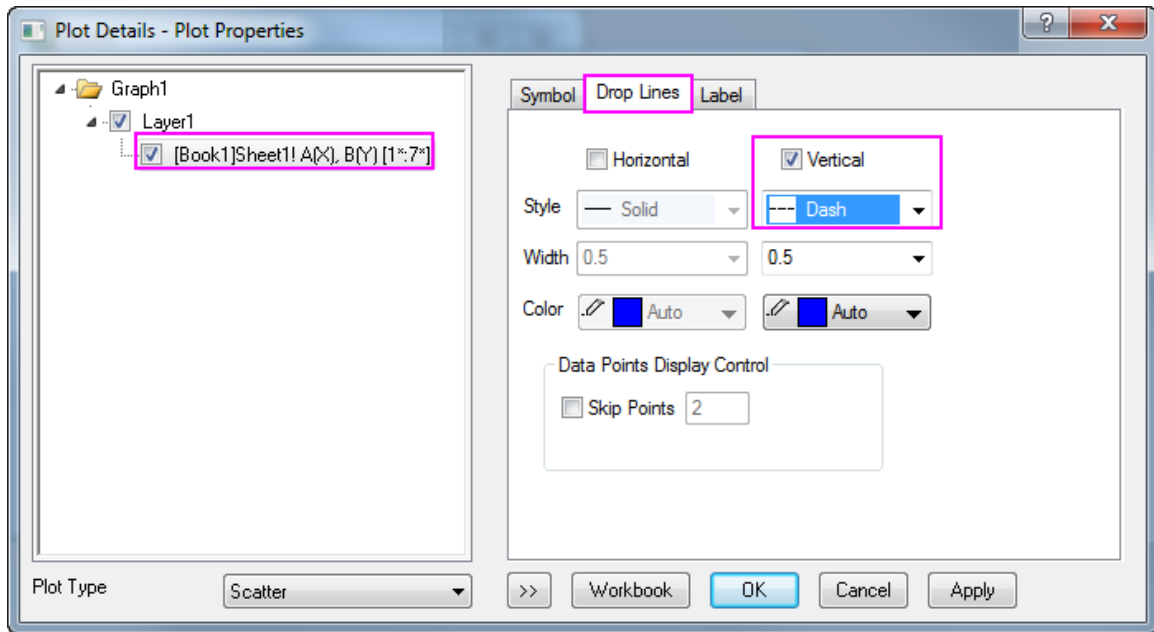

- Click the **OK** button to save the changes and close the dialog. The graph should appear as shown below:

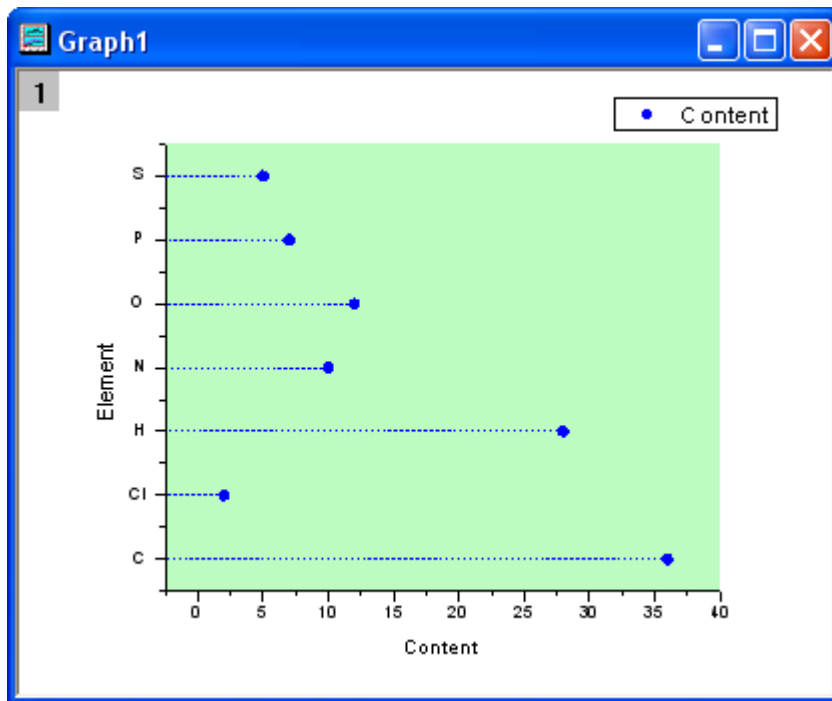

- The next step is to reset the X and Y Axes. Double-click the horizontal axis to open the **Axis** dialog. On the **Scale** page, set **From** as **0** and **To** as **40**. Set the **Increment** as **10**.

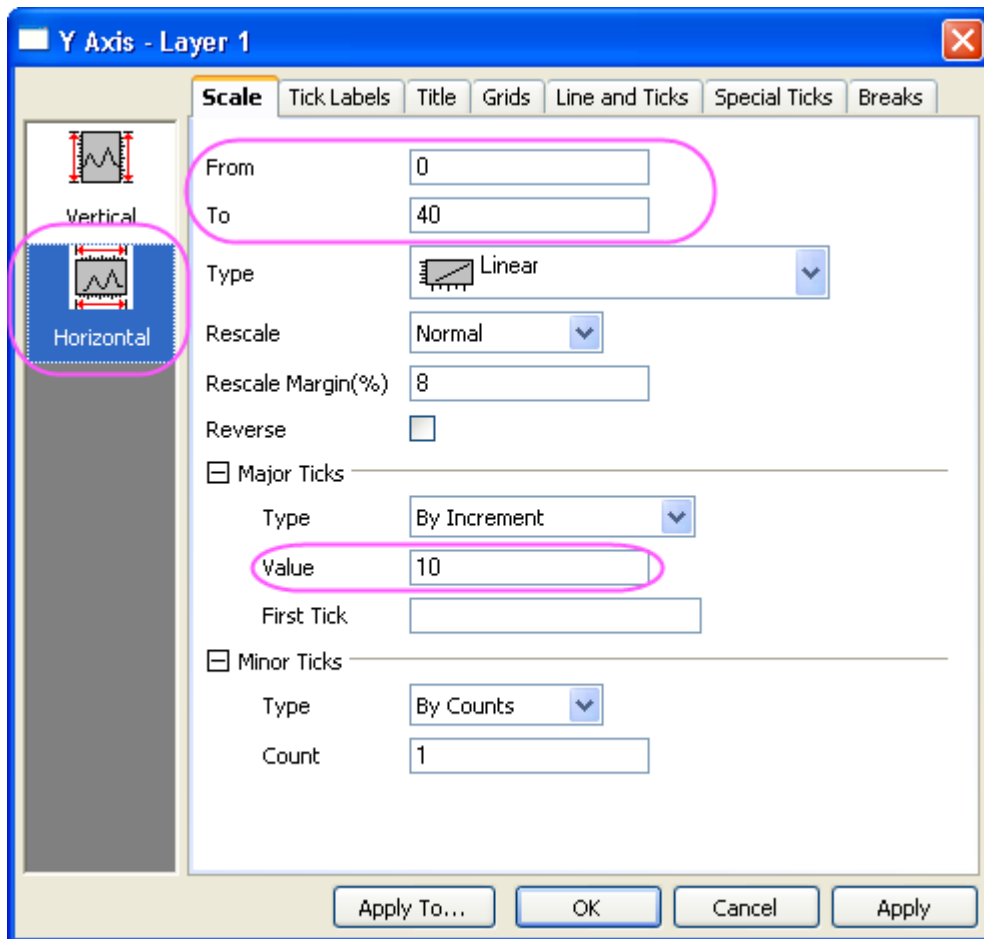

7. Go to the **Line and Ticks** page, select the **Left** icon in the left panel, and set both **Major Ticks** and **Minor Ticks** to **None**. Click **OK** to save the changes.

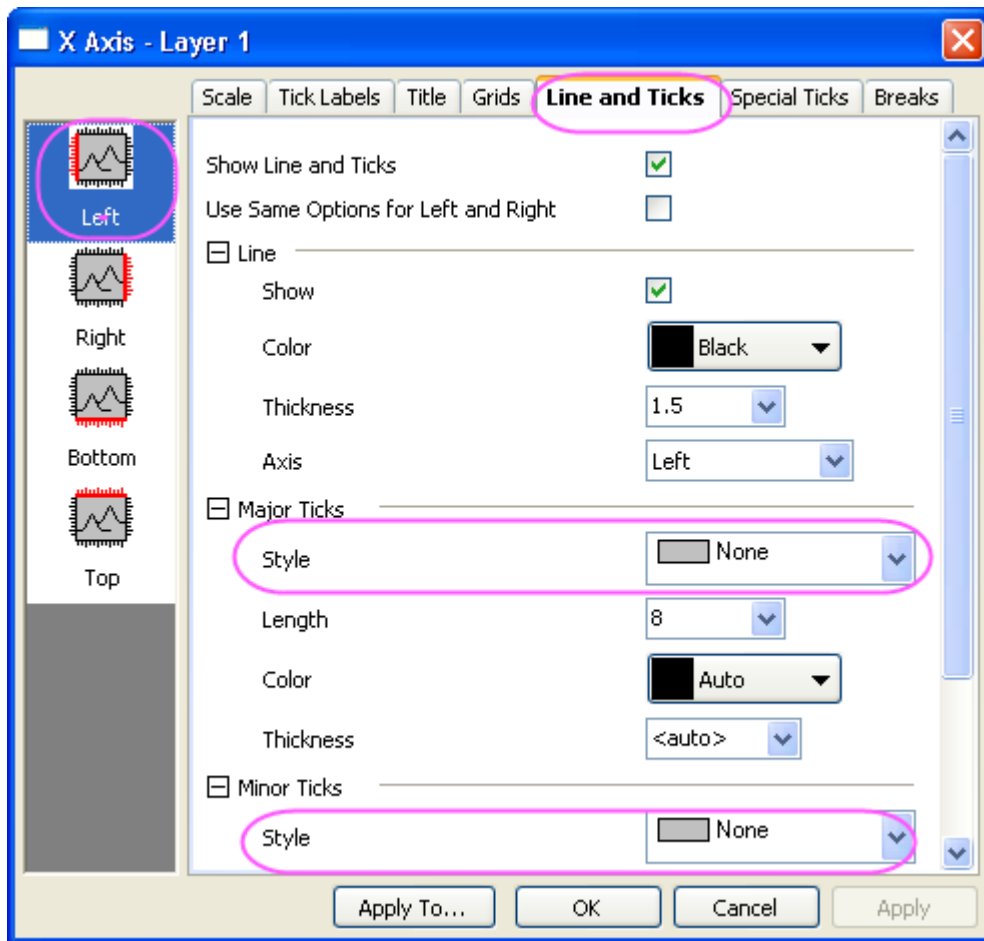

8. The completed Dot chart should appear as shown below:

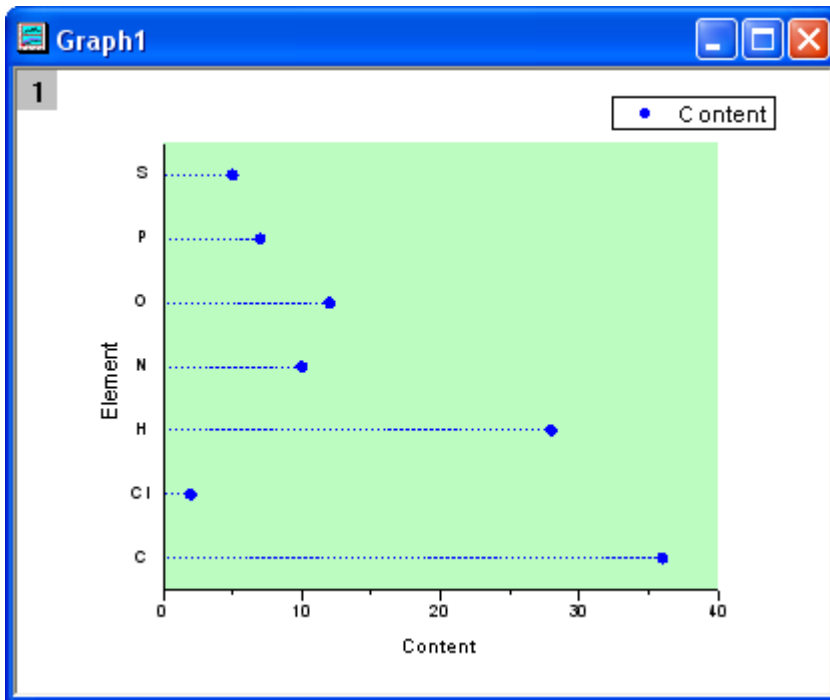

### 6.11.12 Multi-Data Dot Chart

#### 6.11.12.1 Summary

A **Dot Chart** is a statistical chart which consists of data points plotted on a simple scale. It is often used as a substitute for the pie chart because it can make comparing quantities easy. This tutorial will teach you how to create the Multi-Data Dot Chart.

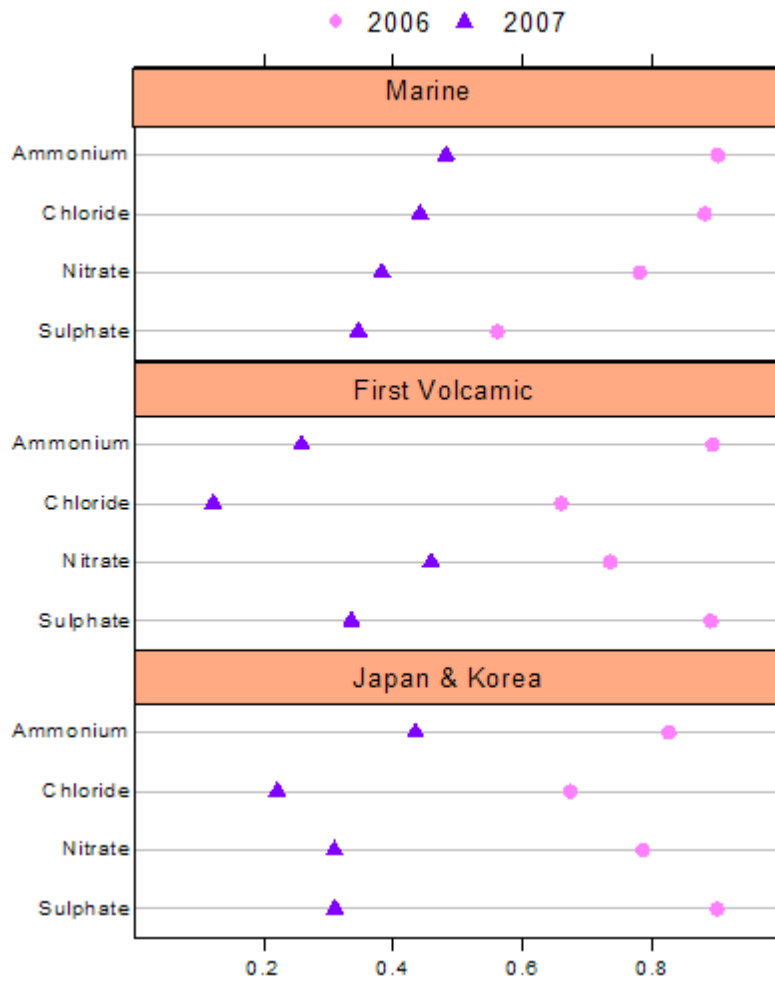

Minimum Origin Version Required: Origin 2015 SR0

#### 6.11.12.2 What you will learn

This tutorial will show you how to:

- Create a scatter graph
- Change the X-Y Axis
- Use Layer Management
- Customize the axes
- Add objects on the graph

#### 6.11.12.3 Steps

The following data concerning the element content of several areas at different times can be used to create a multi-data dot chart:



<b>Sulphate</b>	0.346	0.560	0.333	0.887	0.310	0.899
<b>Nitrate</b>	0.382	0.780	0.456	0.732	0.456	0.732
<b>Chloride</b>	0.441	0.880	0.120	0.656	0.221	0.673
<b>Ammonium</b>	0.481	0.900	0.256	0.890	0.434	0.825

1. Create a new workbook using the **New Workbook** icon on the **Standard** toolbar and input the data.

	A(X)	B(Y)	C(Y)	D(Y)	E(Y)	F(Y)	G(Y)
Long Name							
Units							
Comments							
1	Sulphate	0.346	0.56	0.333	0.887	0.31	0.899
2	Nitrate	0.382	0.78	0.456	0.732	0.309	0.785
3	Chloride	0.441	0.88	0.12	0.656	0.221	0.673
4	Ammonium	0.481	0.9	0.256	0.89	0.434	0.825
5							

2. Hover the cursor over the very first cell of the col(B) till it turns into a downward arrow. Left-clicking highlights col(B) and dragging highlights col(C). Select **Plot > Basic 2D: Scatter** from the main menu to create a graph, and select **Graph: Exchange X-Y Axis**. An alternate way of creating scatter graphs is using the scatter icon in the **2D Graphs** toolbar.
3. Repeat step 2 twice to create two more graphs with col(D) and col(E), as well as col(F) and col(G).
4. To Merge the three graphs, select **Graph: Merge Graph Windows: Open dialog**. In the dialog box that opens expand **Arrange Settings**, set the **Number of Rows** as **3** and the **Number of Columns** as **1**. The Preview window on the right shows how the three graphs will be arranged and which layers they will be on. Click the **OK** button to save . This creates a new graph which contains three layers each containing a separate graph.

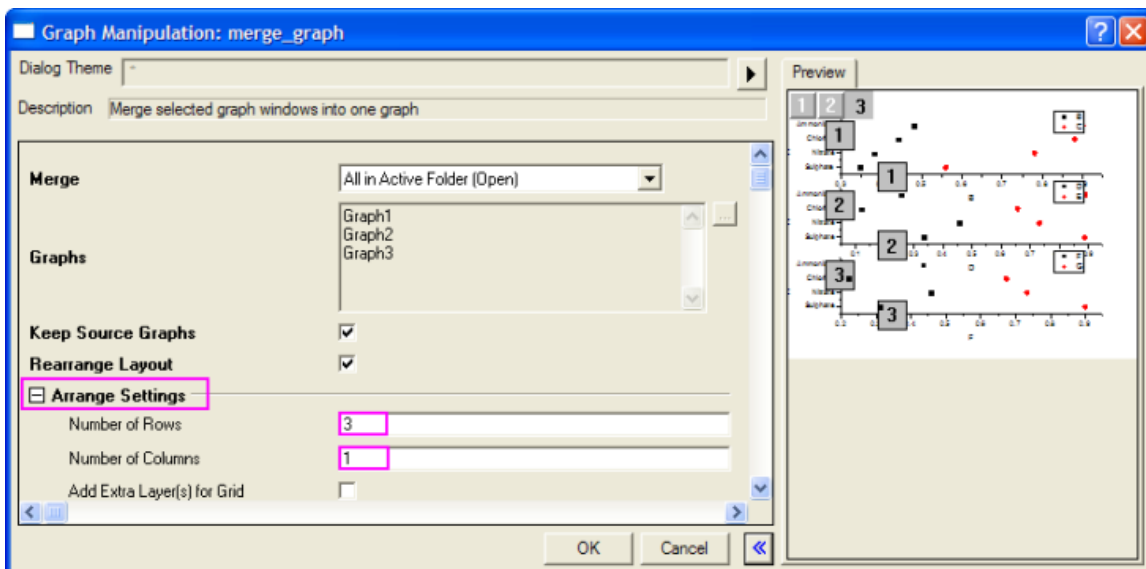

- To clean up the graph, delete the legends and axis titles in the graphs by selecting them and pressing the **Delete** key.

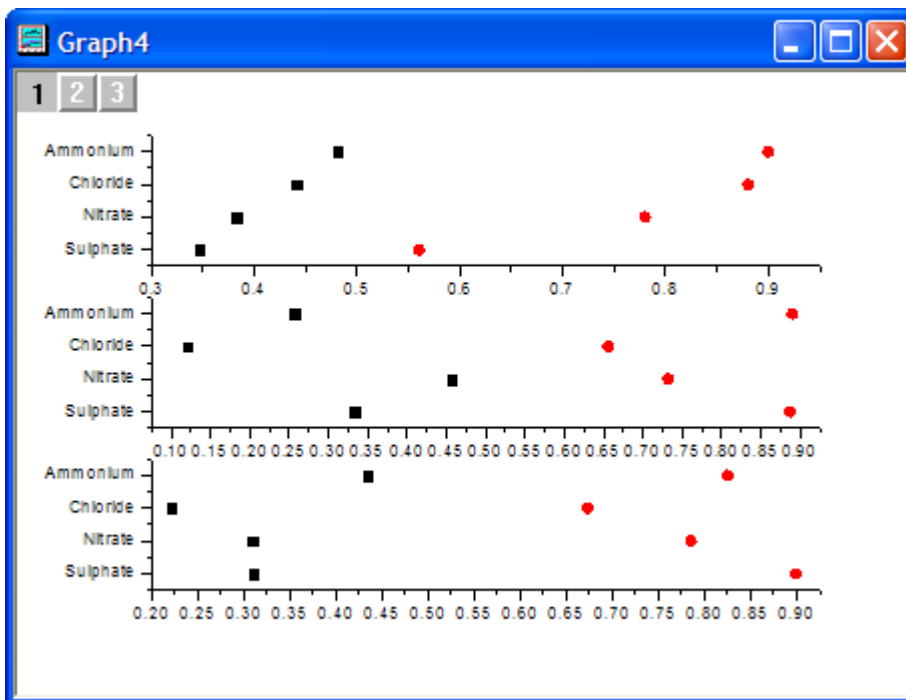

- Select **Graph: Layer Management** from the main menu. Select Layer 2 on the left. In the right panel **Link** tab set **Link to** as **1**. This links the Y axis of the second layer containing the second graph to the first layer containing the first graph. Set the **Y Axis Link** as **Straight (1 to 1)**, this will ensure that the axis for the two graphs is the same. Click the **Apply** button. Check the **When dragged to reposition, also reposition parent layer** box. This setting will ensure that when one axis is moved, the other follows accordingly.

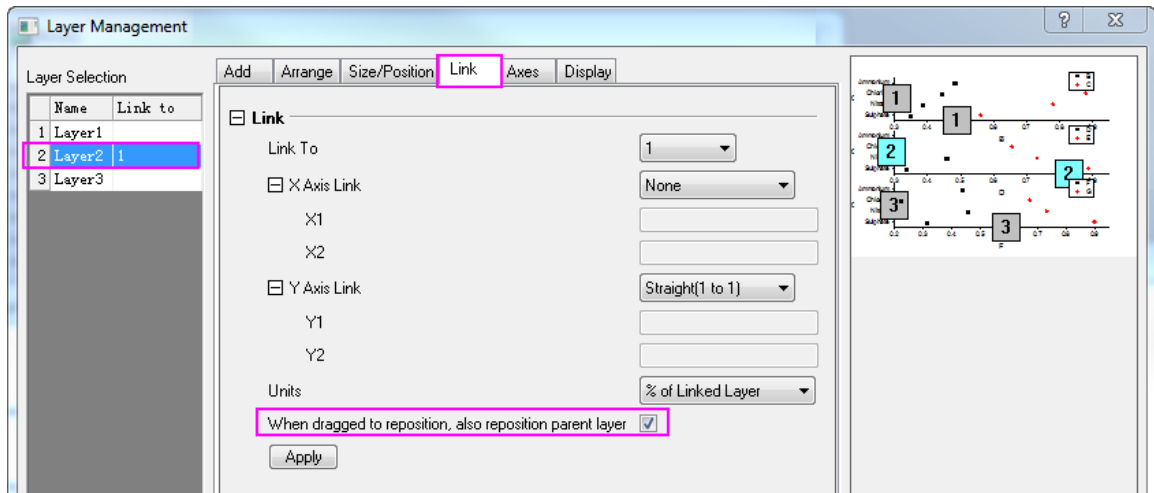

7. Select Layer 3 on the left and repeat the previous step. Click the **OK** button to save changes.
8. In order to reset the X and Y Axes, make sure Layer 1 is the active layer by clicking on **1** at the top left corner of the graph. Double-click on the horizontal axis of the graph layer. On the **Scale** page when **Horizontal** icon is selected, set the values shown below (since the layer axes were linked in the last step, these changes are applied to all three axes):

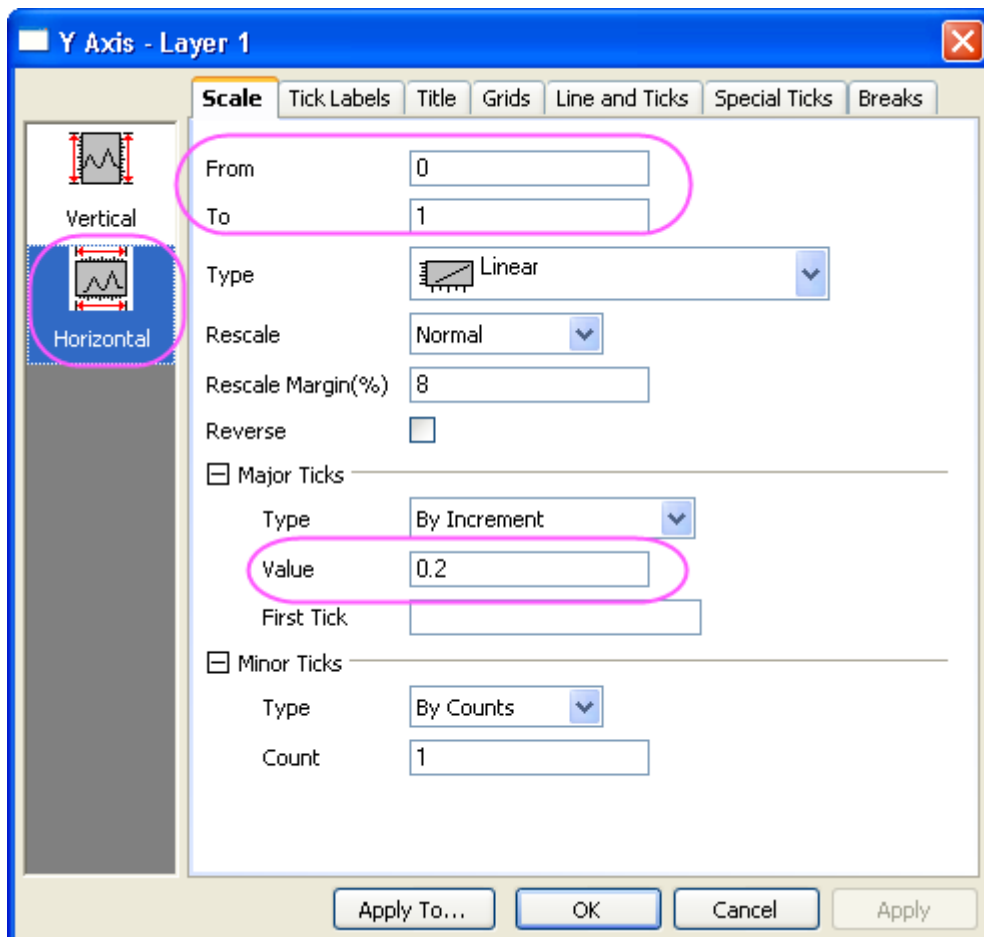

- Go to the **Line and Ticks** page, select **Top** icon in the left panel, check the **Show Line and Ticks** check box to show the top Y axis. And then set **Major Ticks** as **Out** and **Minor Ticks** as **None**.

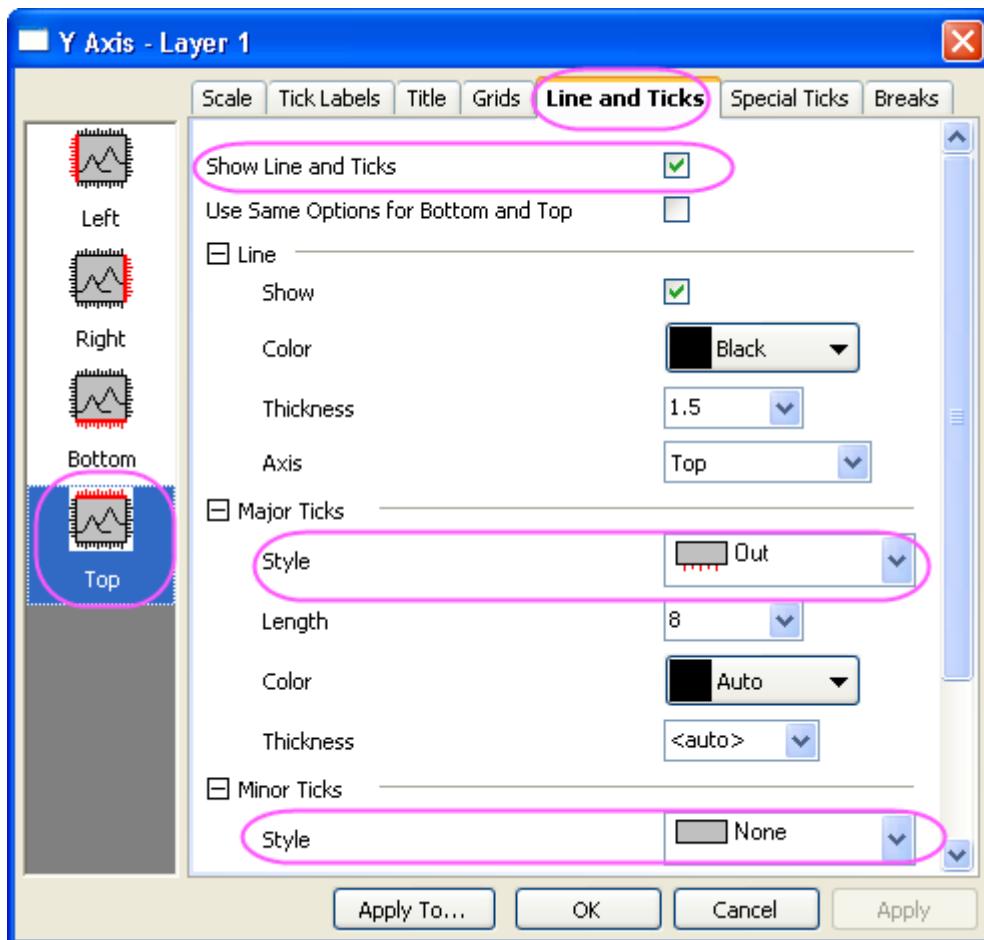

- Select **Bottom** icon in the left panel, in the **Line and Ticks** page, set **Major Ticks** and **Minor Ticks** as **None** to remove the ticks.

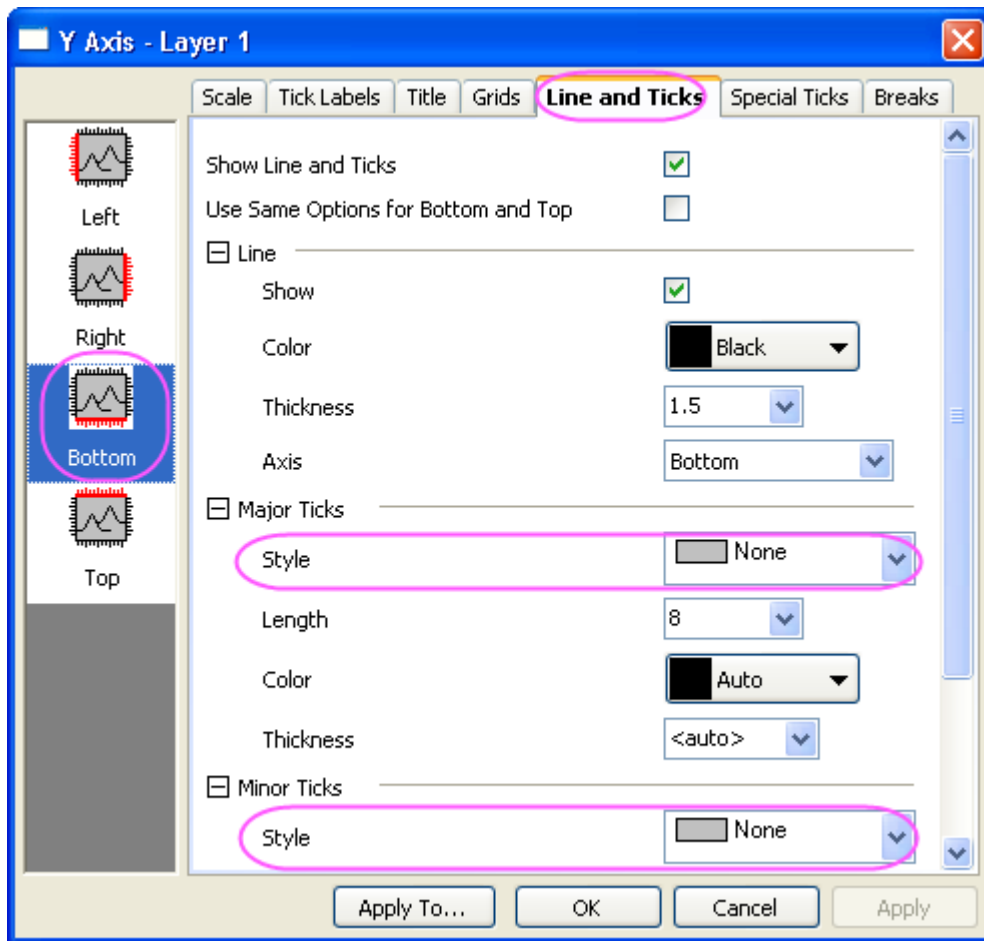

11. Go to **Tick Labels** page in the right panel, select **Top** icon in the left panel, check **Show** check box.

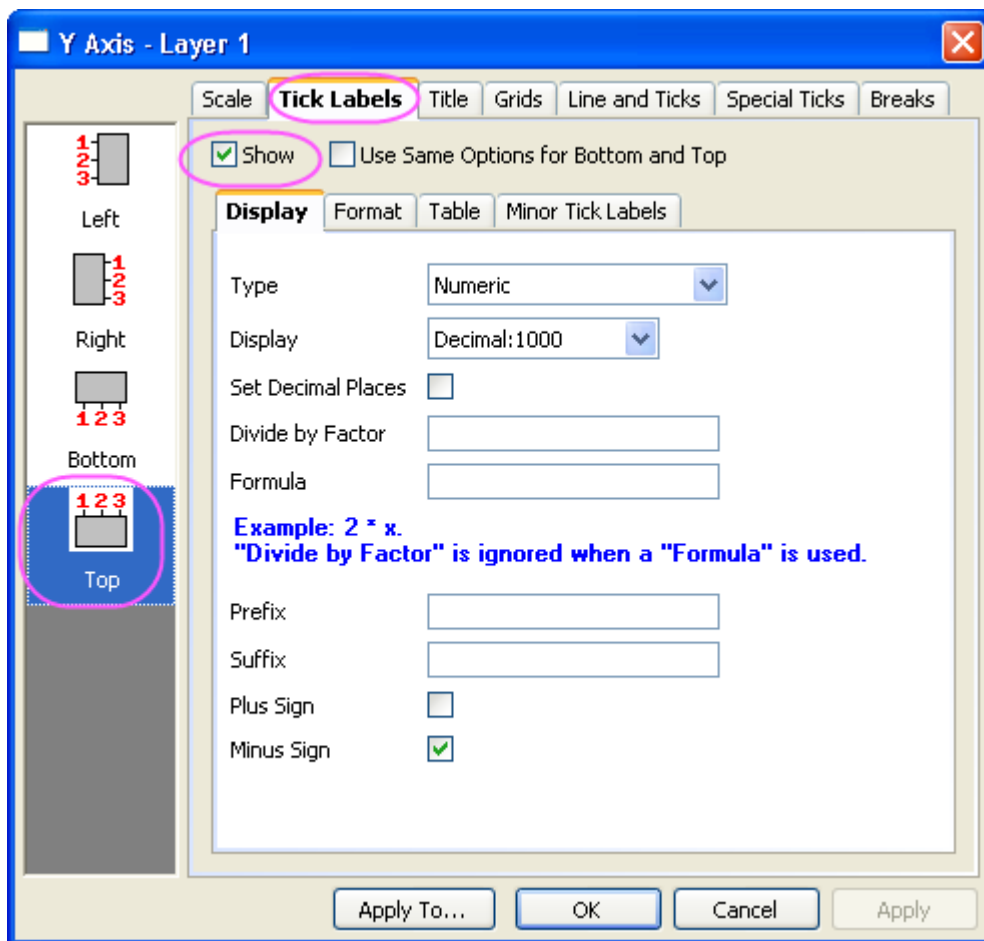

12. Go to the **Special Ticks** page, select **Top** icon in the left panel, choose **Hide** for both **Axis Begin** and **Axis End**.

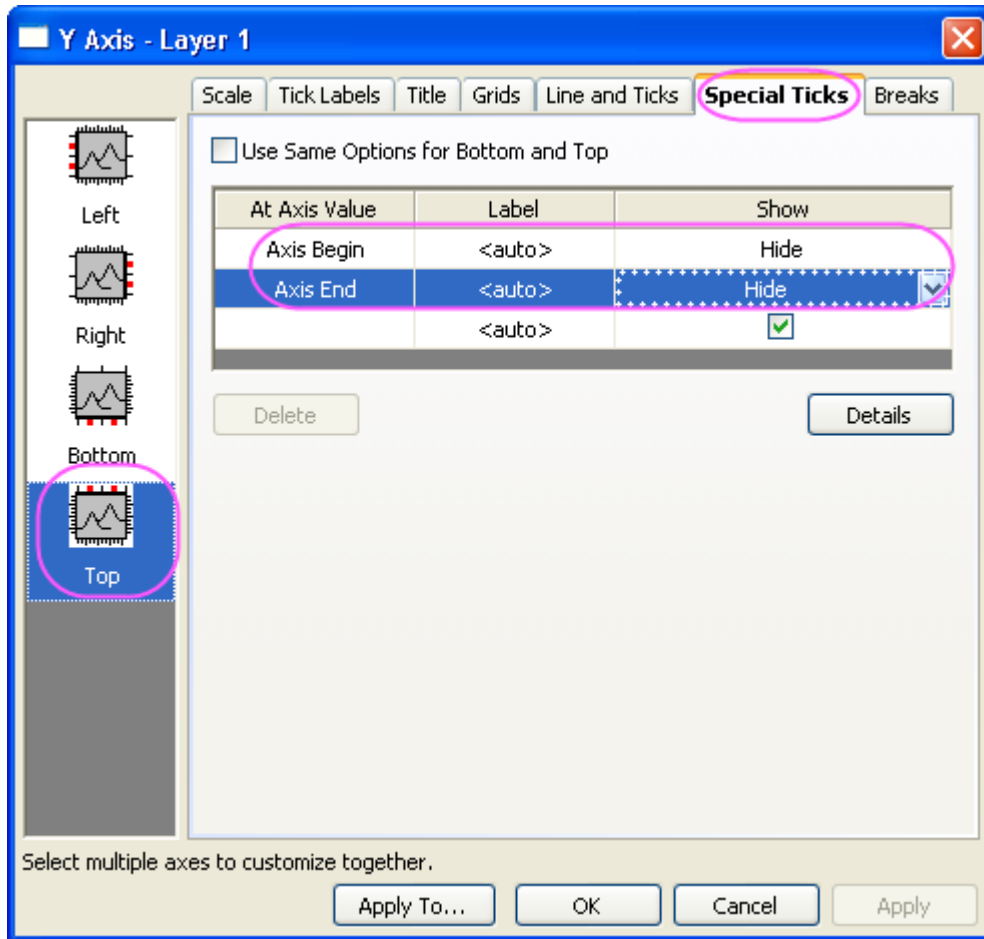

- Go to the **Tick Labels** page, select **Top** icon in the left panel, clear the **Show** check box.

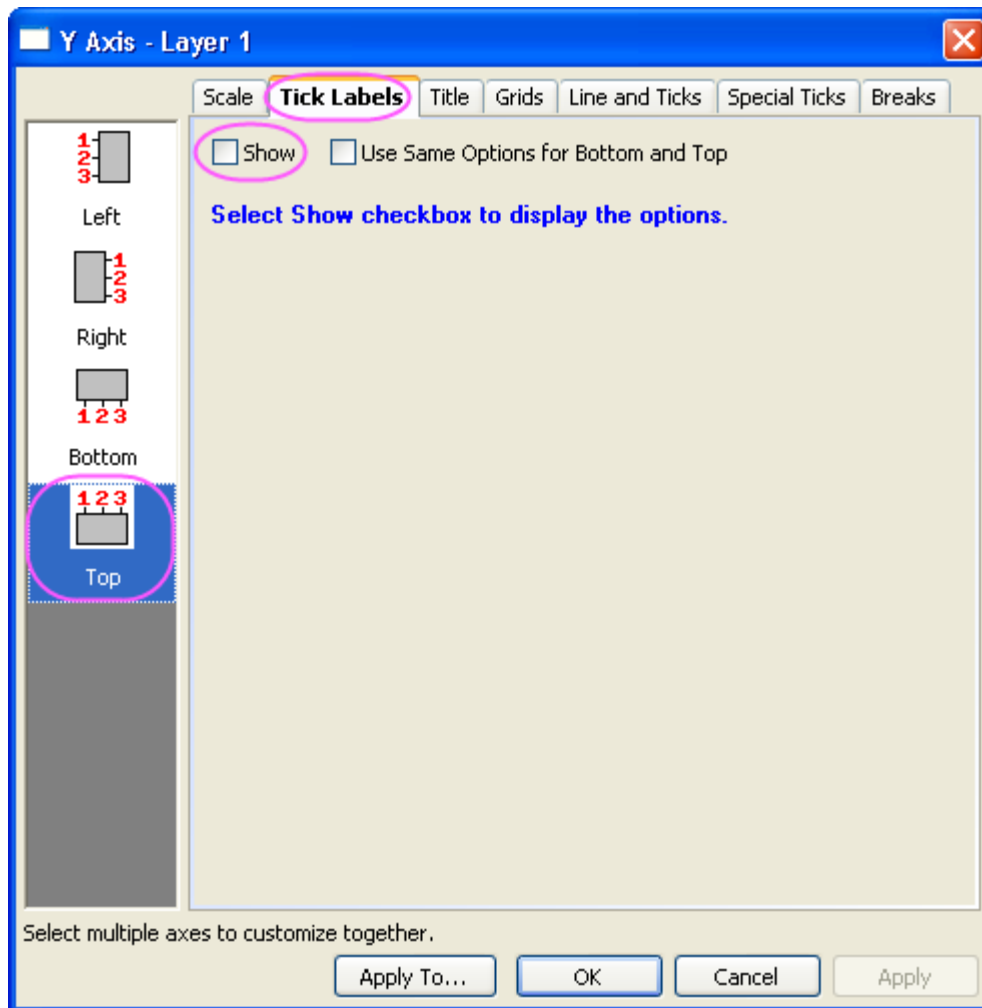

14. Go the **Tick Labels** page, select **Bottom** icon in the left panel, clear the **Show** check box.



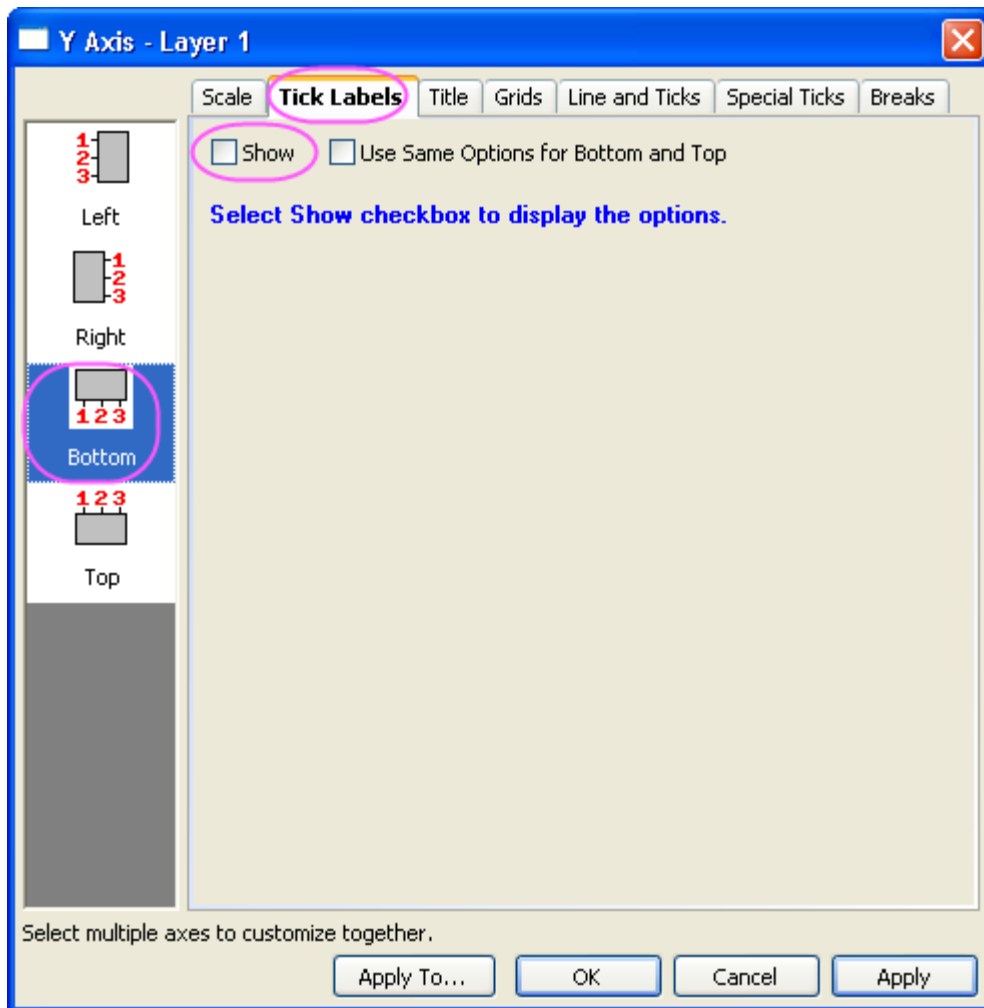

15. Go to the **Line and Ticks** page, select **Left** icon in the left panel, check **Use Same Options for Left and Right** check box. And then set both **Major Ticks** and **Minor Ticks** as **None**:

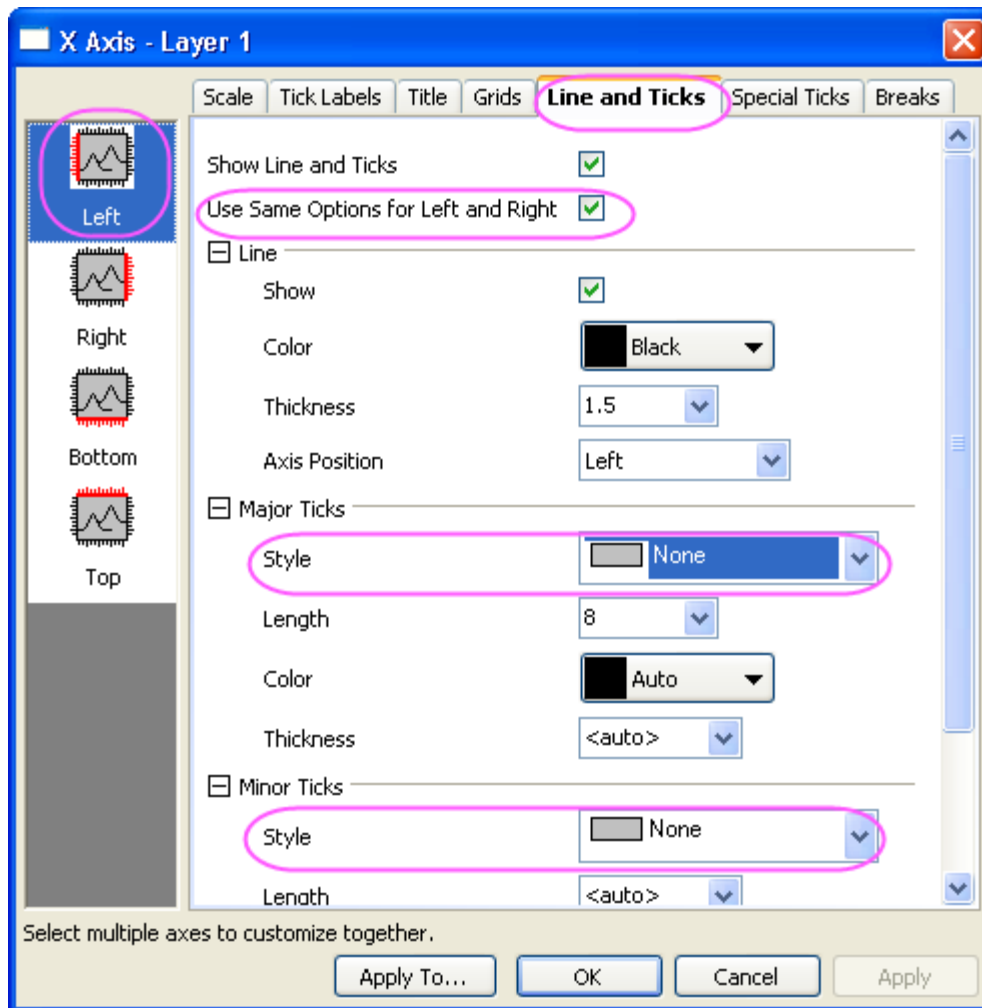

16. Go to the **Grids** page and select **Horizontal** in the left panel, check **Show** check under the **Major Grid Lines** branch.

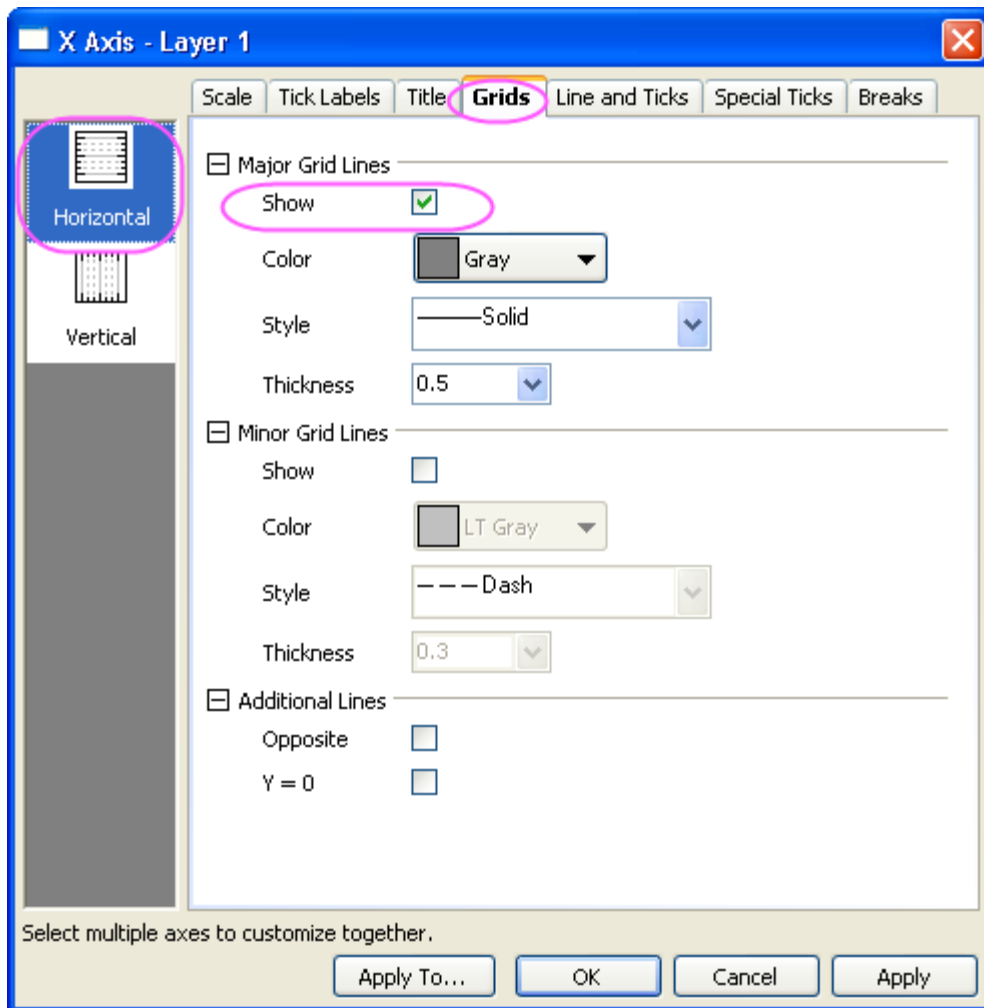

17. Click the **OK** button to apply the settings and close the **Axis** dialog. The graph should now appear as shown below:

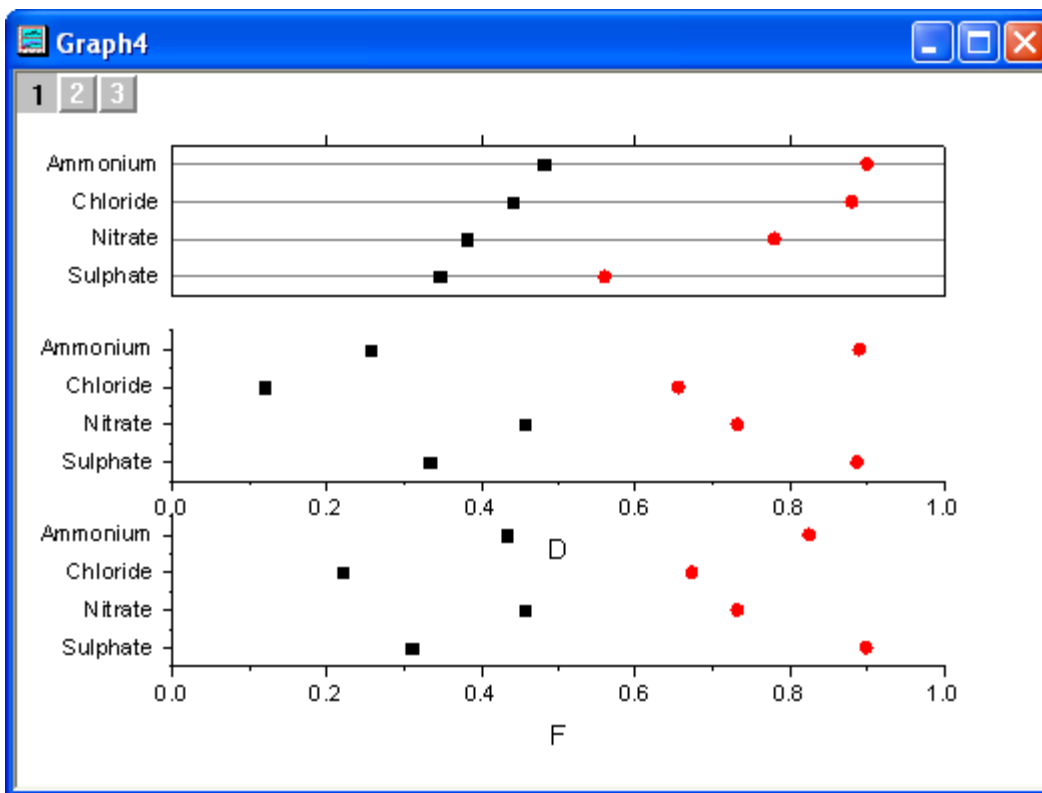

18. Right click on Layer 1 and choose **Copy Format:All Style Formats**. Right click on the graph page and choose **Paste Format** to copy and paste the style from Layer 1 to the whole page.

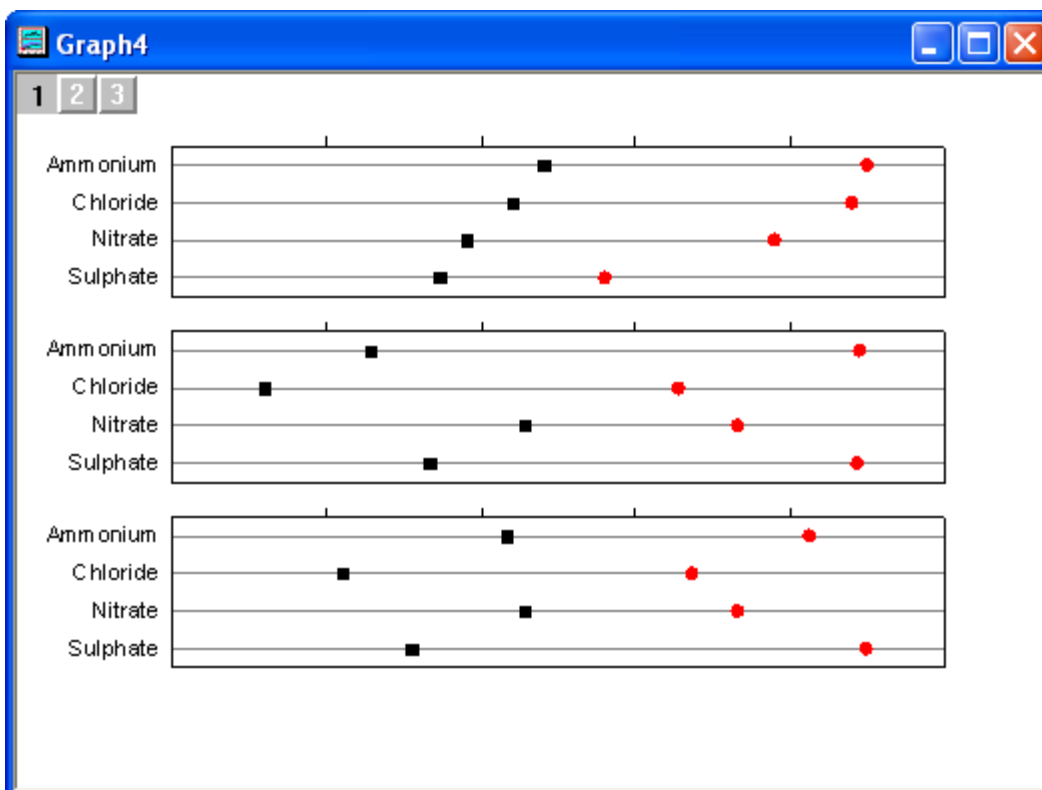

19. Double click on the top axis in Layer 2, go to the **Line and Ticks** page, select **Top** icon in the left panel, set **Major Ticks** and **Minor Ticks** as **None**. Do the same for the top axis of Layer 3.
20. In the **Axis** dialog of Layer 3, go to the **Line and Ticks** page, select **Bottom** icon in the left panel, set **Major Ticks** to **Out**.
21. On the **Tick Labels** page, select **Bottom** icon in the left panel, check **Show** check box.
22. Go to the **Special Ticks** page, select **Bottom** in the left panel, and choose the **Hide** option for both **Axis Begin** and **Axis End**. Click **OK**.

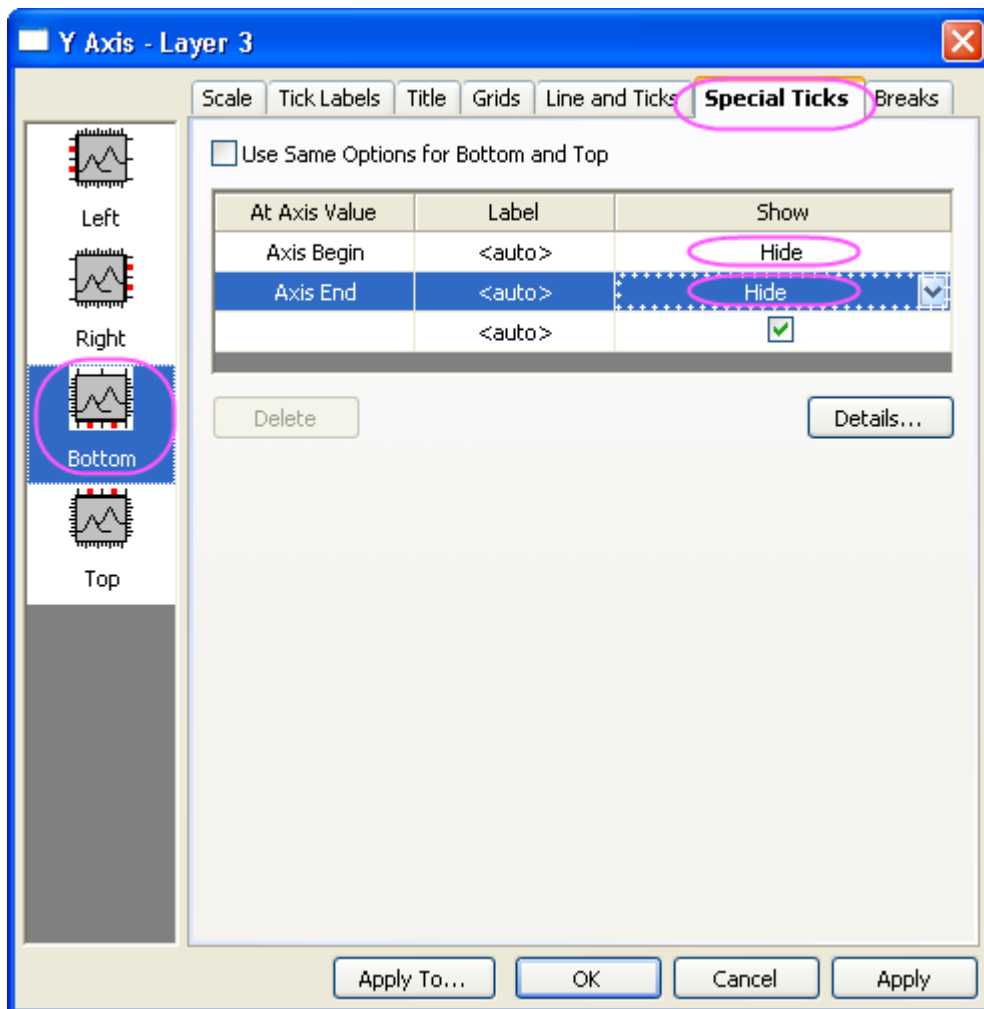

23. The graph should appear as shown below:

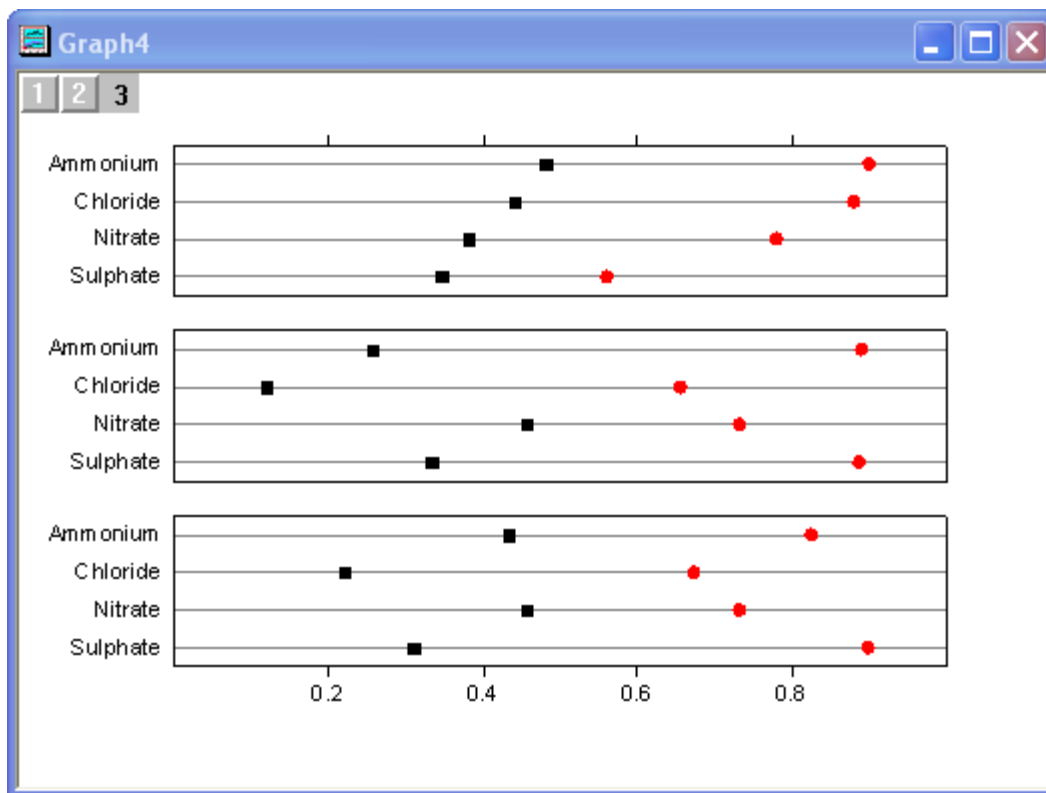

24. Double-click the graph to bring up the **Plot Details** dialog. Change the settings as shown below. Setting the **Edit Mode** as **Independent** ensures that the symbols can be customized separately for each data set on one layer. For Symbol shape, uncheck the **Custom Construction** check box, click the down arrow button to select different symbol shape. For symbol color, in the **Symbol** tab click on the **Symbol Color** option and select **Individual Color** to set one color to all the symbols as in this tutorial:

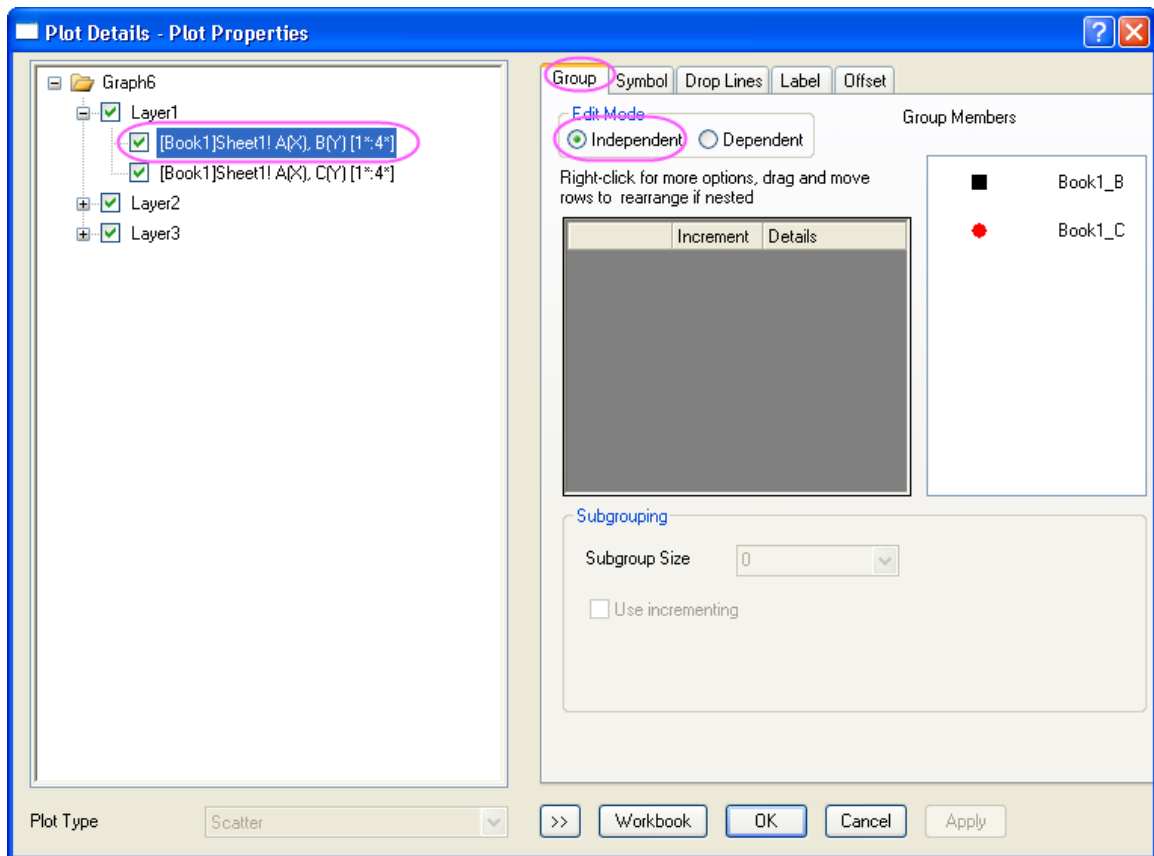

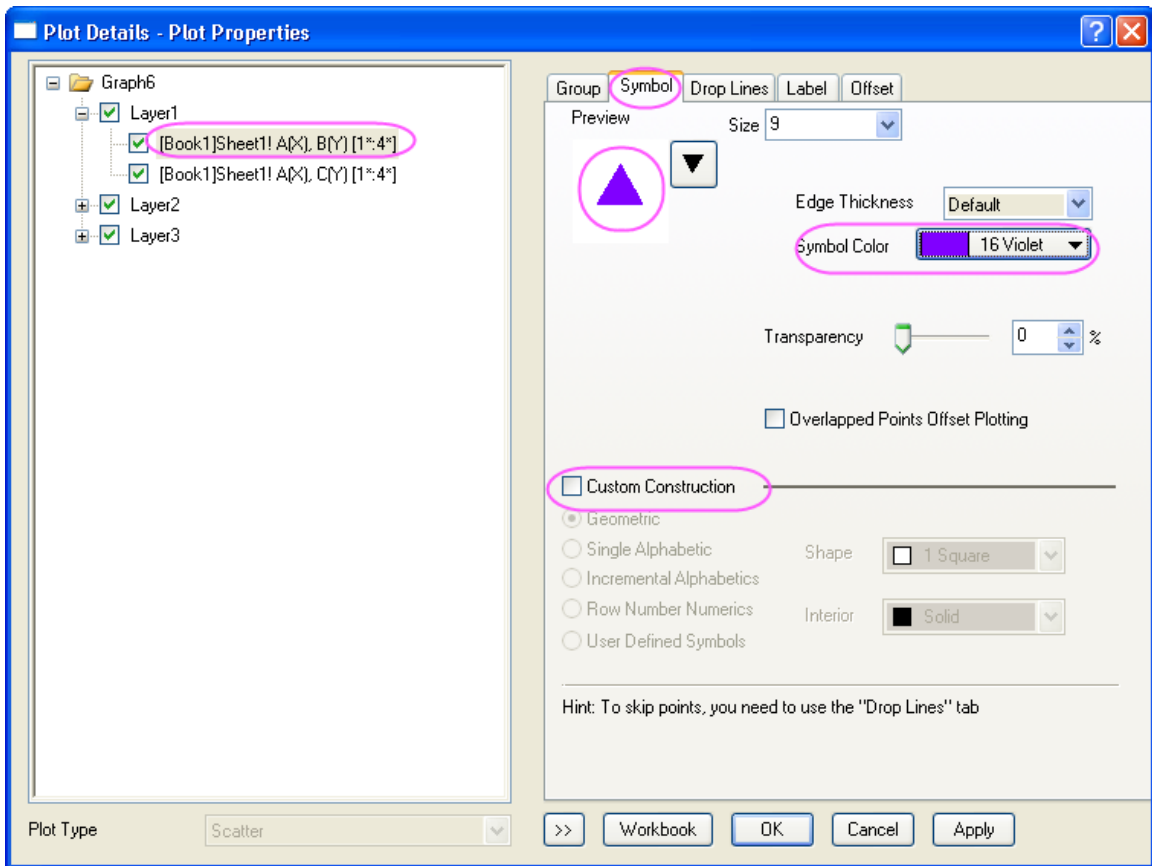



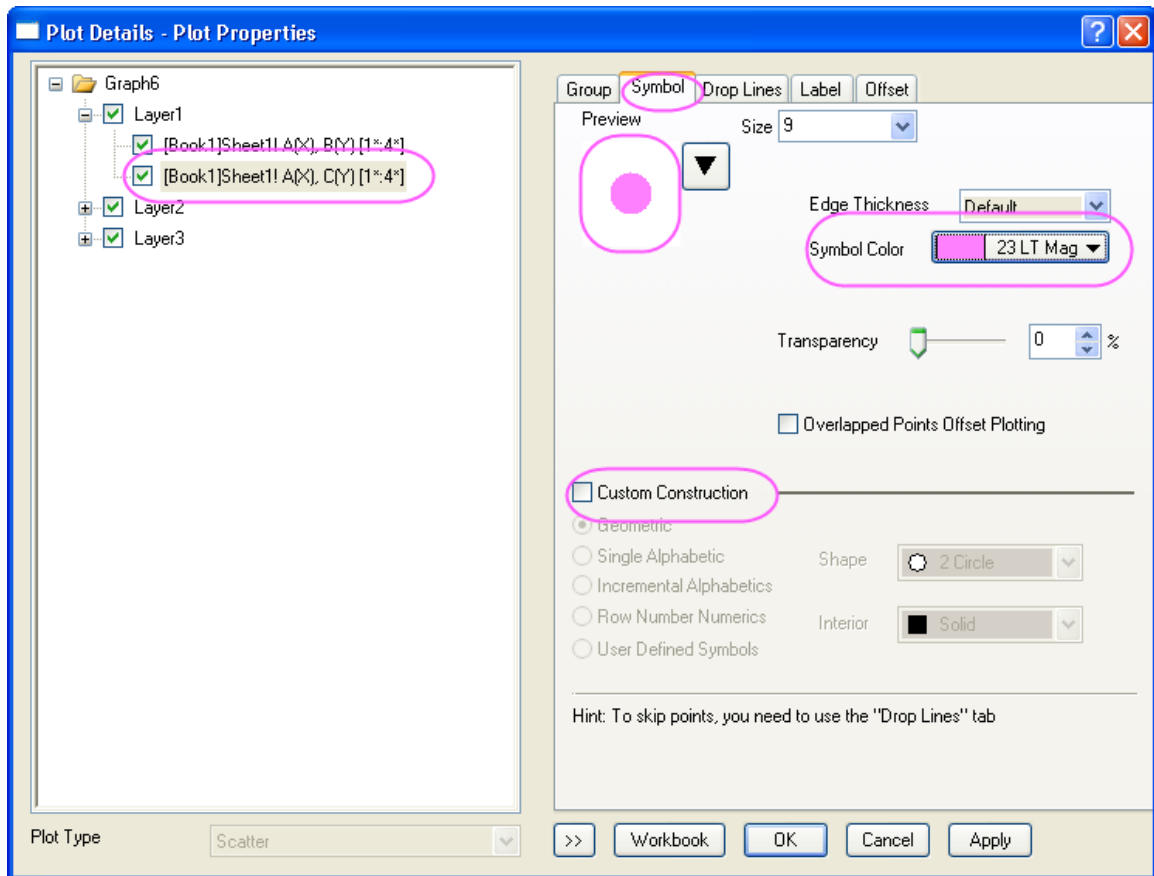

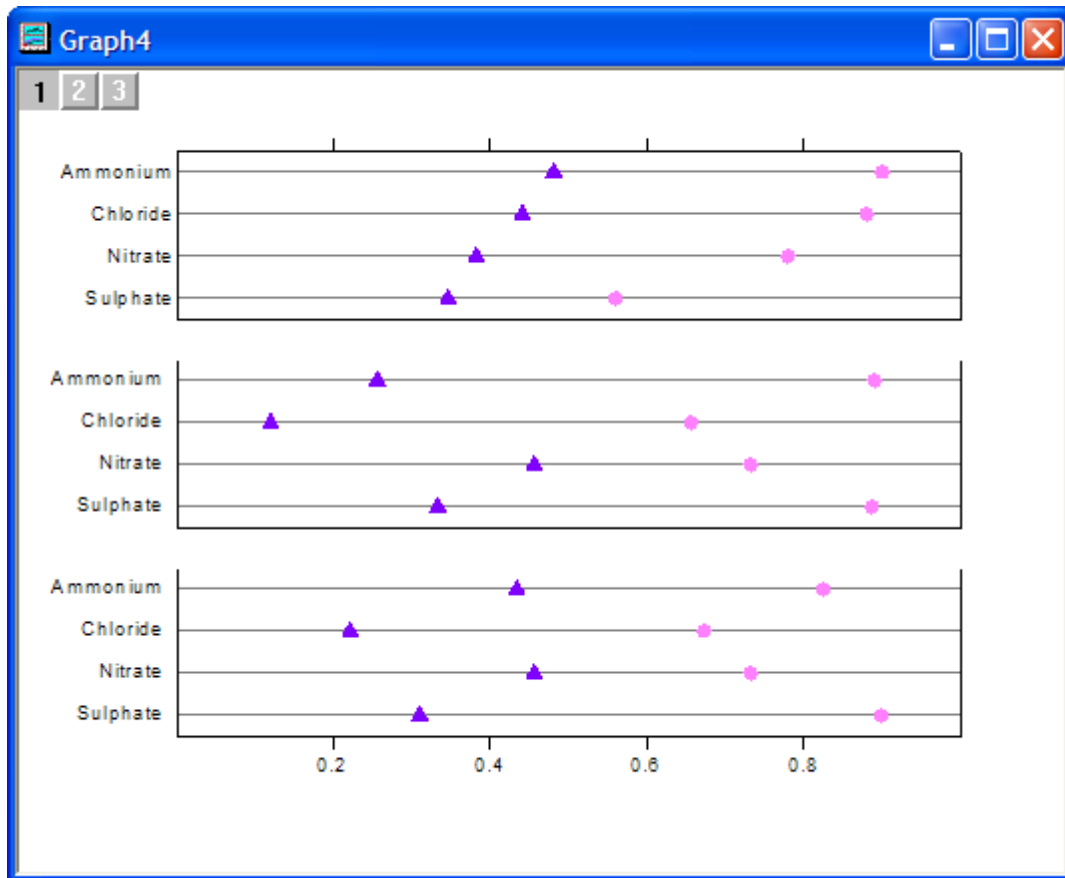

25. Repeat the previous step (step 24) for the Layer 2 and Layer 3. Click the **OK** button and the graph will appear as shown below:



26. Select  in the **Tools** toolbar to draw three rectangles on the graphs. For each rectangle:
1. Double-click on the rectangle to bring up the **Object Properties** dialog.
  2. In the **Fill** tab, set the desired **Fill Color** which will designate the color of the rectangle:

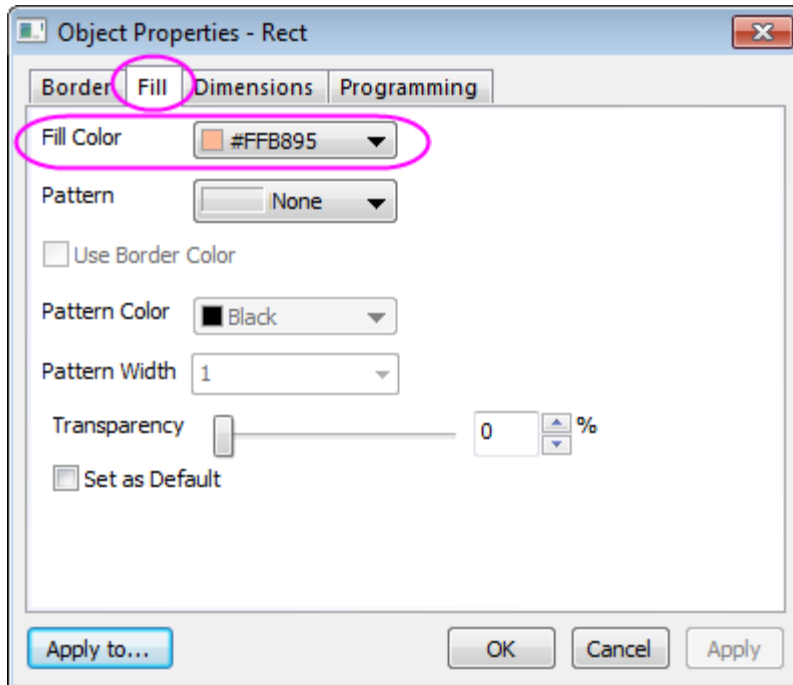

3. In the **Dimensions** tab, adjust the size and position of the rectangle:

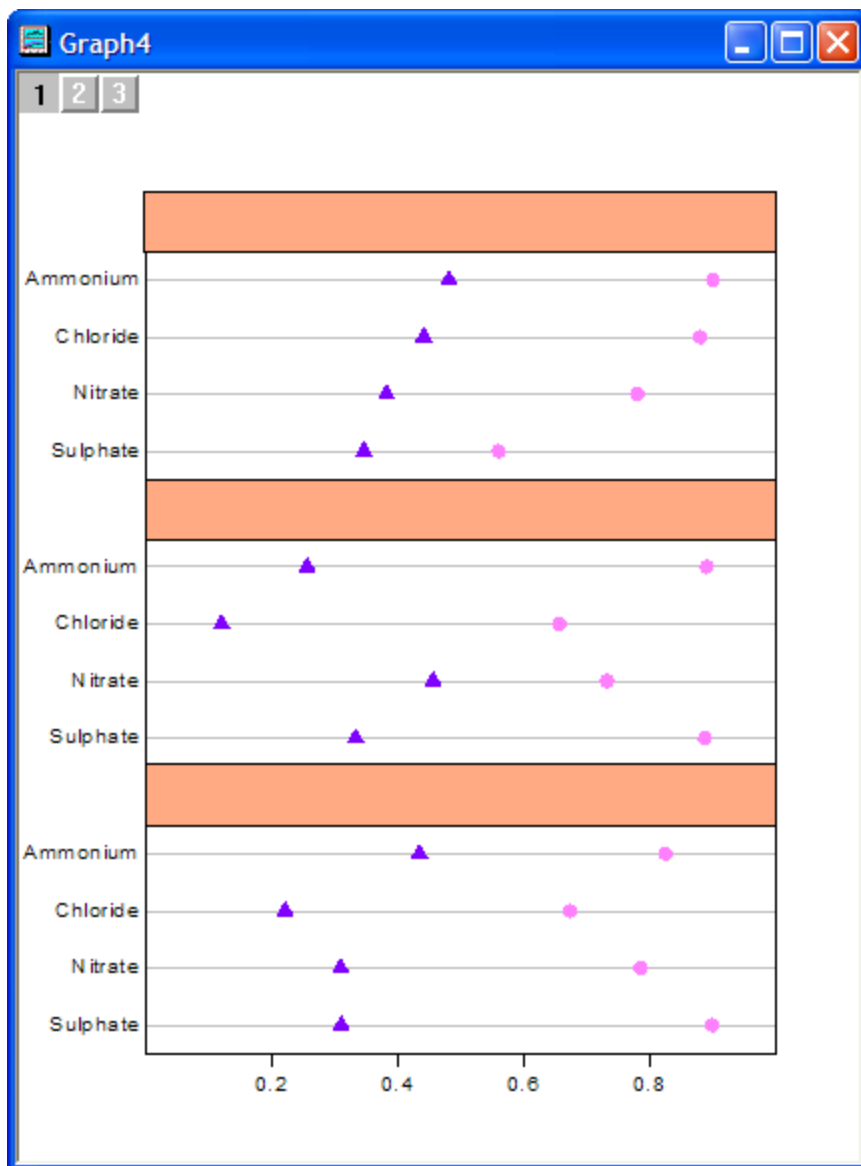

27. Select the Text Tool  in the Tools toolbar and click inside the rectangles to add the desired text.
28. To create a legend for the symbols, select **Graph: Legend: Data Plots** from the main menu. Move the legend to a suitable place, right-click on it and select **Properties**. Change the settings as below:

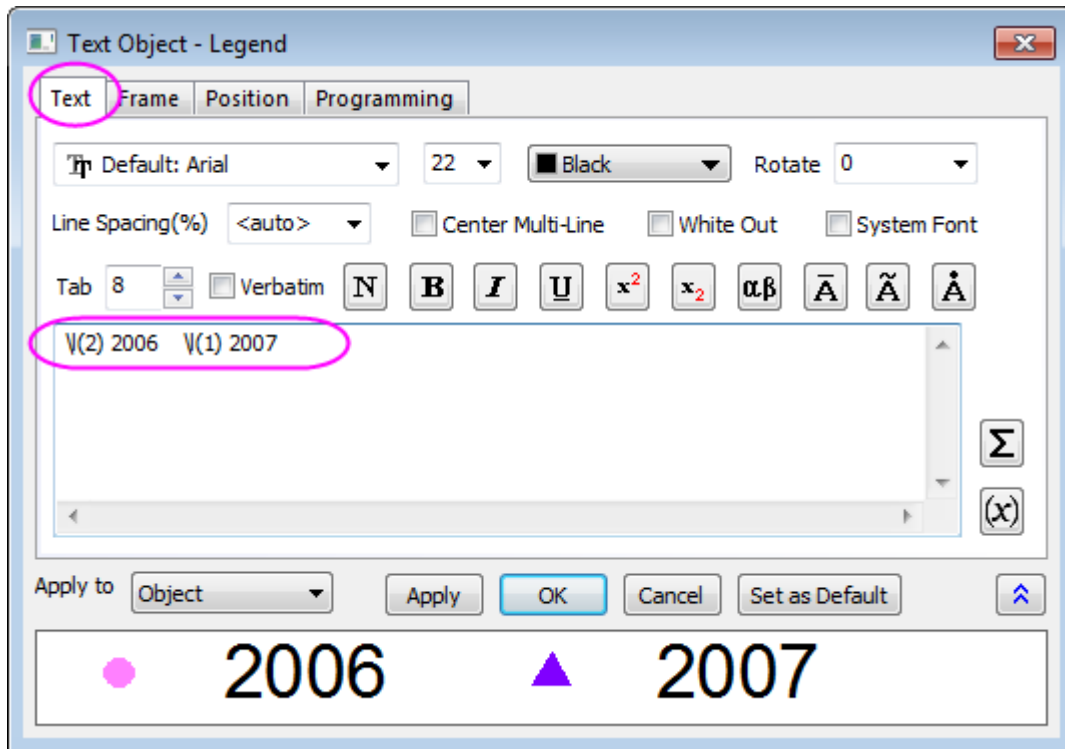

29. Activate the top X axis of Layer 1 to move it to a suitable place.

The complete multi-data dot chart graph should appear as shown below:

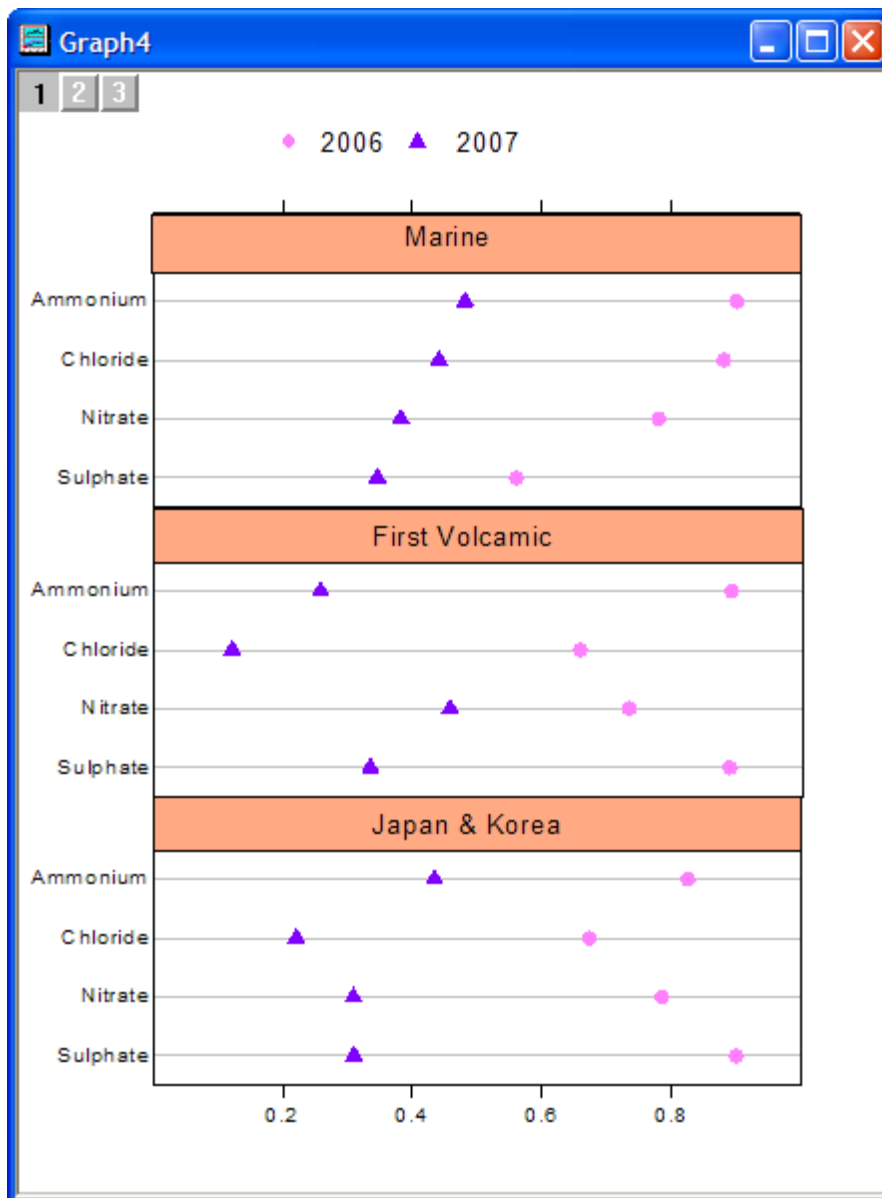

### 6.11.13 Add multiple fitted curves in a Histogram

#### 6.11.13.1 Summary

Origin allows you to fit the peaks from the result of frequency count. Also, fitted curves can be added into the new layer in the Histogram.

#### 6.11.13.2 What you will learn

- Plotting the Histogram
- Using Frequency Count to do statistics
- Using Multiple Peak Fit tool to find peaks and do fitting
- Adding new layers

## 6.11.13.3 Steps

Copy and paste [the sample data](#) into Origin and set the column as Y (Highlight the column and choose **Column: Set As: Y** from the Origin menu). Plot this data as a Histogram by clicking **Plot > Basic 2D: Histogram** from the menu.

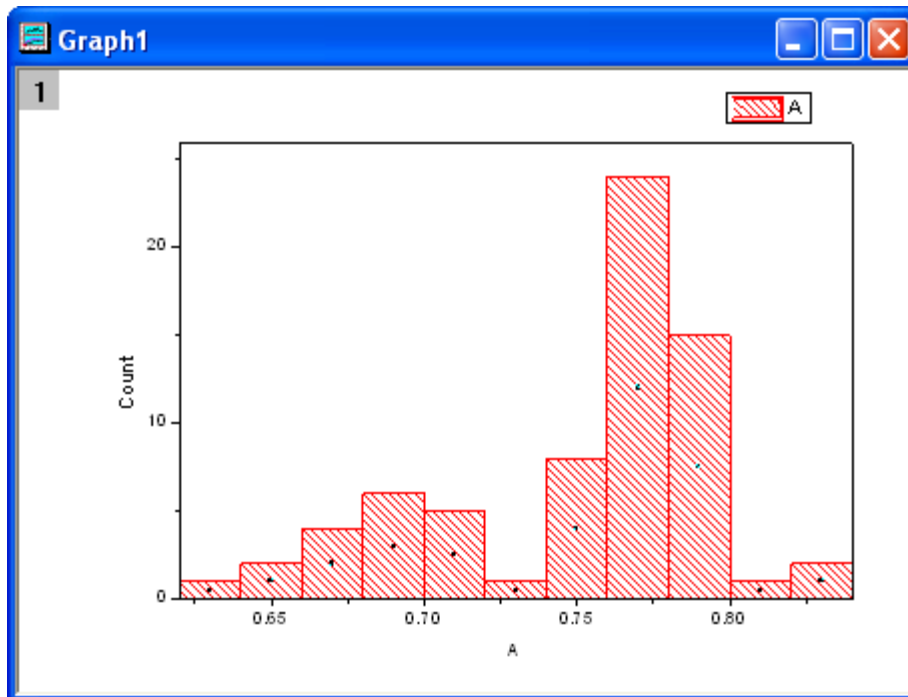

## 6.11.13.3.1 Frequency Count

1. Highlight the sample data, then open the **Frequency Count** dialog by selecting **Statistics: Descriptive Statistics: Frequency Count**.
2. Click **OK** to finish. A new result sheet will be generated.

## 6.11.13.3.2 Fit peaks

1. Select Col(Counts) in **FreqCounts1** sheet and then open the **Multiple Peak Fit** dialog from **Analysis: Peak and Baseline: Multiple Peak Fit**.
2. In the dialog that opens, choose Gaussian for **Peak Function** and click **OK**.
3. A graph window is generated automatically for you to pick peaks from the graph. Double click at the peak center to pick up a peak. Pick two peaks one by one this way.

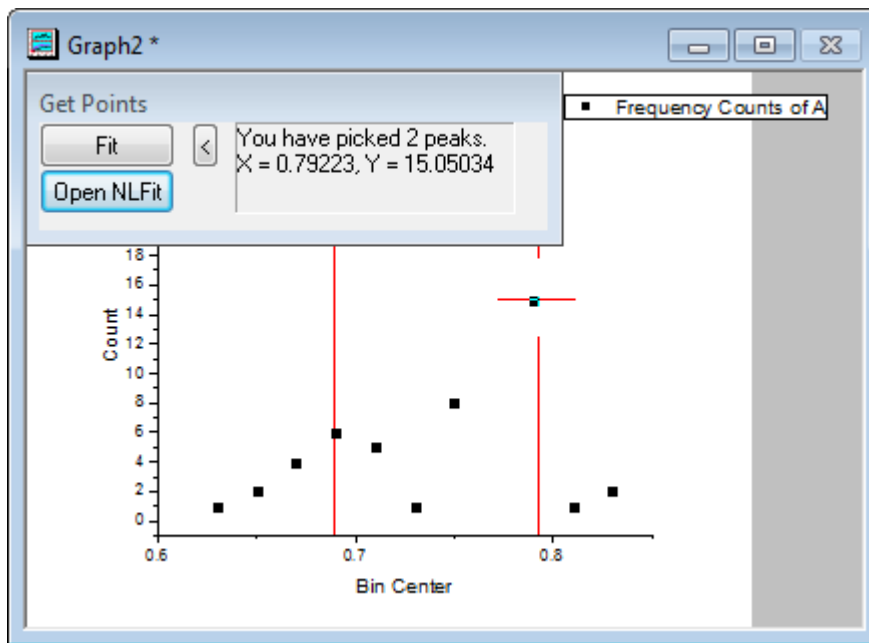

**Note:** you can single click at the peak center and then use Left and Right arrow keys on the keyboard to slightly adjust the center. Once done, press Enter key to confirm.

4. We need to fix the baseline at  $Y = 0$ . To do this, click **Open NLFit** button to open **Nonlinear Curve Fit** dialog. Go to Parameters tab. Set **Value** of parameter  $y_0$  to 0 and check **Fixed** checkbox. Click **Fit** button to perform the fitting.



If your baseline is complicated, or if you would like Origin to auto find peaks by specified method, please use **Peak Analyzer** (open from **Analysis: Peaks and Baseline: Peak Analyzer**). Note that **Peak Analyzer** provides powerful controls appropriate not just in two cases mentioned.

5. Two sheets **nlfiteaks1** and **nlfiteaksCurve1** are added to the source workbook containing the fitting report and the fitted curve data.

### 6.11.13.3.3 Add the fitted curves

1. Activate the Histogram graph and add a layer by selecting **Insert: New Layer(Axes): Right-Y** from the main menu.
2. Double click the **Layer2** icon to open the **Layer Content** dialog.
3. Hold **Ctrl** key to select col("Fit Peak 1") and col("Fit Peak 2") in sheet **nlfiteaksCurve1** in the left panel, click the triangle button next to **A** button and select Line from the fly-out menu, and then click **->** button to add it to the right panel.
4. Click OK. Two fitted curves had been added to the Histogram.
5. Double-click the graph to open the **Plot Details** dialog. Select **RightY** from the left panel, then open the **Link Axes Scales** tab in the right panel and select **Straight(1 to 1)** for both **X Axis Link** and **Y axis Link**. Click OK to close the dialog.



6. The fitted curves are added into the Histogram with the proper scale. The following is the result graph, with the right Y-axis removed.

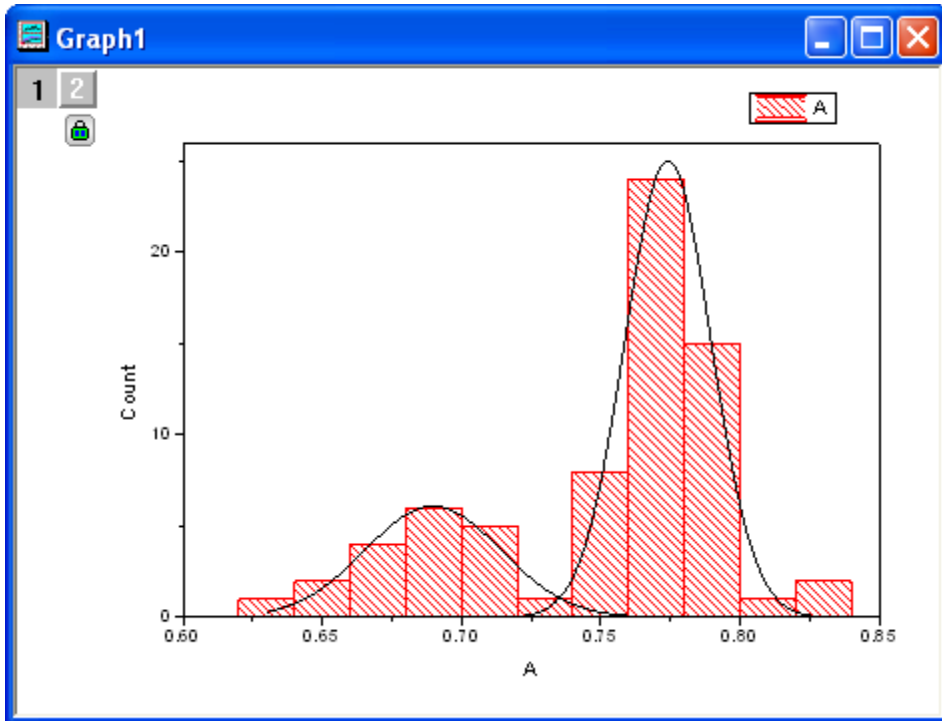

#### 6.11.13.3.4 Sample Data

0.631
0.642
0.652
0.662
0.669
0.676
0.677
0.69

0.691
0.696
0.697
0.699
0.699
0.7
0.7
0.708
0.712
0.718
0.731
0.744
0.749
0.751
0.752
0.753
0.758
0.758

0.759
0.761
0.761
0.763
0.763
0.763
0.765
0.767
0.768
0.768
0.769
0.769
0.77
0.771
0.771
0.772
0.774
0.775

0.775
0.776
0.776
0.776
0.777
0.778
0.779
0.78
0.78
0.781
0.784
0.784
0.785
0.785
0.789
0.789
0.791
0.794

0.795
0.796
0.798
0.798
0.803
0.82
0.831

#### 6.11.14 Weibull Probability Plot

##### 6.11.14.1 Summary

The probability plot shows a graph with observed cumulative percentage on X axis and expected cumulative percentage on Y axis. The Weibull probability plot is used to test whether or not a dataset follows Weibull distribution. And its X scale type and Y scale type are Log10 and Double Log Reciprocal respectively. If all the scatter points are close to the reference line, we can say that the dataset follows the Weibull distribution.

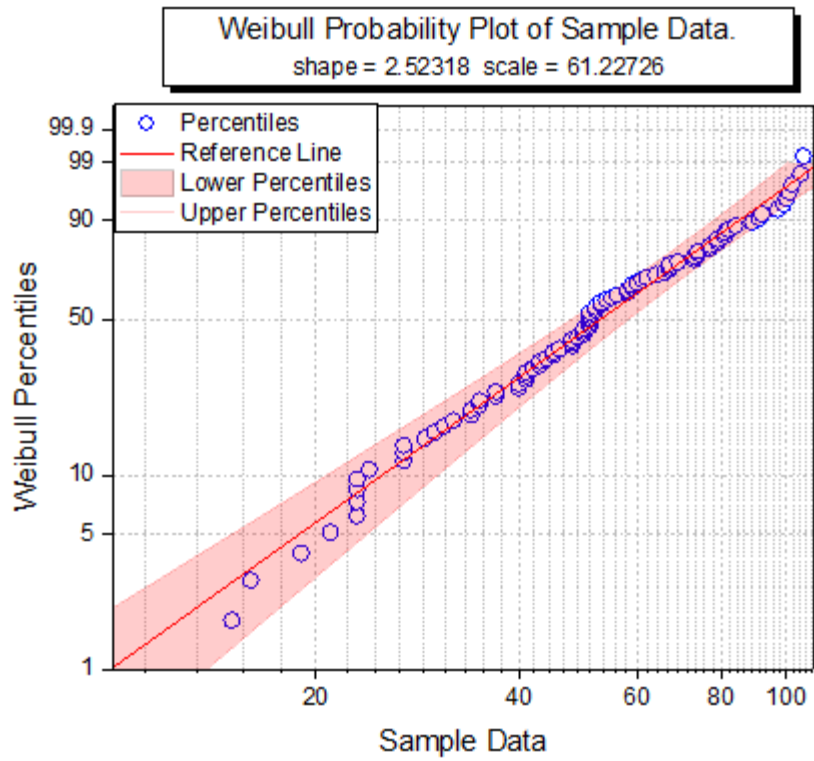

Minimum Origin Version Required: Origin 2016 SR0

#### 6.11.14.2 What you will learn

- How to create a Weibull probability plot
- How to add the fill area between the percentiles lines

#### 6.11.14.3 Steps

You can refer to this graph in Learning Center. (Select **Help: Learning Center** menu or press **F11** key , and then open **Graph Sample: Statistical Graphs**)

1. Download the data from [here](#). Highlight column A and right-click to select **Set As: Y** from the context menu.

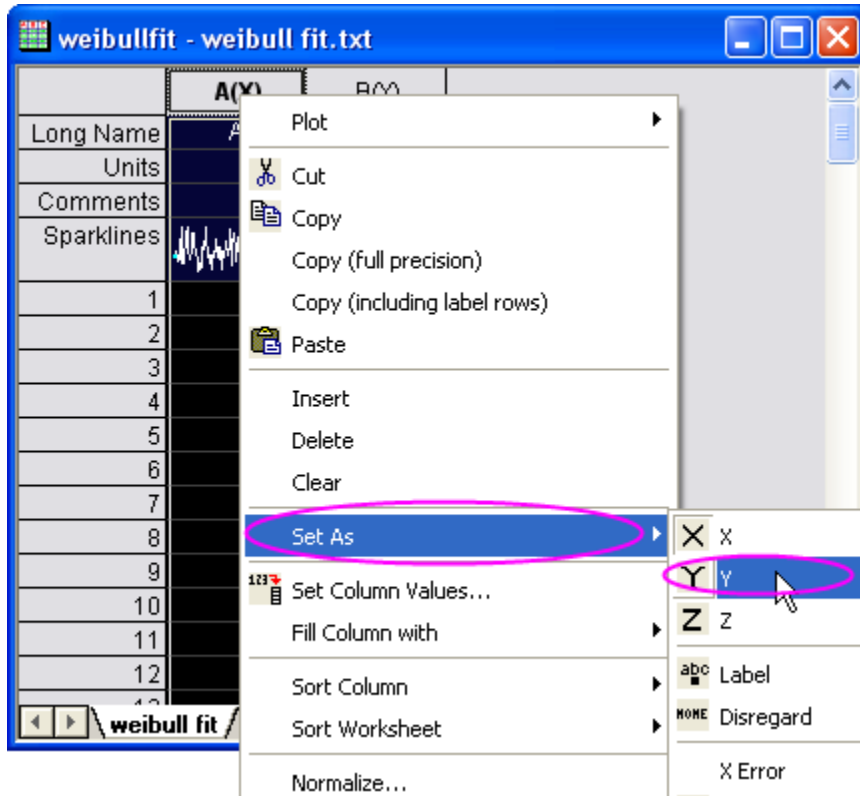

2. Keep this column highlighted, select **Plot > Statistical : Probability Plot** from the Origin main menu to open the **plot\_prob** dialog. In this dialog, change **Distribution** to **Weibull** and then click the **OK** button

to create a Weibull probability plot with column A.

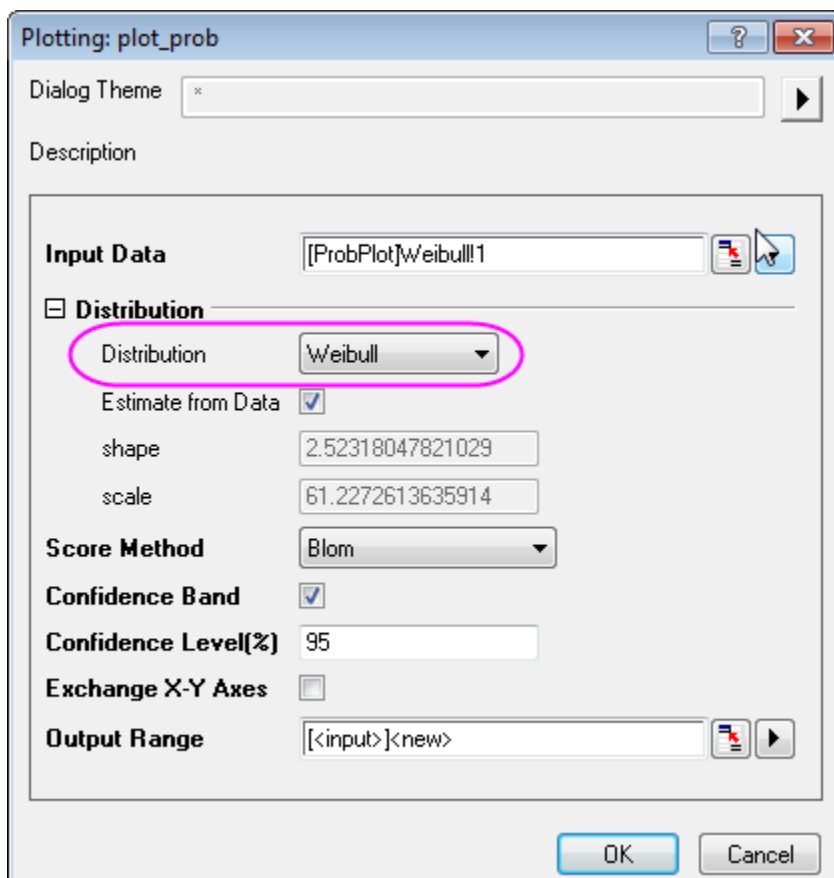

3. Double-click on the Lower Percentiles line to open the **Plot Details** dialog. Go to the **Line** tab, set **Color** to **Red**, **Transparency** to **80%**, then check **Fill Area Under Curve** check box and select **Fill to next**



**data plot - One Color** in the below drop-down list.

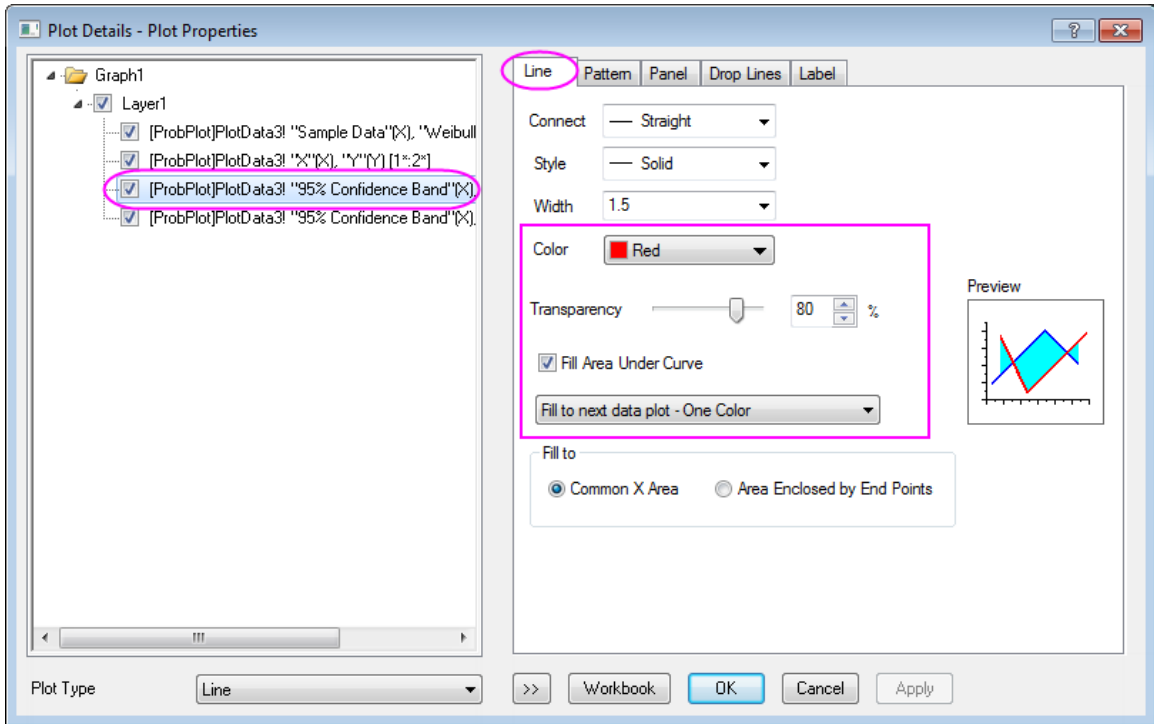

4. Go to **Pattern** tab, set **Fill Color** to **Red**. And make sure the **Follow line transparency** is checked.

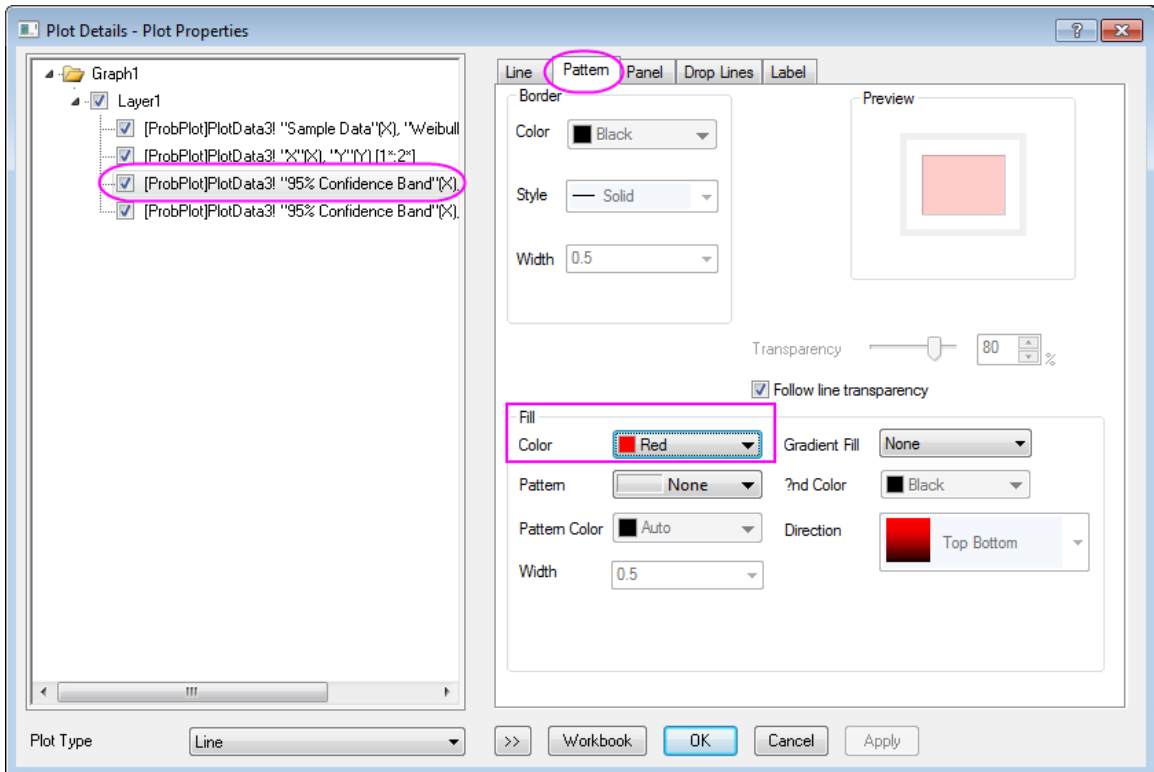

5. Go to the **Line** tab of Upper Percentiles line set **Color** to **Red**, **Transparency** to **80%**. Click **OK** to apply the setting and close the dialog.

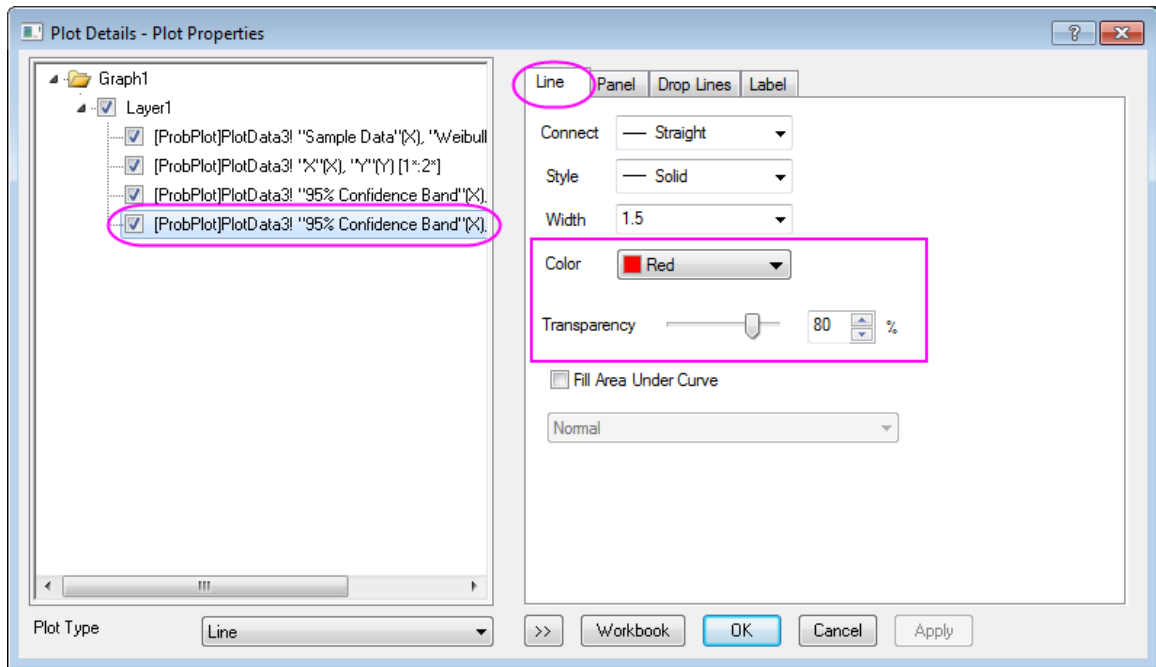

6. Double click on the X axis on the graph to open the **Axis** dialog. Go to **Scale** tab for **Horizontal** axis, change scale from **10** to **100**, and set the increment value of **Major Ticks** to **20**.

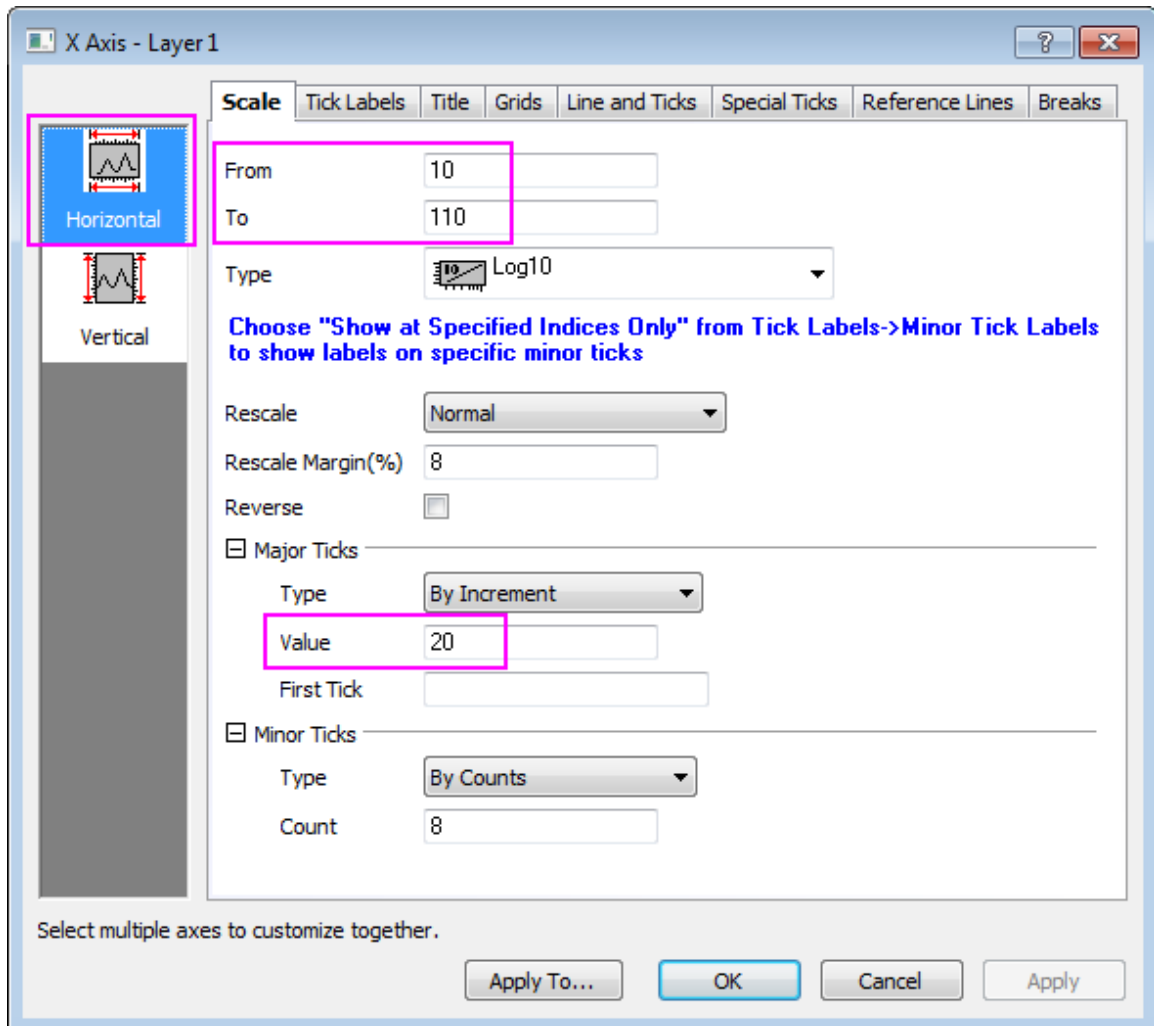

7. Go to **Scale** tab for **Vertical** axis, change scale from **1** to **99.99**. Click **OK** to apply the setting and close the dialog.

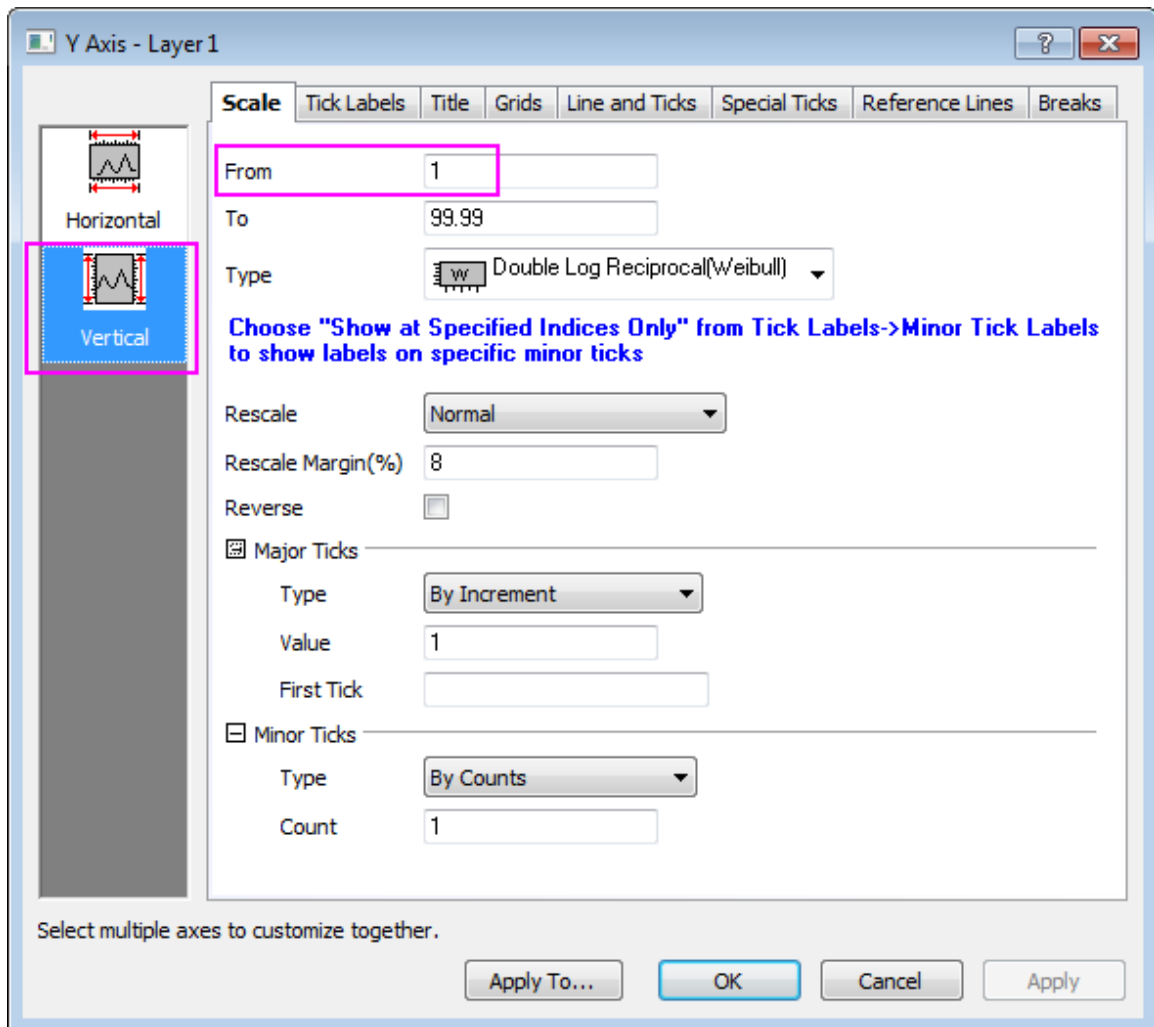

The final graph should look like this:

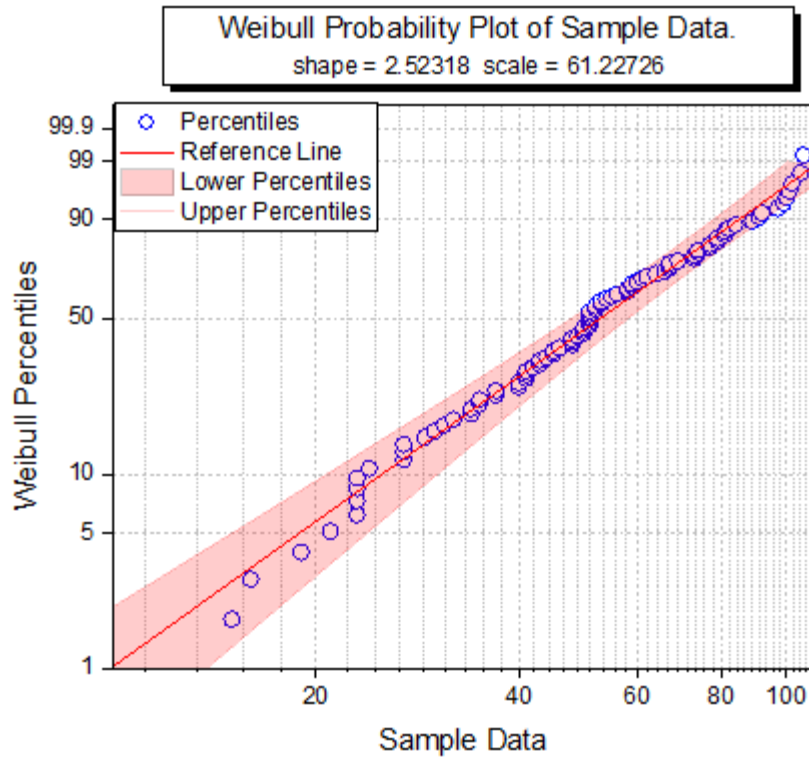

### 6.11.15 Q-Q Plot

#### 6.11.15.1 Summary

The Q-Q plot is a graphic method that tests whether or not a dataset follows a given distribution. The Q-Q plot has independent values on the X axis, and dependent values on the Y axis. If all the plotted points are close to the reference line, then we conclude that the dataset follows the given distribution.

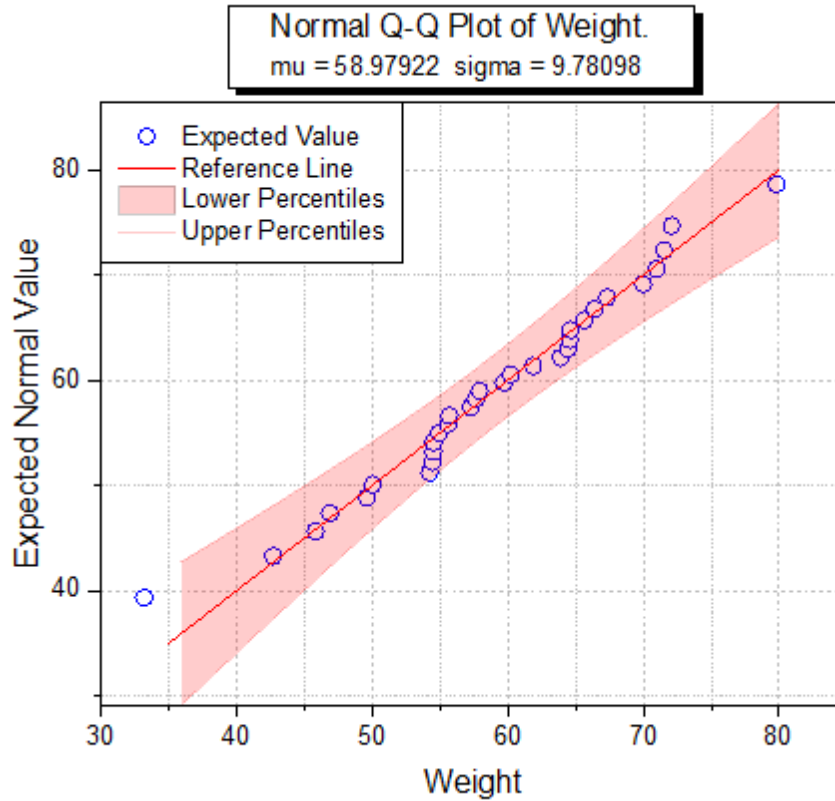

Minimum Origin Version Required: Origin 2016 SR0

#### 6.11.15.2 What You Will Learn

- How to create a Q-Q plot
- How to mask a suspected outlier in the source data and recalculate the Q-Q plot

#### 6.11.15.3 Create a Q-Q Plot

You can refer to this graph in Learning Center. (Select **Help: Learning Center** menu or press **F11** key , and then open **Graph Sample: Statistical Graphs**)

1. Click the  button to import the **Q-Q plot.dat** file under *<Origin EXE folder>\Samples\Graphing\* path.
2. In the **QQplot** workbook, activate the **Q-Q plot** worksheet, highlight column B, right click, and from the context menu, select **Plot > Statistical: Q-Q Plot....** In the **Plotting:plot\_prob** dialog, make sure that

the **Score Method** drop-down is set to **Benard**. Click **OK**.

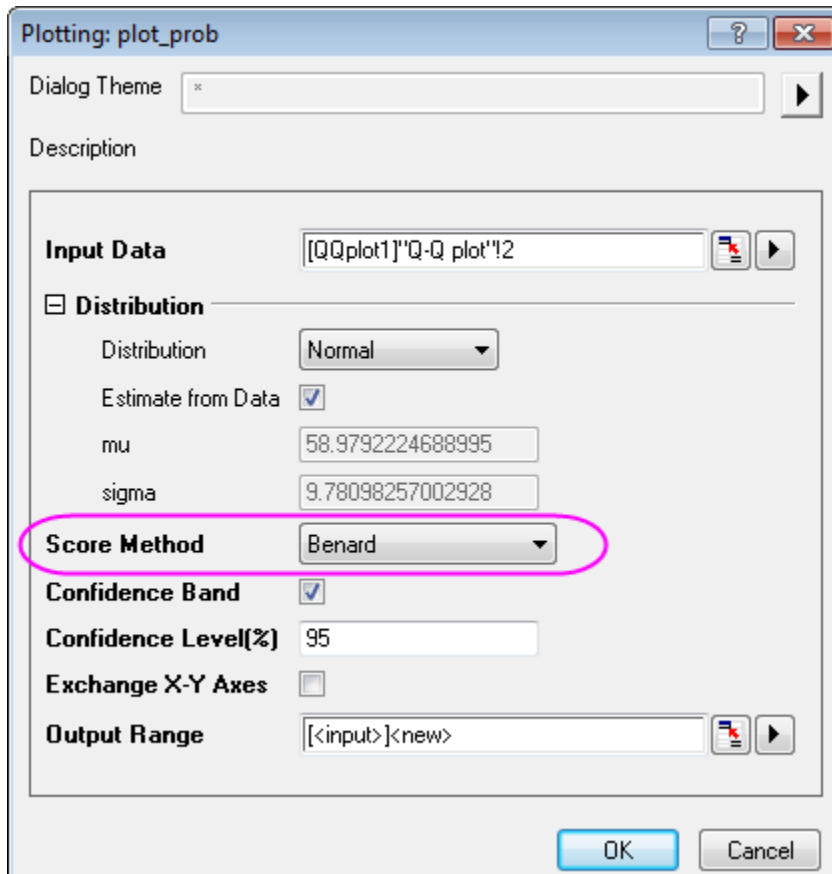

The screenshot shows the 'Plotting: plot\_prob' dialog box. The 'Input Data' field contains '[QQplot1]'Q-Q plot'!2. The 'Distribution' is set to 'Normal'. The 'Estimate from Data' checkbox is checked. The 'mu' field contains 58.9792224688995 and the 'sigma' field contains 9.78098257002928. The 'Score Method' dropdown is highlighted with a pink oval and set to 'Benard'. The 'Confidence Band' checkbox is checked, and the 'Confidence Level(%)' is set to 95. The 'Exchange X-Y Axes' checkbox is unchecked. The 'Output Range' field contains '<input><new>'. The 'OK' and 'Cancel' buttons are at the bottom.

3. Double-click on the Lower Percentiles line to open the **Plot Details** dialog. Go to the **Line** tab, set **Color** to **Red**, **Transparency** to **80%**, then check **Fill Area Under Curve** check box and select **Fill to next**

**data plot - One Color** in the below drop-down list.

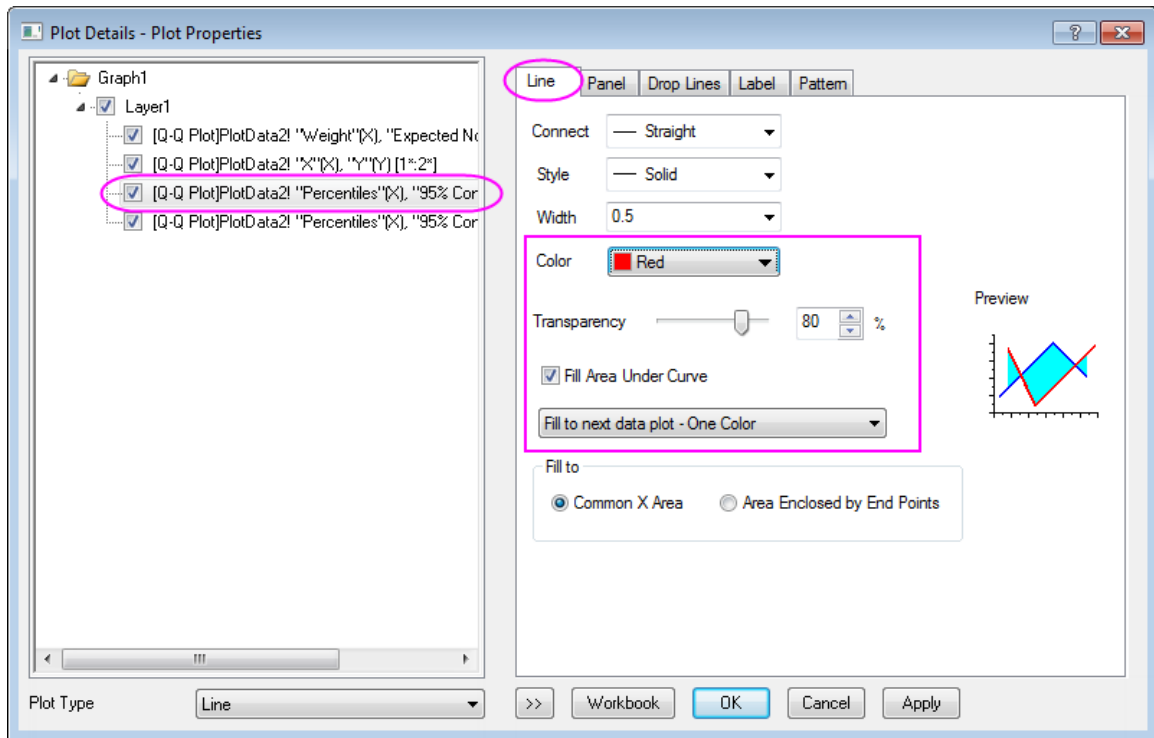

4. Go to **Pattern** tab, set **Fill Color** to **Red**. And make sure the **Follow line transparency** is checked.

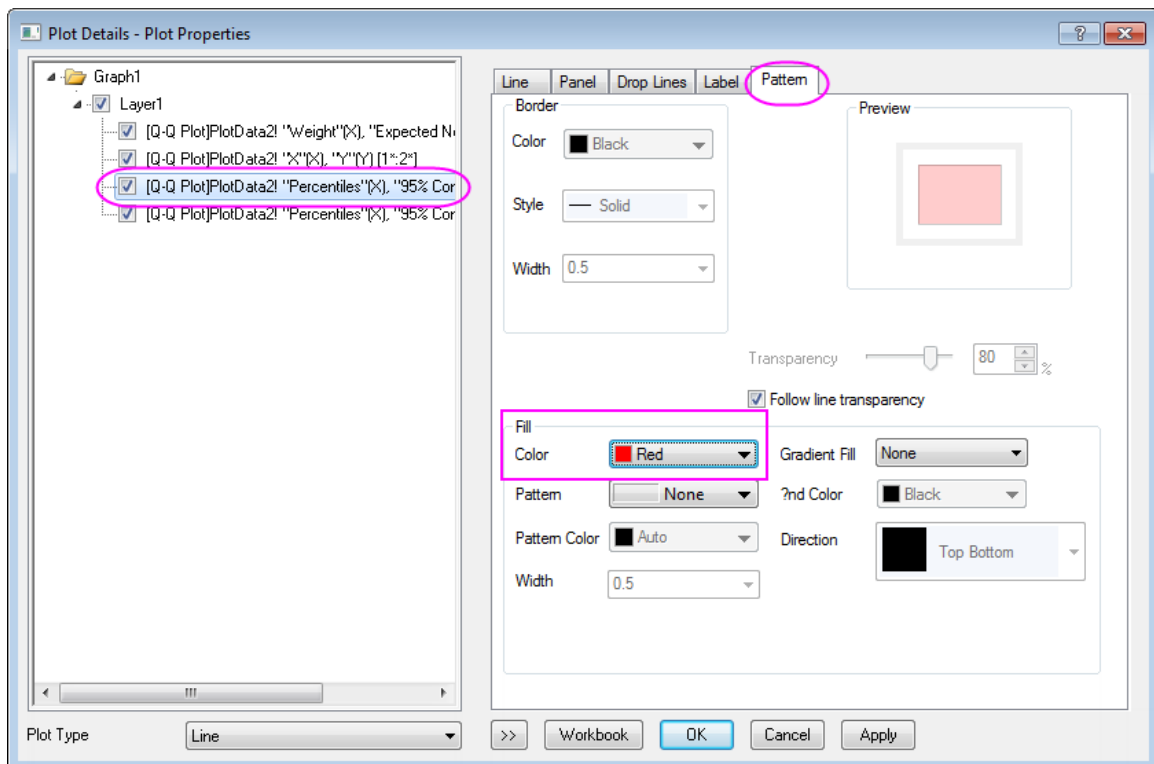



5. Go to the **Line** tab of Upper Percentiles line set **Color** to **Red**, **Transparency** to **80%**. Click **OK** to apply the setting and close the dialog.

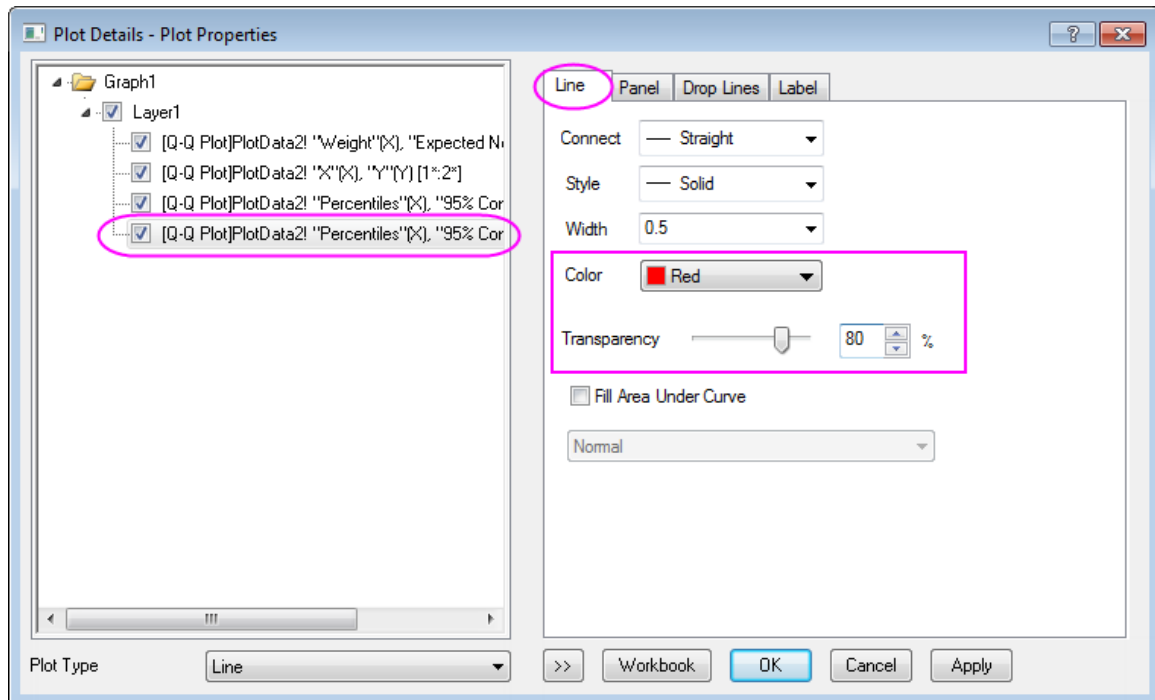

Your graph should look as shown below.

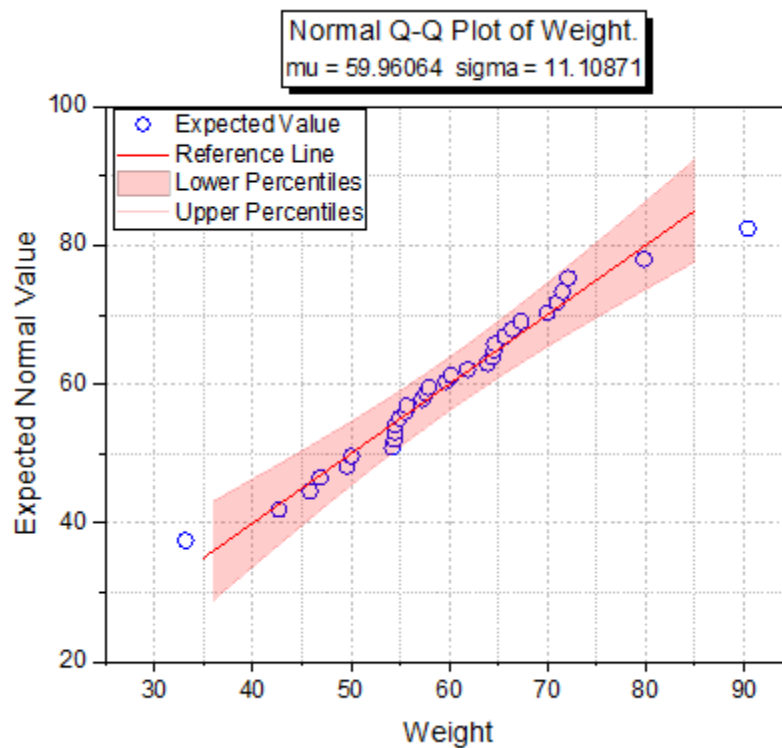

6.11.15.4 Mask a Suspected Outlier

1. Click on the green lock icon to make sure the **Recalculate Mode** is **Auto**.

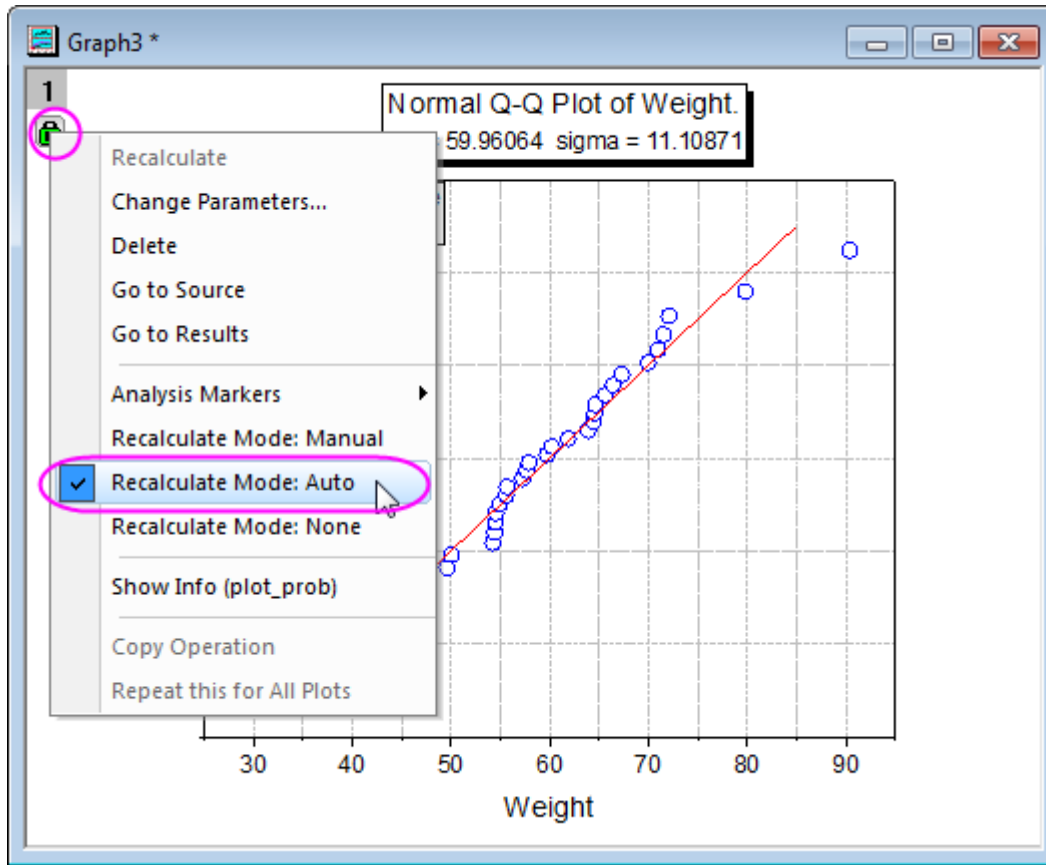

2. Click on the **Data Reader** tool and click to select the suspected data point in the **Q-Q Plot**.

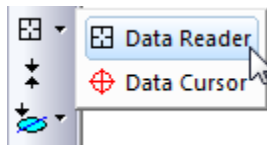

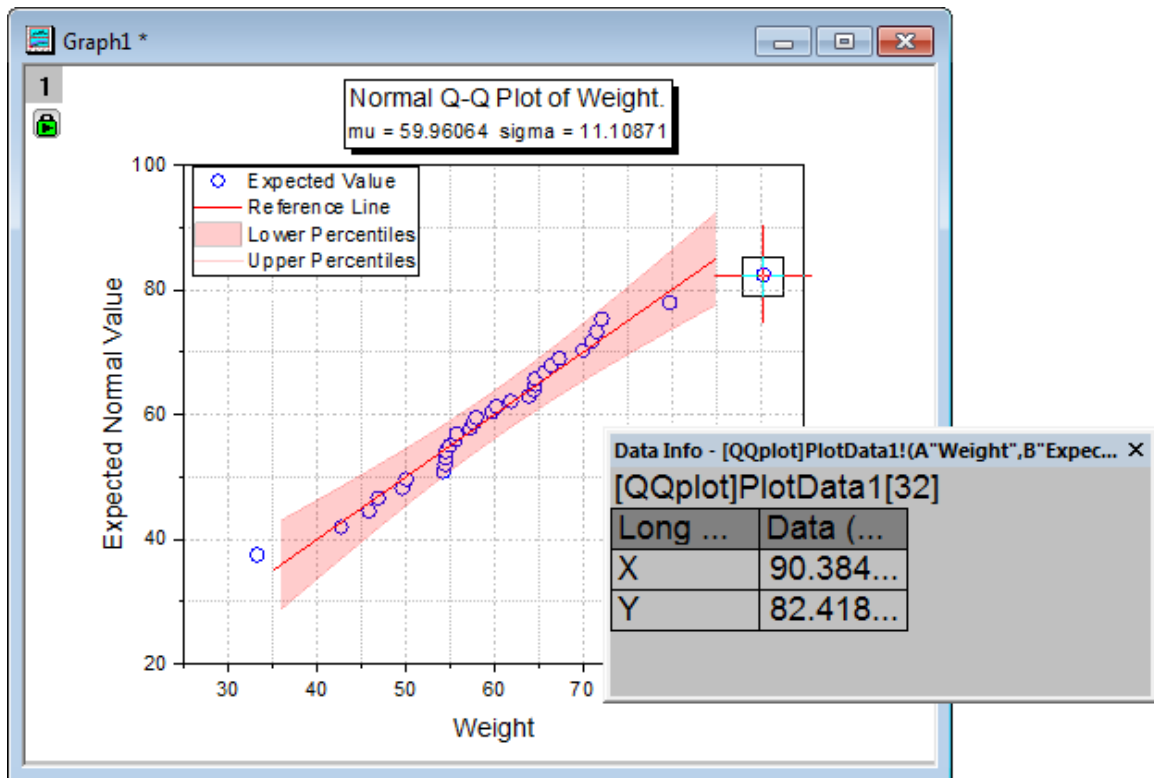

The **Data Info** window shows the value of the outlier point.

3. Activate the **Q-Q plot** worksheet and highlight column B.

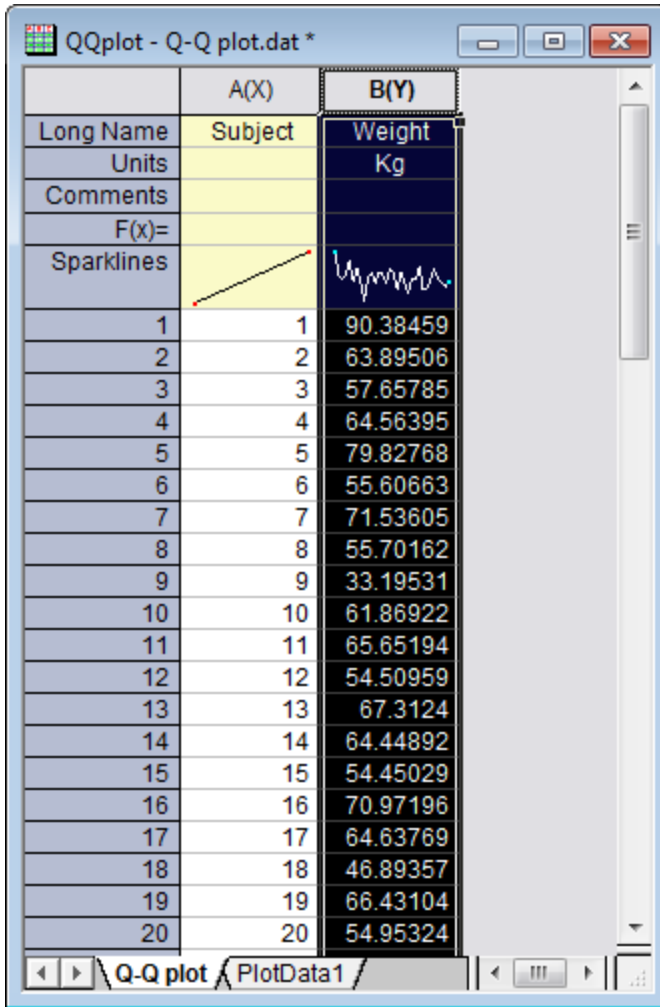

4. From the Menu Bar, click on **Window:Command Window** and at the prompt, enter the script shown below.

```
colmask cond:=eq val:=x;
```

The outlier point will be shown in red in the **Q-Q plot** worksheet, and it will not be included in the graph.

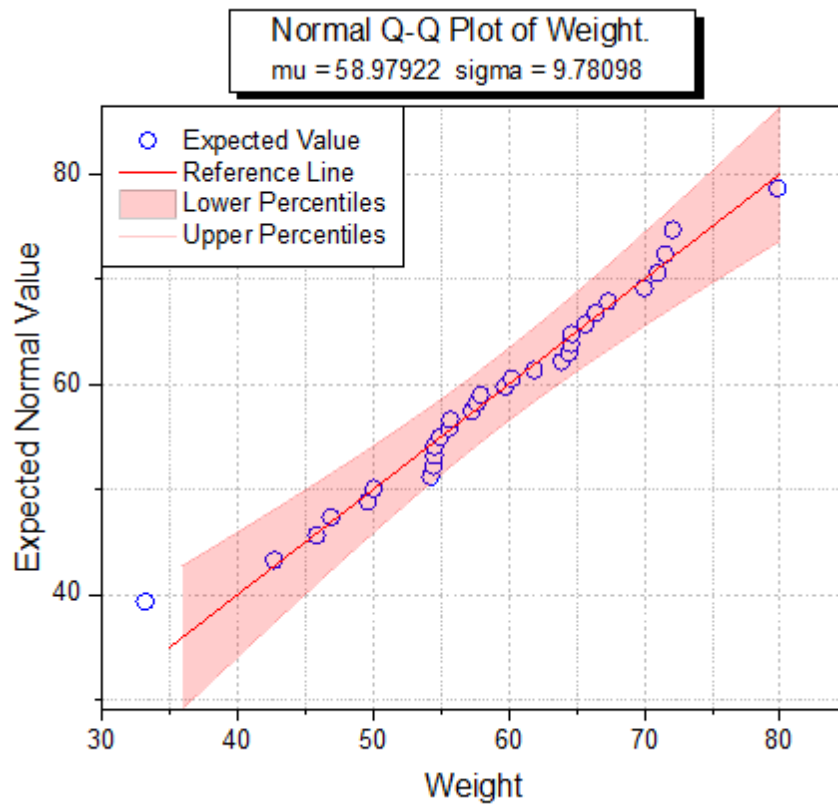
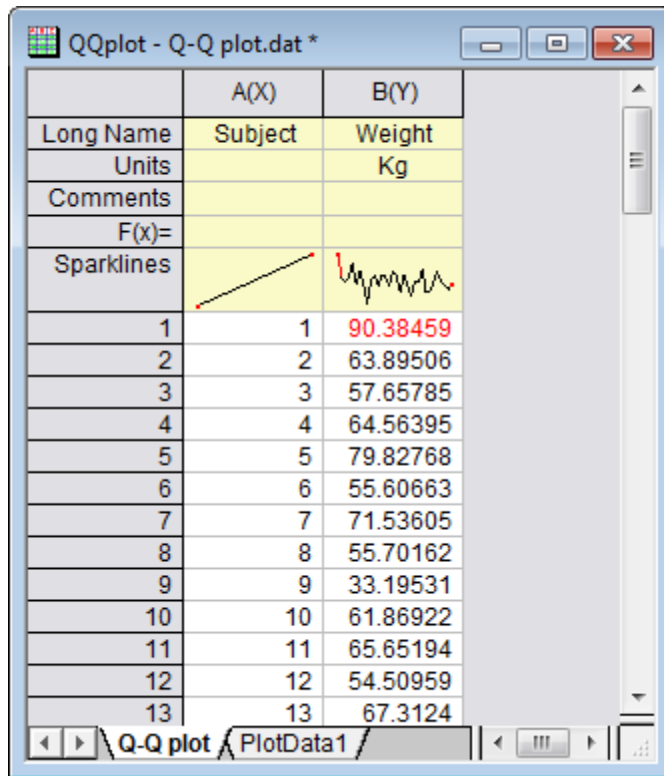

## 6.11.16 Scatter Matrix

### 6.11.16.1 Summary

A scatter matrix consists of several pair-wise scatter plots of variables presented in a matrix format. It can be used to determine whether the variables are correlated and whether the correlation is positive or negative. This tutorial will show you how to create a Scatter Matrix plot.

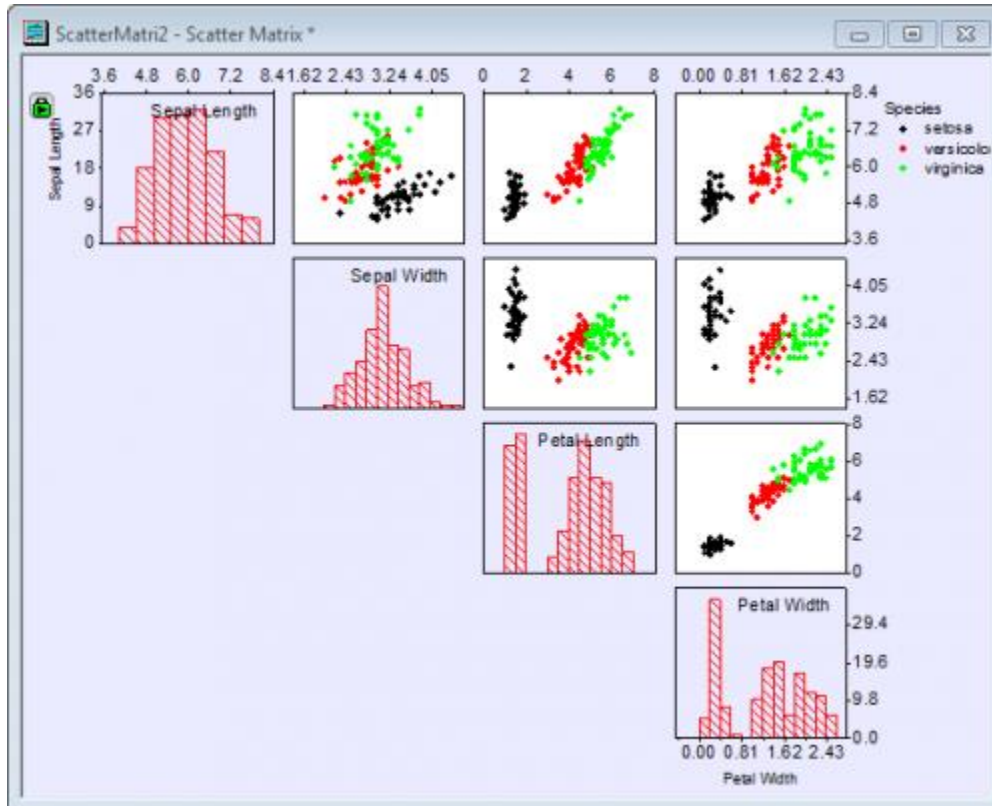

Minimum Origin Version Required: Origin 2016 SR0

### 6.11.16.2 What you will learn

- How to create a Scatter Matrix plot with a histogram
- How to customize Scatter Matrix plot
- How to set a grouping range for showing the color index
- How to specify to hide scatter plots on the bottom/top of the diagonal

### 6.11.16.3 Steps

#### 6.11.16.3.1 Creating Scatter Matrix plot

1. Start with an empty worksheet, select **Data: Import from File: Single ASCII...** to open the Import Single ASCII dialog, browse to the `\Samples\Statistics` subfolder of the Origin program folder, and import the file *Fisher's Iris Data.dat*.

- Highlight columns (A) to (D) but not col(E), and select **Plot > Statistical : Scatter Matrix** from the main menu.
- In the dialog, select **Histogram** from the **Show in Diagonal Cells** drop-down list, and select **Alternate** from **Show Tick and Label** drop-down list.

Plotting: plot\_matrix

Dialog Theme <Last used>

Description

**Input**

Input [Fisher'sIrisD]'Fisher's Iris Data'11:4

Grouping Range <optional>

**Matrix Profile**

Matrix Display Square

Show in Diagonal Cells Histogram

Variables in Diagonal Cells

Show Tick and Label Alternate

Gap(in % of Page Dimension) 0

**Options**

Confidence Ellipse

Confidence Level in % 95

Linear Fit

**Additional Statistics**

Pearson's r

Adj. R-Square

**Exclude Missing Value Listwise**

**Graph Templates**

Scatter ScatterMatrix   Auto

Box BoxMatrix   Auto

Histogram HistMatrix   Auto

**Output Results** [<input>]<new>

OK Cancel

- Click **OK** to close the dialog. The **PlotData1** sheet for the scatter matrix plot is generated in the same workbook as the original data. It contains the data for the different graphs in the scatter matrix and can be accessed by clicking on the second tab labelled **PlotData1** at the bottom of the workbook. The graph

should appear as below:

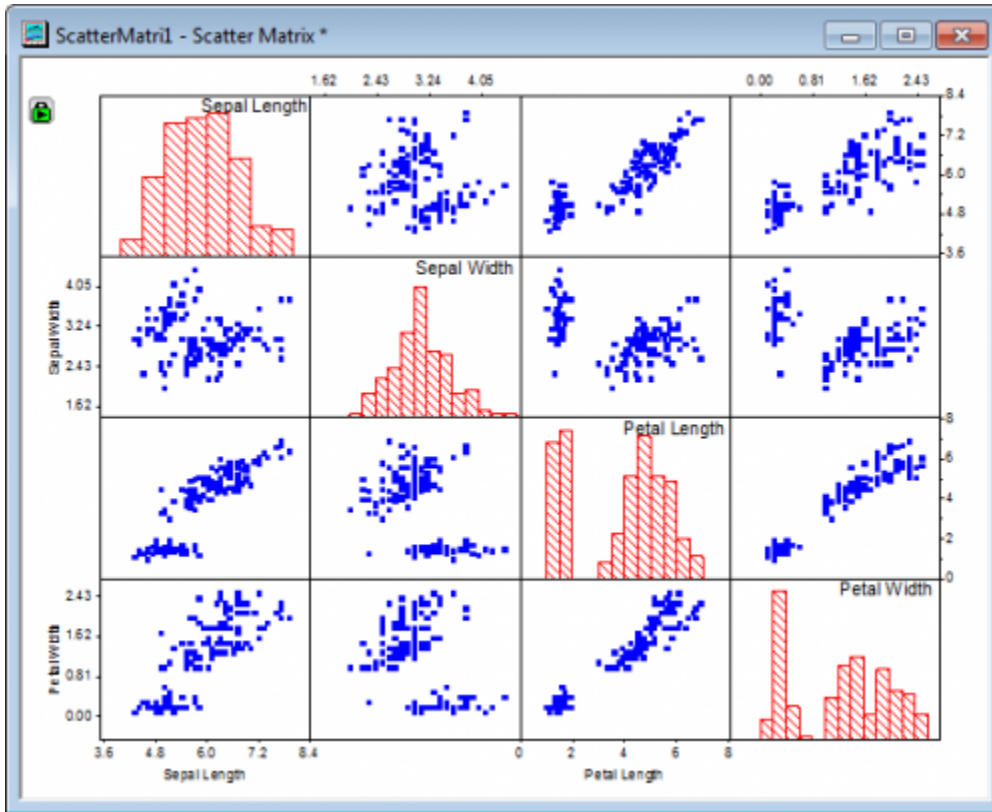

You have the option of performing a linear fit on each scatter plot and calculating adjusted R-squared and, additionally, Pearson's correlation coefficient (Pearson's  $r$ ). Beginning with Origin 2019, these statistics are outputted to a sheet in the active book and named as **ScatterMatrixStatsN**.

Label each plot in the scatter matrix with Adj. R-Square and/or Pearson's  $r$  values by checking the boxes under **Additional Statistics**.



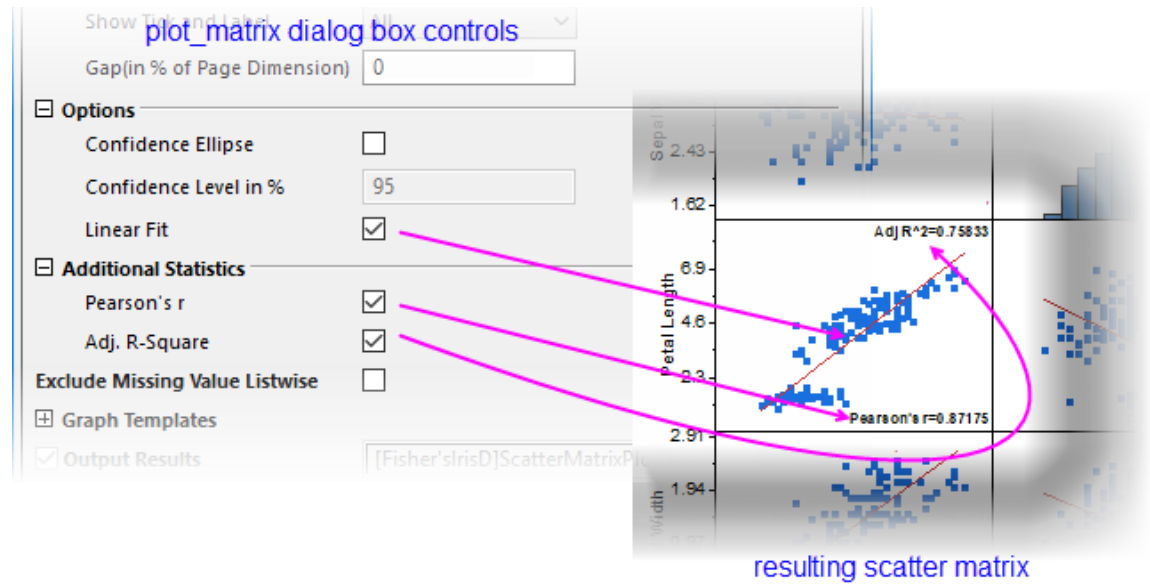

### 6.11.16.3.2 Customizing Scatter Matrix plot

There are multiple layers in the Scatter Matrix graph. This section will explain how to customize the background color, the type and color of the data plots and the axis tick labels of the scatter matrix. Starting with Origin 2016, by default, [if you change the plot style or axis setting of one layer, all other layers will follow](#) (for independent editing, see the tip at the end of this section).

1. Double click on the scatter data to open the **Plot Details** dialog. To change the symbol color click on the **Symbol Color** drop-down menu and select a color from the **Individual Color** option. Specify the type and color of the symbol as shown in the following image, and click **OK**.

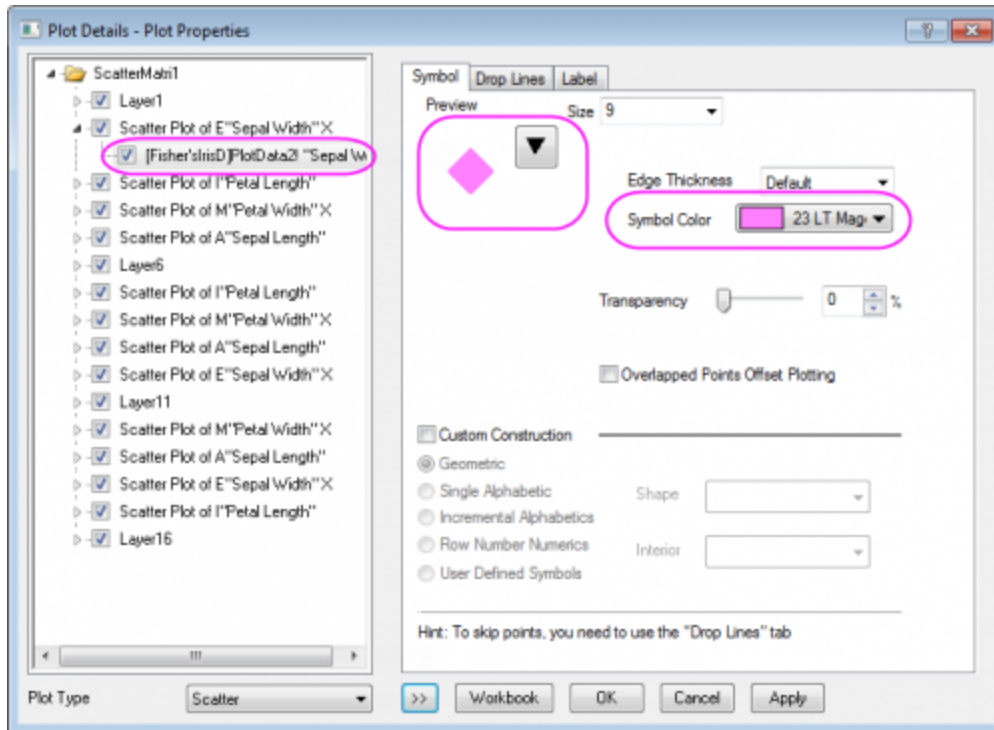

This change will be applied to all scatter data plots in this graph.

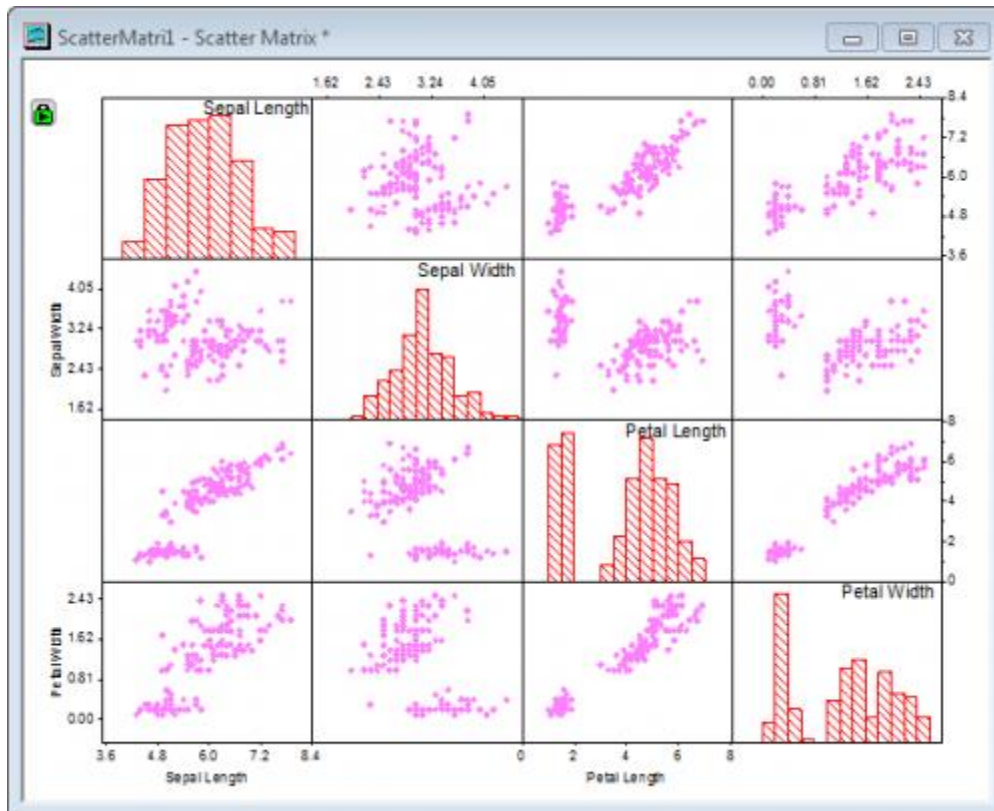

- To change the background color of the entire window, select **Format: Page** to open the **Plot Details** dialog. This dialog can also be accessed by double-clicking inside the Scatter Matrix window. In the

**Display** tab, click on the **Color** drop-down and click on an empty color well beneath **Custom**. This opens the **Colors** dialog box where you can define custom colors.

3. In the **Colors** dialog, specify the color as *Red=235, Green=235, Blue=255* and click **OK**.

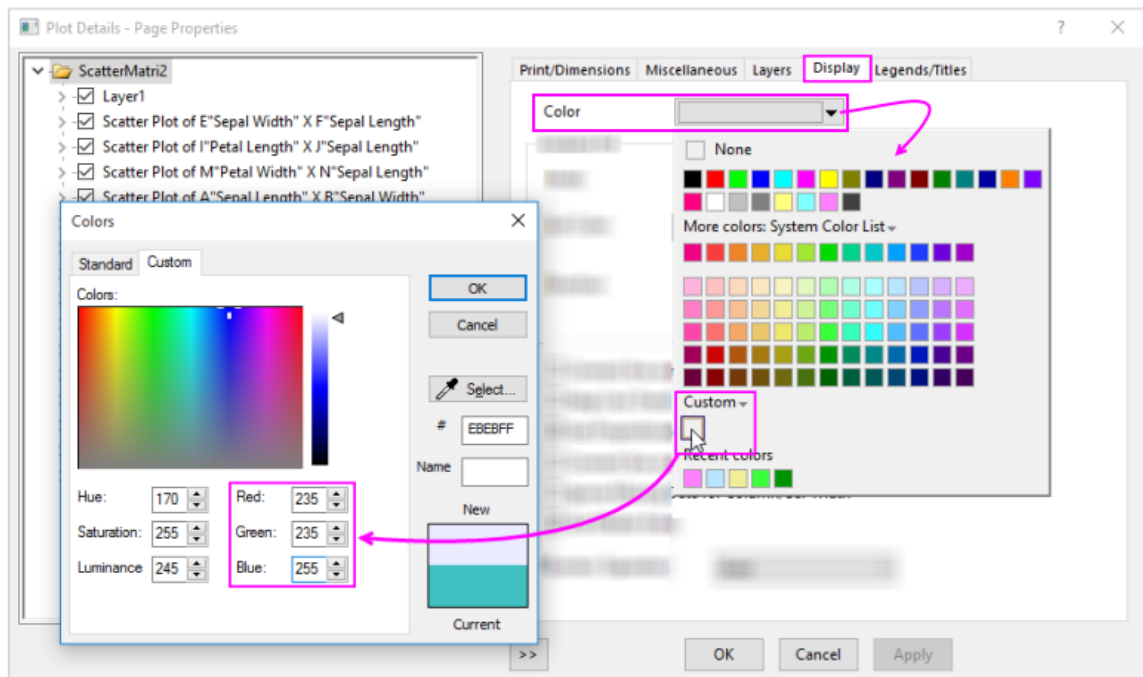

4. To change the background color of the scatter plot layers without changing the background color of the histograms or the rest of the graph, double-click on a scatter plot to open the Plot Details dialog. Click the **Background** tab, and set **Color** to **White**.

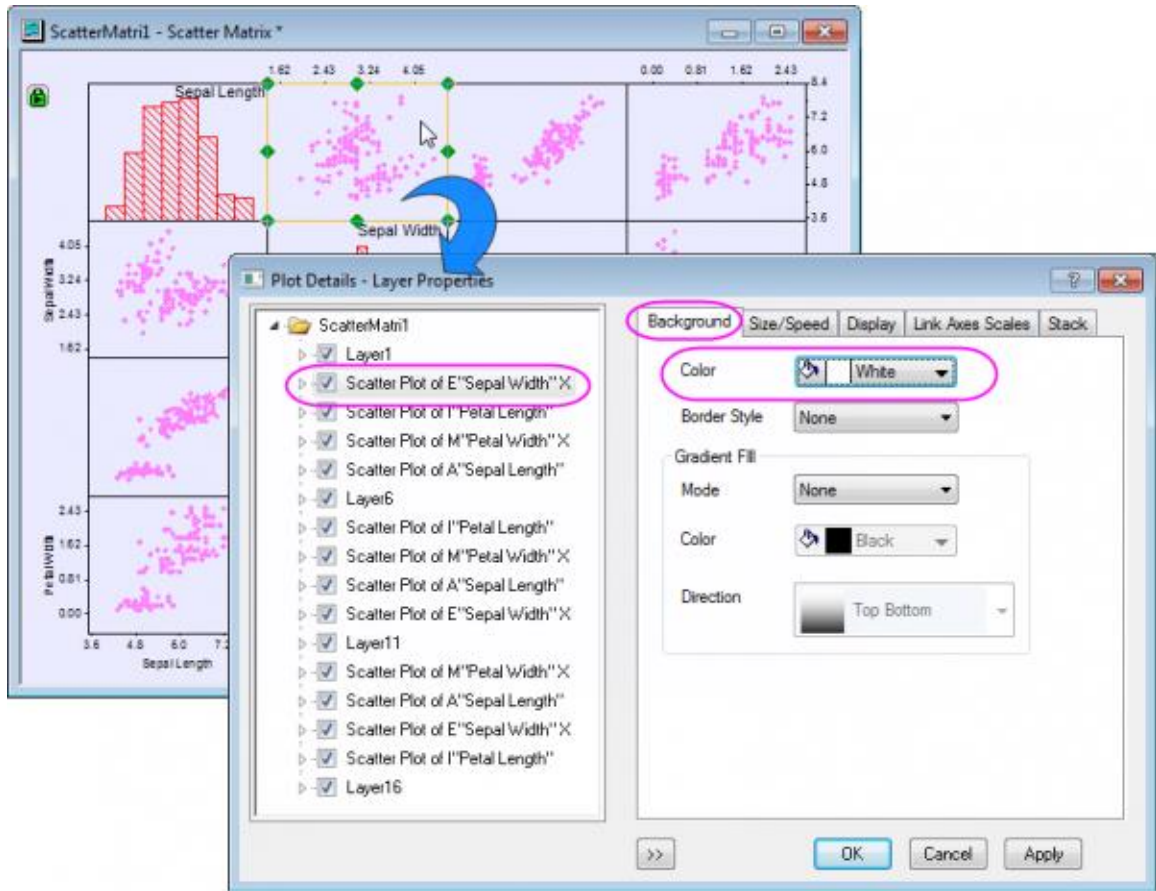

Then click **OK** in the dialog. This change will be applied to all layers with scatter data plots.

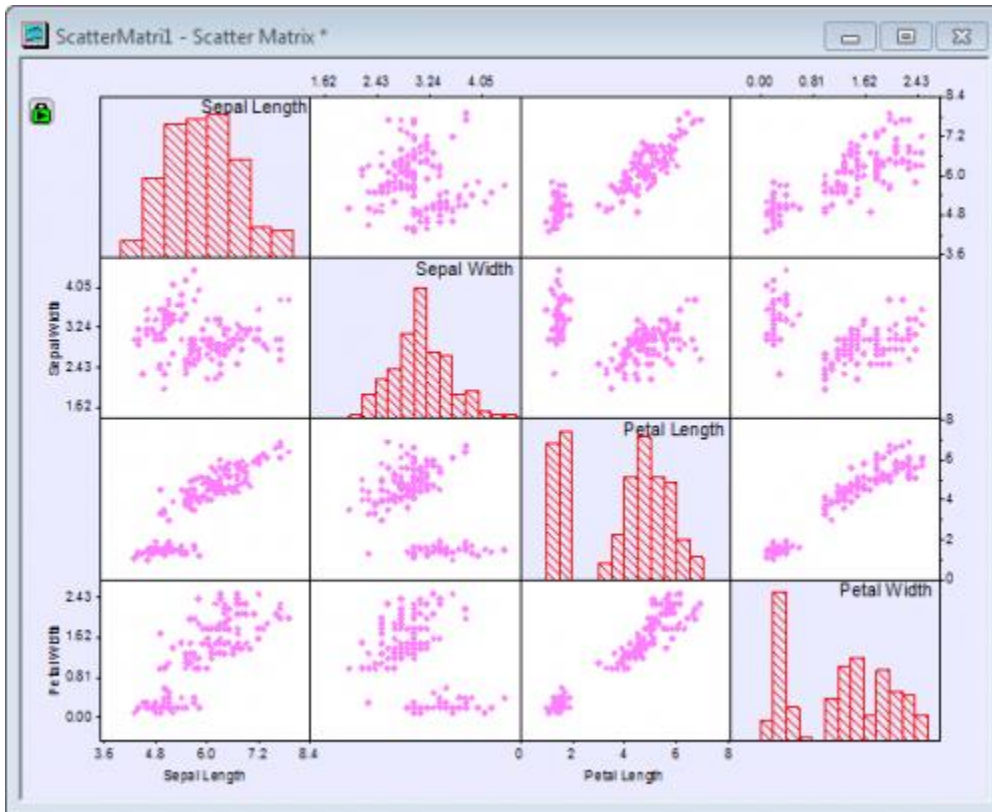

5. Double-click on any tick label in the graph to open the **Axis** dialog for that layer. Go to the **Tick Labels** tab, then the **Format** tab, specify **Size** to **36** for the **Top** axis. Click **Apply**.
6. Click the **Apply To...** button to open the **Apply To** dialog, set the following to apply the previous customization of tick label size to all the other axes in this window. Click **OK**, then **OK** to close the Plot

Details dialog box.

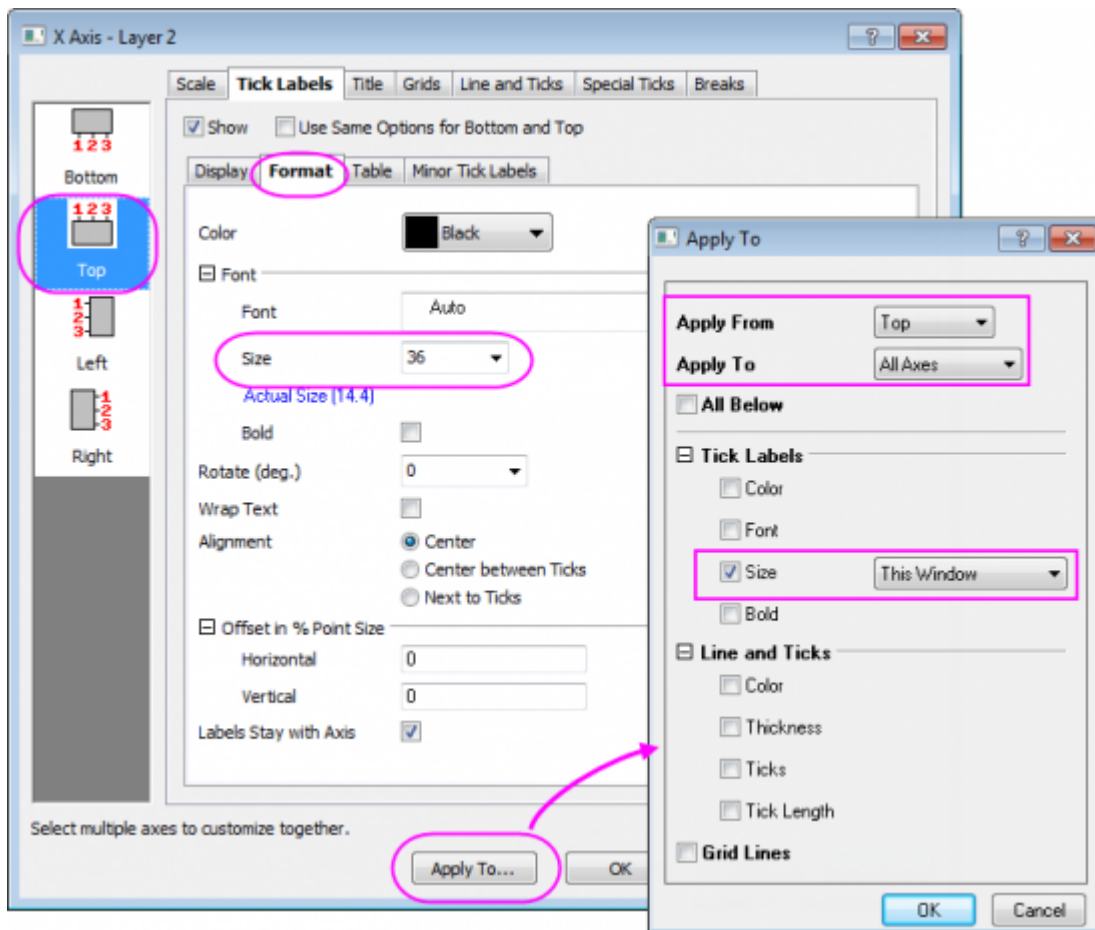

7. The graph will appear as shown below:

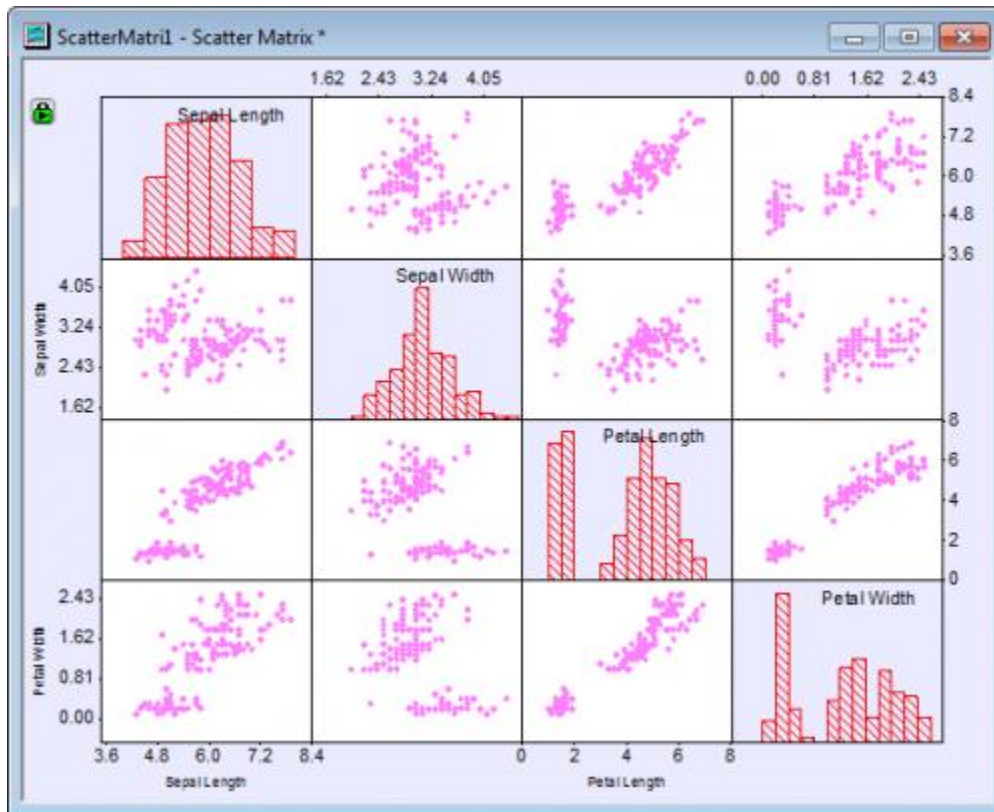

### 6.11.16.3.3 Add Grouping Range

Currently, our scatter plots show pair-wise comparisons of variables Sepal Length, Sepal Width, etc. What is not apparent from our scatter plots is that measurements were made on three species of iris. Since all scatter points look the same, we cannot distinguish between species. What we will do is to use the *Species* column in our original worksheet -- the column that we left out when making the graph -- to color each scatter point so that we can see the effect of species in our pairwise comparisons.

1. To add species information to our plot, click on the green lock icon on the upper-left corner of the graph window. Select **Change Parameters** to bring up the **Plotting: plot\_matrix** dialog.
2. Click the triangular button  beside **Grouping Range** and choose **E(Y): Species**, then click **OK**.
3. Click the **OK** button in the **Plotting: plot\_matrix** dialog. The graph will appear as shown below:



4.

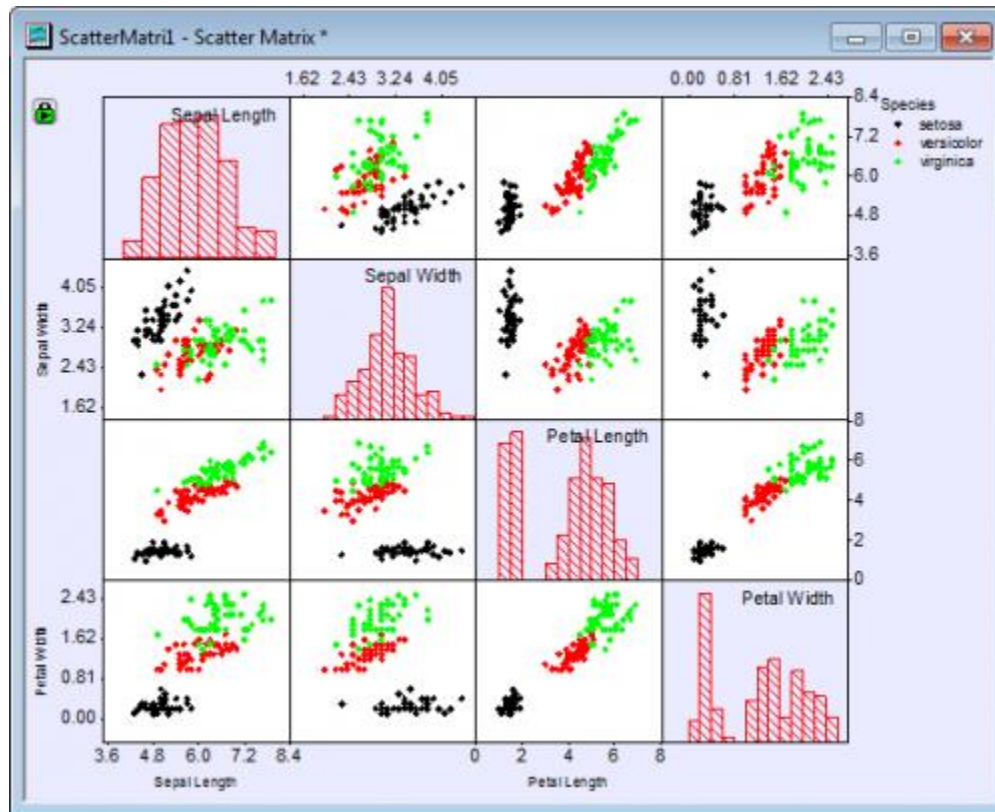

#### 6.11.16.3.4 Customizing Matrix Display

One Scatter Matrix display option is to hide half of the scatter plots (since they merely repeat the same information shown by the other half of the scatter plots).

1. To hide the layers below the diagonal in the Scatter Matrix graph, click on the green lock icon on the upper-left corner. Select **Change Parameters** to bring up the **Plotting: plot\_matrix** dialog.
2. Under the **Matrix Profile** branch of the dialog:
  - Select **Upper Triangular** from the **Matrix Display** drop-down list
  - Select **All** from **Show Tick and Label** drop-down list
  - Enter **2** in the **Gap (in % of Page Dimension)** text box







Plotting: plot\_matrix

Dialog Theme

Description

**Input**

**Input**   

**Grouping Range**   

**Matrix Profile**

**Matrix Display**

**Show in Diagonal Cells**

**Variables in Diagonal Cells**

**Show Tick and Label**



**Gap(in % of Page Dimension)**

**Options**

**Additional Statistics**

**Exclude Missing Value Listwise**

**Graph Templates**

**Output Results**   

OK Cancel

The complete graph should appear as shown below:

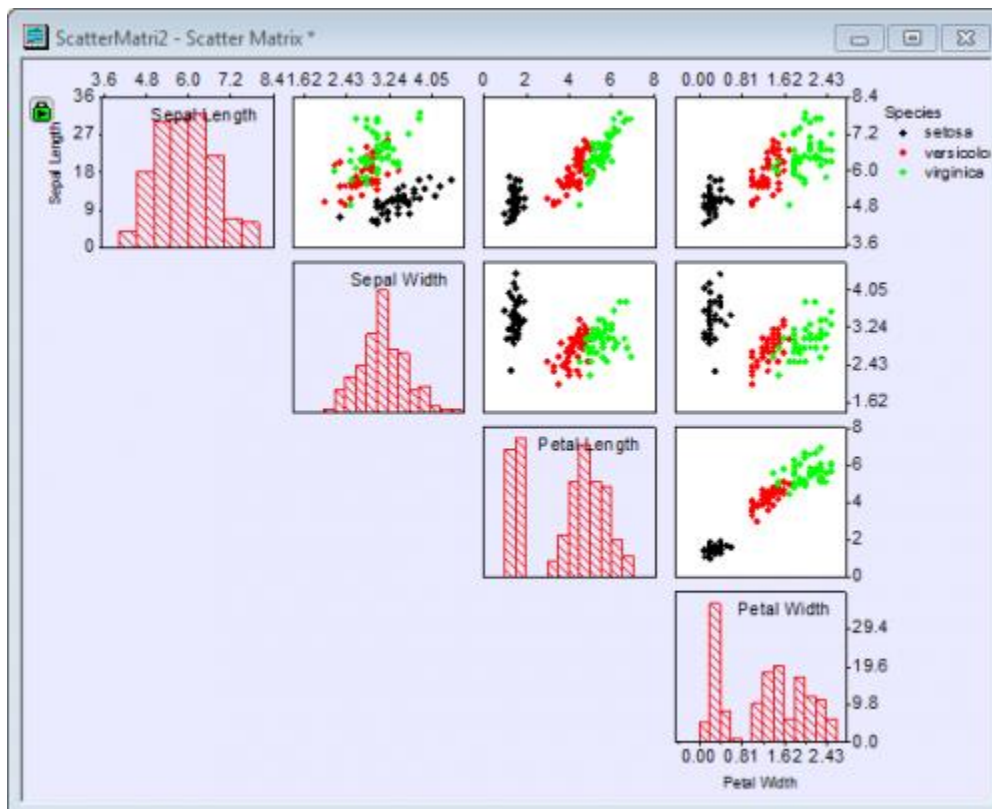

### 6.11.17 Histogram with Distribution Curve overlay

#### 6.11.17.1 Summary

After you plot a Histogram, Origin allows you to overlay a distribution curve on the binned data by selecting **Normal**, **Lognormal**, **Poisson**, **Exponential**, **Laplace**, or **Lorentz** from the **Type** drop-down list in the **Data** tab of the **Plot Details** dialog.

#### 6.11.17.2 What You Will Learn

- How to create a Histogram
- How to add the Distribution Curve
- How to create the Bin worksheet with distribution curve data.

#### 6.11.17.3 Steps

1. From the Main Menu, select **Data: Import from File: Single ASCII...: Sample: Graphing: Histogram2.dat**.

2. Highlight column B, and from the Main Menu select **Plot > Statistical: Histogram**.

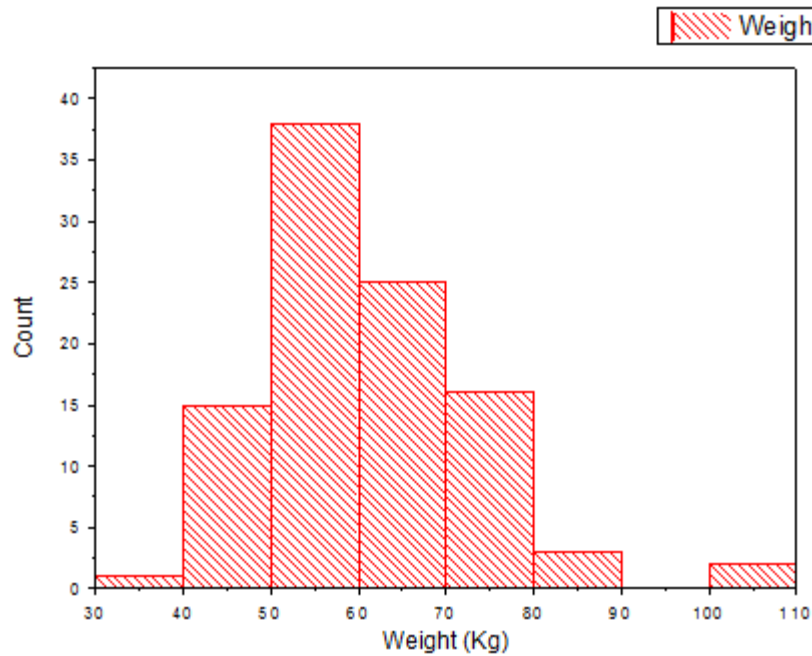

3. From the Main Menu, select **Format: Plot...**. From the **Plot Details - Plot Properties** dialog box select the **Data** tab.
4. From the **Distribution Curve: Type** list, select **Normal** and click **Apply**. Select the **Add Distribution Curves** check box and click **Go**. The **Plot Details - Plot Properties** dialog box closes and a worksheet of binned data (**Histogram2\_B Bins**) is added to the workbook.

The screenshot shows the 'Plot Details - Plot Properties' dialog box with the 'Data' tab selected. The 'Type' is set to 'Dots'. The 'Distribution Curve' section is highlighted with a pink oval, showing 'Type' set to 'Normal' and 'Scale to Maximum (%)' unchecked. The 'Bin Size' is 10, 'Number of Bins' is 8, 'Begin' is 30, and 'End' is 110. The 'Bin Height (0-100)' is 100. The 'Bin Worksheet' section is also highlighted with a pink oval, showing 'Add Distribution Curves' checked and a 'Go' button. A preview window shows a histogram with a normal distribution curve overlaid. At the bottom, it says 'The Counts column in the Bin Worksheet can be used for fitting.'

- In the **Histogram2\_B Bins** worksheet, the box at the intersection of row **Comments** and column **B(Y2)** shows the **Mean** and **SD** values for the data. Right-click on the box, and from the drop down menu select **Copy**.

	CumulativeSum(Y)	CumulativeProbab(Y)	A(X2)	B(Y2)
Long Name	Cumulative Sum	Cumulative Probability	Distribution	Normal
Units				
Comments	Bins	Bins		Mean= 60.705455707568, SD=11.630702803337
1	1	1	30	1.05156
2	16	16	30.08008	1.07083
3	54	54	30.16016	1.09039
4	79	79	30.24024	1.11026
5	95	95	30.32032	1.13044
6	98	98	30.4004	1.15093
7	98	98	30.48048	1.17174
8	100	100	30.56056	1.19286
9			30.64064	1.21431
10			30.72072	1.23609

- Right click within the histogram plot frame (but not directly on the plot) and from the context menu select **Add Text....** Right click within the Text Box and select **Paste**. Click inside the Text Box, select all numbers to the right of the tenths place for **Mean** and for **SD**, and hit the Delete key. Place your cursor after **Mean= 60.7** and hit the **Enter** key. The final graph should appear as below.

**Note** : If data fit the chosen distribution well, the overlay curve will also approximately agree with the histogram well.

7.

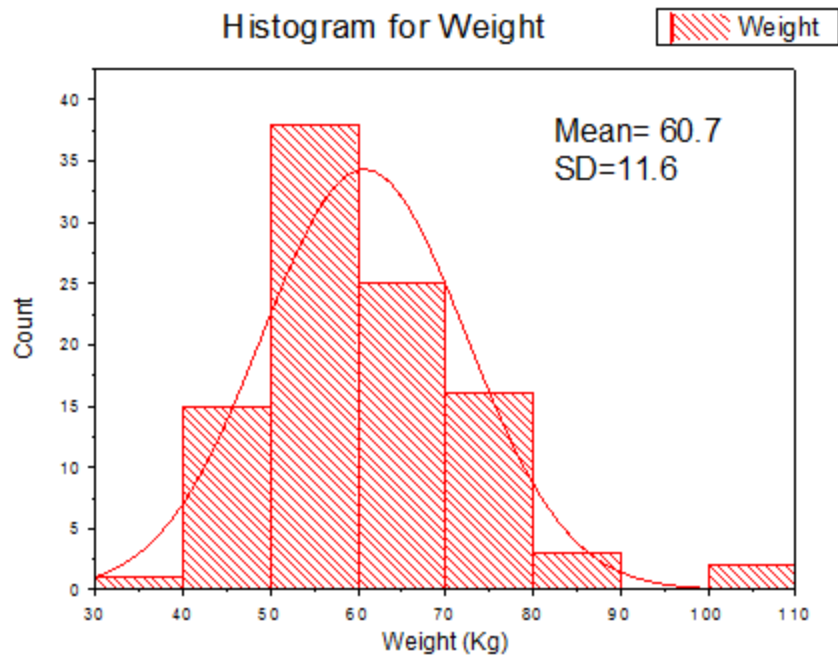

## 6.12 Polar

### 6.12.1 Polar

- [Polar Contour](#)
- [Polar Plot with Error Bar](#)
- [Polar Crop](#)
- [Polar Graph with Custom Radial Axes](#)
- [Polar Graph with Multiple Layers](#)
- [Polar Graph with Columns and Stack Columns](#)
- [Polar Graph with Custom Angular Scale](#)

### 6.12.2 Polar Contour

#### 6.12.2.1 Summary

This tutorial will show you how to create a Polar Contour graph from both XYZ worksheet data and matrix data.

Minimum Origin Version Required: 2015 SR0

#### 6.12.2.2 What will you learn

- Create a Polar Contour graph from both XYZ data and matrix data
- Customize the graph using the Plot Details dialog box

### 6.12.2.3 Steps

#### 6.12.2.3.1 Plot Polar Contour from XYZ data

This tutorial is associated with the Tutorial Data project: <Origin EXE Folder>\Samples\Tutorial Data.opj. You can refer to this graph in Learning Center. (Select **Help: Learning Center** menu or press **F11** key, and then open **Graph Sample: Polar Charts**)

1. Open the Tutorial Data project and browse to folder *Polar Contour* in **Project Explorer**.
2. Activate **Book2BA** containing the temperature and location data and select column **C**. Select **Plot > Specialized : Polar Contour theta(X) r(Y)** from the menu to create a polar contour graph. The graph should look like this:

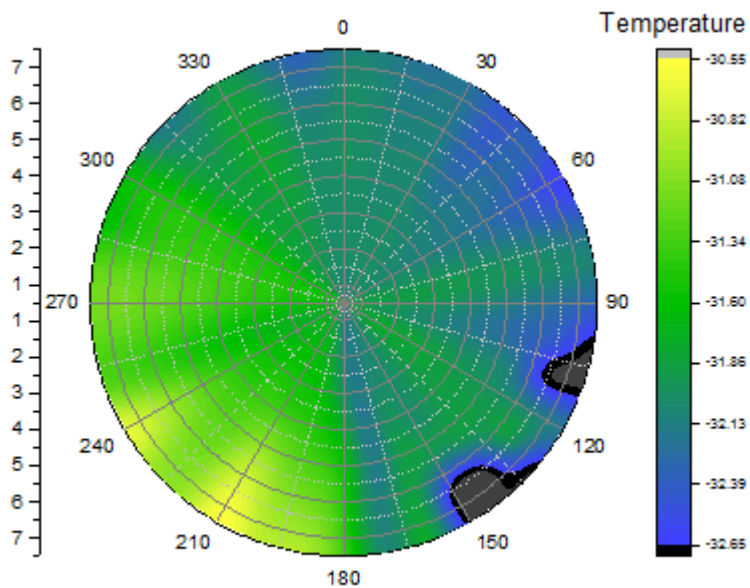

3. Next, we will customize the contour graph using the **Plot Details** dialog box. Double-click on the contour plot to bring up the Plot Details dialog then select the **Color Map/Contours** tab and click the **Fill**

heading. Edit dialog box settings as shown in the following:

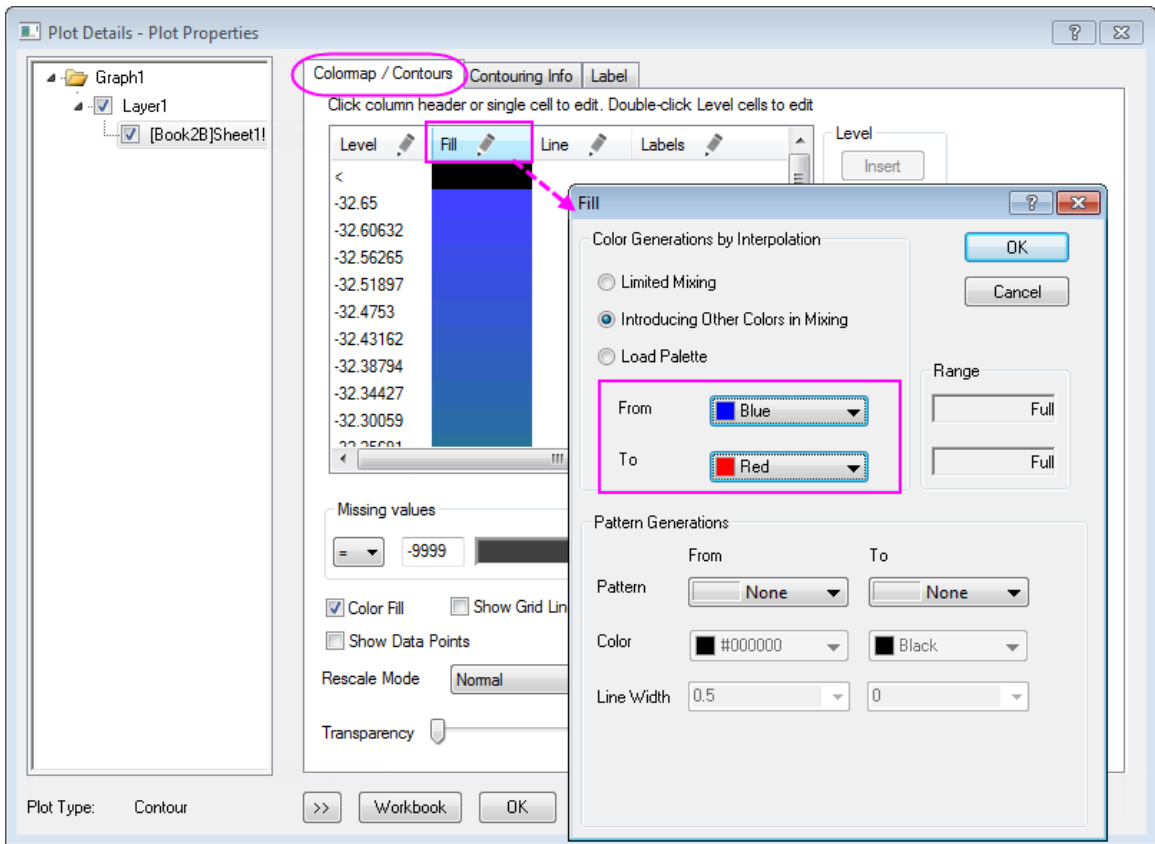

4. Click the **Contouring Info** tab and select the **Layer Boundary** radio button.

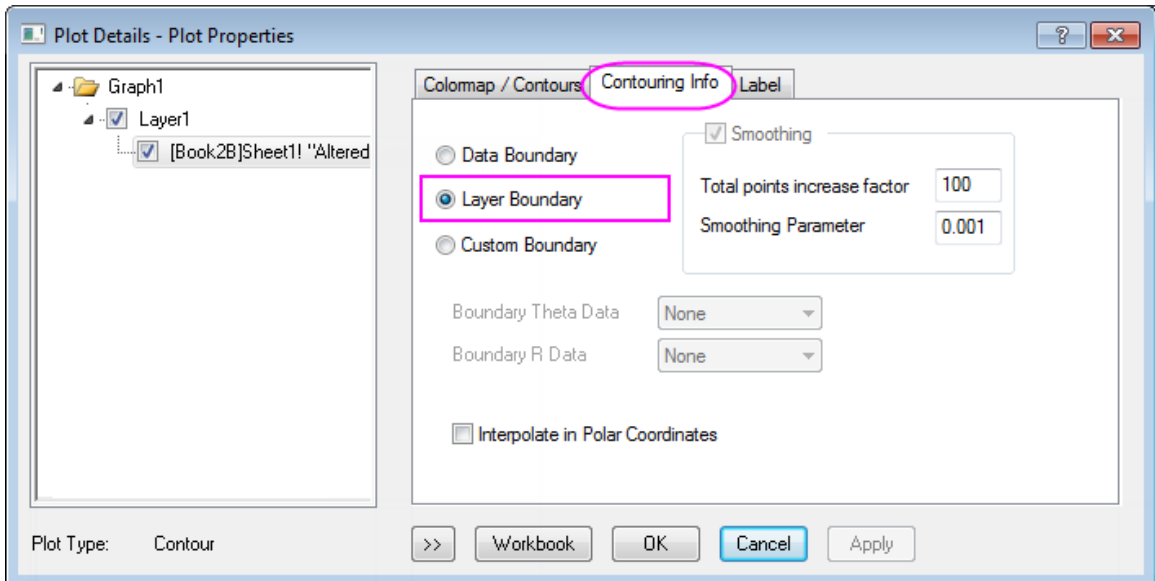

Click **OK** to close the **Plot Details** dialog box.

5. Next, we will customize the graph axes. Double-click on the axes to open the **Axis** dialog box, then...

- Go to **Scale** tab and make sure **Angular** is chosen in the left panel. Under the **Major Ticks** tree node, set the **Type** to **By Increment** and **Value** to **60**.

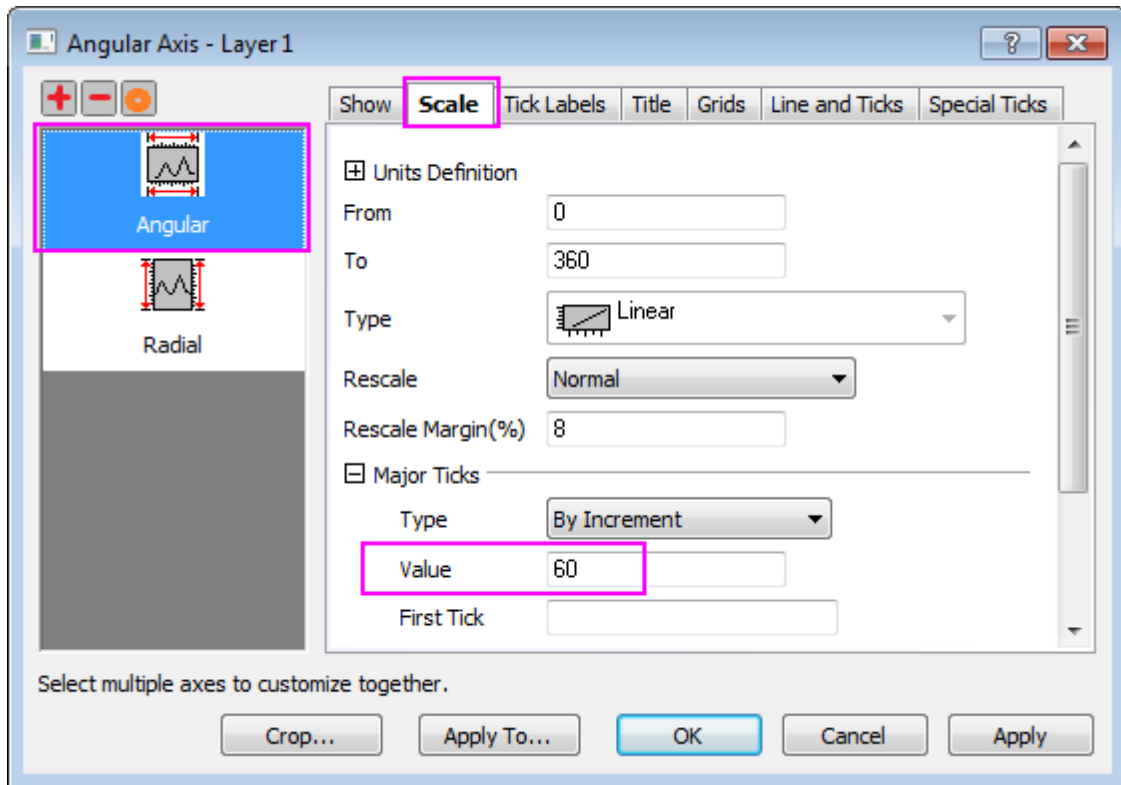

- Go to **Tick Labels** tab and select **Angular - Outer** in the left panel. In the right panel, go to **Display** tab, select **Tick-indexed dataset** in **Type** drop-down list and then select **[Book3B]Sheet1!B"Longitude"** from the **Dataset Name** drop-down list.



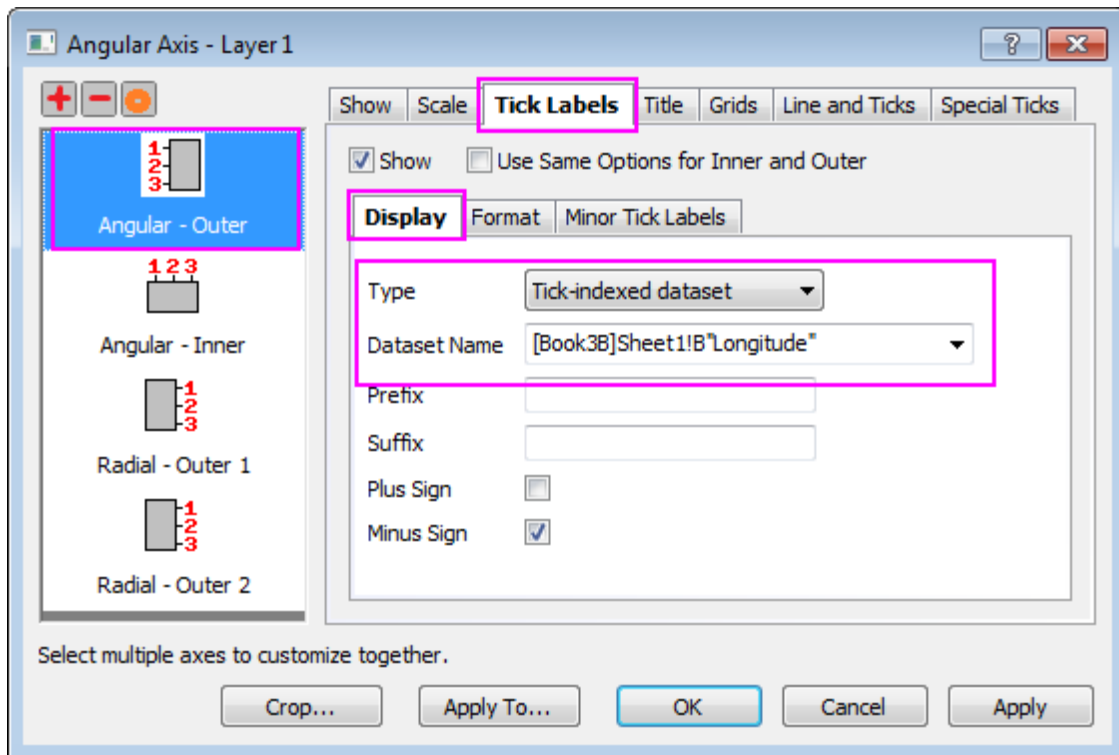

- Go to **Scale** tab, and select **Radial** in the left panel. In the right panel set **From** and **To** to **0** and **7**. Also under the **Major Ticks** tree node, set the **Type** to **By Increment** and **Value** to **2**.

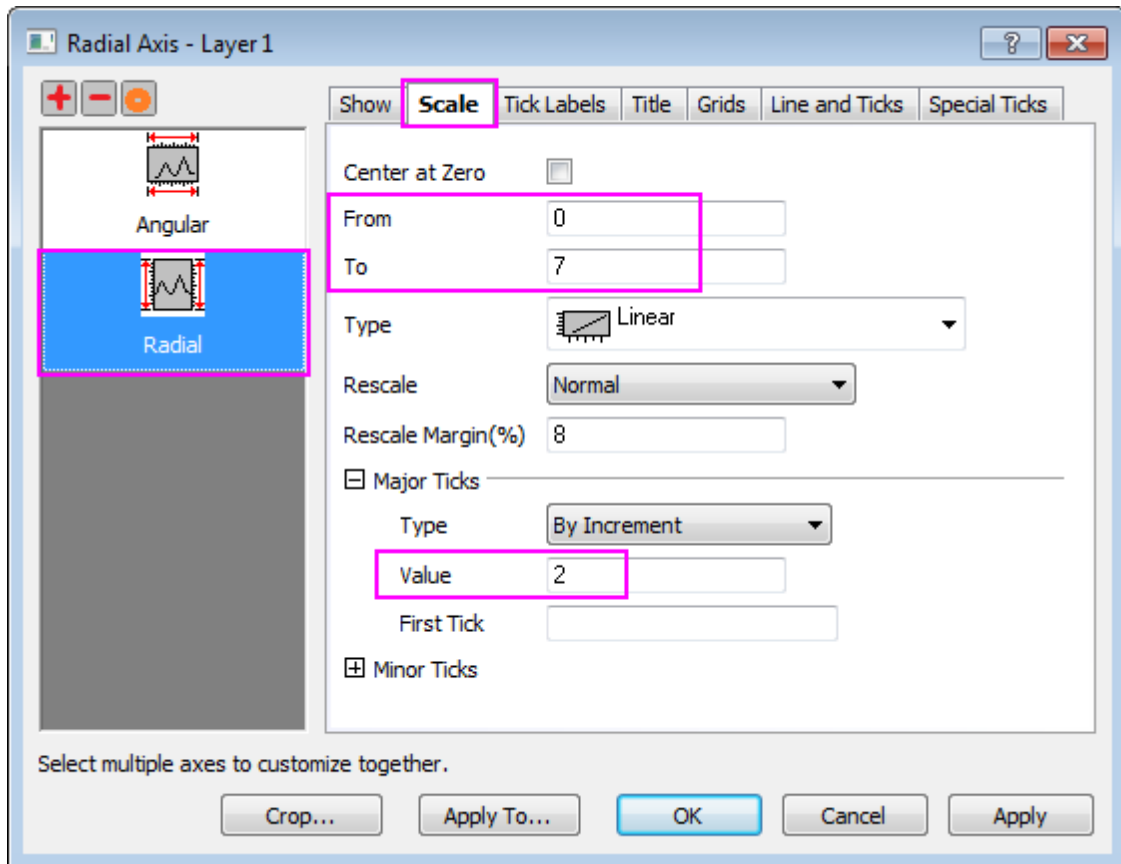

- Go to **Tick Labels** tab. Pressing **Ctrl** key and select both **Radial - Outer 1** and **Radial - Outer 2** in the left panel. In the right panel, go to **Display** tab, select **Tick-indexed dataset** in **Type** drop-down list, then select **[Book3B]Sheet1!A"Latitude"** from the **Dataset Name** drop-down list.

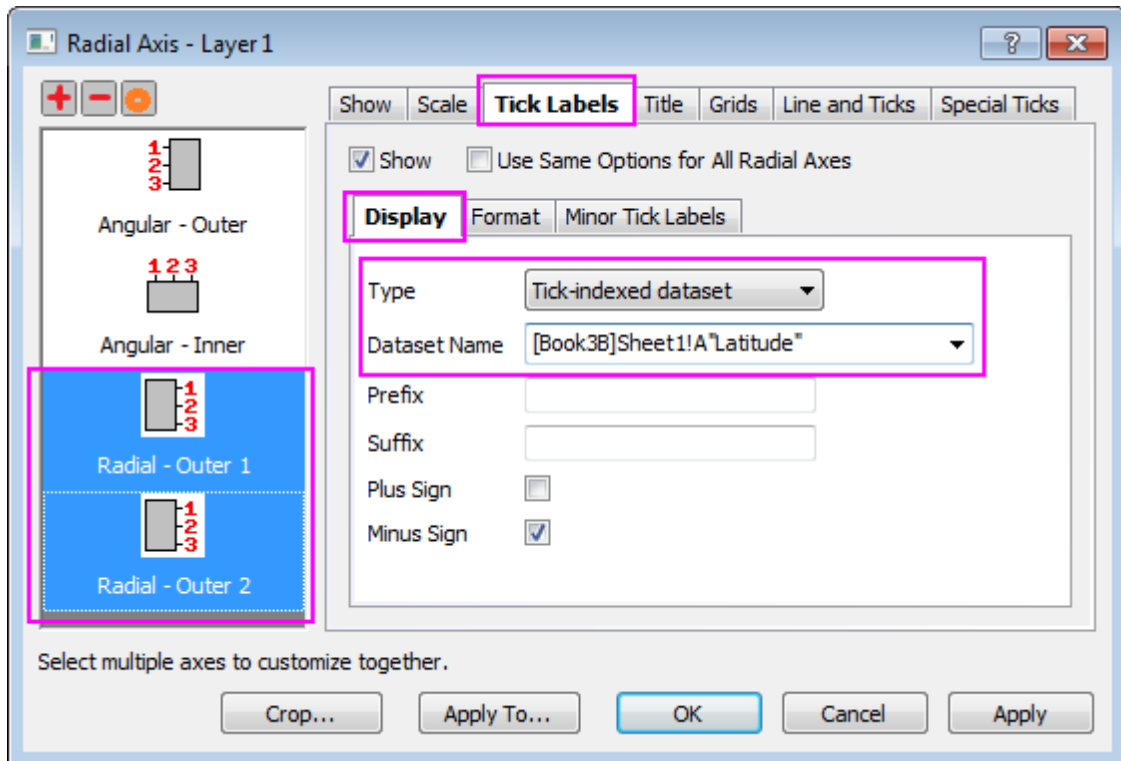

- Go to **Grids** tab, and make sure **Radial** is selected in the left panel. Edit the dialog box settings as in the following image. Click **OK** to close the **Axis** dialog box.

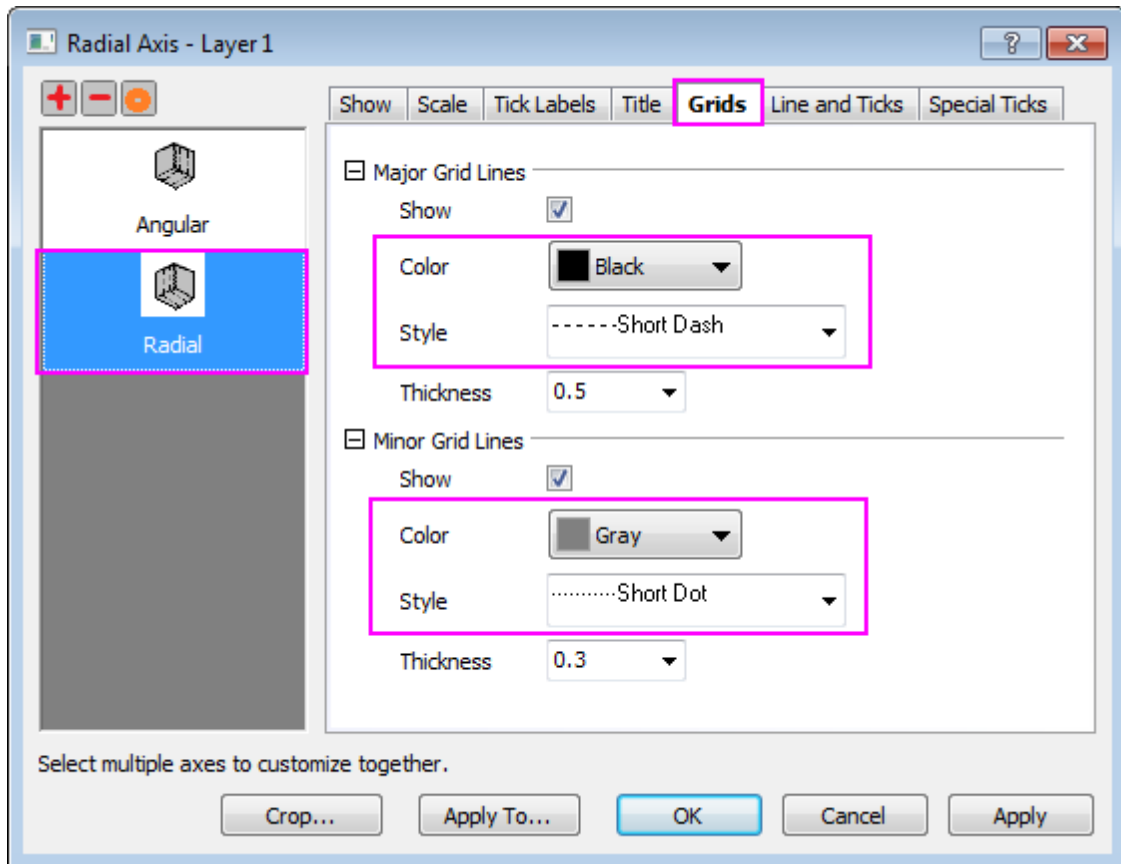

6. Double-click on the **Color Scale** to open the **Color Scale Control** dialog box and edit settings as follows
  - o In the **Labels** page, set font size to **20**.

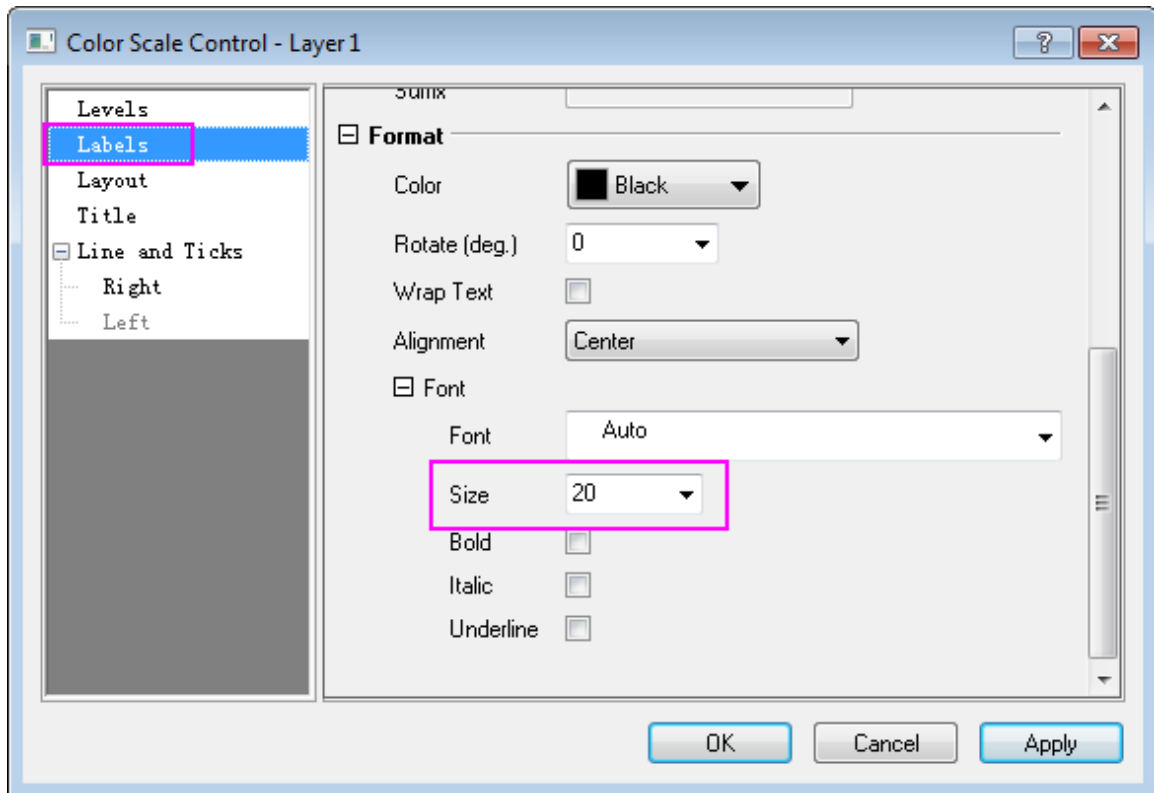

- o In the **Layout** page, uncheck **Reverse Order** check box, and set **Color Bar Thickness** to **100**.

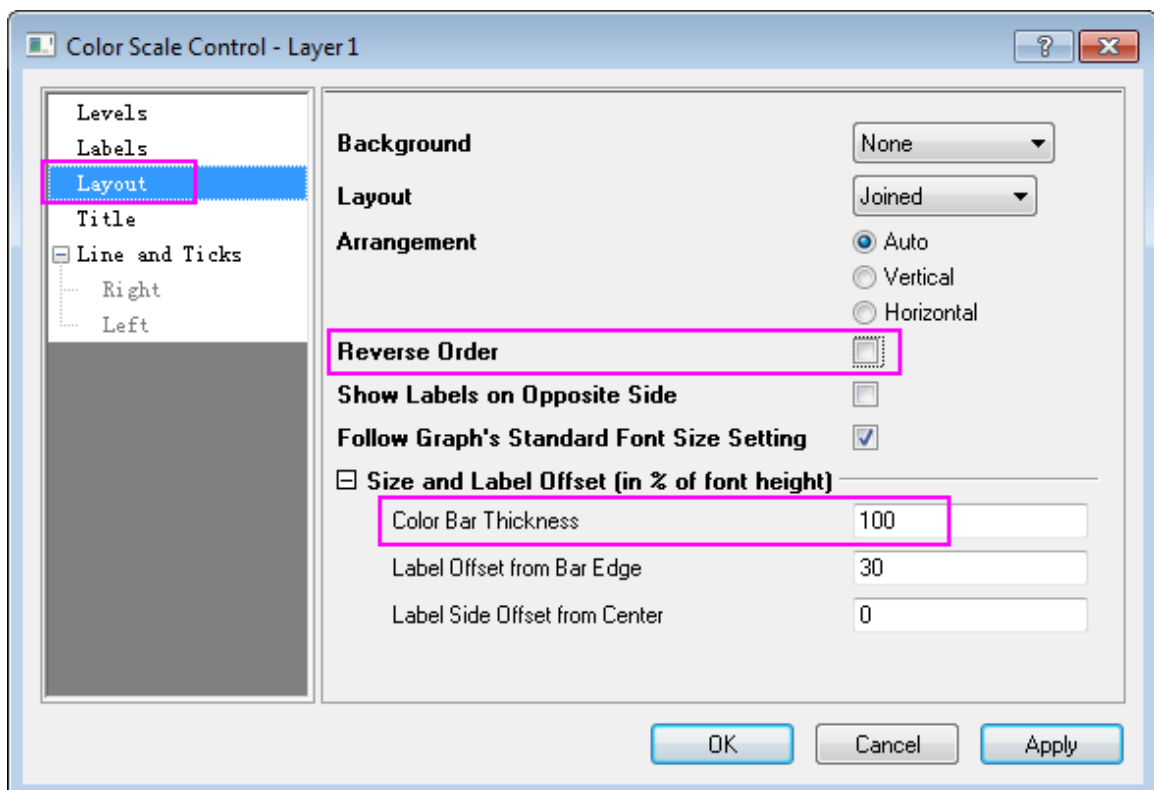

- In the **Title** page, enter  $(\backslash+(o)F)$  in the **Title**, which is supposed to be displayed as  $(^{\circ}F)$  as the unit for temperature. And set the **Position** to **Bottom**.

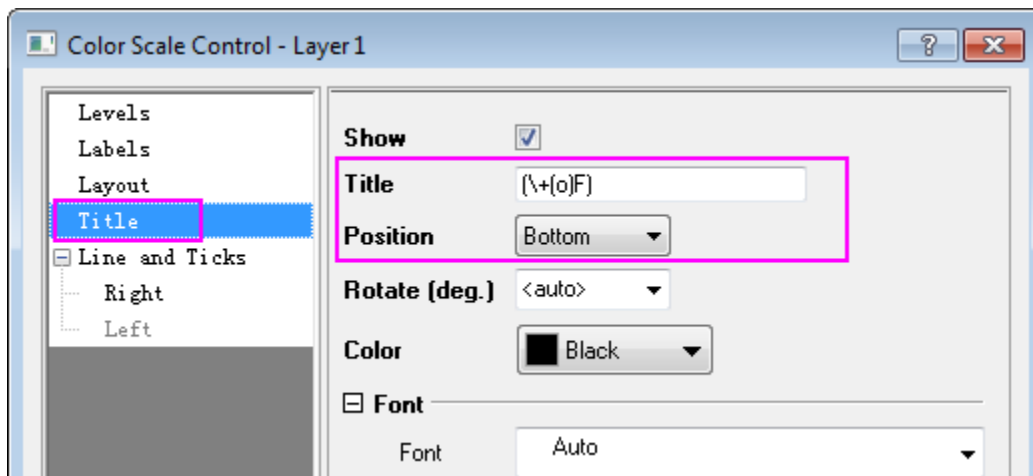

- In the **Line and Ticks** page, uncheck **Show Line and Ticks on Right** and **Show Border** check box. Then Click **OK** to save the setting and close the dialog.

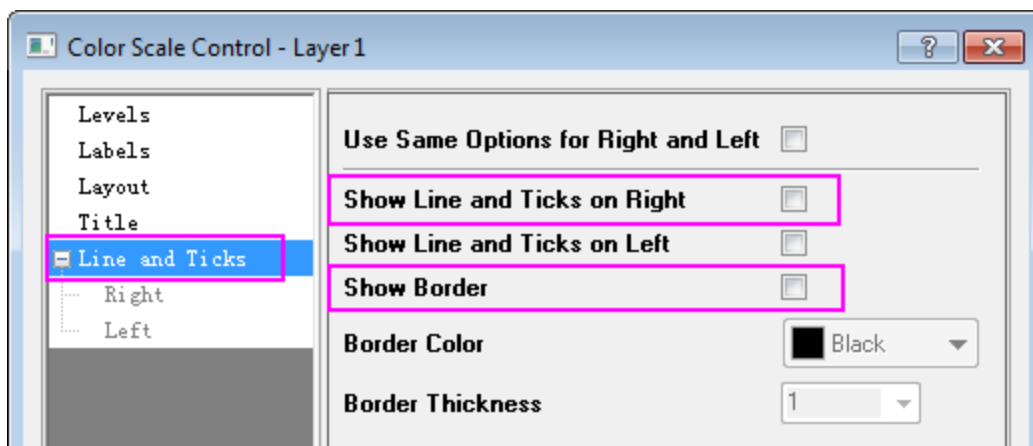

**Note:** The text used for **Title** is  $(\backslash+(o)F)$ , which is supposed to be displayed as  $(^{\circ}F)$  as the unit for temperature.

7. Add the graph title **Temperature Contour Map**, axis title **Latitude** to the graph. The graph should look like this:

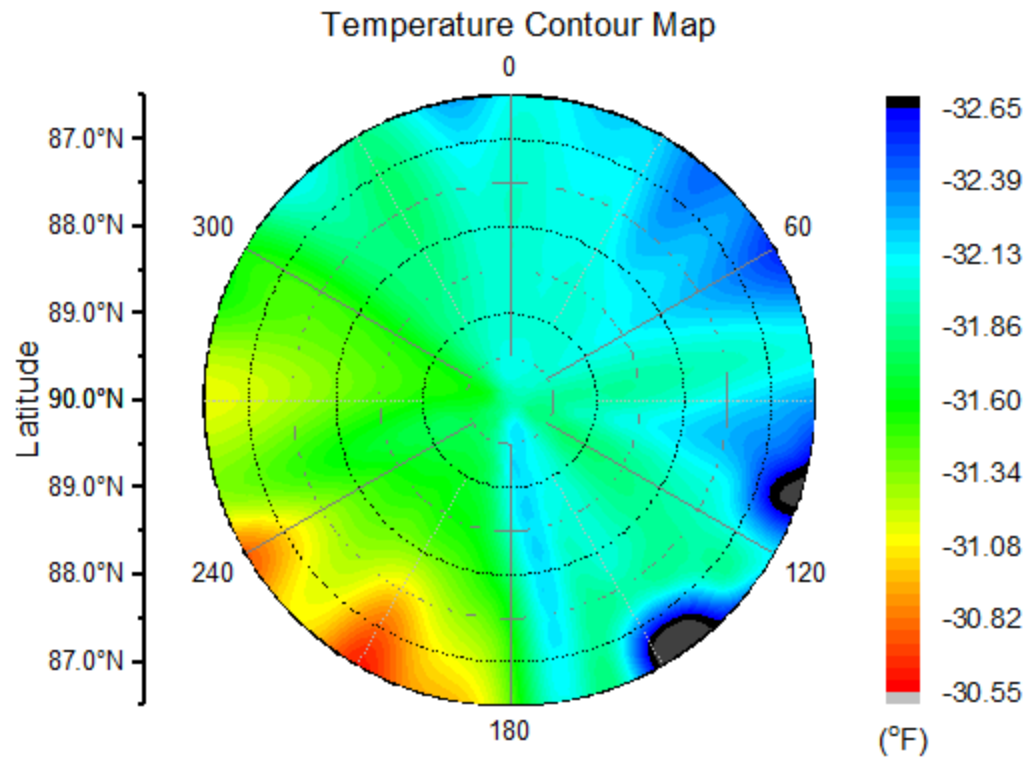



#### 6.12.2.3.2 Plot Polar Contour from Matrix data

This tutorial is associated with the Tutorial Data project: <Origin EXE Folder>\Samples\Tutorial Data.opj. You can refer to this graph in Learning Center. (Select **Help: Learning Center** menu or press **F11** key, and then open **Graph Sample: Contour**)

1. Open the Tutorial Data project and browse to folder *Contour from Matrix* in **Project Explorer**.

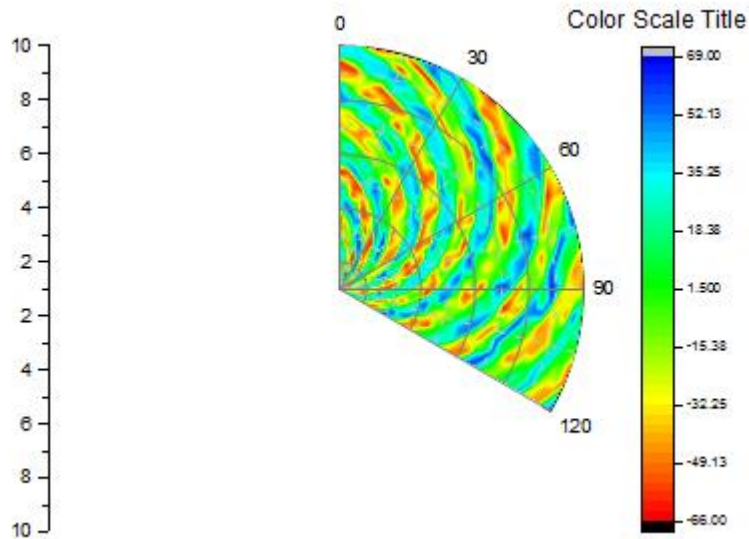
2. Activate *MBook1*. Select **Plot > Specialized : Polar Contour theta(X) r(Y)** from the menu or click the **Polar Contour theta(X) r(Y)** button on the **3D And Contour Graphs** toolbar.



3. Double click the axes to open the **Axis** dialog, we also can customize the **Radial Axes** for this polar graph.
  - o Click on the **Radial Axes Configuration** button  on the right-top of this dialog to open the dialog. In the dialog, choose **0** under the **Angles List** drop-down list.



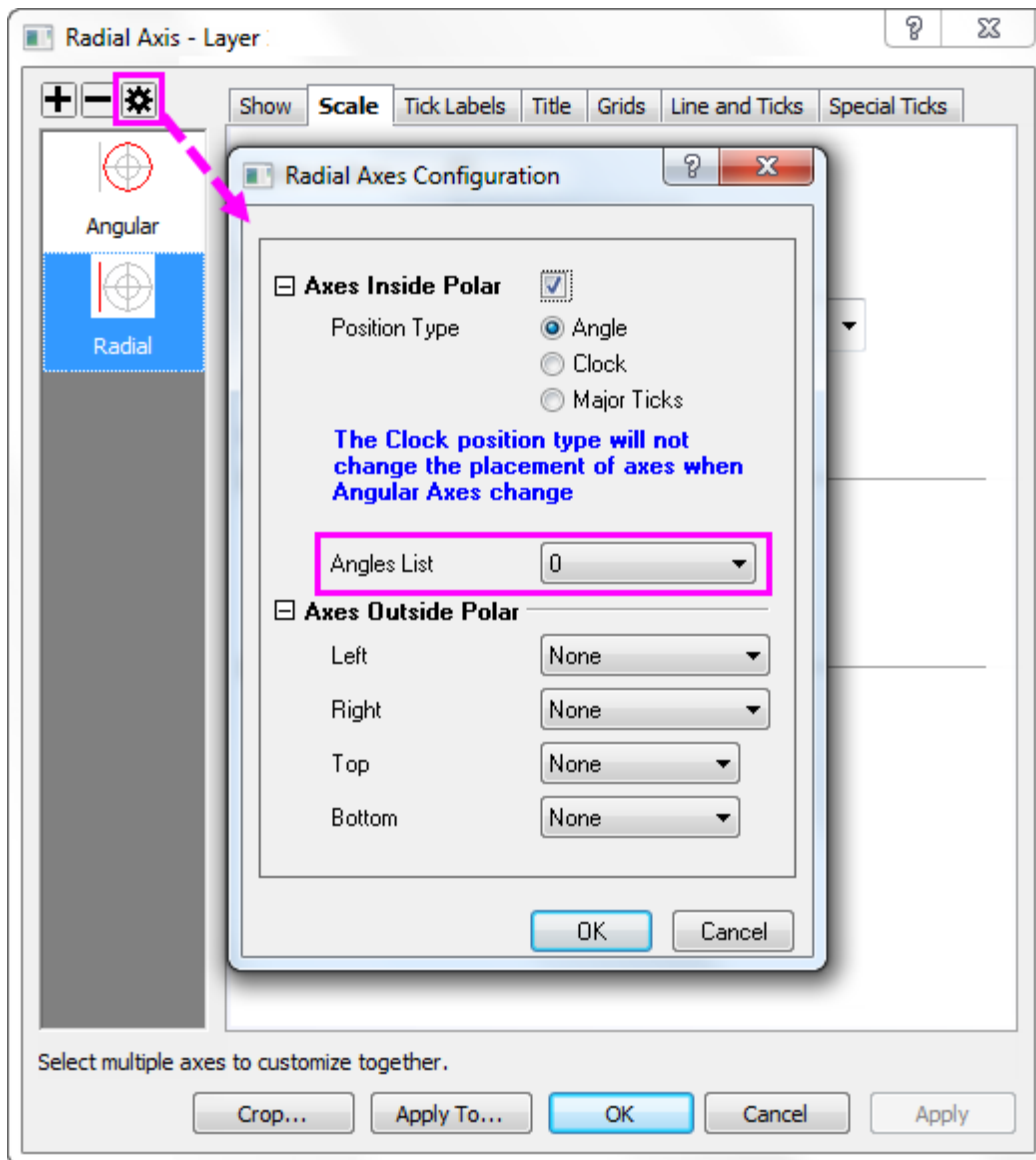

- Go to **Show** tab, and choose **Radial - Inner Axis 1** in the left panel. From the **Angle At** dropdown list, select **End Angle** and set **Flow Direction** to **Negative**.

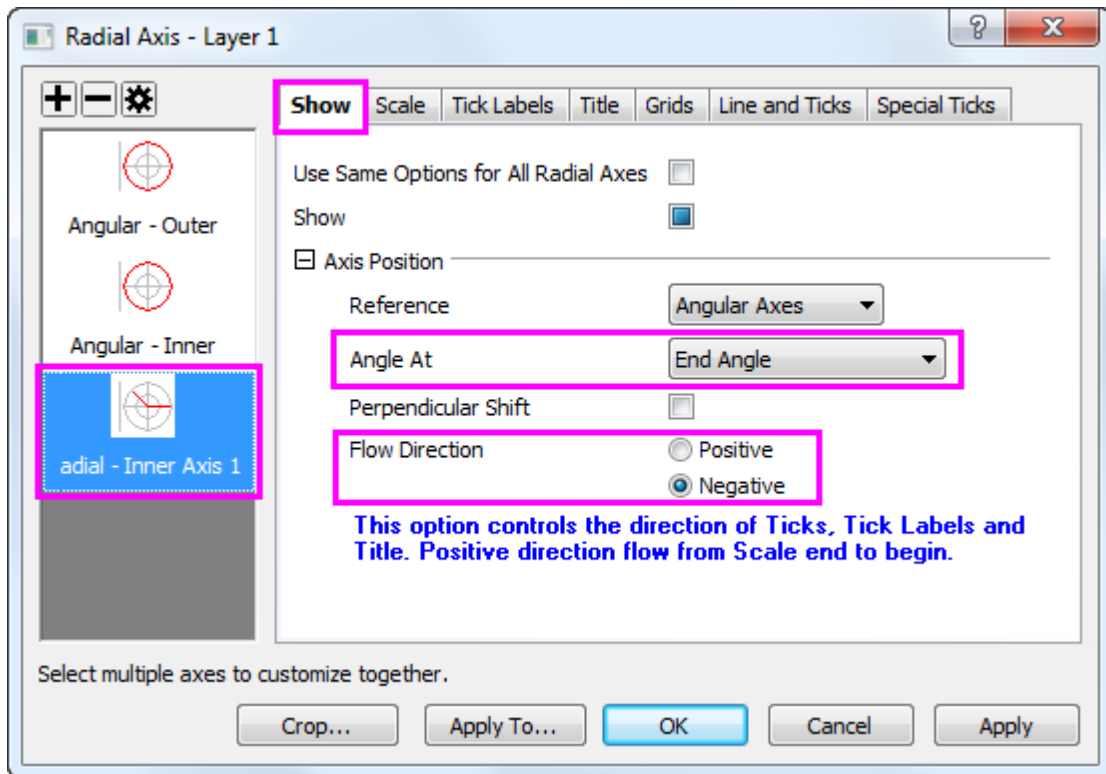

- Choose **Angular - Outer** in the left panel. On the **Show** tab, in the **Axis Start at (deg.)** box, enter **-30**. Click **OK** to save settings and close the dialog.

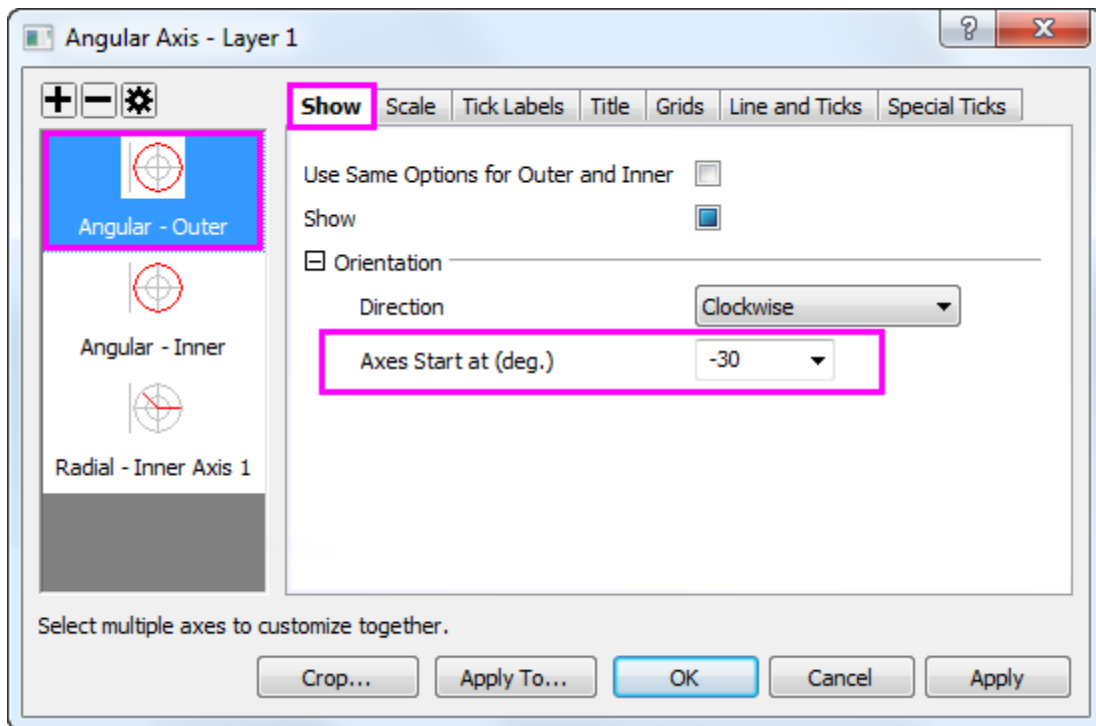

4. Double click on the graph to open **Plot Details** dialog. Go to **Colormap / Contours** tab, click on the **Level** header to open the **Set Levels** dialog. Set levels as in the following image and click **OK**:

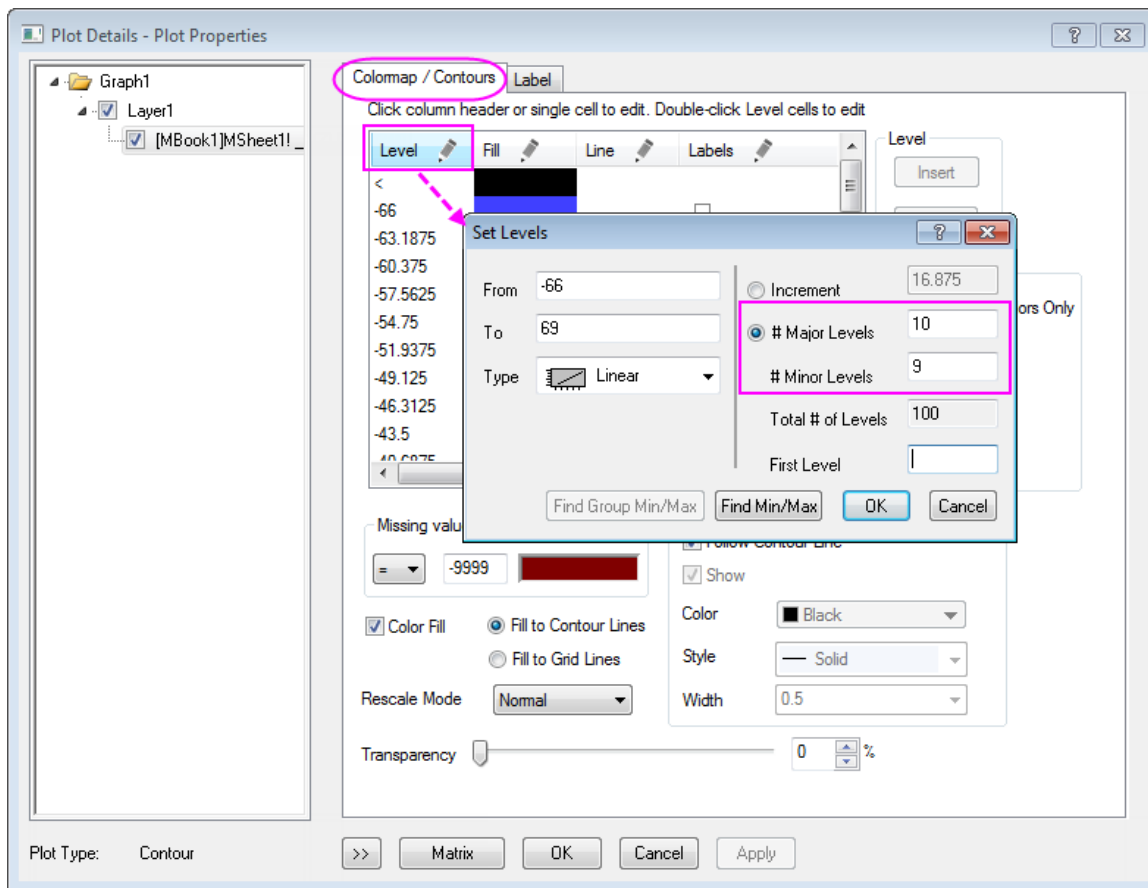

Click on the **Fill** header to open the **Fill** dialog. Make sure colors as in the following image:

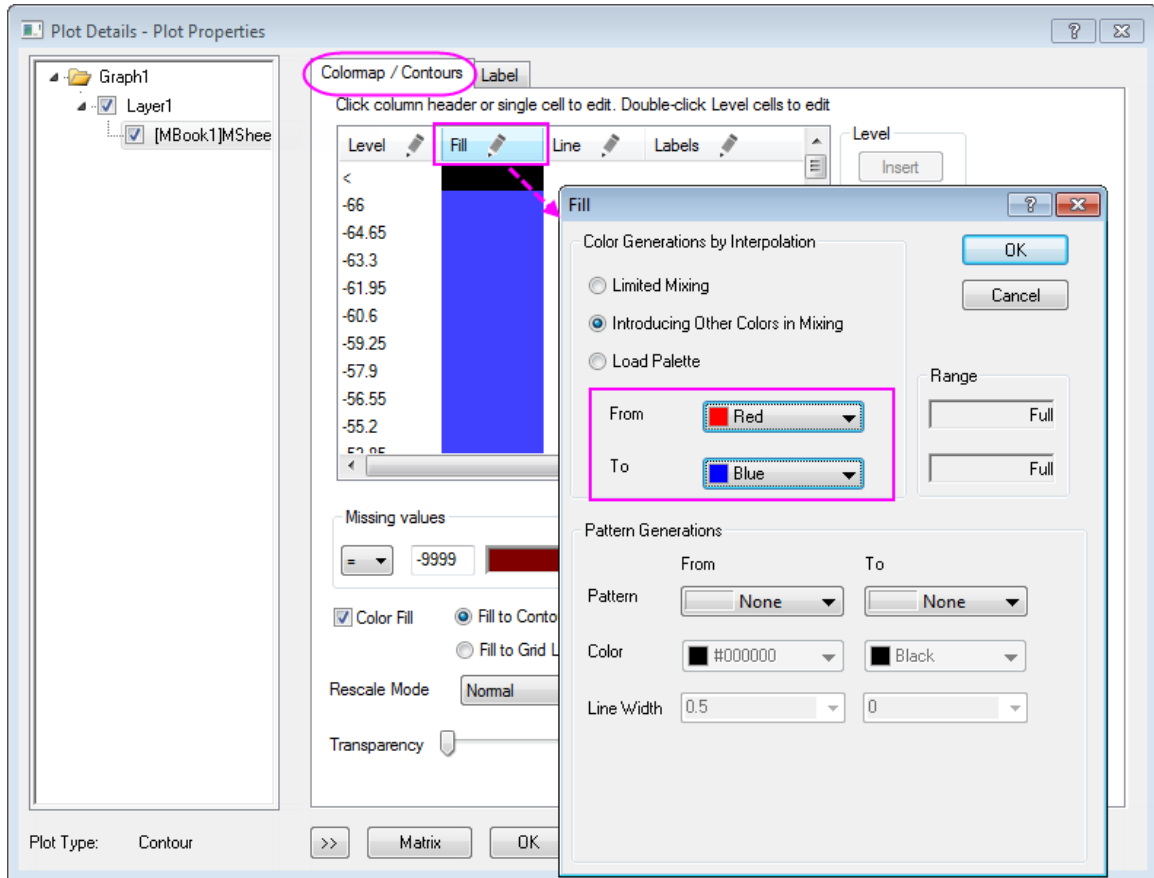

5. Select the **Layer1** icon in the left panel of **Plot Details** and click on the **Size/Speed** tab. Set the **Layer Area** as the following image:

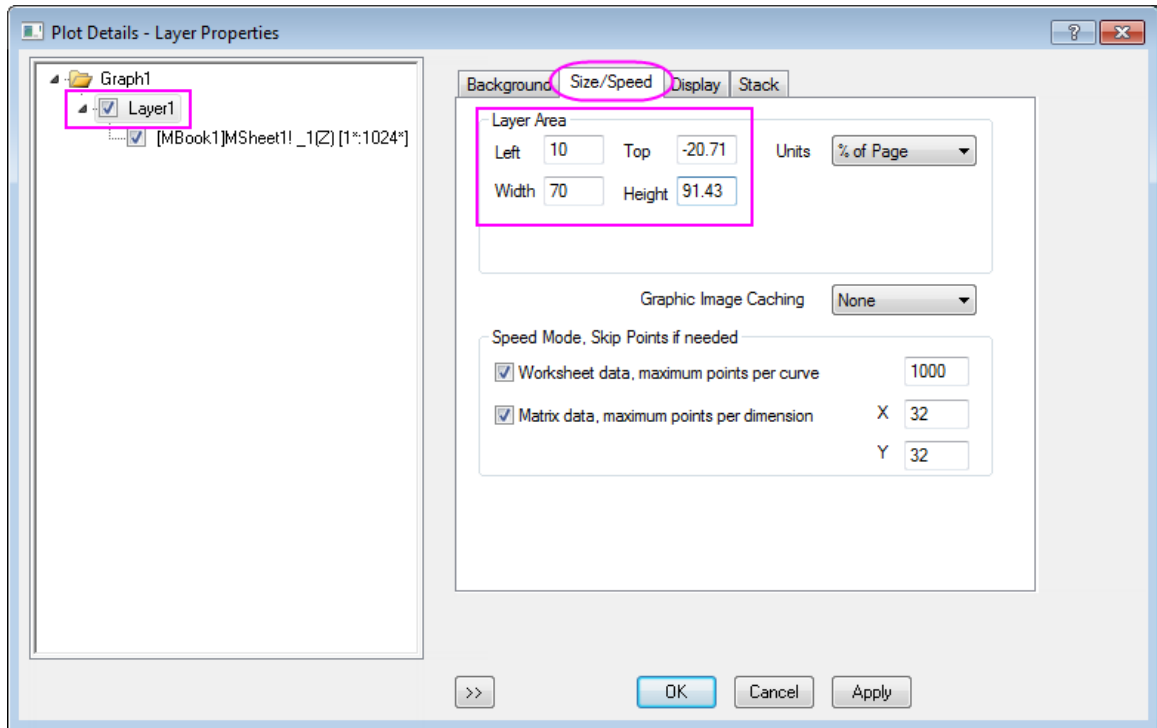

Click **OK** to save settings and close the dialog.

6. Double-click on the **Color Scale** object to open the **Color Scale Control** dialog.
  - In the **Levels** page, check the **Hide Head and Tail Levels** check box.



- In the **Layout** page, uncheck **Reverse Order** and set **Color Bar Thickness** to **400**.

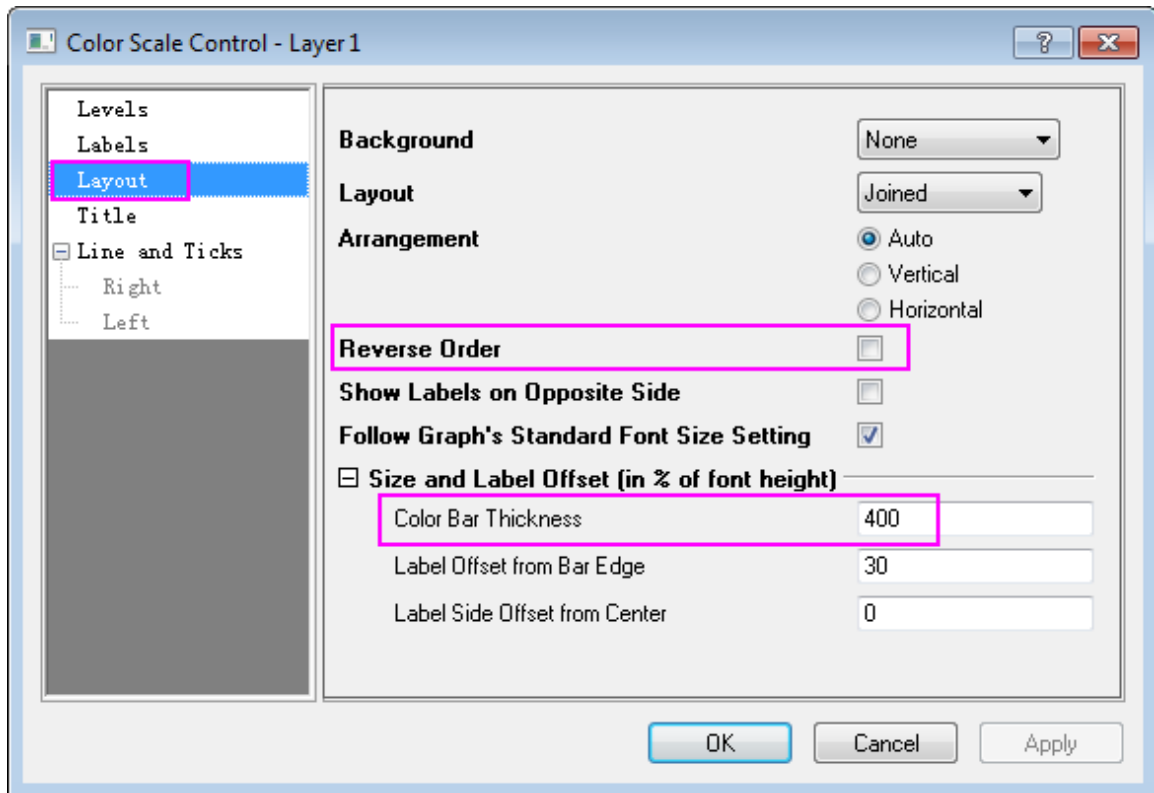

- In the **Title** page, uncheck **Show** check box.

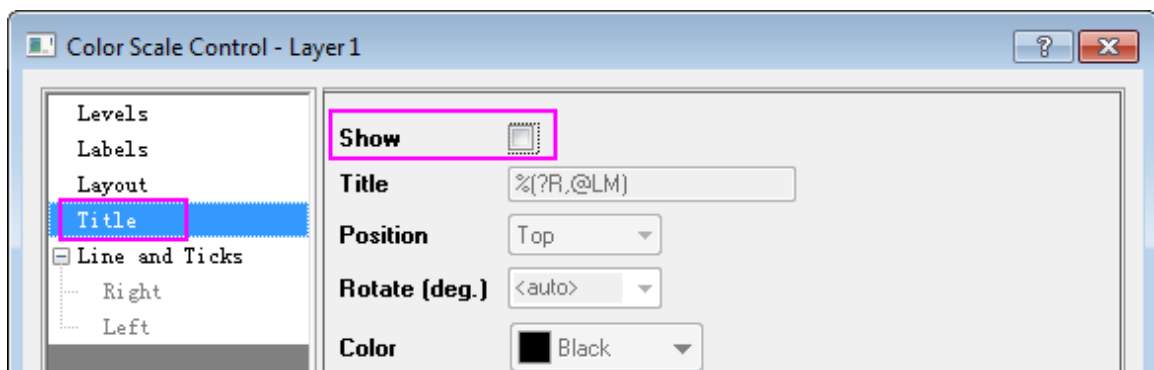

- In the **Line and Ticks** page, uncheck **Show Line and Ticks on Right** and **Show Border**. Click **OK** to save settings and close the dialog.

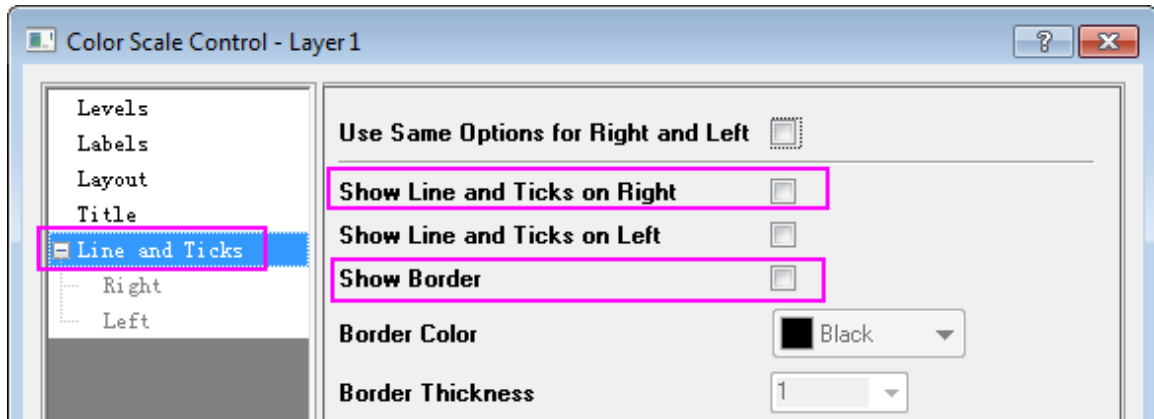

- Click on the Color Scale object and use the anchor points to resize it from vertical direction. The resulting graph should look like this:

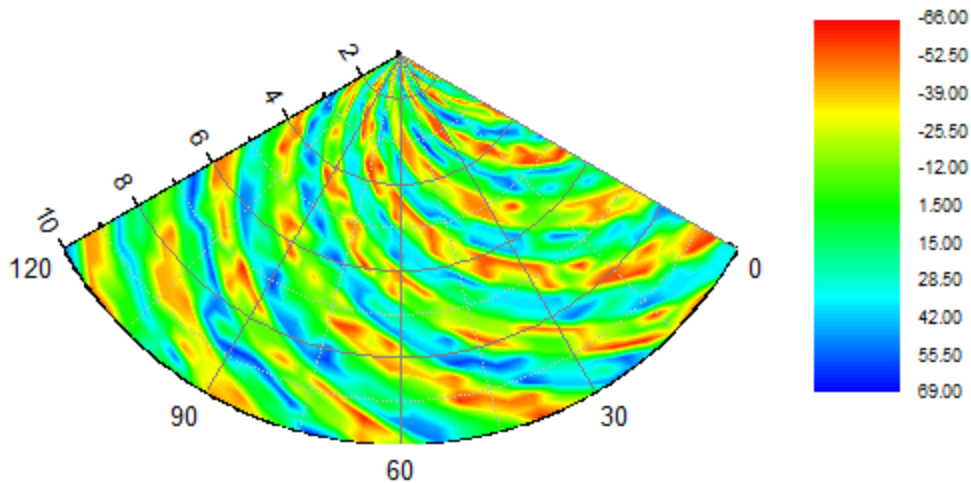

Polar contour graphs from matrix data support filling color to contour lines or to the matrix grid. For more information, see these two topics:

- [Customizing Polar Contour Graphs from Matrix Data](#)
- [Color Fill Control Group](#)

### 6.12.3 Polar Plot with Error Bar



### 6.12.3.1 Summary

This tutorial will demonstrate how to create a Polar graph with error bars:

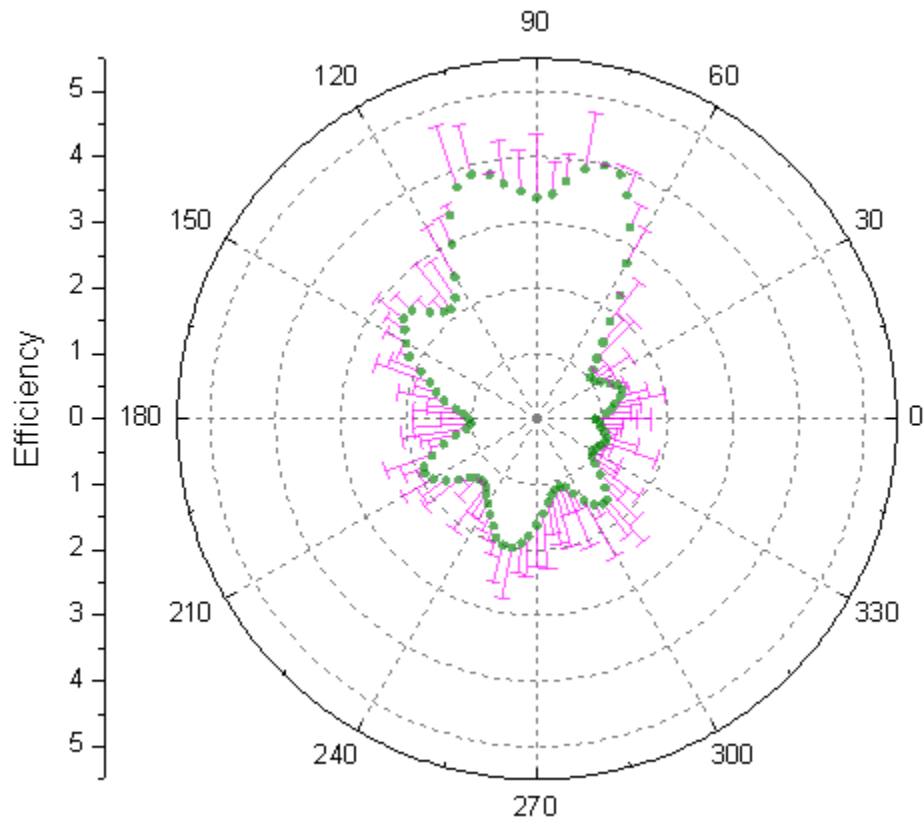

### 6.12.3.2 What you will learn

This tutorial will teach you how to:

- Create a Polar graph with error bars
- Customize the graph using the Plot Details and Axis dialogs

### 6.12.3.3 Steps

1. Import the data file **PolarPlotwithErrorBar.dat** under *<Origin EXE Folder>\Samples\Graphing\* path (Minimum Origin Version: 2015 SR0), or you can download [this data file](#) directly and import into Origin.
2. Hover your cursor over col(C) till it appears as a downward pointing arrow and click to highlight column C. Right-clicking produces a menu where this column can be set as **Y error**.
3. In order to plot the Polar graph of the data with error bars highlight all the columns. In the main menu select **Plot > Specialized : Polar theta(X) r(Y)** or click the **Polar theta(X) r(Y)**  button on the **2D Graphs** toolbar.

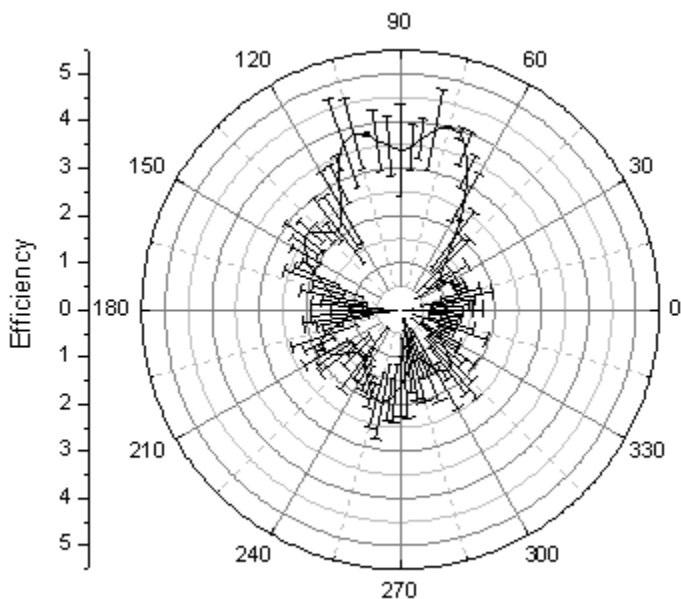

4. Double-click inside the plot to open the **Plot Details** dialog. In the **Error Bar** tab change the **Color** to Magenta and remove the negative error bars by deselecting the **Minus** box as shown below:

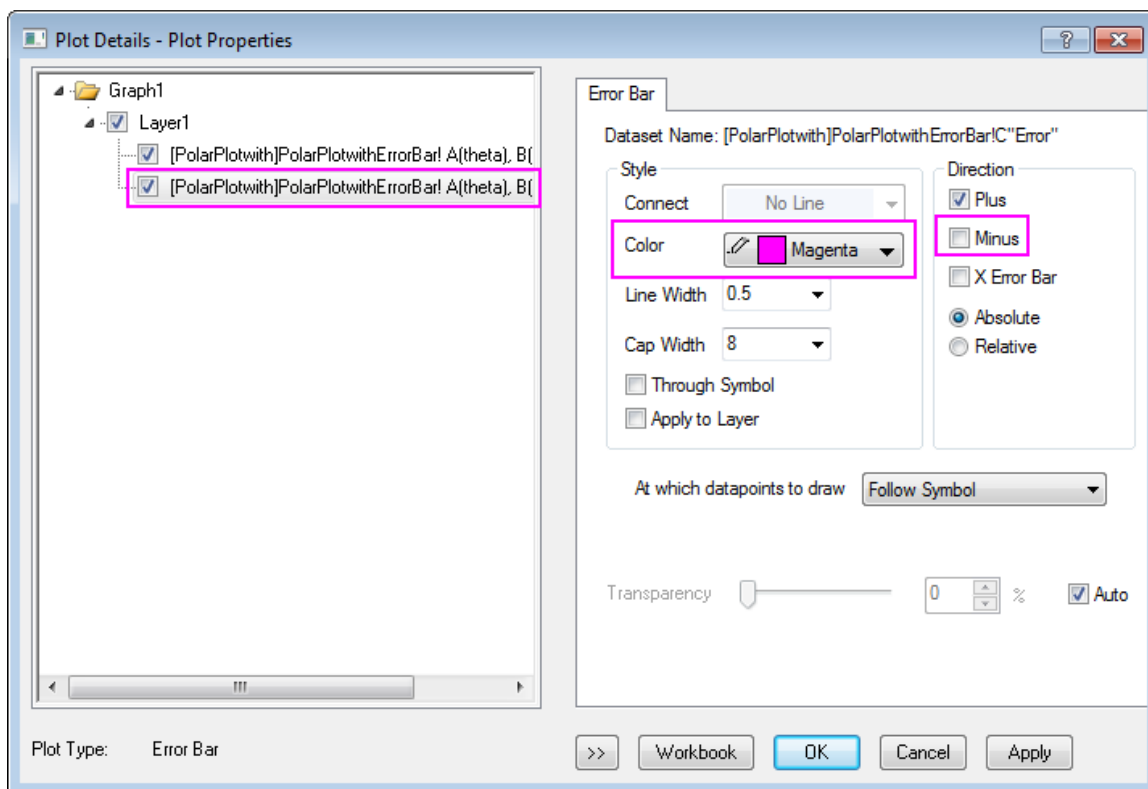

5. If the left panel of **Plot Details** is hidden, click the button with the two arrows on the bottom left of the dialog box. The left panel presents a tree-view display of the layer and data the user is modifying. It also displays a **Plot Type** list at the bottom. Use the **Plot Type** list to change the plot from **Line** to

**Scatter.** This will change the tabs on the right panel and add a **Symbol** tab. In the Symbol tab, change the symbol style, color, and transparency as shown below. To select the symbol color, use the **Individual Color** option in the **Symbol Color** button. Click **OK** to close the dialog.

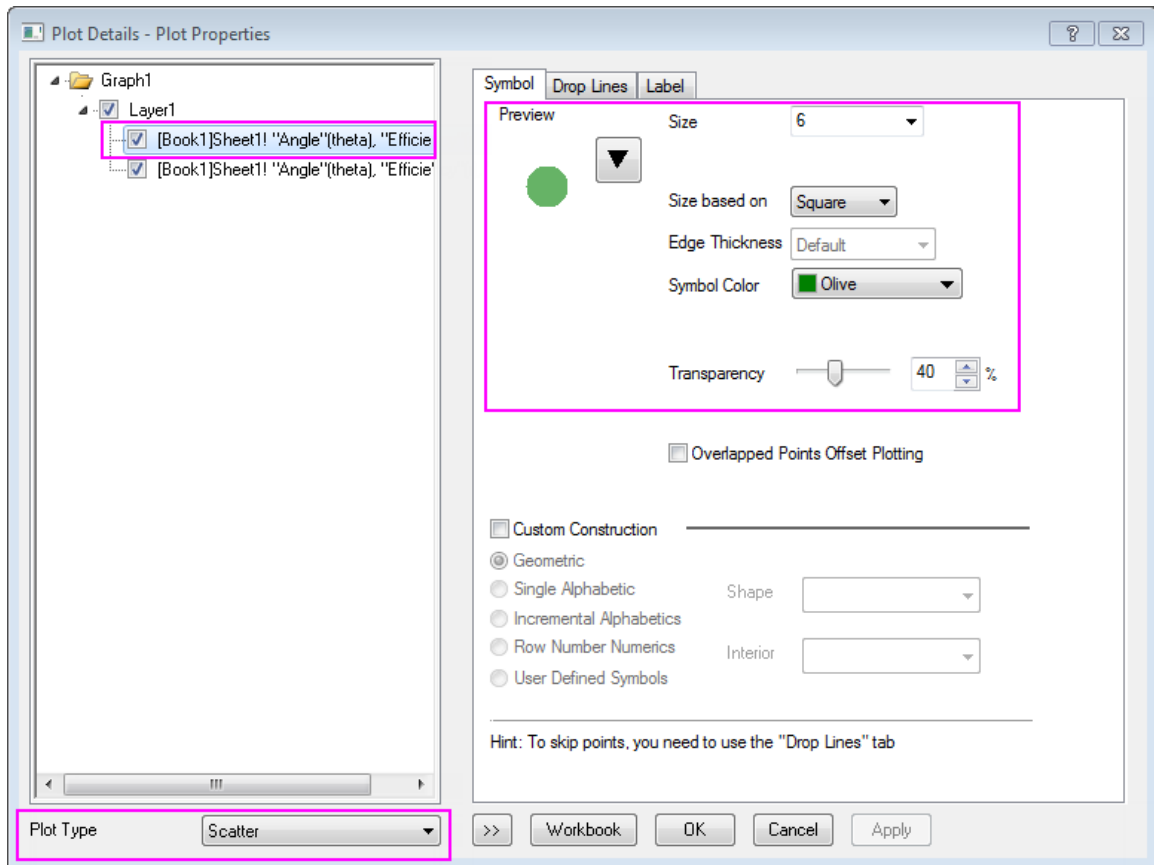

- The next step is to modify the radial axes grid lines. These are the circular grid lines between the inner and outer angular axes. Double-click the vertical axis on the left side of the graph, (i.e. the Radial Axis) to open the **Axis** dialog. In the **Grids** page, choose **Radial** on the left panel. Change the Major Grids Line **Style** to **Dash**, and then clear the Minor Grids **Show** check box as shown below:

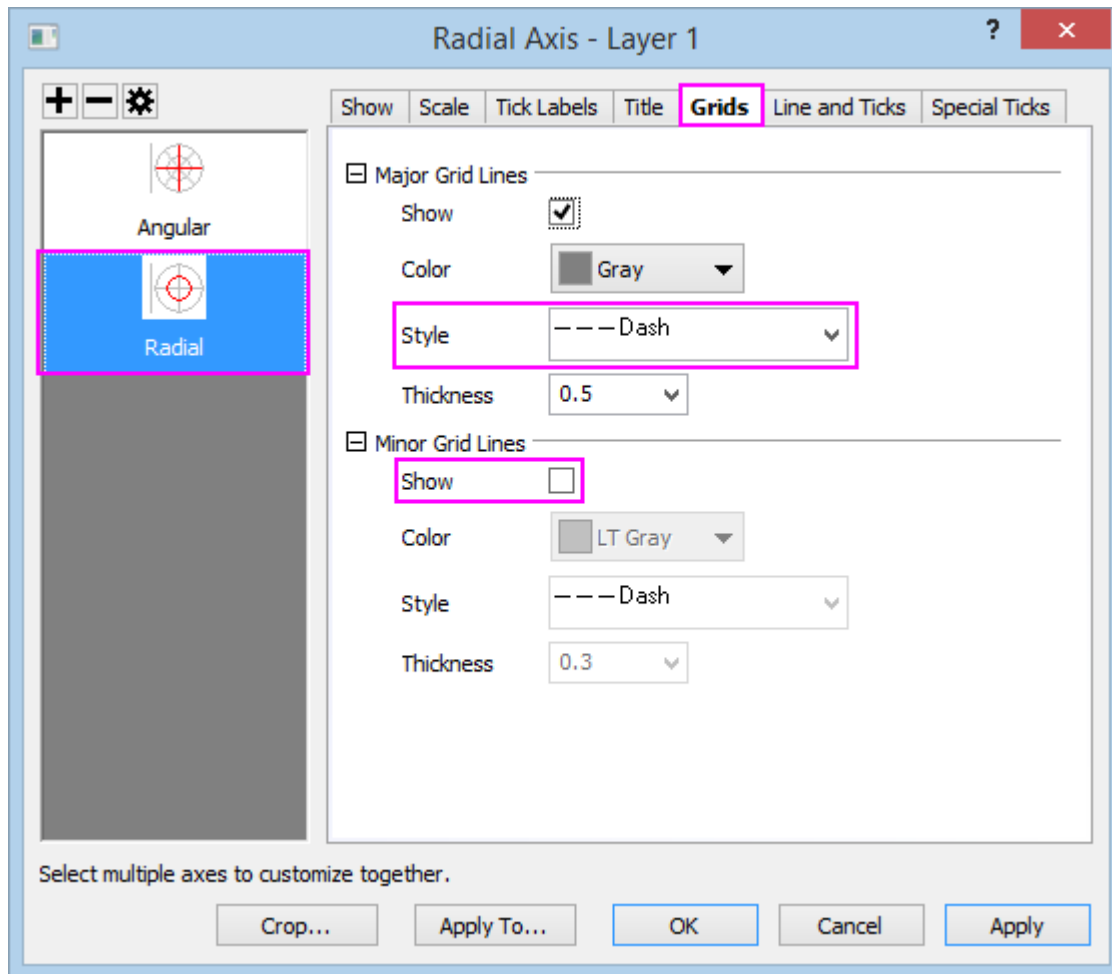

- Use the same procedure to modify the angular axes grid lines, the grid lines that radiate out from near the center of the plot to the edges. In the **Grids** page, choose **Angular** on the left panel. Change the Major Grids Line **Style** to **Dash**, set **Start at** to **Radial Start**, and then clear the Minor Grids **Show** check box. **OK** to save changes.

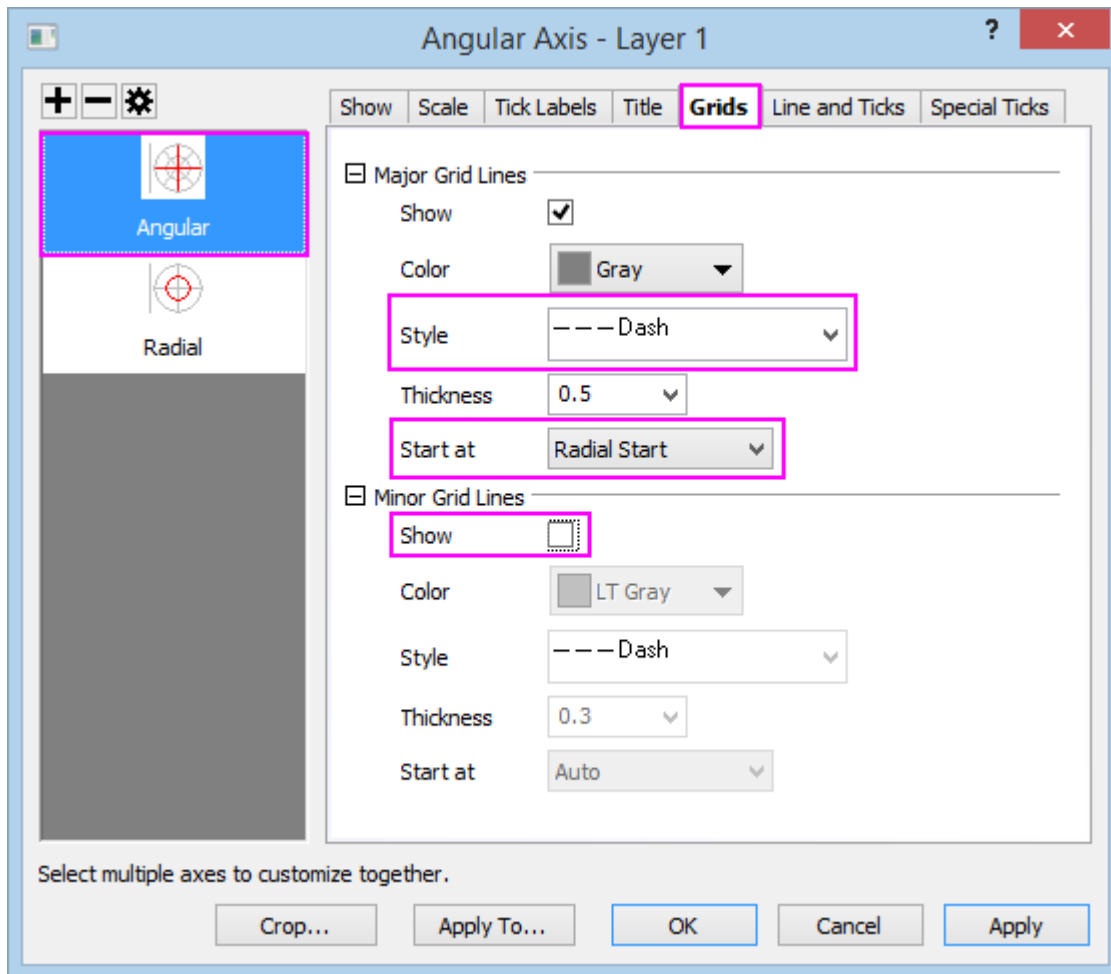

8. The completed polar plot should appear as shown below:

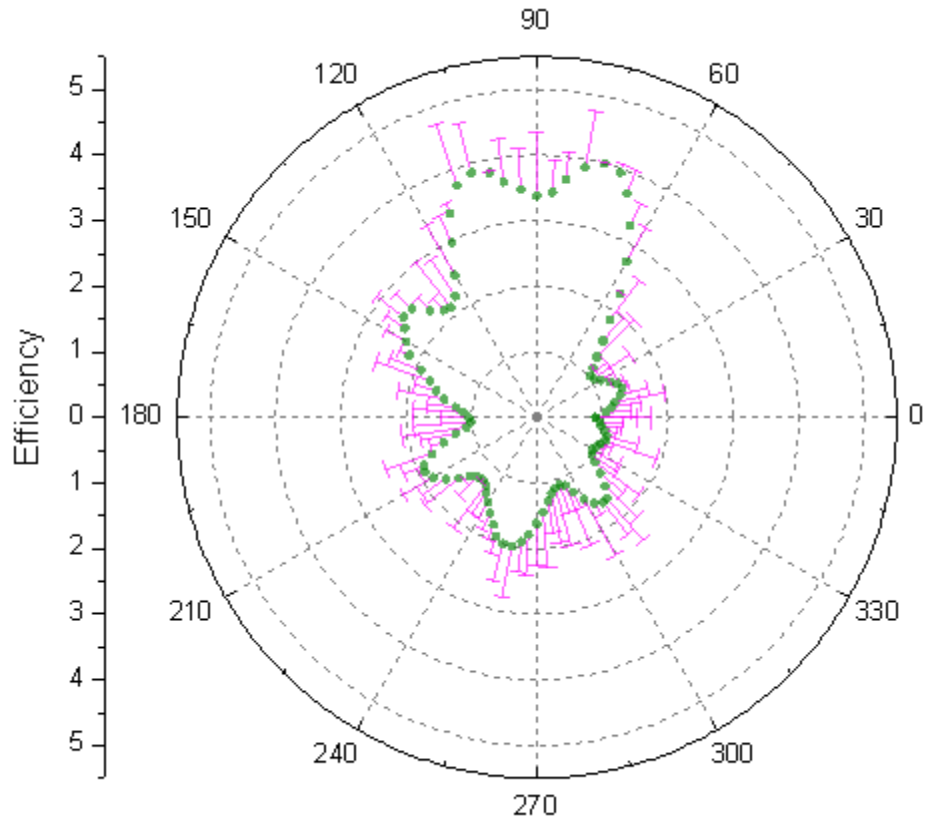

### 6.12.4 Polar Crop

#### 6.12.4.1 Summary

This tutorial will demonstrate how to create a cropped polar graph:

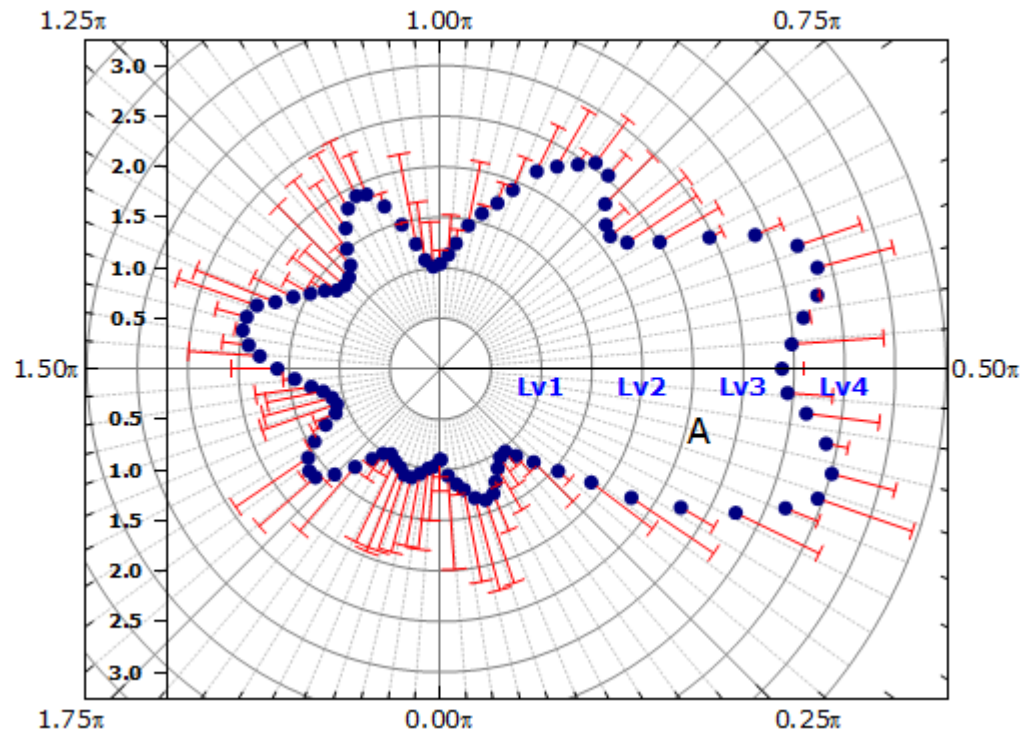

Minimum Origin Version Required: 2015 SR0

#### 6.12.4.2 What You Will Learn

This tutorial will show you how to:

- Customize the axes settings for a polar graph
- Crop the graph to show only a portion of the data

#### 6.12.4.3 Steps to Create the Polar Graph and Customize the Axes

This tutorial is associated with the Tutorial Data project: <Origin EXE Folder>\Samples\Tutorial Data.opj. You can refer to this graph in Learning Center. (Select **Help: Learning Center** menu or press **F11** key, and then open **Graph Sample: Polar Graphs**)

1. Open the **Tutorial Data** project, and browse to the folder *Polar Crop* in Project Explorer. Open the workbook **Book1AK**.
2. Highlight all the columns and choose **Plot > Specialized: Polar theta(X)r(Y)** from the main menu to create a polar graph:



3. Custom the **Angular Axes**

- The data is difficult to interpret since the range is too small to be adequately represented in a 360 degree plot (Origin sets units to degrees by default). Double-click on the axis to open the **Axis Dialog**. Go to **Scale** tab and choose **Angular** in the left panel. Expand **Units Definition** node and select the **Units** to **Radians** from the drop down. Change the **Value** option under **Major Ticks** to **0.25**, **Count** under **Minor Ticks** to be **9**.



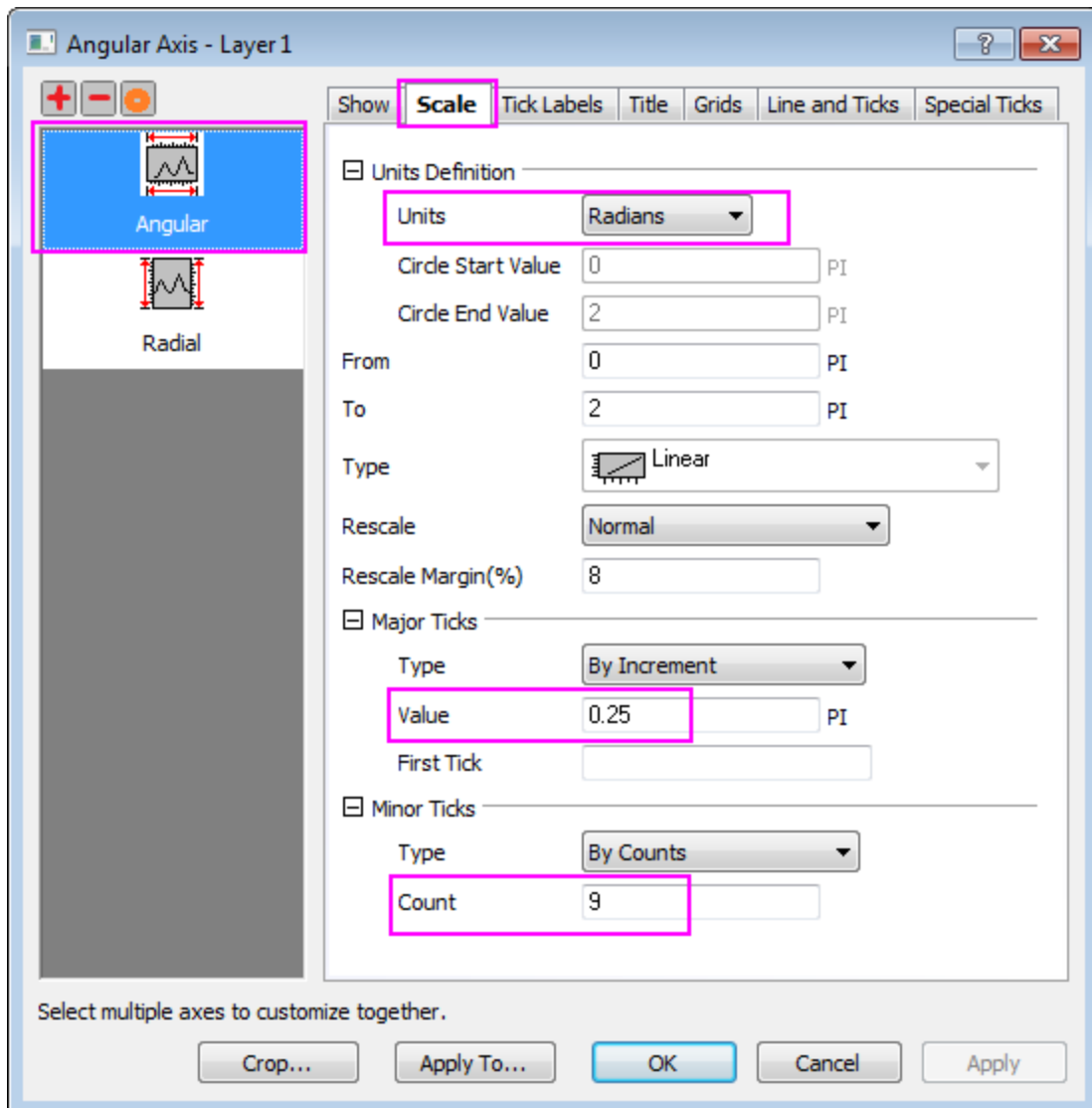

- To change the orientation of the plot, go to **Show** tab and make sure the **Angular - Outer** is selected in the left panel. Set **Direction** to **Counter Clock-Wise** and the **Axis Start at(deg)** to **270** as shown below:

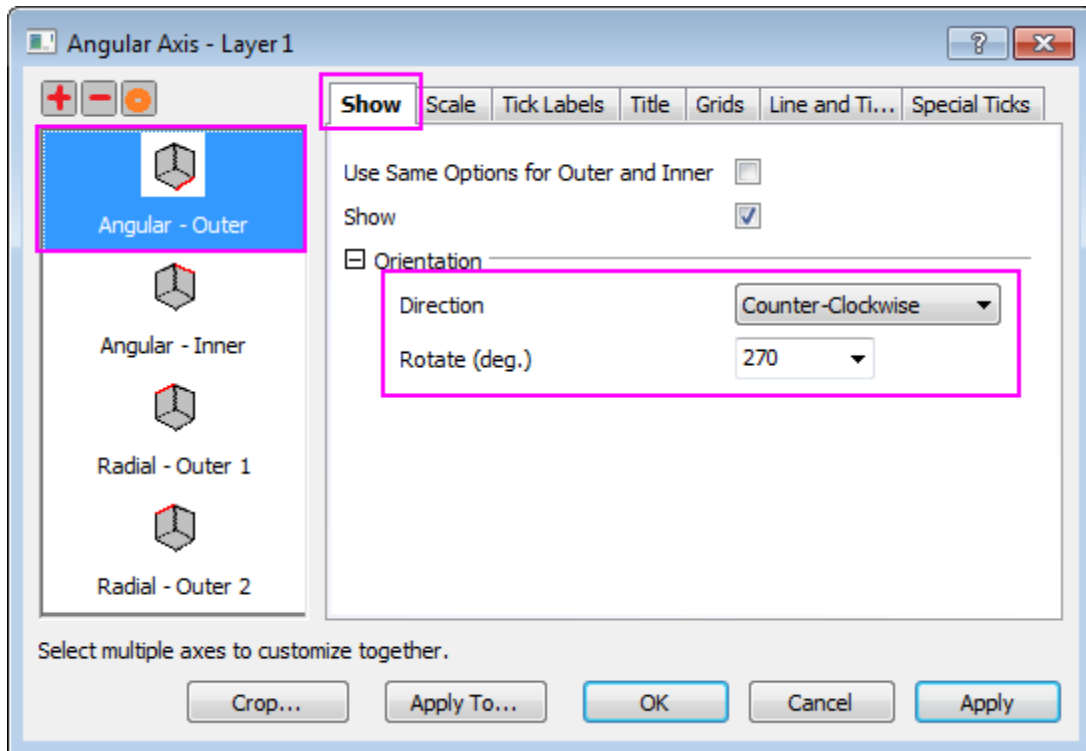

4. Custom the **Radial Axes** scale
  - Go to the **Scale** node and choose the **Radial** in the left panel. Change the **To** value to 5.01 (the 0.01 will show the last tick), the **Value** option under **Major Ticks** to **0.5** and the **Count** option under **Minor Ticks** to **0**.

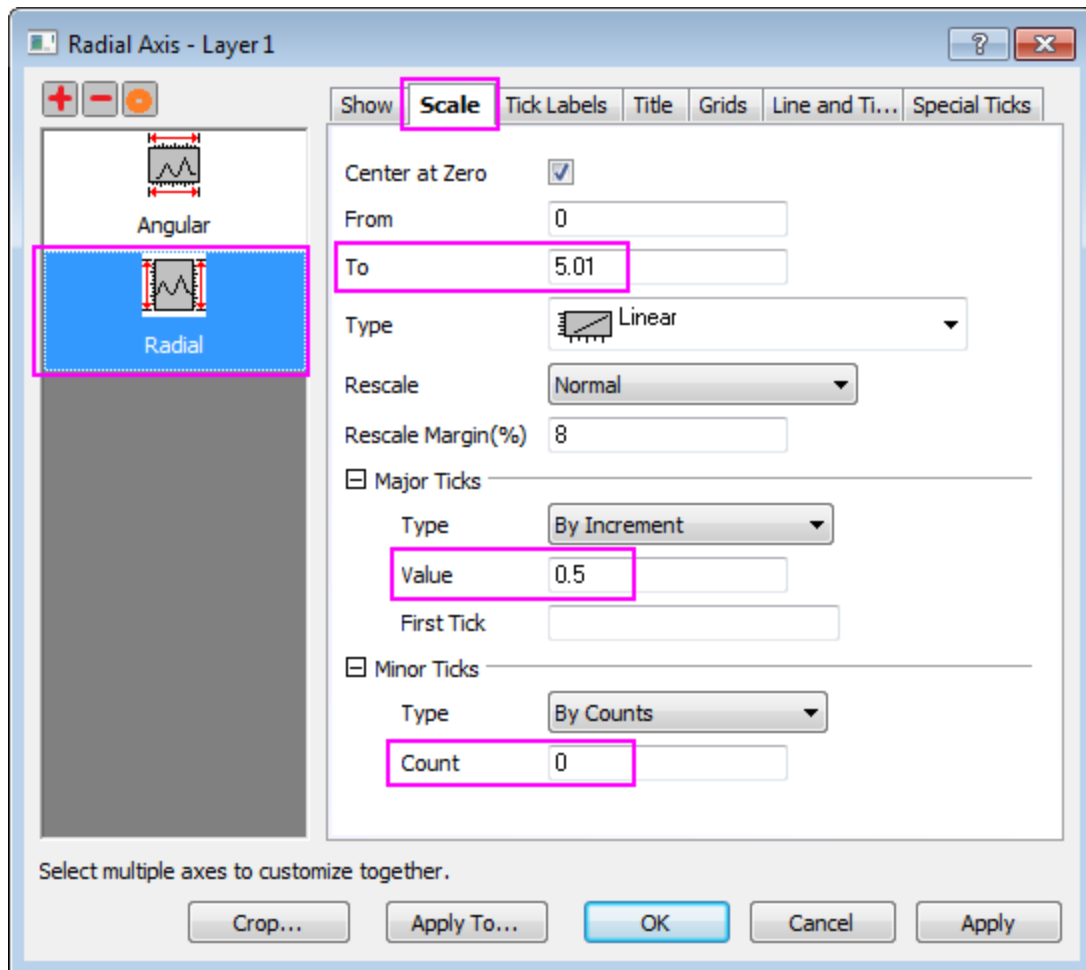

5. Add a **Inner Radial Axis**

- In the **Show** tab, click on the **Add a radial axis** button on the top of the left panel. Then the **Radial - Inner Axis 1** is added in the left panel.
- To change the orientation of the new inner axis from vertical to horizontal, under **Axis Position** section, set the **Reference** as **Clock Dial** and the **Clocks** option as **3 O'Clock**. Select the **Negative** radio button to shift the tick labels to the opposite side of the axis:

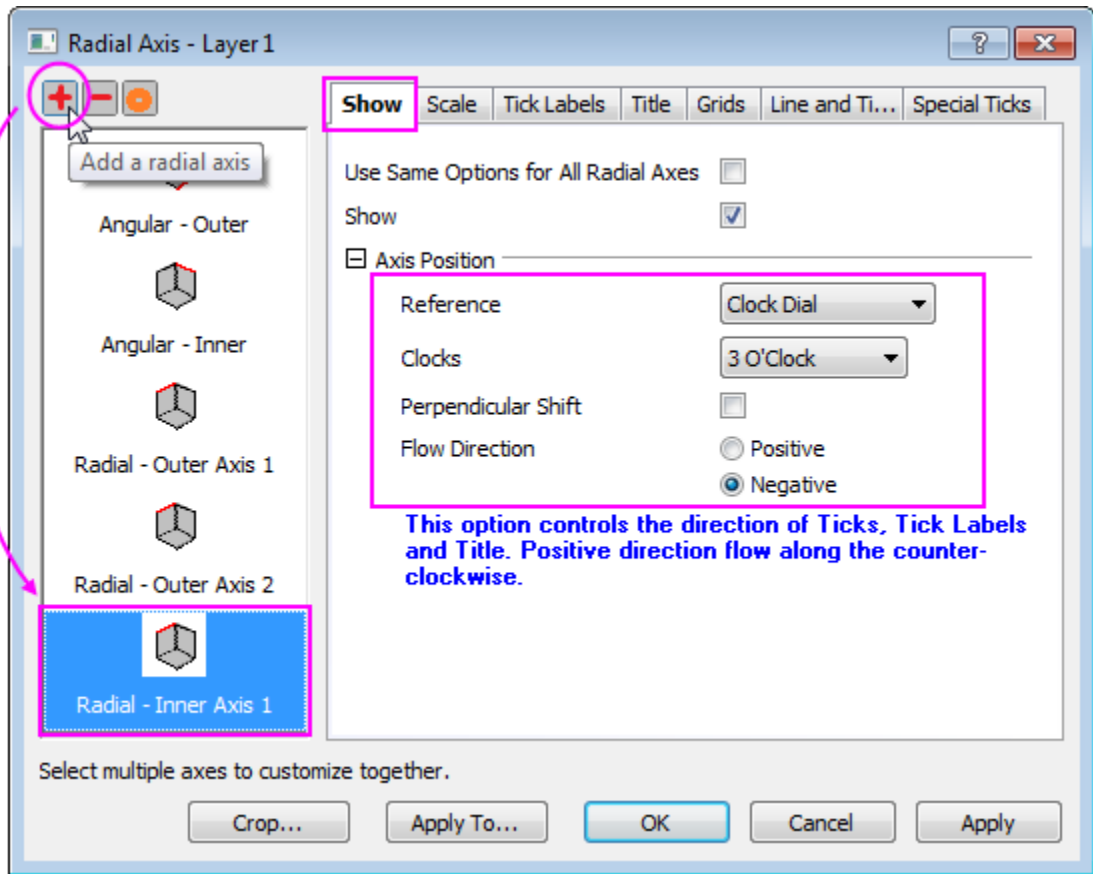

- To add tick labels on **Inner Axis 1**, go to **Tick Label** tab, under **Display** subtab and select **Tick-indexed string** from the **Type** drop-down. Type `0A " " Lv1 " " Lv2 " " Lv3 " " Lv4` in the **Display** edit box (Spaces within the double quotation marks are to indicate no text label at this tick, so that only every second tick is labelled). Set the Formatting options as shown below:

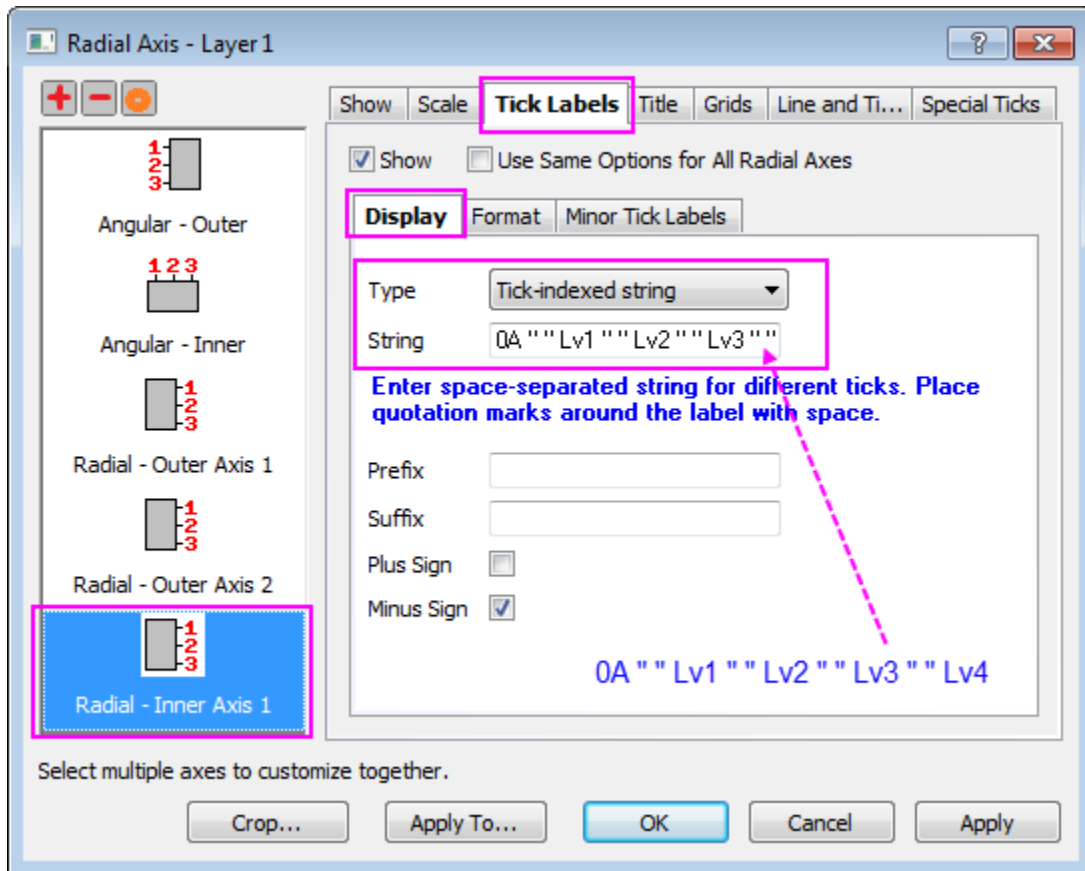

- Go to the **Format** subtab and change the tick label format as below:

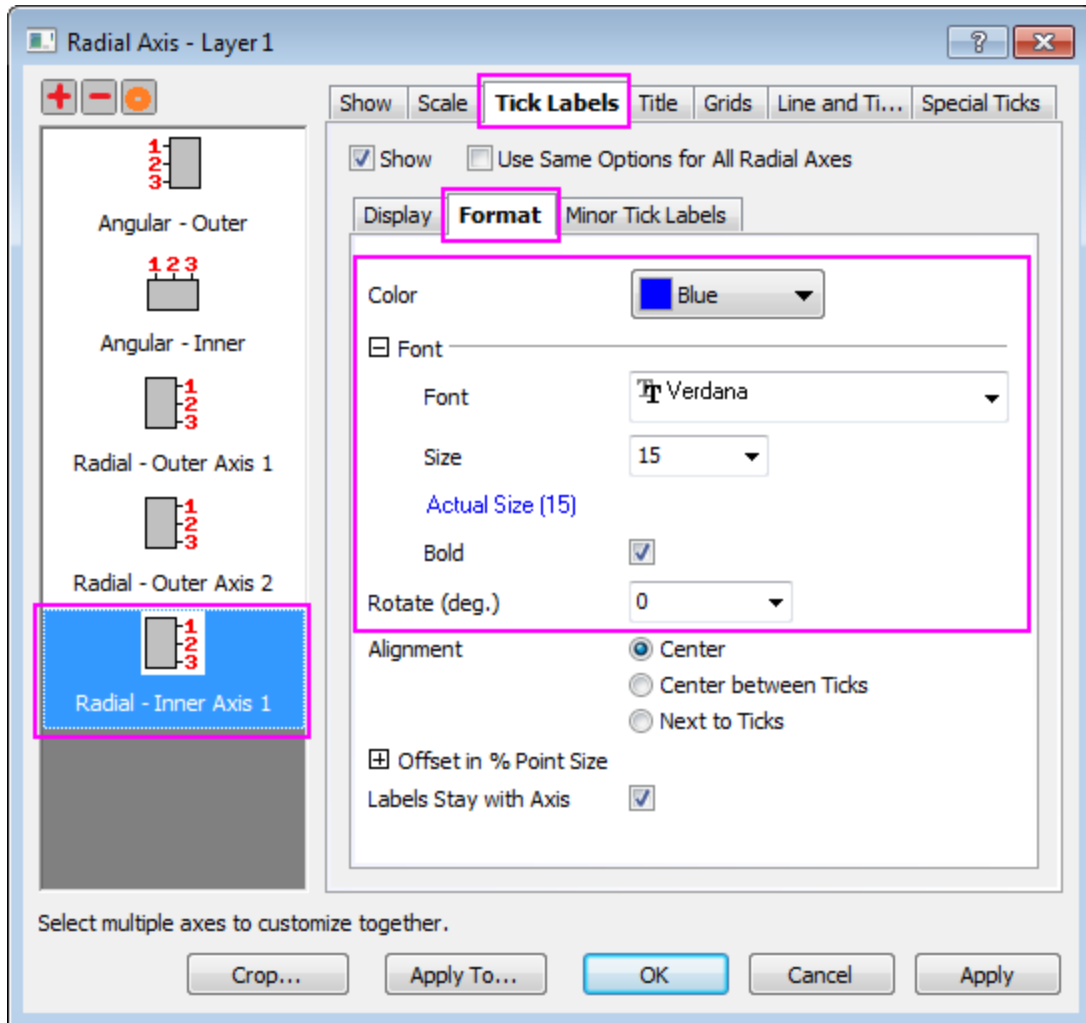

- Go to **Special Ticks** set **Axis Begin** and **Axis End** to **Hide**. Click **OK** to close the dialog and these settings should create an axis as shown below:

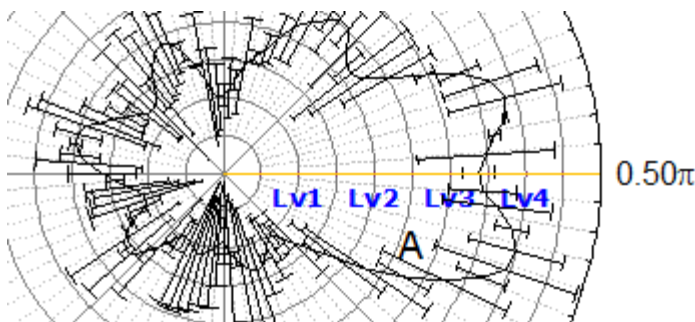

6. Custom the position of **Outer Radial Axes**
  - Double click on the axis to bring up **Axis** dialog again. Go to **Show** tab, and select **Radial - Outer 1** in the left panel. Set **% of Radius** to **-46**.

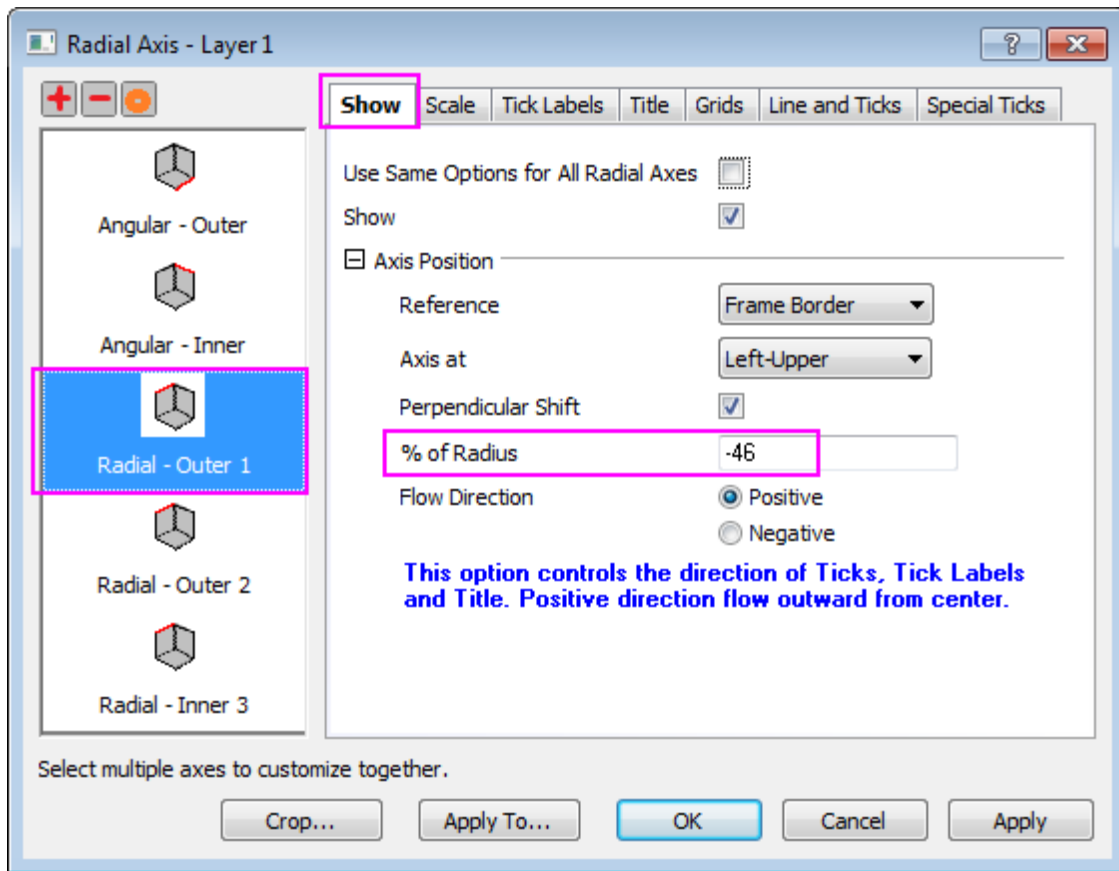

- Go **Special Ticks** tab, set the **Axis Begin** option to **Hide** for **Radial - Outer 1** axis.

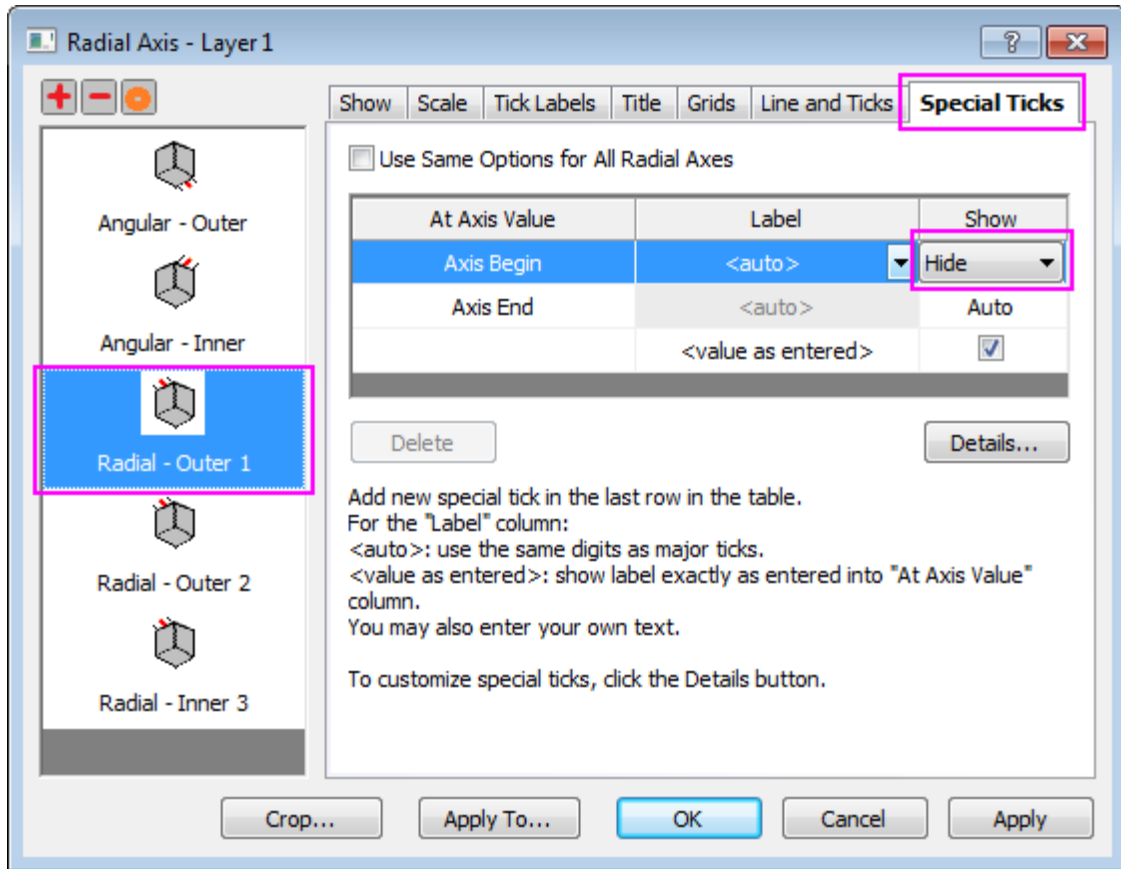

- Repeat the above two steps for **Radial - Outer 2** and click **OK** to exit the dialog box.

#### 6.12.4.4 Steps to Crop the Polar Graph

The crop tool allows you to magnify and emphasize any particular section of the polar plot.

1. Double click on any axis to open the Axis Dialog again. Click on the **Crop...** button to open the **Miscellaneous** dialog. Check the **Enable** box and set the values shown in the image below. Click **OK** to exit the dialog box.



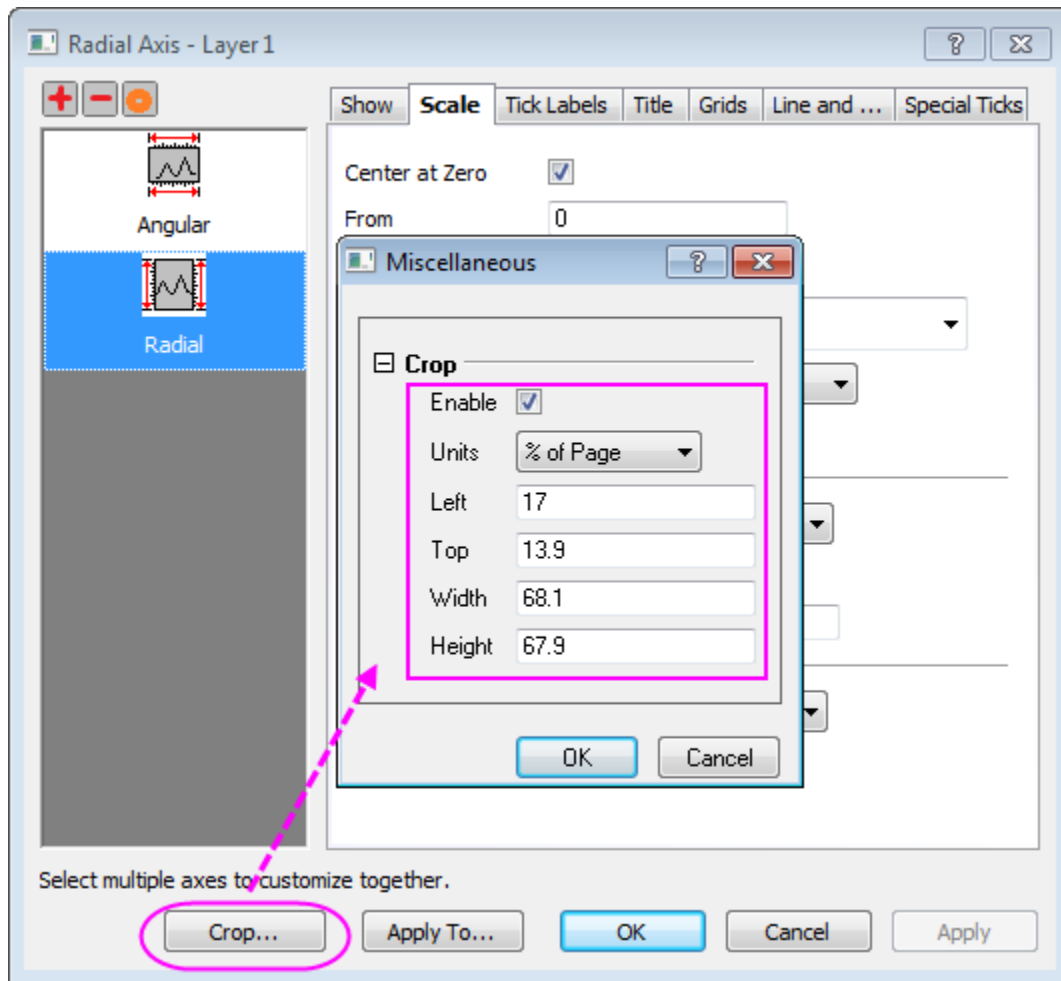

2. The graph will now appear as shown below:

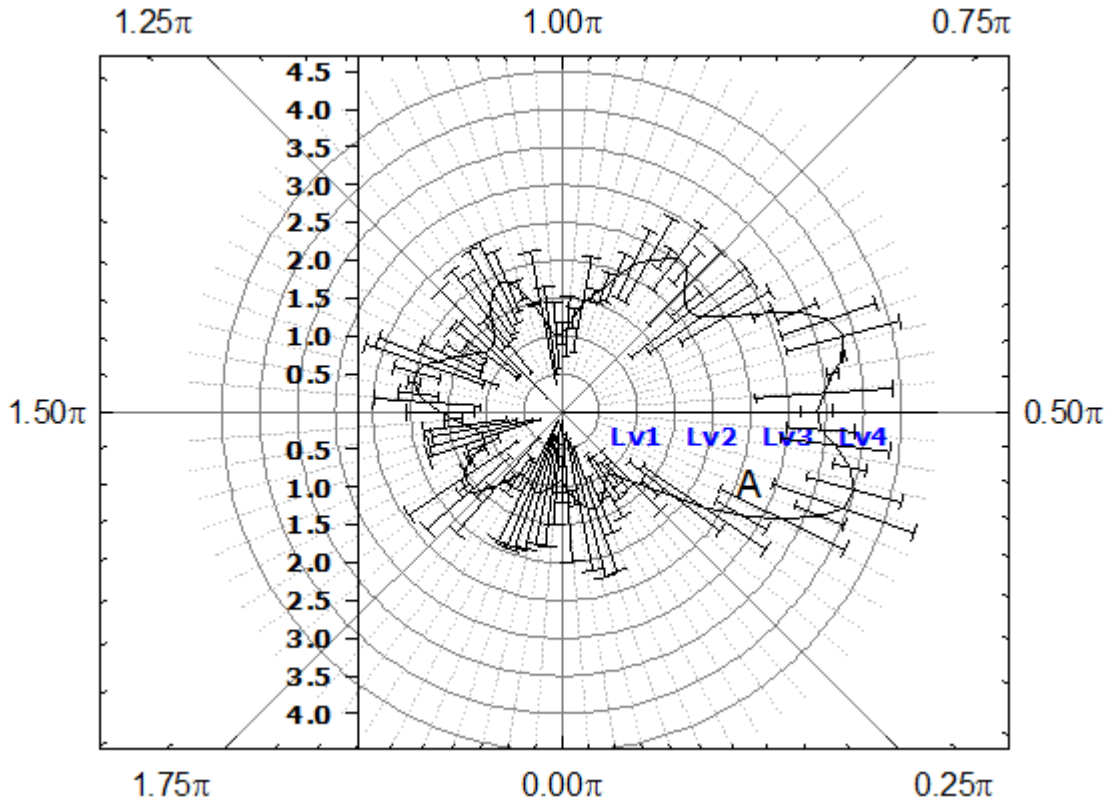

- In order to change the layer size to match the sample project select **Format: Layer** from the main menu to open the **Plot Details** dialog. In the **Size/Speed** tab, set the following values:

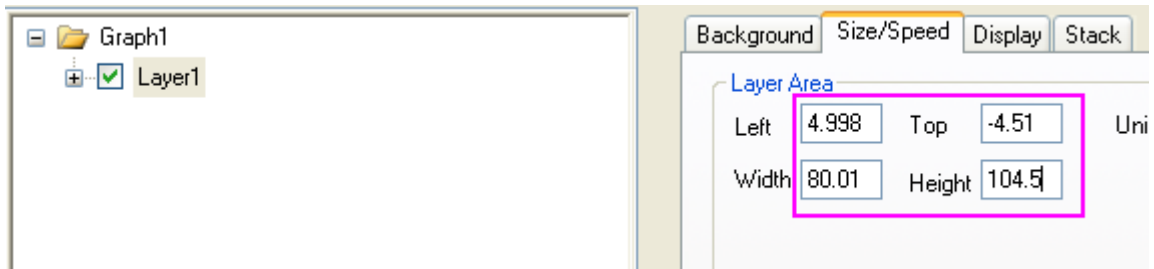

- Expand **Layer1** and select the first data set. Use the **Plot Type** drop-down on the bottom left of the dialog to change the plot to scatter. Customize the symbol shape and color to resemble the final image (symbol color = Navy, symbol shape = filled circle, error bar color = red).
- To remove the negative error bars as in the sample, select the second dataset under **Layer1**. In the **Error Bar** tab on the right, clear the **Minus** box as shown below. The error bar color and thickness can also be adjusted here. **OK** to exit the dialog box.

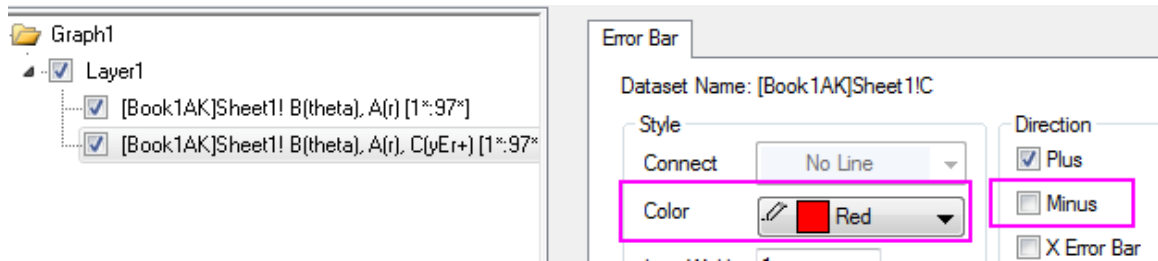

6. The final graph should appear as shown below. Delete any unwanted legends and the axis title by selecting them and pressing the **Delete** key:

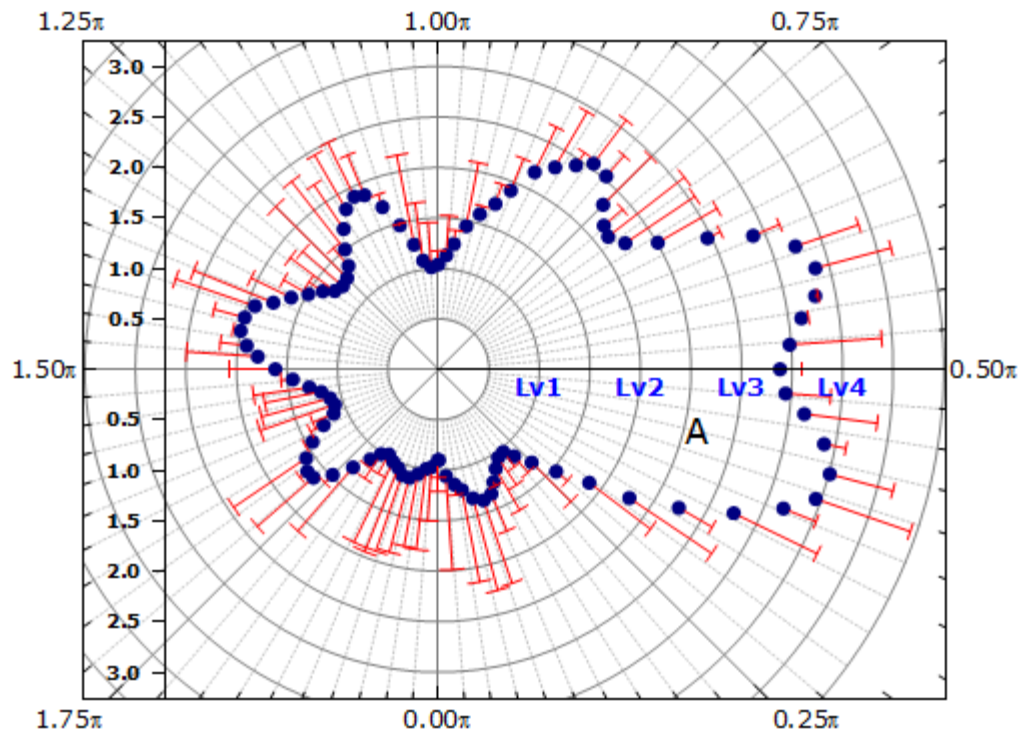

## 6.12.5 Polar Graph with Custom Radial Axes

### 6.12.5.1 Summary

Origin's polar axis dialog allows for flexible customization of both angular and radial axes.

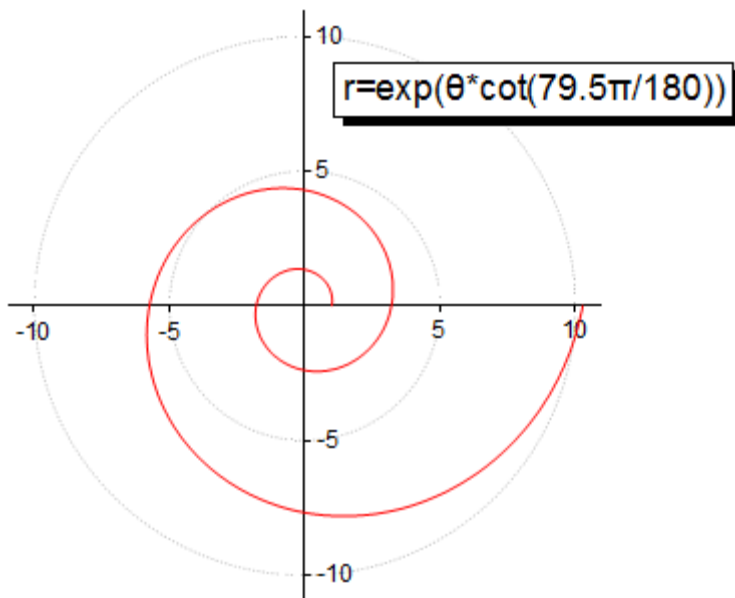

Minimum Origin Version Required: 2015 SR0

#### 6.12.5.2 What You Will Learn

This tutorial will show you how to:

- create a polar graph
- hide angular axis
- customize radial axis

#### 6.12.5.3 Steps

This tutorial is associated with <Origin EXE Folder>\Samples\Tutorial Data.opj.

##### 6.12.5.3.1 **Create a Polar without Angular Axis**

1. Open the Tutorial Data.opj file and browse to the *Custom Radial Axis* folder and activate workbook **Book1E**.
2. Highlight column B and select **Plot > Specialized : Polar theta(X) r(Y)** to generate a polar graph.
3. Select the legend object and delete it.

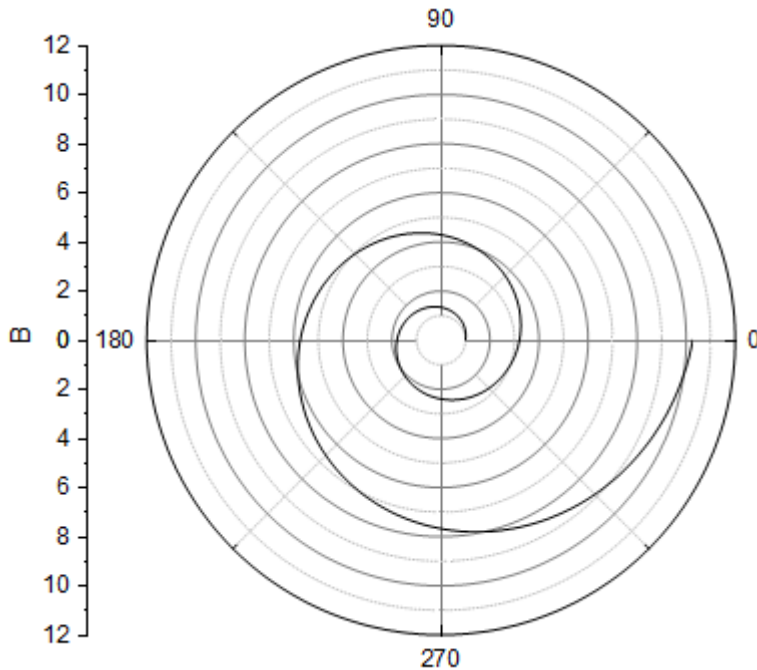

4. To hide the Outer axis (the outer circle) of the polar graph, double-click on any axis to open the **Axis** dialog. Go to **Show** tab, select **Angular - Outer** in the left panel, and clear **Show** check box.

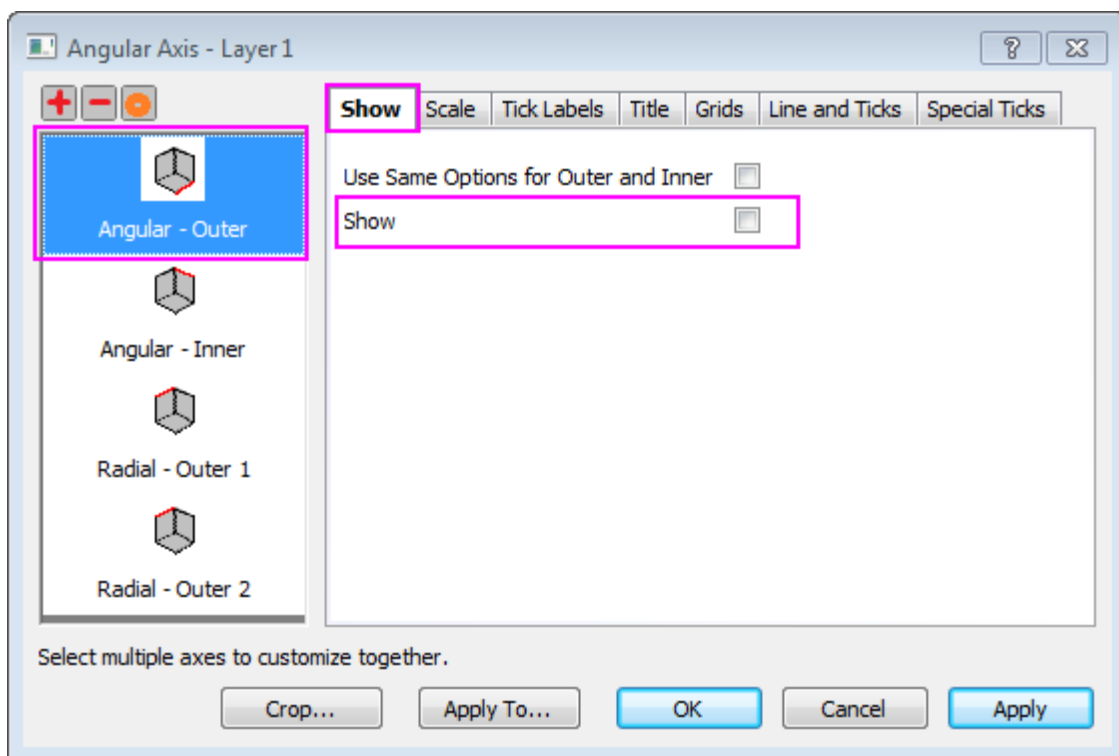

5. To hide all angular grid lines, go to **Grids** tab and make sure **Angular** is selected in the left panel. Clear the **Show** check boxes under **Major Grid Lines** and **Minor Grid Lines** section.

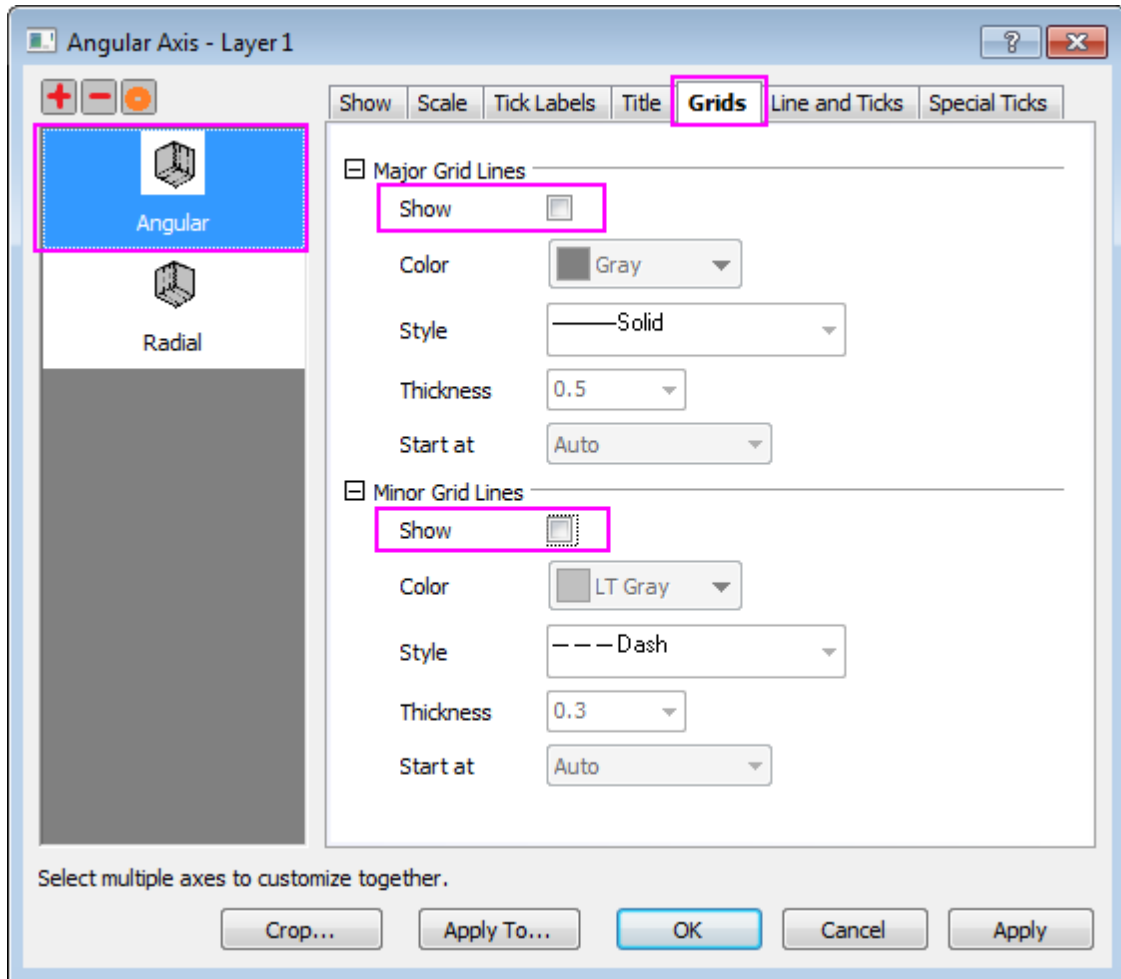

6. Go to **Scale** tab and select **Radial** in the left panel. Set the axis scale as shown below:

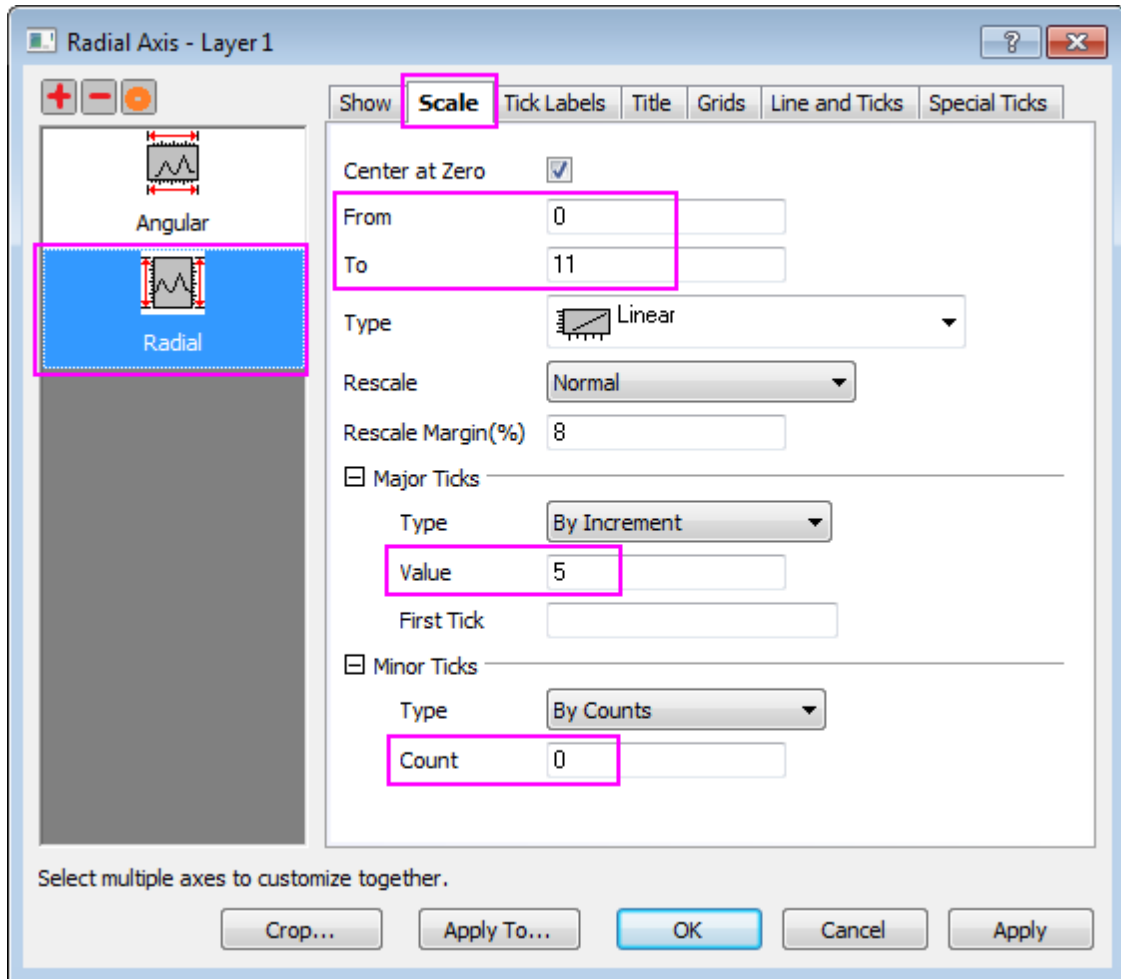

7. Go to the **Grids** tab and set as below:

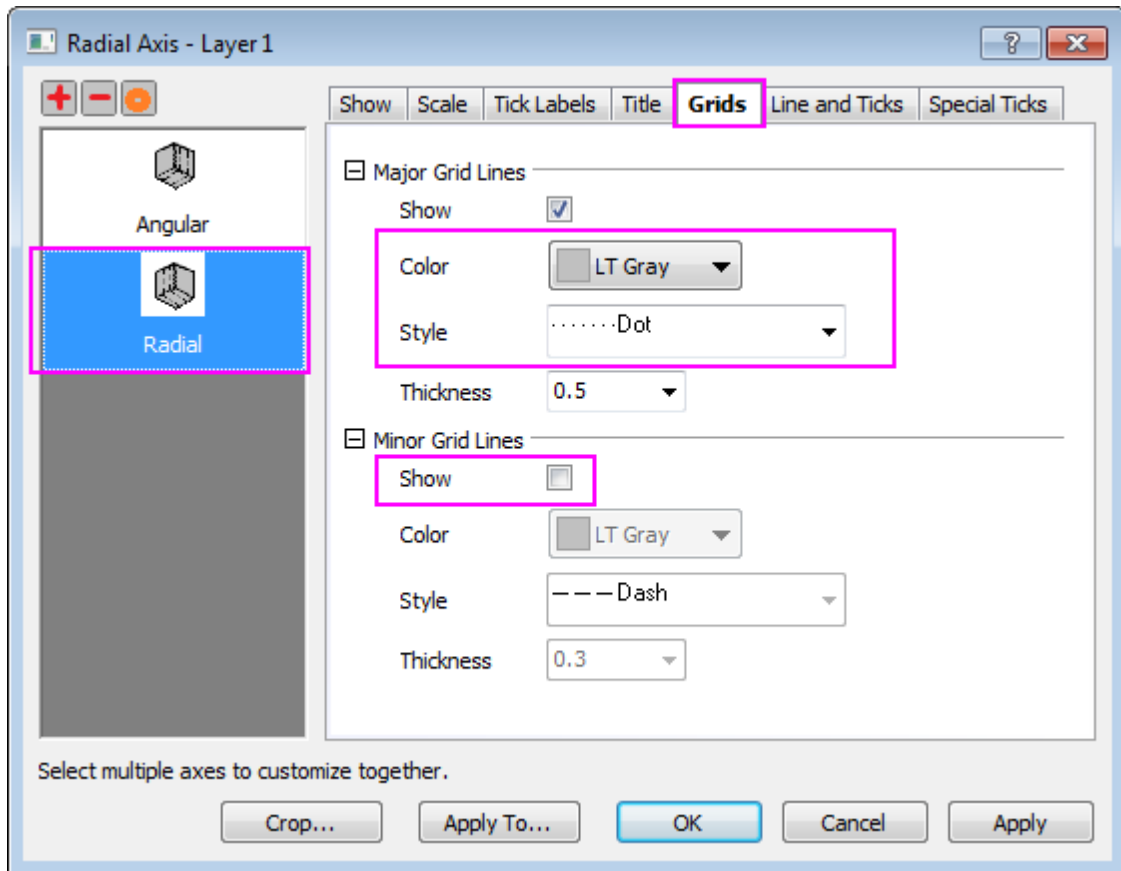

#### 6.12.5.3.2 Add Radial Axis on each Major Tick

1. To show radial axis on each major tick position of angular axis, click the '**Radial Axes Configuration**' button to open the dialog. In the dialog, check the **Major Ticks** option under the **Axes Inside Polar** section.



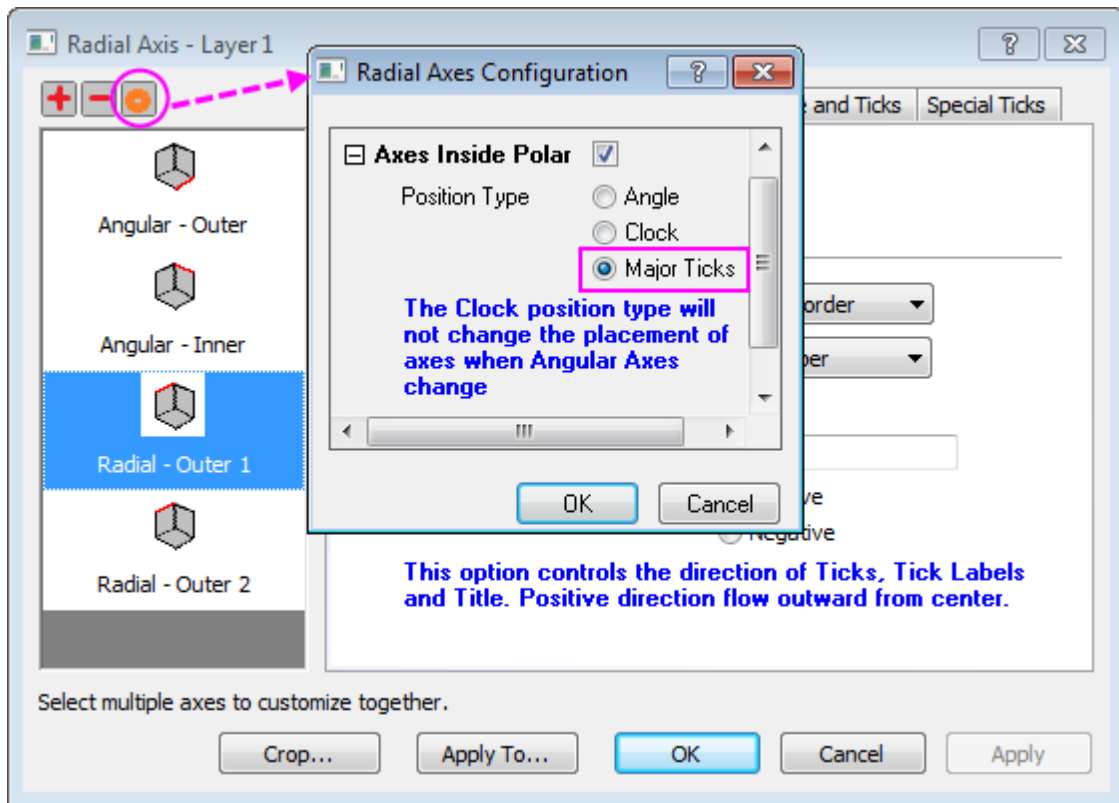

- To hide axis titles, go to **Title** tab and choose **Radial - Major Axes** in the left panel. Uncheck the **Show** check box. Click **Apply** button.

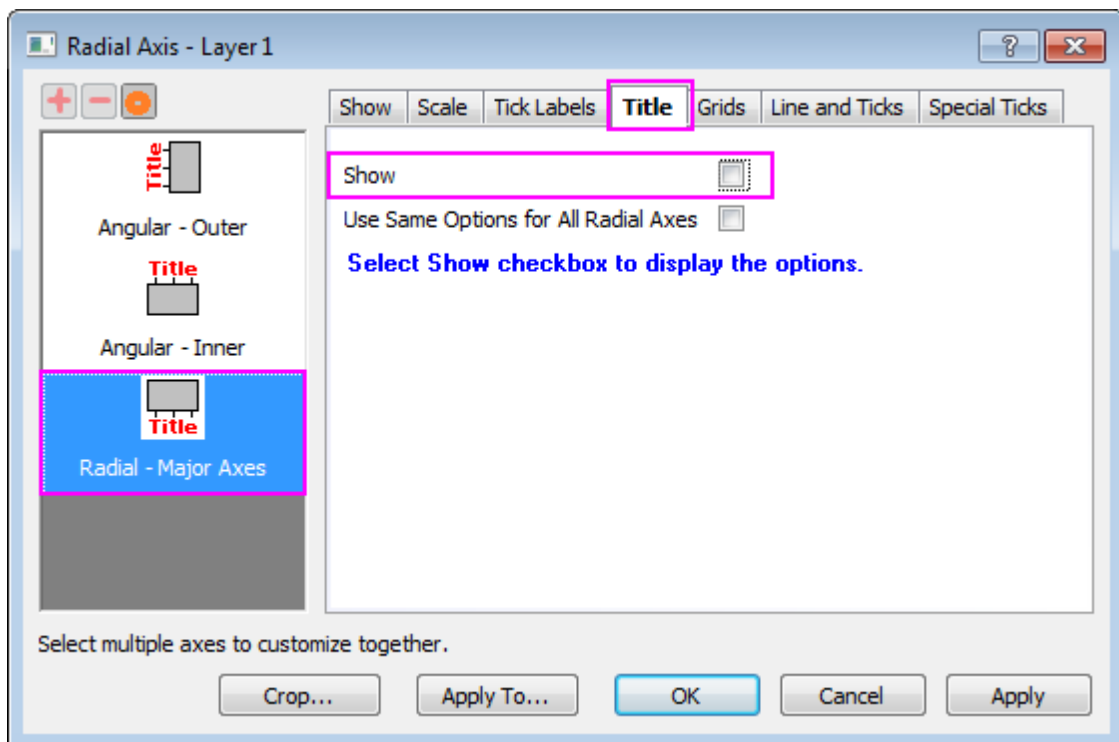

- There are 4 0's show in center of polar. To hide them, go to the **Special Ticks** tab. Select **Hide** from the **Axis Begin** drop-down list.

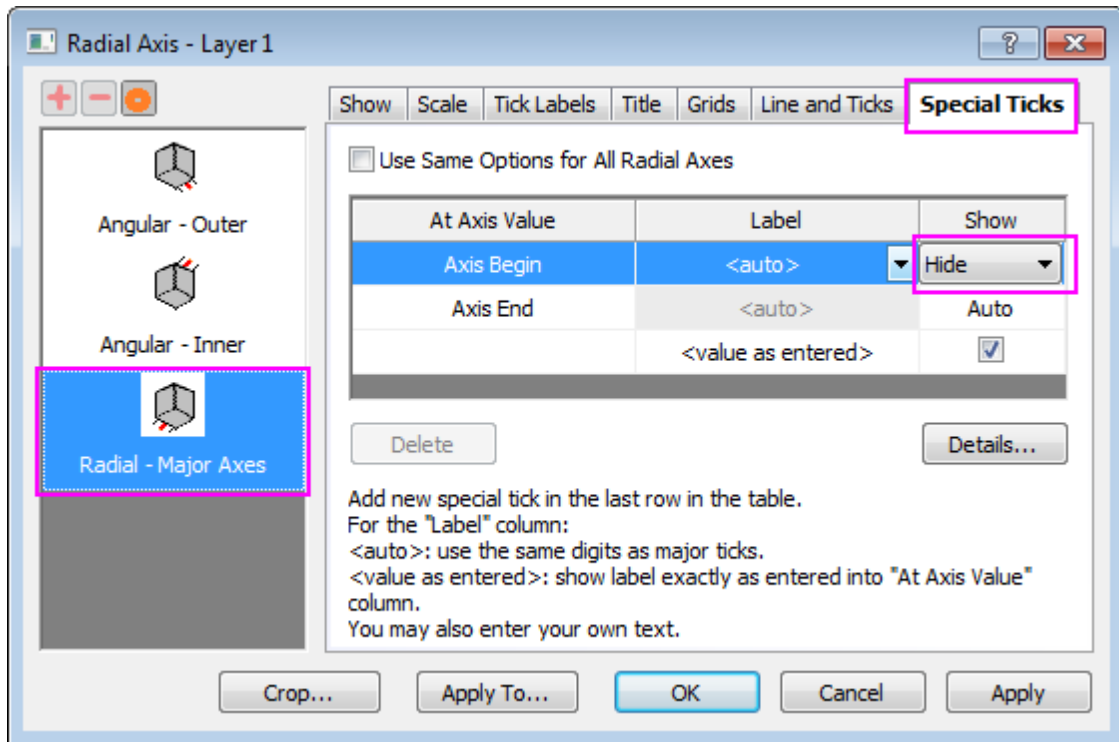

Click **OK** to close the dialog.

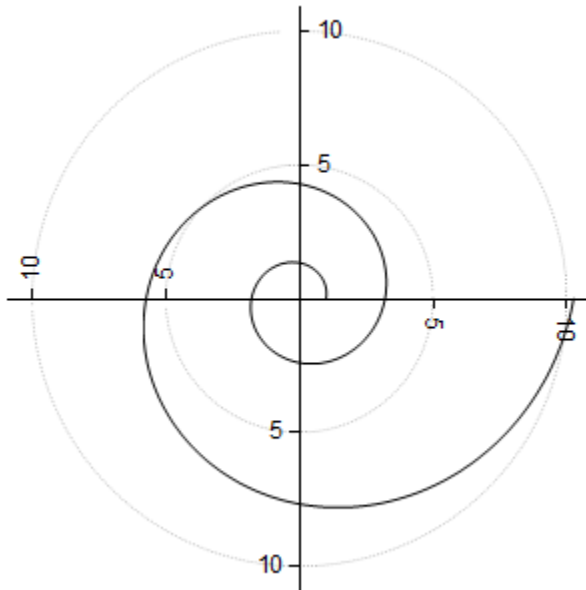

When radial axis is set to show on each major ticks, if you go to **Scale** tab of **Radial** and change major ticks, the radial axis will show in new major tick positions.

### 6.12.5.3.3 Use Configuration Dialog to Customize Radial Axis

Origin supports two kinds of radial axes. One is the frame border kind of axis around the polar graph. The other is inner axis from center of polar outwards.

1. Continue with the graph from the previous section, click on the **Radial Axes Configuration** button on the top of left panel. In **Radial Axes Configuration** dialog, under **Axes Inside Polar** branch, set **Angles List** as below, and click **OK** to close dialog.

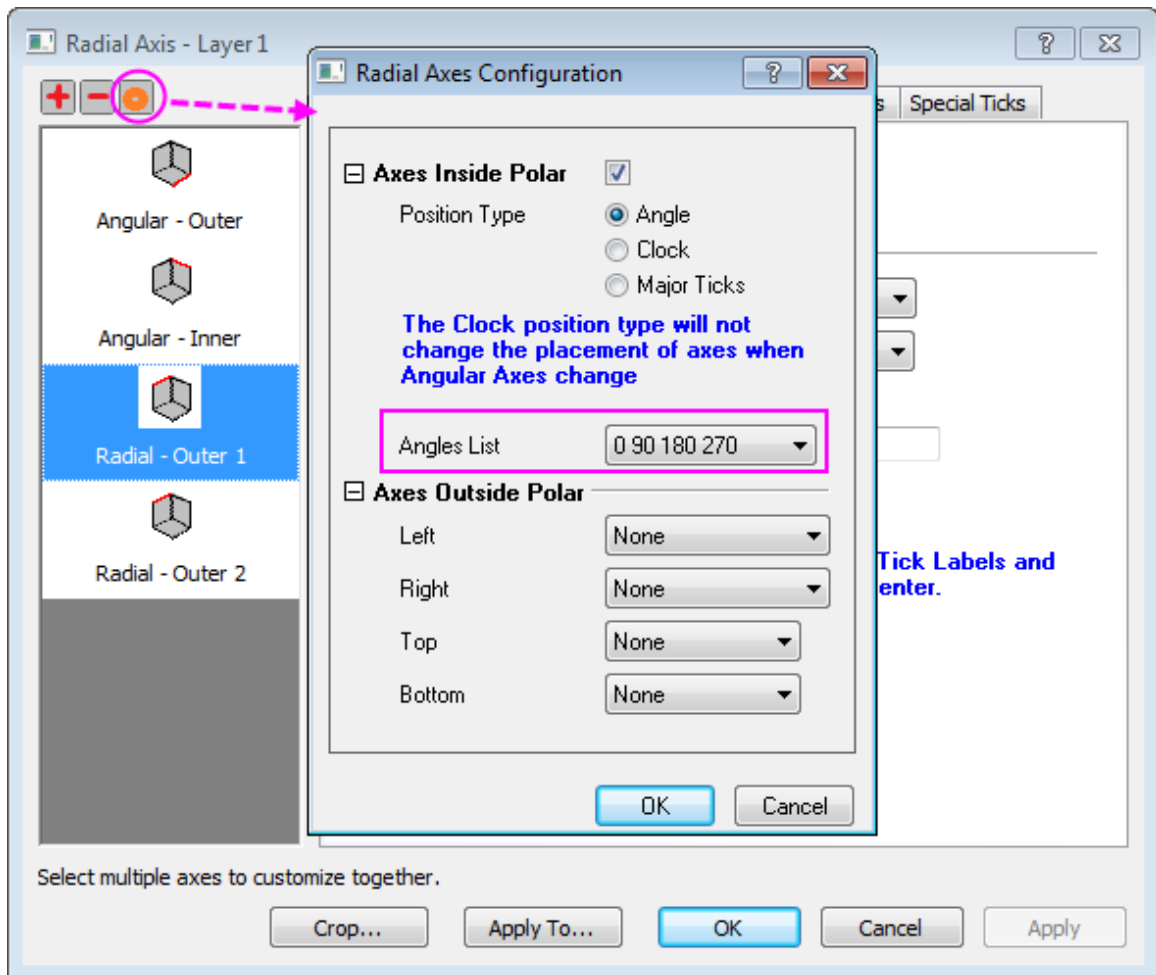

2. Click **Apply** button. Four radial inner axes show in the left panel.
3. Go to **Title** tab, select **Radial - Inner Axis1** in the left panel. Then check **Use Same Options for All Radial Axes** check box and clear the **Show** check box to hide all the titles. Then this setting will be applied to four radial axes.

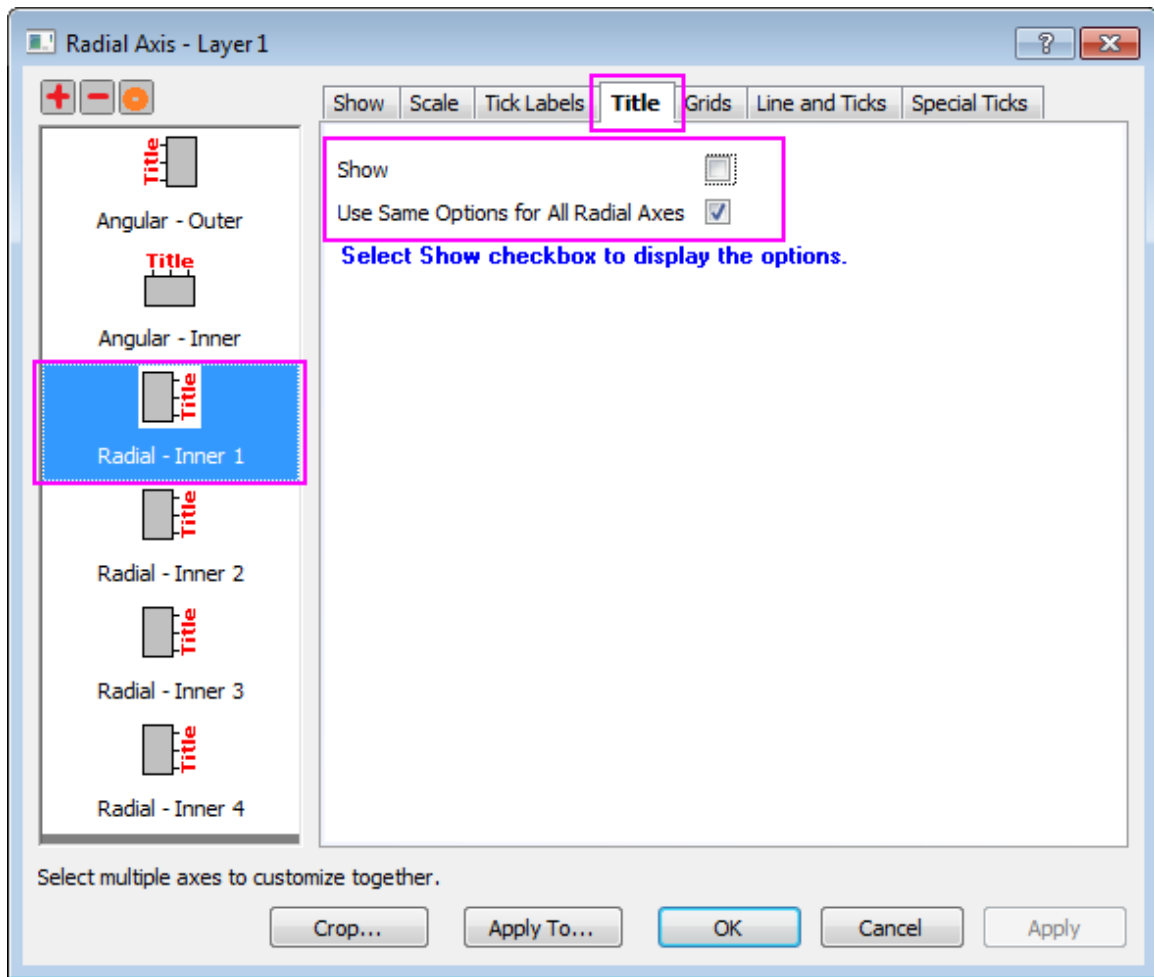

4. Go to **Tick labels** node and check **Use Same Options for All Radial Axes**. Under **Format** subtab, set **Rotate(dge.)** to be **0**.

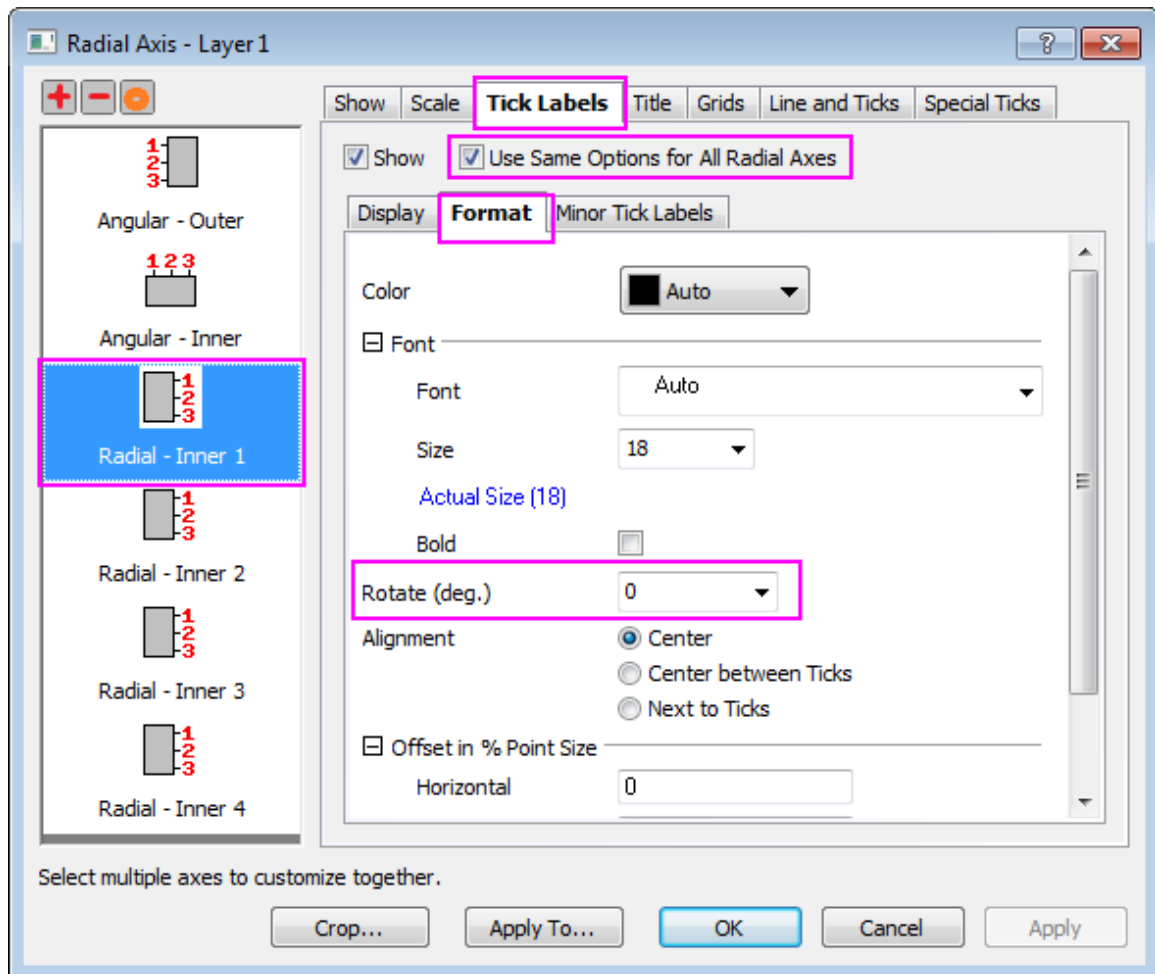

5. Go to the **Special Ticks** tab, and click **Use Same Options for All Radial Axes** check box. Set **Axis Begin** to **Hide**.
6. Go to **Show** tab, press **Shift** key to select **Radial - Inner Axis 3** and **Radial - Inner Axis 4** two axes, change **Flow Direction** to **Negative** under **Axis Position** section.

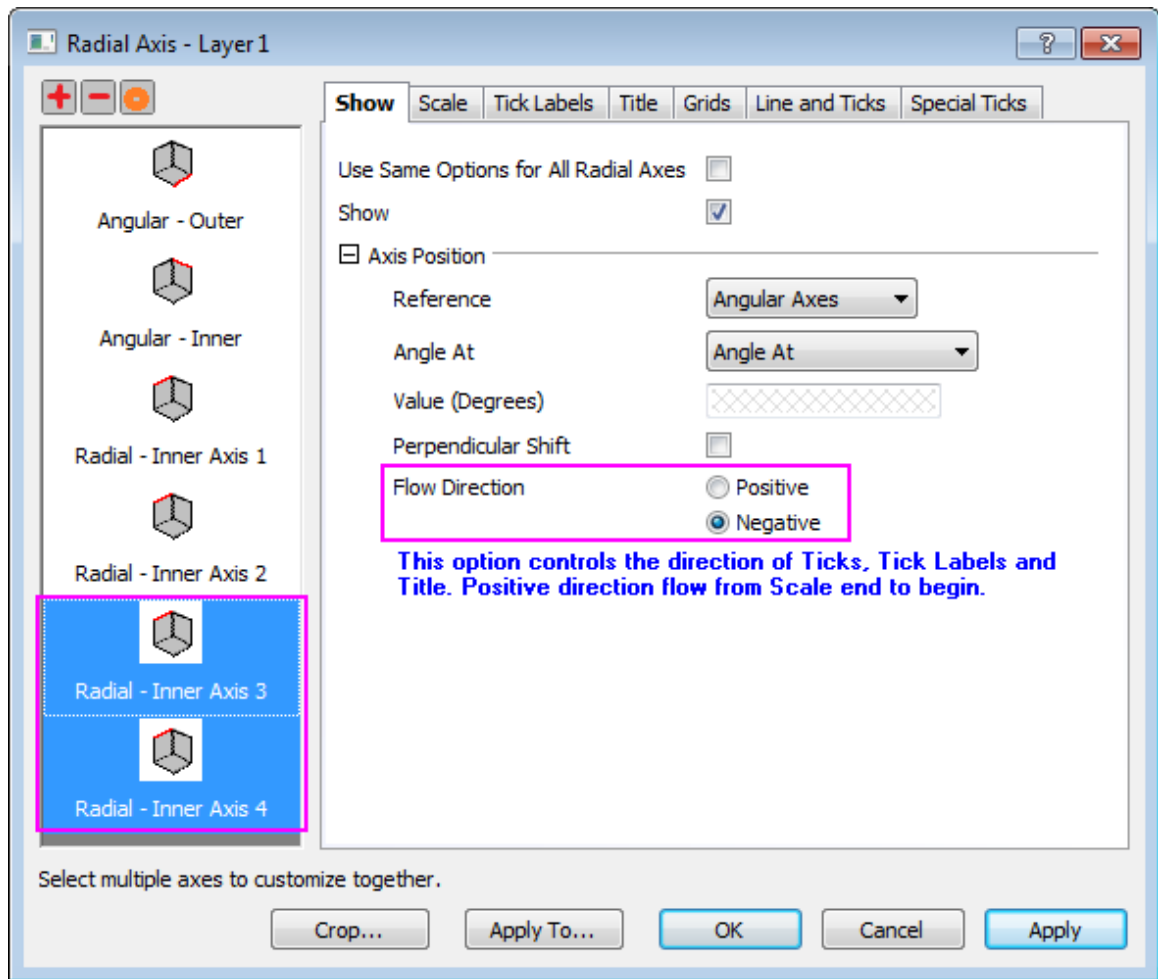

7. Go to **Tick labels** tab, enter a minus sign(-) in the **Prefix** edit box under the **Display** subtab.

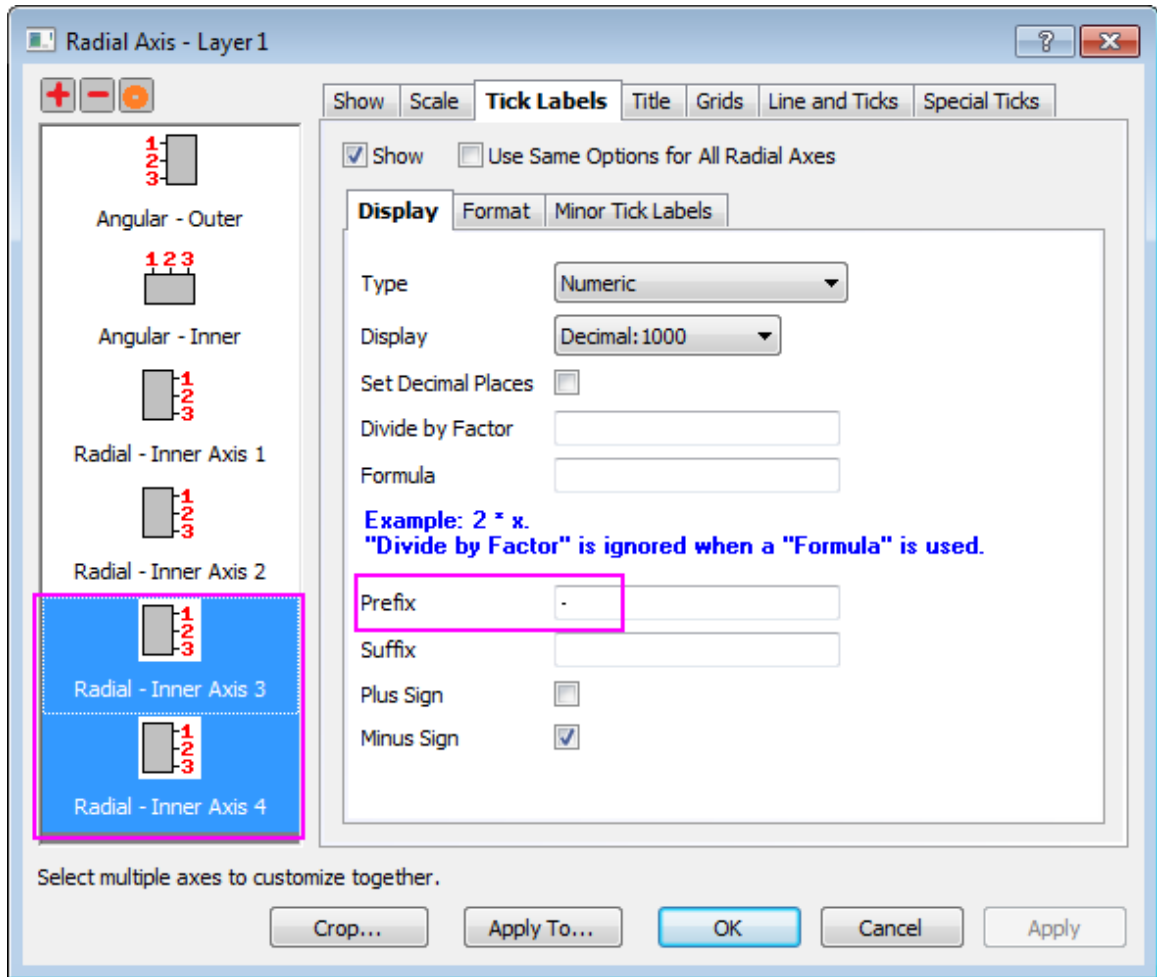

8. Click **OK** button.

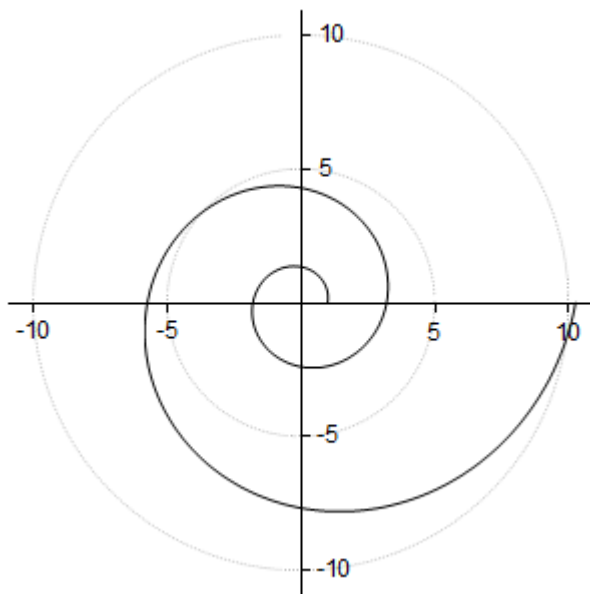

#### 6.12.5.3.4 Further Customization

9. To change the line plot color to red and a little thicker, select the line plot and on **Style** toolbar, set **Line/Border Color** as red, and set **Line/Border Width** to **1.5**.



10. To add an equation to this graph as graph title, right-click on the graph and select **Add/Modify Layer Title**, then enter  **$r = \exp(q \cdot \cot(79.5p/180))$**  into the edit box.

11. Origin supports rich text. So highlight **q** in the text and click  $\alpha\beta$  button on **Style** toolbar to turn it into  $\theta$ . Also turn **p** into  $\pi$ . The text will look as below.

$$r = \exp(\theta \cdot \cot(79.5\pi/180))$$

12. To add shadow to the text and make the font bigger, right-click on the title and click **Properties...** to open the **Object Properties** dialog. In the **Text** tab, set font size to **26**, and go to **Frame** tab to change **Frame** to **Shadow**. Click **OK** to save the setting.
13. Drag the equation to the desired position. The graph should look like the one in **Summary**.

### 6.12.6 Polar Graph with Multiple Layers

#### 6.12.6.1 Summary

The multi-layered graph allows the placement of several polar plots with different ranges on one graph page. This graph is generated by first creating 3 independent polar graphs, and then using the merge graph function to combine the three graph pages into one three-layer polar graph.



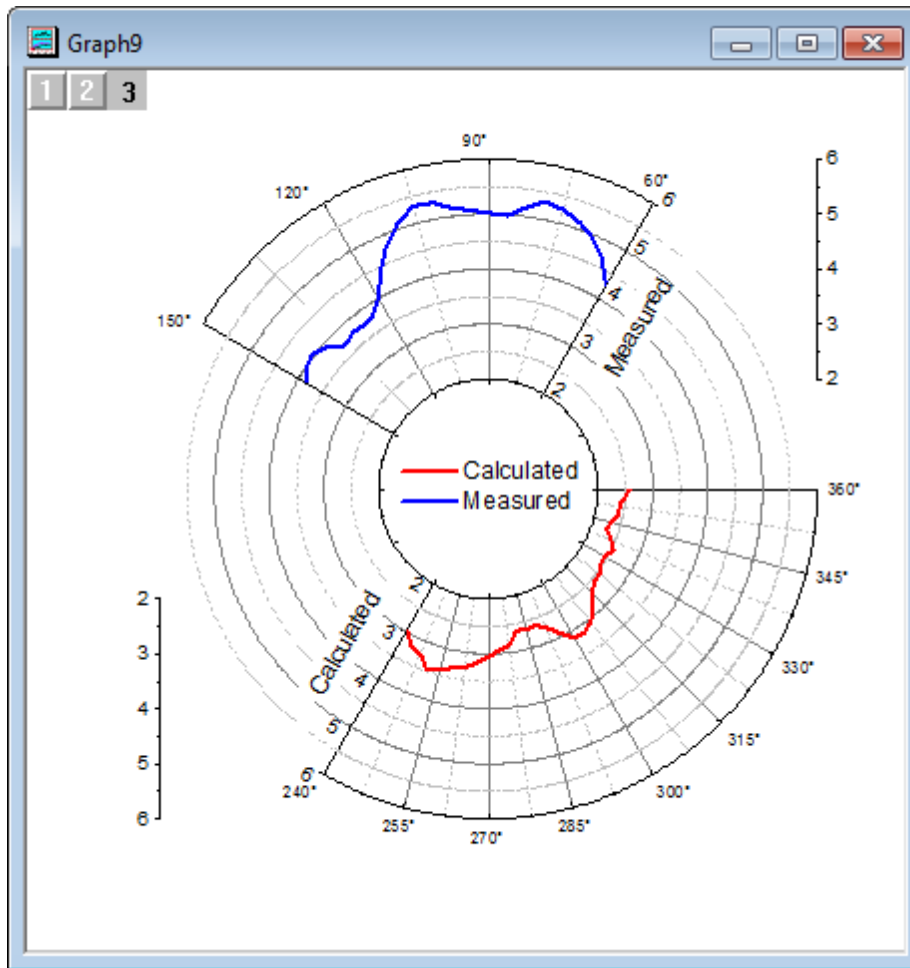

Minimum Origin Version Required: 2015 SR0

#### 6.12.6.2 What You Will Learn

This tutorial will show you how to:

- Customize the Angular axis and Radial axis.
- Duplicate a graph with new data.
- Create multi-layered polar graph.
- Create one legend for the whole page.

#### 6.12.6.3 Steps

This tutorial is associated with the **Tutorial Data.opj** file under the *<Origin EXE Folder>\Samples\* path.

##### 6.12.6.3.1 **Create a Polar Graph for the Measured Data**

1. Open the Tutorial Data.opj file and browse to the folder *Polar Graph with Multiple Layers*. Double-click the workbook **Book26** to open the workbook window.

2. Highlight Column A and Column B and select **Plot > Specialized: Polar theta(X) r(Y)** from the main menu to create the polar graph.

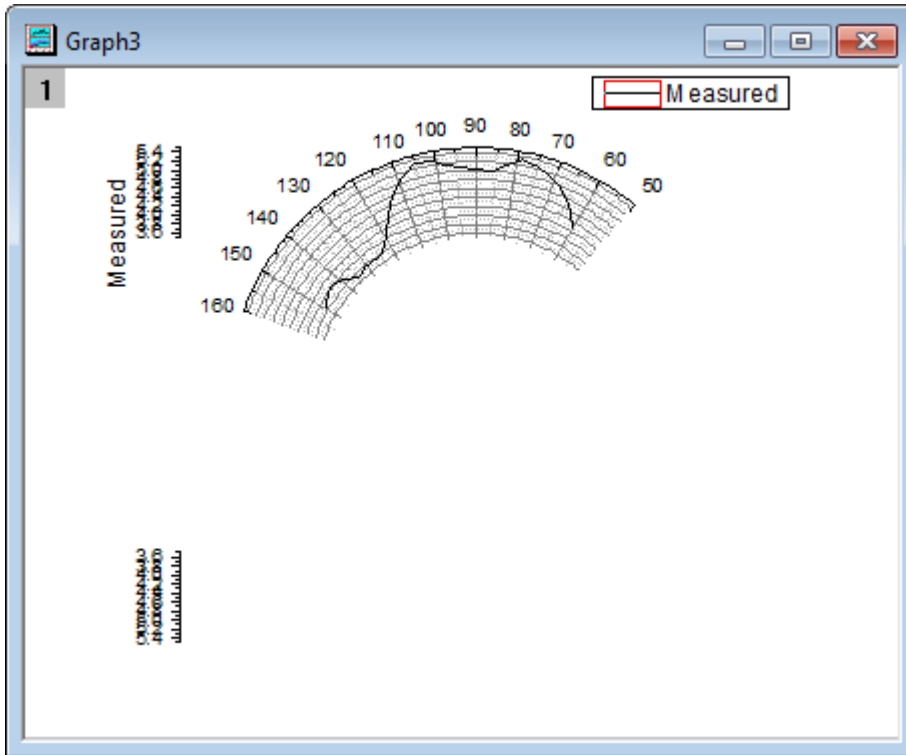

3. Right-click on any tick label of the Angular axis to open the dialog. Go to the **Scale** tab for Angular axis. Set the **Scale** of the Angular Axes as **From 60 To 150**. Set the **Value** for increments under **Major Ticks** as **30**. Click the **Apply** button to see the changes on the graph.

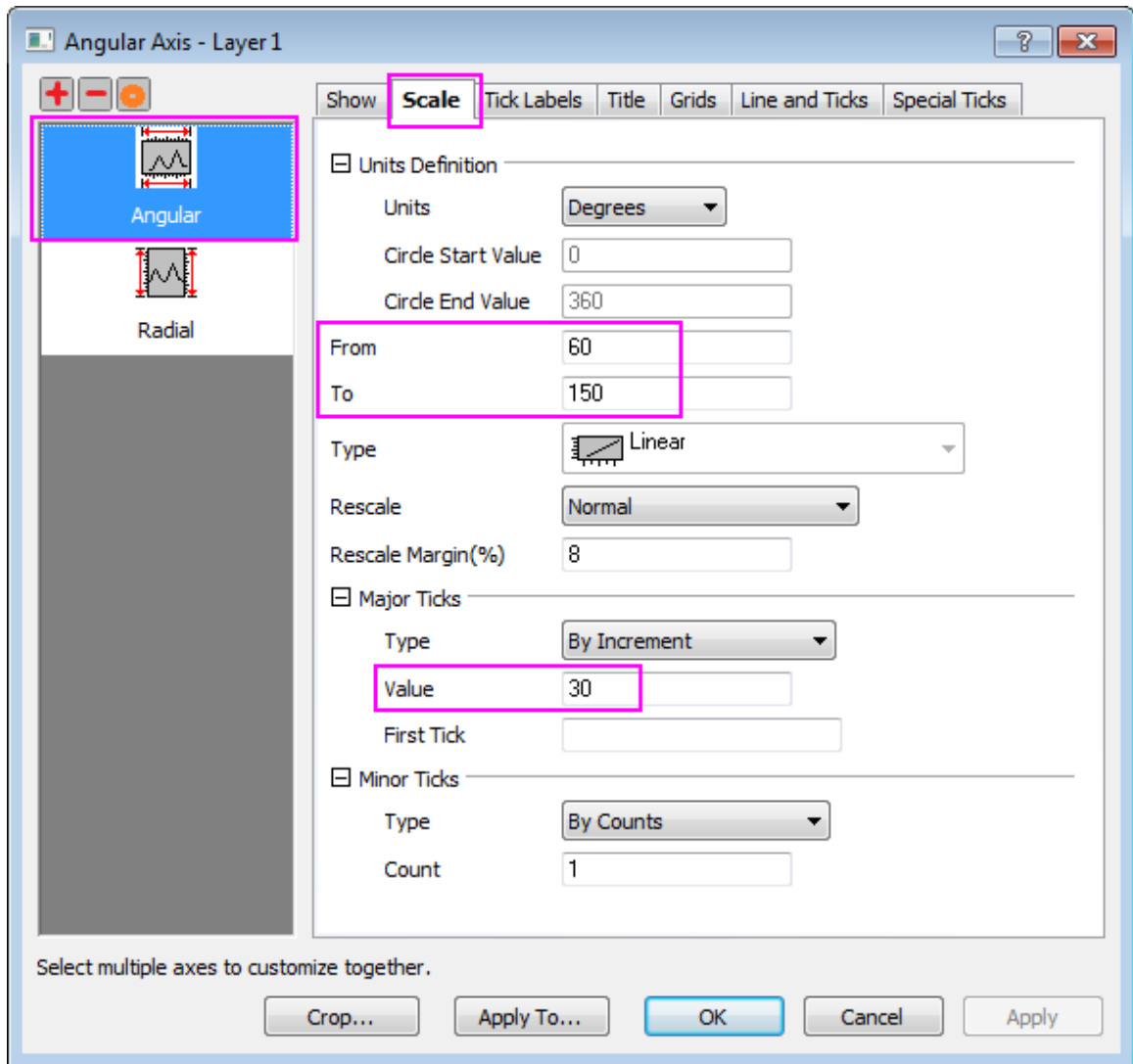

4. Go to **Tick Labels** tab and make sure **Angular - Outer** is selected in the left panel. Under **Display** subtab, type `\(176)` in the **Suffix** text box to add the degree symbol to the Angular tick labels. For more details of supported text formatting commands, please refer to the [escape sequences](#) page.

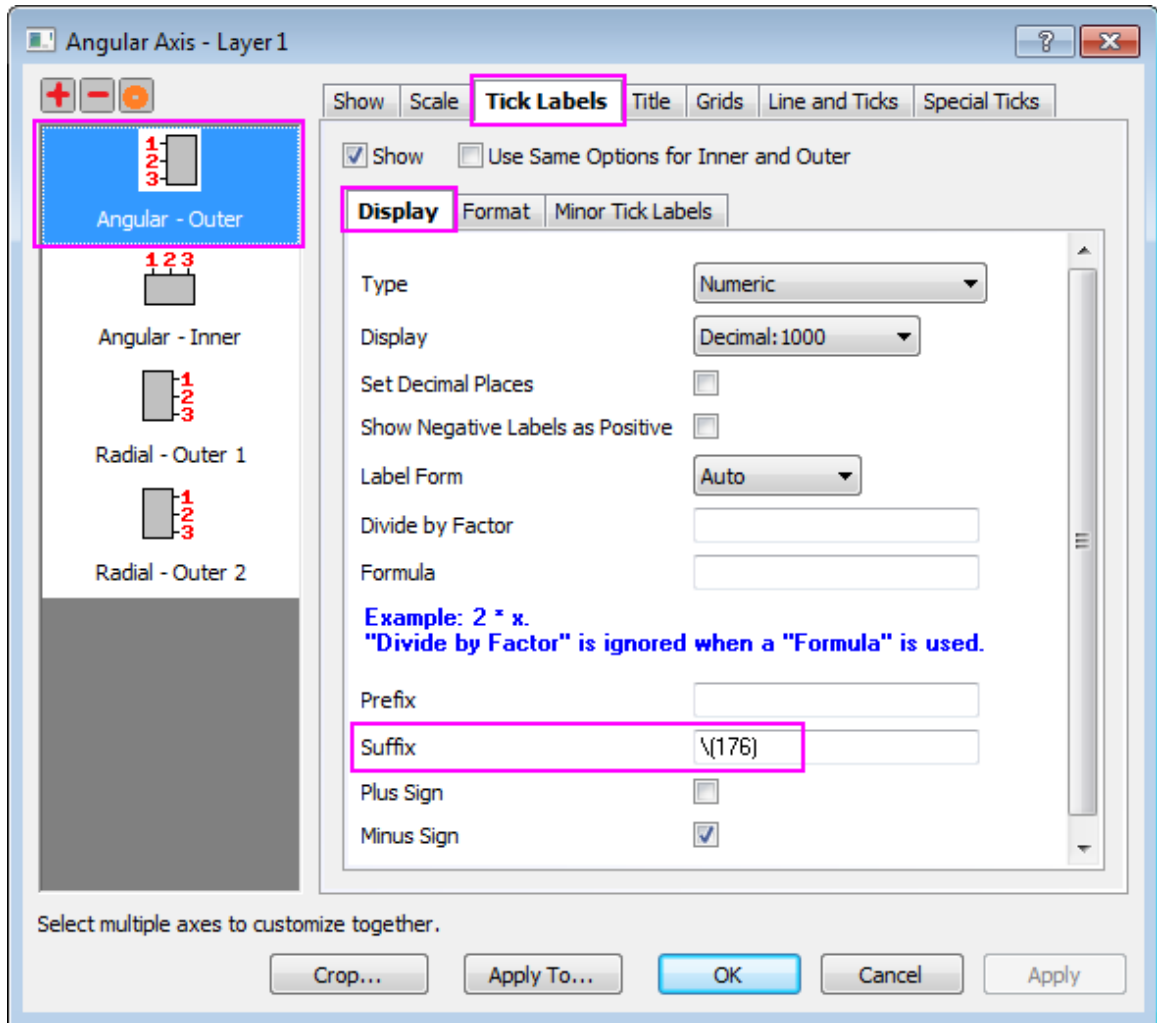

5. Click the **New Configuration...** button to open the **Radial Axes Configuration** dialog.
  - o Check the **Axes Inside Polar** box and configure it as shown below:
    1. Set the **Angles List** as **Custom**.
    2. Set the **Value** text box as **60 150** to place an axis at 60 degrees and one at 150 degrees.
  - o Set the **Axes Outside Polar** options as shown below:
    1. Select **Upper** from the **Right** option drop-down to place an axis at the upper right of the layer frame.
    2. Set **%s of Radius** as **0**.

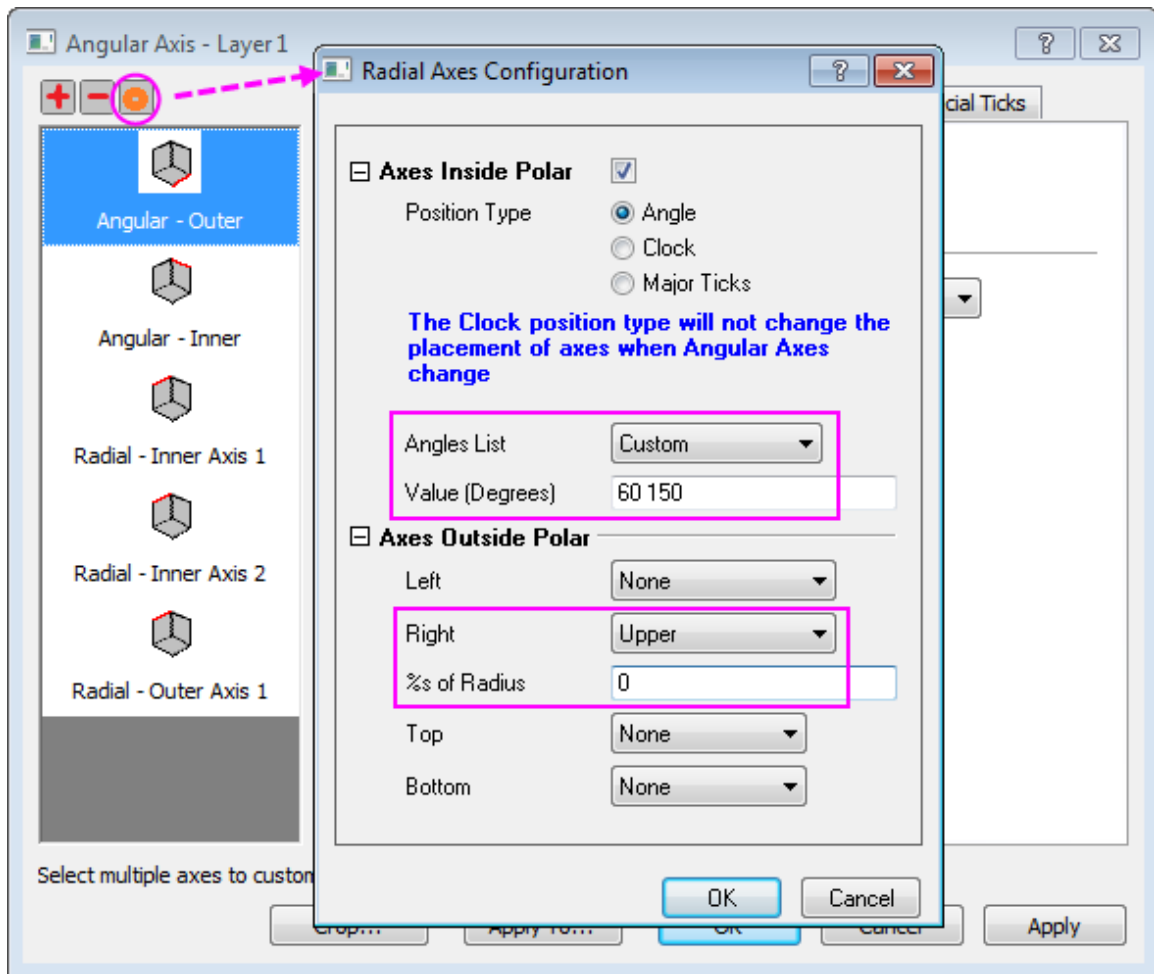

6. Click **OK** to apply the settings.
7. Go to **Scale** tab, and select **Radial** in the left panel. Set radial axis **From** as **2** and **To** as **6**. Change the increment **Value** for the **Major Ticks** to **1**.

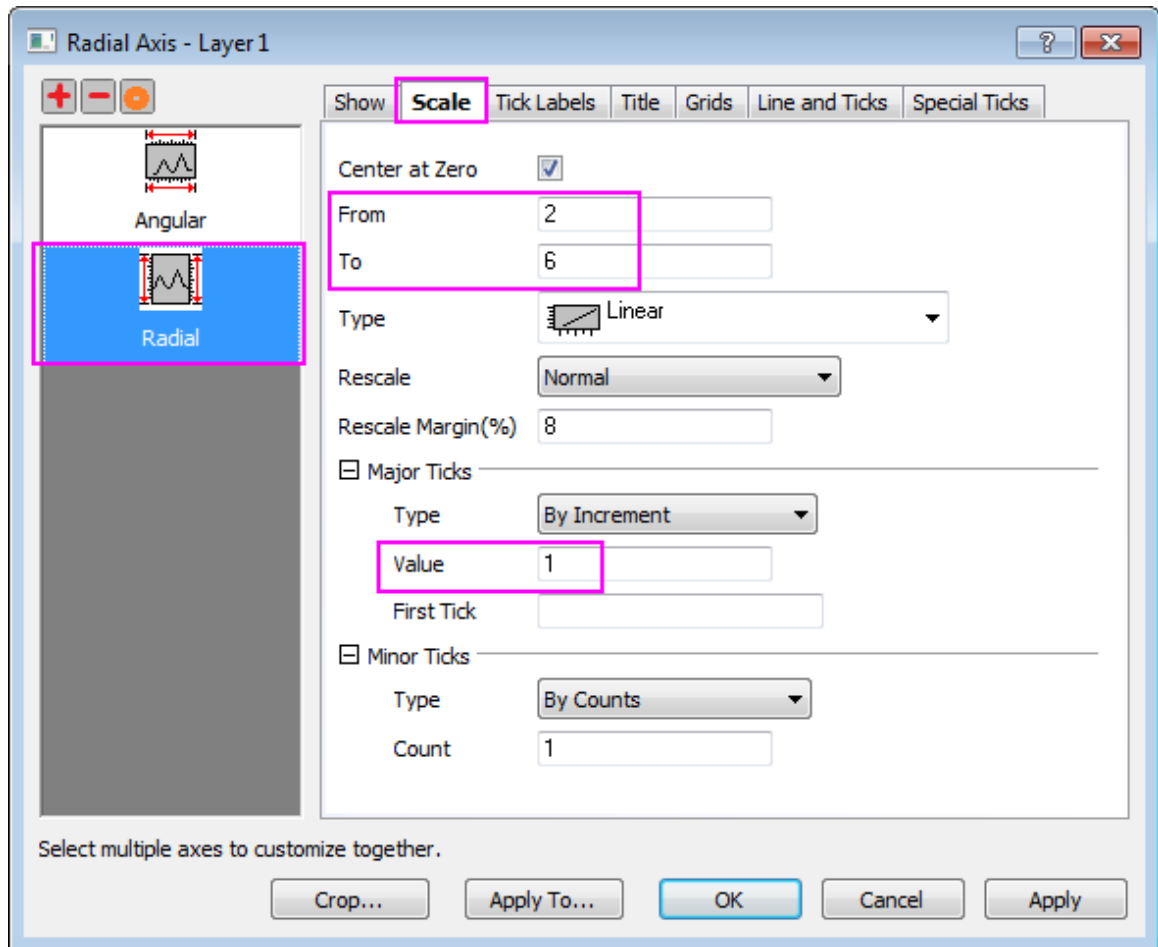

8. Go to **Tick Labels** tab and select **Radial - Inner 2** in the left panel. Uncheck **Show** check box to hide the tick labels for this axis.

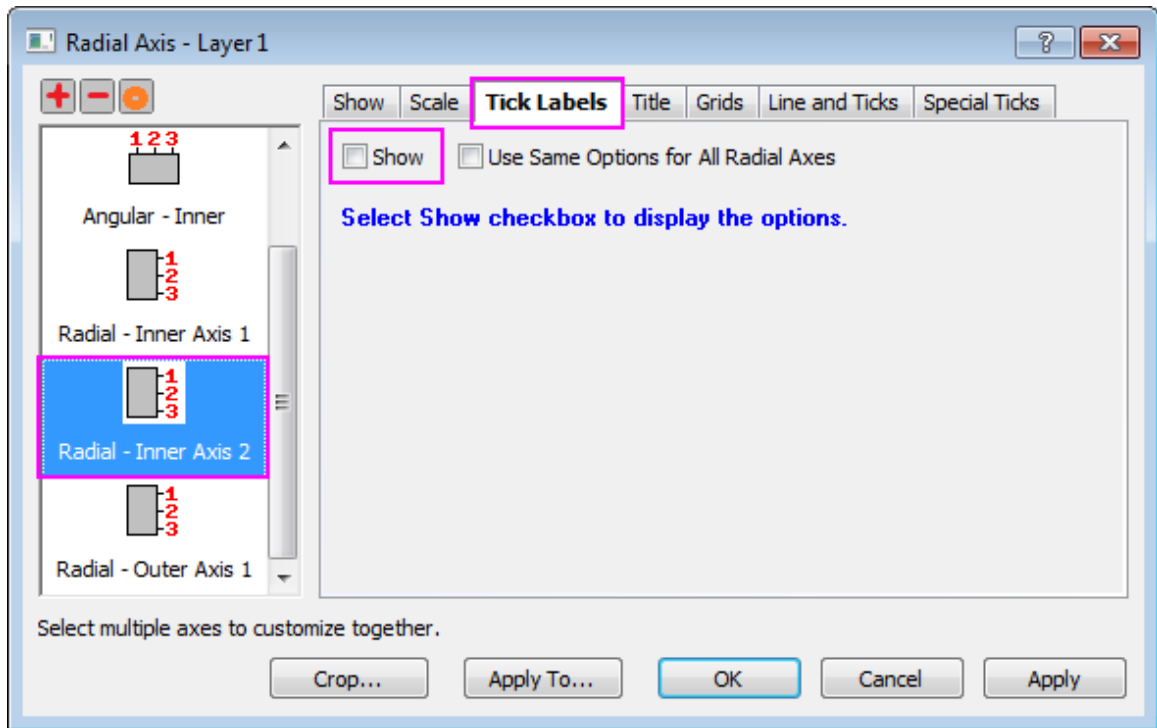

- Go to **Title** tab and select **Radial - Outer 1** in the left panel. Uncheck **Show** check box to hide the title of the outside polar axis. Click the **OK** button.

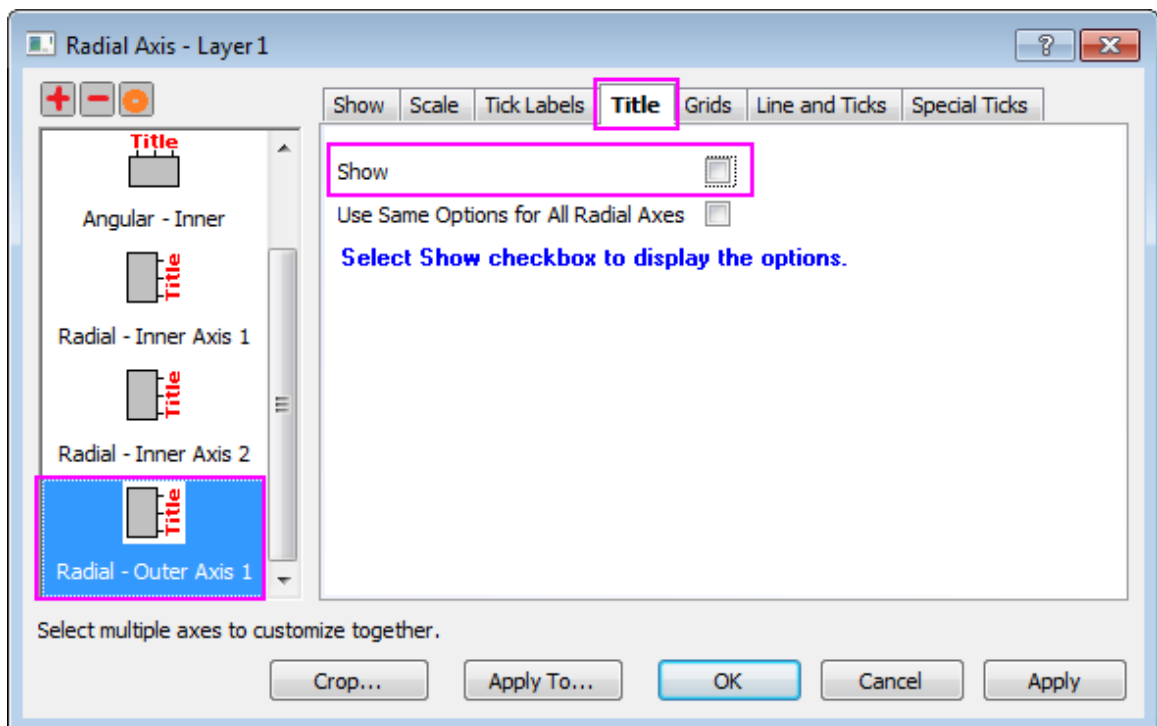

10. Double-click the plot to open the **Plot Details** dialog. In the left panel of the **Plot Details** dialog, click the **Graph** page to go to the page level of this dialog. In the **Legends/Titles** tab, deselect the check box **Indicate Active Dataset**, so that the red box around the legend symbol will be hidden.
11. Expand the **Layer** node on the left panel and select the graph under it. On the **Line** tab in the right panel, change **Width** to **4** and **Color** to **Blue**.

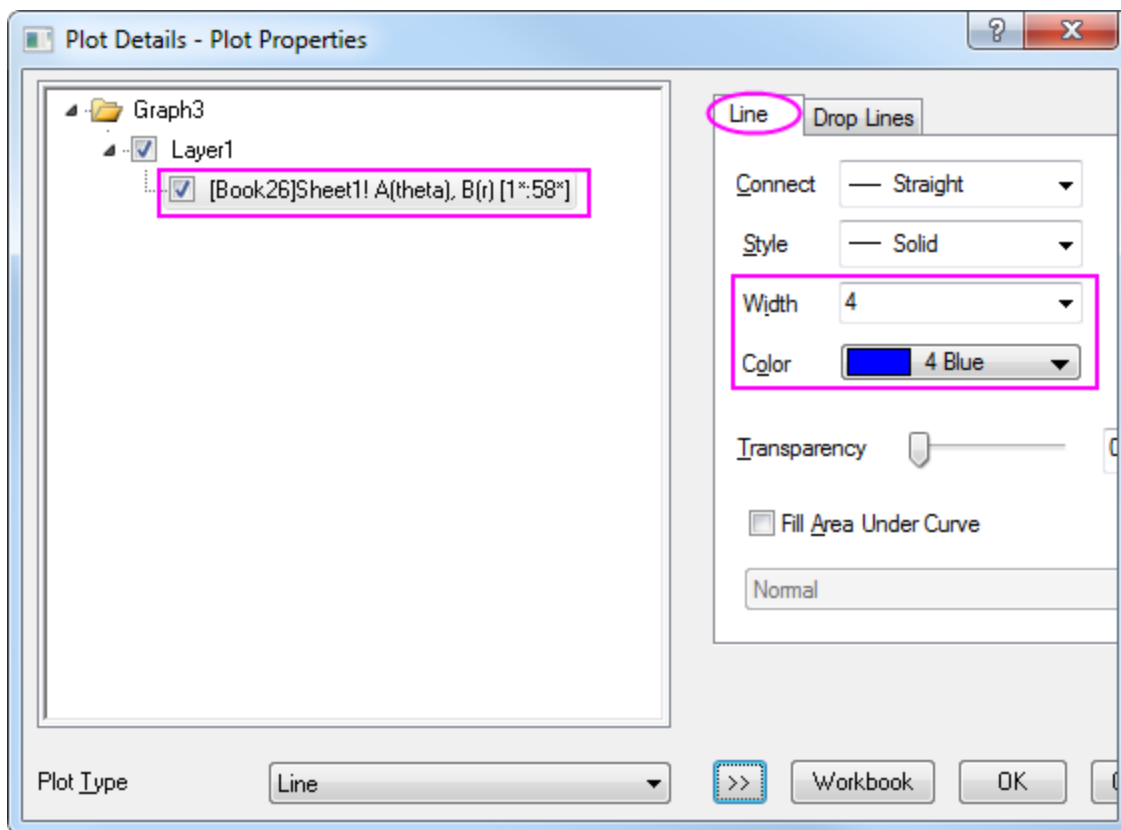

12. Click the **OK** button to apply customizations to the first polar graph.



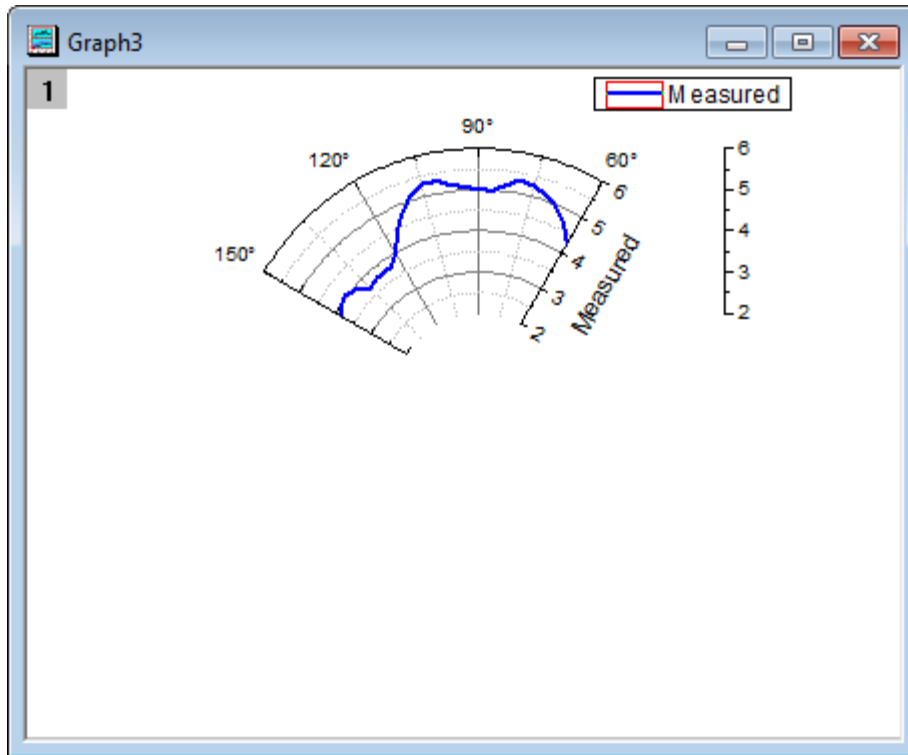

#### 6.12.6.3.2 Duplicate a Polar Graph with the Calculated Data

1. Right-click the header of the polar graph to open the shortcut menu. Select **Duplicate (Batch Plotting): Duplicate with New Columns...** to open the **Select Column** dialog. Select the column **C:Calculated** and click **OK** to duplicate a polar graph with data from Column C.

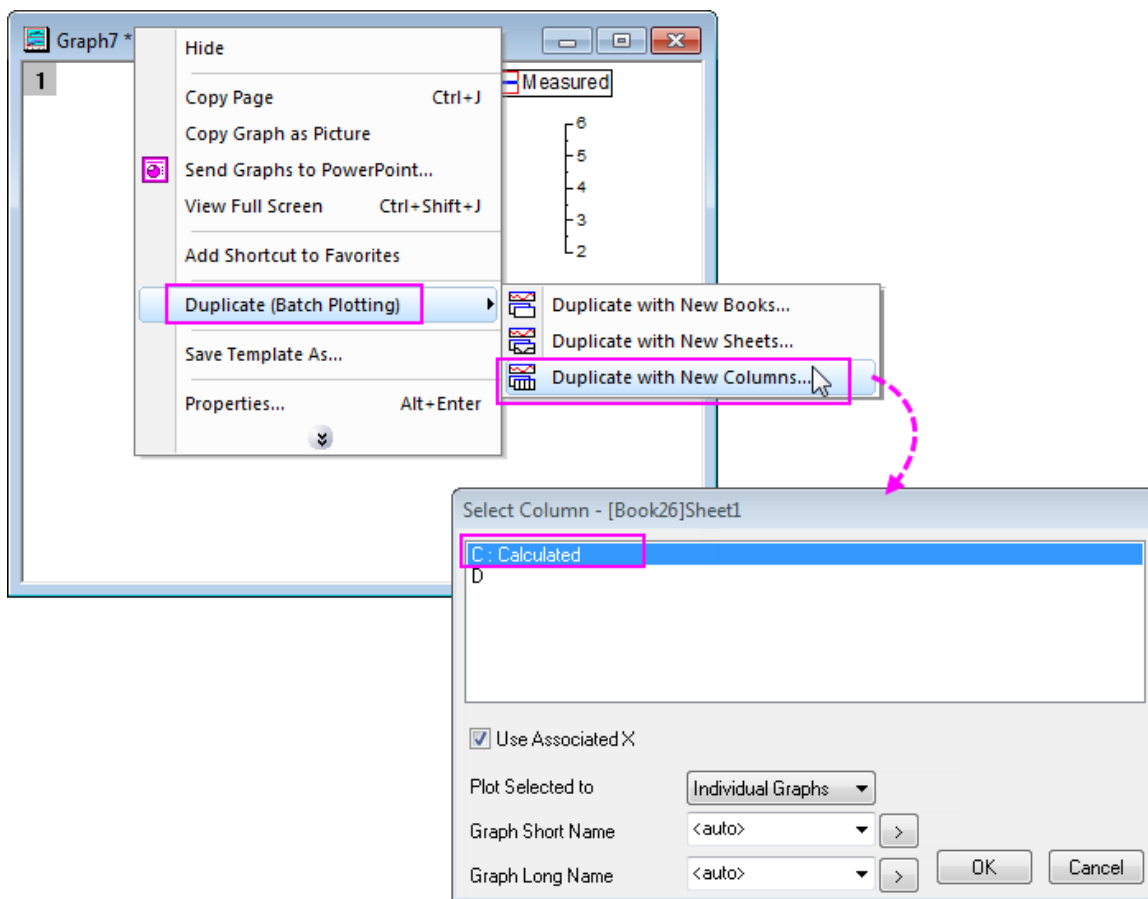

2. Since the data range in Column C is quite different from Column B, the **Reminder Message** window will pop up, asking whether to rescale the axes of the new graph to show all data. Leave the **Yes** radio button selected and click **OK**.
3. Follow steps 3 from the last section to set the scale of the Angular Axes. Set **From** as **240** and **To** as **360** and the increment of the **Major Ticks** to **15**.
4. On the **Scale** tab, choose **Radial** in the left panel and then set **From** as **2** and **To** as **6** and the increment of the **Major Ticks** as **1**.
5. Go to **Show** tab
  - Choose **Radial - Inner 1** in the left panel. Under **Axis Position** section, set the **Value (Degrees)** as **240** to move the first inside polar axis to 240 degrees.
  - Choose **Radial - Inner 2** in the left panel. Set the **Value (Degrees)** as **360**.
  - Choose **Radial - Outer 3** in the left panel. Select **Left-Lower** in **Axis at** drop-down list to move the outside axis to the lower left of the layer frame.

Click the **OK** button to finish customizing the axes.

6. Double click the plot to open the **Plot Details** dialog. Change the line **Color** to **Red** and **Width** to **4** in the **Line** tab. Click **OK**.

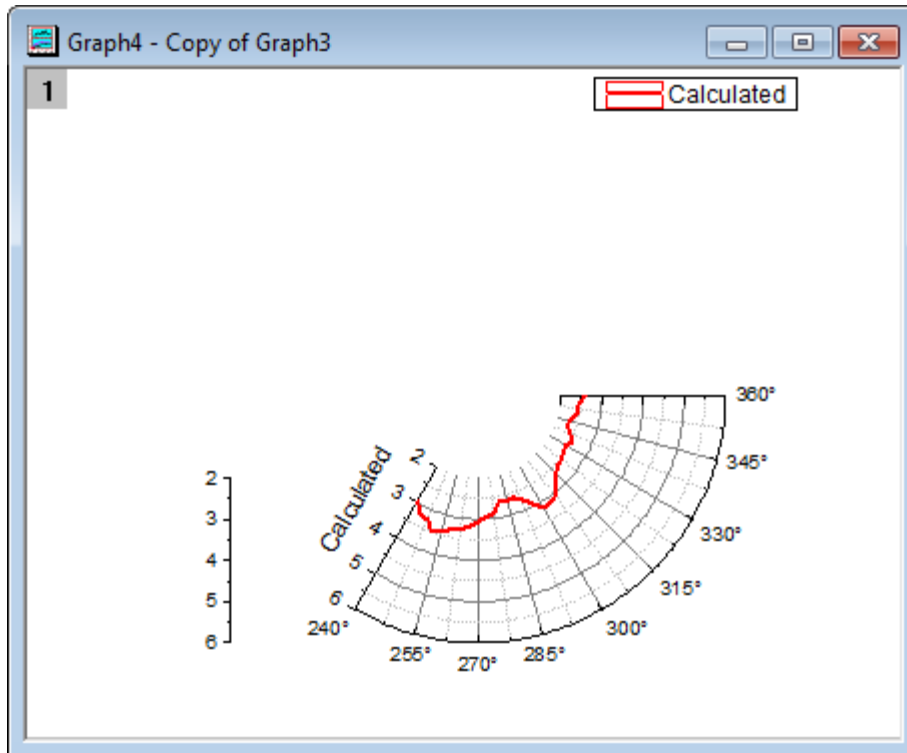

#### 6.12.6.3.3 Create a Polar Graph to Show Full Range Grids

1. Open the workbook **Book26**.
2. Select Column D and click the **Polar theta(X) r(Y)**  button in the **2D Toolbar** to create an empty polar graph.
3. Repeat steps 3 in the [Create the Polar graph for the Measured data](#) section to set the scale of the Angular Axes as **From 0 To 360** and the increment **Value** of the **Major Ticks** as **30**.
4. Go to **Show** tab, select **Angular - Outer** on the left panel and uncheck **show** box. Then select **Angular - Inner** on the left panel and check **Show** box.
5. Go to **Tick Labels** tab, select **Angular - Inner** in the left panel, and uncheck the **Show** check box to hide the tick labels of the inner Angular axis.
6. Go to **Grids** tab, make sure **Angular** is selected in the left panel. Uncheck the **Show** option in the **Major Grid Lines** and the **Minor Grid Lines** sections.
7. Go to **Scale** tab, select **Radial** in the left panel, and change the scale **From 2 To 6** and set the increment **Value** of the **Major Ticks** as 1.
8. Go to **Show** tab, select **Radial - Outer 1**, and check **Use Same Options for All Radial Axes**. This will apply the settings on this page to **Radial - Outer 2** axis as well. And then uncheck **Show** check box. Click the **OK** button.

#### 6.12.6.3.4 Create the Multi-layered Graph with One Legend

1. With a graph window activated, select **Graph: Merge Graph Window** from the main menu.
2. Set the **Merge** option as **Specified** and make sure only **Graph1**, **Graph2** and **Graph3** (the three new graphs just created) are selected in the **Graphs** text box.

3. In the **Arrange Settings** section set both **Number of Rows** and **Number of Columns** to **1** to overlay the three graphs.
4. Check the box next to **Link Source Graphs**.
5. In the **Page Setup** section, set both **Width** and **Height** to **15**.

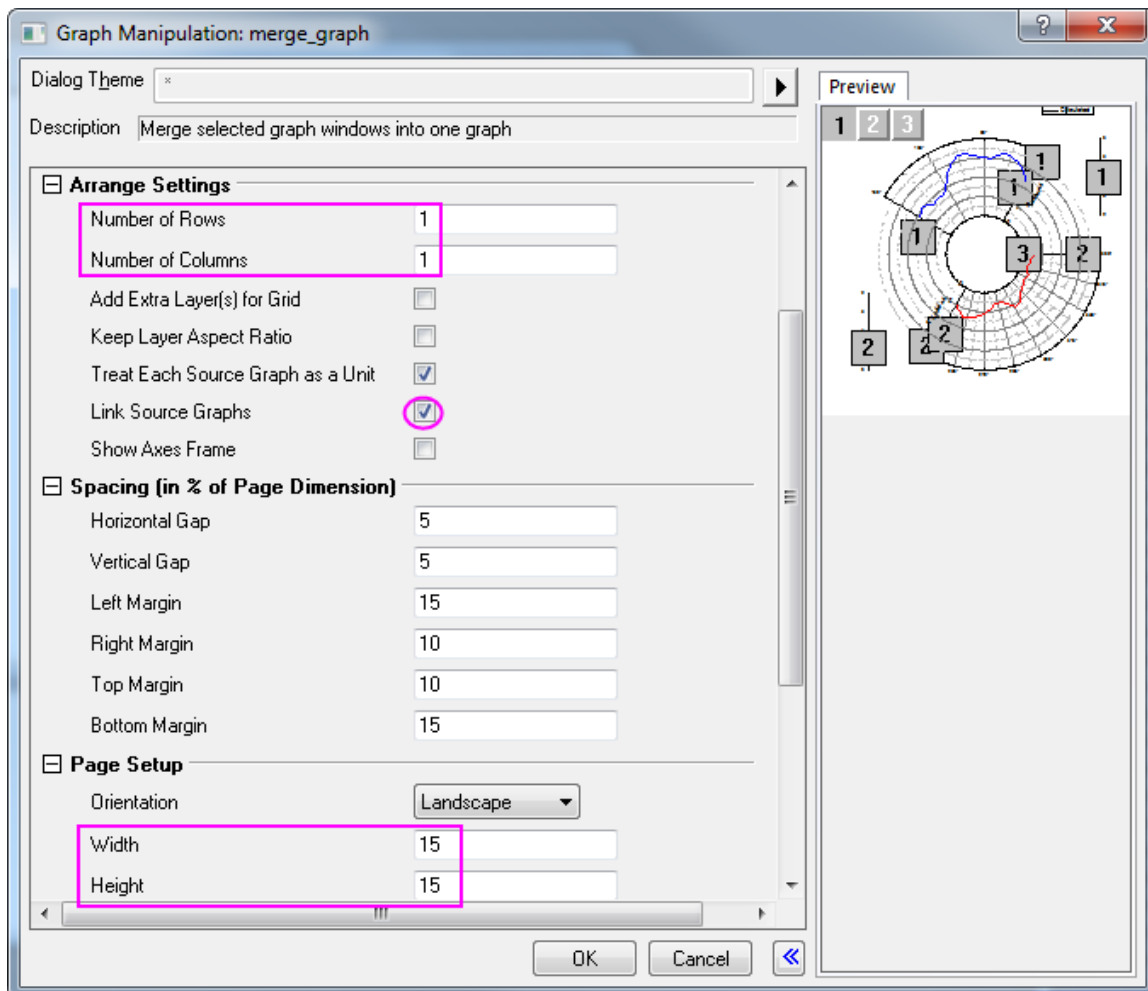

6. The preview of the graph can be seen in the right panel.
7. Keep the rest of the default settings and click **OK**.
8. Right-click the legend and select **Legend: Update Legend** from the shortcut menu, to open the dialog.
9. Set the **Update Mode** to **Reconstruct** to create a new legend.
10. Set the **Legend** to **One Legend for Whole Page** to create only one legend for this multi-layered graph.
11. Set the **Layer Order** as **Descending** to place the Layer 2 legend above the Layer 1 legend.
12. Set the **Auto Legend Translation Mode** as **@LA: Long Name** to use the Long Name data for the legend. Click **OK**.

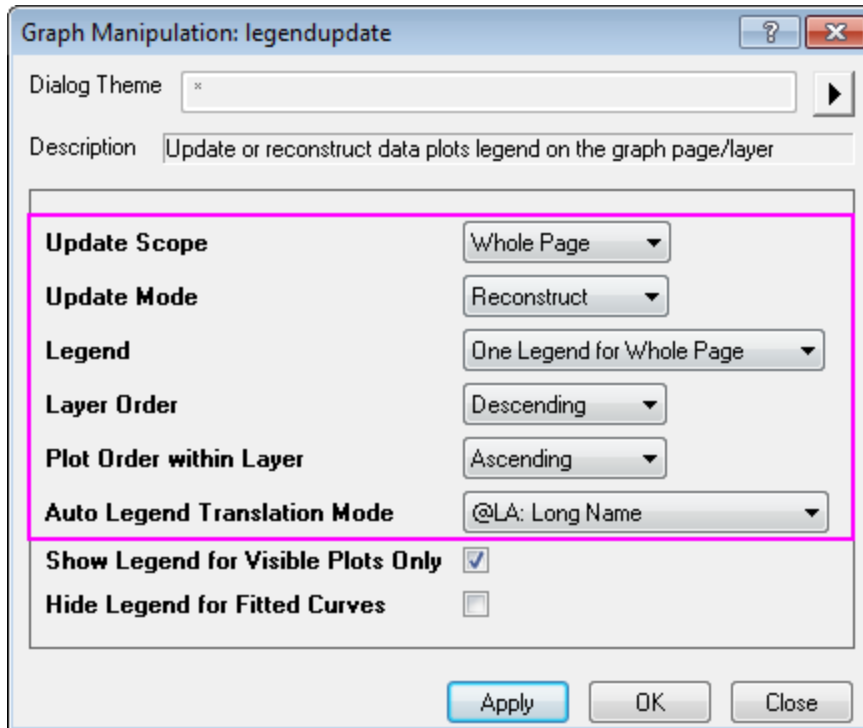

13. Right-click on the new legend and select **Properties...** to open the dialog.
14. Delete the first line in the lower text box.
15. On the **Frame** tab, set Frame to **None**. Click **OK**.
16. Drag the legend to the center of the inner Angular axis.
17. Use the **Font Size**  text box to change the size of the fonts on this graph. Drag the tick labels to move them to an appropriate position.
18. Right-click one of the inner radial axis titles (**Calculated** or **Measured**) and select **Properties...** from the shortcut menu.
19. In the **Object Properties** dialog that opens, in the **Frame** tab, choose the **None** from **Frame** drop-down list. This clears the grid lines and other background from behind the axis title making it easier to read. Click **OK**.
20. Repeat the same operation for the other inner radial axis title.
21. The final graph should appear as shown below:

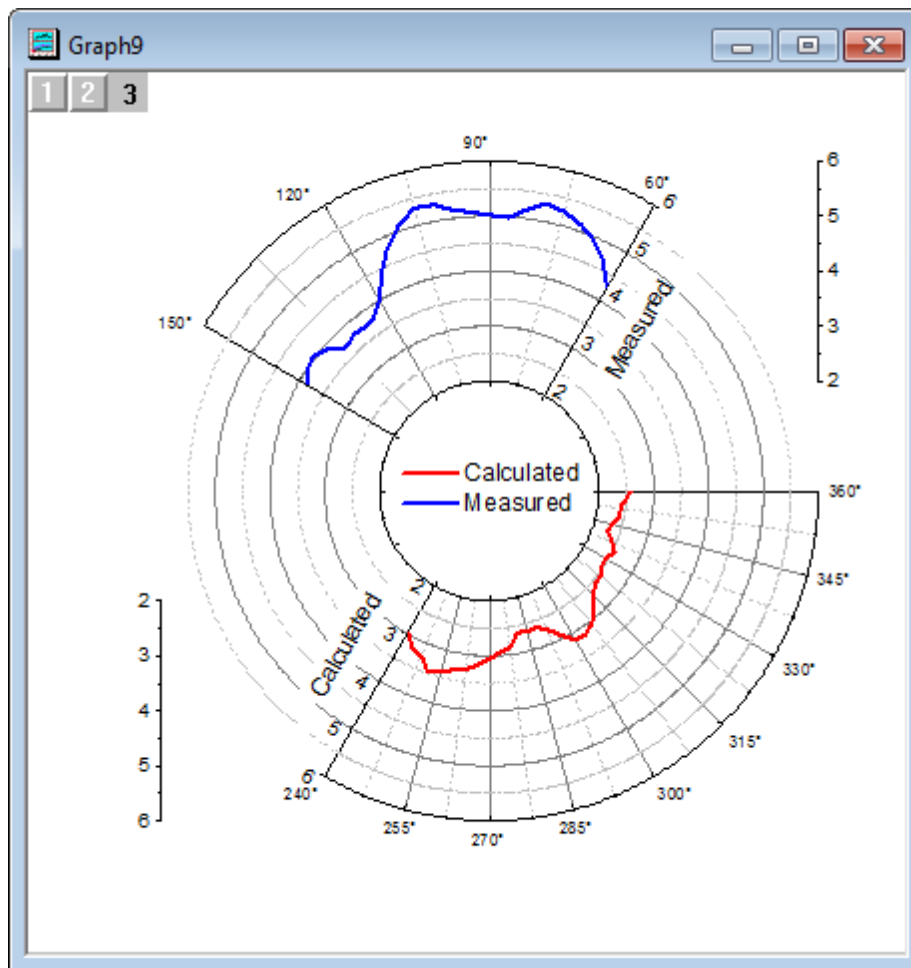

## 6.12.7 Polar Graph with Columns and Stack Columns

### 6.12.7.1 Summary

By default, Origin polar graphs are line plots. Note, however, that you can convert an existing polar line plot to column/bars. Further, a grouped column plot in polar coordinate system can be stacked.

Minimum Origin Version Required: 2015 SR0

### 6.12.7.2 What You Will Learn

This tutorial will show you how to:

- plot polar graphs with columns
- control the column width using a dataset
- create a stacked column plot in the polar coordinate system
- customize the polar axes

### 6.12.7.3 Steps

## 6.12.7.3.1 Polar Graph with Columns

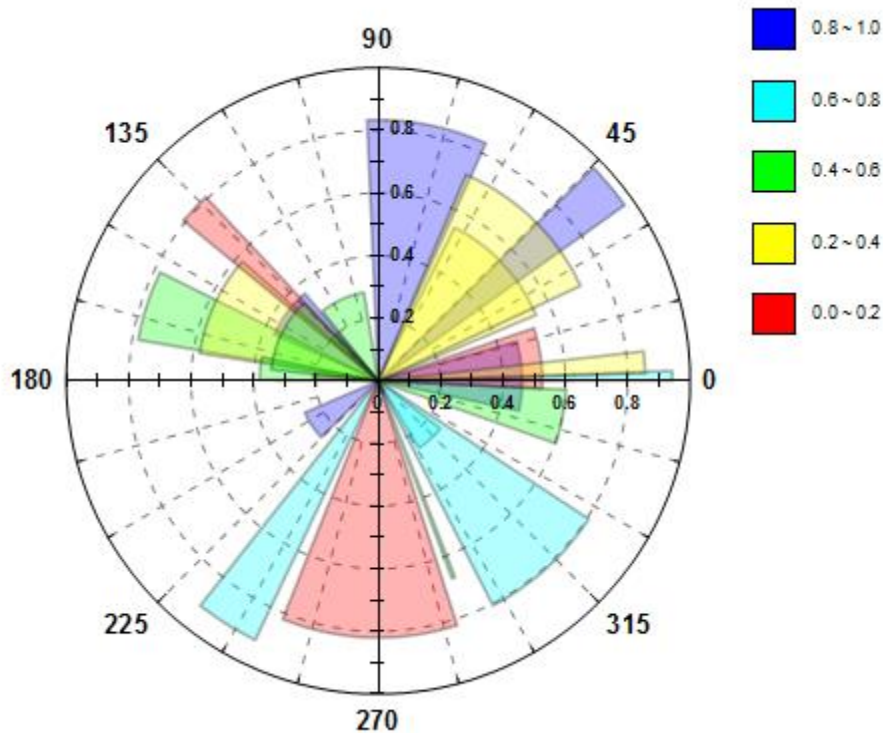

This tutorial is associated with the Tutorial Data project: <Origin EXE Folder>\Samples\Tutorial Data.opj. You can refer to this graph in Learning Center. (Select **Help: Learning Center** menu or press **F11** key , and then open **Graph Sample: Polar Graphs**)

1. Open the Tutorial Data project and browse to the folder *Column and Stack Column* and activate **Book18**.
2. Highlight column B and select **Plot > Specialized:Polar theta(X) r(Y)** to create a line plot in the polar coordinate system. Click on the legend object and delete it from the graph.
3. Double-click on the line plot to open the **Plot Details** dialog box. Make sure the left panel is expanded and set **Plot Type** to **Column/Bar**. This will change the line plot to a column plot.
4. In the **Pattern** tab, under the **Fill** section, set **Color** to **Color Mapping:Col(D)**. This will map column colors in the plot using the row value in column D of the worksheet (note that a **Colormap** tab is added to **Plot Details**. Click on this tab to see how values are mapped to fill color).
5. Set the **Transparency** in this tab to **70%**, and **Width** of border to **2** :

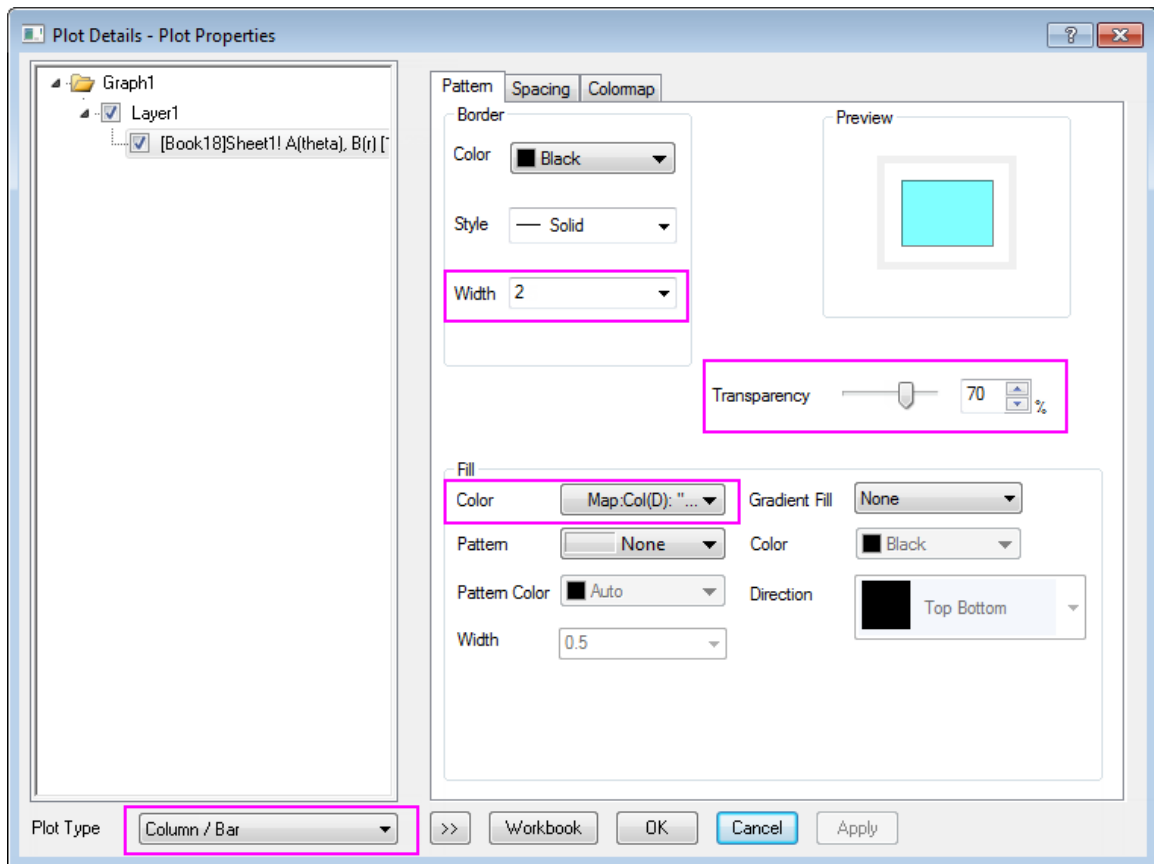

6. Go to the **Spacing** tab, select **Col(C):"Size"** from the **Width(in %)** drop-down menu and type in **8** as **Scaling Factor**. This causes values in column C to determine the width of the columns in the plot.



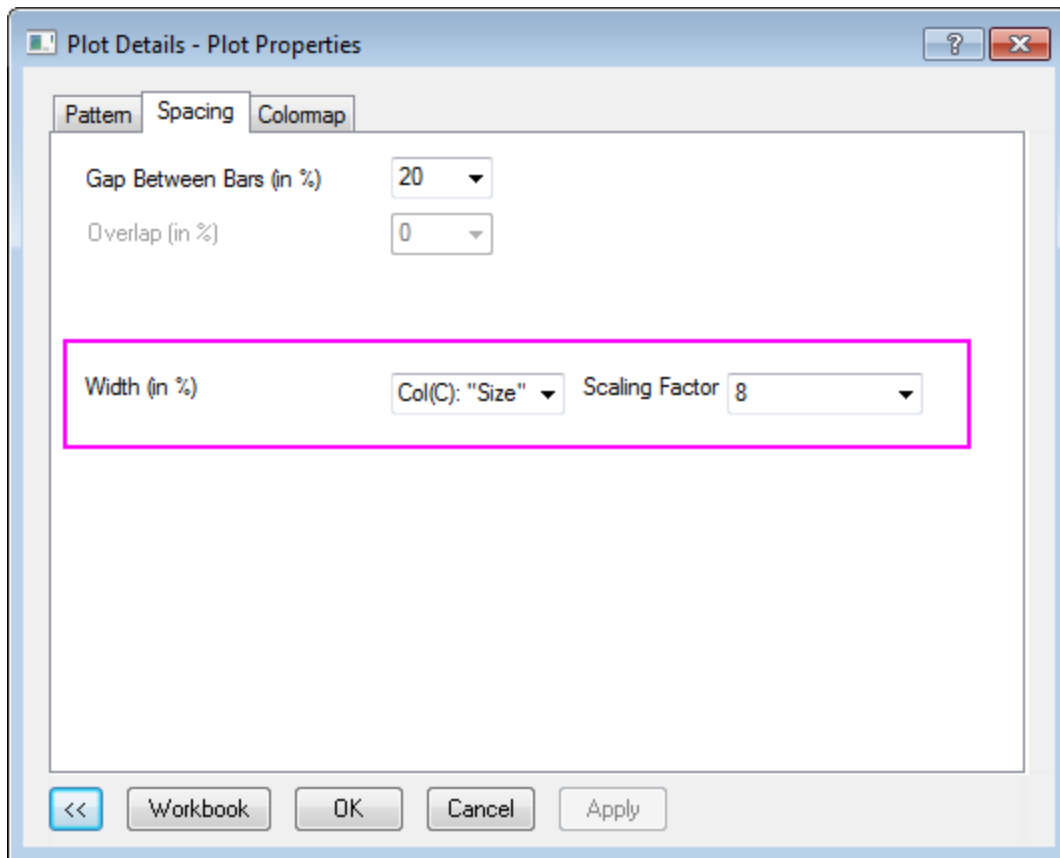

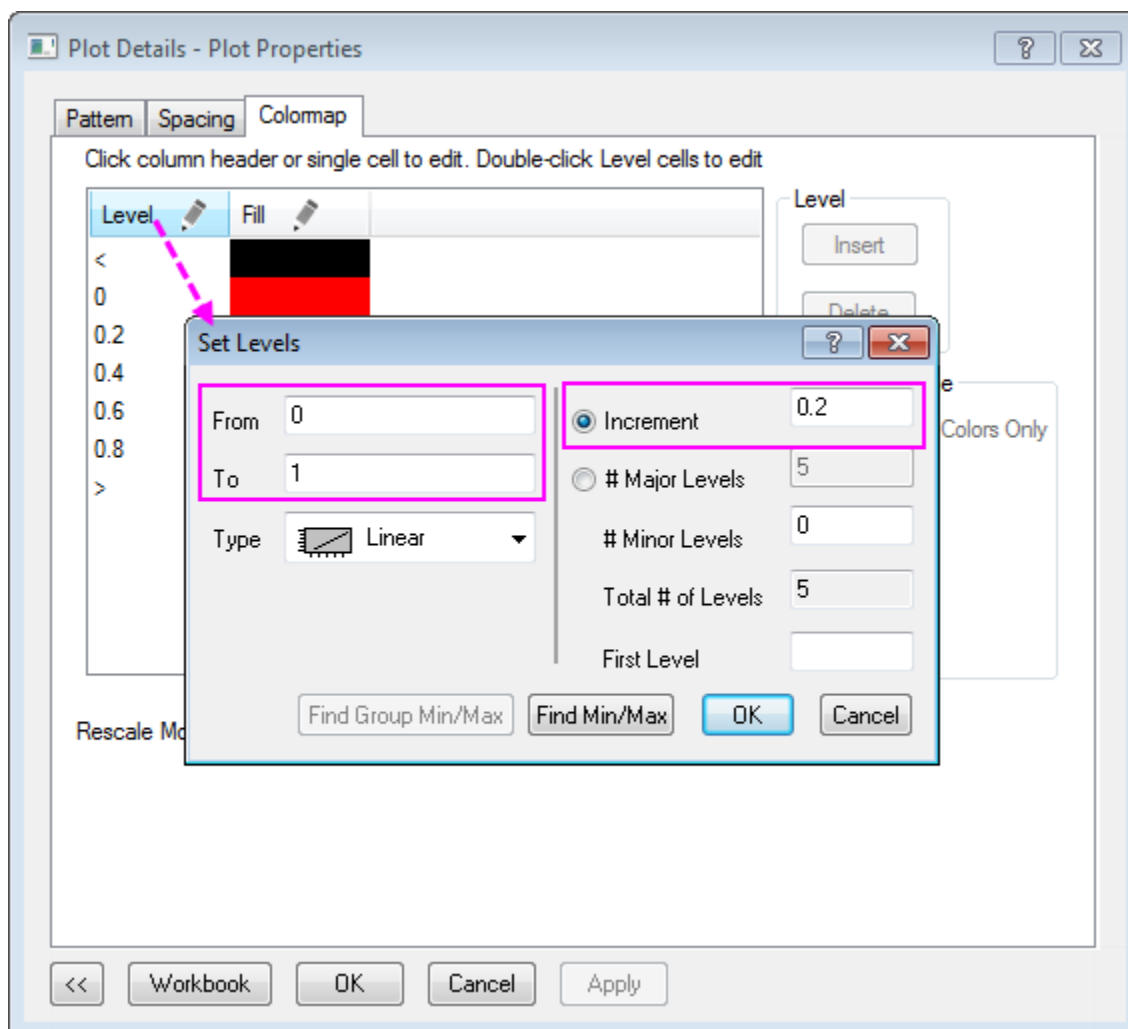

7. Go to **Colormap** tab, click **Level** head. Set the level from **0** to **1** and **Increment** to **0.2** in the **Set Levels** dialog,

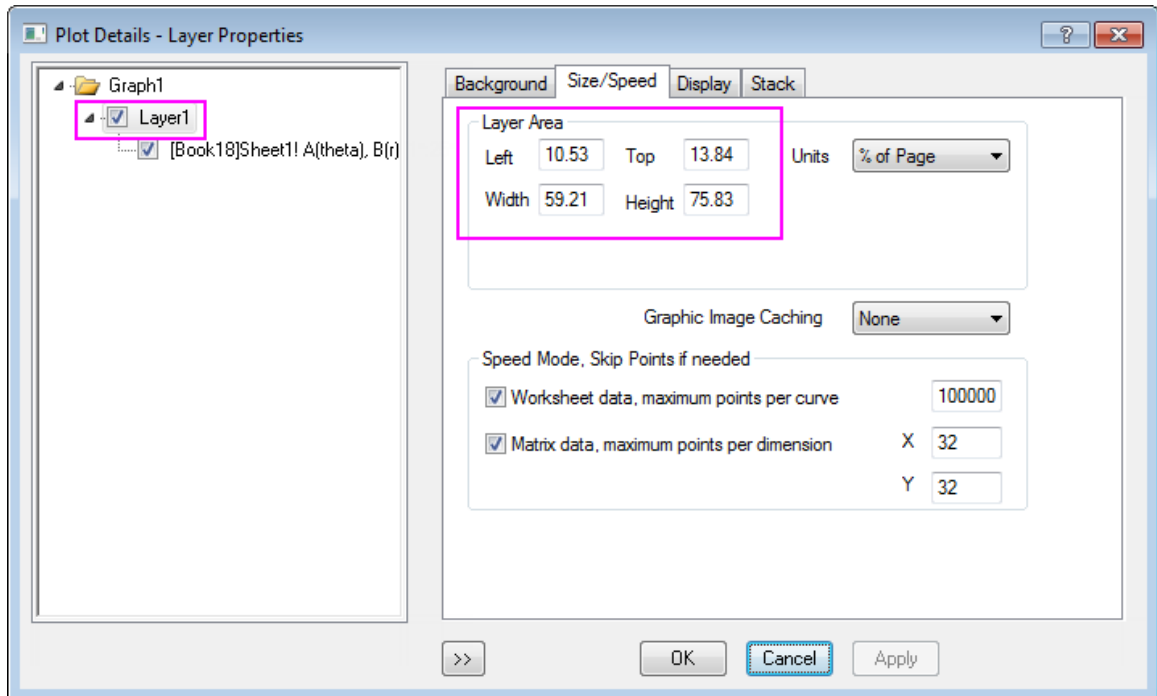

8. Go to **Size/ Speed** tab under **Layer1** level, and set **Layer Area** as following:



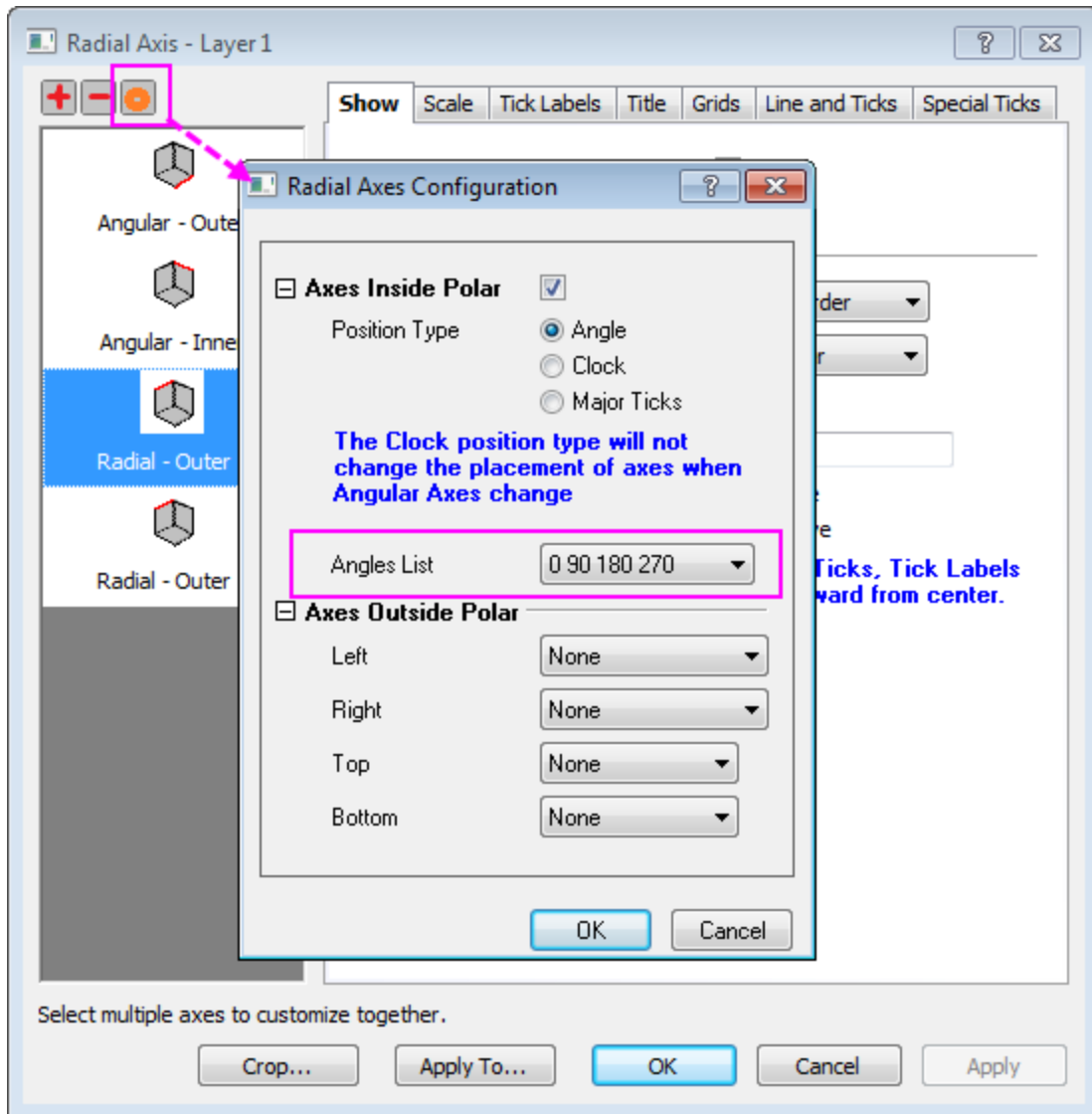

Click **OK** to close the **Plot Details** dialog.

9. Now we will customize the graph **Angular Axes**.
  - Double-click on an axis (Angular or Radial) to open the **Axis** dialog. Go to the **Scale** tab under the **Angular** tree node and set the **Value** under **Major Ticks** to **45**, and set the **Count** under **Minor Ticks** to **2**.
  - Go to **Format** tab under **Tick Labels** tab of **Angular -Outer** tree node. Check **Bold** check-box.
  - Go to **Grids** tab under **Angular** tree node. Change **Style** of **Major Grid Lines** to **Dash**.
  - Go to **Line and Ticks** tab under **Angular -Outer** tree node. Change **Thickness** of **Line** to **1.5**.
10. In the **Axis** dialog, we also can customize the **Radial Axes** for this polar graph.
  - Click on the **Radial Axes Configuration** button  on the right-top of this dialog to open the dialog. In the dialog, choose **0 90 180 270** under the **Angles List** drop-down list.

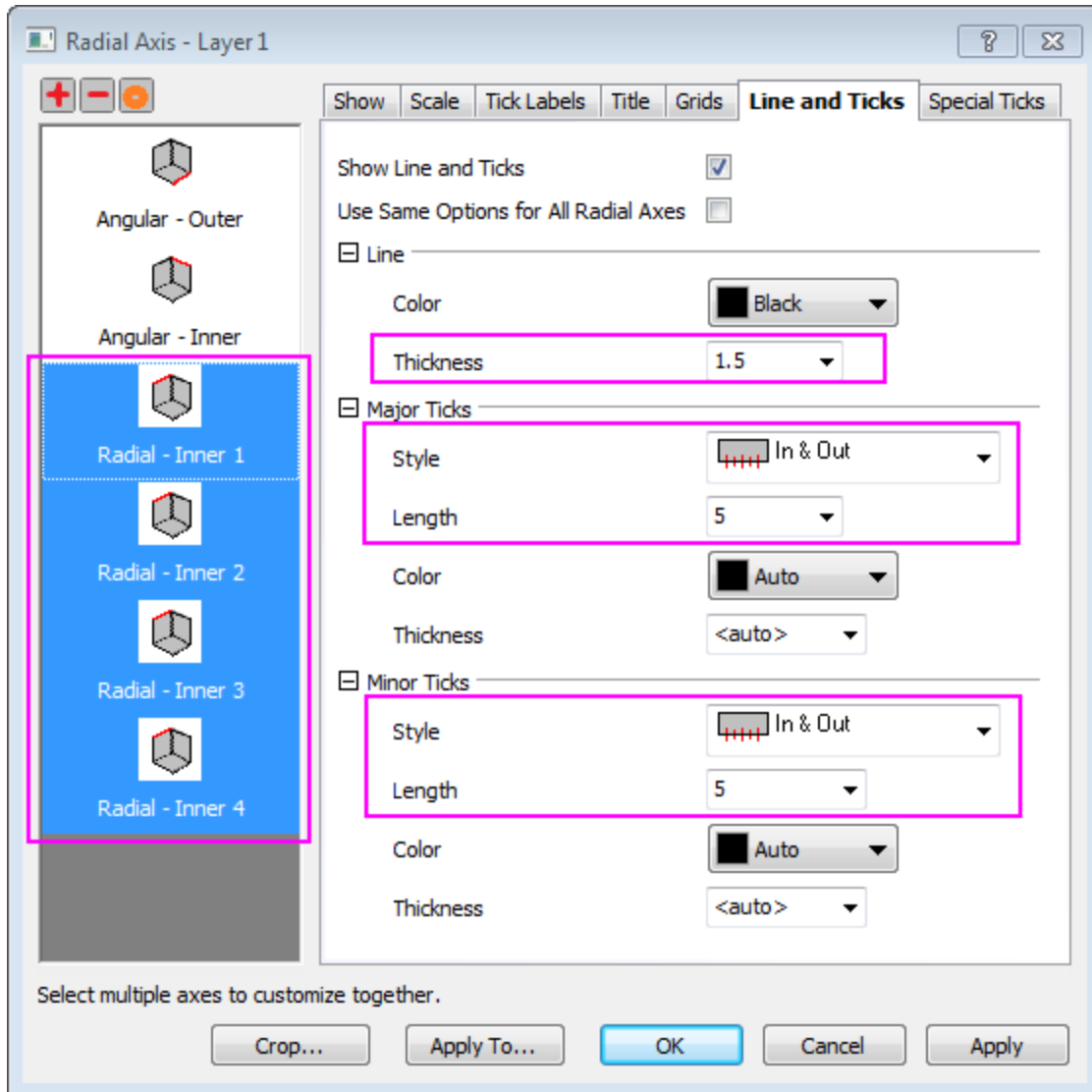

- Go to the **Scale** tab under the **Radial** tree node. Set scale from **0** to **1**.
- Go to the **Format** tab under **Tick Labels** tab, and then
  - select the **Radial - Inner1**, change **Size** to **12**, check **Bold** box, and set **Rotate (deg.)** to **0**.
  - select the **Radial - Inner2**, change **Size** to **12**, and check **Bold** box.
  - select both **Radial - Inner3** and **Radial - Inner4**, then uncheck **Show**.
- Go to the **Display** tab under **Tick Labels** tab of **Radial - Inner1** tree node. Choose **Custom** in **Display** drop-down list, and enter **.2\*** in **Custom Format** text box.
- Go to the **Title** tab and highlight all radial axes node. Uncheck **Show** check box.
- Go to the **Grids** tab under **Radial** tree node. Uncheck **Show** check box under **Minor Grid Lines**. Click **OK** to save the setting and close the dialog.
- Go to **Line and Ticks** tab, select all radial axes. Change **Thickness** of **Line** to **1.5**. And set **Style** to **In & Out**, **Length** to **5** for both **Major Ticks** and **Minor Ticks**.



- Go to **Special Ticks** tab of **Radial - Inner 1**, then set **Axis Begin** value to **Show**, **Axis End** value to **Hide**. Choose **Radial-Inner 2**, set both **Axis Begin** and **Axis End** value to **Hide**. Click **OK** to apply the setting and close the dialog.
11. Select **Insert: Color Scale** to add the color scale legend. To customize the color scale legend, double click on the color scale to open the dialog.
- In the **Color Scale Control** dialog, go to **Level** page, and check the **Hide Head and Tail Levels**
  - Go to **Labels** page, check **Set Decimal Places** check box and enter **1** in the **Decimal Places** text box.
  - Go to **Layout** page, select **Separated** in the **Layout** drop-down list. Click **OK** to apply the setting and close the dialog.
12. Click on the Enable/Disable Anti-Aliasing button . This polar column plot should look something like this:

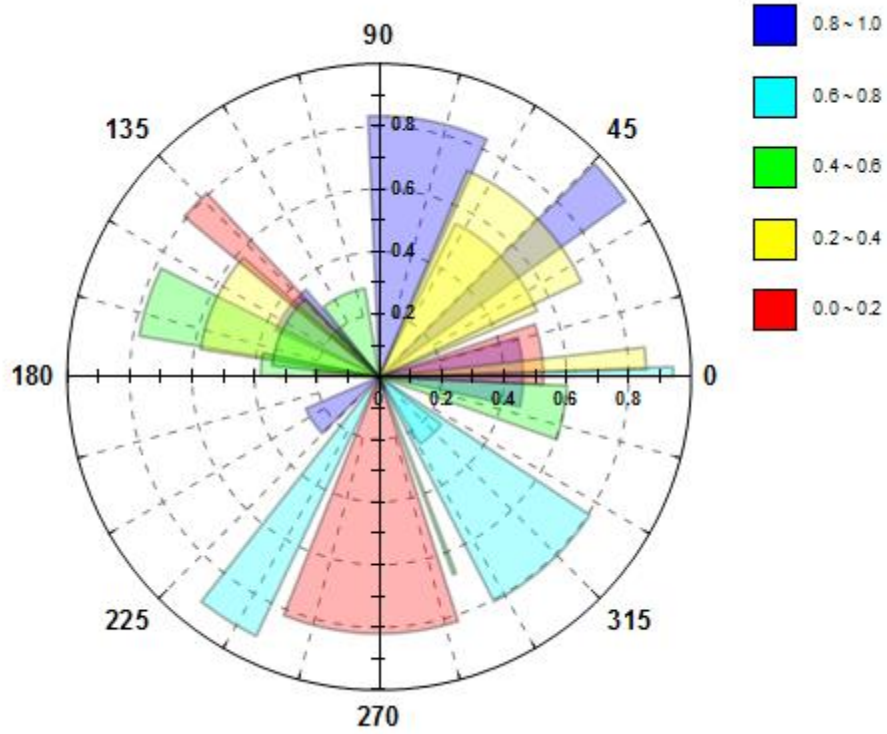

### 6.12.7.3.2 Polar Graph with Stack Columns

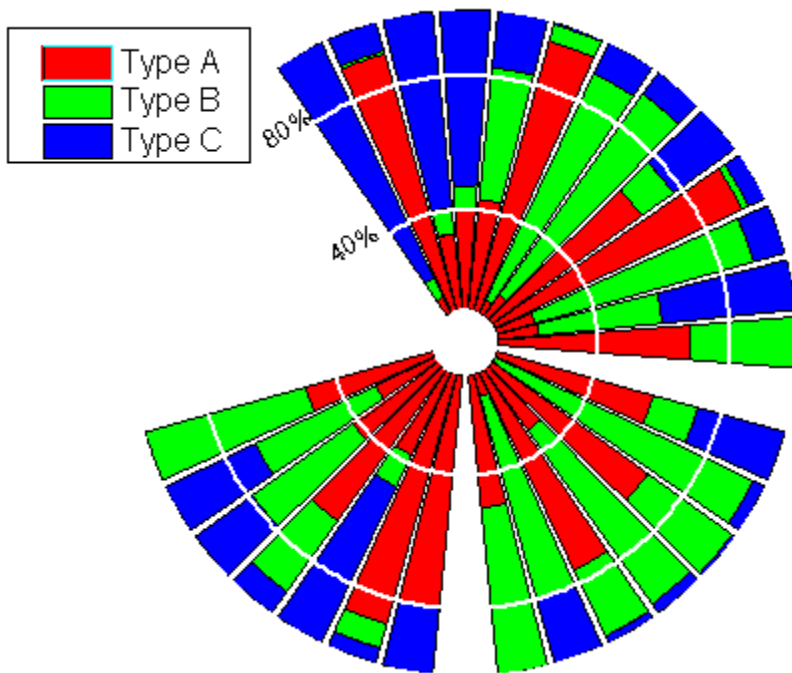

This tutorial is associated with the Tutorial Data project: <Origin EXE Folder>\Samples\Tutorial Data.opj.

1. Open the Tutorial Data project and browse to folder *Column and Stack Column* and activate **Book3F**.
2. Highlight columns B through D and select **Plot > Specialized:Polar theta(X) r(Y)** to create a grouped line plot in the polar coordinate system.
3. Double-click on the line plot to open the **Plot Details** dialog box. Make sure the left panel is expanded and set **Plot Type** to **Column/Bar** and click **Apply** to change the plot to a grouped column plot.
4. On the **Group** tab, click the ... button to the right of **Fill Color**. This opens the **Increment Editor**. Right-click on the first Background Color, black, and delete it from the increment list:

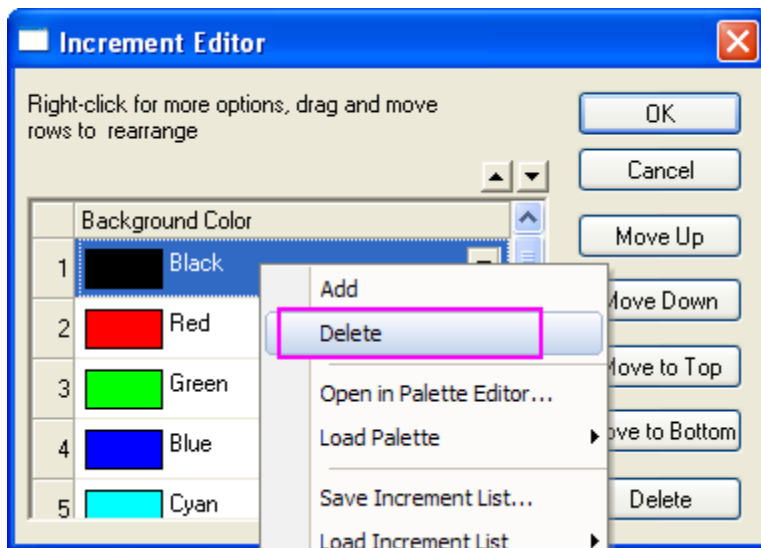

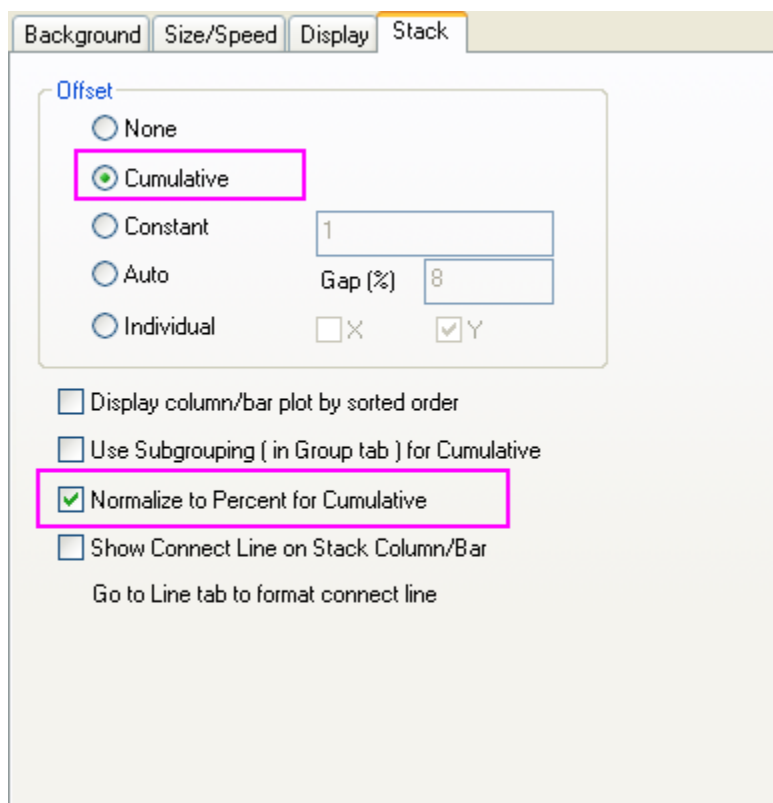

5. Click **OK** to apply the new increment list and close the **Increment Editor**.
6. Go to the **Spacing** tab and set **Gap Between Bars (in %)** to **30**.
7. In the left panel of the **Plot Details** dialog, click **Layer 1** (take care not to clear the check box) to see the **Layer Properties**. Go to the **Stack** tab and recreate the following settings so that the columns will be stacked and normalized to 100%:



8. Go to the **Display** tab and select the check box **Grid on Top of Data** to draw grid lines on top of data plot. Clear the **X Axes** check box under **Show Elements** to hide the Angular axis and its associated grid lines in the graph:

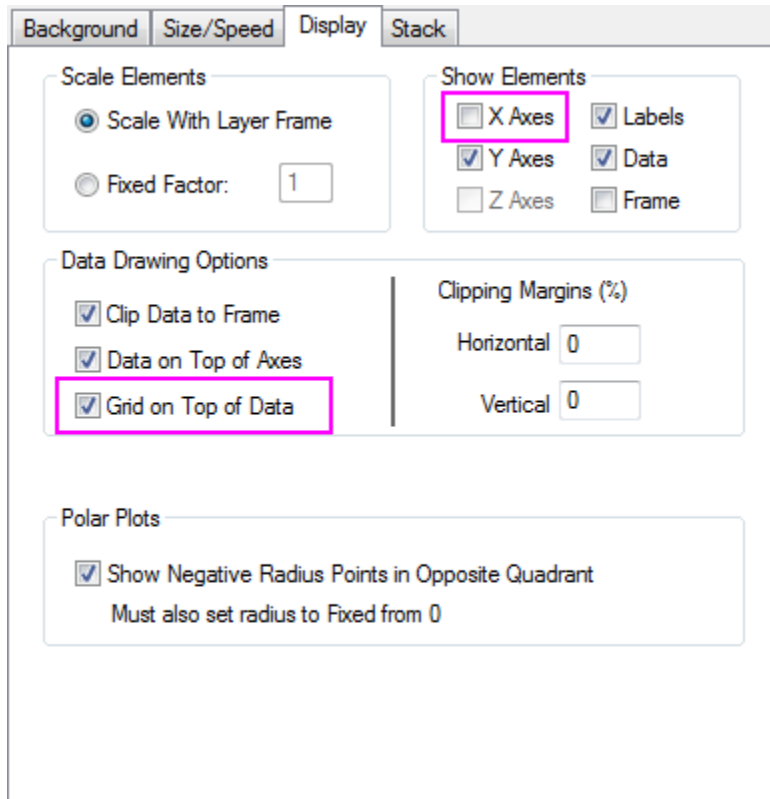



9. Click **OK** to apply the settings and close the **Plot Details** dialog box.
10. Click the  button in the **Graph** toolbar to rescale the radial axis of the graph from 0-1 to 0-100 (Or you can press **CTRL+R**).
11. We have created a 100% Stack Column graph in polar coordinate system, and now we will customize its axes. Double-click on any axis to open the **Axis** dialog. Click on the **Radial Axes Configuration** button to open the dialog box. Recreate the following settings to display only one Radial axis at 120 degrees on the polar graph. Click **OK**.

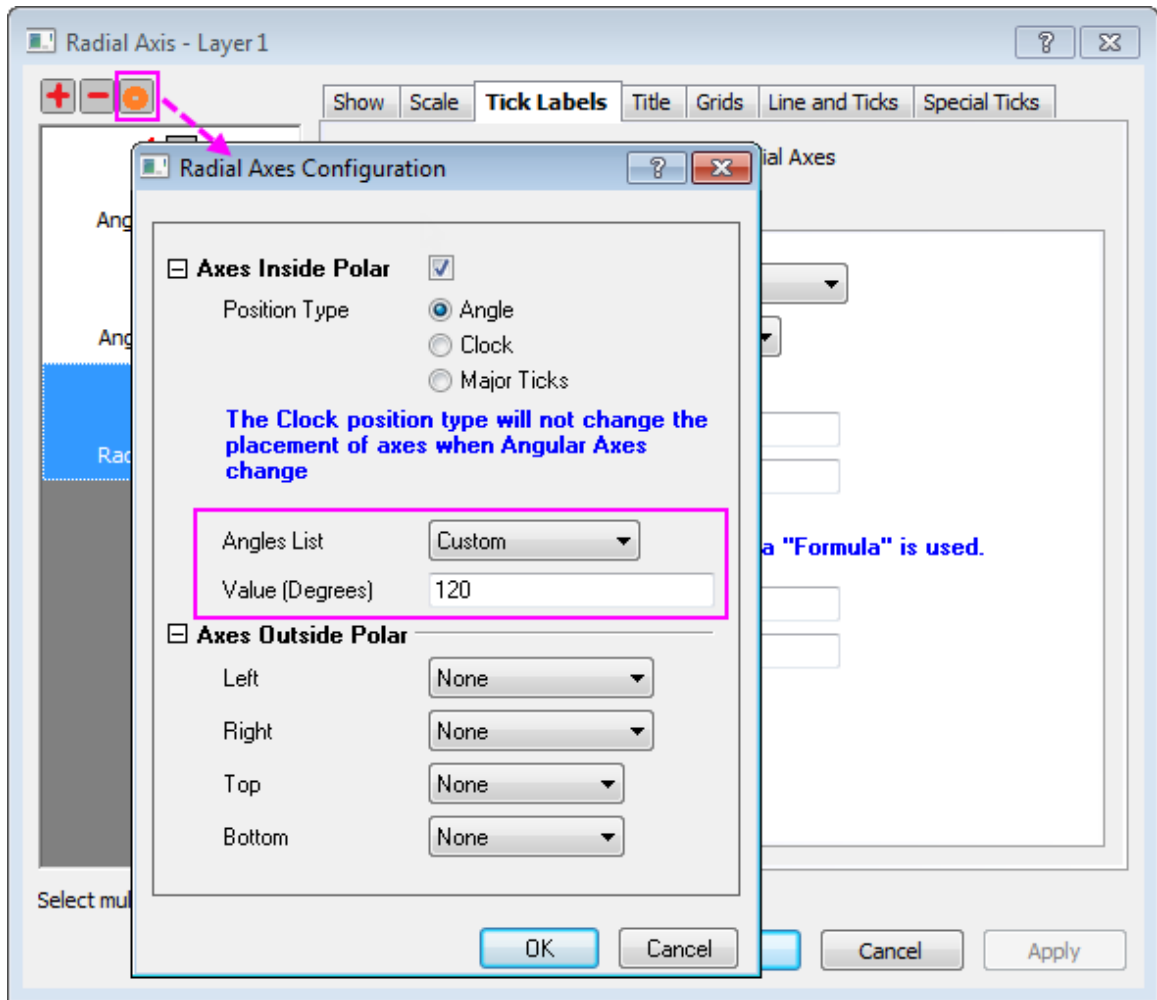

- Go to **Show** tab and you will see the **Radial - Inner 1** in the left panel. Select it, and change the **Flow Direction** to **Negative** so that the tick label will be displayed outside the data plot.

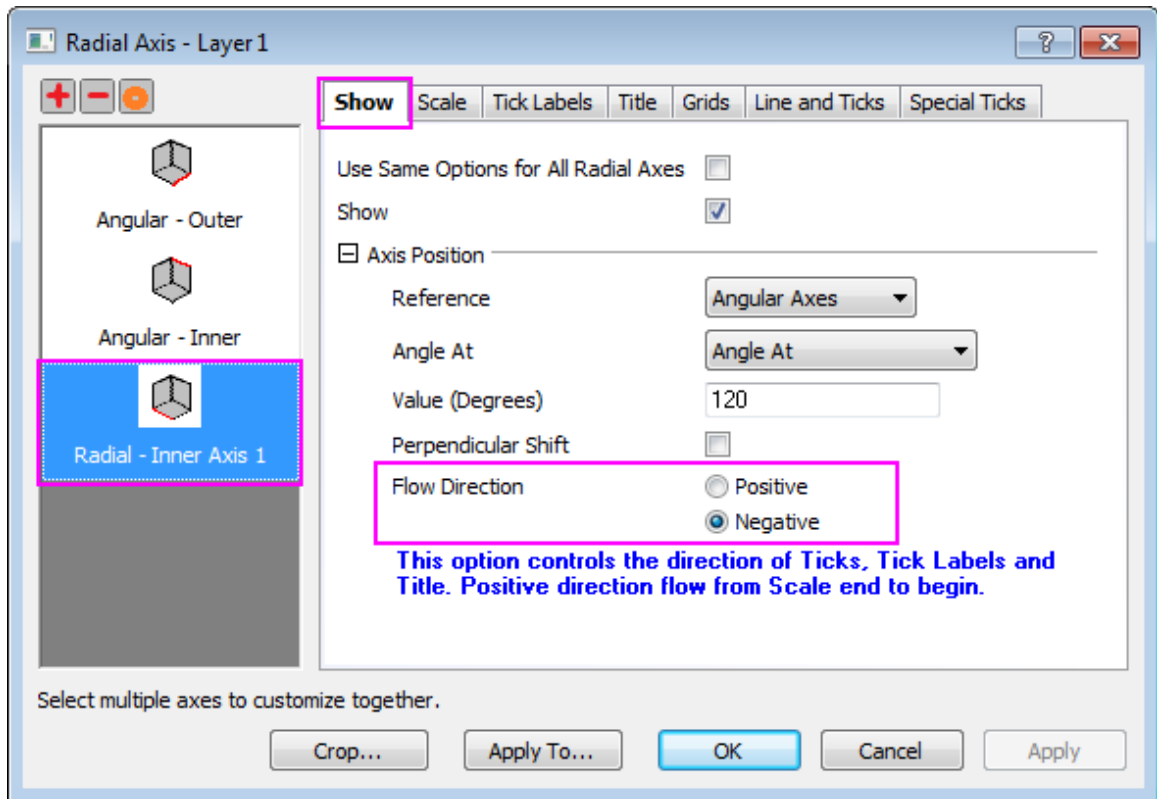

13. Go to the **Scale** tab and make sure **Radial** is selected in the left panel. Set **From: 10** and **To: 100**. Under **Major Ticks** section, choose **By Custom Position** in the **Type** drop-down list, and enter **40 80** in the **Position** text box. Set **Count** to **0** for minor ticks

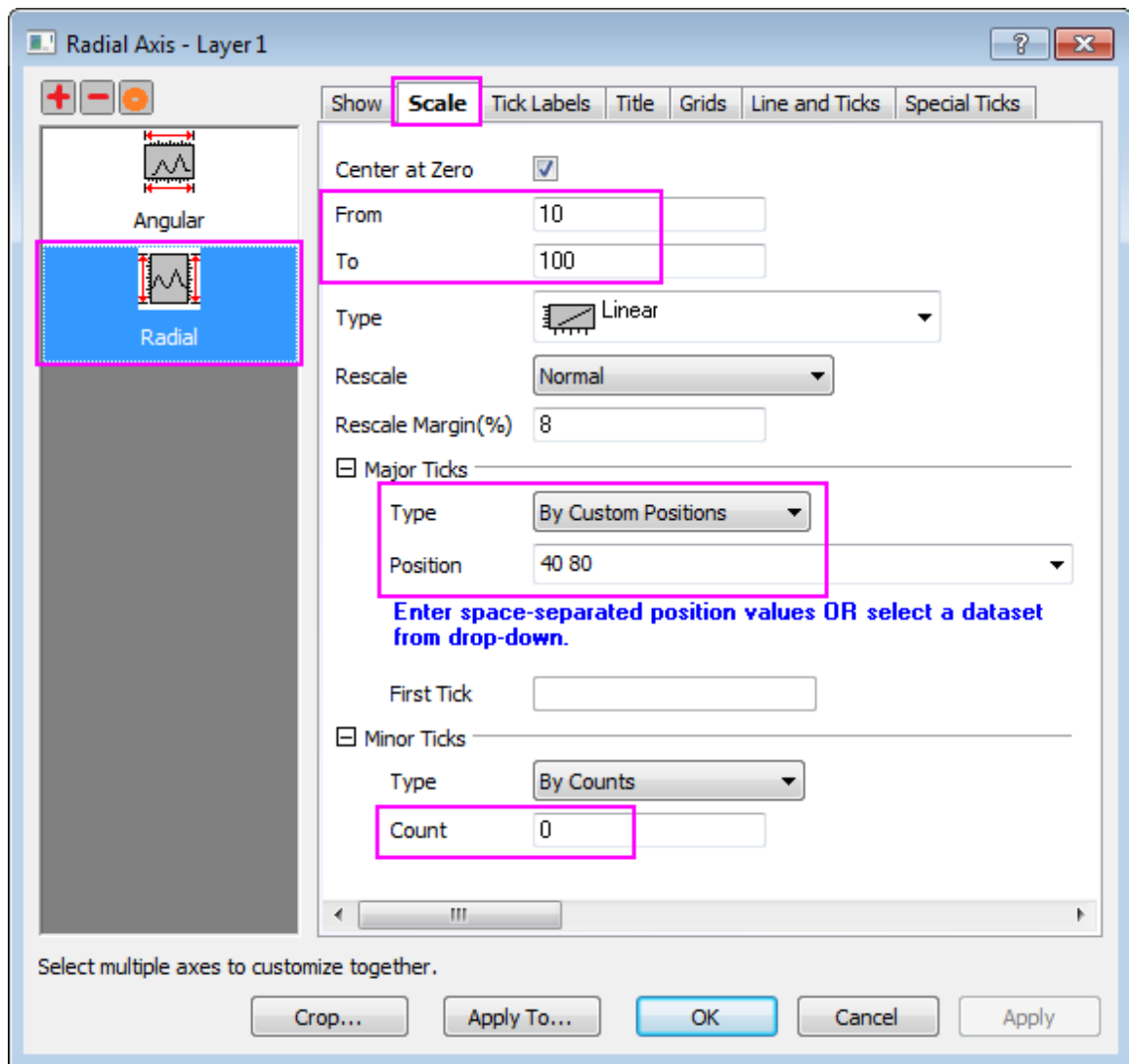

- Go to the **Grids** tab. For Radial Axes, set the major grid lines as following image:

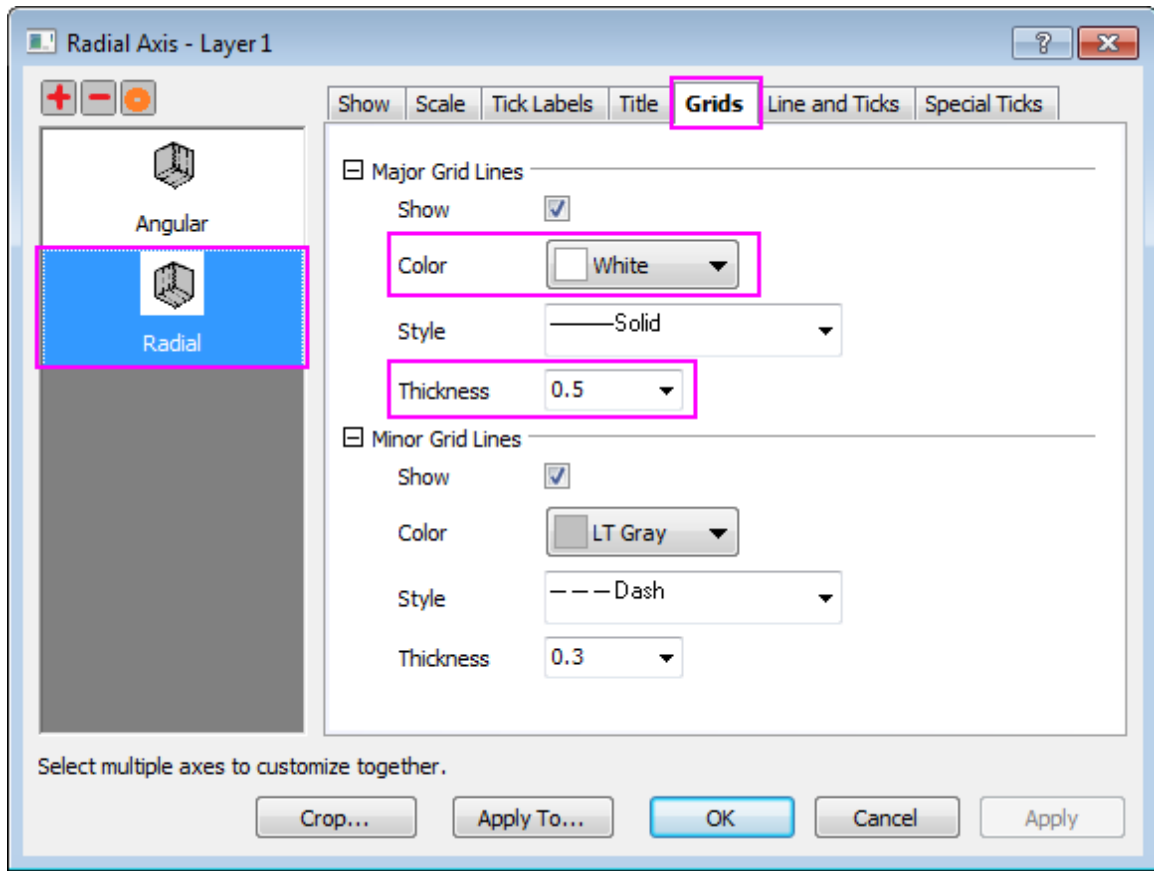

15. Go to the **Tick Labels** tab, add a **%** suffix under **Display** subtab. Add set a horizontal offset under **Format** subtab.

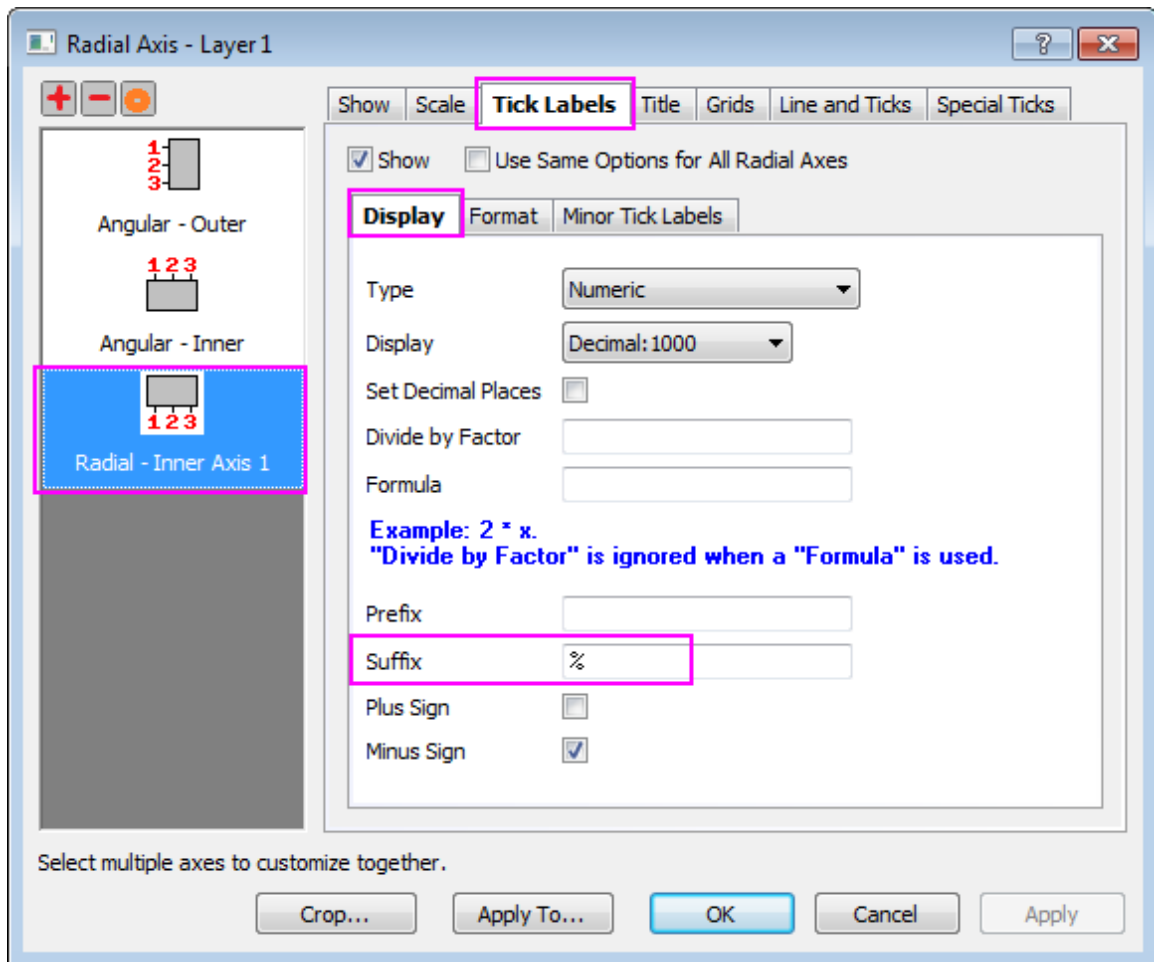

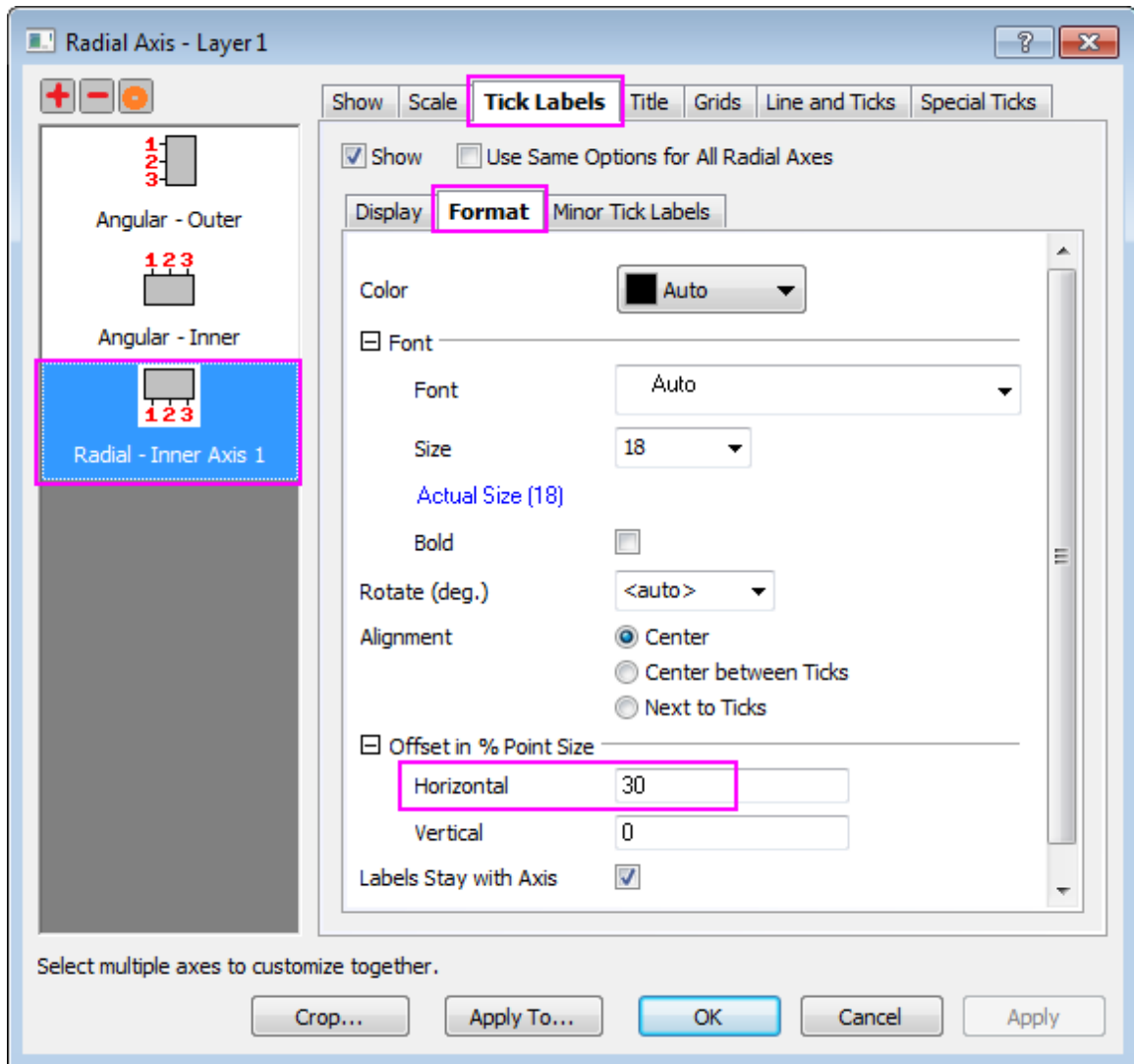

16. Go to the **Title** page and clear the **Show** check box to hide the axis title.

17. Click **OK** to close the **Axis** dialog box. Your graph should look something like this:

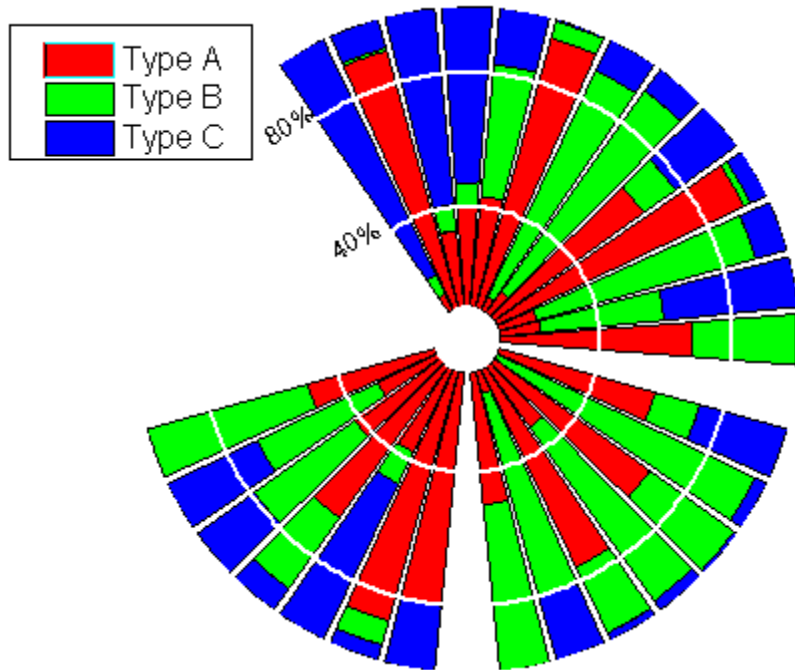

### 6.12.8 Polar Graph with Custom Angular Scale

#### 6.12.8.1 Summary

Normally, the polar angular axis unit reads in degrees, radians or gradians. However, Origin's polar graph also supports use of custom units.



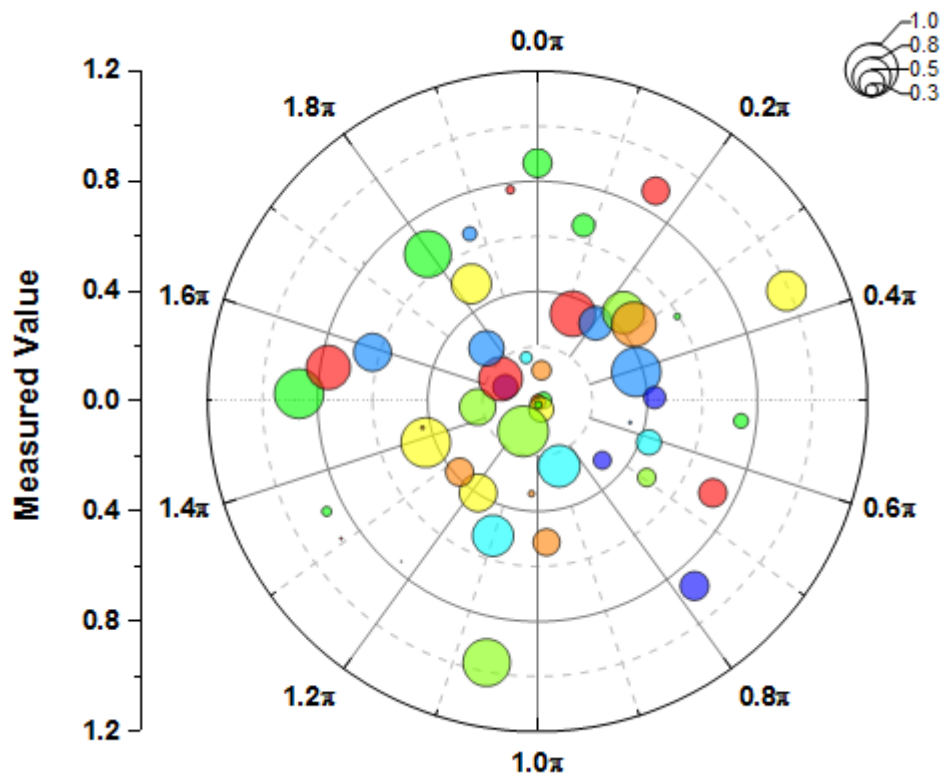

Minimum Origin Version Required: 2018b

#### 6.12.8.2 What You Will Learn

This tutorial will show you how to:

- use a dataset to control symbol size and color in a polar graph.
- use a custom unit for the angular axes.
- display tick labels as quarters.
- add and custom the bubble scale

#### 6.12.8.3 Steps

You can refer to this graph in Learning Center. (Select **Help: Learning Center** menu or press **F11** key , and then open **Graph Sample: Polar Graphs**)

1. Highlight column B and select **Plot > Specialized :Symbol theta r** to create a symbol plot in polar coordinate system.
2. Double-click on any axis to open the **Axis** dialog. Go to the **Scale** tab and select **Angular** in the left panel. In this right panel, expand **Units Definition** node, and choose **Radians** as **Units**. Make sure the

scale from **0** to **2 PI**. Then change the **Value** of increment to **0.25**

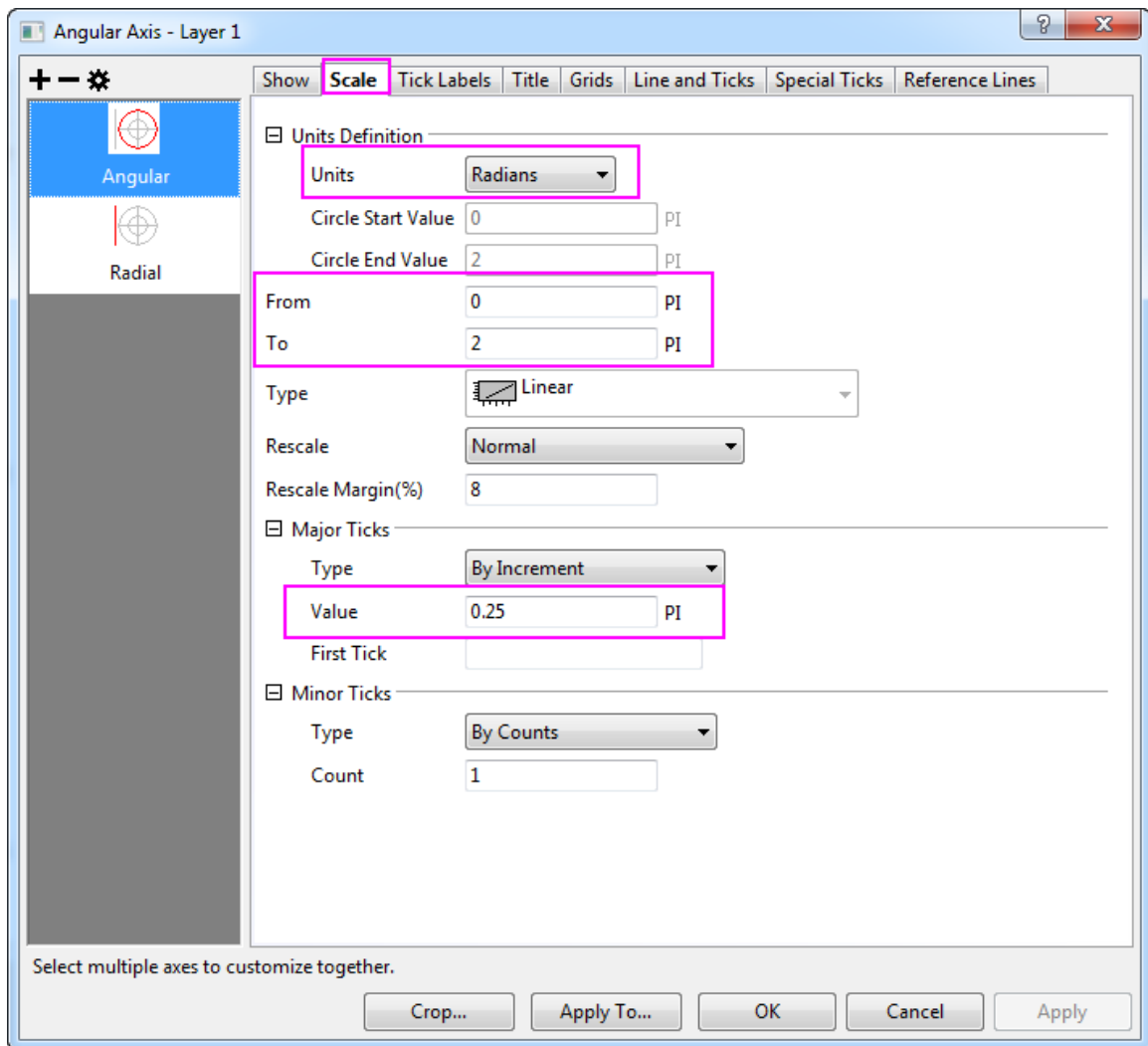

3. Go to the **Show** tab for **Angular-Outer** axis, then change the **Direction** to **Clockwise** and set **Rotate (deg.)** to **90**.

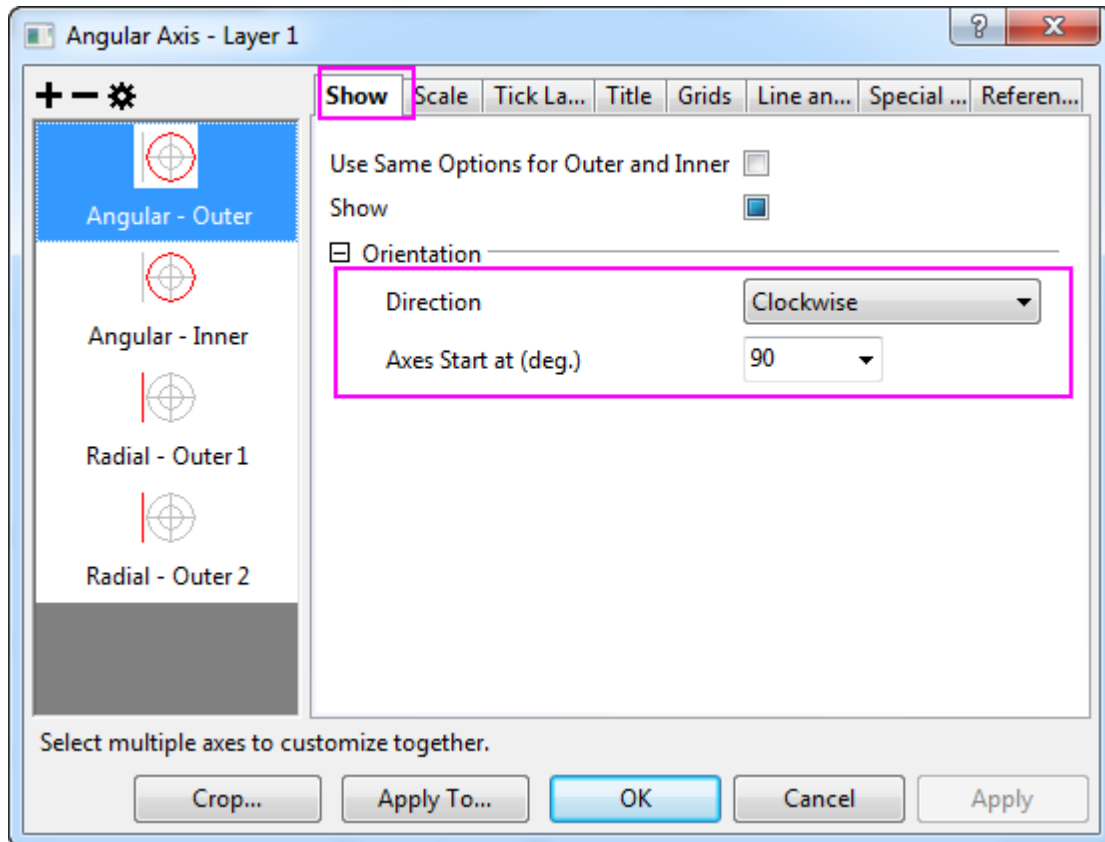

4. Go to the **Scale** tab and select **Radial** in the left panel. Then set the scale from **0** to **1.2**, and change the **Value** of increment to **0.4**.

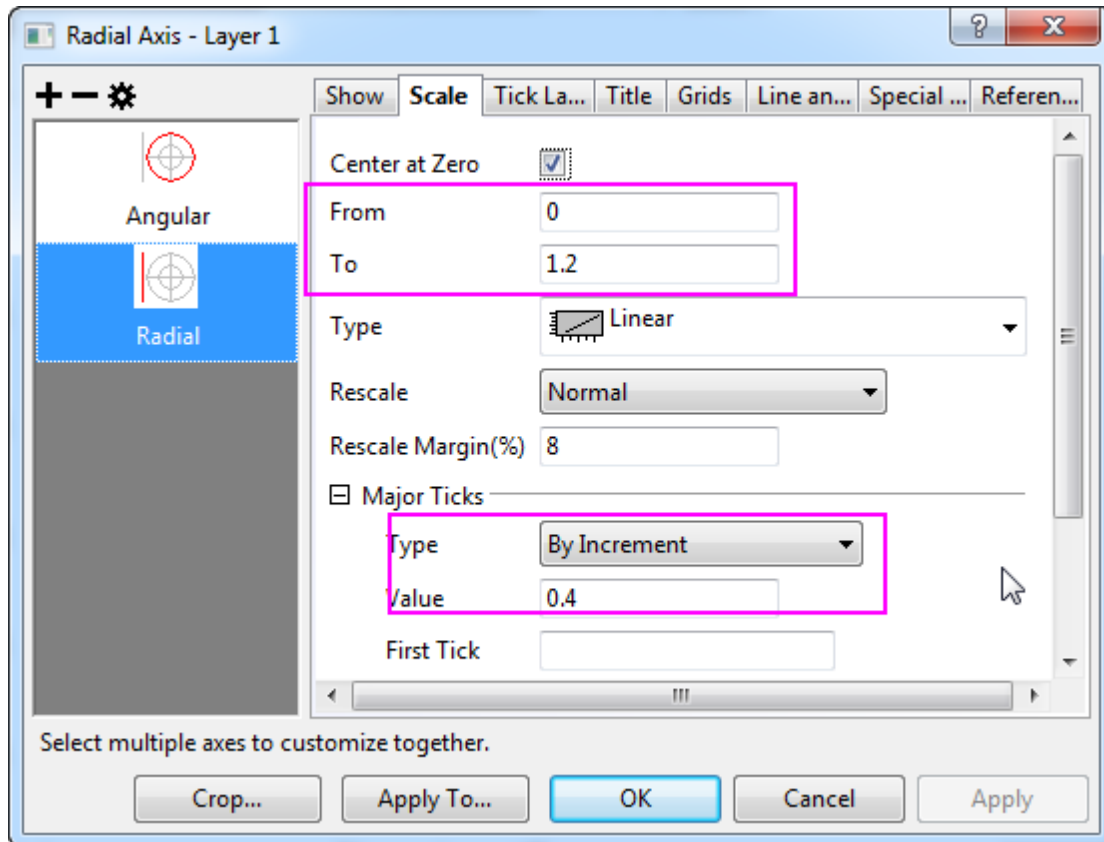

5. Go to **Tick Labels** tab for the **Angular - Outer** axis. Open **Display** subtab, set **Display** to **Custom** and enter # #/4 as **Custom Format** to show the tick labels as fractions.

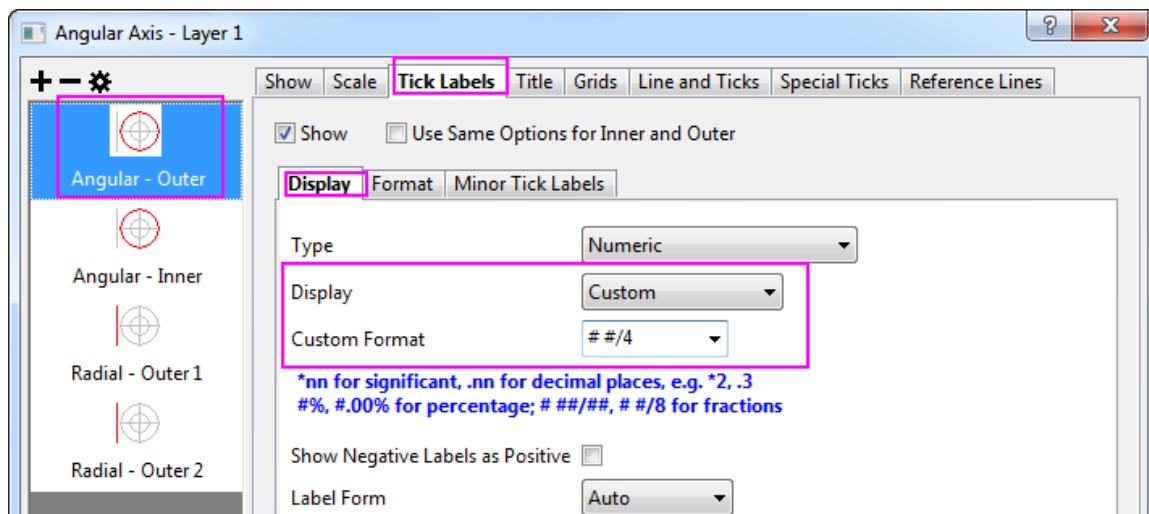

6. Select **Radial - Outer 1** axis. Choose **Format** subpage, and check the **Bold** check box. Then click the **Apply To...** button. In the pop-up dialog, make sure **Apply From** is **Outer 1** and **Apply to** is **All Axes**, then check the **Bold** under the **Tick Labels**. Click **OK**.

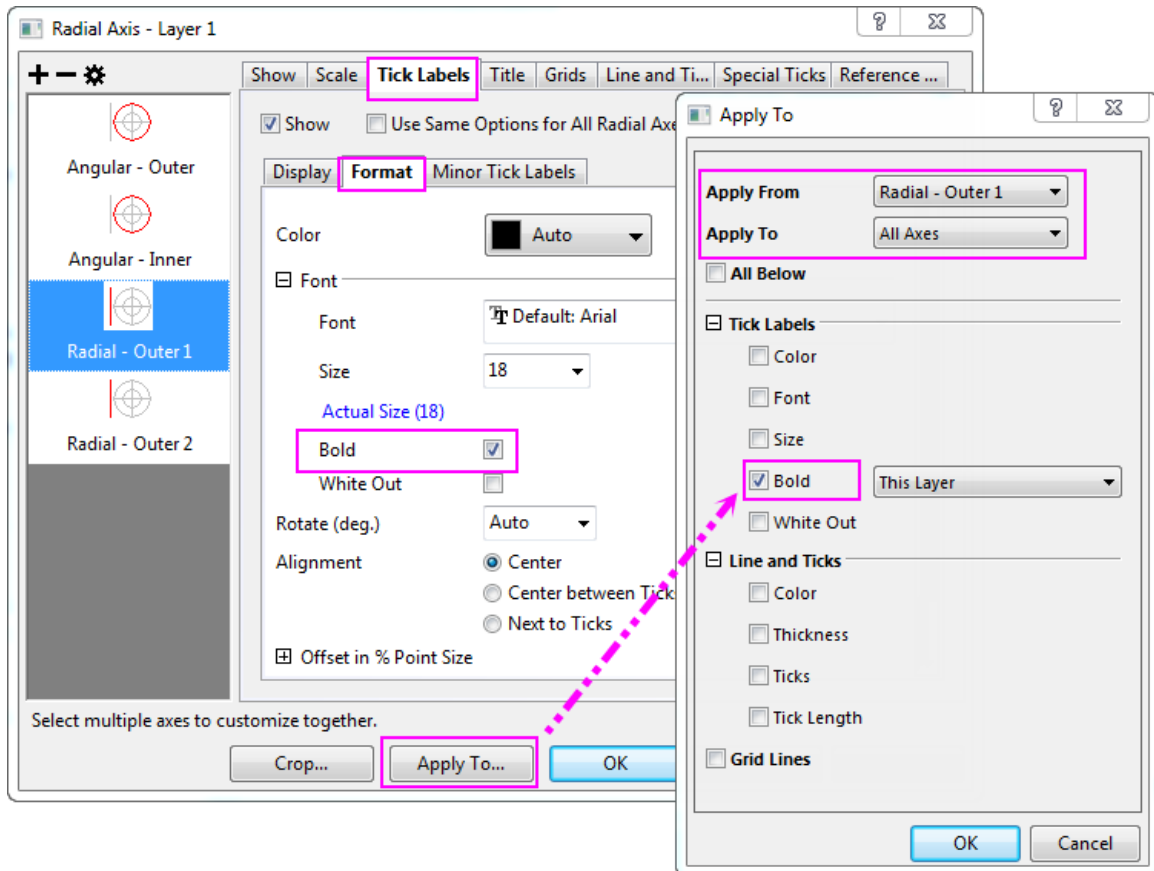

In Axis dialog, click **OK** to apply settings and close the **Axis** dialog.

7. Double-click on the line plot to open the **Plot Details** dialog, in the **Symbol** tab, recreate the following settings, in the sequence shown in the screenshot:

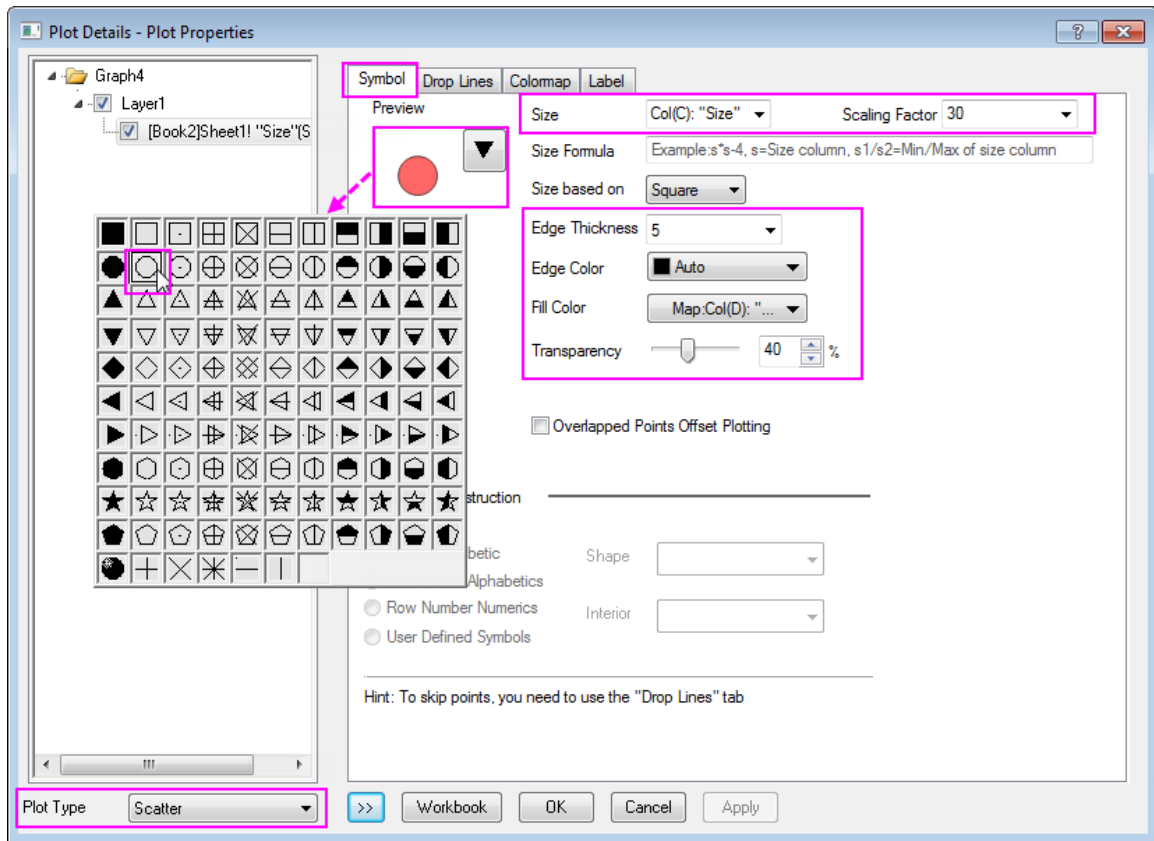

Click **OK** to apply the settings and close the **Plot Details** dialog.

8. Select **Bubble Scale** in the **Insert** main menu to add a bubble scale in this graph.
9. Right-click on the bubble scale, and choose **Propertise...** to open the control dialog. Go to the **Levels** page, set the level from **0** to **1**, and change the **Value** of increment to **0.25**.

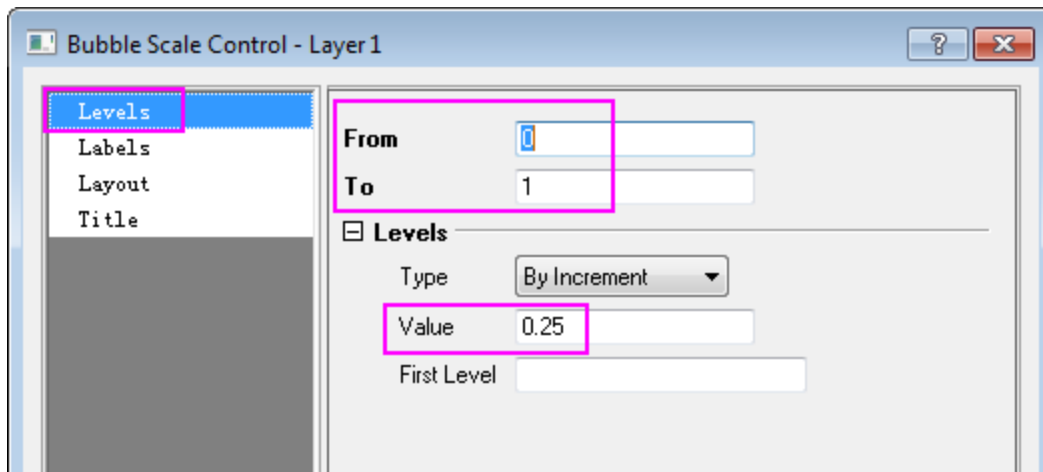

10. Go to **Labels** page, check the **Set Decimal Places** check box and enter **1** in the **Decimal Places** text box.

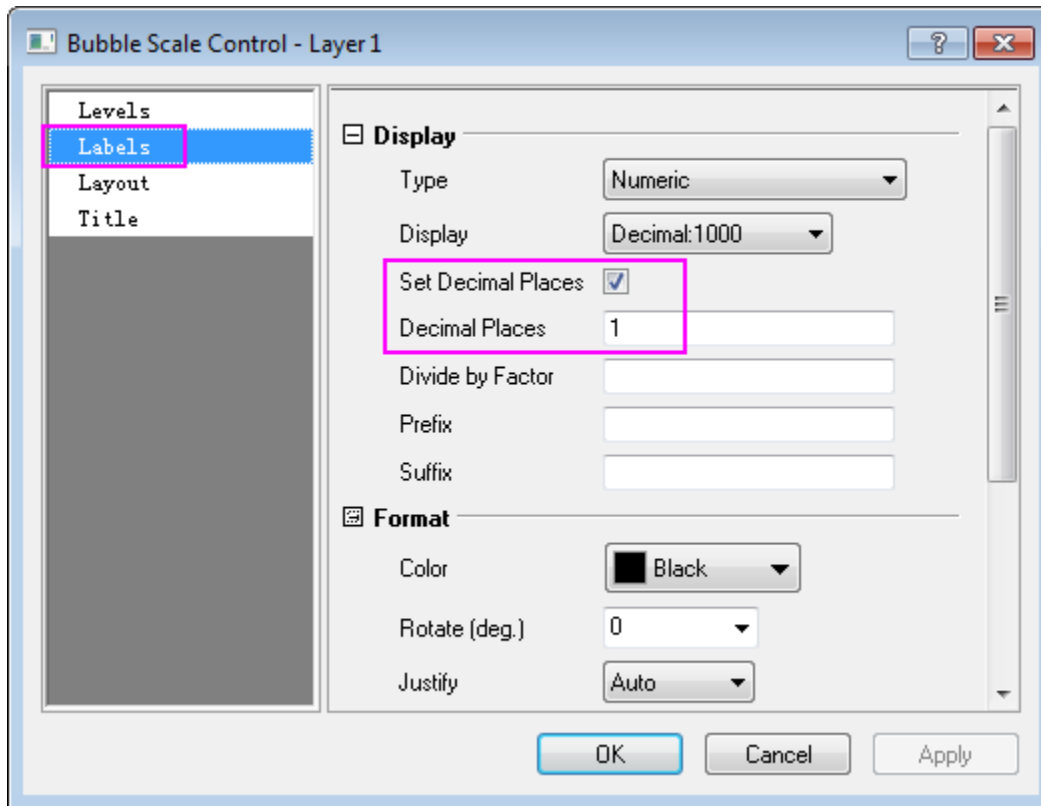

11. Go to **Layout** page, choose **Nested** in **Layout** drop-down list. Select **Black Edge and No Fill** as **Bubble style** and change the **Label Offset from Symbol Center** to **150**. Check the **Show Leader Line** check box, then expand the node to check the **Auto Reoisition to Avoid Overlapping** check box. Click **OK** to apply the setting and close the dialog.

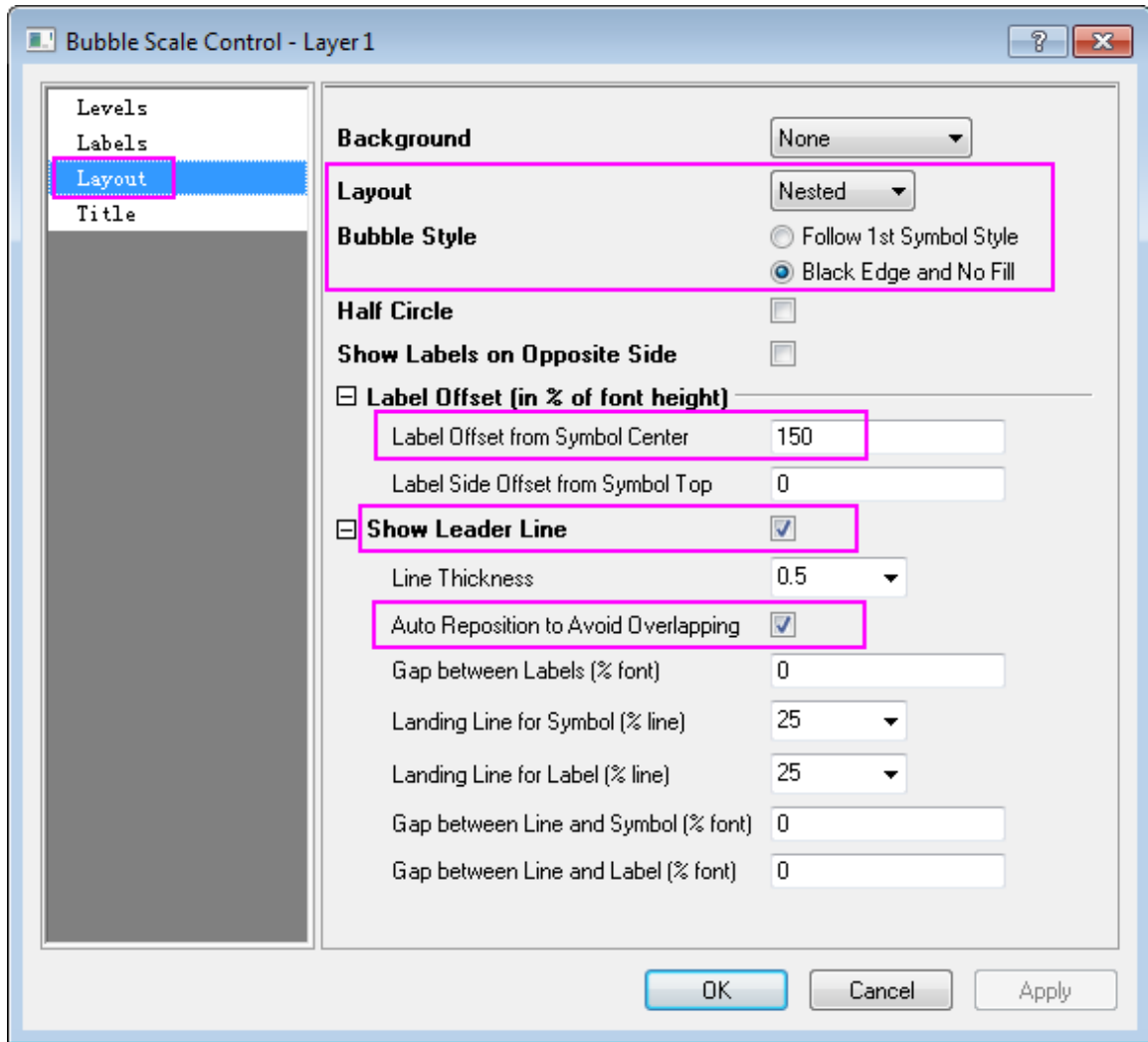

Manually move the legend object and Radial axis, and click the **Enable\Disable Anti-Aliasing** button





to smooth the graph. The final graph should look like this:

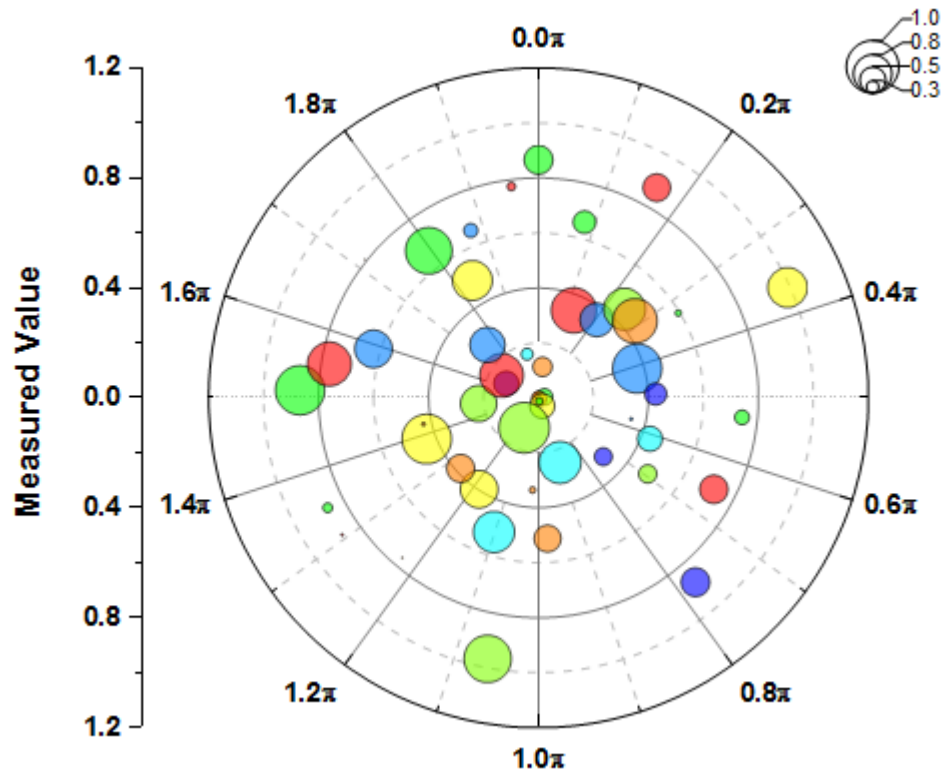

## 6.13 3D Graphs

### 6.13.13D Graphs

- [3D Pie Chart](#)
- [3D Vector](#)
- [3D Scatter Plot with Line Projections of Core Drilling Locations](#)
- [3D Bar and Symbol](#)
- [Surface with Missing Values](#)
- [Creating Intersecting Surface Plots from Worksheets](#)
- [Intersecting Color Surfaces](#)
- [Surface with Symbols and Droplines](#)
- [Colormap from Second Matrix](#)
- [Color Map Surface Graph](#)
- [Parametric Surface with Colormap from Data](#)
- [Stacked 3D Surface Plots](#)
- [Multiple Surfaces in Same Layer](#)

- [3D Scatter with Colormap](#)
- [3D Scatter with Droplines](#)
- [Surface With Transparent Plane](#)
- [3D Bar on Flatten Surface](#)
- [3D Bar with Labels](#)
- [3D Surface with Point Label](#)
- [Transparent Parametric Surfaces combined with Scatter Plot](#)
- [Convert Data from Spherical Coordinate to XYZ and Make a 3D Plot](#)
- [Flattened Colormap Surfaces with Increasing Z Offset](#)
- [3D Ternary Colormap Surface with Contour Lines Projection](#)

## 6.13.23D Pie Chart

### 6.13.2.1 Summary

Origin's 3D Pie Chart gives you complete control over the look of the plot. Set the thickness of the pie slice, displacement, view angle, and size and rotation of the chart. You can even choose to explode the view of one or more pie slices.

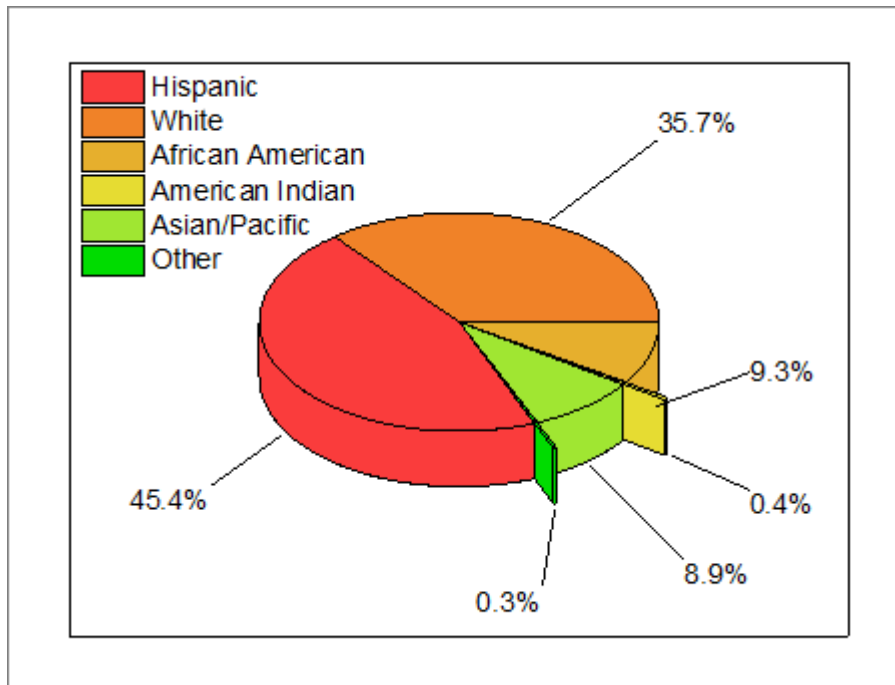

### 6.13.2.2 What you will learn

- Create a 3D pie chart and change the plot colors.
- Modify the pie chart view angle.
- Explode the view of pie slices.

- Label pie slices, add leader lines and drag to re-position labels.

### 6.13.2.3 Steps

You can refer to this graph in Learning Center. (Select **Help: Learning Center** menu or press **F11** key , and then open **Graph Sample: Statistical Graphs**)

1. Import the data `\Samples\Graphing\3D Pie Chart.dat` into worksheet, and rename the column long name as *Demographic* and *Percent*.
2. Highlight the 2nd column and create a 3D Pie Chart by clicking **Plot > Basic 2D: 3D Color Pie Chart**.
3. Double-click the pie chart to bring up the **Plot Details** dialog. On the **Pattern** tab, in the **Fill** group, click the **Color** drop-down and then on the **By Points** tab of the Color Chooser, click on the **Color List** drop-down.

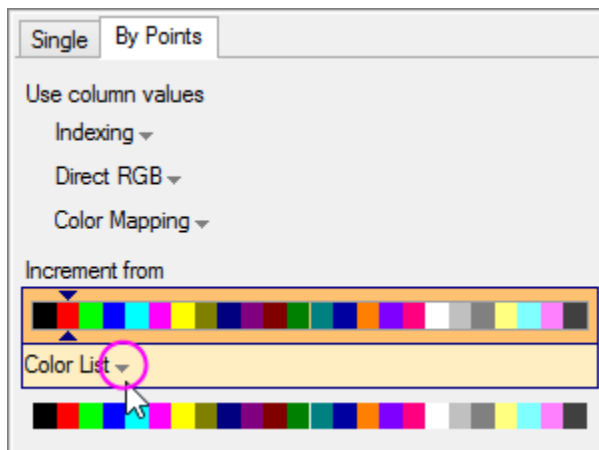

4. Choose the **System Color List**, then move the **Increment from** slider to the right one color position, then click **Apply**.

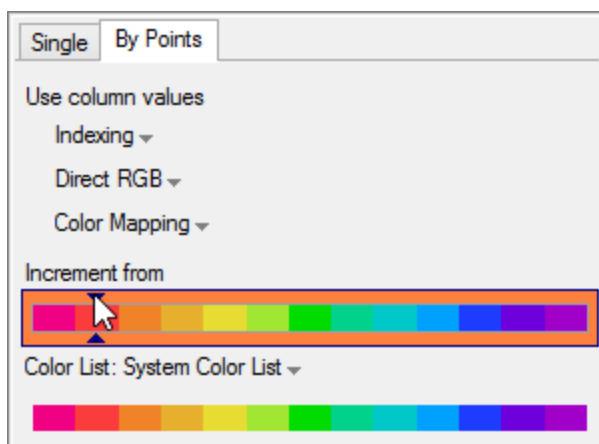

5. Click the Pie Geometry tab and duplicate the following settings:

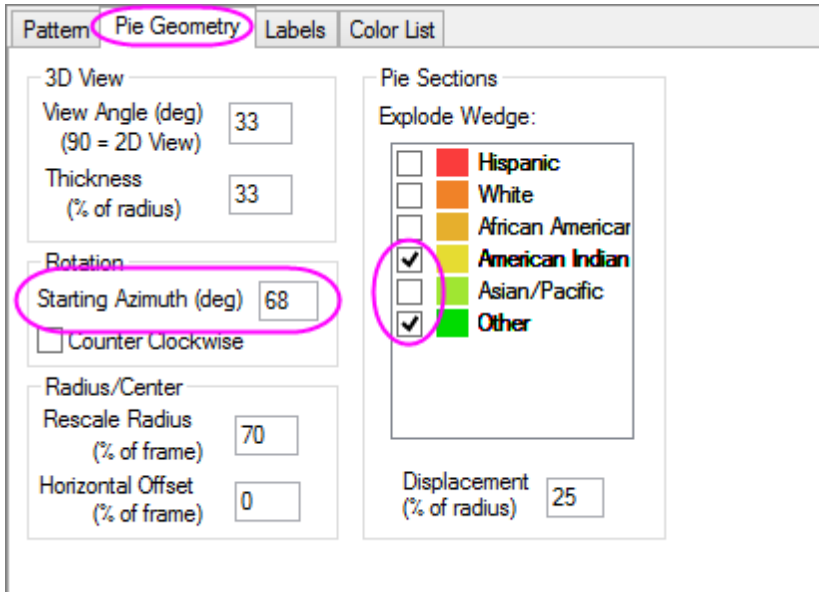

- Click on the **Labels** tab and in the **Position** group, clear the **Associate with Wedge** check box. Enable Show Leader Line if Offset Exceeds (%) and enter an offset of 2.

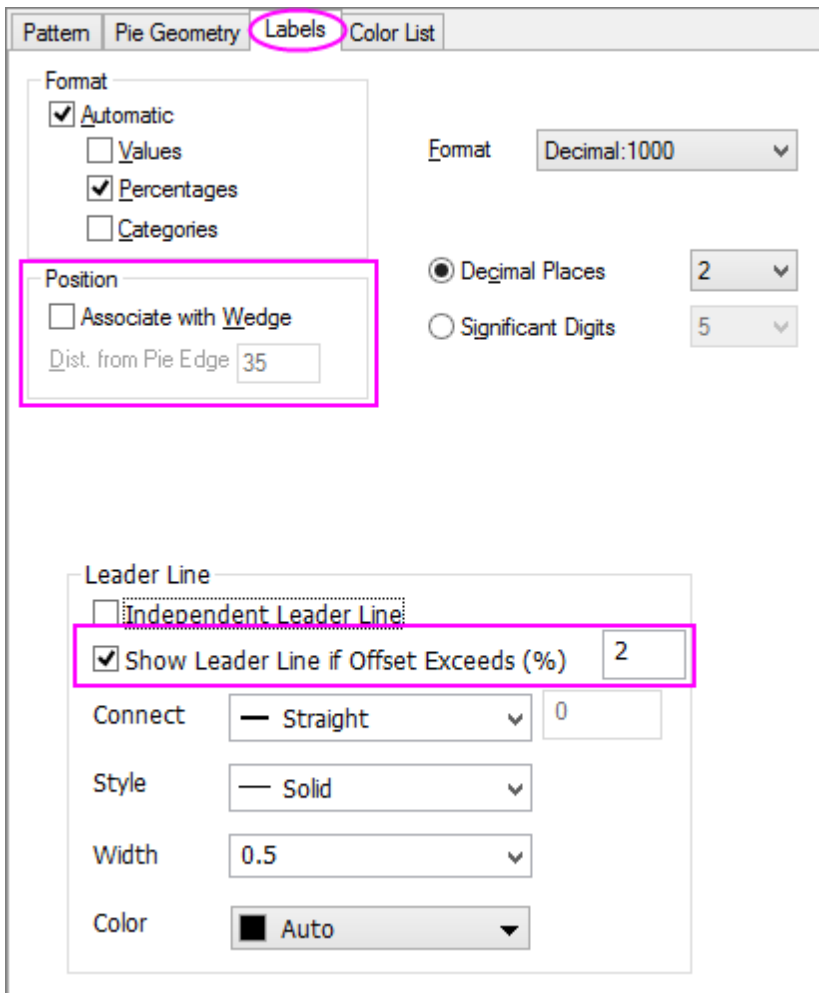

7. Click **OK** to close Plot Details. Drag the graph legend to the left side of the pie. Drag wedge labels to reposition them, noting that the leader line follows the label. Your graph should now look something like this:

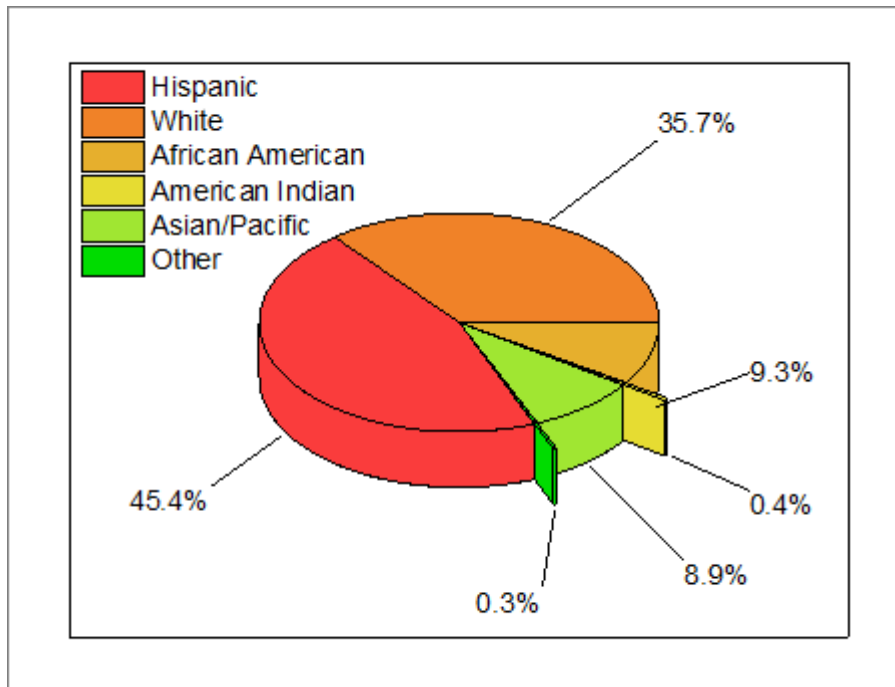

### 6.13.33D Vector

#### 6.13.3.1 Summary

Origin can plot 3D Vectors from two different data structures: **XYZ XYZ** and **XYZ dXdYdZ**.

XYZ dXdYdZ defines the tail and head data for the vector, while XYZ XYZ provides the vector's tail data and the distance between tail and head projections on X, Y, and Z axes.

#### 6.13.3.2 What you will learn

- Create a 3D Vector from XYZ dXdYdZ worksheet data.
- Customize the 3D Vector

#### 6.13.3.3 Steps

This tutorial is associated with <Origin EXE Folder>\Samples\Tutorial Data.opj.

Also, you can refer to this graph in Learning Center. (Select **Help: Learning Center** menu or press **F11** key , and then open **Graph Sample: 3D Symbol Bar and Wall**)

1. Open **Tutorial Data.opj** and browse to the **3D Vector** folder in **Project Explorer** (PE).
2. Select workbook **Book2**. Click in the upper left corner of the worksheet to select all data.

3. On the main menu, select **Plot > 3D : 3D Vector XYZ dXdYdZ**. This will create a 3D Vector graph with our built-in template.

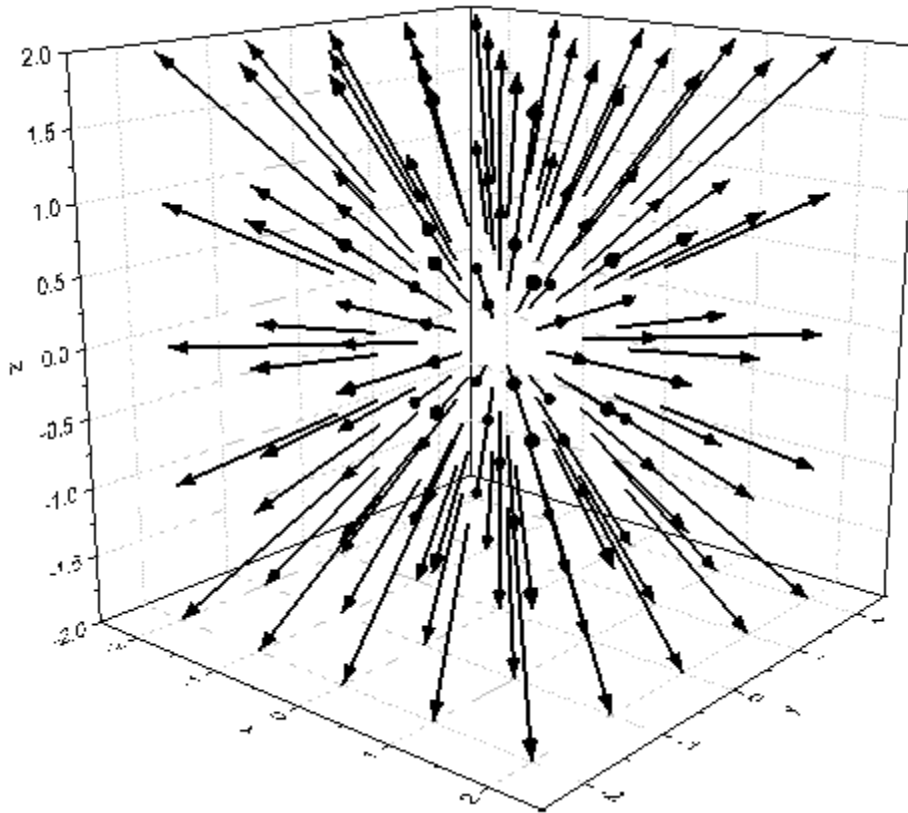

4. Double-click on the vector plot to open the **Plot Details** dialog box. Ensure that the **Original** vector plot has been selected in the left panel of the dialog box. Select the **3D Vector** tab.
  - In the **3D Vector** tab of **Plot Details** dialog box, set the parameters as shown in the following graph. Click the **Color** button and select **Dark Green** from the menu.

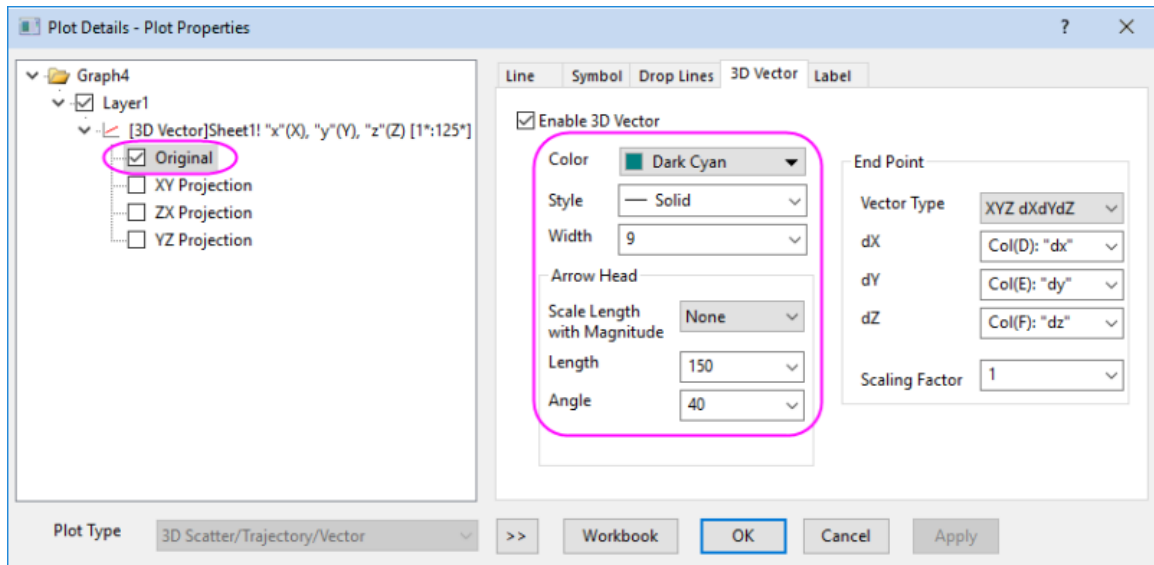

Click **OK** to apply these settings and close the dialog box.

5. Go to **Lighting** tab in **Format: Layer** dialog, Set the lighting attribute follows graph below:

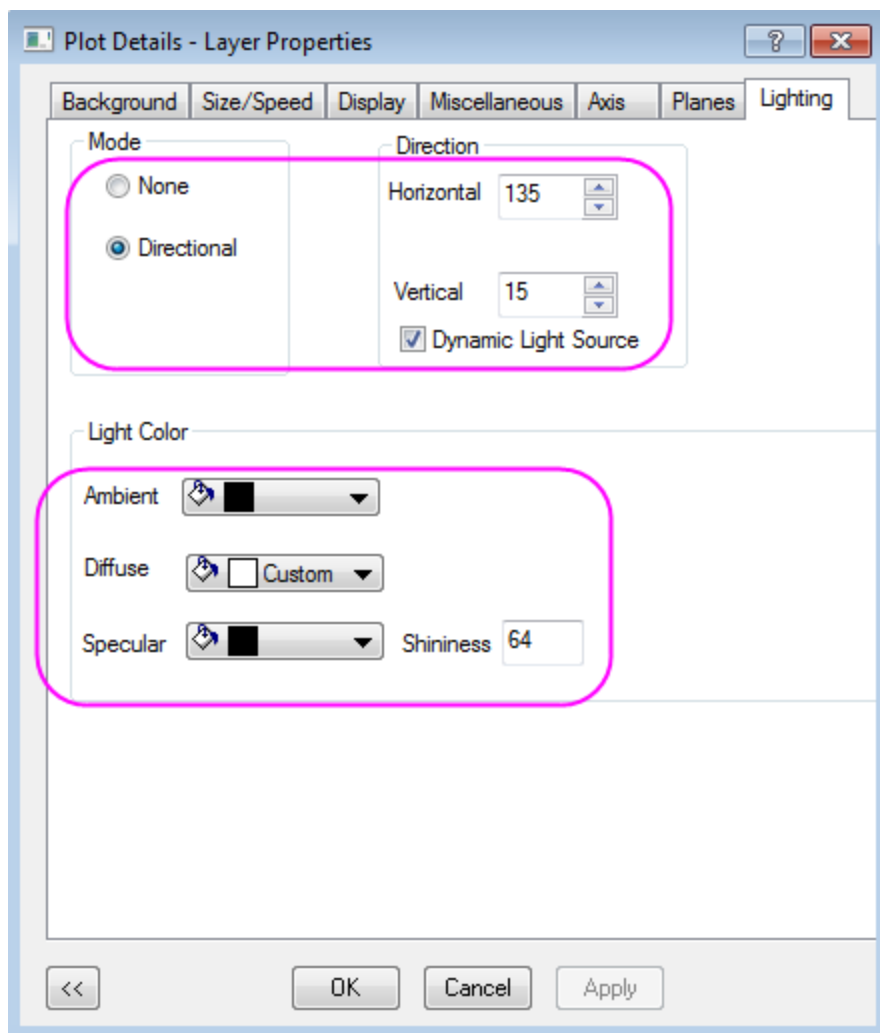

6. Rotate the graph to a proper perspective. The final graph should look something like this:



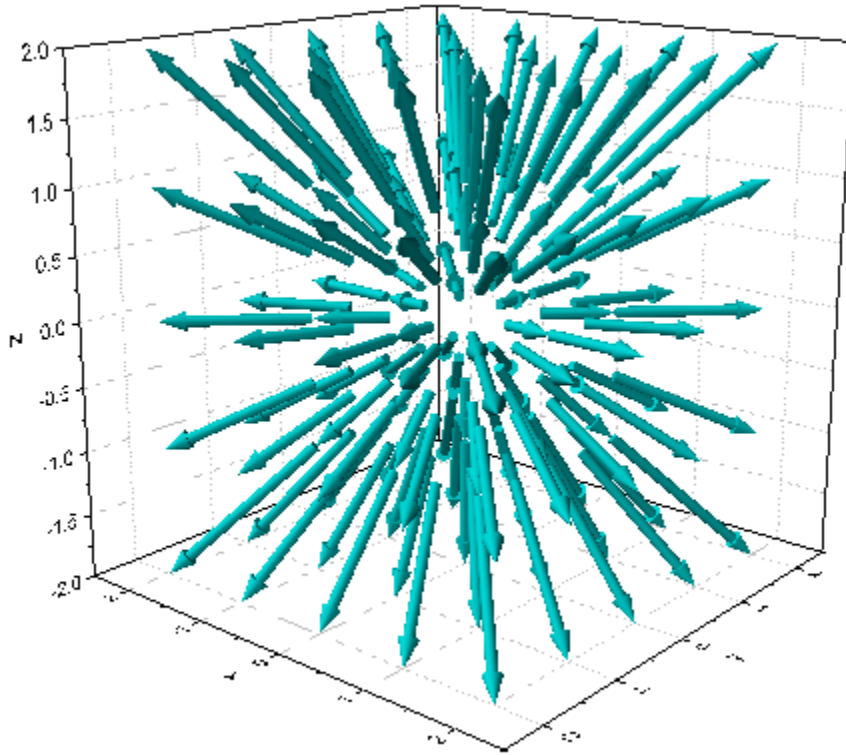

### 6.13.43D Scatter Plot with Line Projections of Core Drilling Locations

#### 6.13.4.1 Summary

This tutorial will demonstrate how to create a 3D scatter plot and show the projections of the plots.

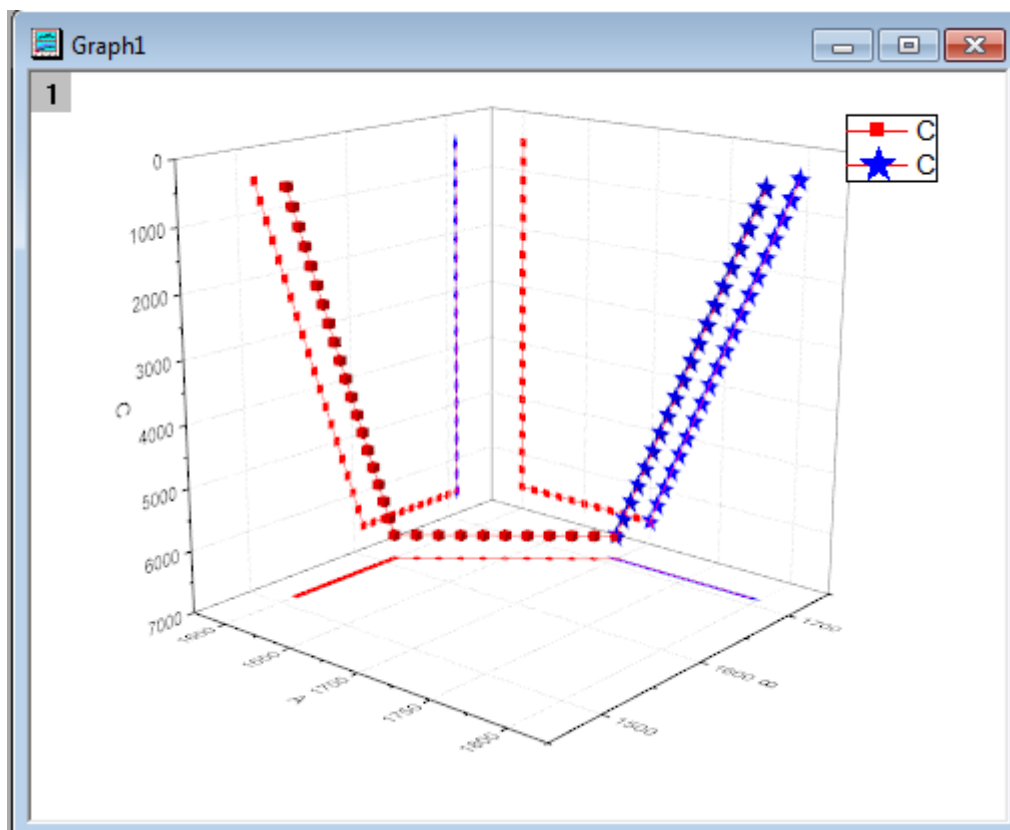

Minimum Origin Version Required: Origin 2015 SR0

#### 6.13.4.2 Steps

This tutorial is associated with the Tutorial Data.opj file under <Origin EXE Folder>\Samples\.

1. Open the Tutorial Data.opj file and browse to the folder **3D Scatter with Line Projections**, activate the workbook **3DScatterPlot**.
2. Activate the **The\_First\_Curve\_of\_3D\_Scatter** worksheet. The column designation for the three columns is already set as XYZ so you could directly create a 3D scatter plot. Highlight column **C** and select **Plot > 3D: 3D Scatter** to create the plot.
3. Activate **The Second Curve of 3D Scatter** worksheet. Highlight column **C**. Move the mouse cursor



to the right edge of the selection area until the shape of the cursor changes to . Hold down the left mouse button and drag the highlighted data into the newly created graph window. The resulting graph should appear as shown below:

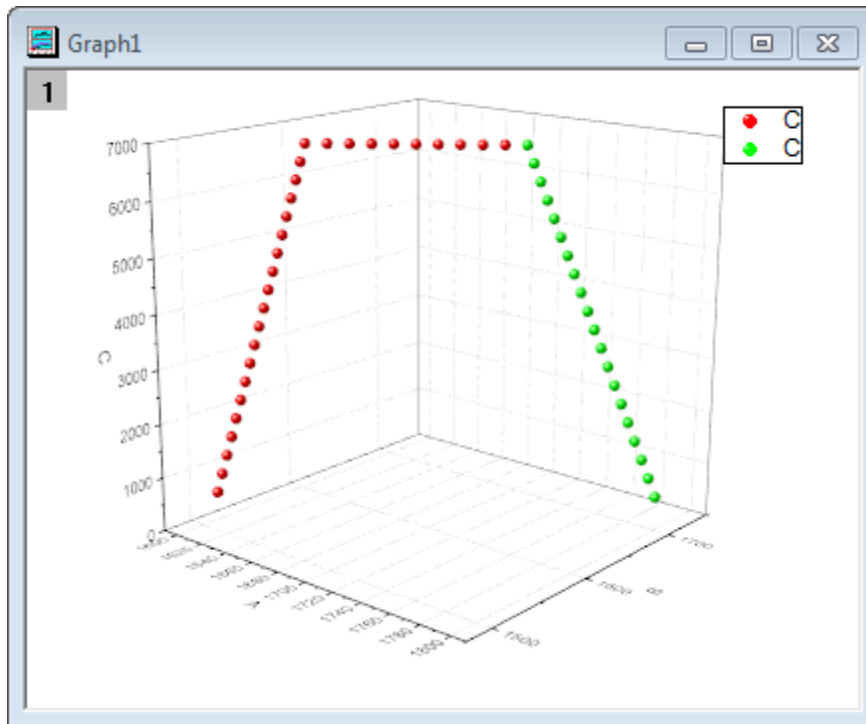

4. Double-click on the Z axis to open the **Axis** dialog, go to the **Scale** tab with **Z** icon on left panel selected and reverse the Z axis by exchanging **From** and **To** values.

**Z Axis - Layer 1**

Use Only One Axis For Each Direction

**Show** **Scale** Tick Labels Title Grids Line and Ticks Special Ticks B

From: 7000  
To: 0

Type: Linear

Rescale: Normal

Reverse:

Major Ticks

Type: By Increment

Value: 1000

First Tick:

Minor Ticks

Type: By Counts

Count: 1

- Click **OK** to close dialog. Select **Format: Layer** from the main menu to open the **Plot Details** dialog. Alternatively you can double-click on the plot to bring up the dialog. If the left panel is not visible, use

the  button on the bottom left of the dialog box to open it up. Expand the **Layer1** node. Choose the first plot and select **All Together** from the **Edit Dependencies** page. This applies the same settings to the original data and all the projections.

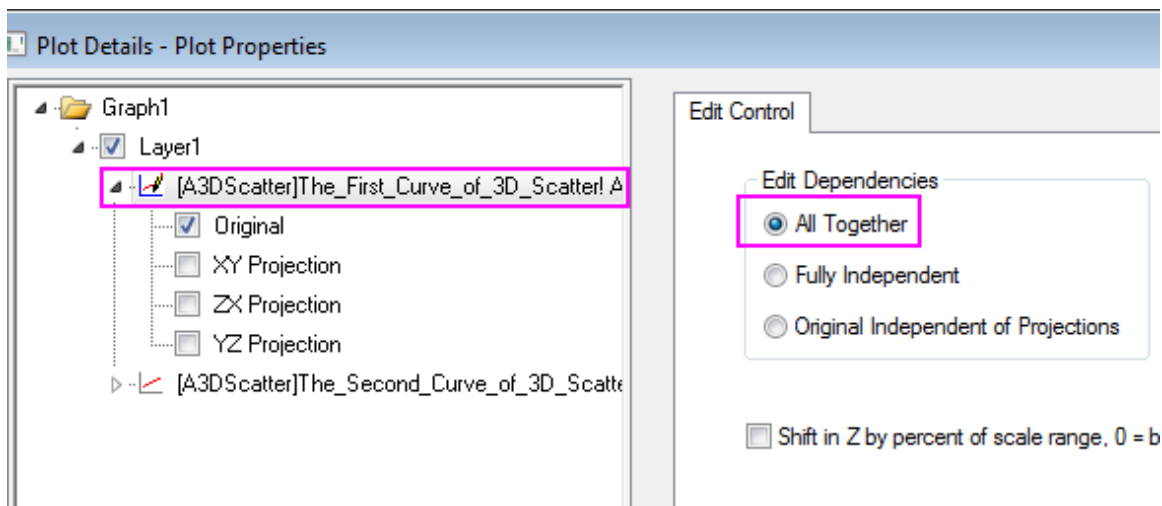

- Expand the first plot node and select **Original** and **XY/XY/YZ Projection** check box.
- Set the dialog options to those shown in the screenshot below. To set the color, click on the **Color** button and choose the desired option from the **Individual Color** drop down. Since the **All Together** radio button was selected in the previous step, these settings automatically apply to the projections as well.

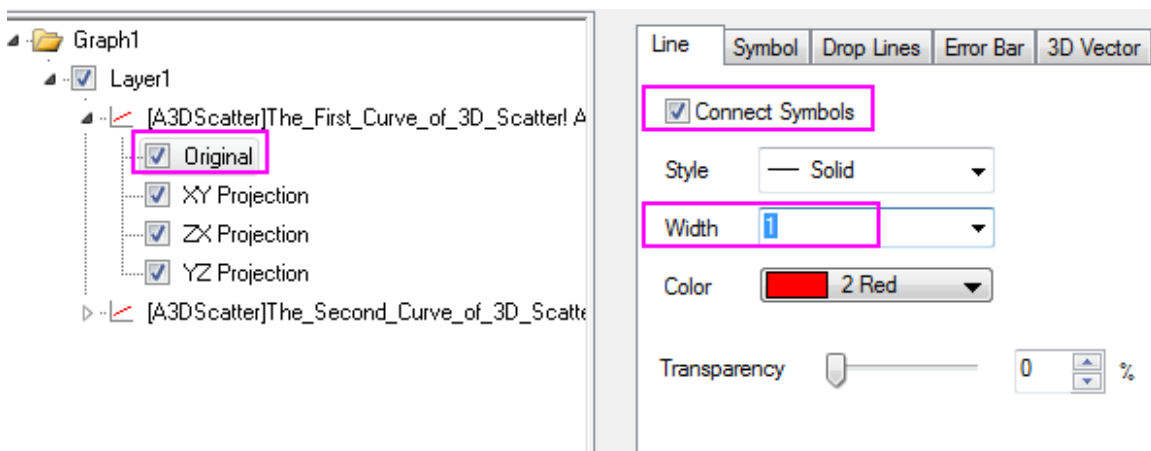

- Select the **Symbol** tab and change the **Shape** to **Cube**:

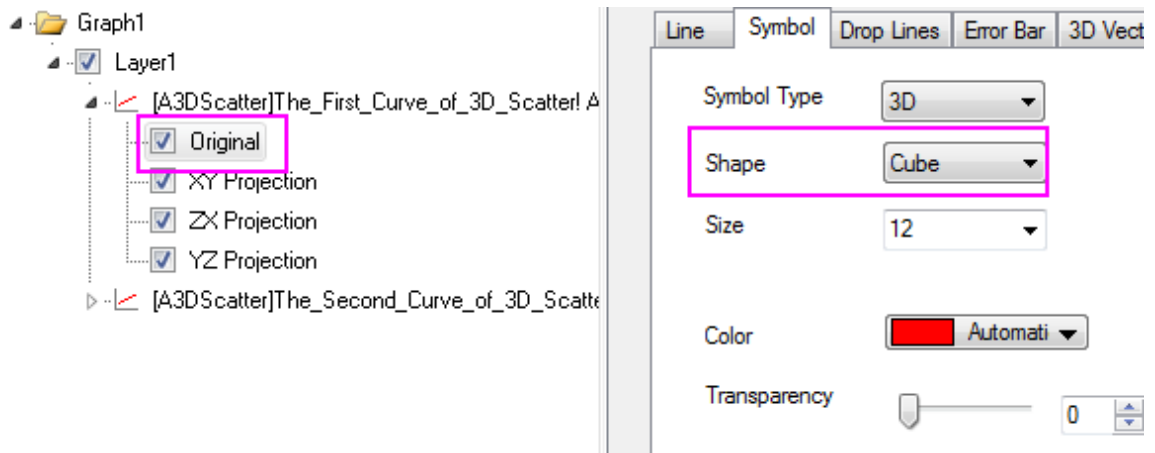

9. In a similar fashion, select the second plot and set the dialog options to match those in the screenshots below:

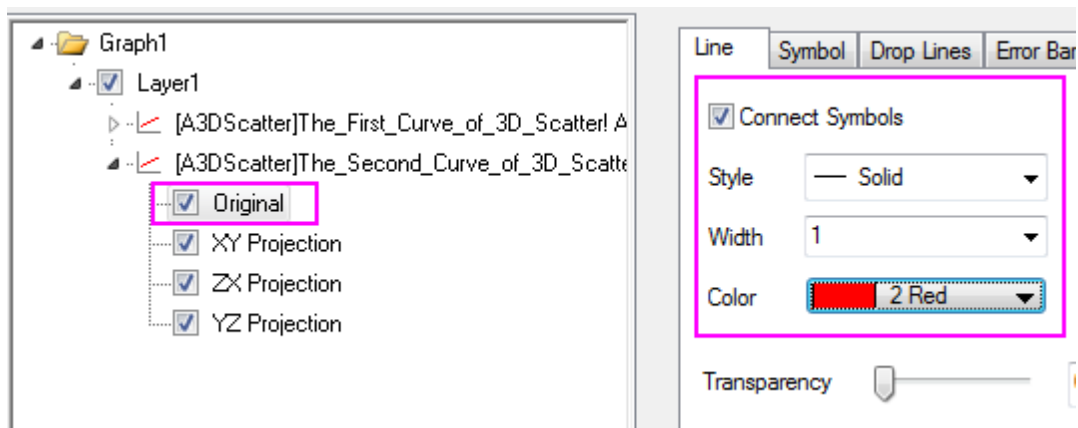
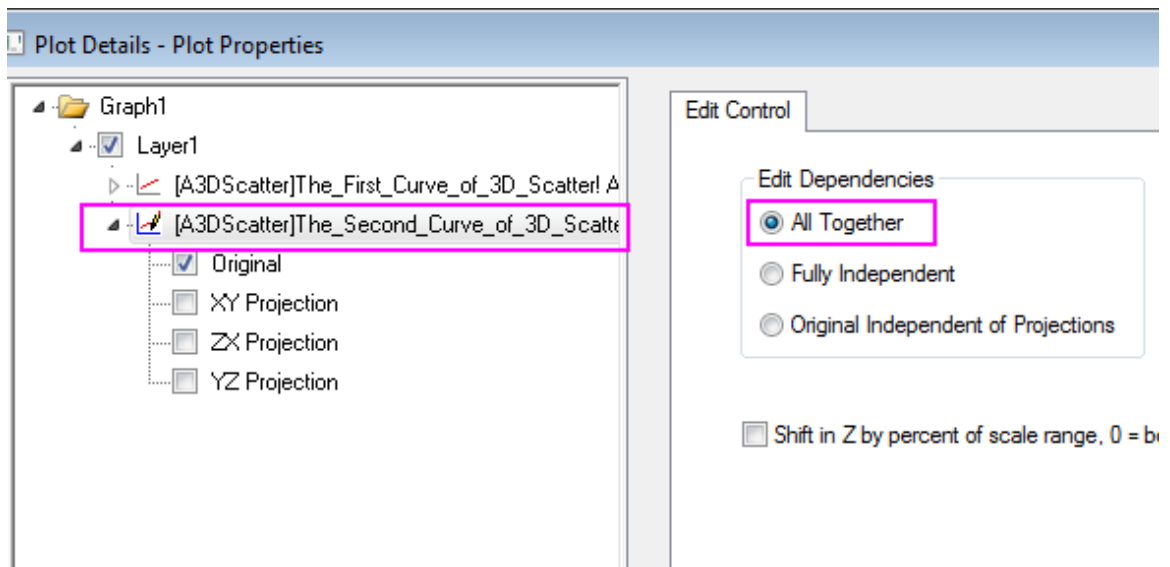

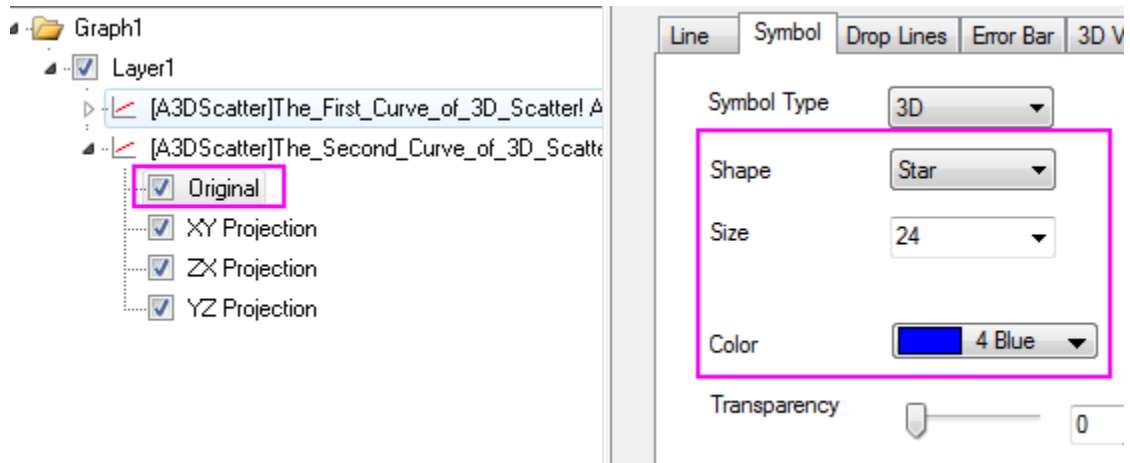

10. The final graph should appear as shown below:

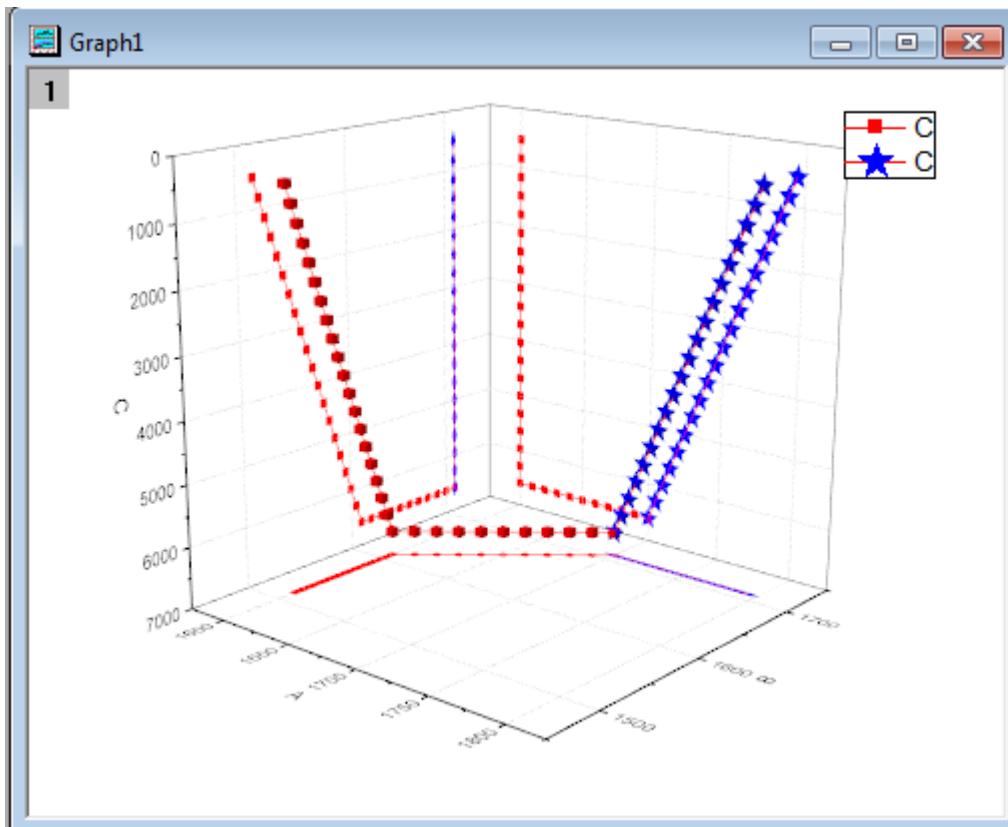

### 6.13.53D Bar and Symbol

#### 6.13.5.1 Summary

This graph is a combination of a 3D bar plot showing the changes in HPI (Home Price Index) and a 3D scatter plot showing the Unemployment Rate. The data is of several Census Divisions during different years. Colormapping is introduced to both plots based on the Z values.

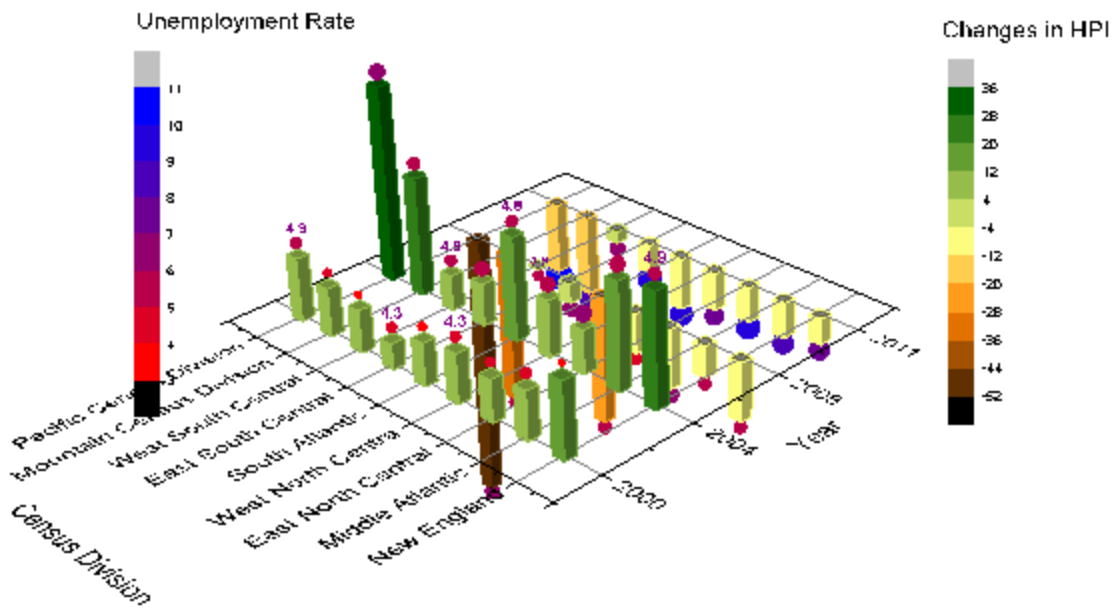

Minimum Origin Version Required: Origin 2015 SR0

#### 6.13.5.2 What you will learn

This tutorial will show you how to:

- Plot a 3D bar graph.
- Add a scatter plot to a 3D bar graph.

#### 6.13.5.3 Steps

1. Open the **Home Price Index Changes & Unemployment Rate.opj** file by selecting **File: Open** and navigate to `<origin exe folder> \Samples\Graphing`

2. Activate book **Home Price Index Changes & Unemployment Rate**, highlight columns A(X), B(Y), and C(Z), and then select **Plot > 3D :3D Bars** to plot a 3D bar graph.

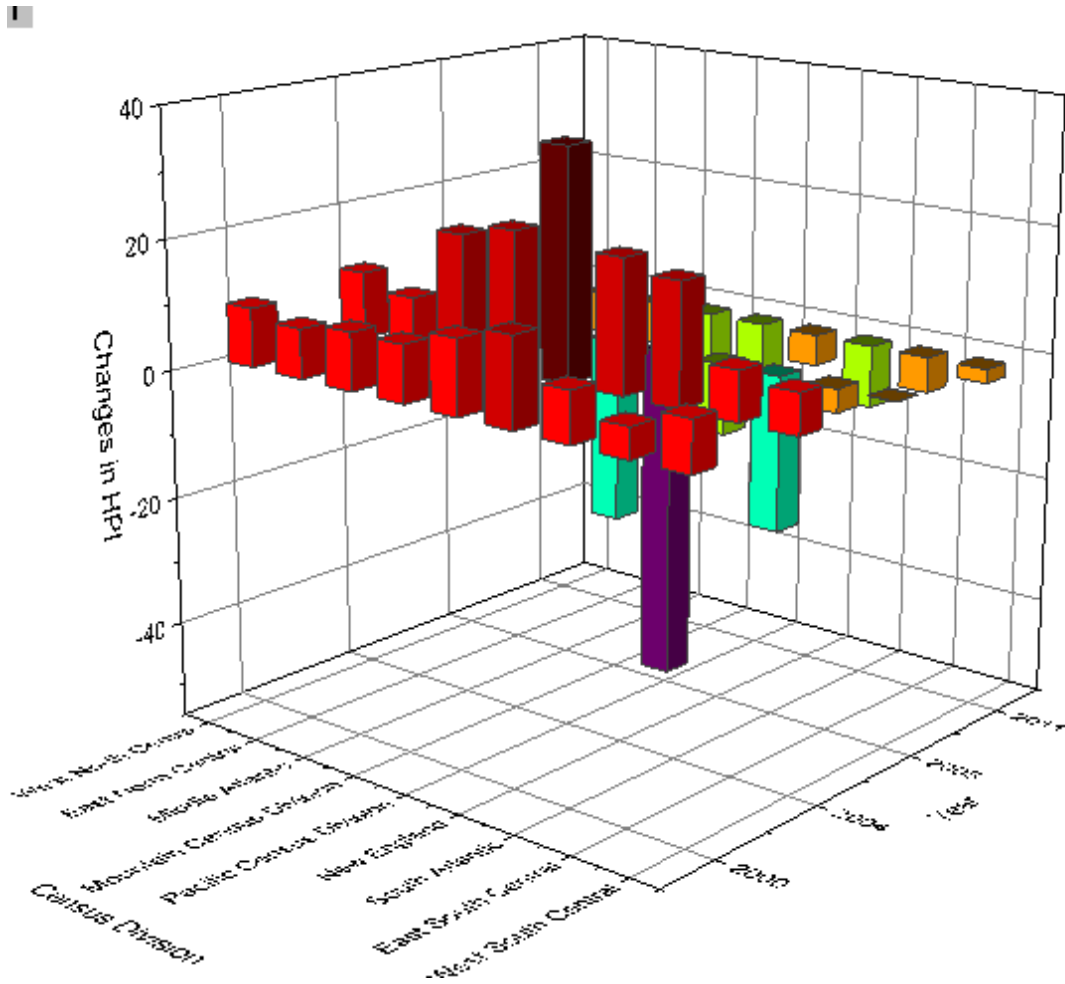

3. Right-click on the layer icon and choose **Plot Setup** from the context menu. In the **Plot Setup** dialog, set columns A, B, and G1 as X, Y, and Z respectively. Then click the **Add** button to add this plot to the current



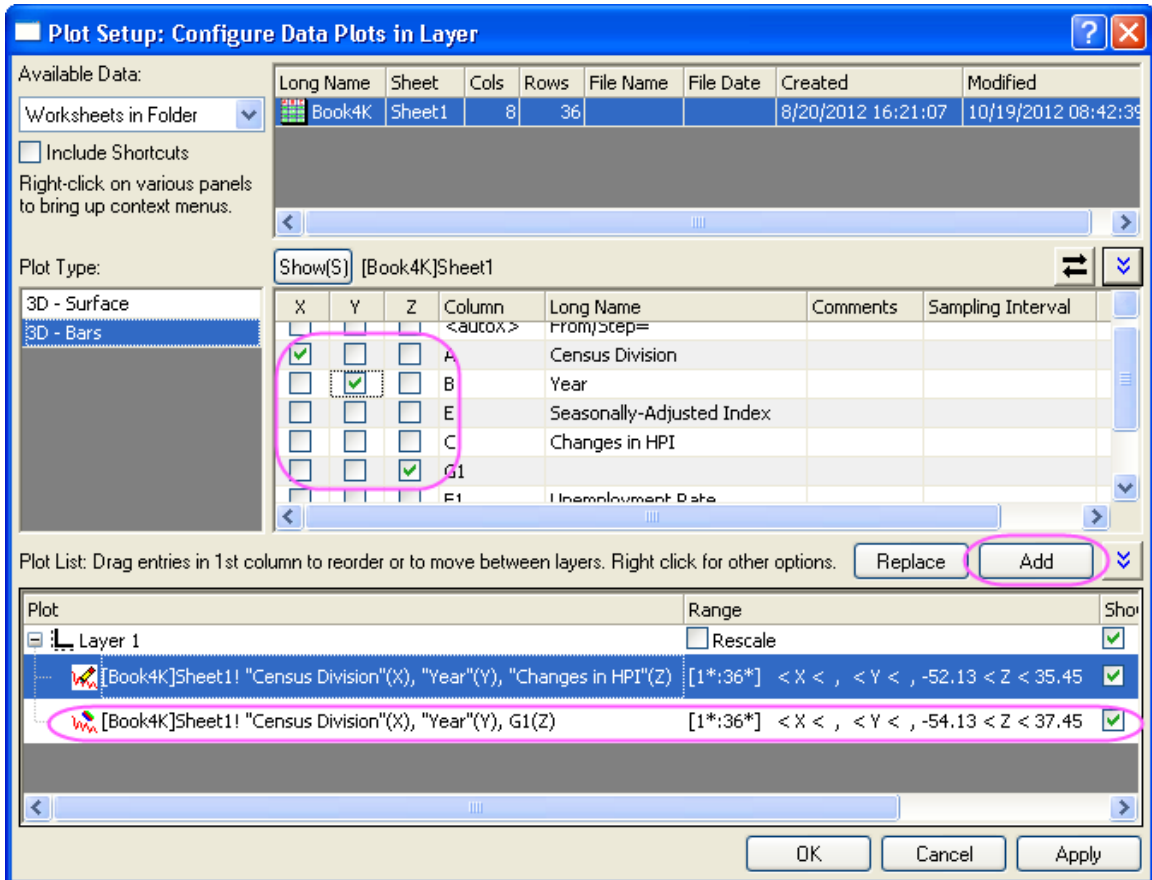

layer. After that, click the **OK** button to close the **Plot Setup** dialog.

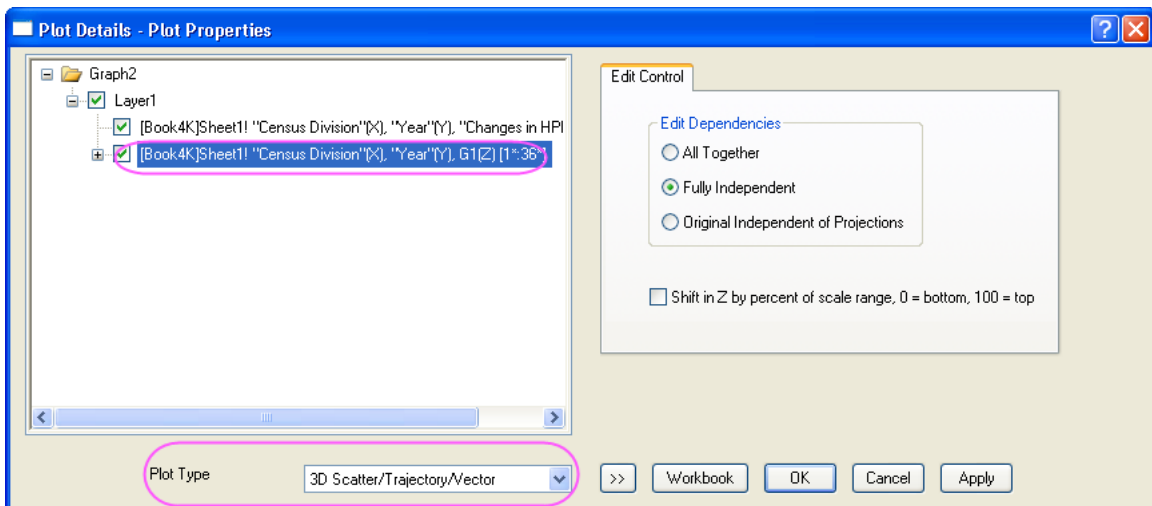

4. Double-click on the plot to open the **Plot Details** dialog. In this dialog, select the second plot in the left panel and set the **Plot Type** as **3D Scatter/Trajectory/Vector**.





In order to show all three panels in **Plot Setup** dialog, please expand **Plot Type** panel by clicking  and expand **Available Data** panel by clicking  again.

Please refer to [Plotting using Plot Setup](#) for more information.

5. Select **Original** in the left panel, then go to the **Symbol** tab in the right panel, select Col("Unemployment rate") for both **Size** and **Color**, and set the **Scaling Factor** of size as **2**.

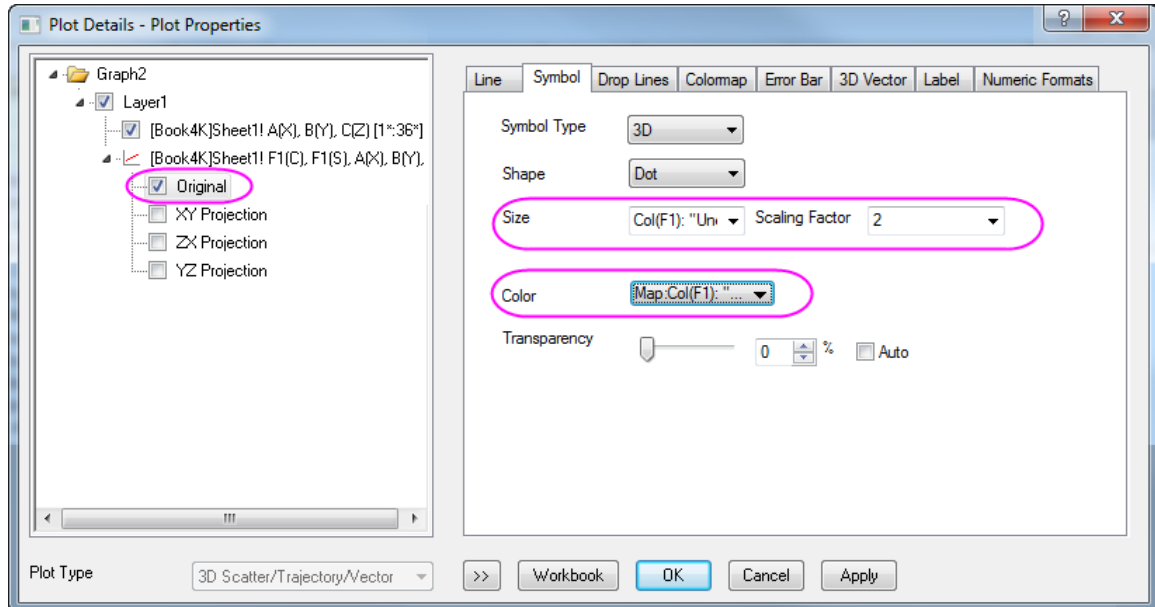

- Go to the **Colormap** tab, set **Level** and **Fill** as shown below.

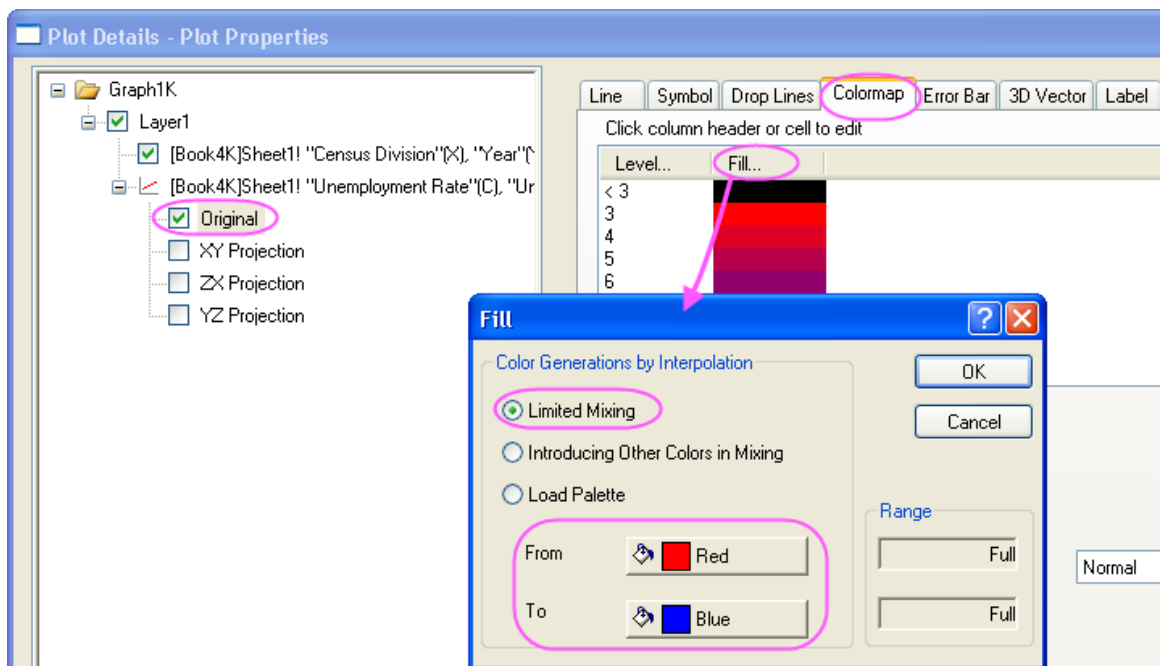
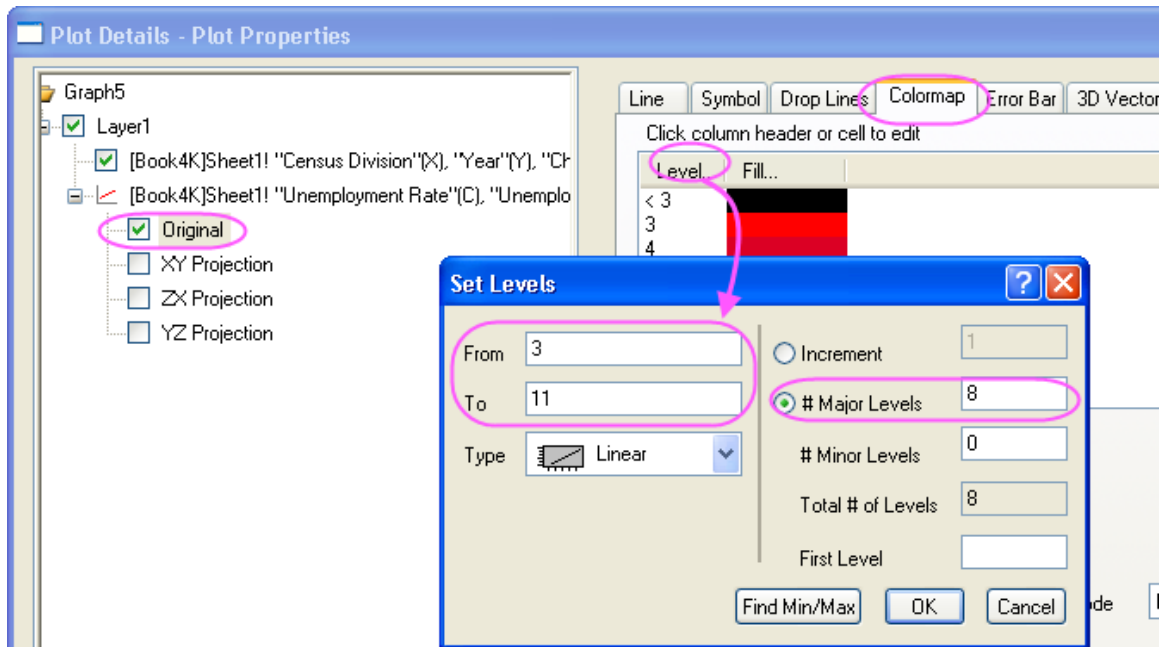

- Go to the **Label** tab, check the Enable check box, set **Label Form** as *Col(F)* and **Position** as above.

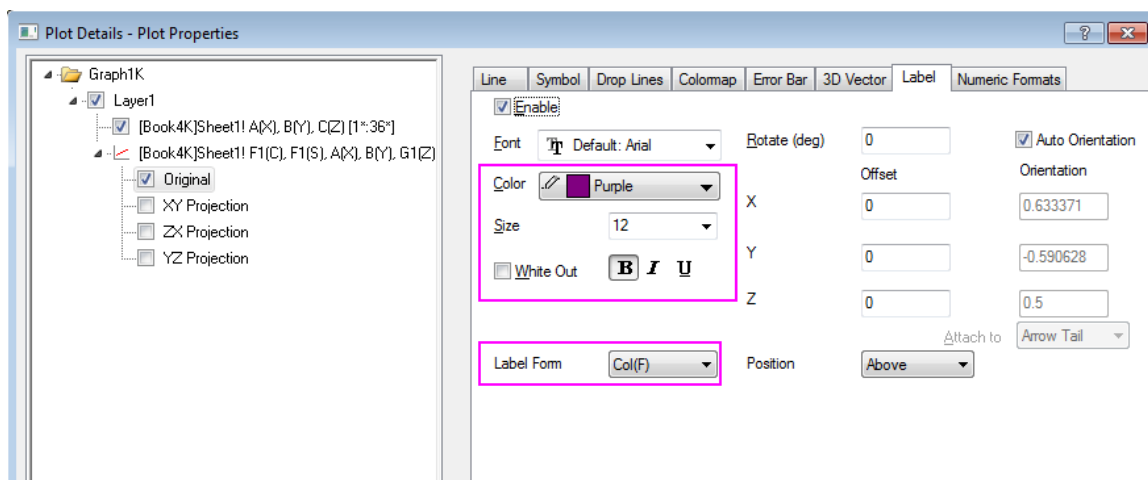

- Go to the **Numeric Format** tab, select **Decimal Places** and set it to *0*.

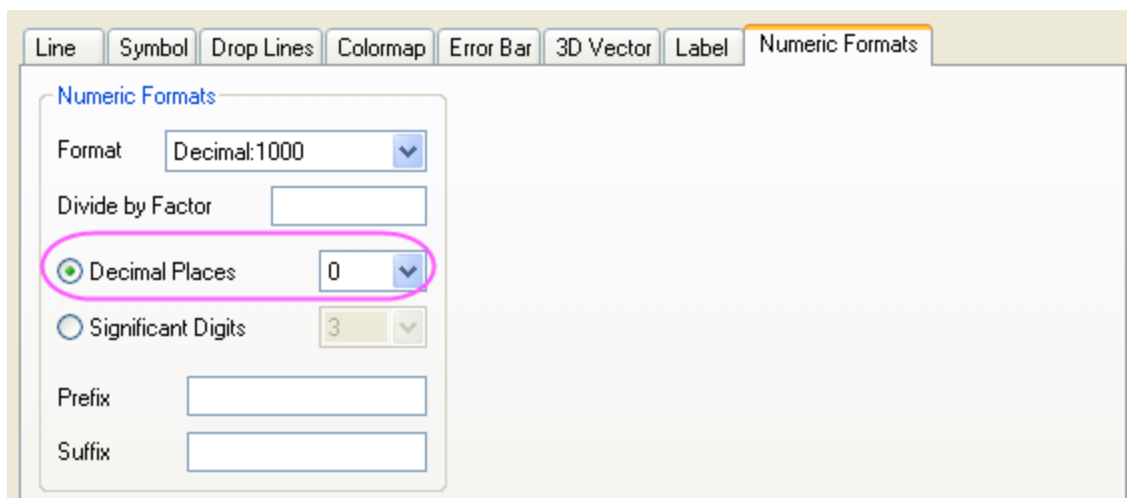

9. Select **Layer1** in the left panel. In the right panel, go to the **Planes** tab, uncheck **YZ** and **ZX**, select **At Position=** for the **Position** dropdown list and enter **0** for the **Percent/Value** blank box.

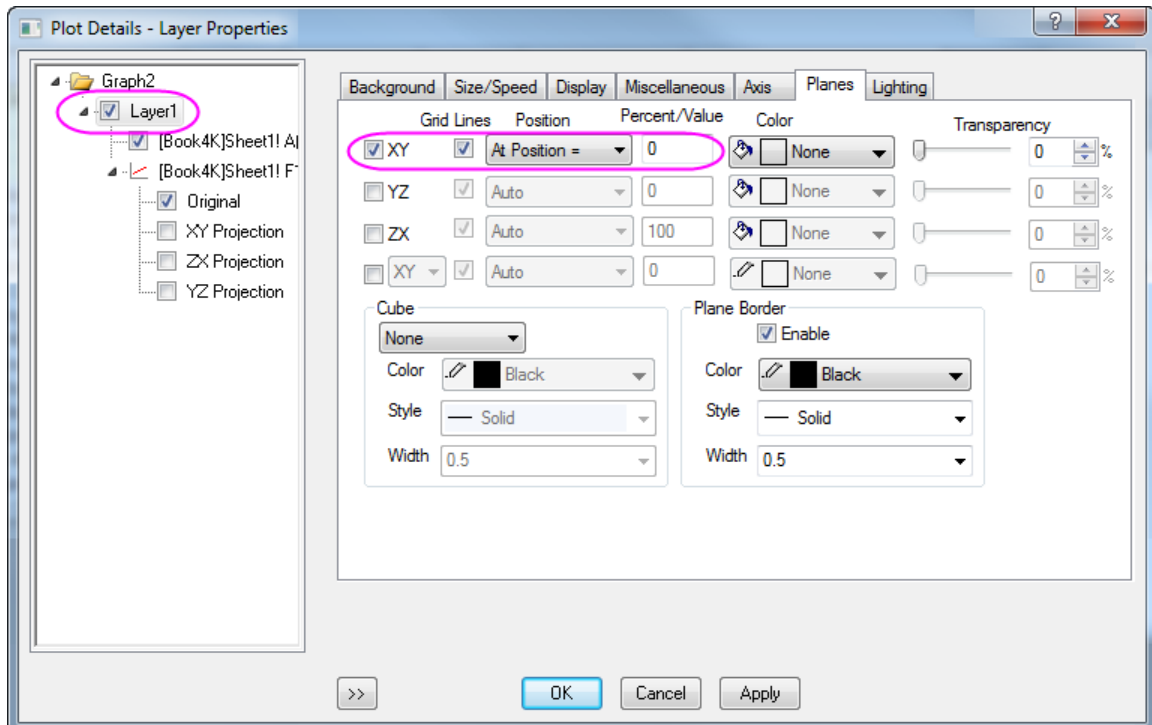

- Go to the **Axis** tab in the right panel, do settings as below:

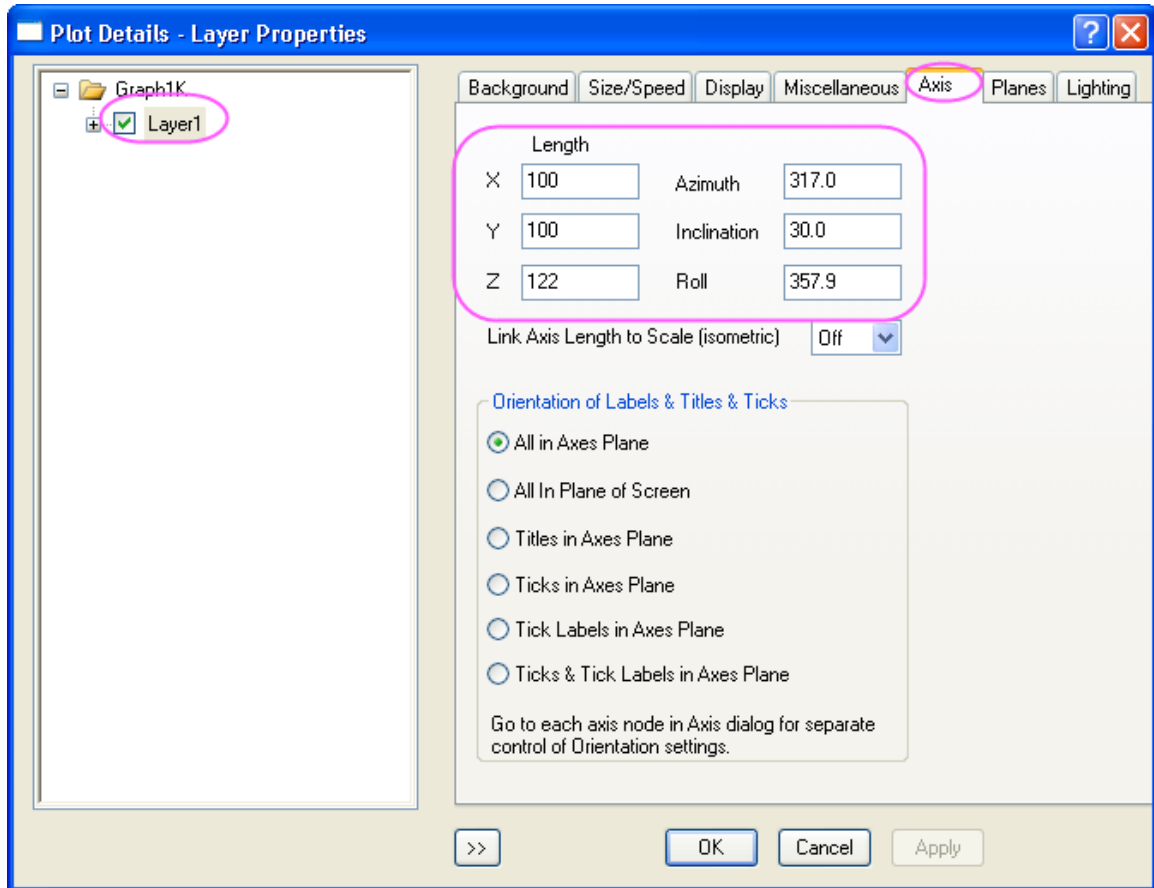

- Select the first plot under Layer1 in the left panel, go to the **Pattern** tab, use Col("Changes in HPI") as the colormapping for both bar border and shape fill.

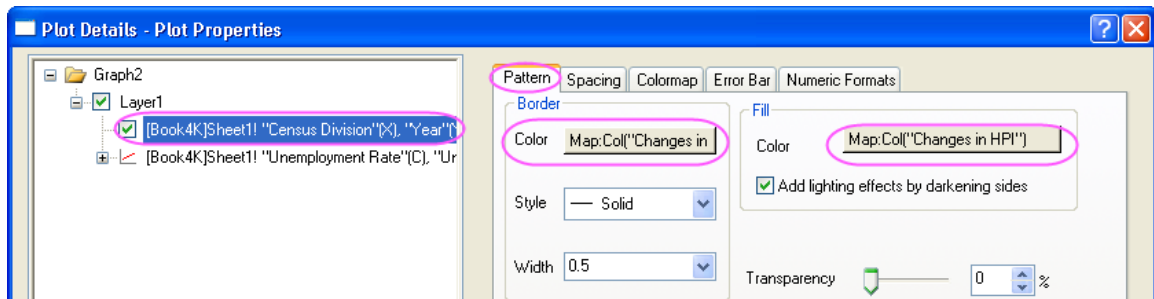

12. Go to the **Outline** tab, set the **Width(in%)** to 30 as below.

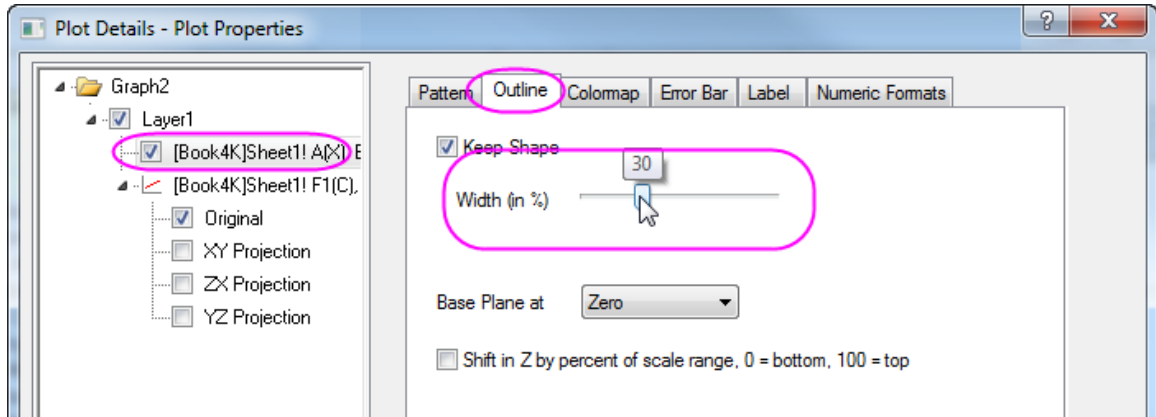

13. Go to the **Numeric Format** tab, select **Decimal Places** and set it to 0.

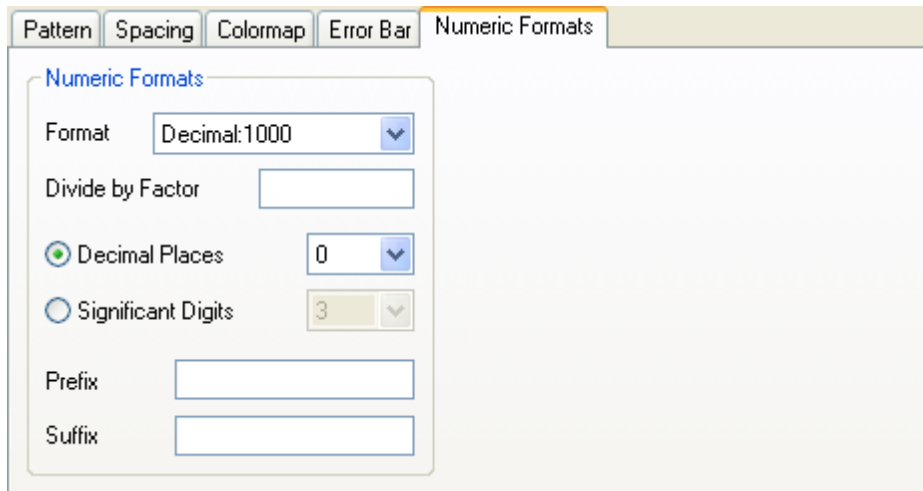

14. Go to the **Colormap** tab, click **Level...** header to open the **Set Levels** dialog. Do settings as below.

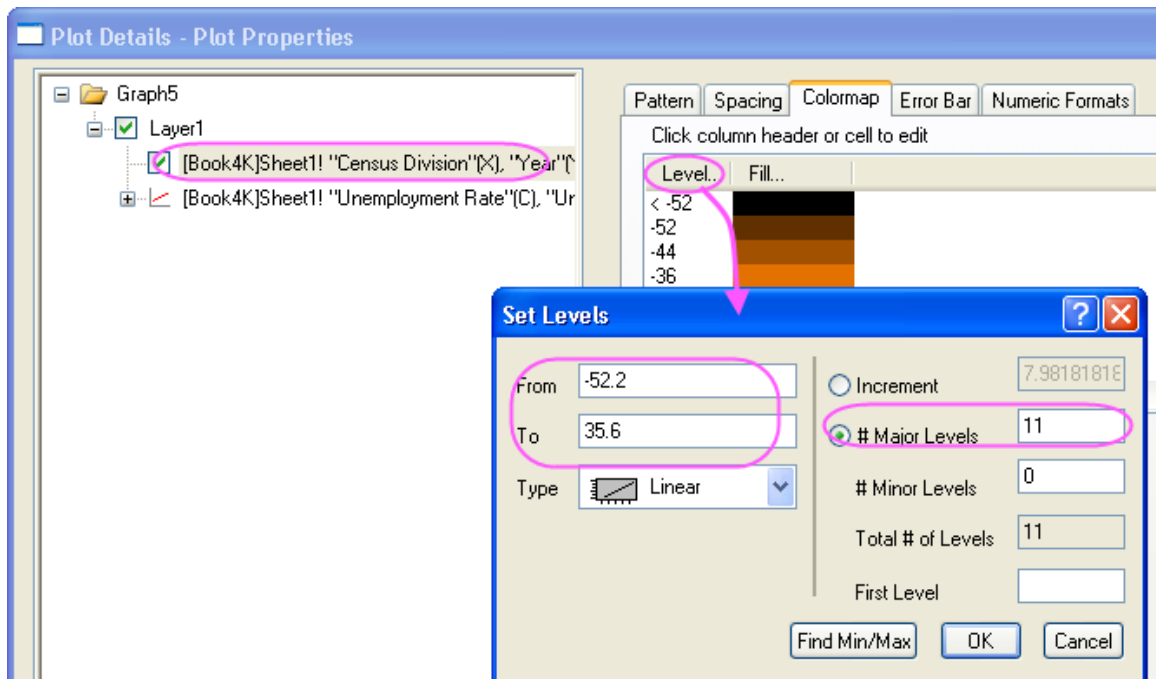

- Click OK button to close the **Set Levels** dialog. Click **Fill...** and select the **Pumpkin Patch** as the palette. Click OK to close the Fill dialog.

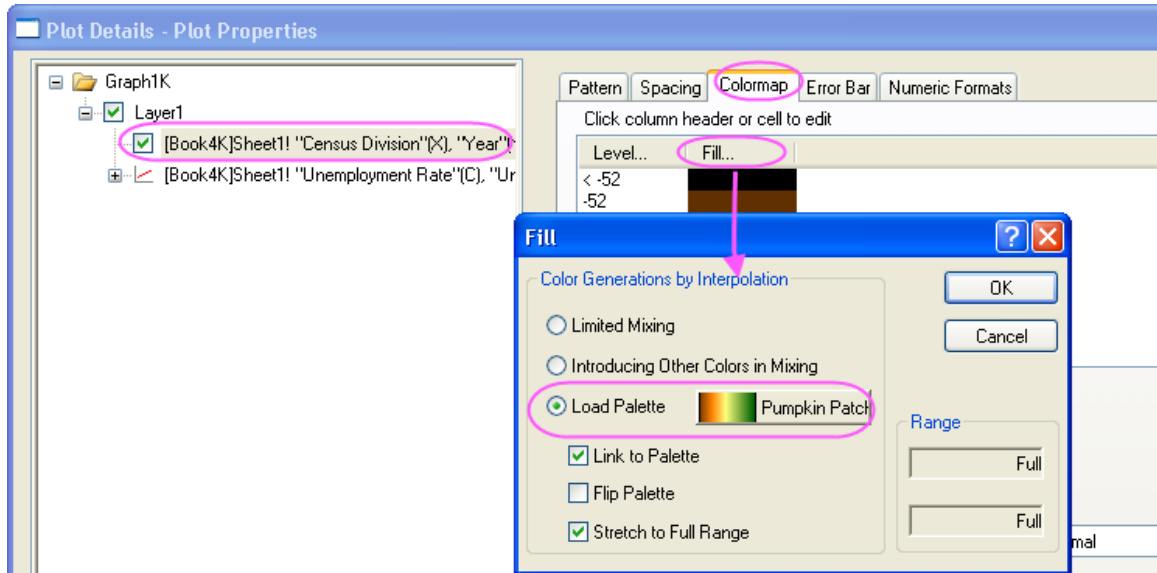

- Click the **OK** button to close the **Plot Details** dialog.
- With the graph window active, select **Insert: Color Scale** from the main menu to add a color scale for the first plot. Double-click on the color scale to open the **Color Scale Control** dialog. In this dialog, apply settings below.

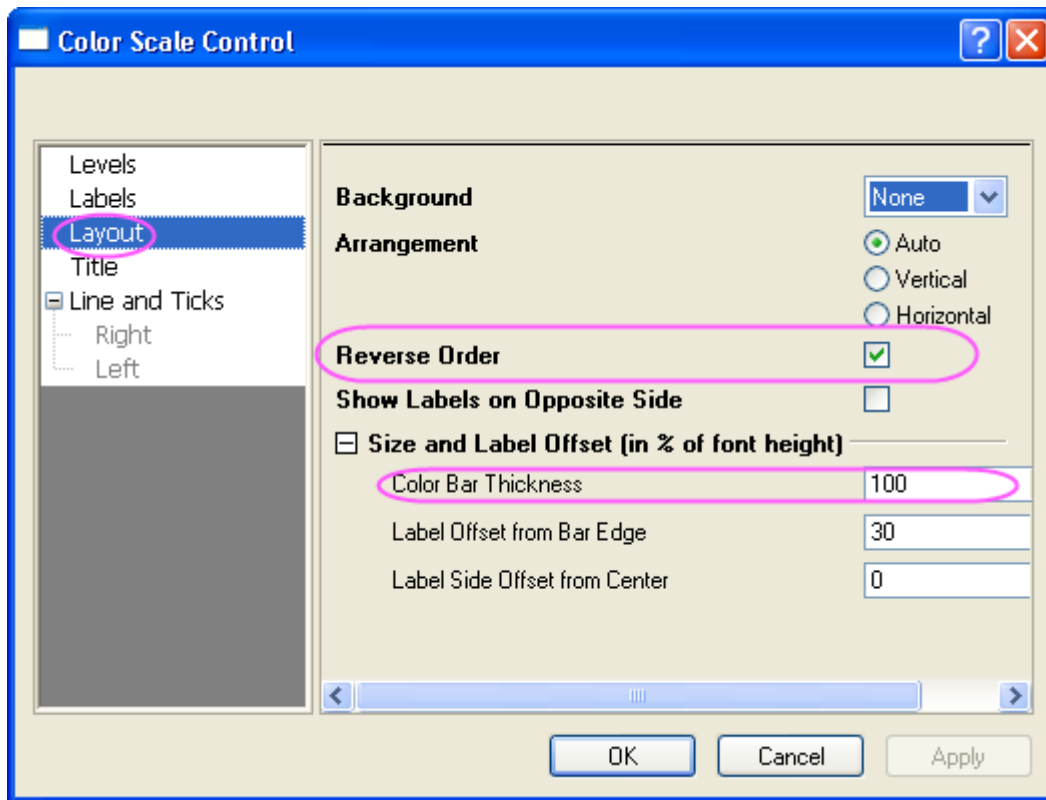

- Click OK button to close the **Color Scale Control** dialog. Then right-click the layer icon to activate the other plot from the context menu, then select **Insert: Color Scale** from the main menu to add another



color scale. Double-click on this color scale to open the **Color Scale Control** dialog. In this dialog, do the settings as the previous step does.

19. Add titles **Changes in HPI** and **Unemployment Rate** for these two color scales. Finally, you will get the graph given below.

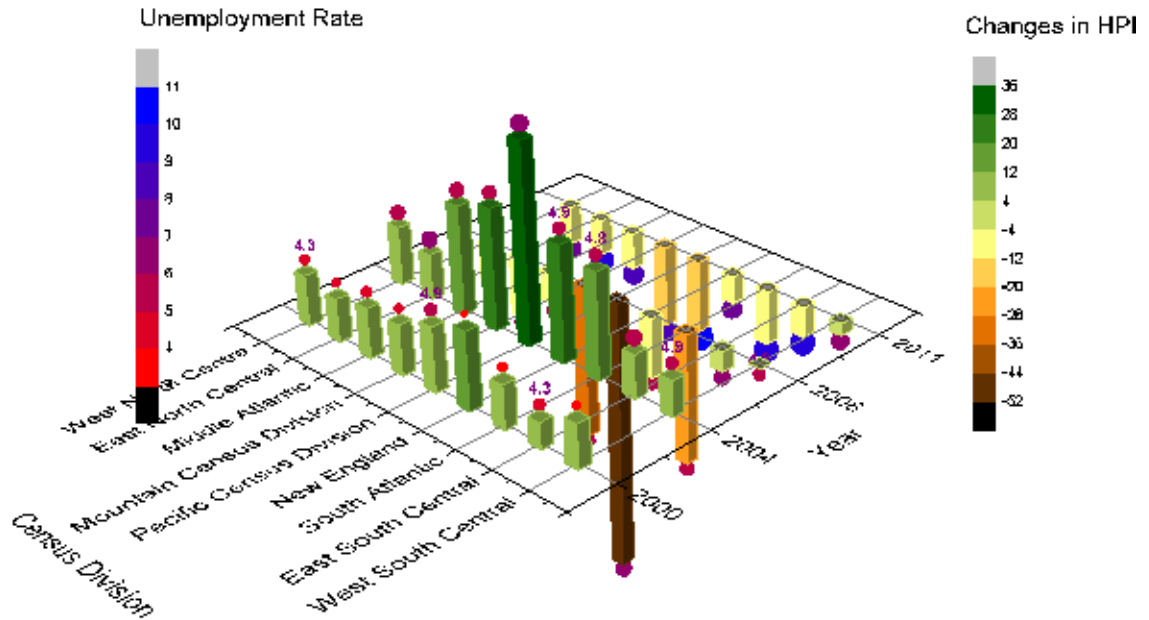

#### 6.13.5.4 Controlling the Categorical Values

1. In the following steps, we want to customize the order of values shown in the graph but not change the source data. Right click on window title of source data book, select View: Categories, a new column label named **Categories** will be added to the head of the worksheet. Double click the "unsorted" to open the **Categories** dialog :

	A(X)	B(Y)	E(
Long Name	Census Division	Year	Seasonally
Units			
Comments			
Sparklines			
<b>Categories</b>	Unsorted	Unsorted	
10	West North Centra	2004	
11	East North Central	2004	
12	Middle Atlantic	2004	

2. Uncheck the **<auto>** checkbox, then you can specify the order of the items by using



buttons based on the order of census division shown in graph below:

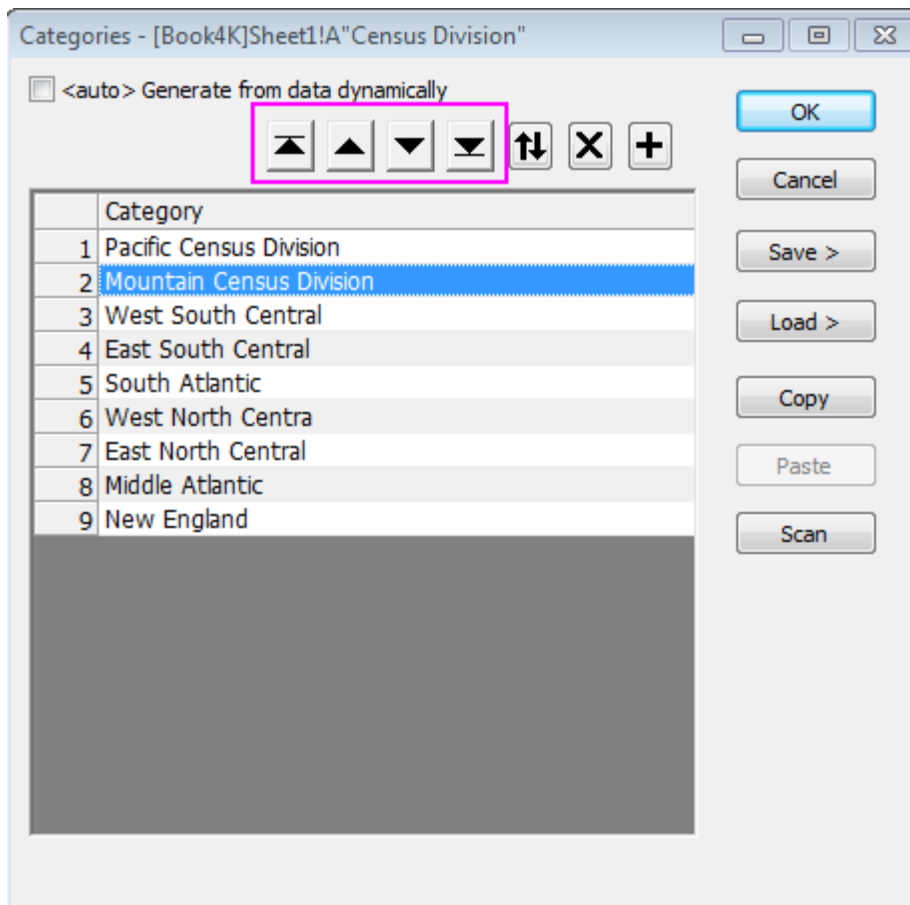

3. Double click the Categories cell of column **B**, "Unsorted", to open the **Categories** dialog. Select **Ascending** in the **Sort** list, click **OK** to close the dialog.

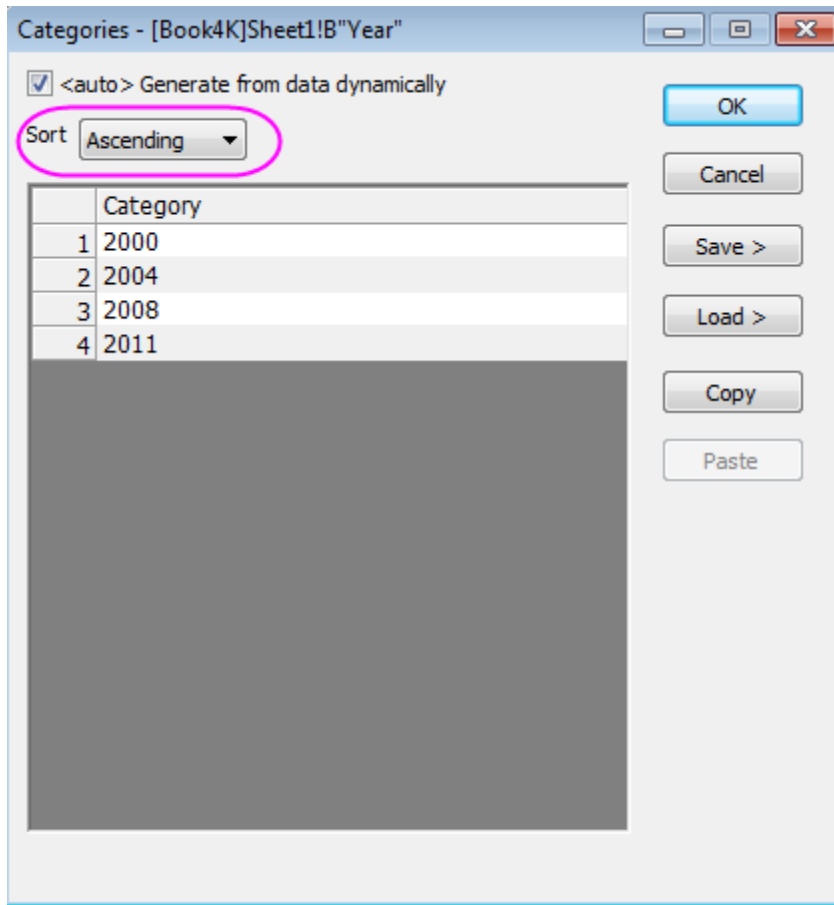

- The 3D bar graph will be updated automatically with the new order of Categorical data.

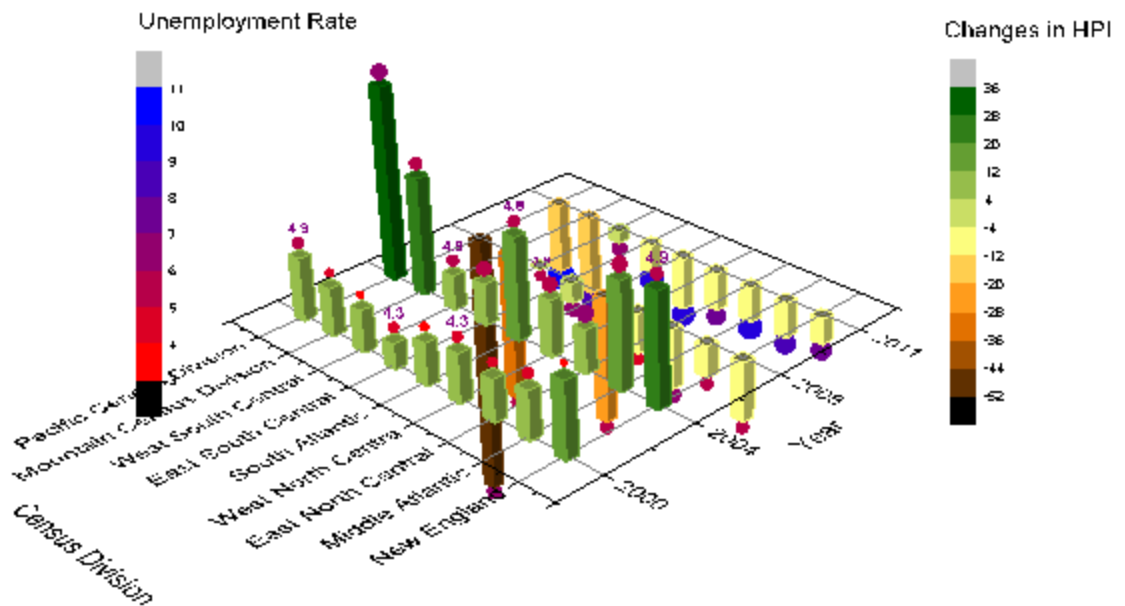

## 6.13.6 Surface with Missing Values

### 6.13.6.1 Summary

In this tutorial, a 3D color map surface graph as shown below will be created from a matrix with missing values. It will also demonstrate how gridlines can be skipped by customization.

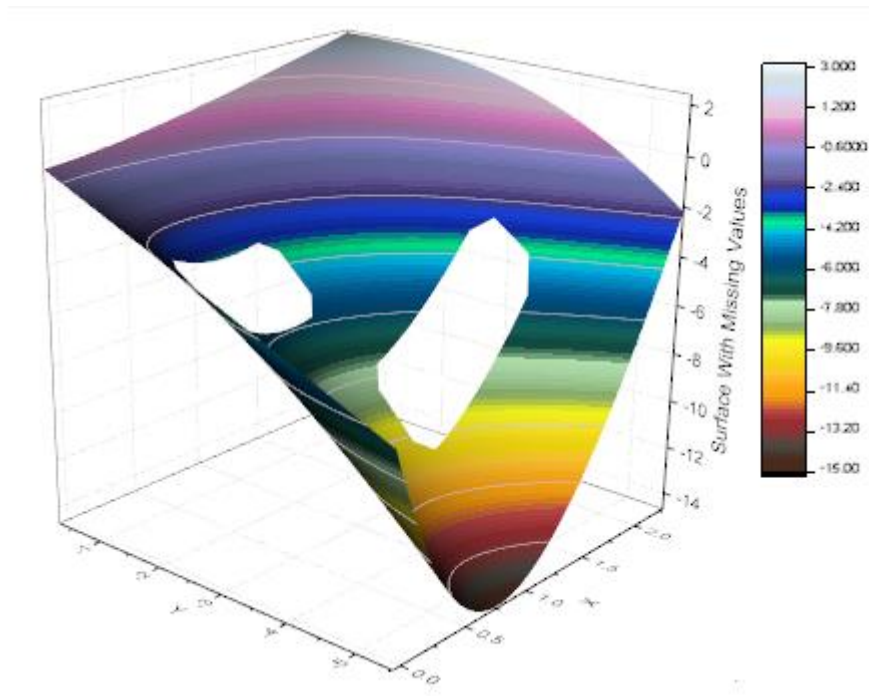

Minimum Origin Version Required: Origin 2015 SR0

### 6.13.6.2 What you will learn

This tutorial will show you how to:

- Create a 3D surface plot from a matrix by ignoring missing values
- Skip gridlines on a 3D surface plot
- Set contour lines
- Set contour levels and fill colors

### 6.13.6.3 Steps

1. Start with a new worksheet and import the file `\Samples\Graphing\Surface With Missing Values.dat`. Hover the cursor over the cell in the top left corner of the worksheet till it appears as a slanting black arrow and click to highlight. Select **Plot > 3D : 3D Colormap Surface** from the Origin main menu to create a graph. This is a virtual matrix so the **plotvm** dialog (plot virtual matrix dialog) will appear. Use the system default settings as below:

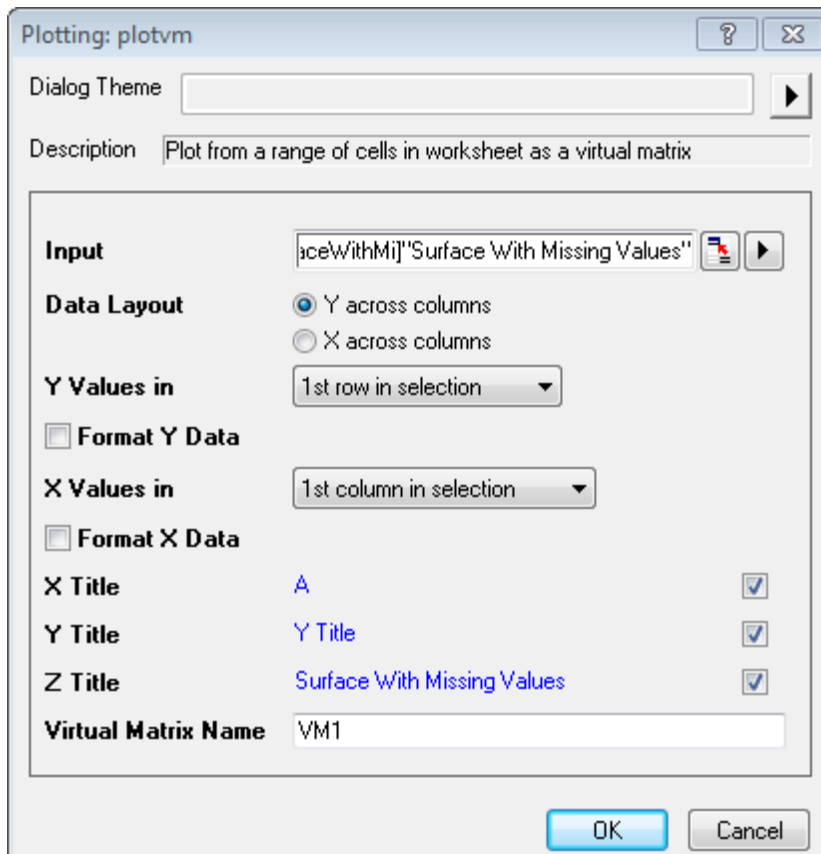

2. The graph should appear as shown below:

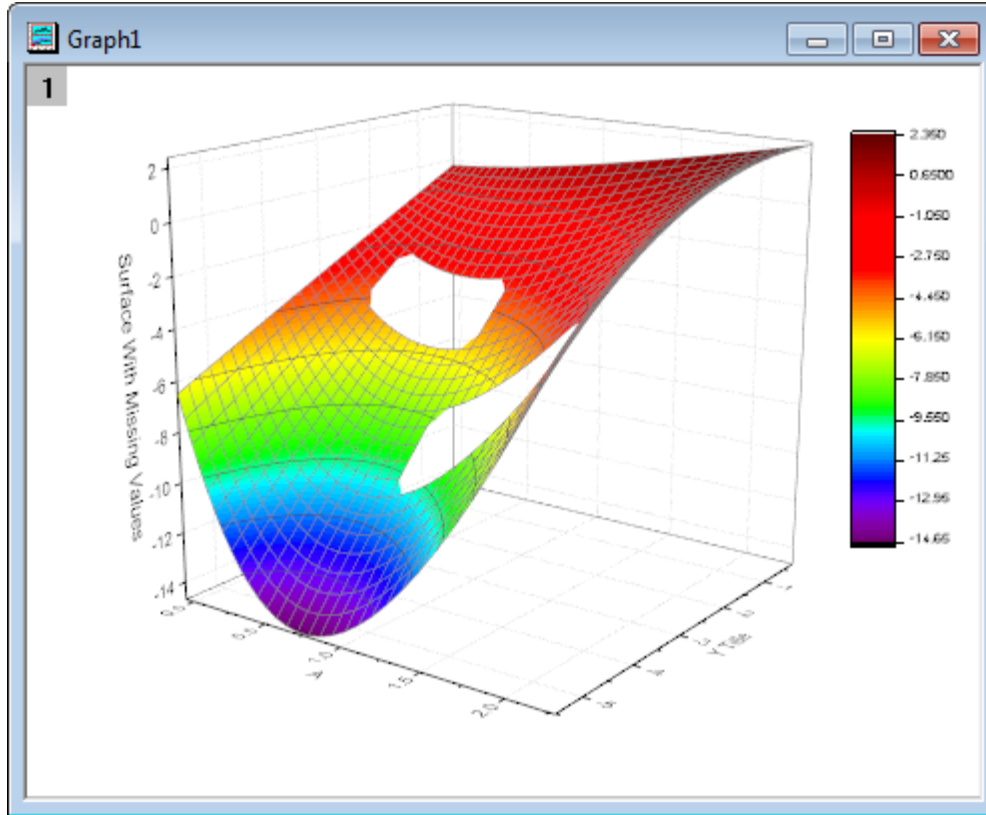

3. Double click on the graph to pull up the **Plot Details** dialog. If the left panel is not expanded use the



button on the bottom left of the dialog to open it. Expand the tree node on the left panel to make sure that the box under **Layer1** is selected. The next few steps will customize the graph using the settings in the **Plot Details** dialog. Activate the **Colormap / Contours** tab on the right panel. Click the **Level** heading to open the **Set Levels** dialog and set the dialog as shown in the following image.:

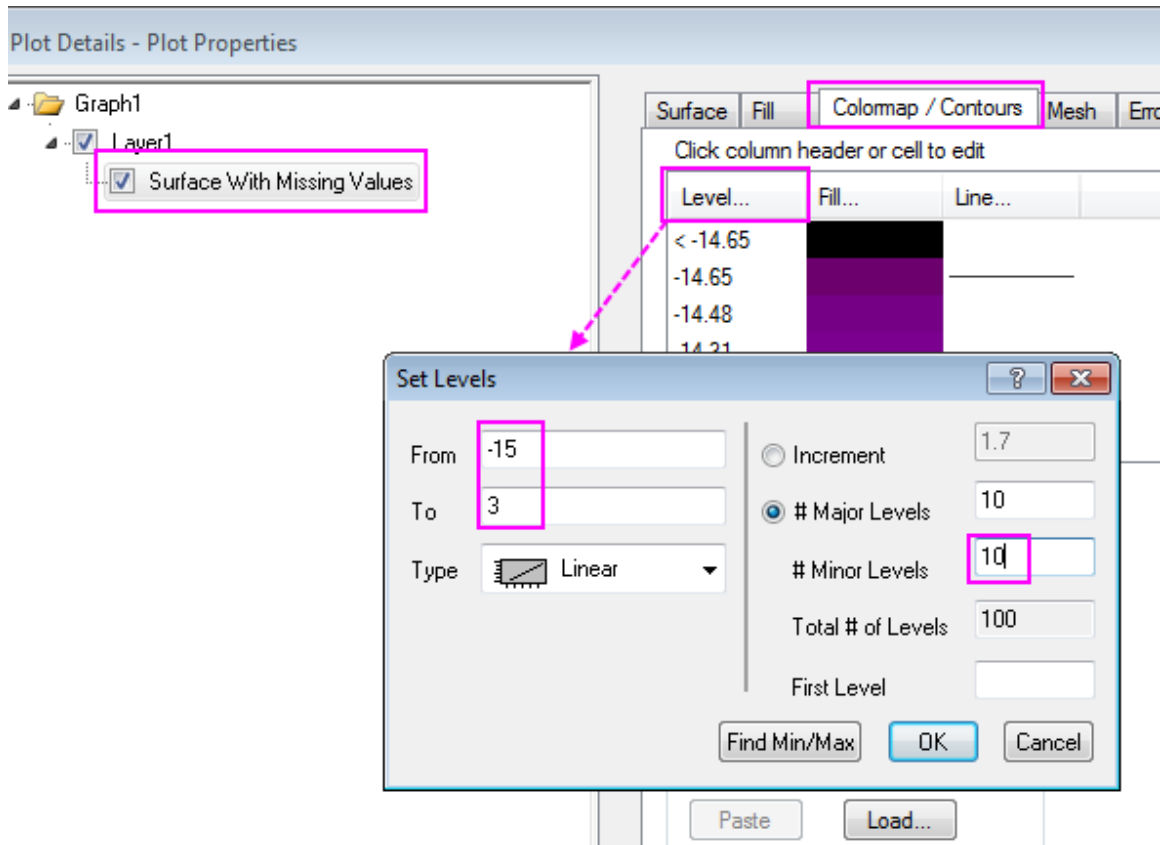

- Click on the **Fill** heading to open the **Fill** dialog. In this dialog, choose the **Load Palette** radio button and then click the **Select Palette** button to choose the **Reef** palette. Ensure the **Link to Palette** check box has been enabled. Click the **OK** button to return to the **Plot Details** dialog.

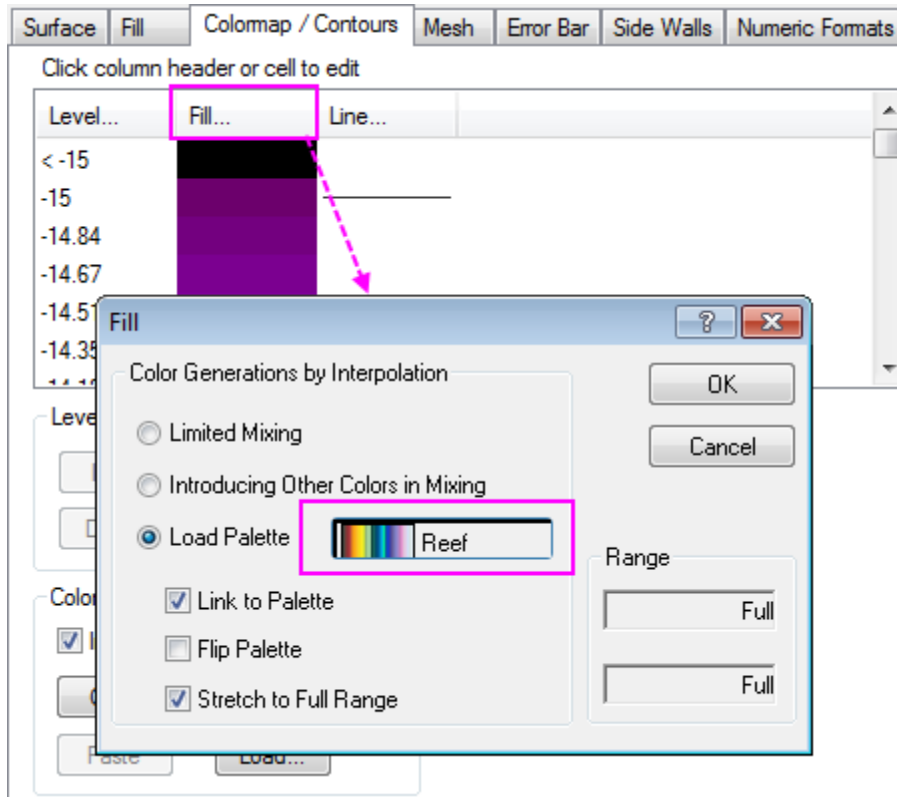

5. Click on the **Line** heading to open the **Contour Lines** dialog. Check **Color** check box under **Apply to All**, and set **Color** to **LT Gray**. Click the **OK** button to return to the **Plot Details** dialog.

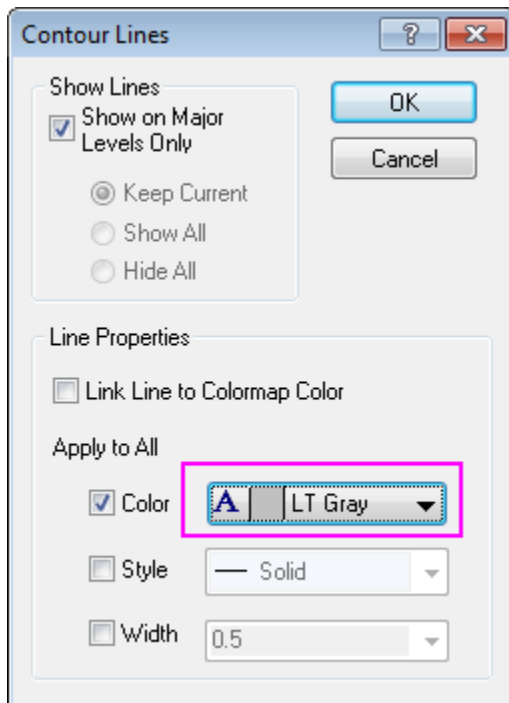



6. Activate the **Mesh** tab on the right panel. Deselect the box before **Enable** as the following screenshot shows. Click **Apply**. This will remove the mesh lines on the graph:

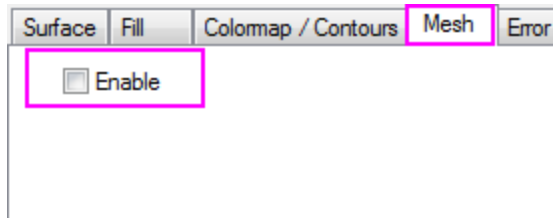

7. Click on the **Layer1** on the left panel, and select **Lighting** tab on the right panel. Select **Directional** in Mode. Click **OK** to save the setting and close the dialog.

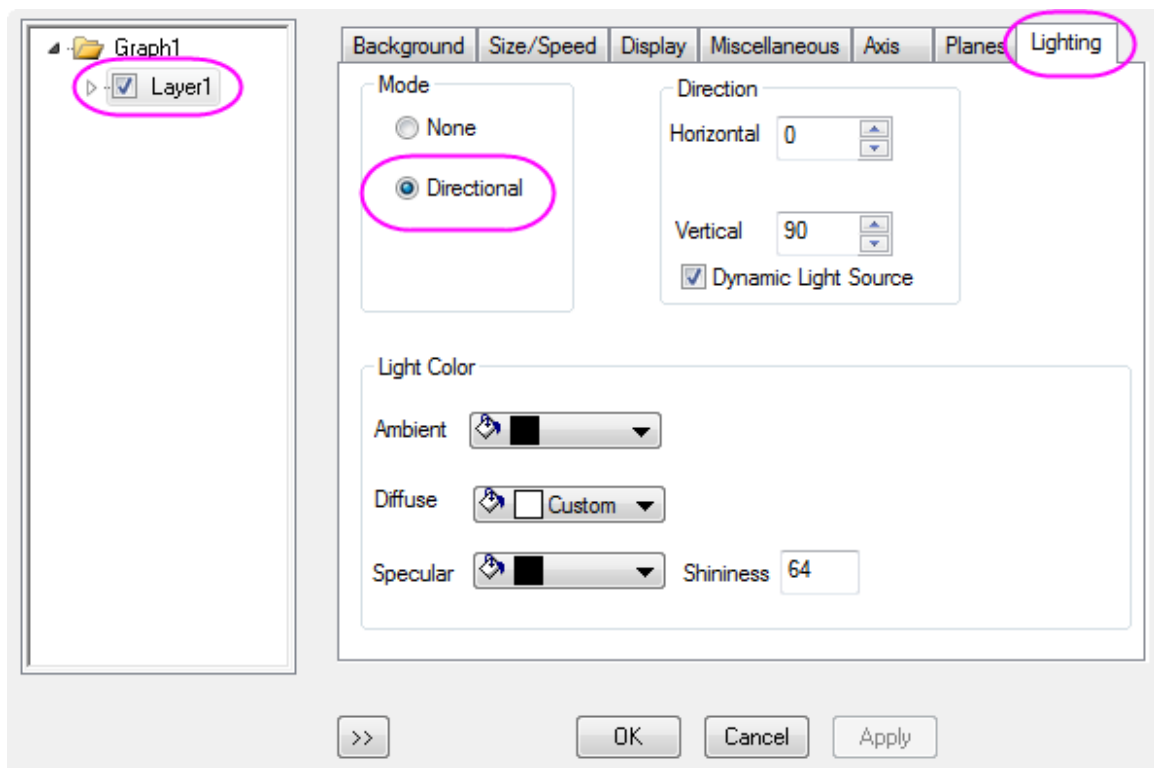

8. Double click on the axis title object(s) to modify them to *X* and *Y* for *X* and *Y* axis respectively.
9. Click the layer spacer to activate the 3D transform control toolbar, then select the **Rotate** button to rotate the 3D graph to a desired orientation:

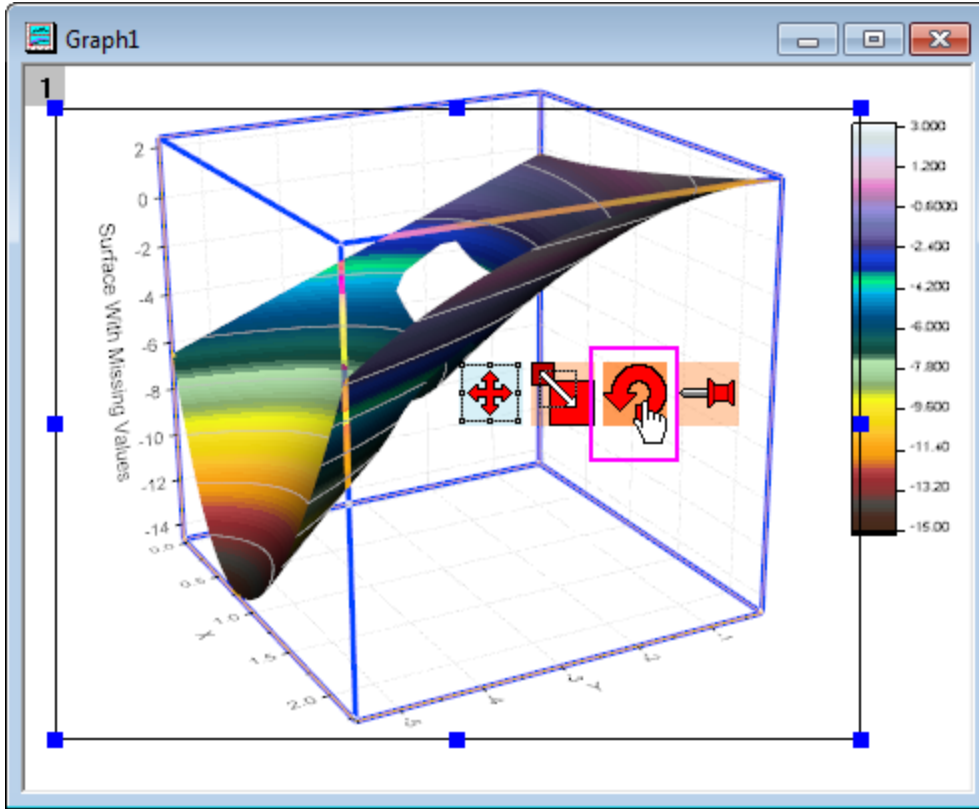

10. The final graph should appear as shown below:

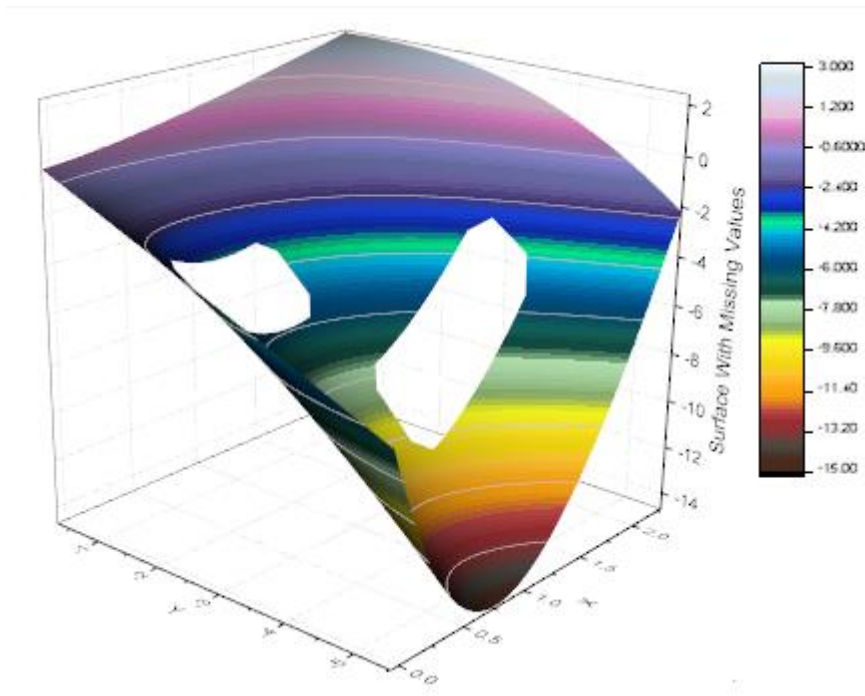

## 6.13.7 Creating Intersecting Surface Plots from Worksheets

### 6.13.7.1 Summary

Many plot types, such as 3D Surface, 3D Bars, and Contour, can be created from data contained in a matrix object or from data arranged in a block of cells in a worksheet. The latter arrangement is referred to as a **Virtual Matrix**. Whereas a typical matrix object only supports a linear mapping of X and Y coordinates, a virtual matrix supports nonlinear mapping as well. In this tutorial, we show you how to create intersecting color map surface plots from virtual matrix data.

Minimum Origin Version Required: Origin 2015 SR0

### 6.13.7.2 What you will learn

This tutorial will show you how to:

- Create a Color Map Surface plot using virtual matrix data from a worksheet
- Add one surface graph to another to create intersecting surface plots
- Set transparency

### 6.13.7.3 Steps

#### 6.13.7.3.1 Create Surface Plots from Virtual Matrix Data

This section will demonstrate how to create surface plots from data in a worksheet.

1. Start a new project.
2. Click the **Import Multiple ASCII** button  on the **Standard** toolbar.
3. In the dialog that opens, navigate to the `\Samples\Graphing` folder and select both `VSurface 1.dat` and `VSurface 2.dat` by holding down the Ctrl key and clicking **Add File(s)**

- Select the **Show Options Dialog** check box.

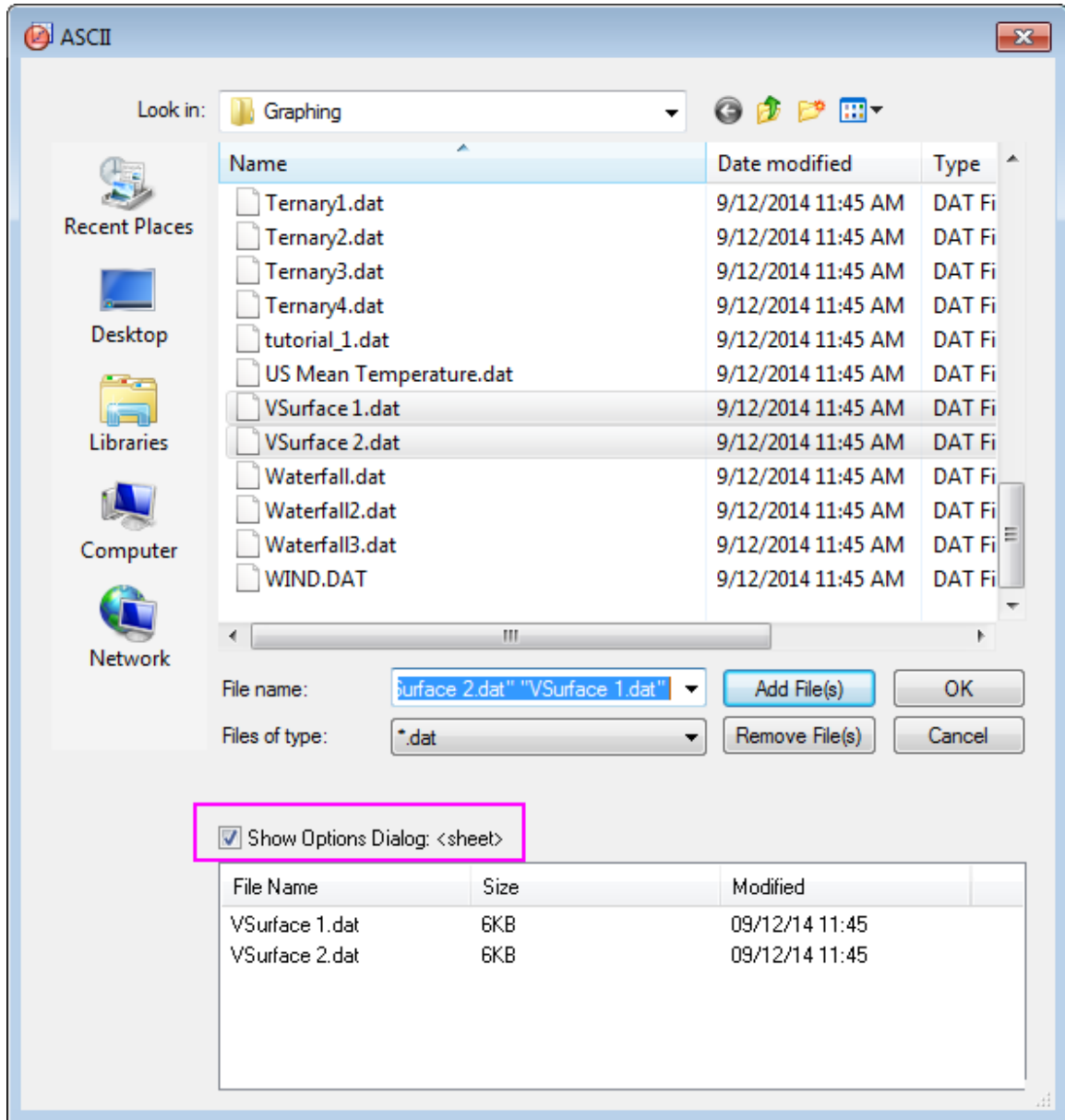

- Press the **OK** button.

6. In the **impASC** dialog, modify the settings according to the following image, so that the two data files will be imported as two worksheets with name **VSurface1** and **VSurface2** in one workbook:

**Import and Export: impASC**

Dialog Theme <sheet>

Description Import ASCII file/files

**Import Options**

- Add Sparklines Yes(if less than 50 columns)
- Import Mode **Start New Sheets**
- Template Name
- File Structure
- Columns
- Header Lines
- (Re)Naming Worksheet and Workbook
  - Auto Rename Using Filename
  - Rename Sheet with (Partial) Filename**
  - Trim Filename From 1
  - Trim Filename To 0
  - Rename Book with (Partial) Filename**
  - Trim Filename From 1
  - Trim Filename To 0
  - Rename Long Name for Book only
  - Include File Path when Renaming Book
  - Append Filename to Workbook Comment
  - Append Filename to Worksheet Comment
  - Append Filename to Column Comment
  - Include File Path when Appending Filename

- Click **OK** to import these two data files.

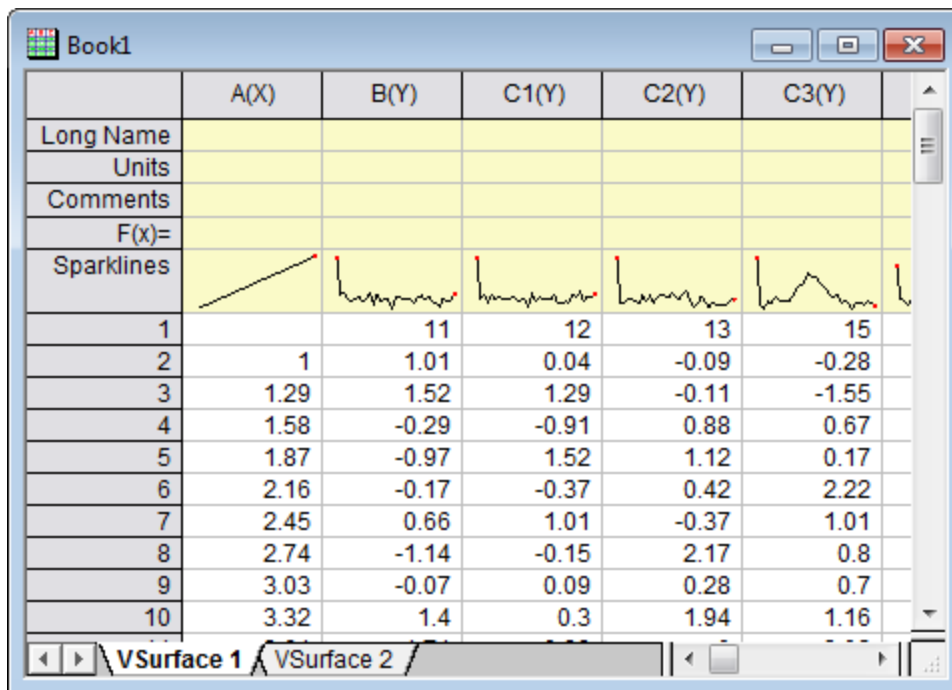

The data has X coordinate values in the top row and Y coordinate values in the first column. Note that the X coordinates have nonlinear spacing.

- With the "VSurface 1" sheet active, hover the cursor over the cell in the top left corner of the worksheet till it appears as a slanting black arrow and click to highlight. .
- Select the menu item **Plot > 3D :3D Colormap Surface** to open the **plotvm** dialog.
- Note:**This dialog opens every time a 3D or Contour plot menu item is invoked with a group of worksheet cells selected. The dialog allows you to define where the X and the Y coordinate values are located.

11. In this dialog, adjust the settings as shown in the image below:

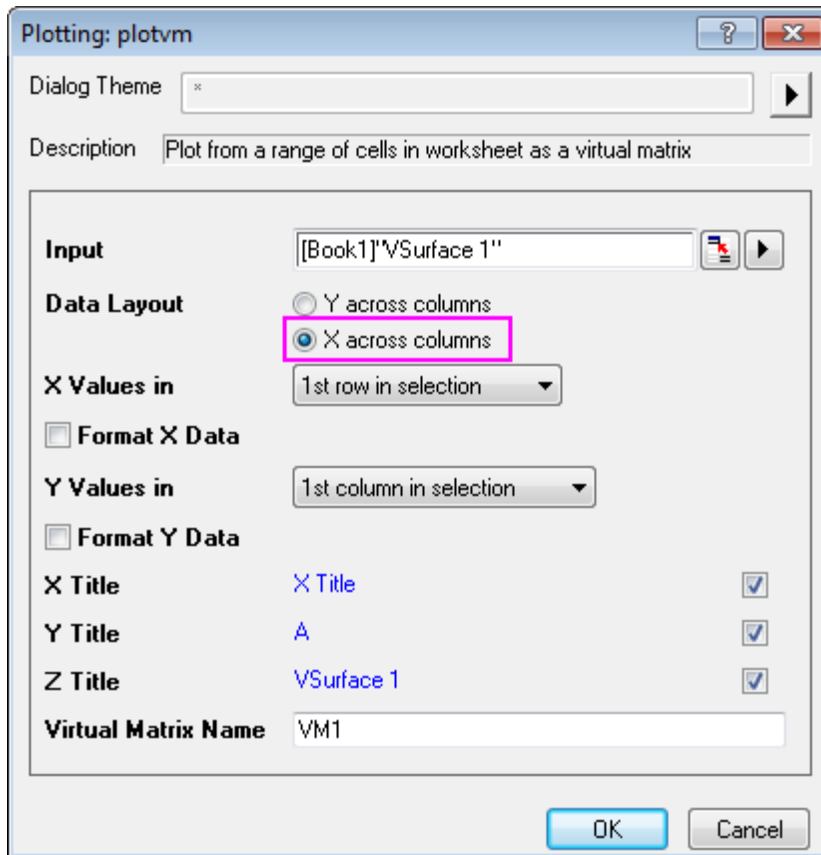

12. Click **OK** to generate a Color Map Surface plot and a virtual matrix as shown below:

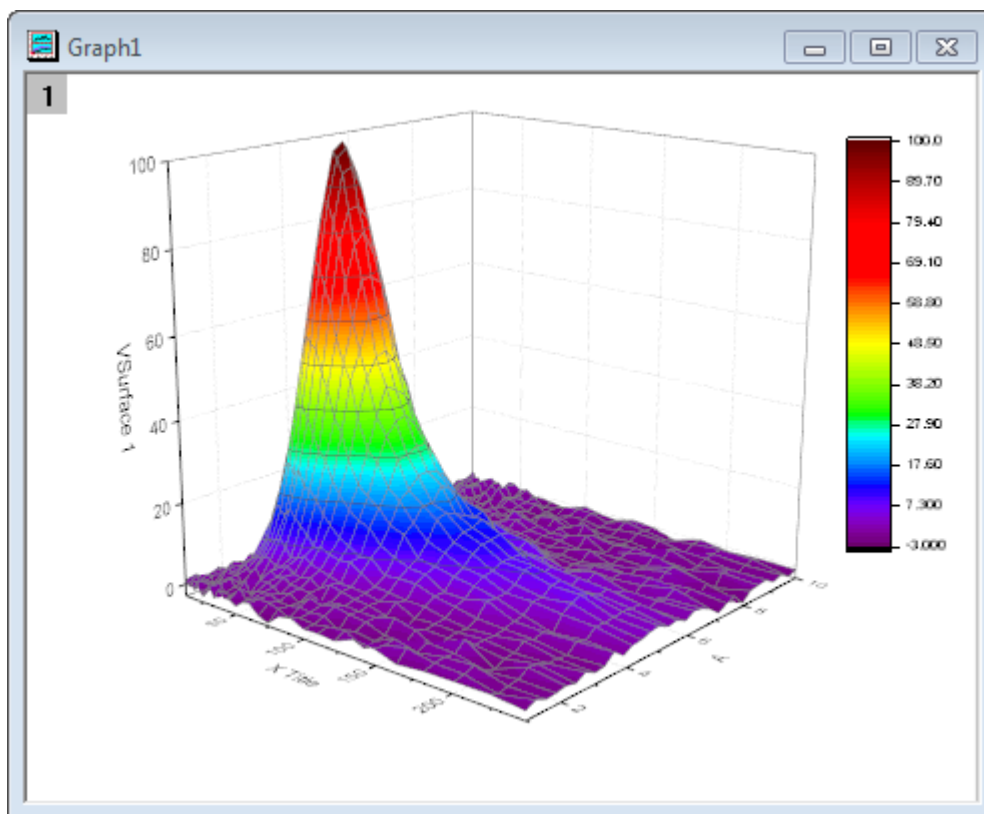



13. Repeat the last step to plot another Color Map Surface plot using data from the VSurface 2 worksheet. This time **VSurface 2** will be automatically used as Z title in the **plotvm** dialog.

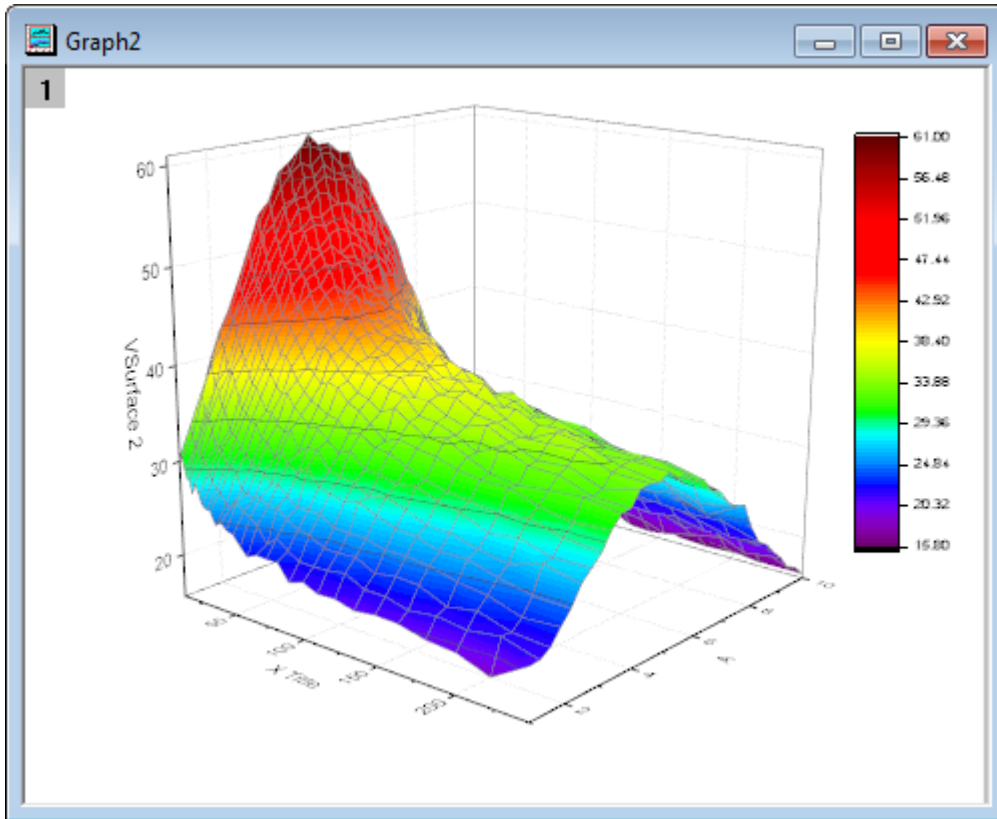

### 6.13.7.3.2 Add Another Surface Plot to Layer

This section will demonstrate how to add a surface plot to a graph layer that already contains another surface plot.

1. Activate Graph1, right-click on the Layer 1 icon **1** on the top left corner of the graph and select **Layer Contents** from the context menu.
2. In the **Layer Contents** dialog that opens, select **VSurface2** from the Available Data panel on the left and add it to the Layer Contents box on the right using the arrow that points to the right in the center of the dialog box (The arrow below it can be used to shift selected items from Layer Contents to Available Data).

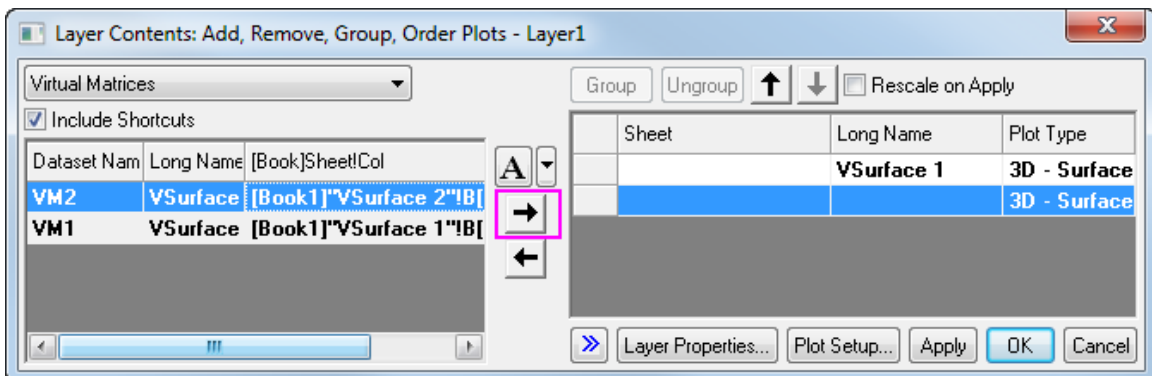

3. Click **OK** to add the second surface, the graph will now appear as shown below:

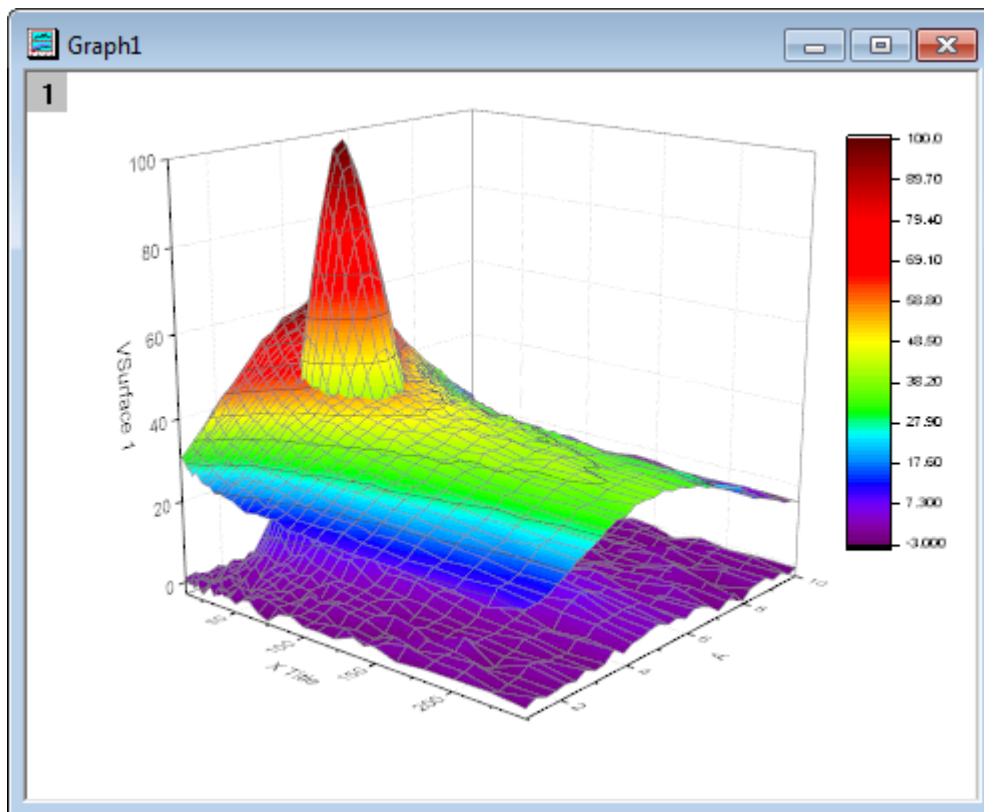

Note the two surfaces are displayed with proper intersection.

### 6.13.7.3.3 Set Surface Transparency

The next step is to set the transparency of the second surface so that parts of the first surface are visible in this intersection plot.

1. Double click on the second colormap surface to open the **Plot Details** dialog.

- In the **Surface** tab, move the **Transparency** slider to 40% and click **Apply**, then **OK**.

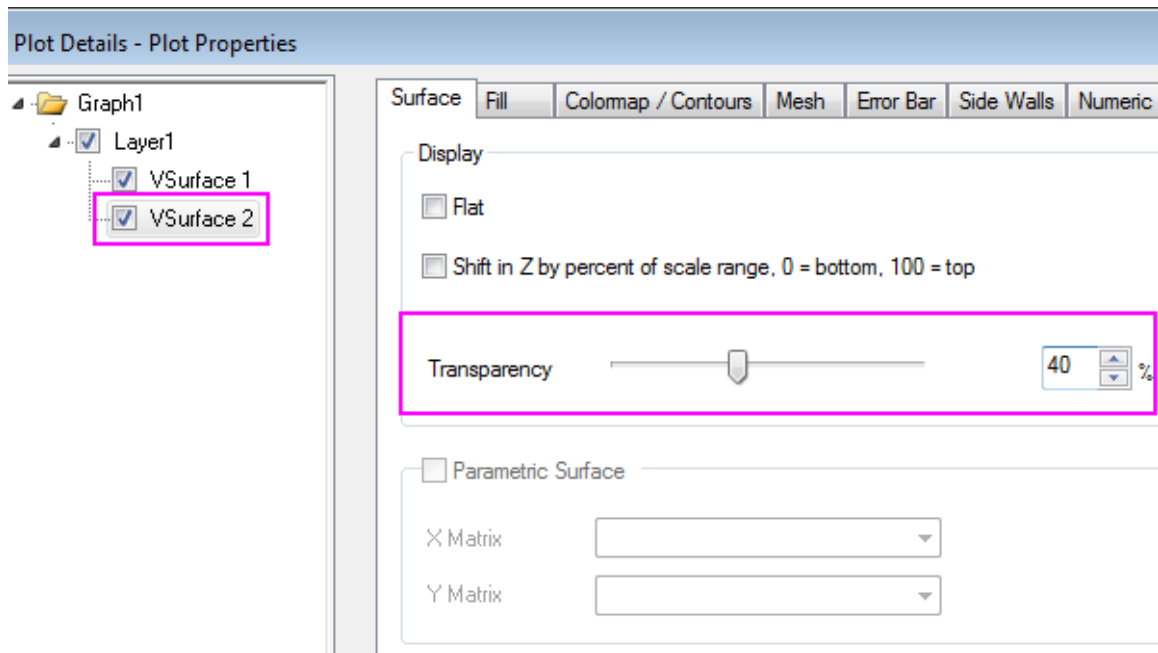

The completed graph should appear as the the image shown below:

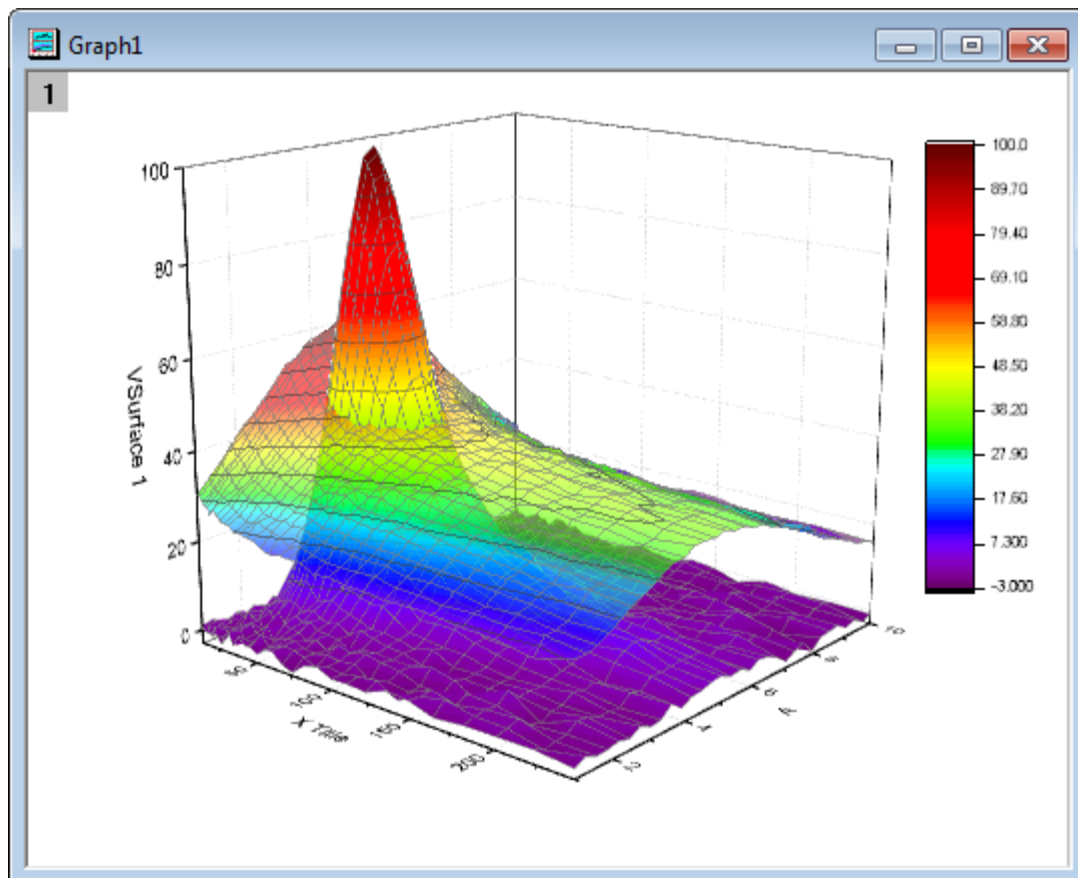

## 6.13.8 Intersecting Color Surfaces

### 6.13.8.1 Summary

Origin supports multiple intersecting surfaces.

Minimum Origin Version Required: Origin 9.0 SR0

### 6.13.8.2 What you will learn

This tutorial will show you:

- How to create intersecting color surfaces from different matrix objects.
- How to customize the colormap surface plot.
- How to construct additional color scale for multiple colormap surfaces.

### 6.13.8.3 Steps

This tutorial is associated with the **Tutorial Data** project: <Origin EXE Folder>\Samples\Tutorial Data.opj.

1. Open the **Tutorial Data** project and browse to folder *Intersecting Surfaces* in **Project Explorer**.
2. Active the **MBook36** matrix. Note that the matrix displays two thumbnail images above the data, one for each matrix object in the matrix.



To plot intersecting surfaces, each matrix object must have identical dimensions and XY Mapping. This requirement is automatically fulfilled when the two objects are contained in the same matrix.

3. Select either thumbnail image. From the main menu, select **Plot > 3D : Multiple Colormap Surfaces**. This will generate an intersecting surface plot of every matrix object in the matrix sheet.
4. Open the **Layer Properties** dialog by double-clicking on the graph layer, or by selecting **Format: Layer...** from the main menu. Go to the **Lighting** tab, and change the **Mode** to **Directional** to turn on the lighting effect.

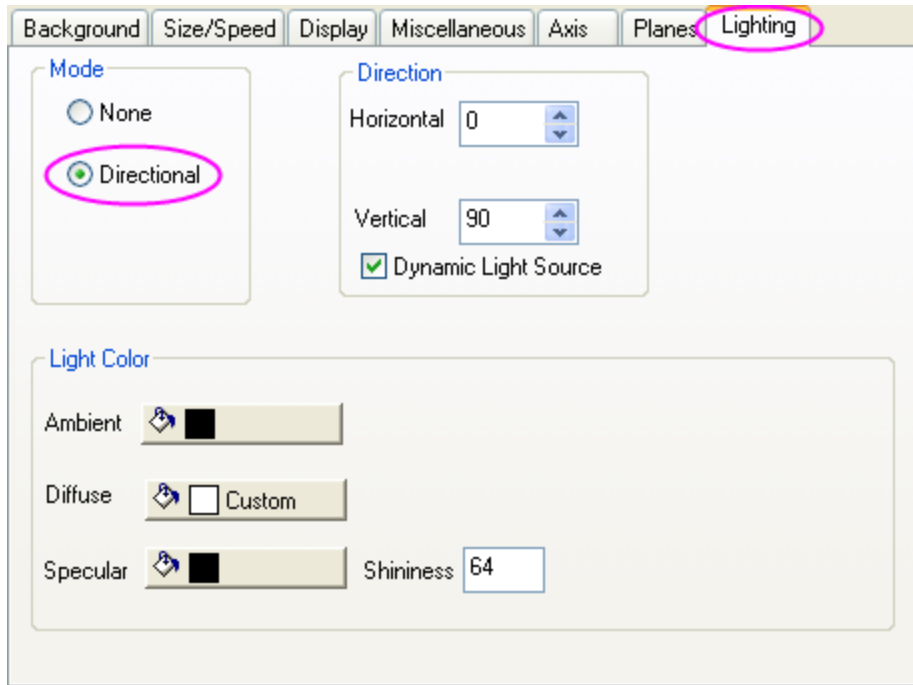

Click on **Apply** button, you can find the graph showing as this:

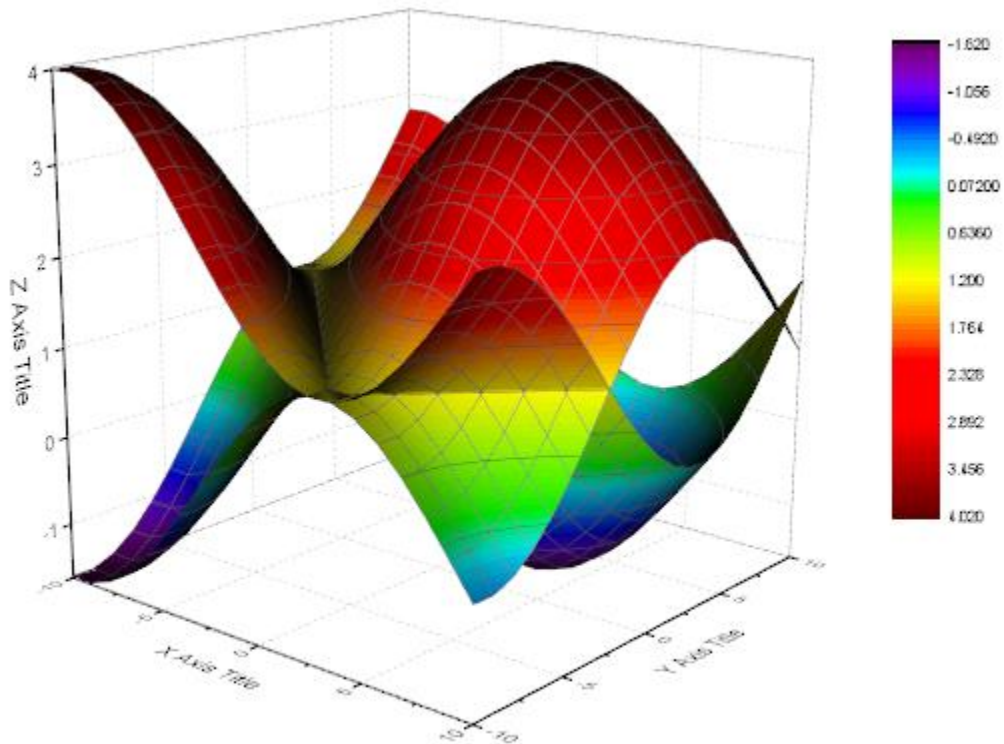

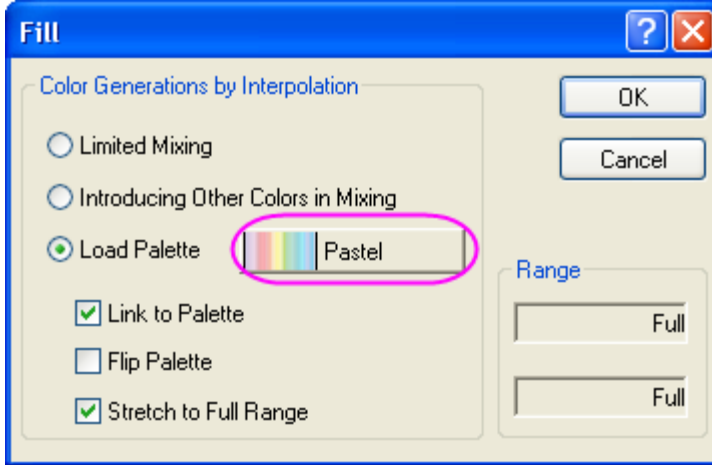

- Expand the **Layer 1** branch in the left panel, select **[MBook36]MSheet1!\_1(Z)[1\*:400\*]** to open the **Plot Properties** dialog. In the right panel, go to the **Colormap/Contour** tab, uncheck the **Enable Contours** check box to turn off contour lines
- Click the **Fill...** column header to open the **Fill** dialog box. Click the default **Rainbow** palette to open the palette menu. On the palette menu, select **Pastel**. Click **OK** to close the **Fill** dialog box.

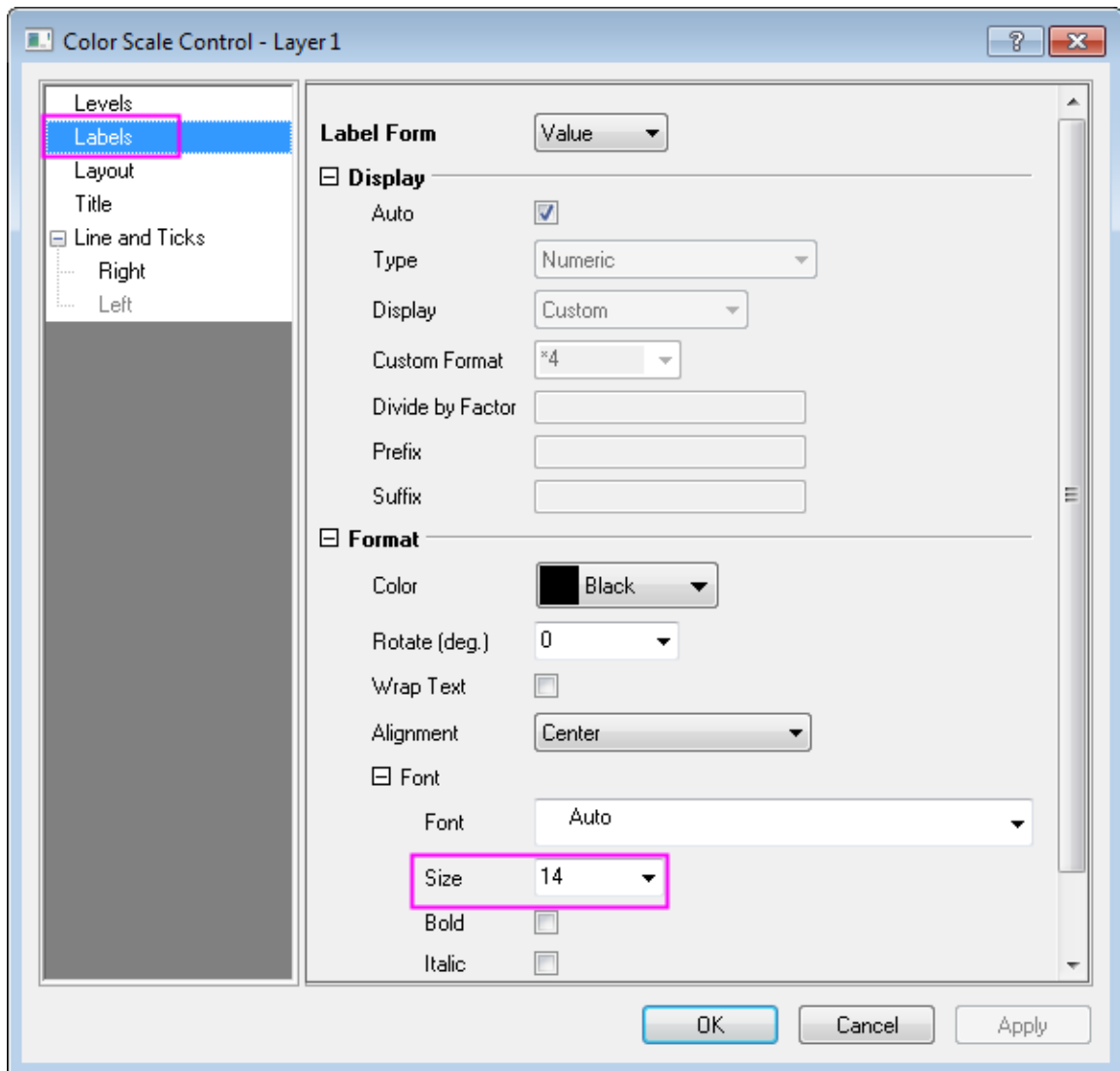

- Select **[MBook36]MSheet1!\_2(Z)[1\*:400\*]** in the left panel. Uncheck the **Enable Contours** check box. And click **Apply** to see the modifications so far. Do the same for **[MBook36]MSheet1!\_1(Z)[1\*:400\*]**.
- Keep **[MBook36]MSheet1!\_2(Z)[1\*:400\*]** selected, and go to the **Mesh** tab and clear the check box before **Enable** to turn off the mesh lines. Do the same for **[MBook36]MSheet1!\_1(Z)[1\*:400\*]**. Click **OK** to close the **Plot Details** dialog box and update the graph.
- Now we will construct the an additional color scale for the second surface, change that plot to be active by click **Data:2 [MBook36]MSheet1!\_2(Z)[1\*:400\*]**, then click **Insert: Color Scale** to create color scale for this plot.
- Double click on the newly added color scale object to open the **Color Scale Control**, change the settings according to the screenshots below, then drag and put the color scale object to a desired place on the layer:

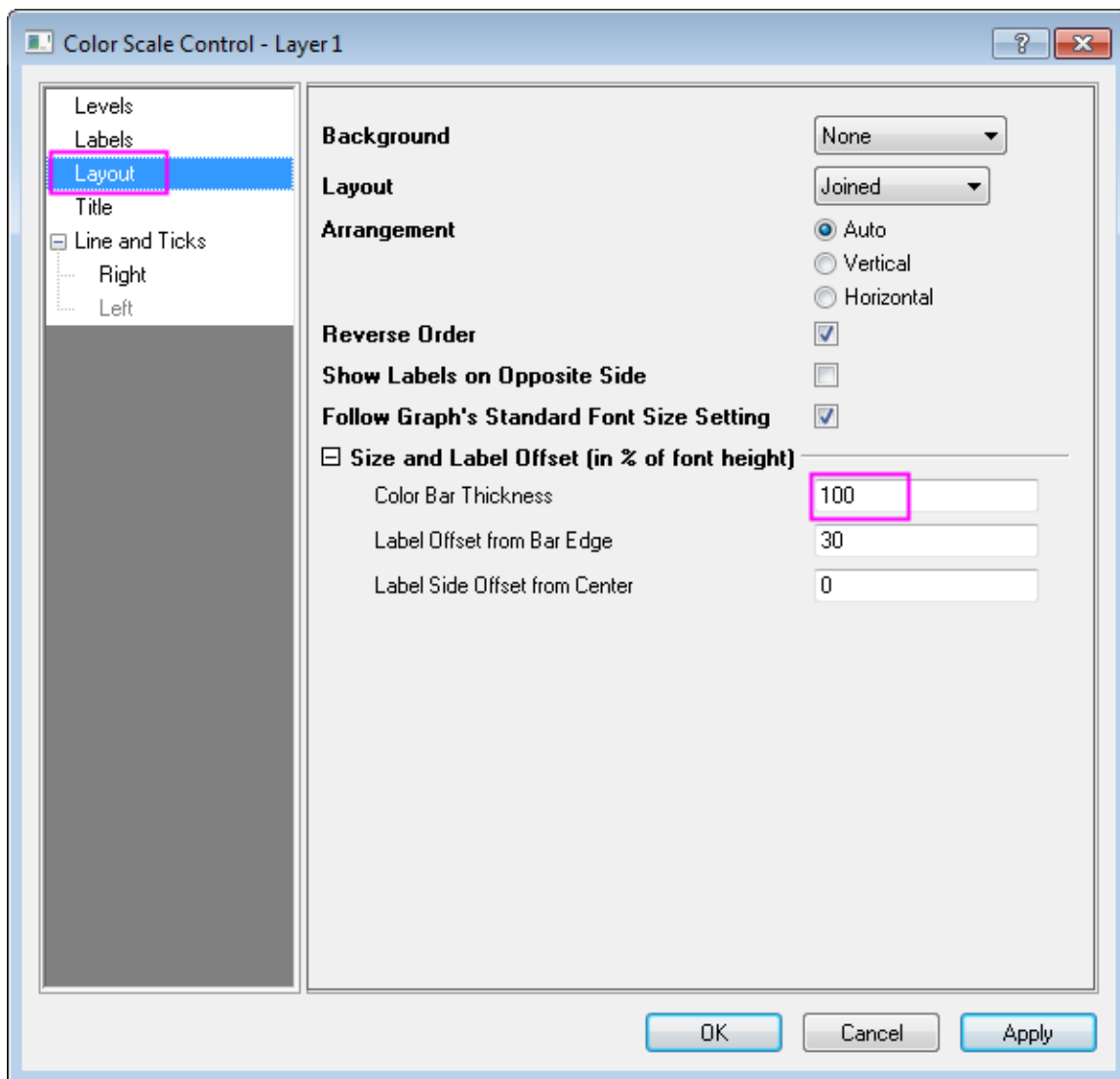



11. You can use the 3D rotation button  to rotate the graph and gain an overhead perspective. This button is a part of the 3D annotation toolbar which can be brought out by clicking the graph layer once



Your final graph should look something like this:



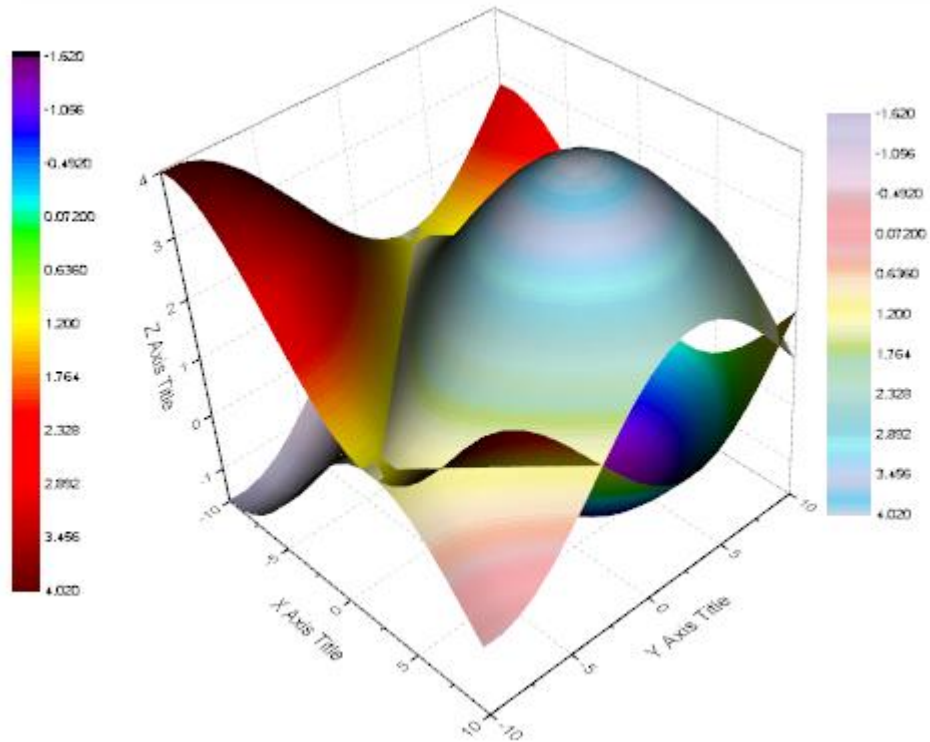

### 6.13.9 Surface with Symbols and Droplines

#### 6.13.9.1 Summary

Origin supports transparency in most graph types. This feature permits the visibility of parts of a graph that would otherwise be obscured by overlapping plots. In this tutorial, we will add a fitted surface to a scatter plot, set transparency to make data points "behind" the surface visible, and add drop lines and error bars for data points.

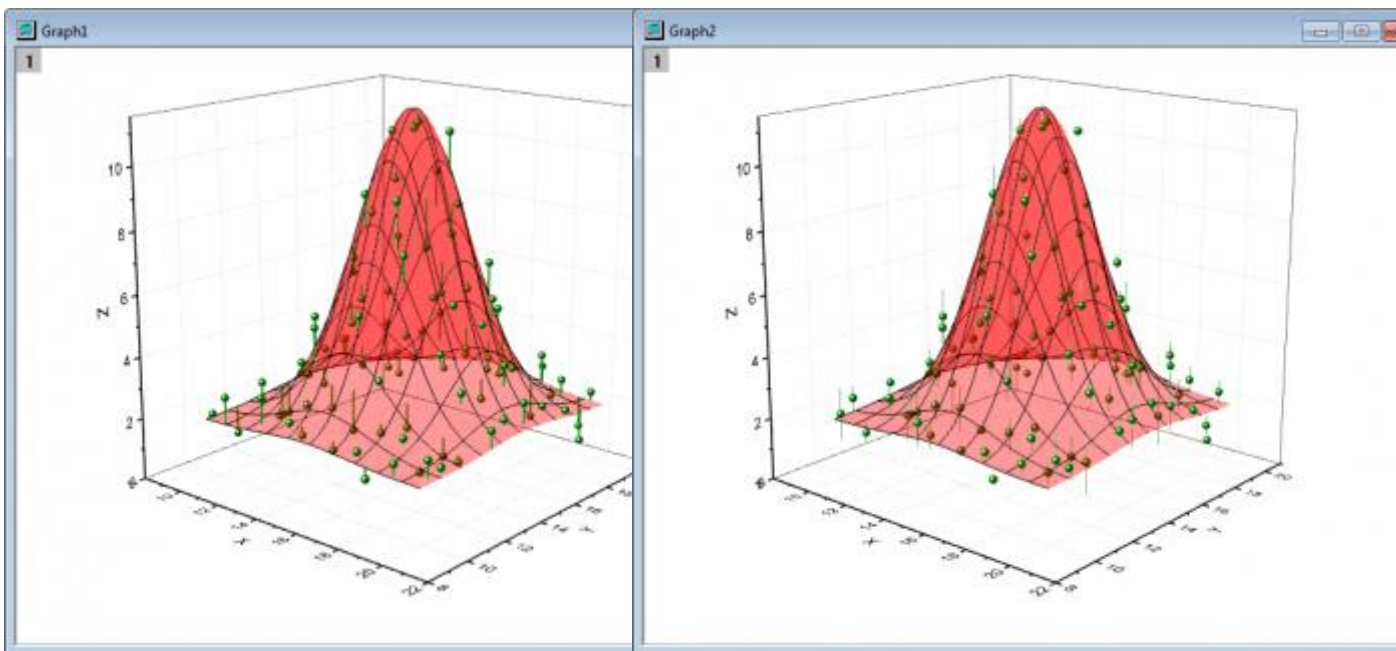

**Surface with Symbols and Droplines**

**Surface with Symbols and Error Bar**

Minimum Origin Version Required: 8.5 SR0

#### 6.13.9.2 What you will learn

- Create a 3D scatter plot from worksheet data and add a color fill surface to it.
- Draw drop lines or error bars for data points.
- Set surface transparency.

#### 6.13.9.3 Steps

##### 6.13.9.3.1 **Create a surface graph with symbols and droplines**

This tutorial is associated with <Origin EXE Folder>\Samples\Tutorial Data.opj.

1. Open the **Tutorial Data.opj** and browse to the folder **Surface with symbols and droplines**.
2. Active the worksheet *XYZRandomGauA*, highlight the XYZ to plot a 3D scatter by selecting **Plot > 3D : 3D Scatter** from the main menu.

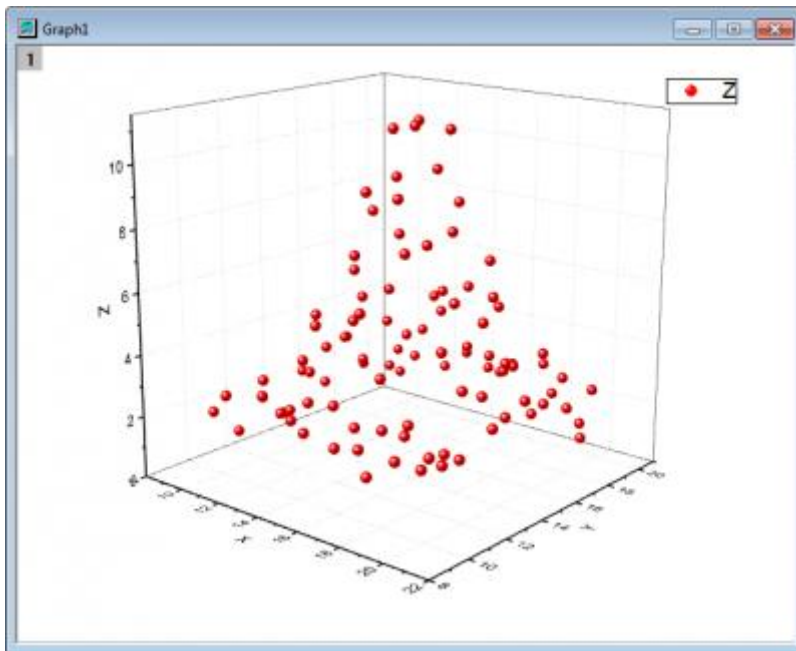

3. Now we will add a 3D Color Fill Surface plot to this 3D scatter graph. In the top left corner of the graph window, double-click the layer **1** icon to open the **Layer Contents** dialog.
4. In the **Layer Contents** dialog box, select **Matrices in Folder** from the dropdown menu in the upper left. In the left panel, select **MBook 3**, Click the **triangle button** next to **A** and select **3D - Surface**.

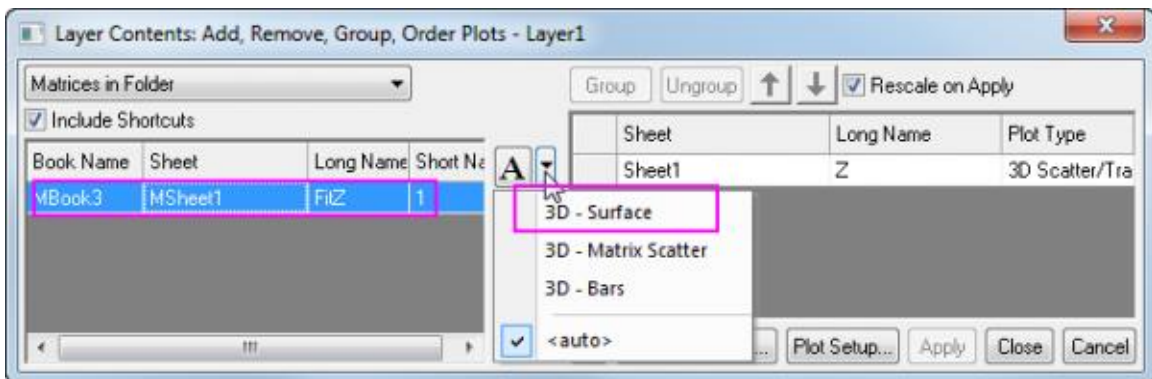

Click  to add it to the right panel.



- Click **OK** button to apply the change and close the **Layer Contents** dialog. Double-click the graph to open the **Plot Details** dialog box. In the left panel of this dialog, expand all items and select **Original** (or choose **Plot** from the **Format** menu). In the right panel, on the **Symbol** page set **Size** as 9 and **Color** as *Olive* from **Individual Color** fly-out menu and click **Apply**.

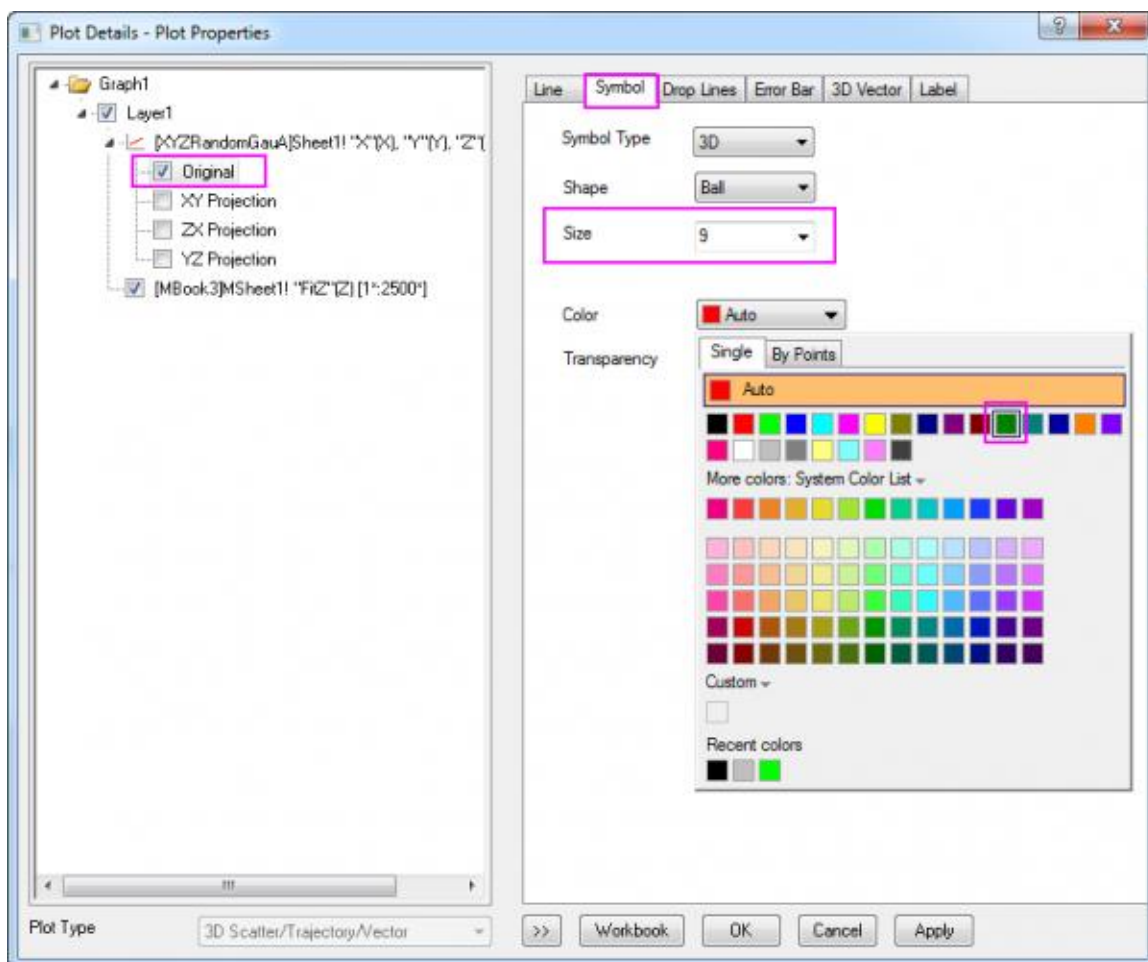

- In the left panel, select the surface plot, and then go to the **Fill** tab in the right panel, change the **Fill piece by piece** as **Red**. Set **Transparency** to **60** and click **Apply**.

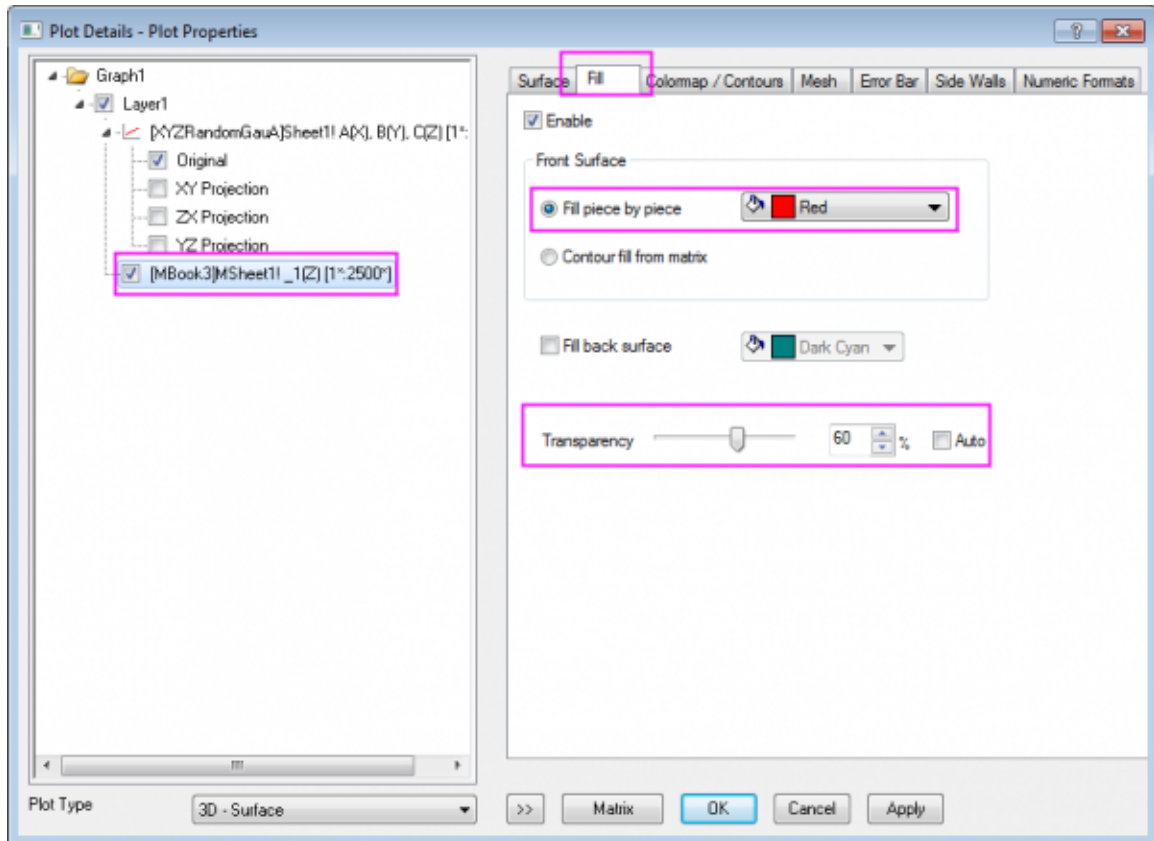

7. Go to the **Mesh** tab, set the **Line Width** as **1** and **Set Total Number of Majors** as  $X=9$  and  $Y=9$ , and **Major Line Color** as *Black* and click **Apply**.

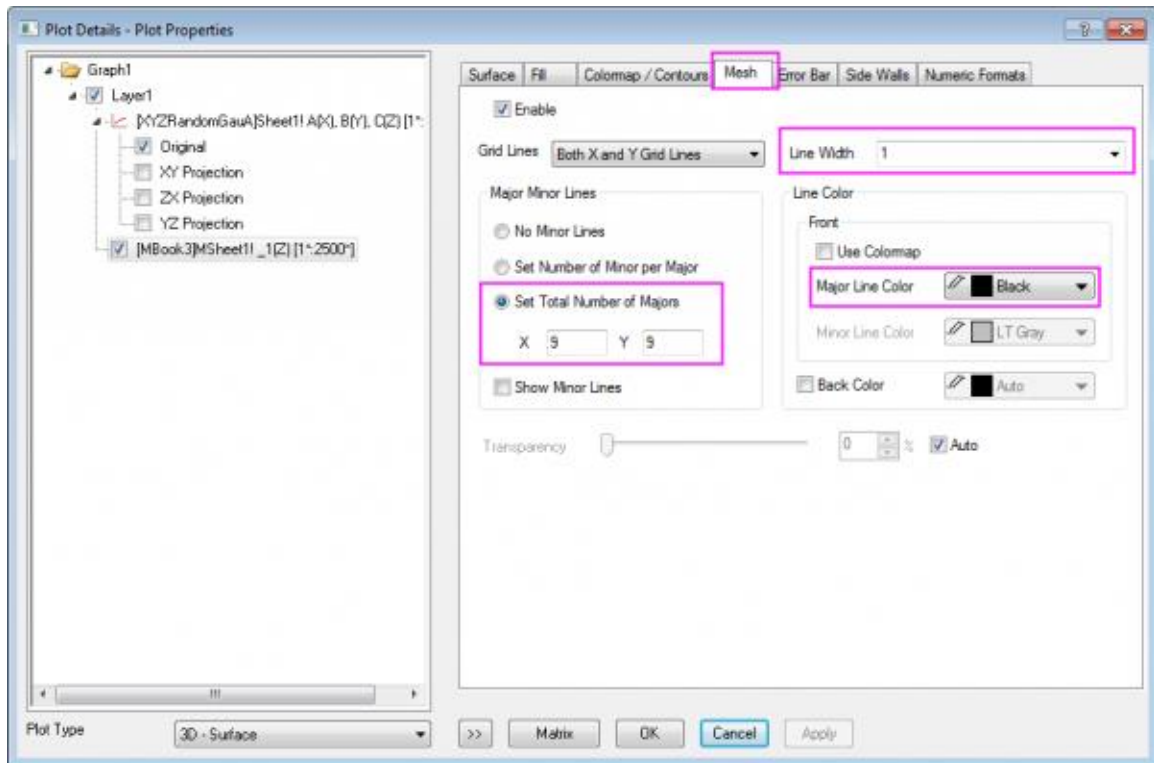

8. Now we will draw the drop lines. In the left panel, select the scatter plot (Original). In the right panel, select the **Drop Lines** tab. Select the **Parallel to Z Axis** check box, change the drop line **Width** to **2** and set the **Drop to** to **Surface**.

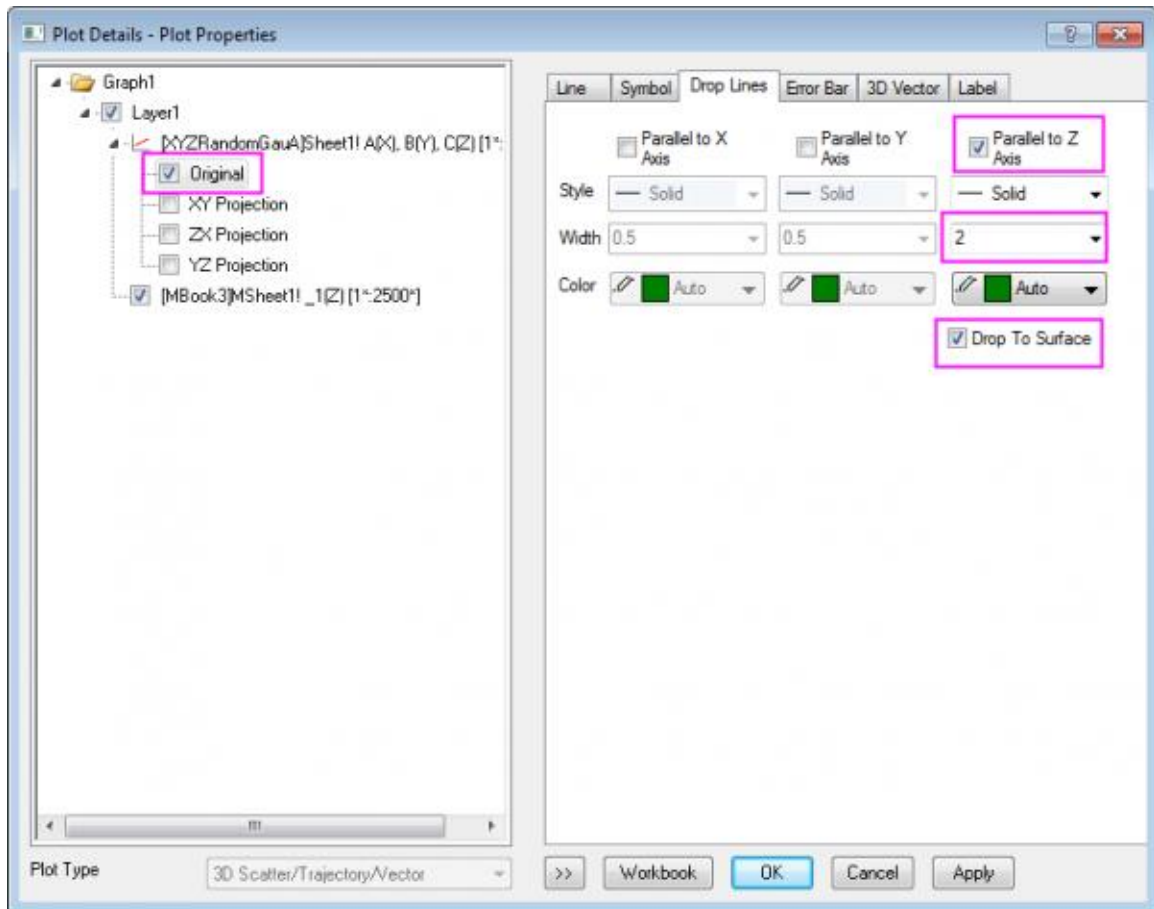

9. Click **OK** to close the dialog and delete the legend. Your final graph should look like this:

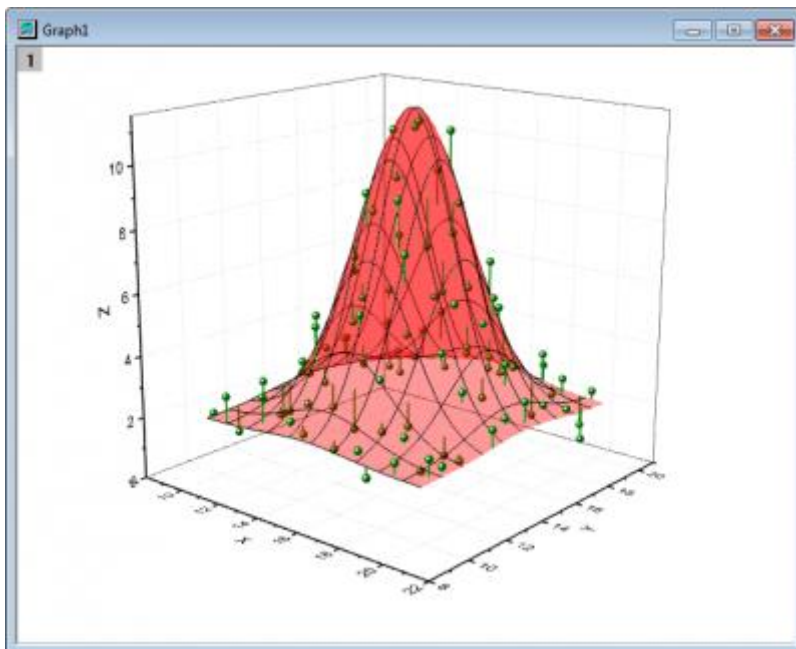

### 6.13.9.3.2 Create a surface with symbols and error bar

1. Follow steps 1 through 8 above and click **OK** to create a 3D surface graph with a scatter plot.
2. Add a new column in the worksheet "XYZRandomGauA". Select the column and right-click. In the **Fill Column with** context menu, click **Uniform Random Numbers**.
3. Double click on the newly created graph to open the **Plot Details** dialog. Expand the node to select the plot (Original) in the left panel. On the **Error Bar** tab, select the **Enable** check box, and select **Col(D)** from the **Error Data** dropdown menu.

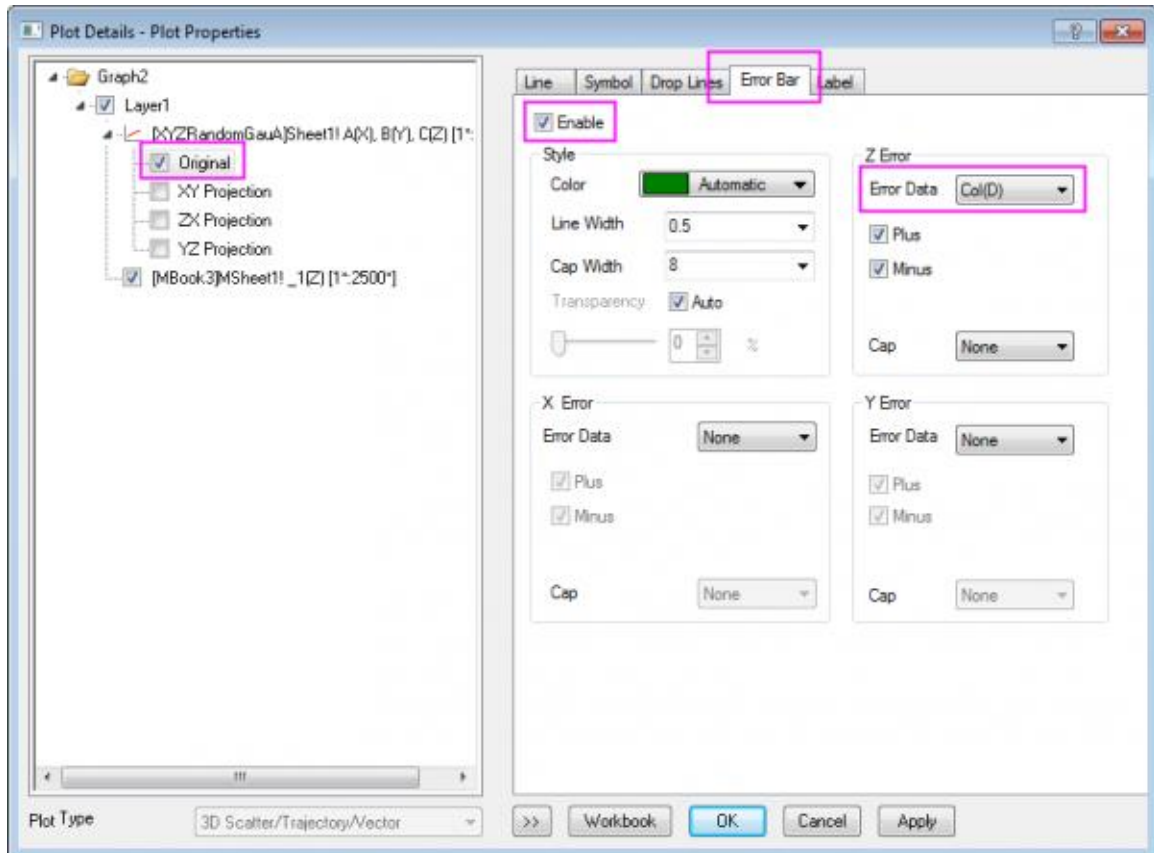

4. Click **OK** to close the dialog and delete the legend. Your final graph should look like this:



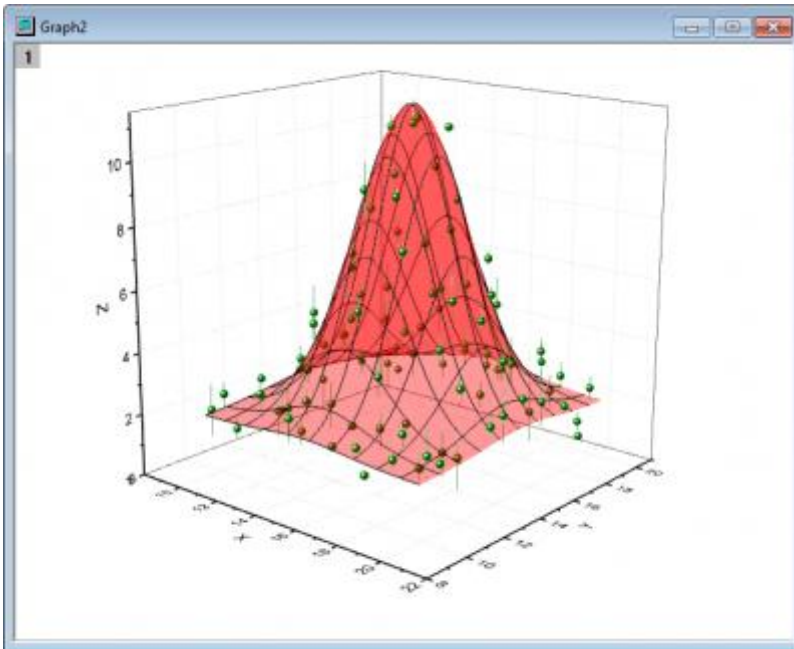

### 6.13.10 Colormap from Second Matrix

#### 6.13.10.1 Summary

Origin can represent four-dimensional data by color-mapping a surface plot using a second matrix.

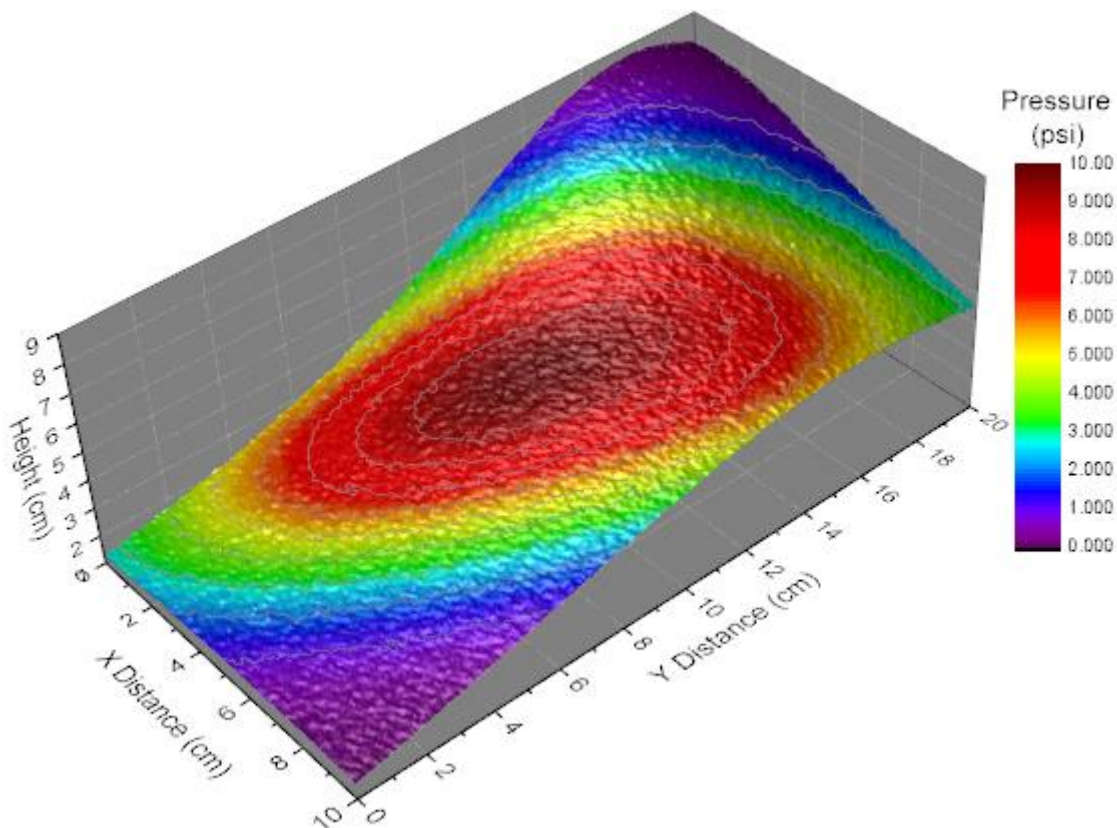

Minimum Origin Version Required: Origin 2015 SR0

#### 6.13.10.2 What you will learn

- Create a Color Fill Surface from a matrix.
- Color map a surface plot using a second matrix.
- Customize color map levels and palette.
- Control lighting on the graph (From Origin 9 SR0)

#### 6.13.10.3 Steps

This tutorial is associated with the **Tutorial Data** project: <Origin EXE Folder>\Samples\Tutorial Data.opj.

1. Open the **Tutorial Data** project and browse to folder *Surface with Colormap from Another Matrix* in **Project Explorer**.
2. Active the **MBook1D** matrix, You should see two image thumbnails above the matrix data, just under the title bar. (If you do not see image thumbnails, right-click on the matrix title bar and select **Show Image Thumbnails**.) Select image thumbnail 1."
3. On the main menu, select **Plot > 3D : 3D Color Fill Surface** to generate a surface plot.

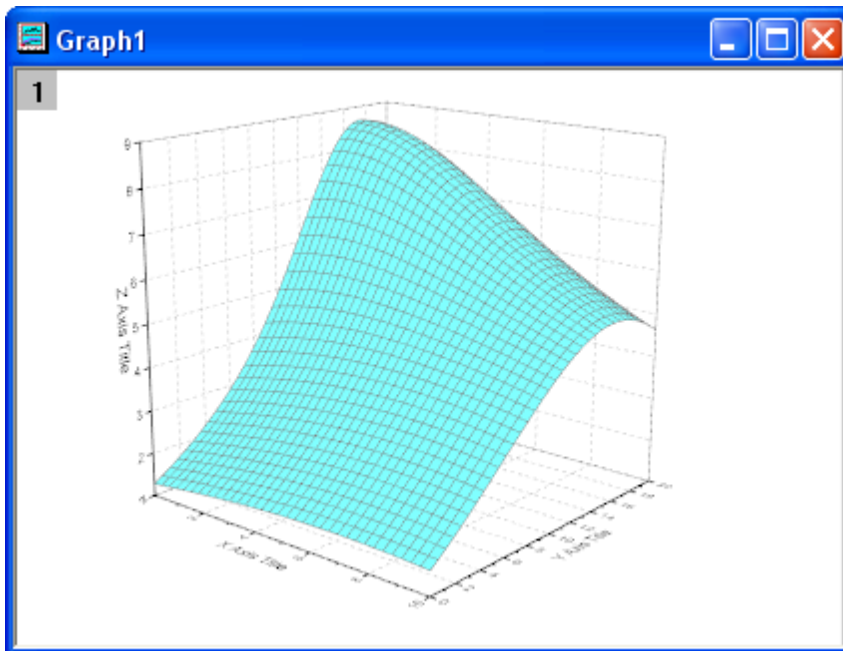

4. Double click on the plot to open the **Plot Details** dialog. In the left panel, select **(MBook1D)MSheet1**. In the right panel, select the **Fill** tab. Choose **Contour Fill from Matrix**, and select **Mat(2)** for front surface.

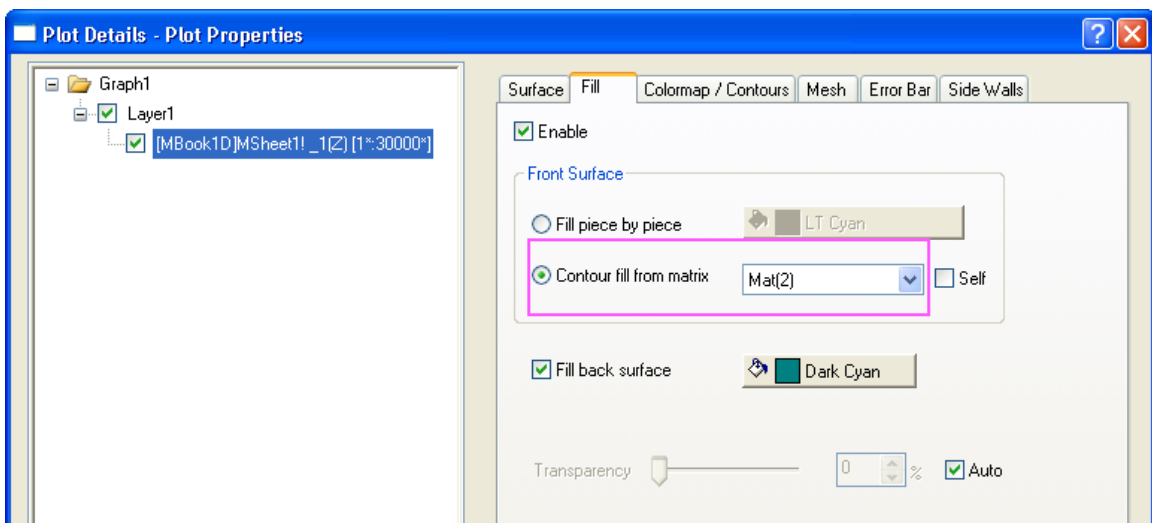

5. Go to **Colormap/Contours** tab, click the **Level...** title to open the Set Levels dialog. In this dialog, click **Find Min/Max** button and set the **#Major Levels** and **#Minor Levels** as 10 and 9. Click OK button to close the dialog.

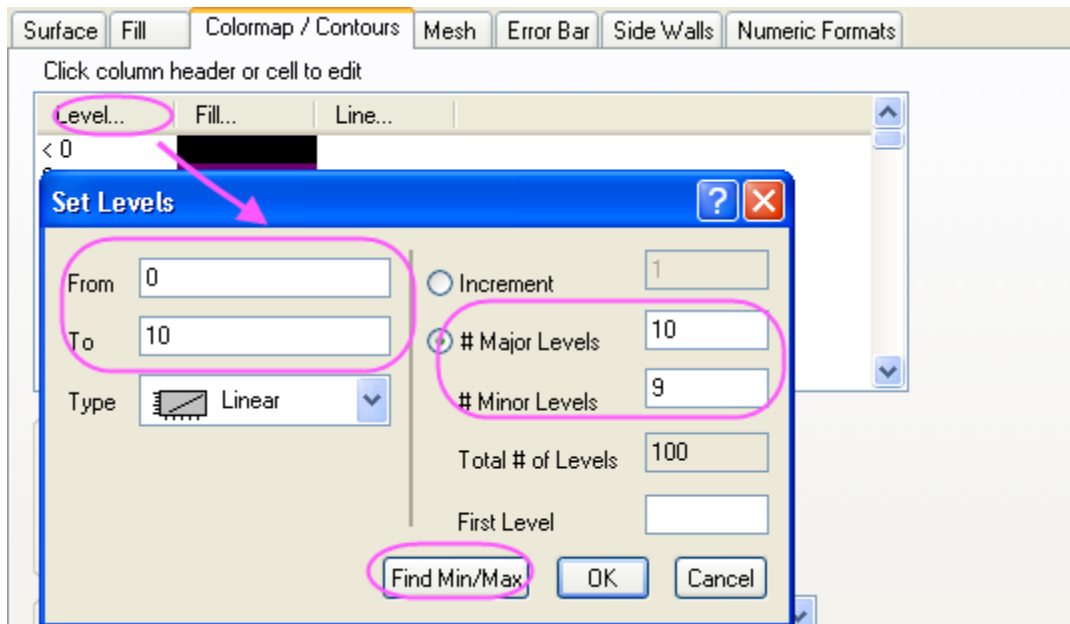

6. Click the **Fill...** title to open the **Fill** dialog. select **Load Palette** and then click **Select Palette** button to select **Rainbow** palette. Click **OK** button to close this dialog.

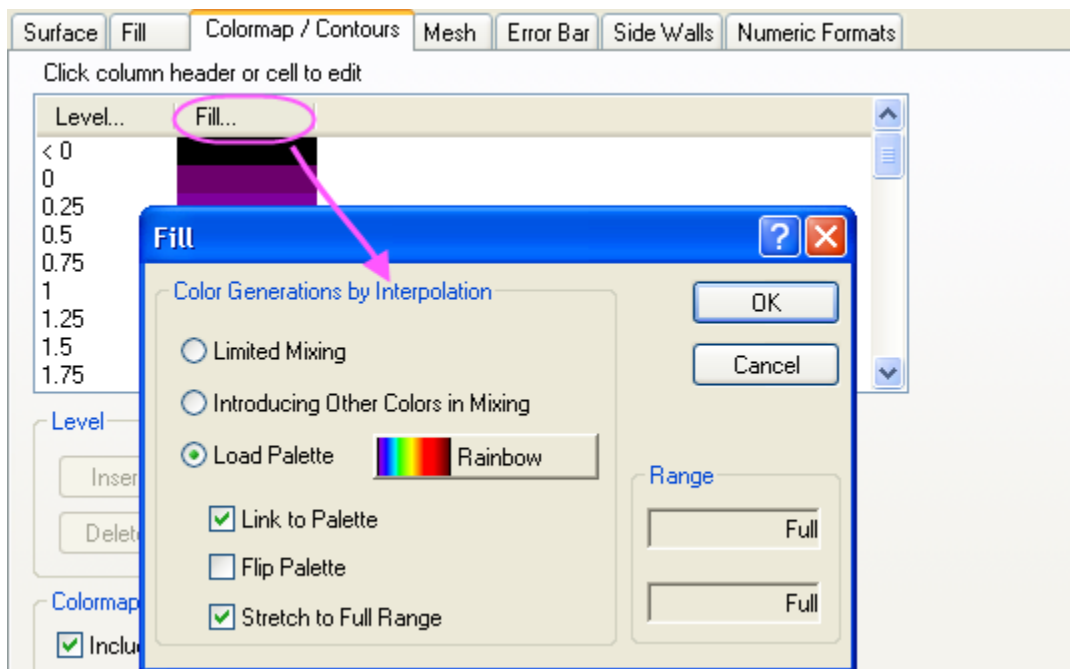

7. Check the **Enable Contours** check box. And then click **Line...** to open the **Contour Lines** dialog. In this dialog, check the **Show on Major Levels Only** check box and set the **Line Properties** as below. Click **OK** button to close the dialog.

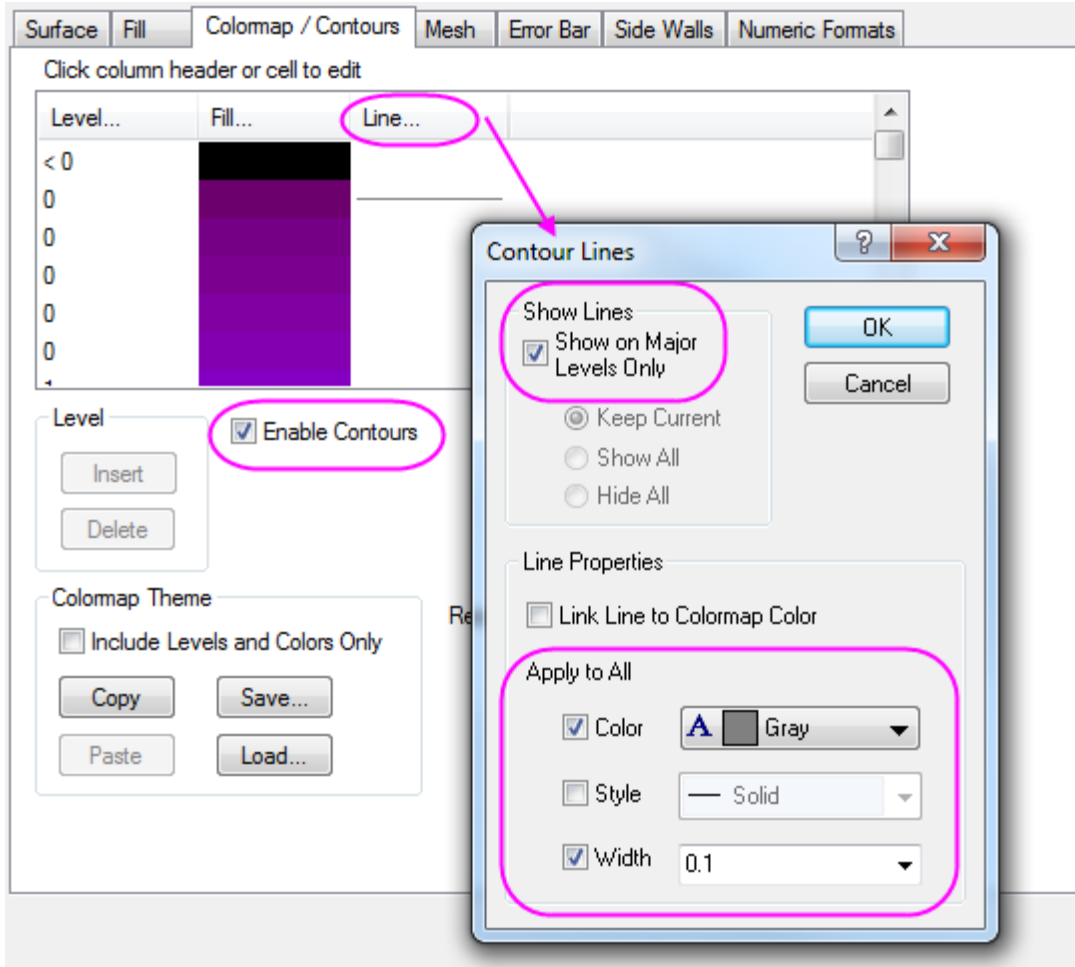

8. Go to the **Mesh** tab, uncheck the **Enable** box to disable the mesh lines.
9. Select **Layer1** in the left panel, go to **Lighting** tab in the right panel. Select **Directional** under **Mode**. Set **Horizontal** and **Vertical** as *124* and *40*, and change the color of **Diffuse** as *LT Gray* and **Specular** as *Gray*. Then set the **Shininess** as *37*.

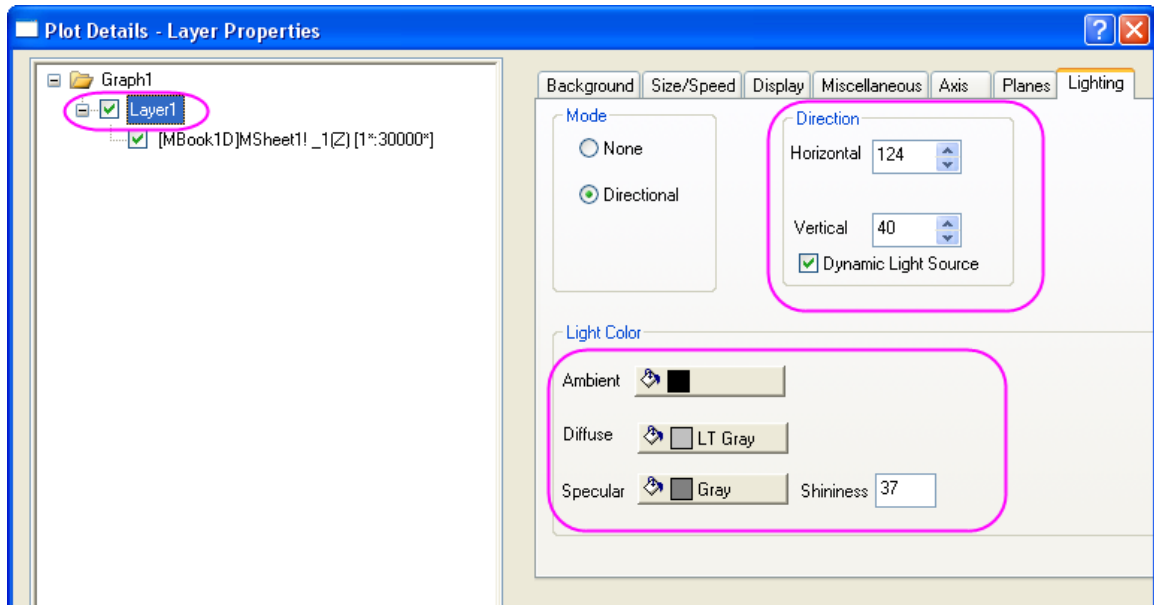

10. Go to the **Planes** tab, set the color as **Gray** and select **Front Corner** for the Cube drop-down menu.

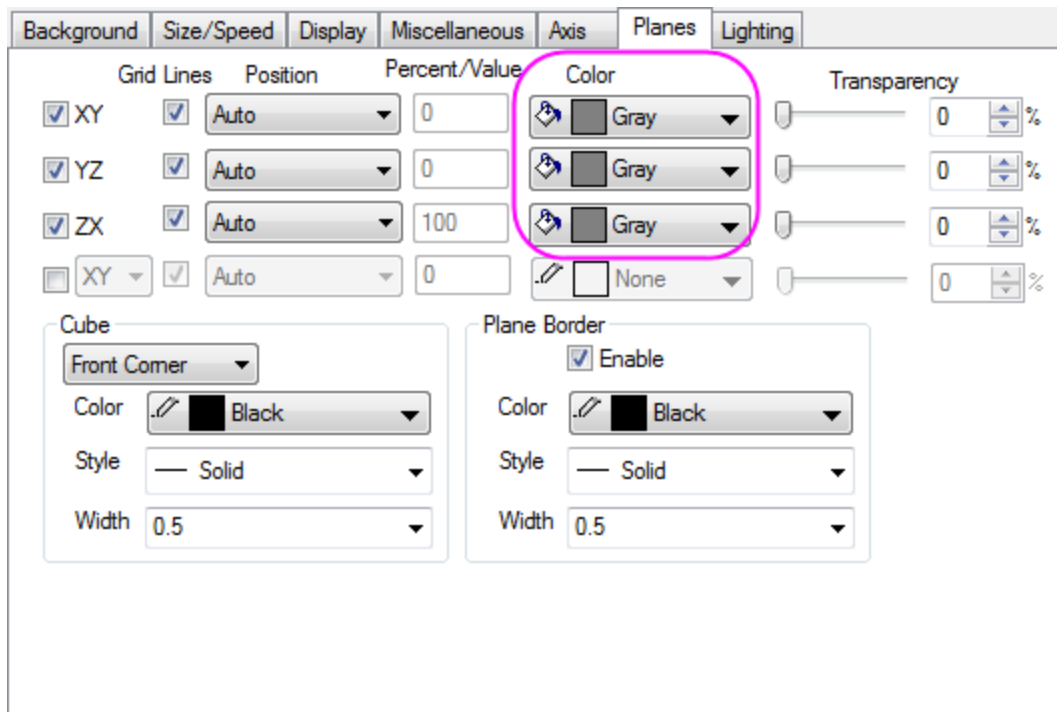

11. Go to **Axis** tab and do settings as below. Click **OK** button to close this dialog.

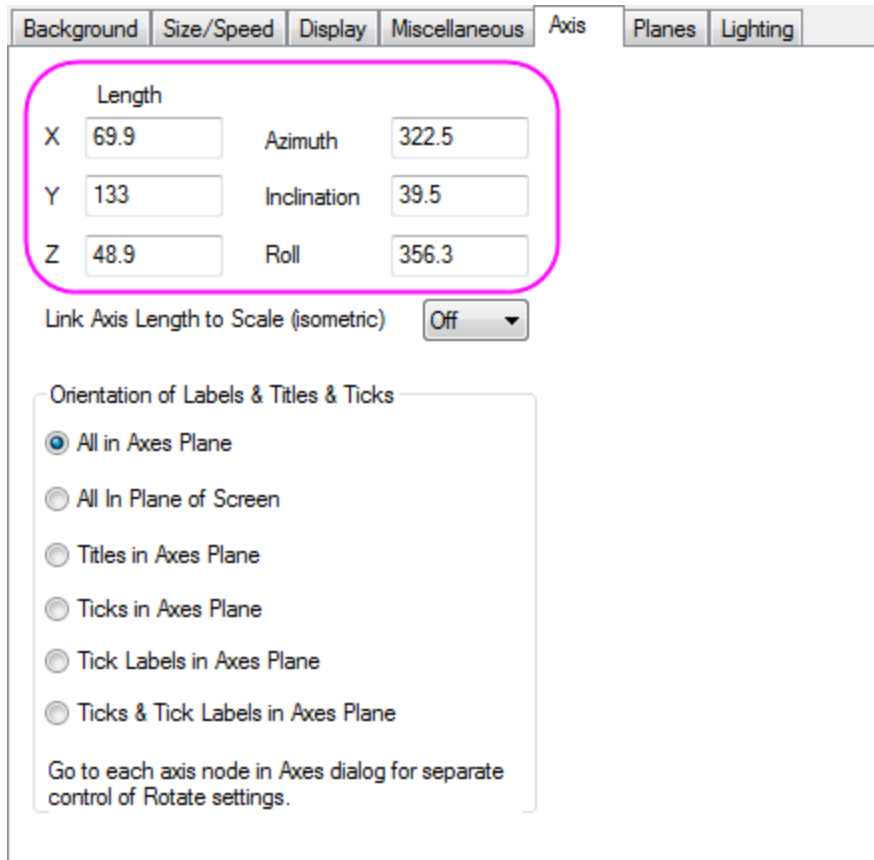

Axis	Length	Angle
X	69.9	Azimuth: 322.5
Y	133	Inclination: 39.5
Z	48.9	Roll: 356.3

Link Axis Length to Scale (isometric)

Orientation of Labels & Titles & Ticks

- All in Axes Plane
- All In Plane of Screen
- Titles in Axes Plane
- Ticks in Axes Plane
- Tick Labels in Axes Plane
- Ticks & Tick Labels in Axes Plane

Go to each axis node in Axes dialog for separate control of Rotate settings.

12. Keep the graph window active. Select **Insert: Color Scale** to add a new color scale in the graph window.
13. Double-click anywhere on the color scale to open the **Color Scale Control** dialog box. Select **Layout** in the left panel, change **Color bar thickness** to **150** and check the **Reverse Order** check box.

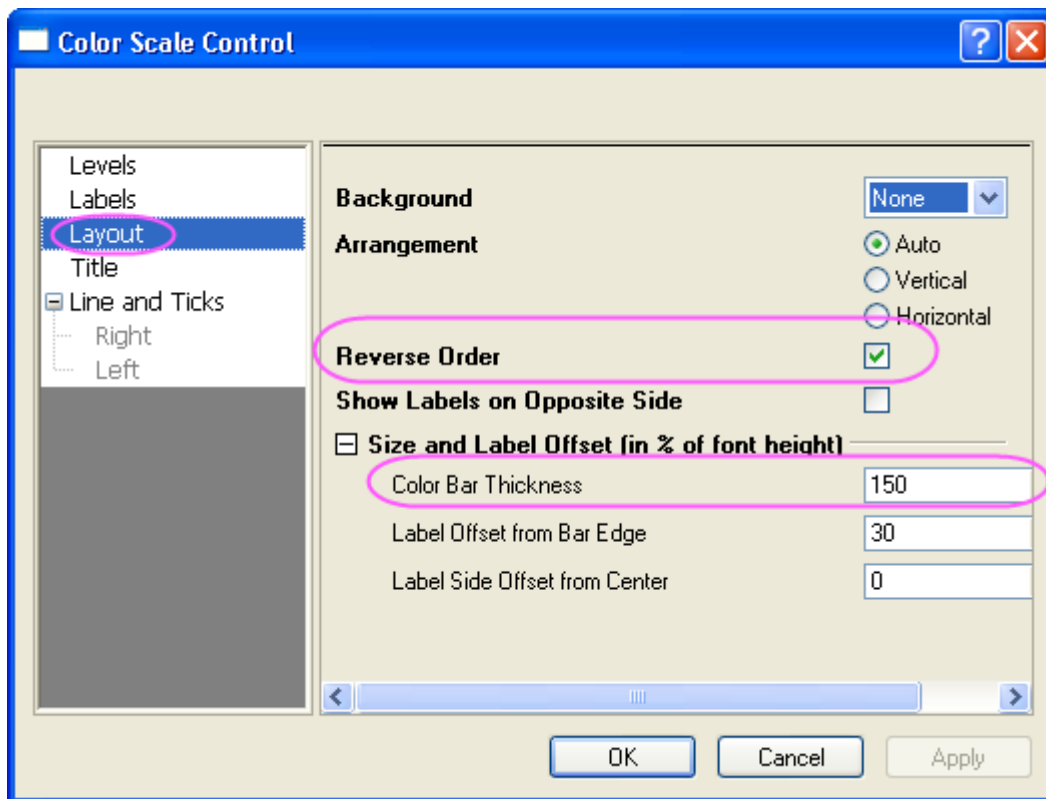

14. Select **Labels** in the left panel, set the **Font Size** to 14 in the right panel as below:

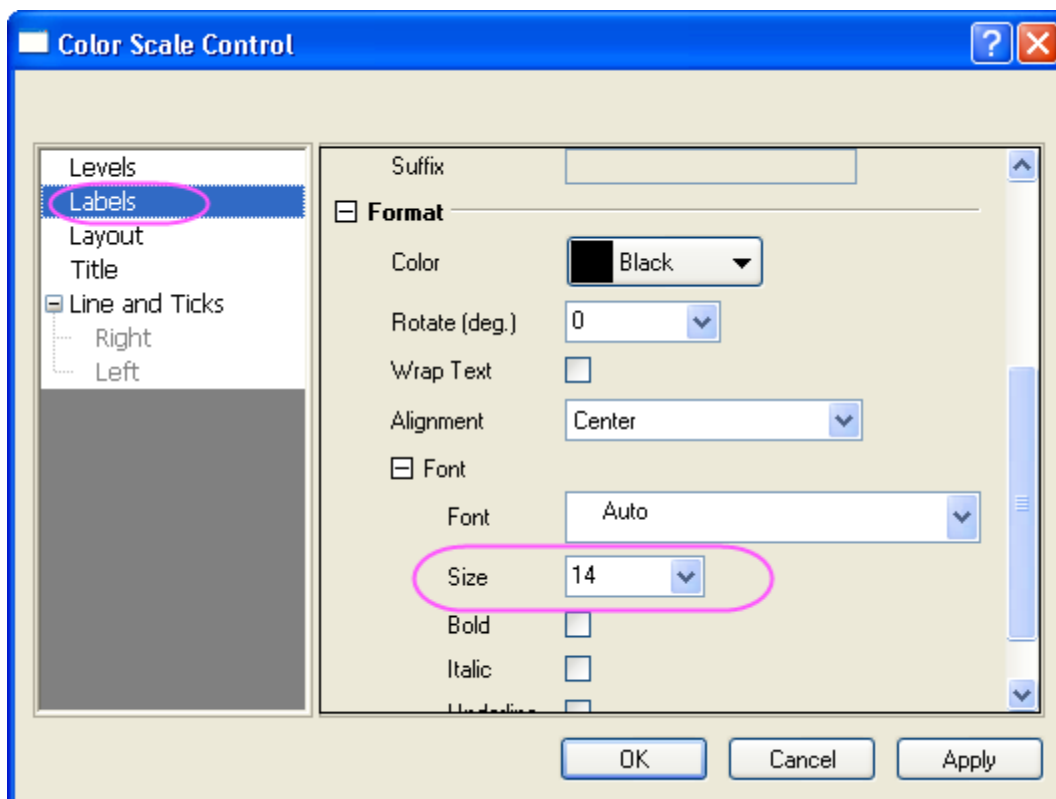



Click **OK** to close the **Color Scale Control** dialog box.

15. Double-click the X, Y and Z axis title and enter "X distance", "Y distance" and "Height". Add a text object "Pressure(psi)" above the color scale.

16. Your final graph should look like this:

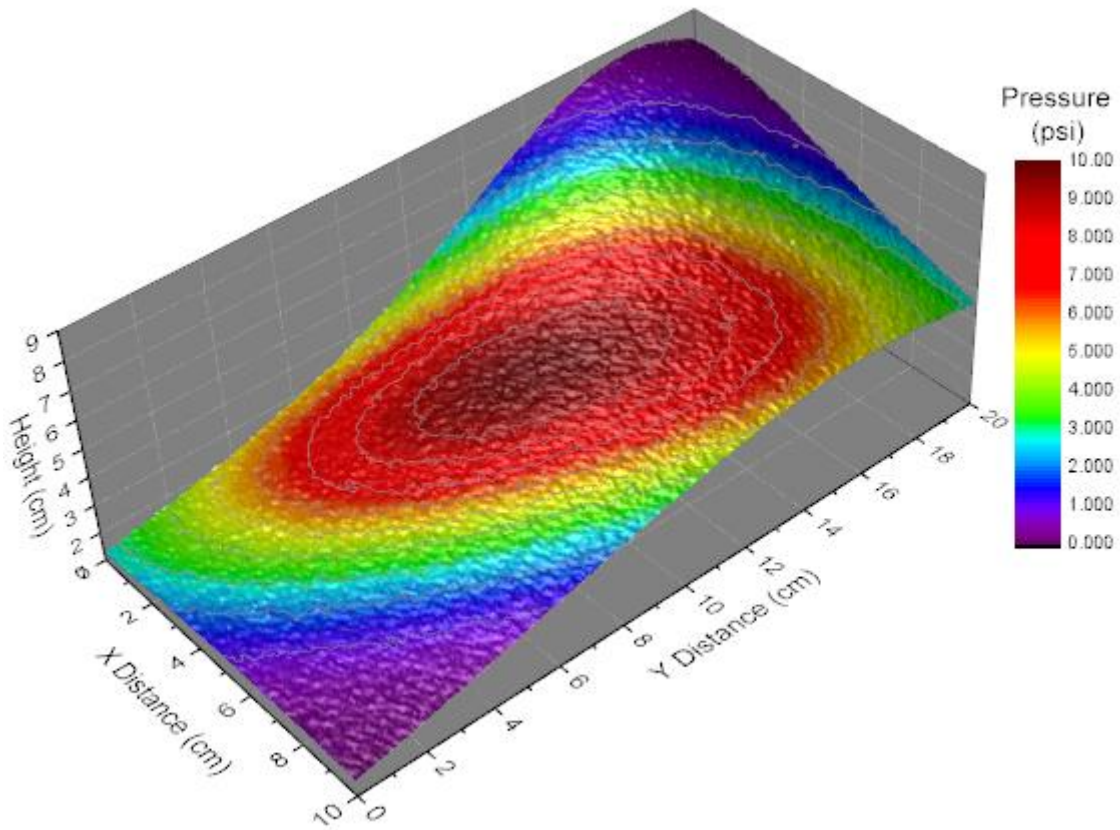

### 6.13.11 Color Map Surface Graph

#### 6.13.11.1 Summary

This tutorial will show you how to create a 3D color map surface.

### Full-body Warming System Heat Transfer Profile

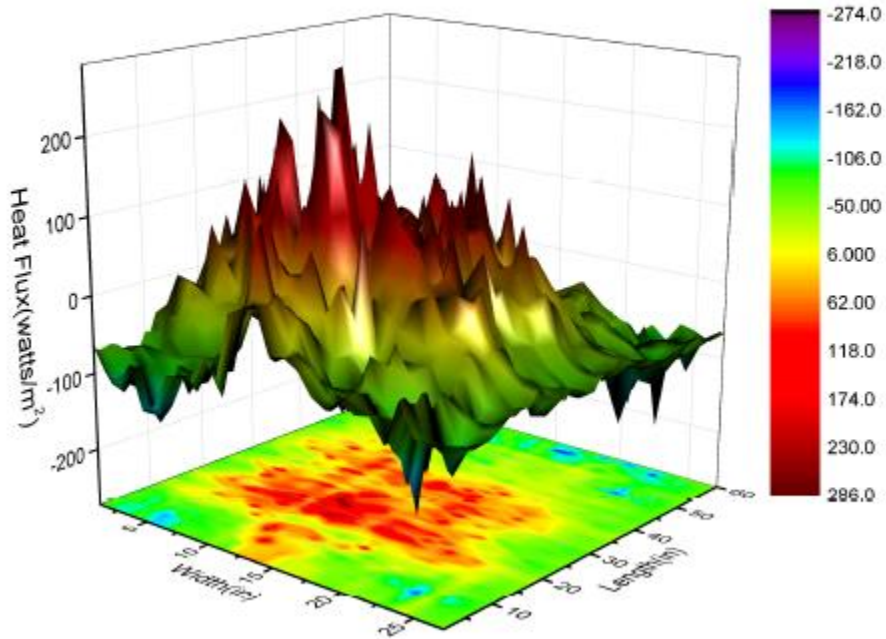

#### 6.13.11.2 What will you learn

This tutorial will show you how to

- Create a 3D color map surface graph
- Customize the 3D surface graph

#### 6.13.11.3 Steps

This tutorial is associated with [this Graph Galley page](#).

1. Download the project by clicking the Download Project link at the top of this page.
2. Open the project in the zipped file. Highlight **HFT data** matrix and select **Plot > 3D : 3D Colormap Surface with Projection** to create a 3D graph.

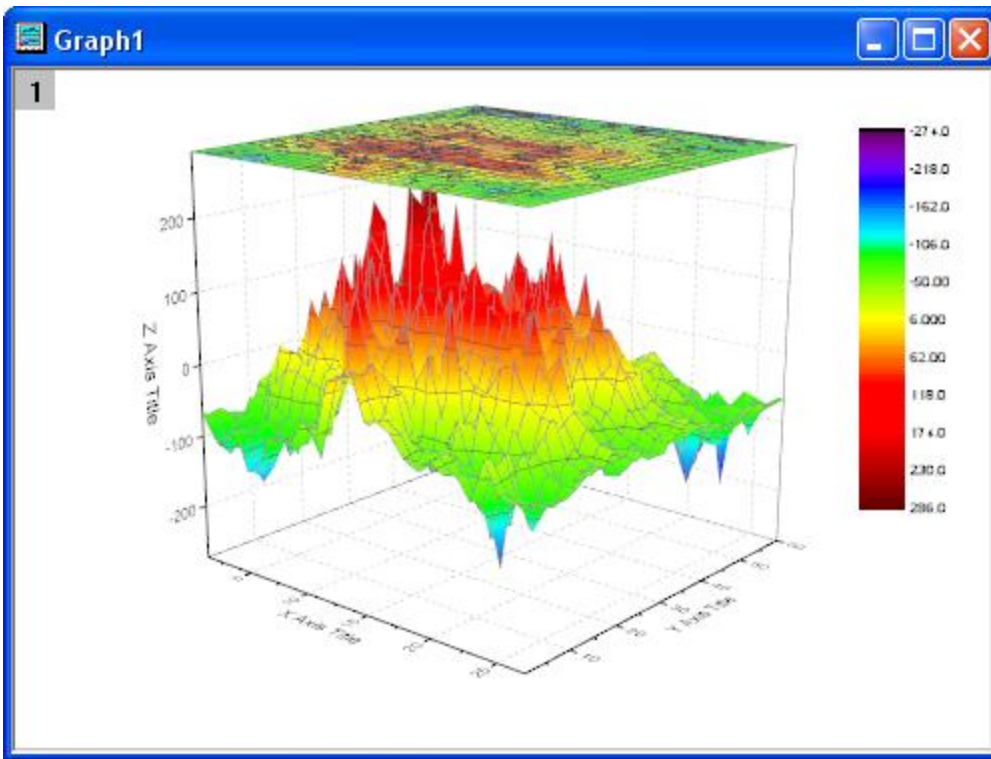

3. Choose **Format: Plot** to go to the plot level of the **Plot Details** dialog.
4. Select the surface plot, go to the Mesh tab, uncheck the **Enable** box to turn off the mesh lines. Go to **Colormap/Contours** tab, click Line title to open the **Contour Lines** dialog. In this dialog, uncheck **Show on Major Levels Only** and select **Hide All** to hide all contour lines.

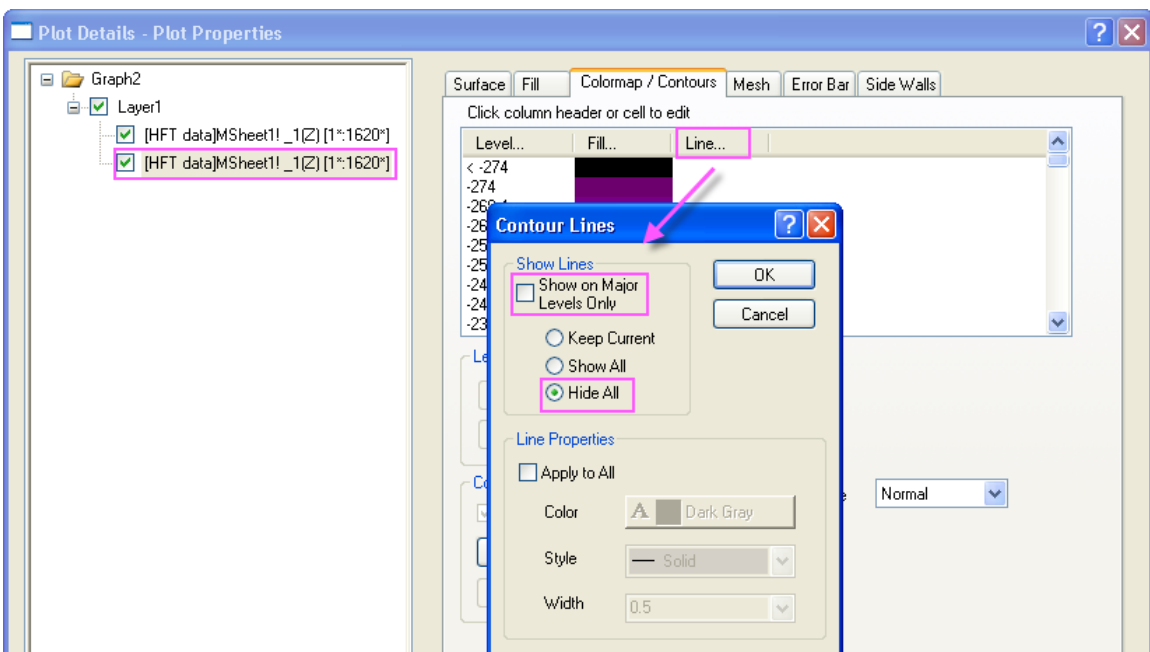

5. Select the projection plot in the left panel, go to **Surface** tab, Enter 0 as the following image shows to put the projection to the bottom of the graph.

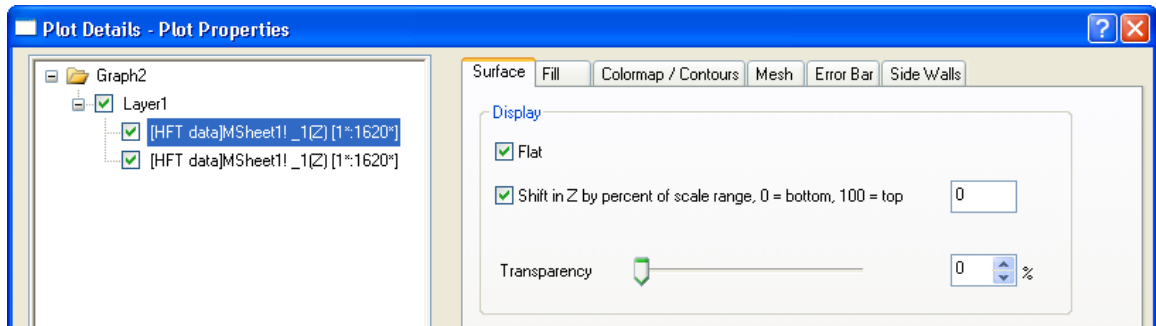

6. Go to the **Mesh** tab, uncheck the **Enable** box to disable the mesh lines. Go to **Colormap/Contours** tab, hide all contour lines like the step4 does.
7. Click Layer 1 in the left panel, and then in the right panel select the **Lighting** tab. Change the setting as following to enable lighting effect:

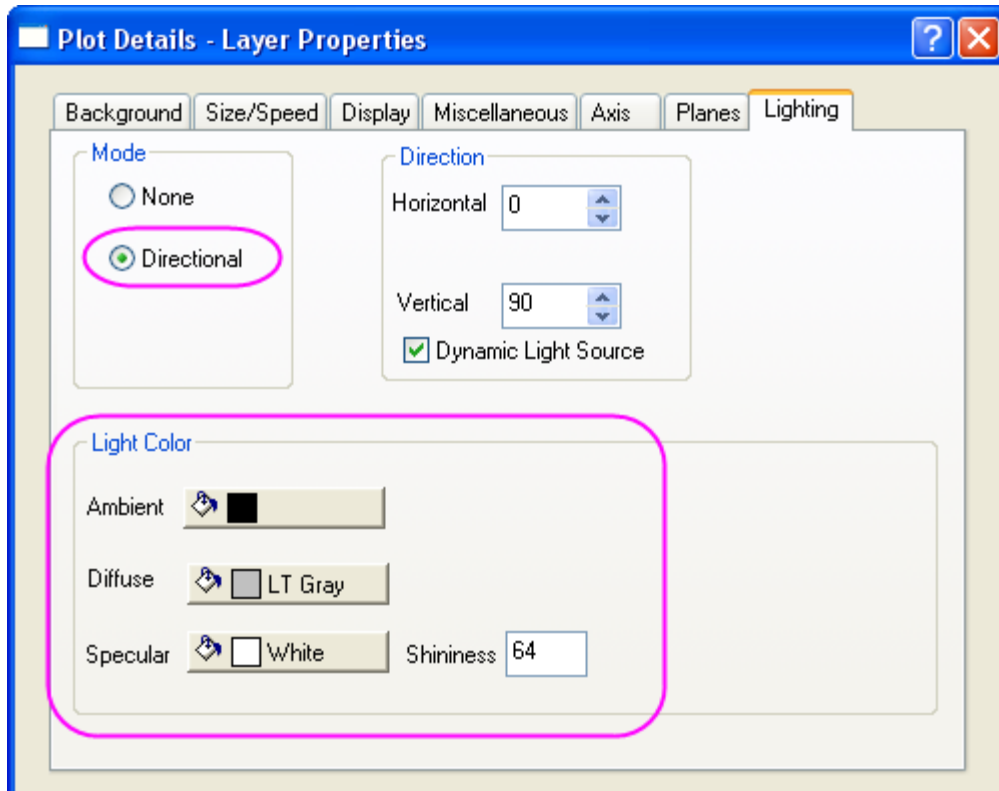

Then Click **OK** to close the dialog.

8. Finally, change axis titles and add a graph title as the following graph.

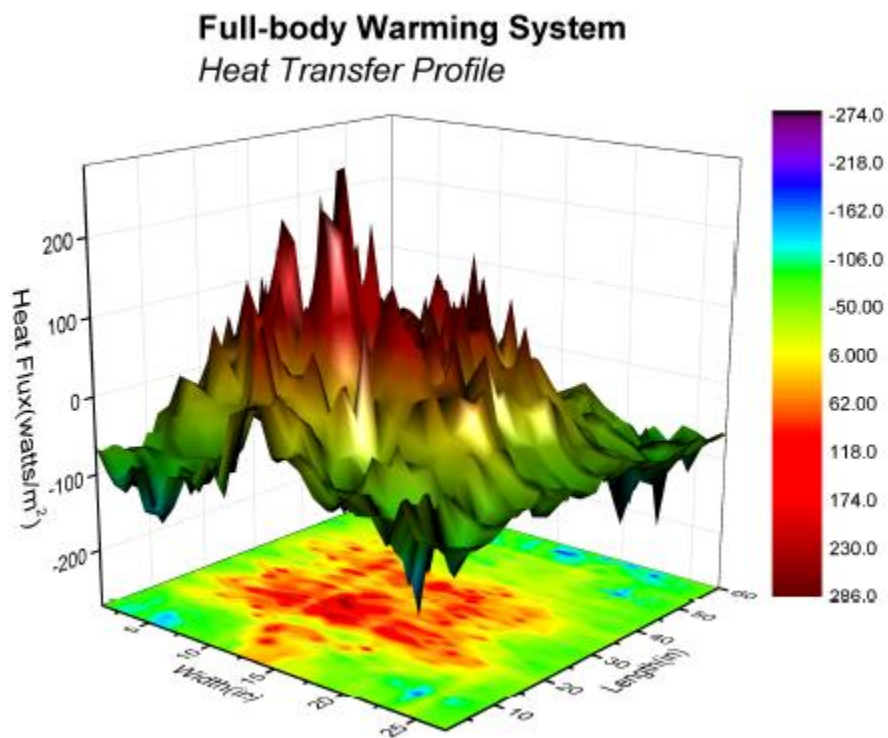

### 6.13.12 Parametric Surface with Colormap from Data

#### 6.13.12.1 Summary

This tutorial demonstrates how to create a 3D sphere using the data from three matrices. It also shows how the surface is filled to display the surface temperature contour using the data from a different matrix.

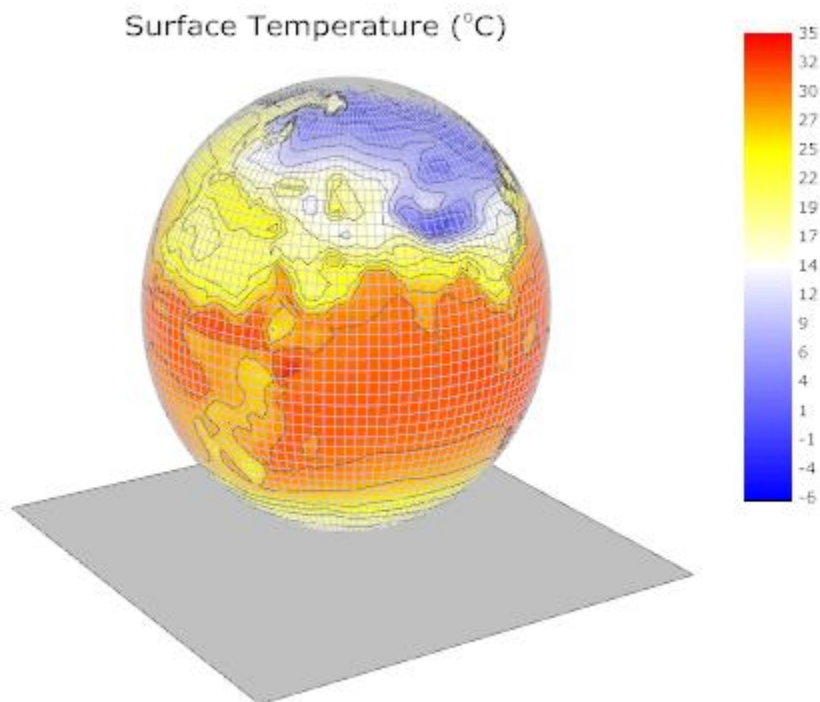

Minimum Origin Version Required: Origin 2015 SR0

#### 6.13.12.2 What you will learn

This tutorial will show you how to:

- Create a parametric surface from matrix data
- Set contour fill from another matrix
- Customize the 3D parametric surface plot

#### 6.13.12.3 Steps

This tutorial is associated with <Origin EXE Folder>\Samples\Tutorial Data.opj.

Also, you can refer to this graph in Learning Center. (Select **Help: Learning Center** menu or press **F11** key , and then open **Graph Sample: 3D Function Plots**)

1. Open **Tutorial Data.opj** and browse to the **Parametric Surface with Colormap from Data** folder in **Project Explorer** (PE).
2. Activate the matrix *FUNCA:1/4*, and highlight the data. Click the  button on the **3D and Contour Graph** toolbar to create a colormap surface as shown below. You can also create this colormap surface by selecting **Plot > 3D : 3D Colormap Surface** in the main menu.

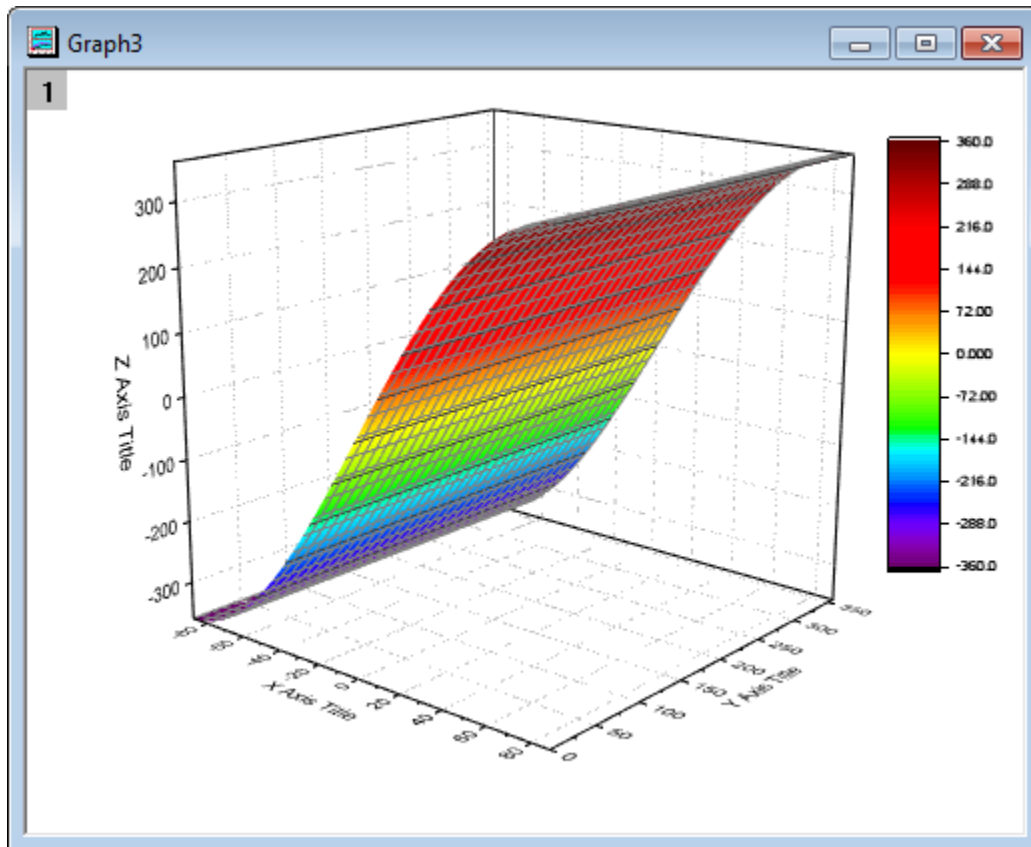

3. Double click on the plot to bring up the **Plot Details** dialog. In the **Surface** tab check the **Parametric Surface** box and set **X Matrix**, **Y Matrix** as **Mat(2)**, **Mat(3)** respectively.

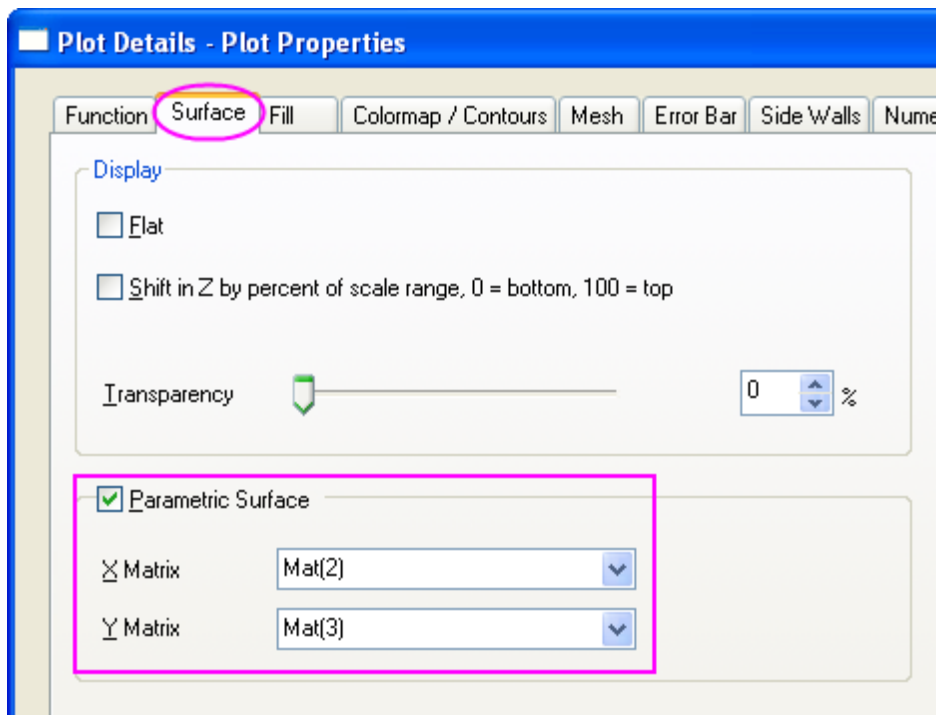



Click **OK** to close the dialog.

4. In order to display the complete colormap surface in the axes area use the rescale  button in the **Graph** toolbar. The colormap surface should appear as shown below:

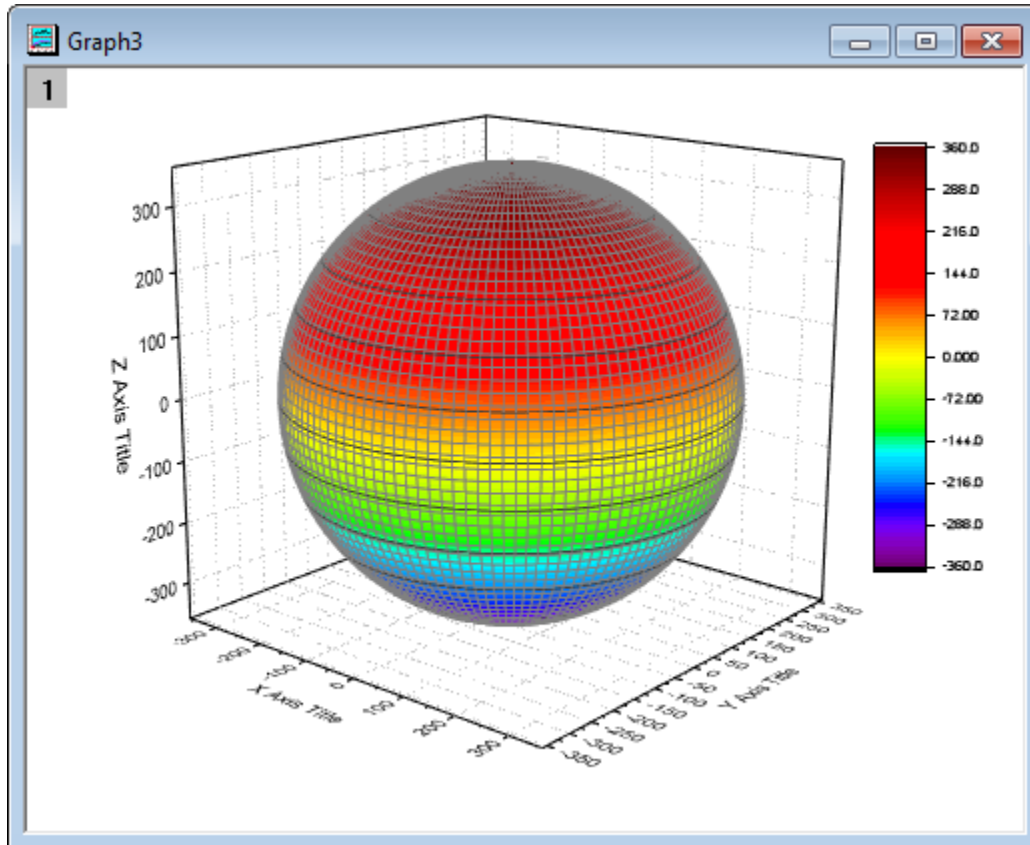

5. Double click on the plot to open **Plot Details** dialog. This dialog box is used to customize the surface. In the **Fill** tab Front Surface section deselect the box before **Self** and set **Contour fill from matrix** as **Mat(4)**. Click **Apply**.



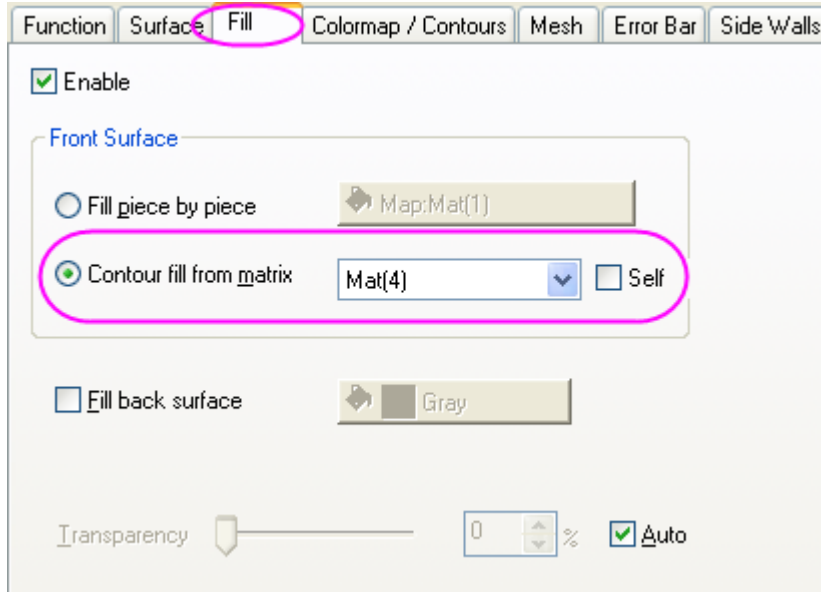

6. Activate the **Colormap / Contours** tab. Click the **Level** heading to open the **Set Levels** dialog. Click **Find Min/Max** and set **Major Levels**, **Minor Levels** as **16**, **8** respectively. Click **OK**.

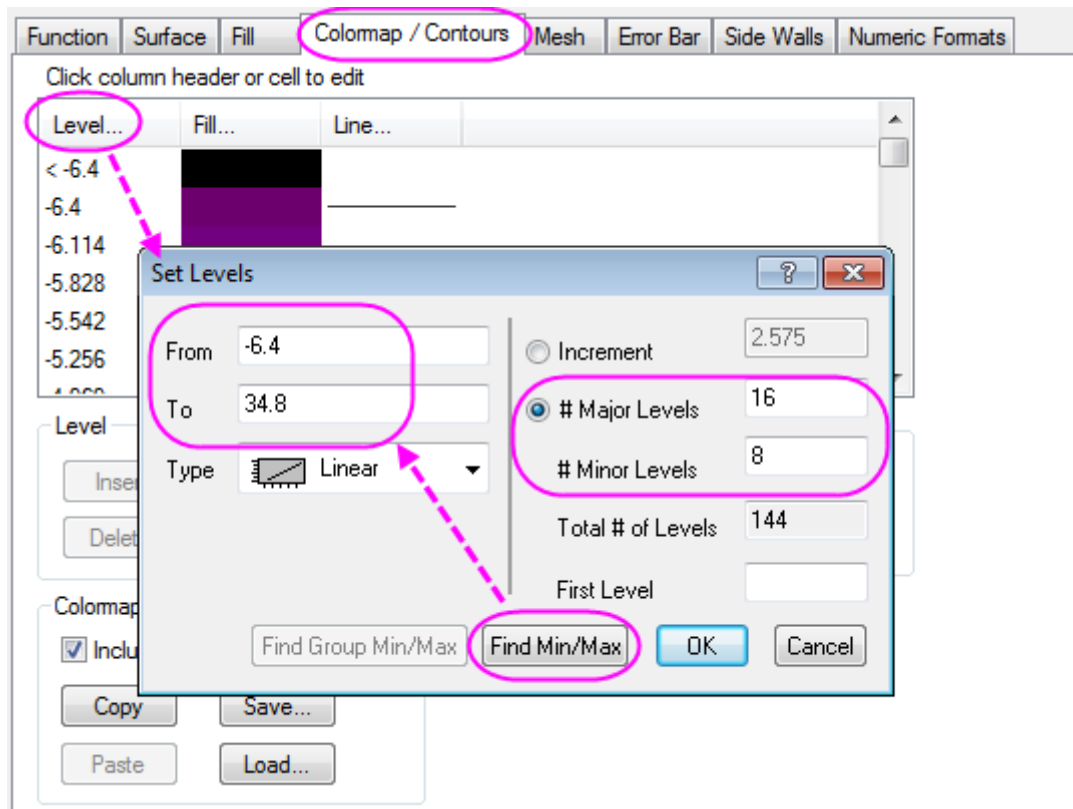

7. Click **Fill** to open the **Fill** dialog. This dialog is used to customize the color scale. The **Load Palette** option allows the user to select from a list of possible palettes. Set **Load Palette** as **Temperature**. Click **OK**.

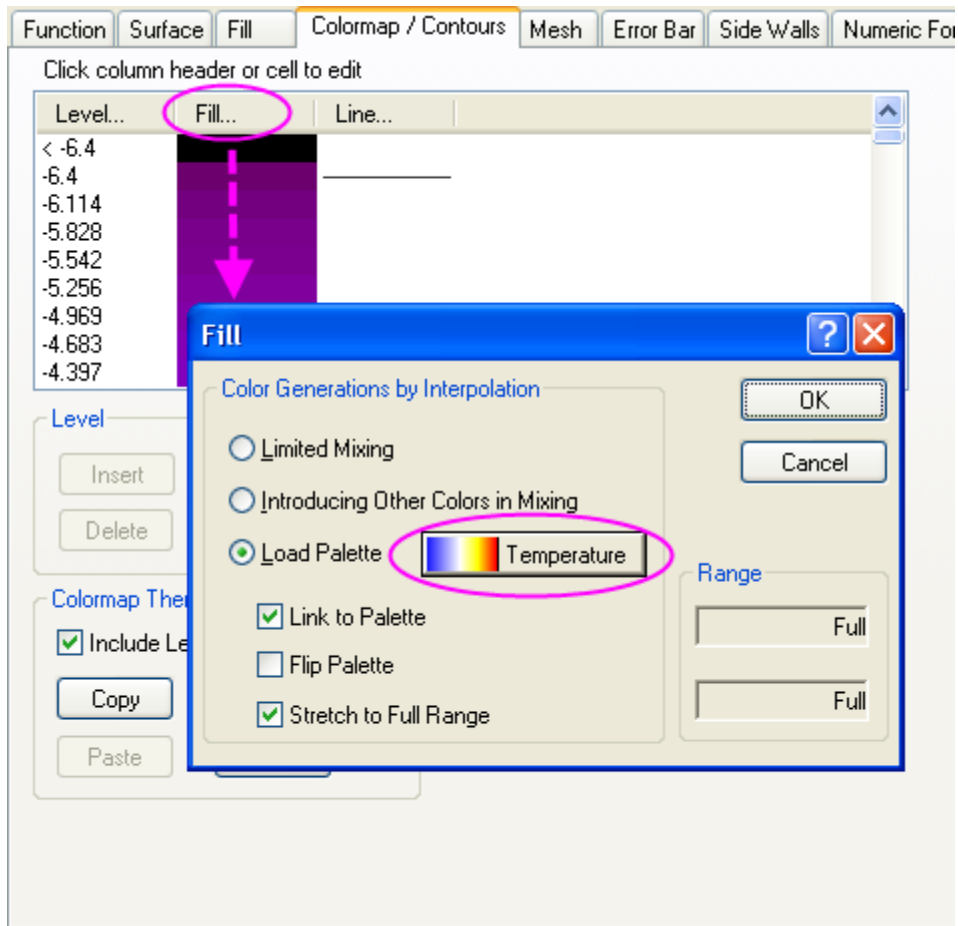

8. Click on the **Mesh** tab. Set **Line Width** as **0.05** by clicking on the font box and typing the value instead of using the drop down menu. Set **Line Color** in the Front section as **LT Gray**. Click **Apply**.

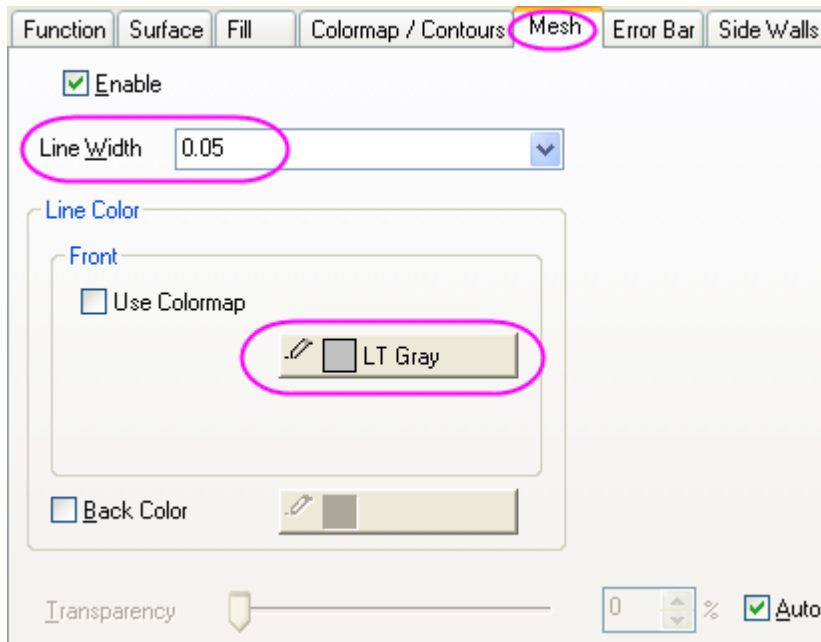

9. In the **Numeric Formats** tab choose the **Decimal Places** radio button and set its value as **0**.

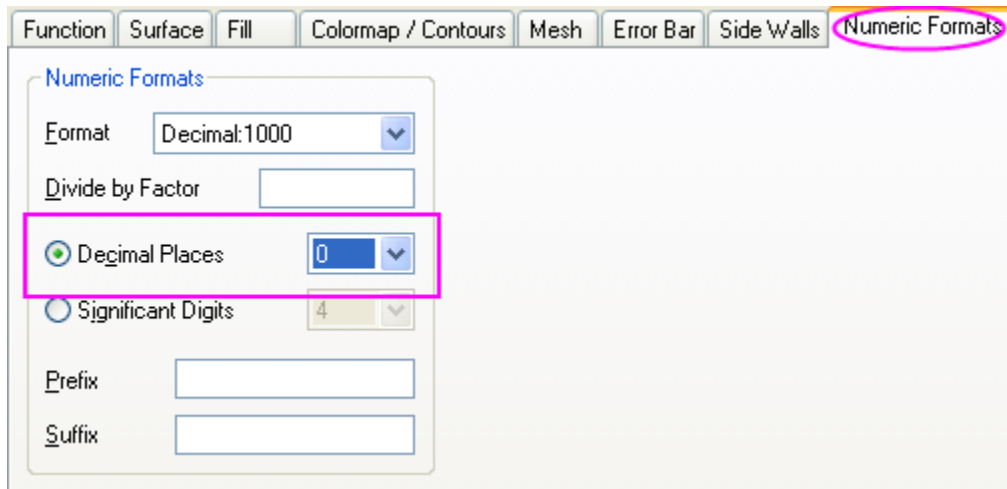

Click **OK** to apply the settings and close the **Plot Details** dialog. The graph should appear as shown below:

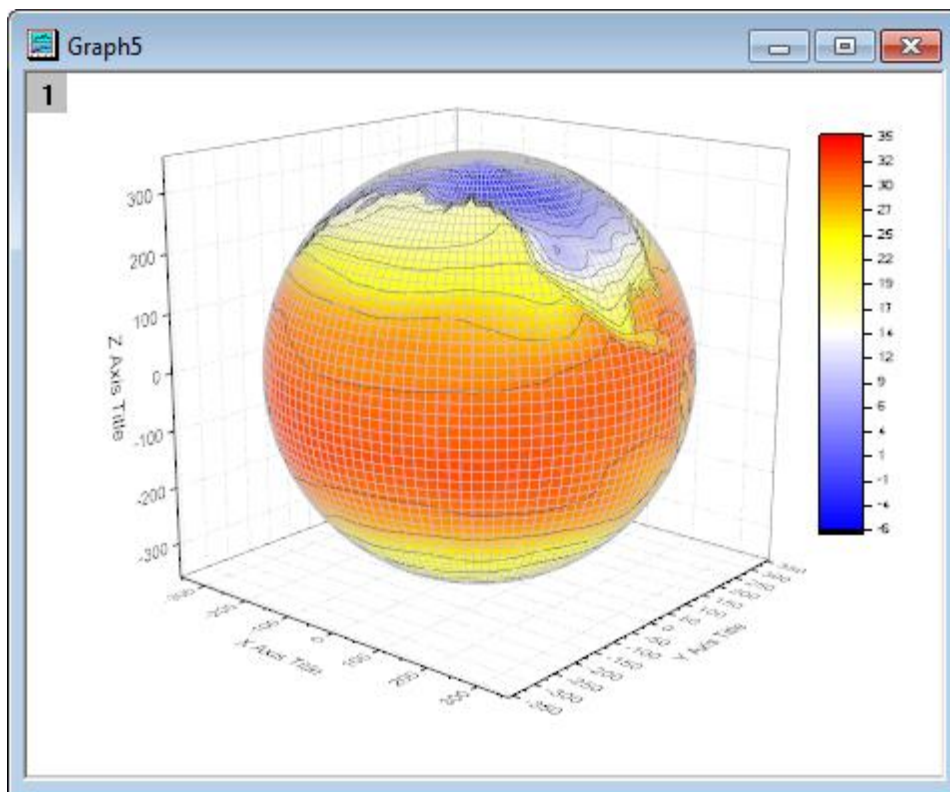

10. The next step is to modify the axes. Double click on the Z axis to open the **Axis** Dialog. Go to the **Scale** tab, select **Z** icon. Set the value of **From** and **To** as **-400** and **400** respectively.

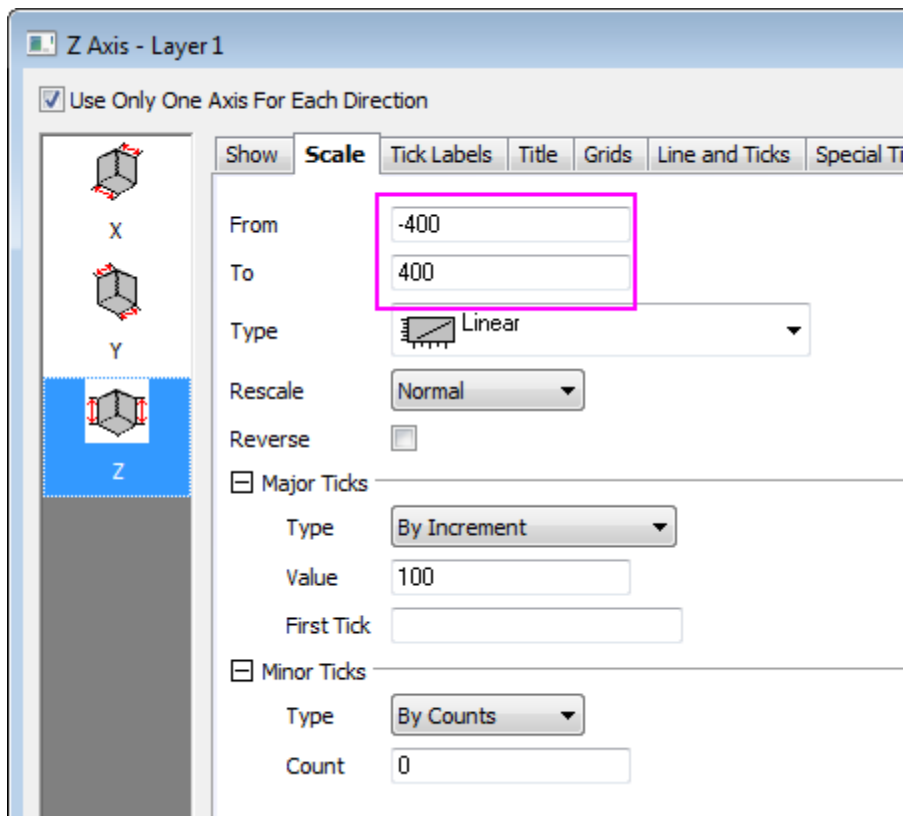

- Go to the **Title** tab, hold **Ctrl** key and click to select **X**, **Y** and **Z** together. Deselect the **Show** checkbox to hide the axis title for all axes and click **OK** to close the dialog.

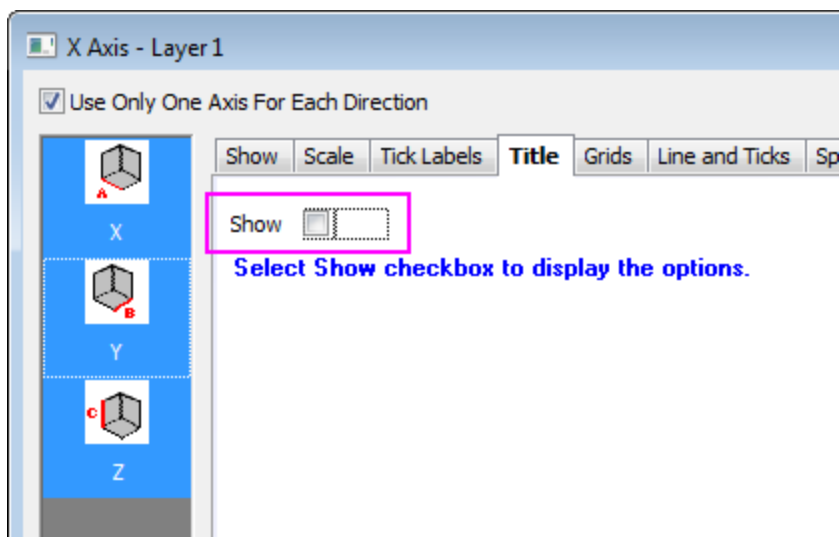

- Double click on the XY Plane to open **Plot Details - Layer Properties**. In order to hide the axes, in the **Display** tab, deselect the **X Axes**, **Y Axes**, **Z Axes** boxes under the Show Elements section.

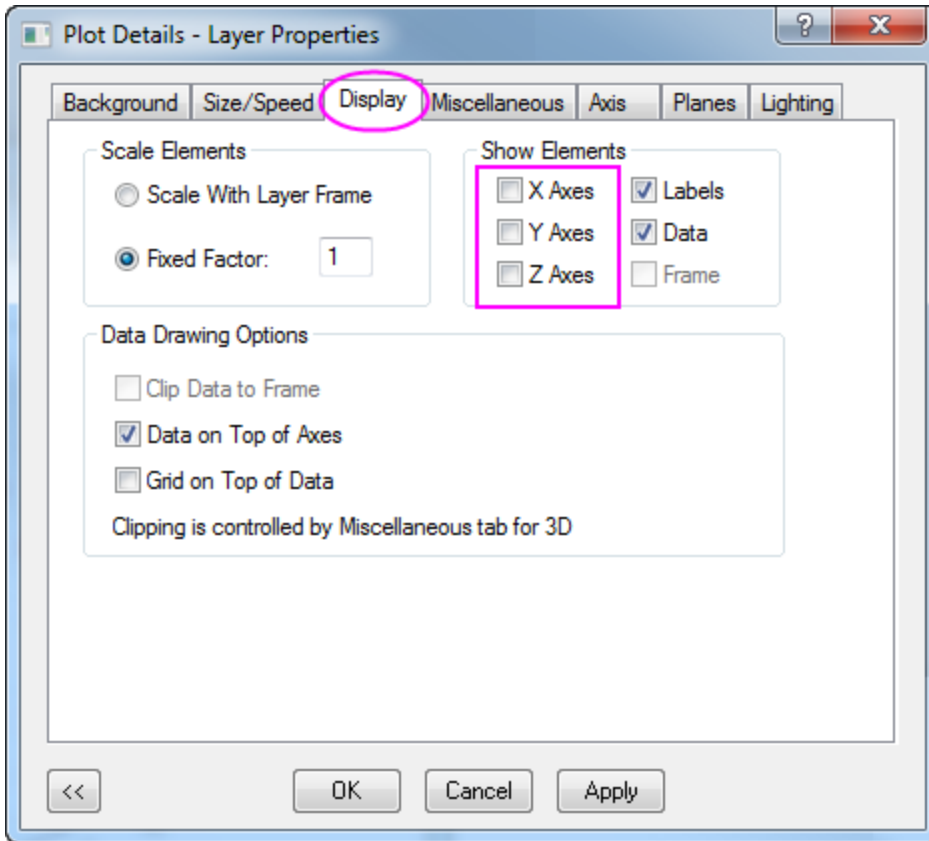

13. To hide the YZ and ZX planes, click on the **Planes** tab, and deselect the boxes before **YZ, ZX**. Set the **Color** of the remaining **XY** plane as **LT Gray**. Click **OK** to close the dialog.

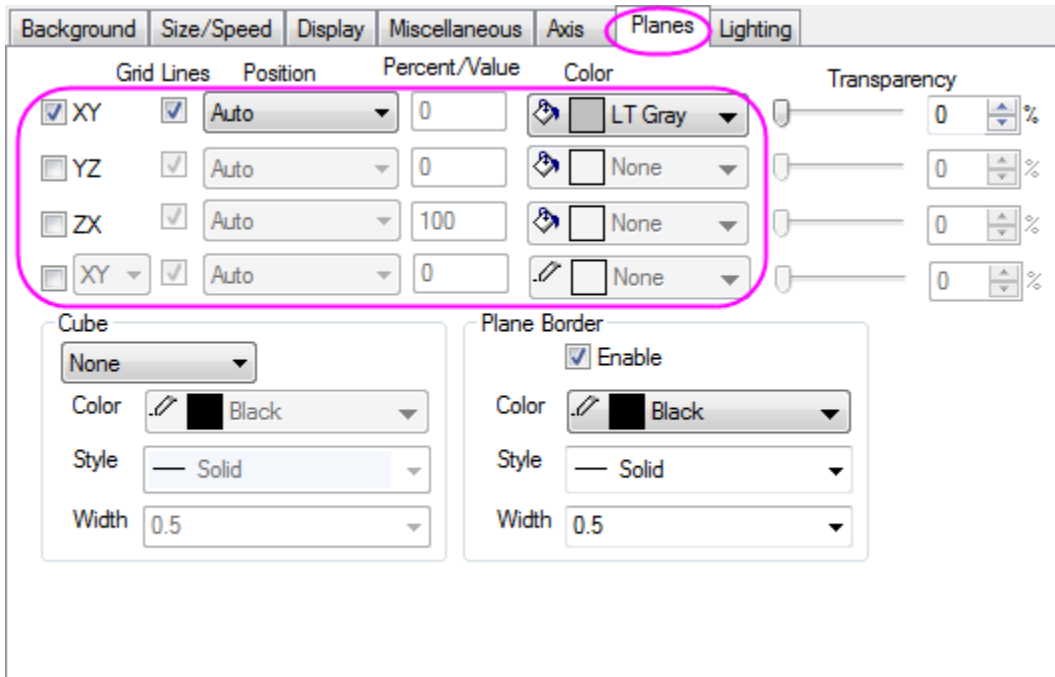

- The next step is to customize the color scale. Double click on it to open the **Color Scale Control** dialog, go to the **Labels** node and set the Font as **Verdana**.

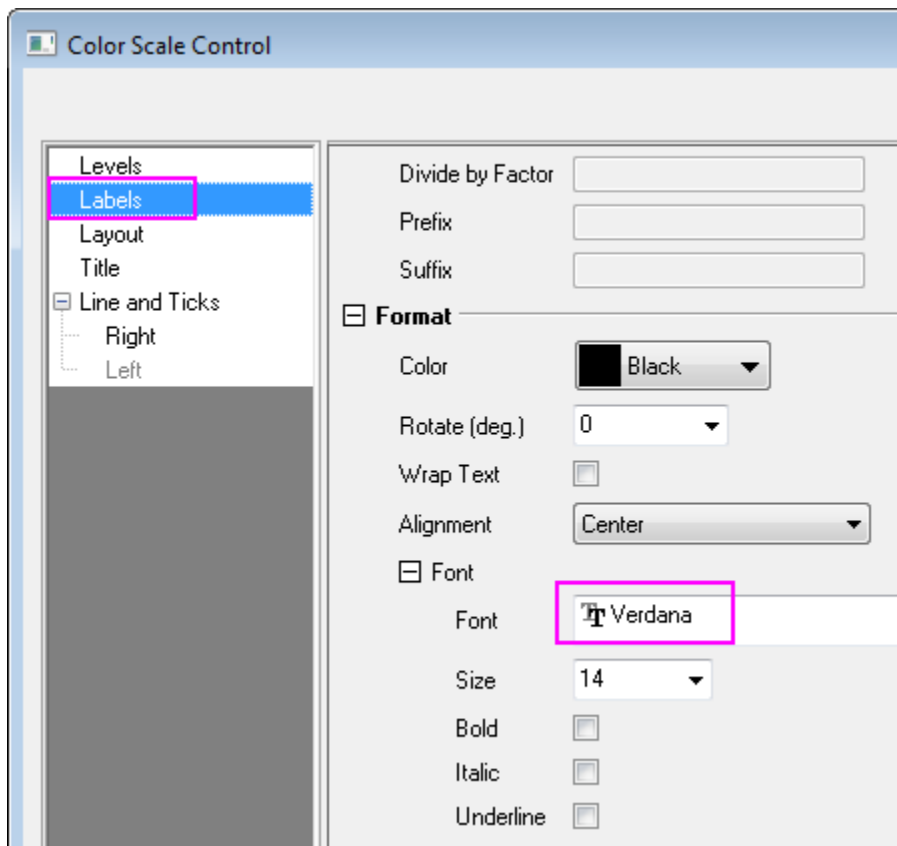

- Go to the **Line and Ticks** node and hide the border and ticks:

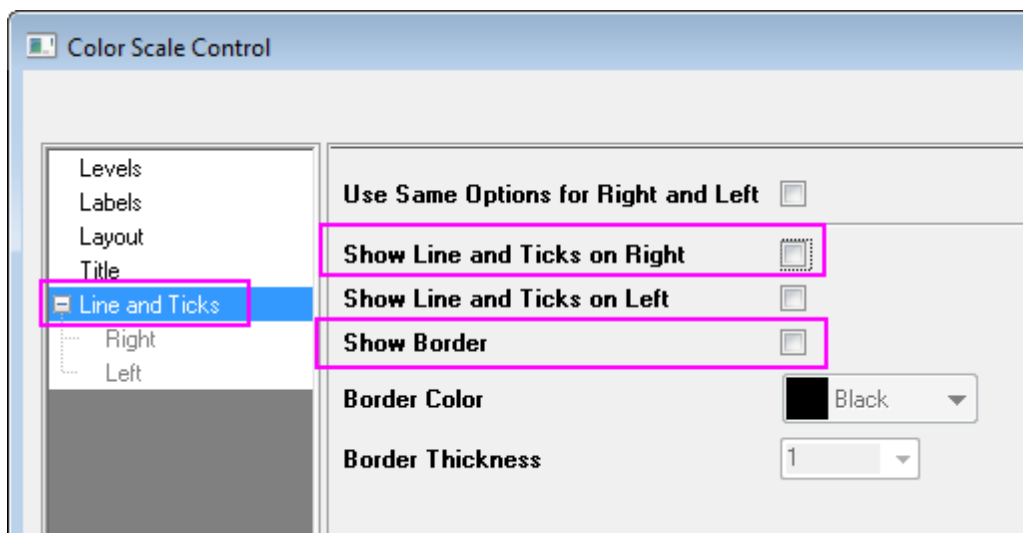

- Click **OK** to apply the setting and close the dialog. Select and drag to move the color scale object to the desired location.

17. Right click on the white area of the graph layer to bring up a context menu and choose **Add/Modify Layer Title**. Click elsewhere to deselect the text box, then right-click on it and select **Properties...** from the shortcut menu to open the **Object Properties** dialog. Set the font as **Verdana** and type **Surface Temperature (\\+(o)C)** in the content table. Click **OK**.

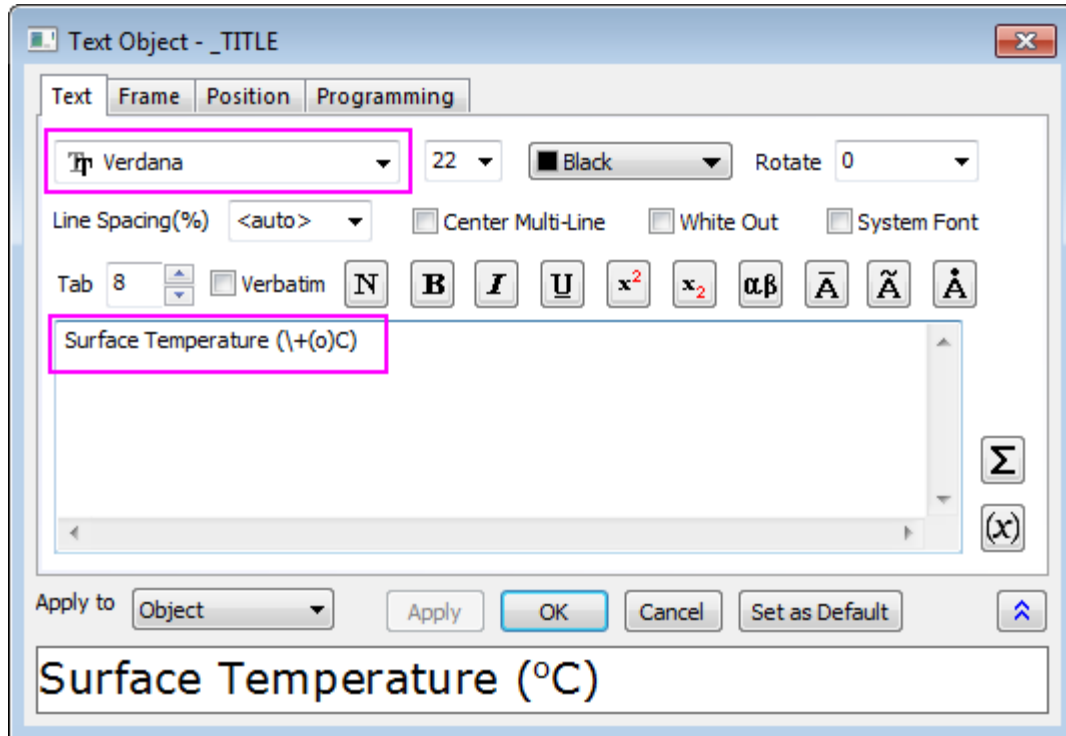

18. Click on the graph layer within the 3D frame (not the data plot), and click the **Rotate** button as shown in the image below, to activate the rotation mode. Other ways to rotate the 3D plot include using the red rotate button in the **Tools** toolbar, the various buttons in the **3D Rotation** toolbar or by selecting in the plot, pressing the **R** key and using the cursor.

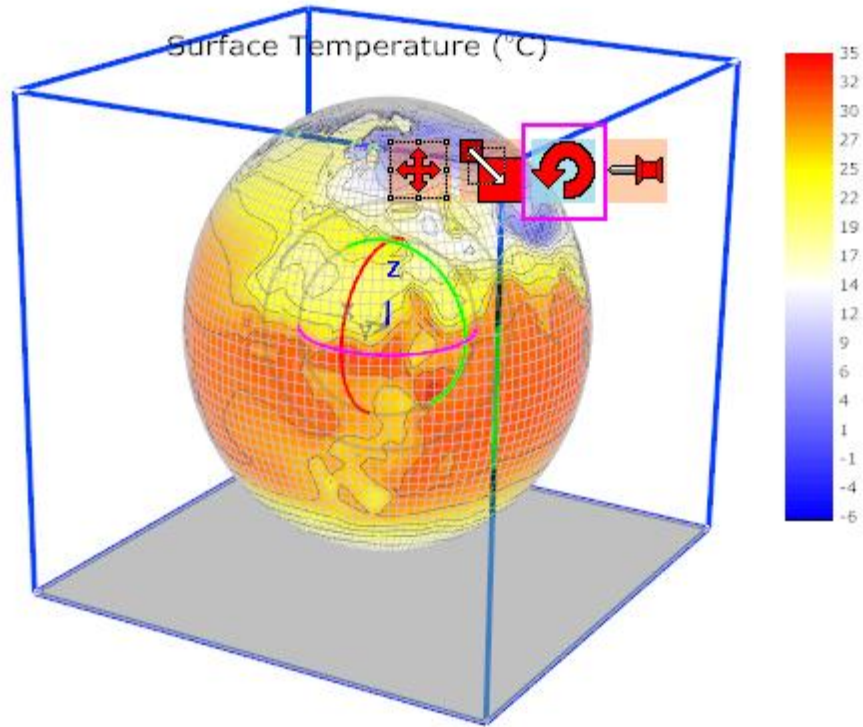

Rotate the plot to get a better view. The graph should resemble the image shown below:

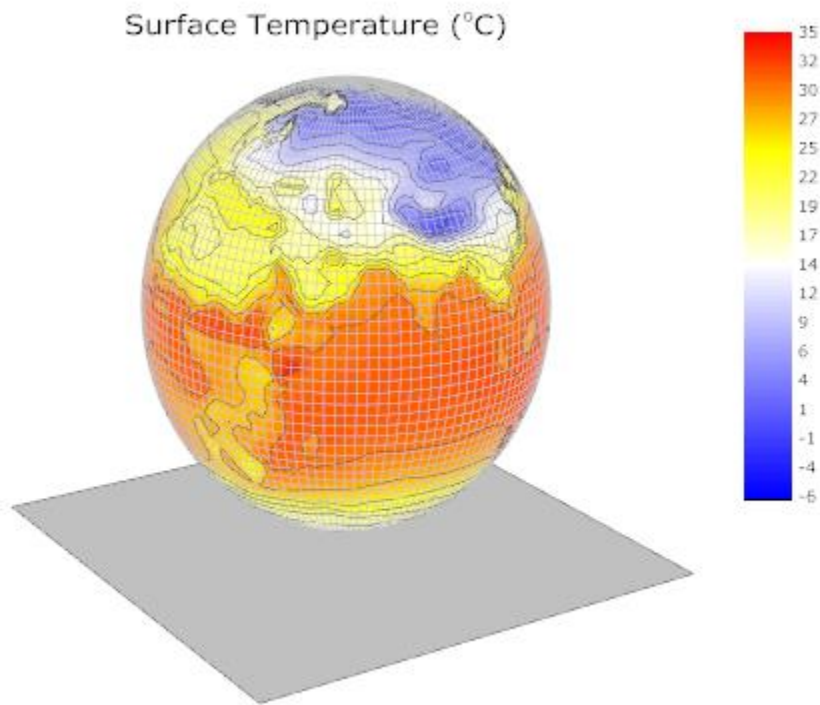

### 6.13.13 Stacked 3D Surface Plots



### 6.13.13.1 Summary

This tutorial shows how to create stacked 3D colormap surfaces from different matrix objects. The surfaces in the plot display the topology before and after volcanic eruption:

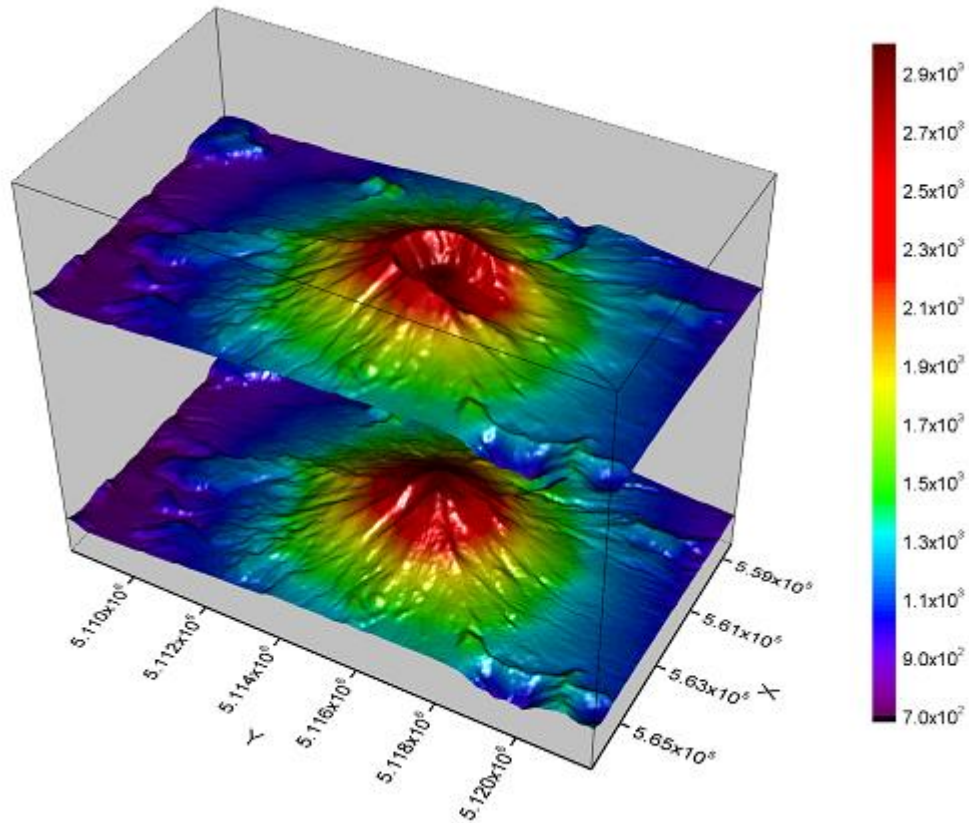

Minimum Origin Version Required: Origin 2015 SR0

### 6.13.13.2 What you will learn

This tutorial will show you how to:

- Create stacked 3D colormap surfaces.
- Customize axes display and layer properties.
- Resize and rotate a 3D plot.

### 6.13.13.3 Steps

#### 6.13.13.3.1 Create Multiple Colormap Surfaces

This tutorial is associated with <Origin EXE Folder>\Samples\Tutorial Data.opj.

Also, you can refer to this graph in Learning Center. (Select **Help: Learning Center** menu or press **F11** key , and then open **Graph Sample: 3D Surface**)

1. Open **Tutorial Data.opj** and browse to the **Stacked 3D Surface Plots** folder in **Project Explorer** (PE).

2. Activate the matrix book **Mbook1** which contains two matrix objects, then click **Plot > 3D : Multiple Colormap Surfaces** to create two 3D surfaces from these two matrix objects as shown below:

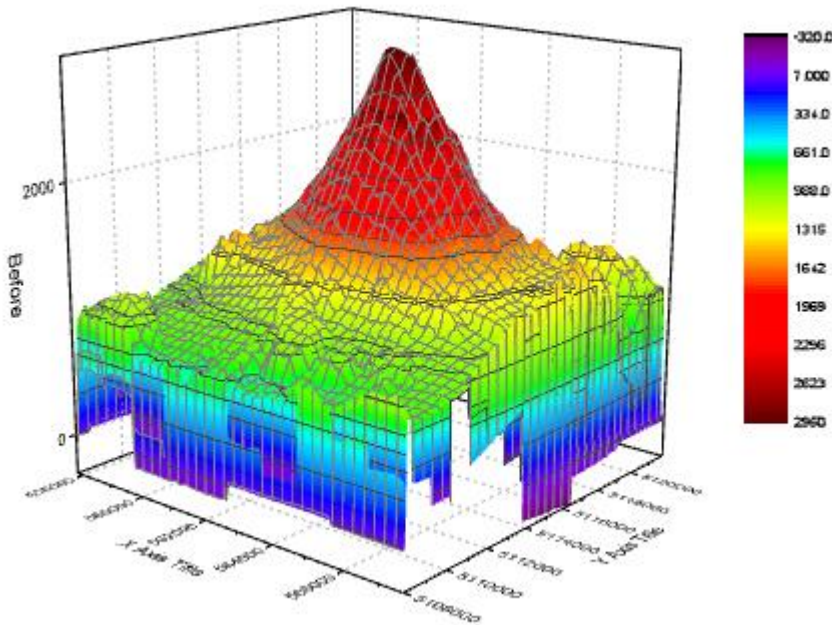

3. Double click on the plot to open the **Plot Details** dialog. If the left panel is not open the use the arrow button on the bottom left of the dialogue. There are two surfaces under the **Layer1** node on the left panel. To shift the "After eruption" surface in Z axis, activate the second plot under **Layer1** on the left panel, and in the right panel, select the **Surface** tab. Check the **Shift in Z by percent of scale range** box, and enter **70** in the text box.

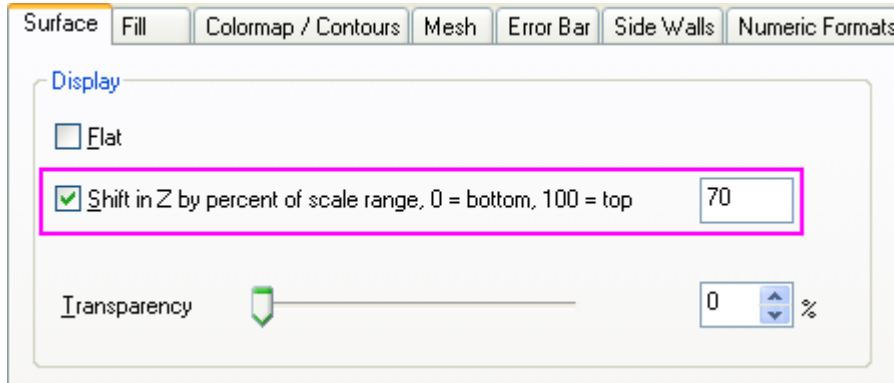

4. In the **Fill** tab Front Surface section, deselect the **Self** box to fill contour by the same matrix object (Mat "Before") as the other surface used.

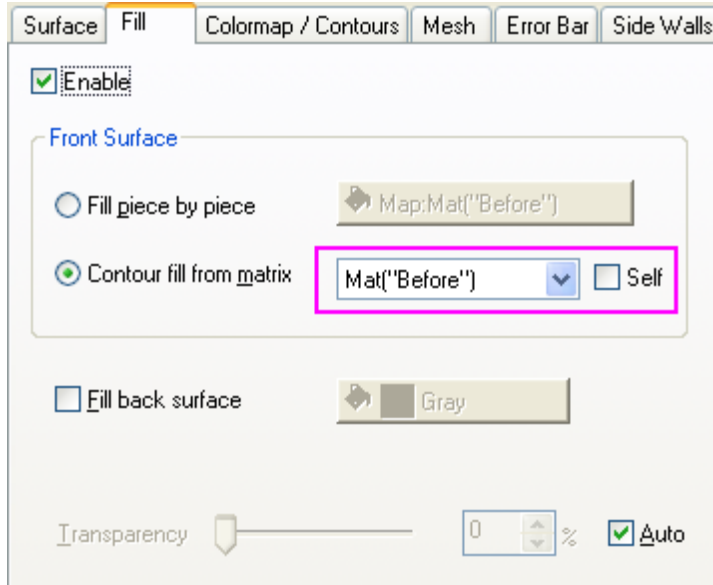

5. Select the **Colormap / Contours** tab. Click **Level..** to bring up the **Set Levels** dialog. Set the parameters as shown in the following graph and click **OK**.

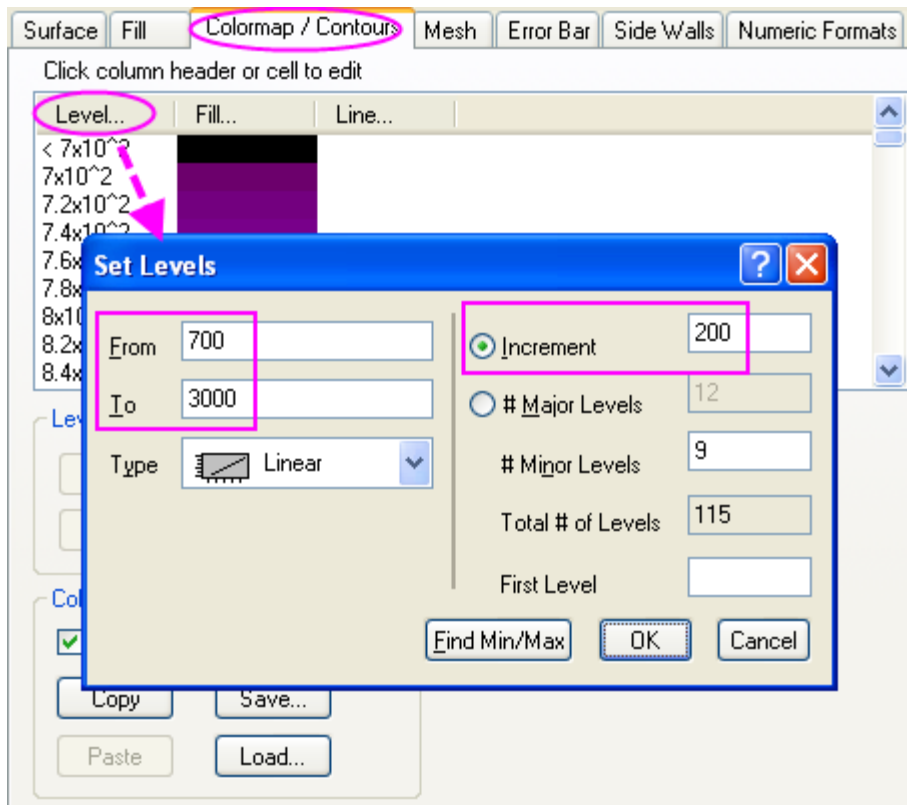

Then uncheck the **Enable Contours** checkbox to hide the contour lines. Click **OK**.

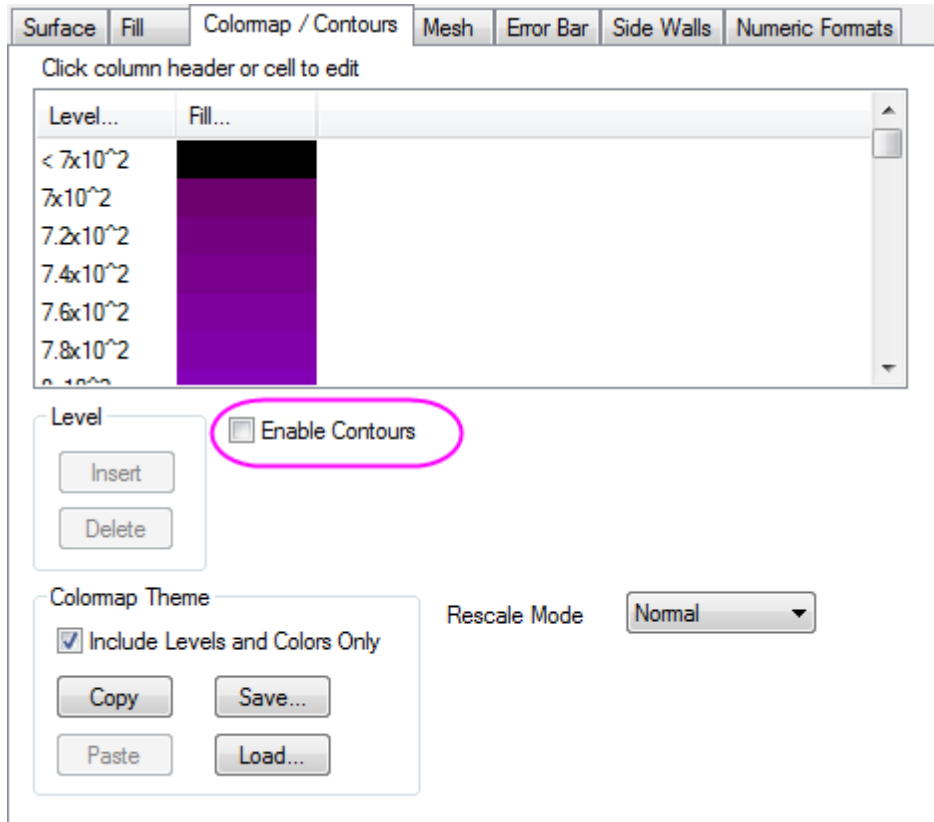

6. In the **Mesh** tab deselect the **Enable** box to disable the mesh line.
7. Repeat steps 5 to 6 for the first plot under the **Layer1** node.
8. In this project the two surfaces use the same matrix as contour fill, so they can share one color scale.

To set the numeric format of the color scale, activate the first plot on the left panel of the **Plot Details** dialog. Select the **Numeric Formats** tab on the right panel. Select **Scientific:  $10^3$**  from the drop down list next to the **Format**, and set **Significant Digits** as **2**. Click **OK**.

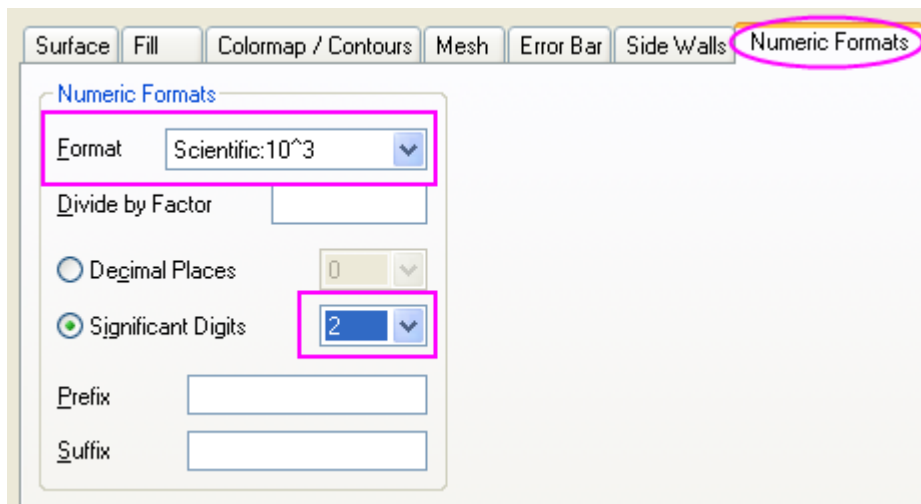

To customize the color scale, double click on the color scale to open the **Color Scale Control** dialog. Check the **Reverse Order** box and set **Color bar thickness** as **100**. Click **OK**.

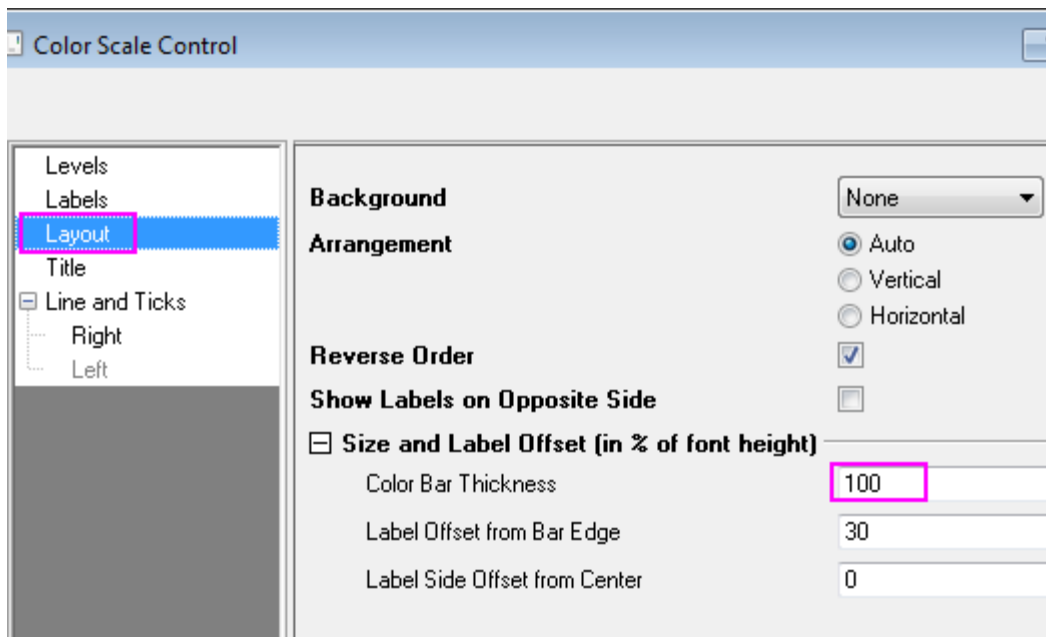

#### 6.13.13.3.2 Customize Axes Display

The next step is to change the the axes scale and tick labels' format in the **Axes** dialog. To open this dialog, select **Format: Axes: X Axis...**

1. Change the settings on the **Scale** tab:
  - Set scale from **558000** to **566500** for the X Axis (click **X** icon), from **5108200** to **5121800** for the Y Axis (click **Y** icon), and from **0** to **10000** for the Z axis (click **Z** icon).
  - For the X axis, set **Type of Major Ticks** as **By Counts** and set **Count** as **5**. For the Y and Z axis, set **Type of Major Ticks** as **By Increment** and set **Value** as **2000**. To hide all the minor ticks, set **Count of Minor Ticks** as **0** for all axes.
2. Customize the **Tick labels**:
  - First, ensure that the **Use Only One Axis for For Each Direction** is enabled in the top of the **Axis** dialog.
  - Go to the **Tick Labels** tab, hold **Ctrl** key to select **X**, **Y** and **Z** icons together so they will be customized together. Select **Custom** for **Display** and select **P\*3** from the drop down list of **Custom Format** to show the tick label as base-10 scientific notation with 3 significant digits. Click **OK**. For more information about the options in this drop down list, please refer to [Custom Display Format](#).

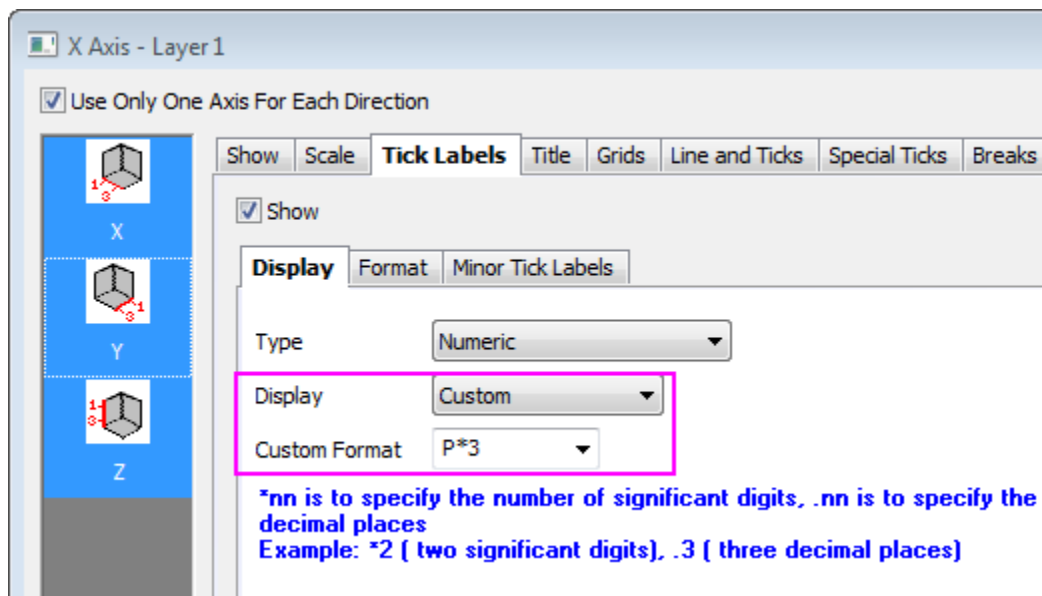

### 6.13.13.3.3 Customize Layer Properties

1. Double click on the blank space outside the plots or click **Format: Layer...** from the menu to open the **Plot Details - Layer Properties** dialog.
2. Activate the **Miscellaneous** tab on the right panel. Check the box before **Enable** in the **Clipping** section, which will clip the image outside the axes area according to the settings in the **Clipping** section.

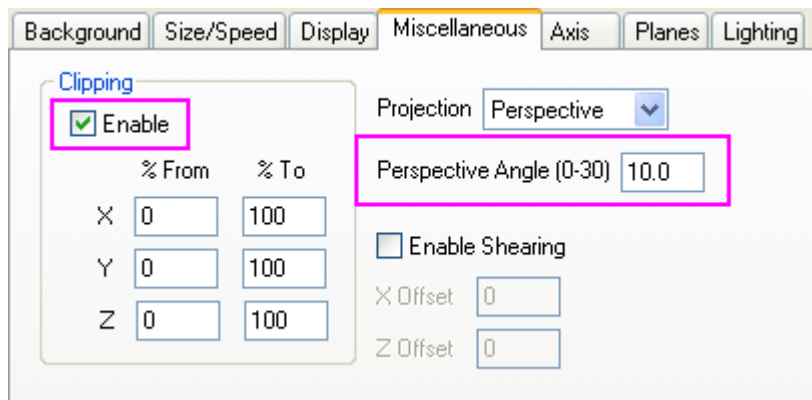

3. In the **Planes** tab set **Color** as **LT Gray** for all planes. Select **Front Corner** from the drop-down list in the **Cube** section to show the cube's border.

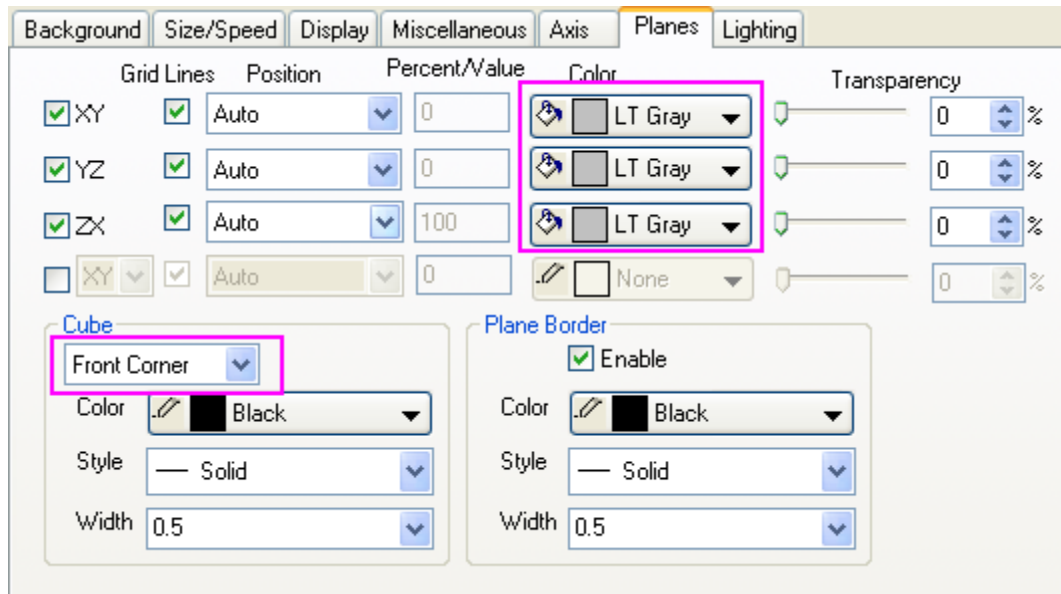

4. Select the **Lighting** tab. In the **Mode** section, choose **Directional** to enable lighting mode. Set **Light Color** as shown in the following graph. Click **OK**.

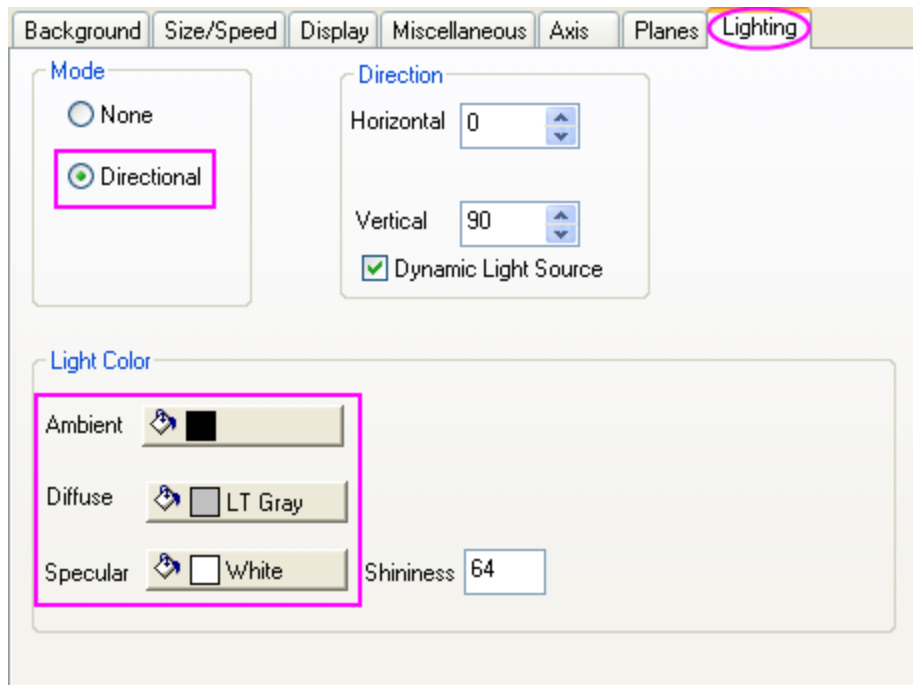

#### 6.13.13.3.4 Resize and rotate the plot

1. Click on the cube (not the data plot) to activate the 3D toolbar. Click the Resize button , a 3D Cartesian coordinate will show up. Place the cursor on Y axis, which will then be highlighted, at this moment drag-and drop the Y axis to stretch the plot in Y axis direction. Do the same to X direction and Z direction.



- Click the rotate button to activate rotation mode. A sphere will be displayed at the center of the plot. Rotate the plot to get a better view.

The 3D toolbar allows you to resize and rotate the plot freely. However, you can also achieve the same view as Graph1 in this sample project by setting the value in the **Axis** tab of the **Layer Properties** dialog as shown in the following graph.

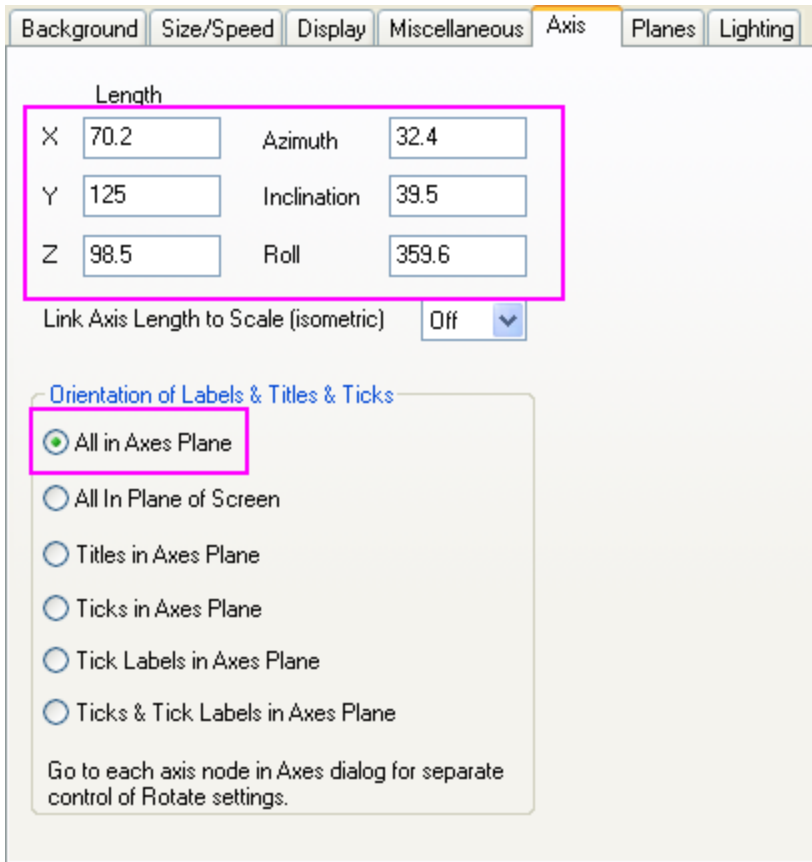

## 6.13.14 Multiple Surfaces in Same Layer

### 6.13.14.1 Summary

The four stacked surfaces shown below were created from the same matrix. The first layer from the top is a wire frame, the second layer is a flattened contour line plot, the third layer is a color filled surface with lighting effect, and the bottom layer is a flattened color filled contour plot.



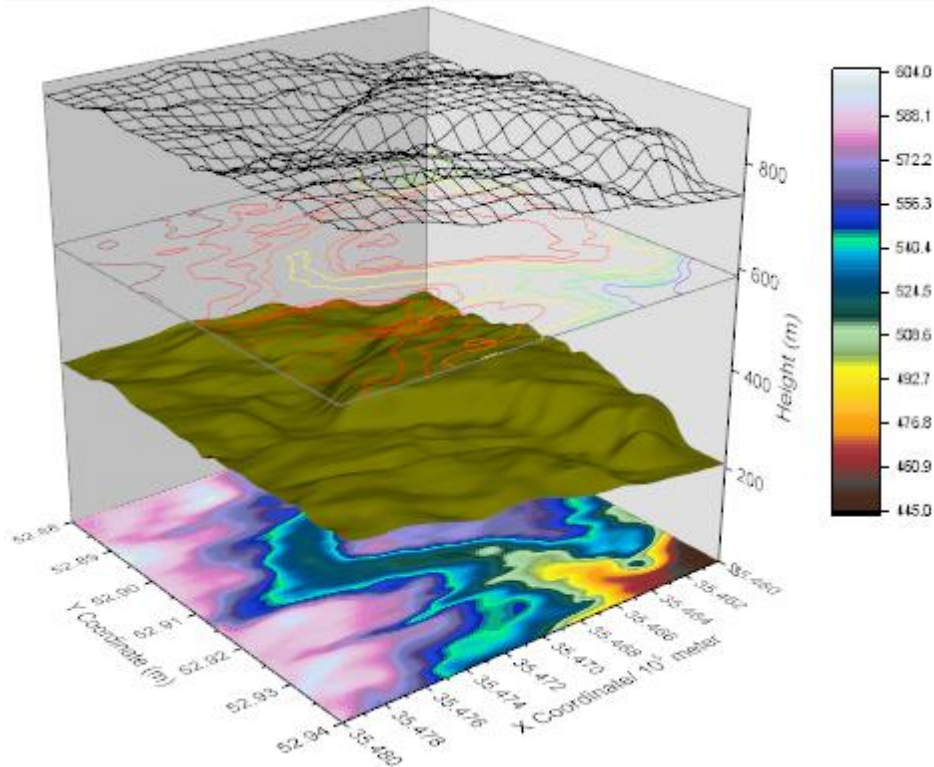

Minimum Origin Version Required: Origin 2015 SR0

#### 6.13.14.2 What You Will Learn

This tutorial will show you how to:

- Add multiple surface plots to a single graph layer
- Explore ways in which you can customize surface plots

#### 6.13.14.3 Steps

##### 6.13.14.3.1 Create a Graph with Multiple Surfaces

This tutorial is associated with <Origin EXE Folder>\Samples\Tutorial Data.opj.

Also, you can refer to this graph in Learning Center. (Select **Help: Learning Center** menu or press **F11** key , and then open **Graph Sample: 3D Surface**)

1. Open **Tutorial Data.opj** and browse to the **Multiple Surfaces in Same Layer** folder in **Project Explorer (PE)**.
2. Select the **MBook8** worksheet and highlight all that data. From the Main Menu select **Plot > 3D : 3D Colormap Surface**. The graph window should appear as shown below:

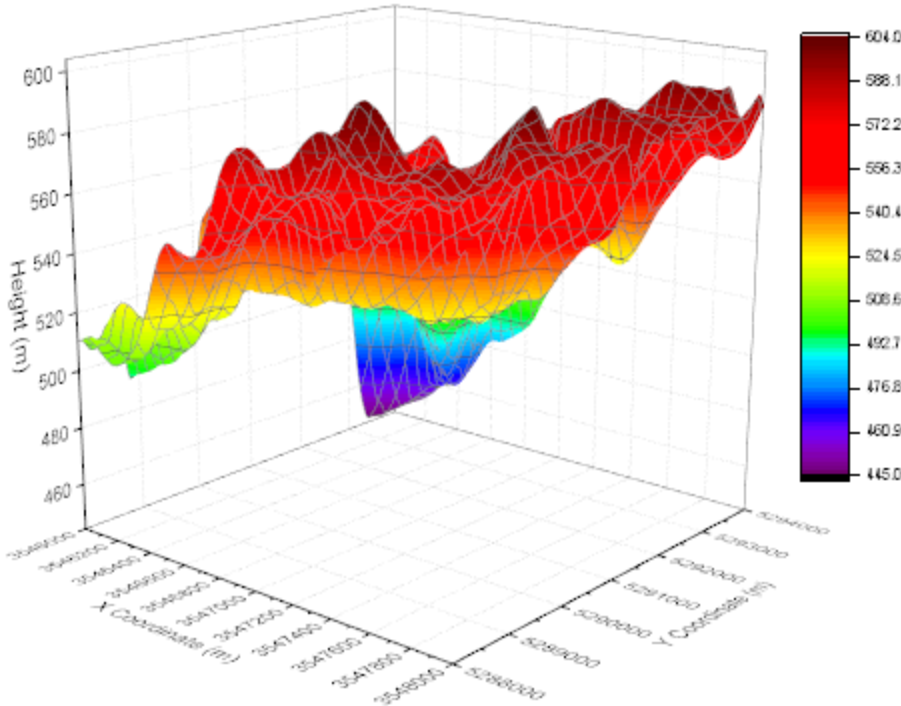

- With the new graph window active choose **Graph: Layer Contents....** In the **Layer Contents - Layer 1** dialog box, select the **MBook8** matrix in the left panel and click the Add plot button (the right-pointing arrow in the center of the dialog) three times. Click **OK**. This will add the same MBook8 data to the graph layer four times. Note that at this point there only a single plot, the following steps will change that.

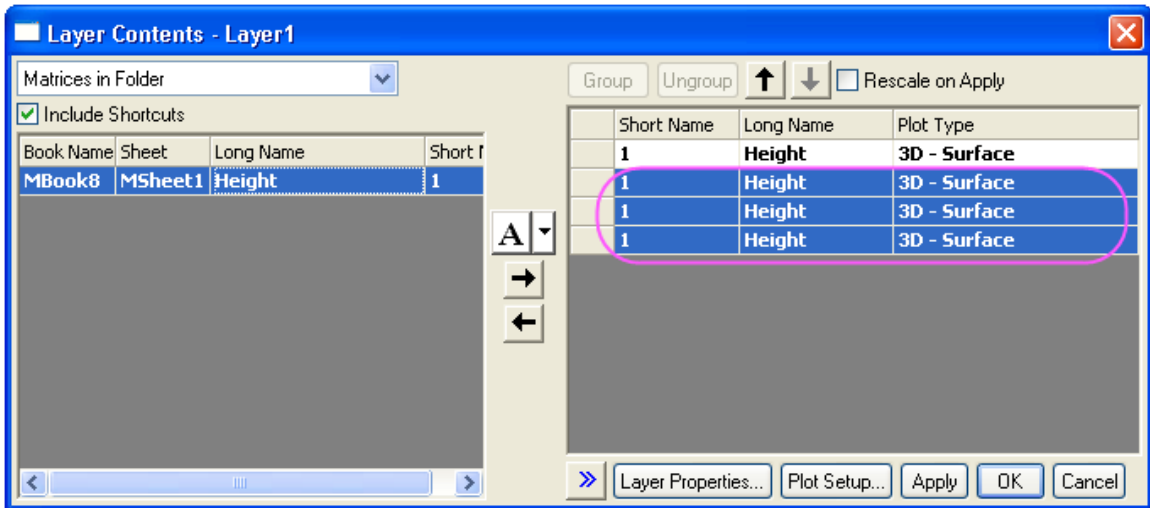

- Double-click on the plot to open the **Plot Details - Plot Properties** dialog box. Select the first plot in the left-hand panel and in the **Surface** tab check the **Flat** box, check **Shift in Z by percent...** and enter **0** in the accompanying text box. Select the second plot, leave **Flat** unchecked, check **Shift in**

**Z...** and enter **23**. Select the third plot, check **Flat**, check **Shift in Z...** enter **65**. Select the fourth plot, leave **Flat** unchecked, check **Shift in Z...** and enter **82**. Click **OK**.

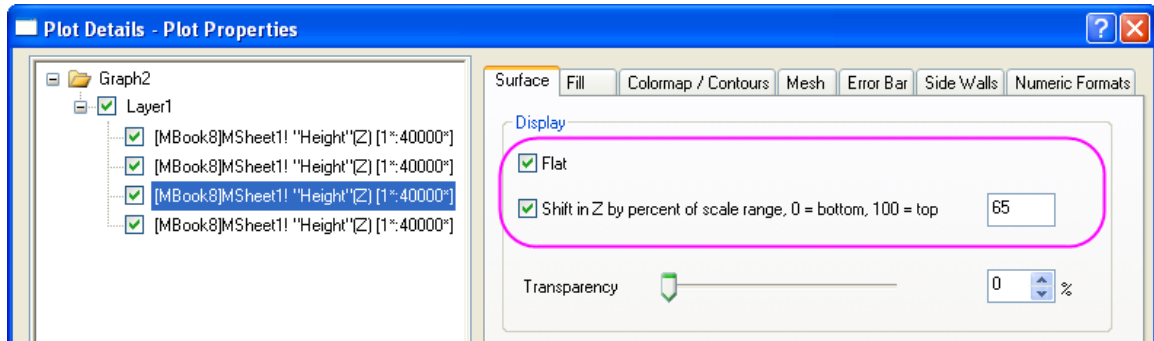

- Double-click on the Z axis, and in the **Axes Dialog** box, go to the **Scale** tab, make sure **Z** axis icon is selected and set **From** to **0**, and **To** to **900**.

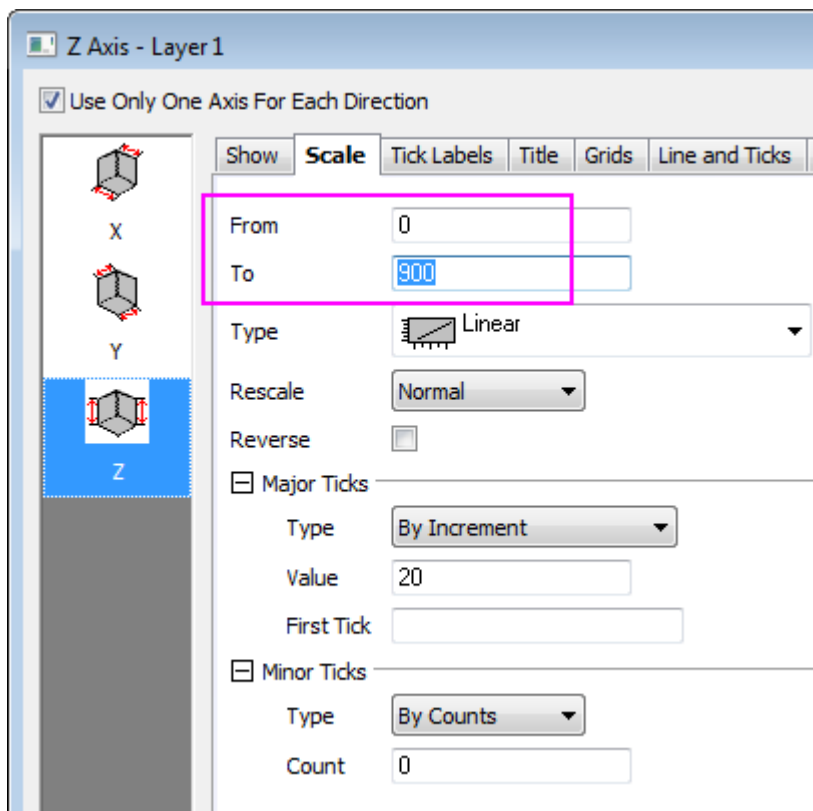

- Go to the **Tick Labels** tab, hold **Ctrl** key to select **X** and **Y** icons together. In the **Display** tab, for **Divide by Factor**, enter **100000**.

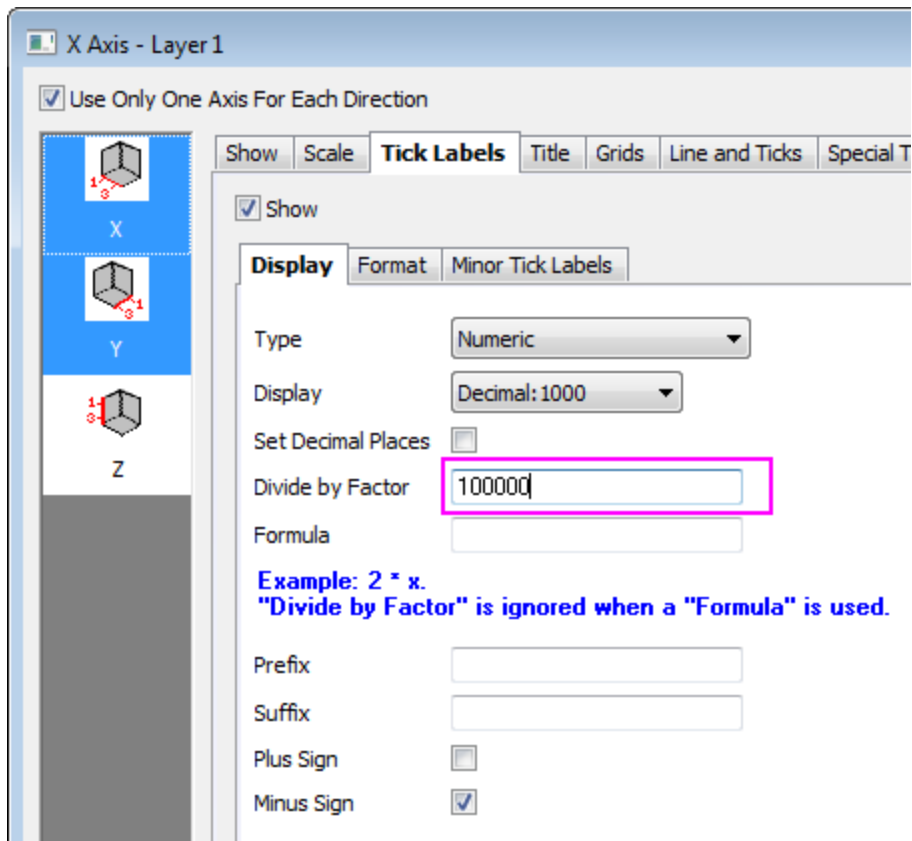

7. Go to the **Title** tab, select the **X** icon and enter **X Coordinate/ 10\+(5) meter** as the text for X title. Select the **Y** icon and enter **Y Coordinate/ 10\+(5) meter** as title text.

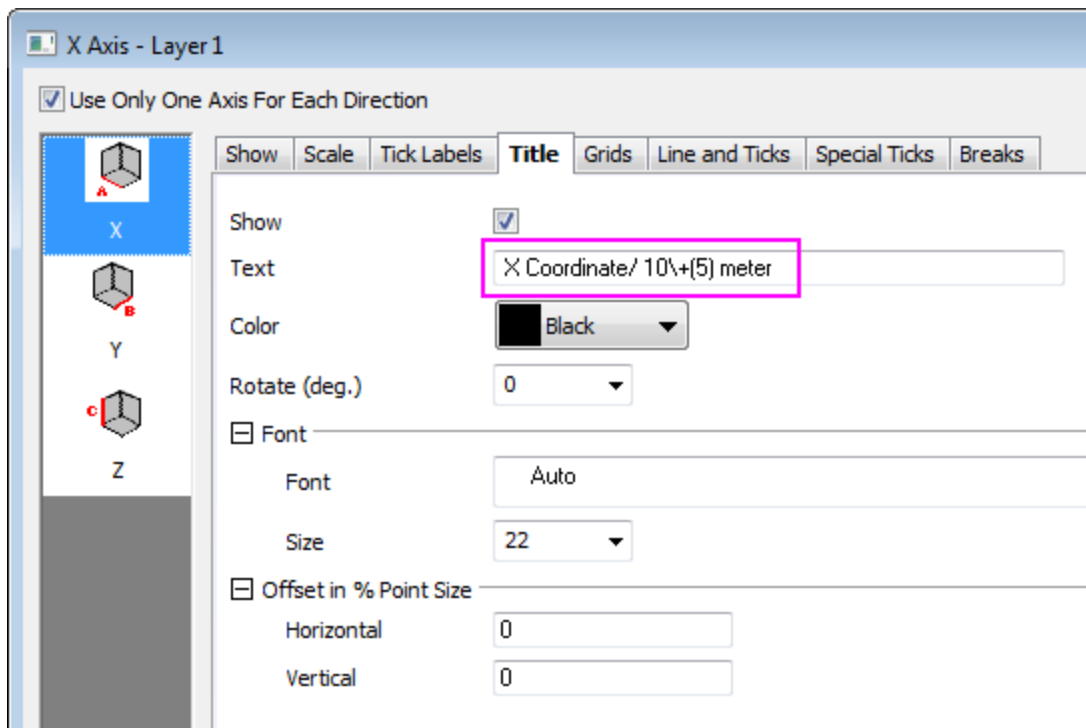

- Go to the **Grids** tab, hold **Ctrl** key to select **X**, **Y** and **Z** icons together. Under **Major Grid Lines** clear the **Show** check box to hide the grid lines for all axes.

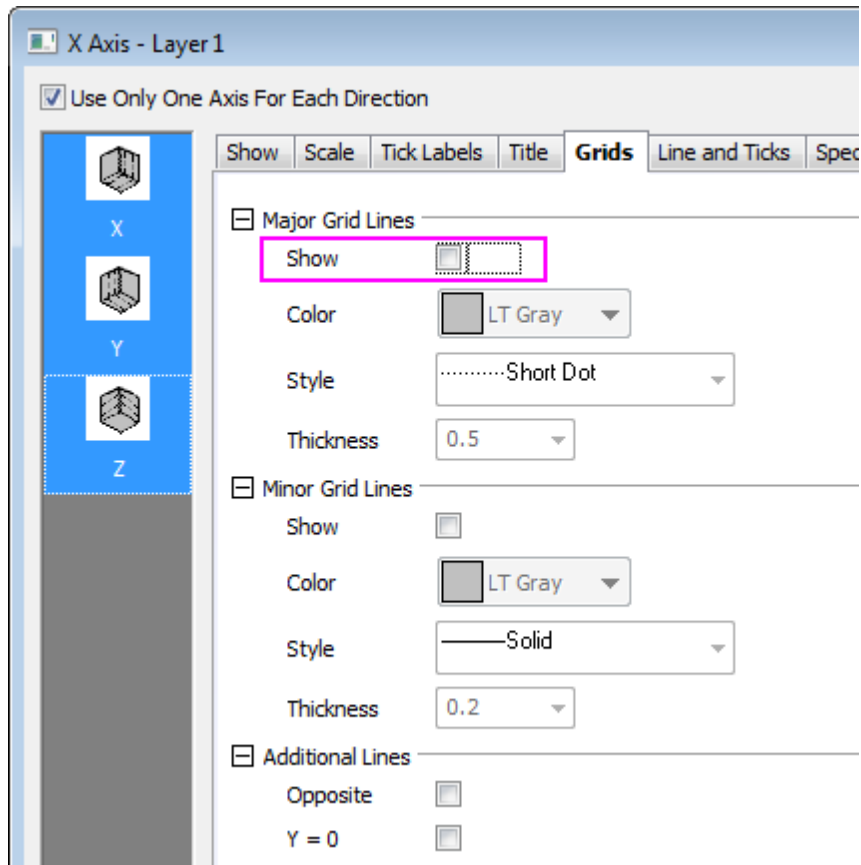

- Click the **OK** button. The graph should now display four separate surfaces as shown below:

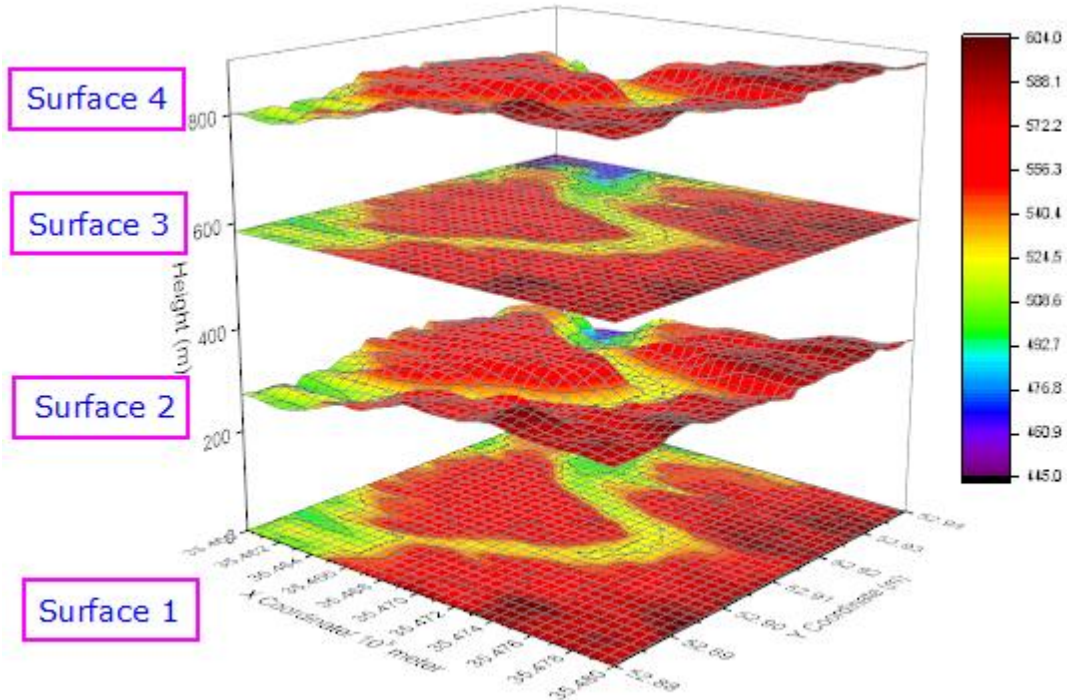

### 6.13.14.3.2 Customize the flattened color filled contour plot

1. Double-click on "Surface 1" to open the Plot Details dialog. Select the **Colormap/Contours** tab and click on the **Fill...** header to open the **Fill** dialog. In the **Fill** dialog, select **Load Palette** then click **Select Palette** and select the **Reef** palette. Click **OK** to close the **Fill** dialog.

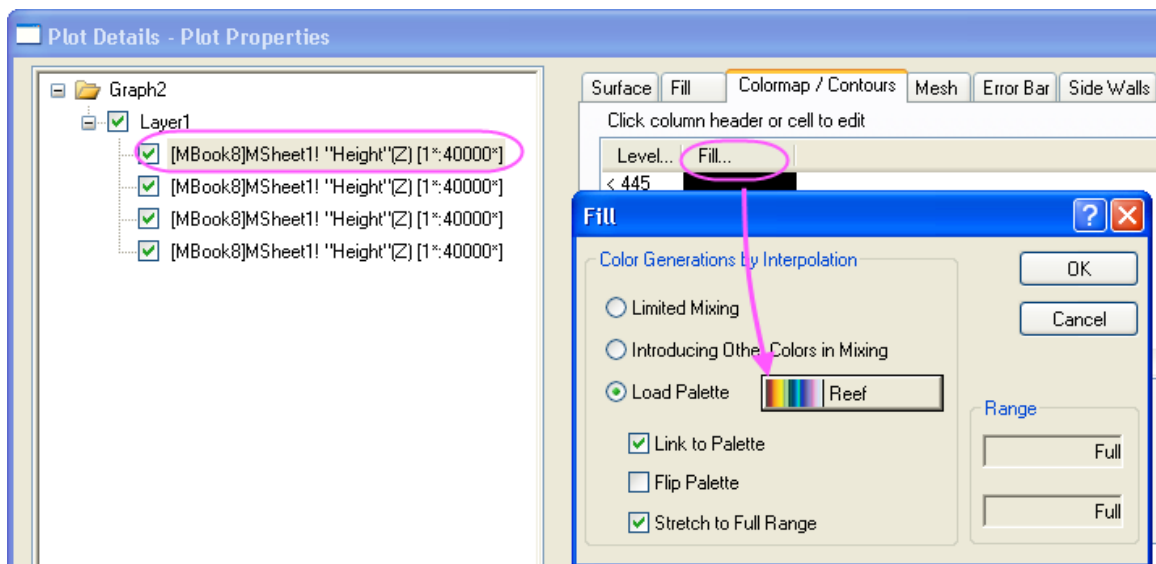

2. In the **Colormap/Contours** tab, clear the **Enable Contours** check box.

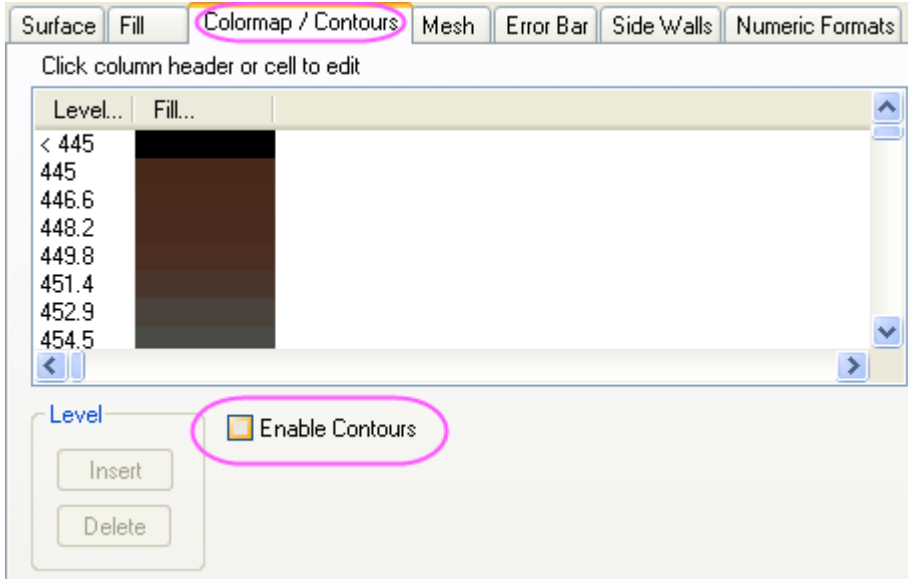

3. Select the **Mesh** tab and clear the **Enable** check box.



4. Click **Apply** to update your graph.

### 6.13.14.3.3 Customize the color filled surface

1. Select the second data set (do not clear the accompanying check box), click the **Fill** tab, select **Fill piece by piece** and choose **Dark Yellow** from the drop-down.

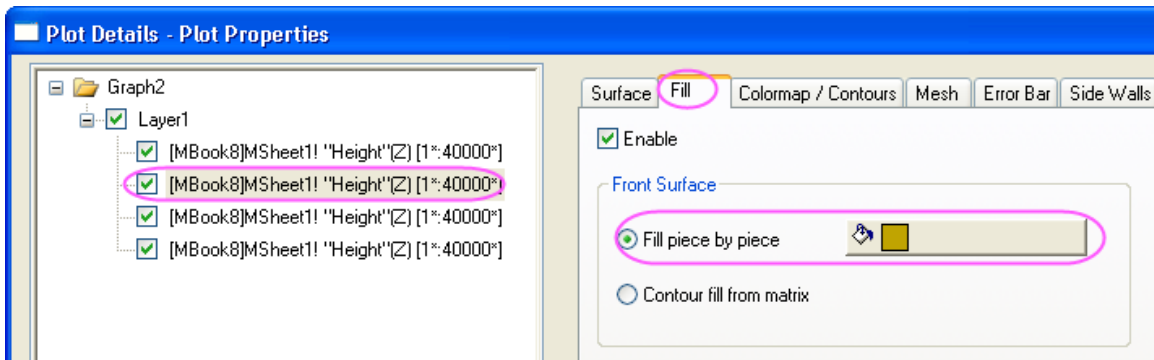

2. Select the **Colormap/Contours** tab and clear the **Enable Contours** check box.

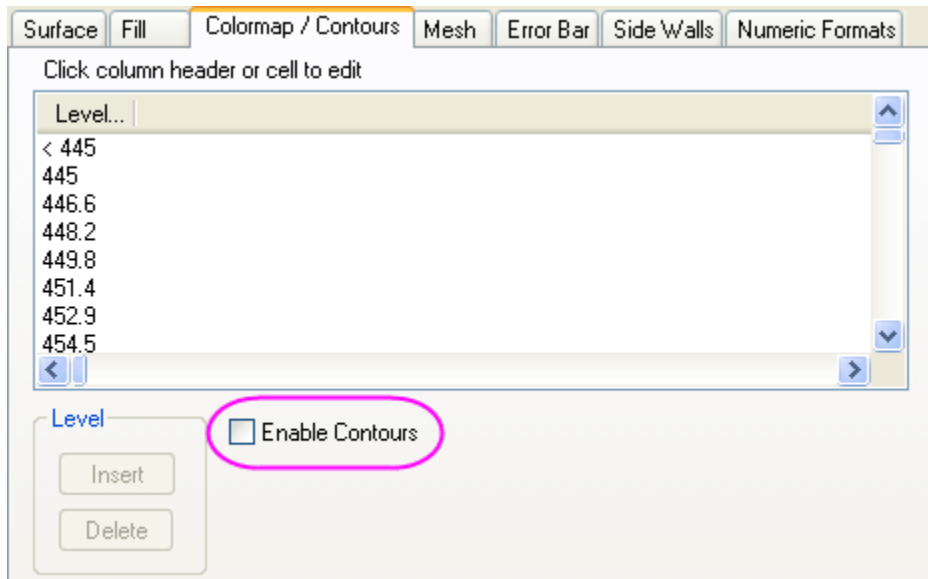

3. Select the **Mesh** tab and clear the **Enable** check box.



4. Click **Apply** to update your graph.

#### 6.13.14.3.4 Customize a flattened contour line plot

1. Select the third data set, click the **Fill** tab and clear the **Enable** check box.

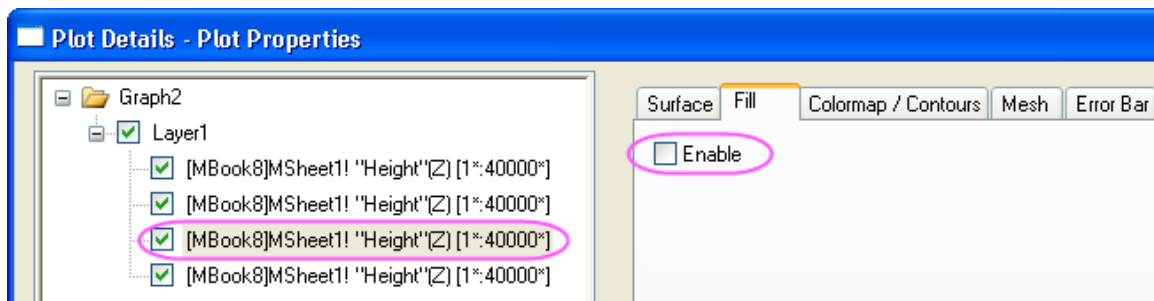



2. Select the **Colormap/Contours** tab click on the **Line...** header to open the **Contour Lines** dialog. In this dialog, select the **Link Line to Colormap Color** checkbox. Click **OK** to close the **Contour Lines** dialog.

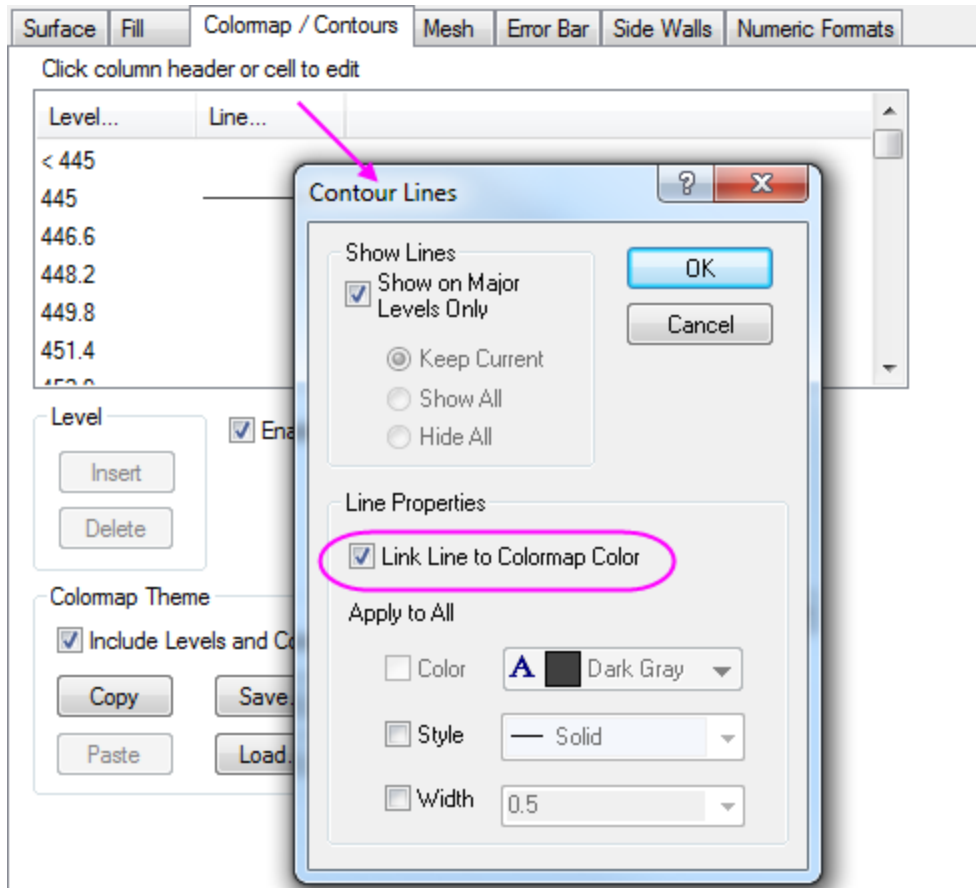

3. Select the **Mesh** tab and set the **Line Width** to **1**. In the **Major Minor Lines** section, choose the settings shown below and in the **Line Color** section select the **Use Colormap** check box .

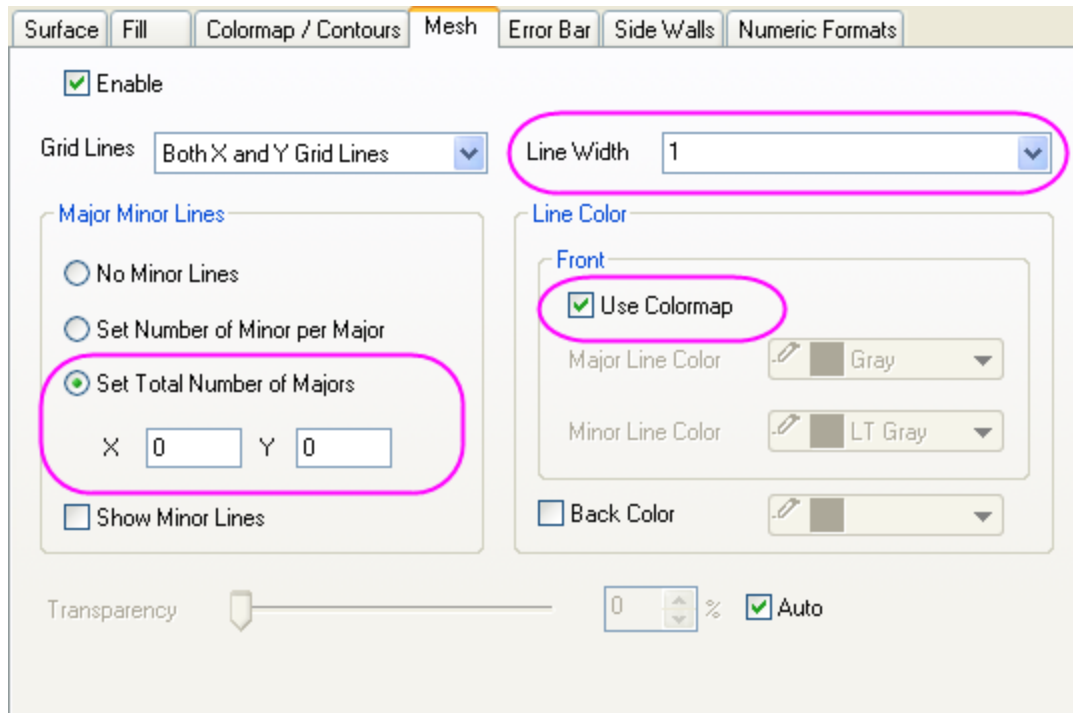

4. Click **Apply** to update your graph.

#### 6.13.14.3.5 Customize a wireframe surface

1. Select the fourth data set, click the **Fill** tab and clear the **Enable** check box.

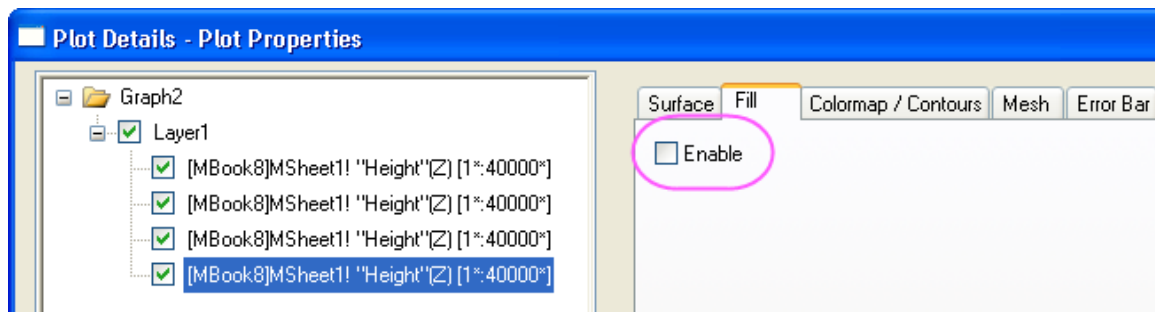

2. Select the **Colormap/Contours** tab and clear the **Enable Contours** check box.

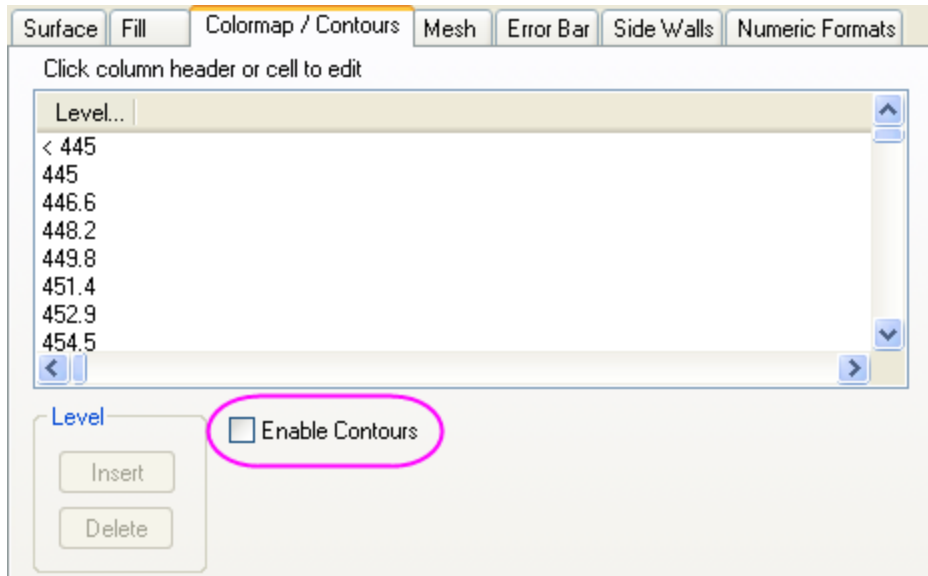

3. Select the **Mesh** tab and set the **Line Width** to **1**. In the **Major Minor Lines** section, choose the settings shown below and in the **Line Color** section set **Major Line Color** to **Black**.

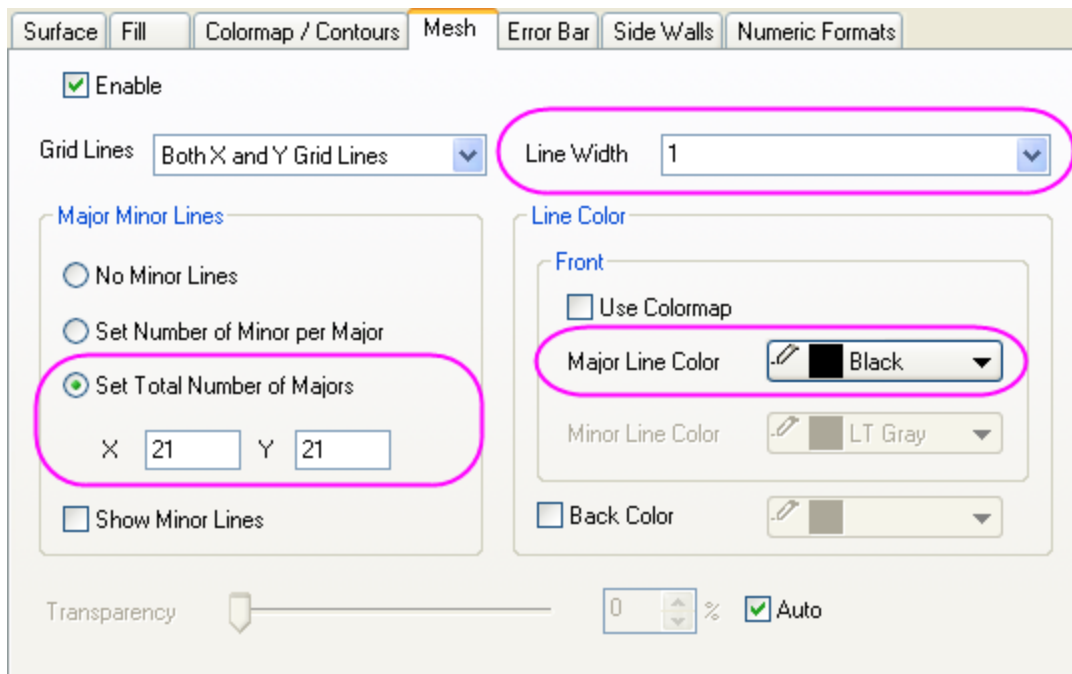

4. Select **Layer1** in the left panel. In the **Lighting** tab choose **Directional** for **Mode** and set the **Direction** group controls as shown below:

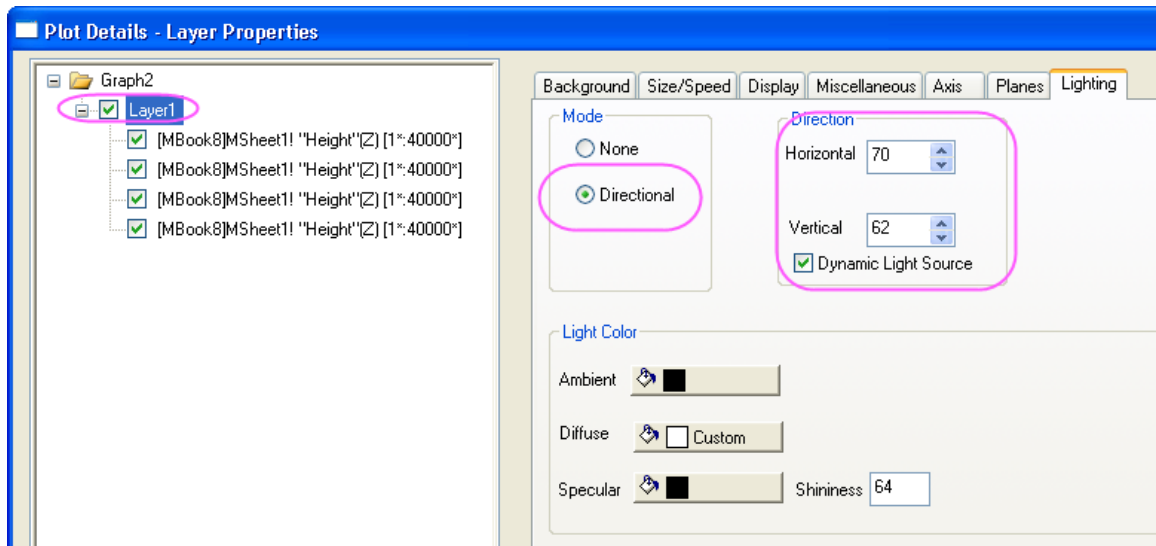

5. Select the **Planes** tab. Specify the colors of the **YZ** and **ZX** planes as shown below (a custom color approximating "eggshell" for **YZ** and LT Gray for **ZX** works well).

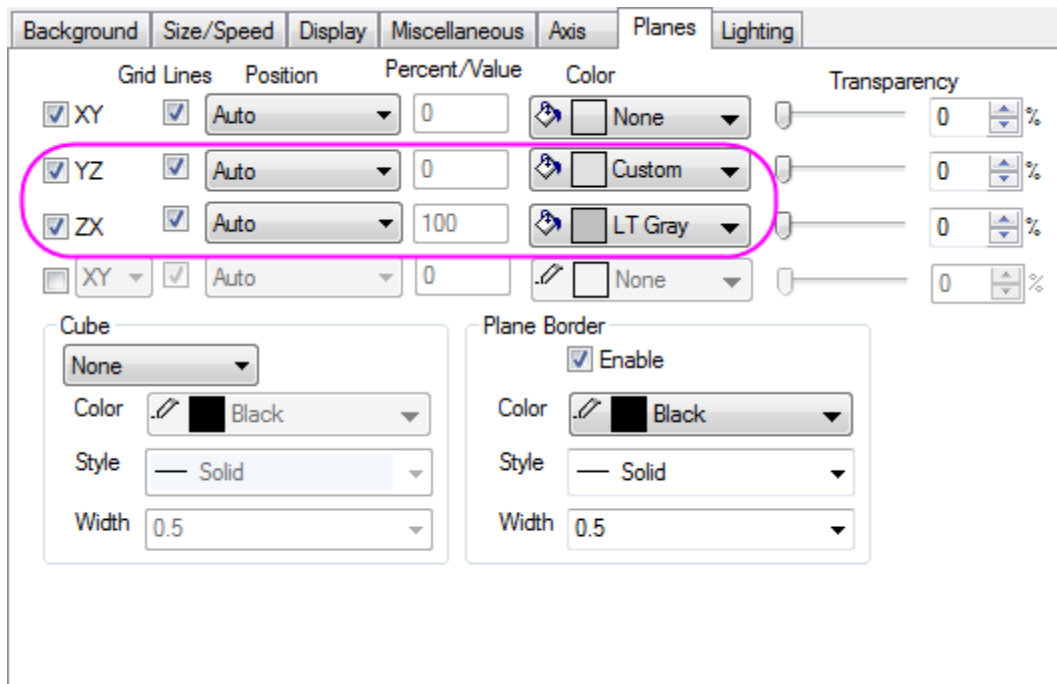

6. Click **OK** to update your graph.
7. Rotate the 3D graph if you want to. Your graph should resemble the image shown below.

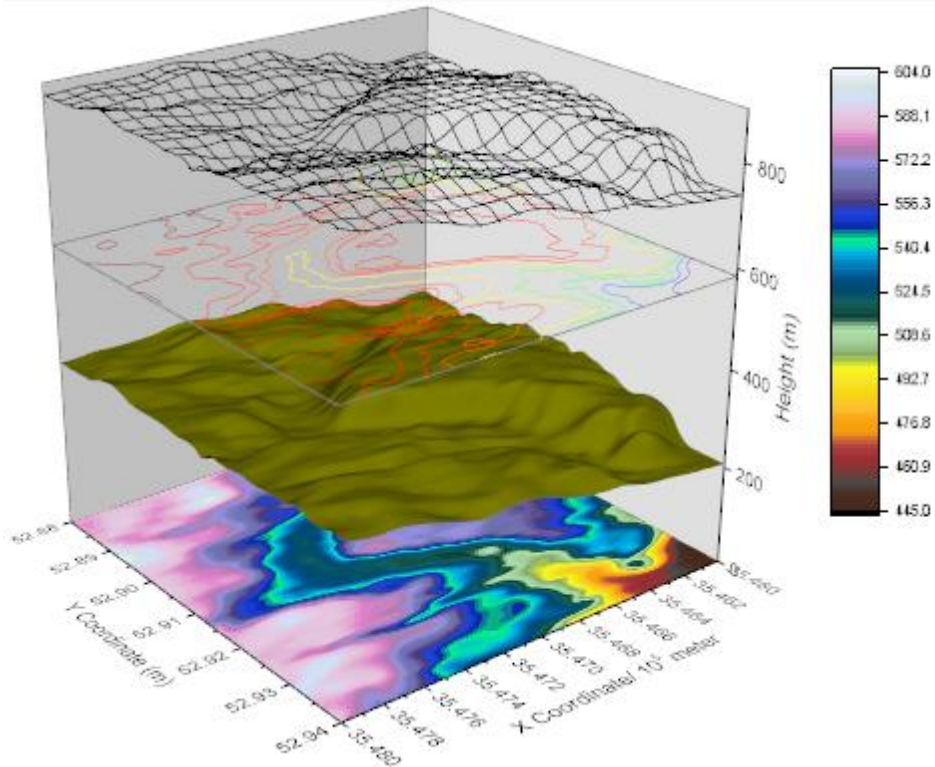

### 6.13.15 3D Scatter with Colormap

#### 6.13.15.1 Summary

This tutorial will demonstrate how to create a 3D scatter plot with Z colormap from XYZ data in a worksheet, set scatter size proportional to the data in a specified column, and create projections of the data on all three axis planes.

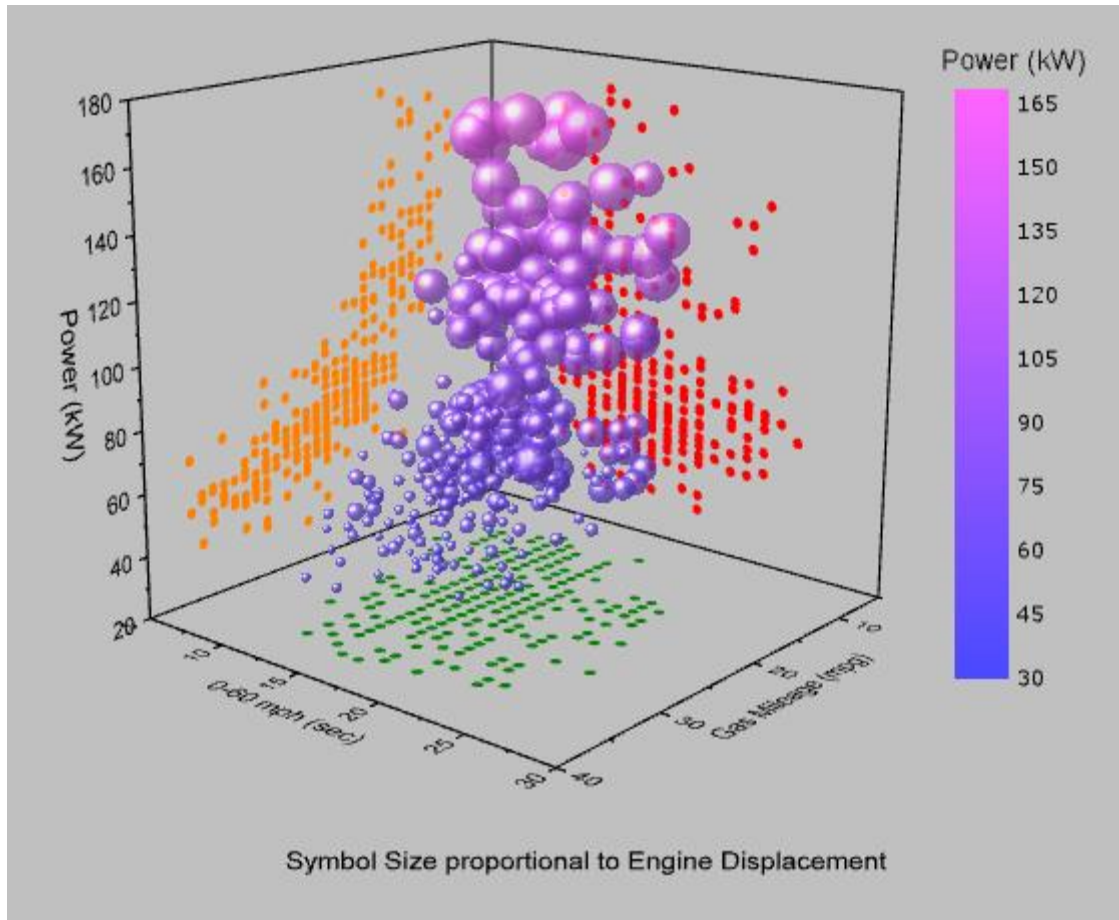

Minimum Origin Version Required: 2015 SR0

#### 6.13.15.2 What you will learn

This tutorial will show you how to:

- Generate a 3D scatter plot with Z colormap
- Set the symbol size proportional to data in a specified column
- Add and customize the scatter projections on axis planes

#### 6.13.15.3 Steps

This tutorial is associated with <Origin EXE Folder>\Samples\Tutorial Data.opj.

Also, you can refer to this graph in Learning Center. (Select **Help: Learning Center** menu or press **F11** key , and then open **Graph Sample: 3D Symbol Bar and Wall**)

1. Open **Tutorial Data.opj** and browse to the **3D Scatter with Colormap** folder in **Project Explorer (PE)**.
2. Activate the workbook **A3DScatter**, and highlight col(C). Select **Plot > 3D: 3D Scatter** to generate a scatter plot.

3. A **Reminder Message** window like the one shown below will pop up, stating that the graph might not be correctly displayed if the OpenGL version is less than 2.1. The OpenGL version of your video card is listed on the **Reminder Message** window. Click **OK** to close the window.

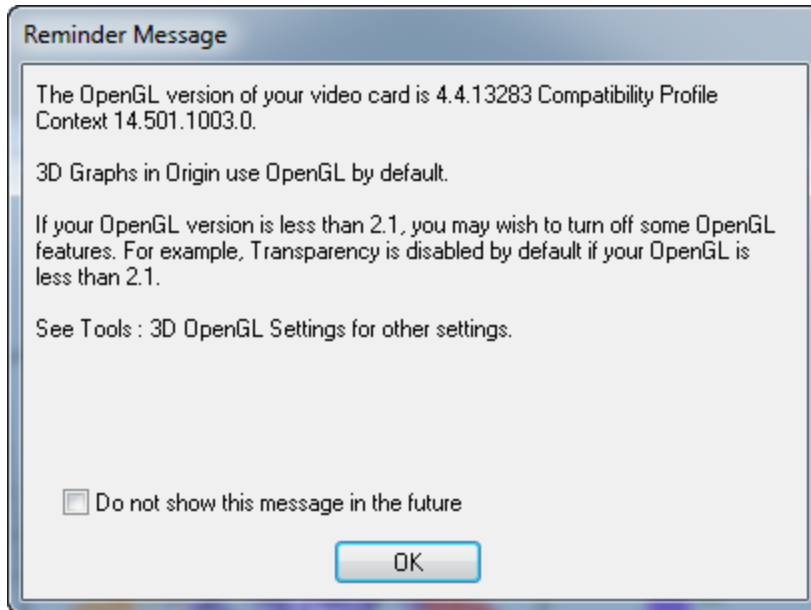

**Note:** Speed Mode might be turned on if the OpenGL version is too low.

4. Double click on the plot to open the **Plot Detail** dialog. If the left panel is not expanded use the  button on the bottom left of the dialog to expand it. Expand the **Layer1** option and select the **Original** level, this contains the original data. This dialog box is where the 3D scatter is customized.
5. In the **Symbol** tab, set **Shape** as **Sphere**. In order to use the sphere sizes to show the differences of Engine Displacement, select **Size** as **Col(E): "Engine Displacement"**, and set **Scaling Factor** as **0.005**. Type manually into the edit box instead of using the drop down menu. For **Color**, click the drop-down menu, then choose the **By Points** tab of the Color Chooser. Click on **Color Mapping** and choose Col(C): "Power" **to introduce a Z-value colormap. Set Transparency to 25%**.

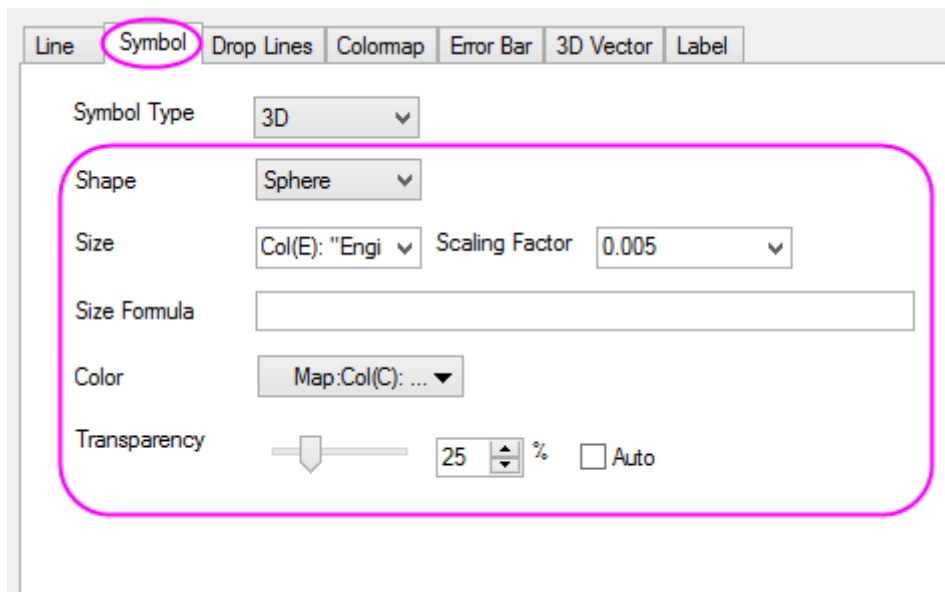

6. Select the **Colormap** tab. Click the **Level...** title to open the **Set Levels** dialog. Set **From** as **30**. Select **Increment**, and set it as **15**. Set **# Minor Levels** as **9**. Click **OK**.

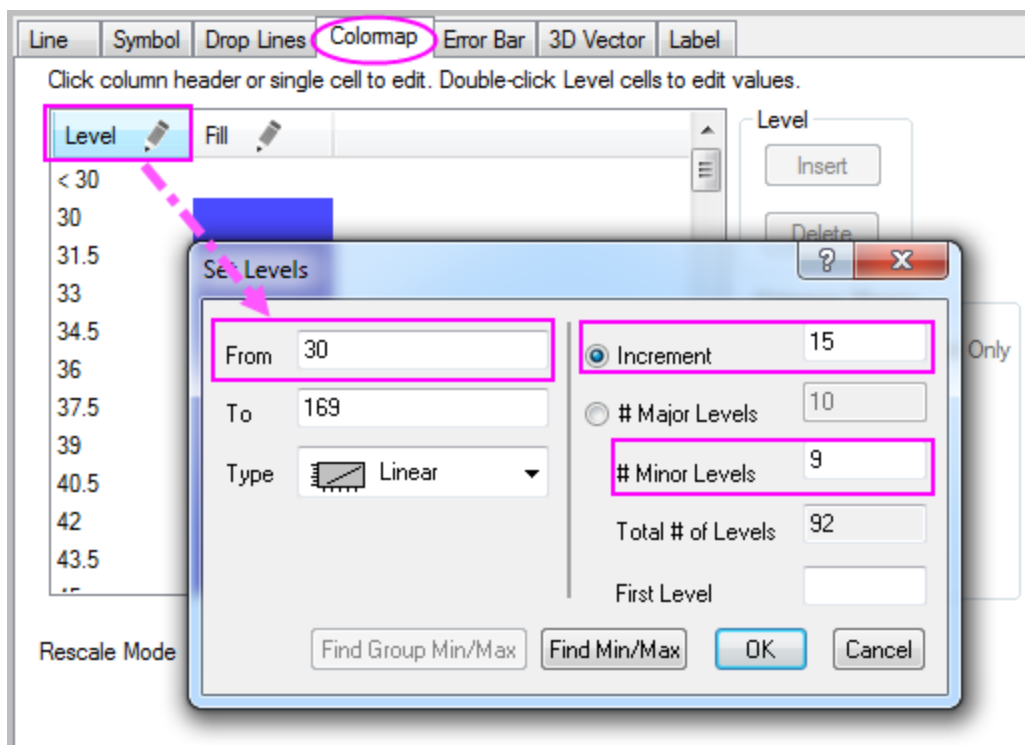

7. Click the **Fill...** title to open the **Fill** dialog. Select **Limited Mixing**. Click the default color of **From** and then click the square box under **Custom** section in the color setting panel to open the **Colors** dialog. In the **Colors** dialog, set the **Red, Green** and **Blue** option in the bottom right as 74, 74, 255. Do the same thing for **To** color and set the **Red, Green** and **Blue** option as 255, 100, 255. Click **OK**.



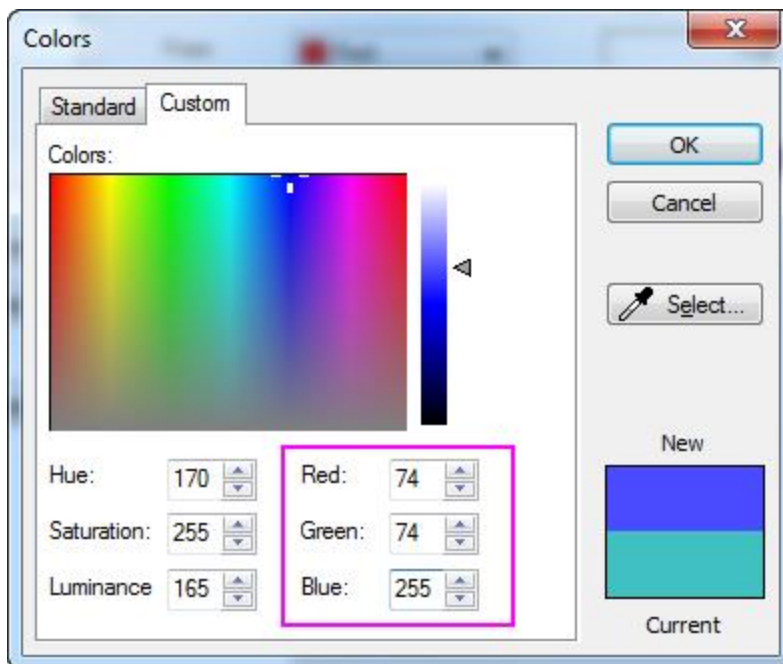
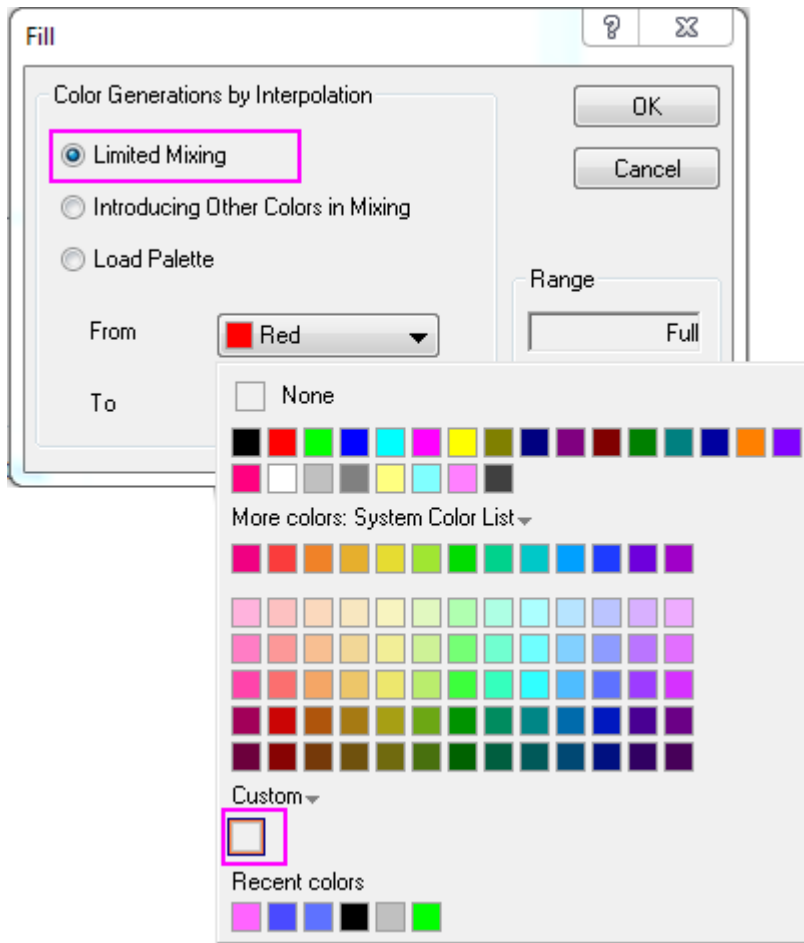

- Click on the fill color of **<30** level to open the **Fill** dialog. Set **Fill Color** as **None**. Click **OK**. Repeat the this step to set fill color of **>168** level as **None**. This will ensure that there is no color for levels above and below the specified range.

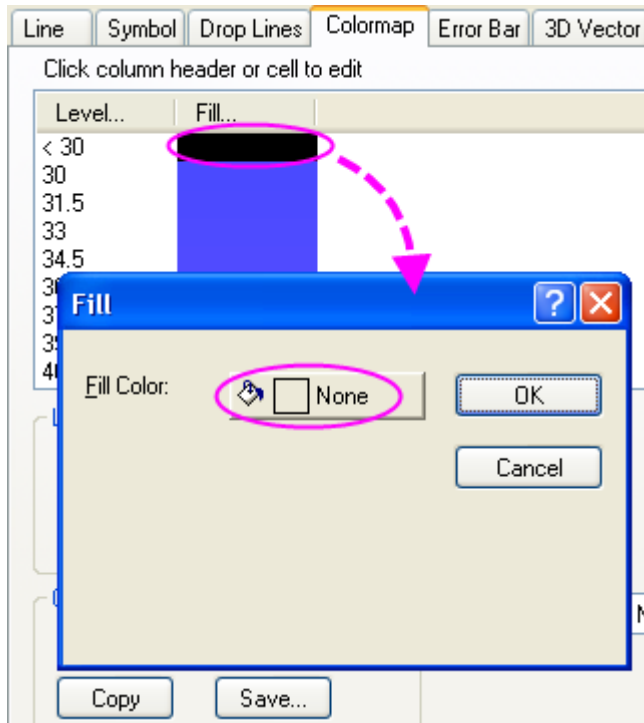

- The next step is to add the data projections. In the left panel of the **Plot Details** dialog, select the option above **Original**, and select the **Fully Independent** radio button. This will ensure that when the projections have been enabled, each can be customized separately. Check the boxes for **XY Projection**, **ZX Projection** and **YZ Projection** to enable the scatter projections on all three planes.
- To customize the colors of the projections, in the **XY Projection** level **Symbol** tab, set its color as **Olive**(the 12th common color). Set the symbol color of **ZX Projection** and **YZ Projection** as **Red** (the second common color) and **Orange** (the 15th common color) respectively. Click **OK**.

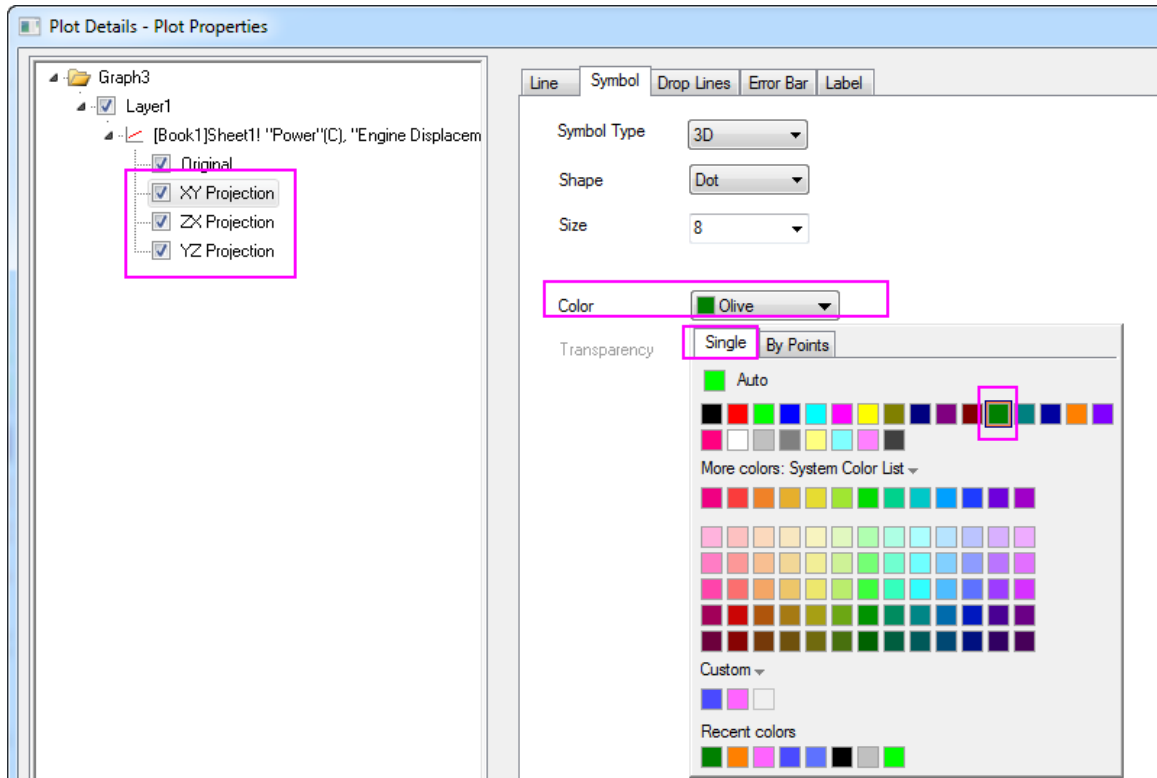

- In order to remove the grid lines, double click on the X axis to open the **Axes** dialog. Select the **Grids** tab on the right panel, hold the CTRL key and select Y and Z axes to customize the settings together, then deselect the **Show** box under **Major Grid Lines** to hide the major grid lines of all axes.

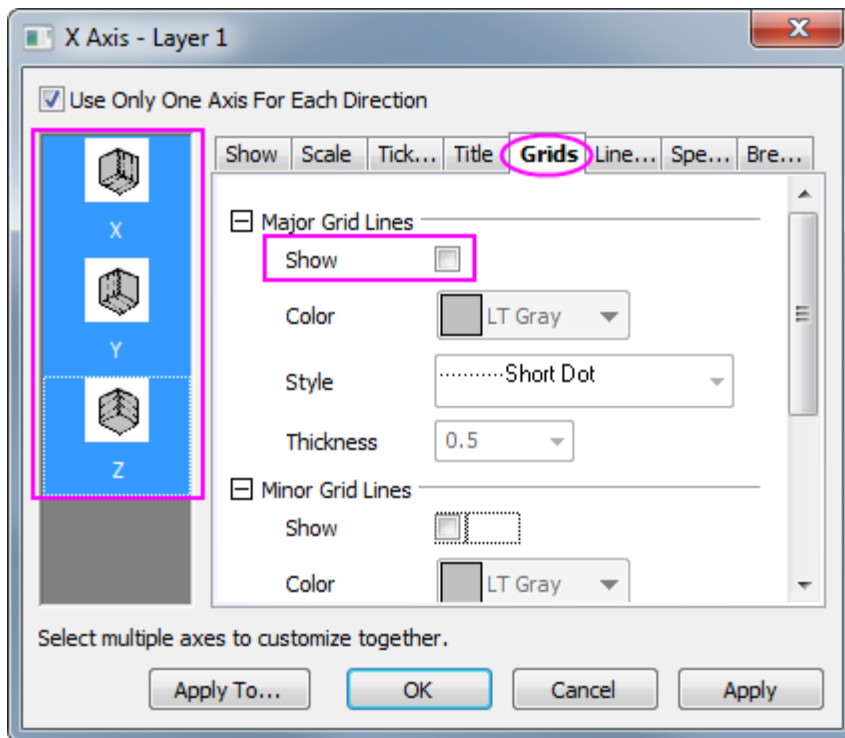

12. The next step is to change the scale for the axes. On the **Scale** tab for each axis set the following; for X Axis, change the **From, To** value and the increment **Value** of major ticks to **5, 30, 5** respectively, and then check the **Reverse** check box; for Y Axis, to **5, 40** and **10**, and then check the **Reverse** check box; And for Z Axis, to **20, 180** and **20**. Click **OK**.
13. To designate the color for the background of the entire window, open the **Plot Details** dialog again. In the left panel, select the **Graph** level above the **Layer1** option. Select the **Display** tab. Set **Color** as **LT Gray**. Click **OK**.

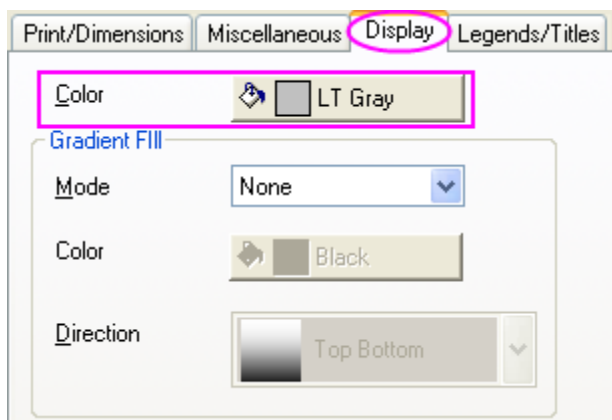

14. Delete the legend object created by default, we are going to add a color scale legend instead.

15. In order to add a color scale legend, click the **Add Color Scale**  button in the **Add Object to Graph** toolbar. Double click on the color scale to bring up the **Color Scale Control** dialog. Set the color scale format according to the screenshots below:

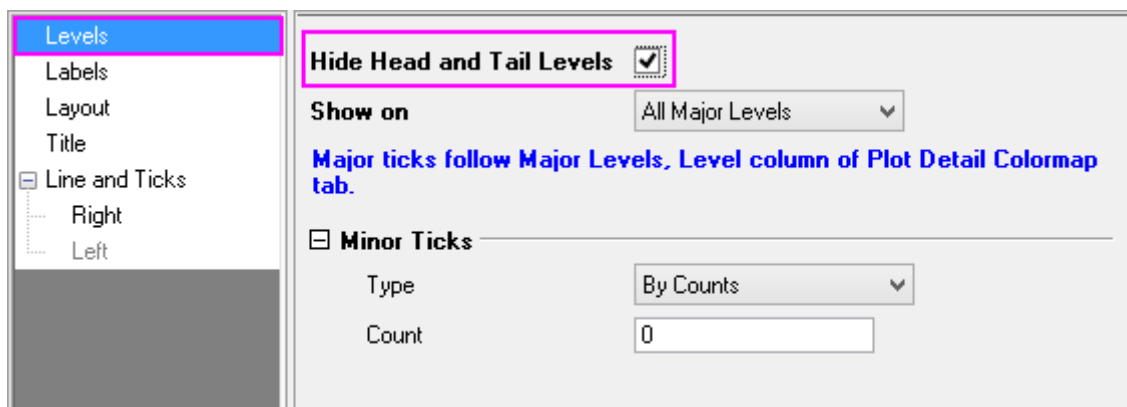

Levels  
Labels  
Layout  
Title  
Line and Ticks  
Right  
Left

Divide by Factor

Prefix

Suffix

**Format**

Color

Rotate (deg.)

Wrap Text

Alignment

**Font**

Font

Size

Bold

Italic

Underline

Levels  
Labels  
Layout  
Title  
Line and Ticks  
Right  
Left

**Background**

**Layout**

**Arrangement**

Auto

Vertical

Horizontal

**Reverse Order**

**Show Labels on Opposite Side**

**Follow Graph's Standard Font Size Setting**

**Size and Label Offset (in % of font height)**

Color Bar Thickness

Label Offset from Bar Edge

Label Side Offset from Center

Levels  
Labels  
Layout  
Title  
Line and Ticks  
Right  
Left

**Show**

**Title**

**Position**

**Rotate (deg.)**

**Color**

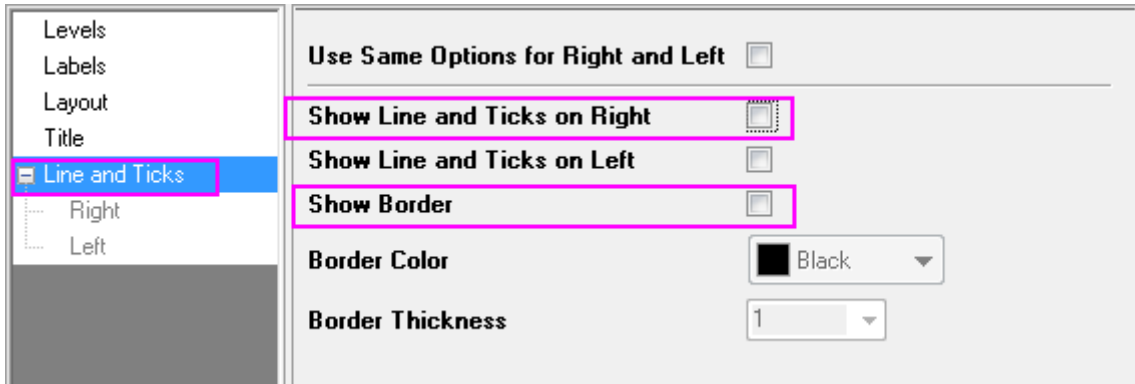

16. Right click on the page layer to bring out the context menu. Select **Add/Modify Layer Title** and type *Symbol Size proportional to Engine Displacement* in the text box that appears as the layer title.

17. The graph should appear as shown below. Rotate to explore all sides:

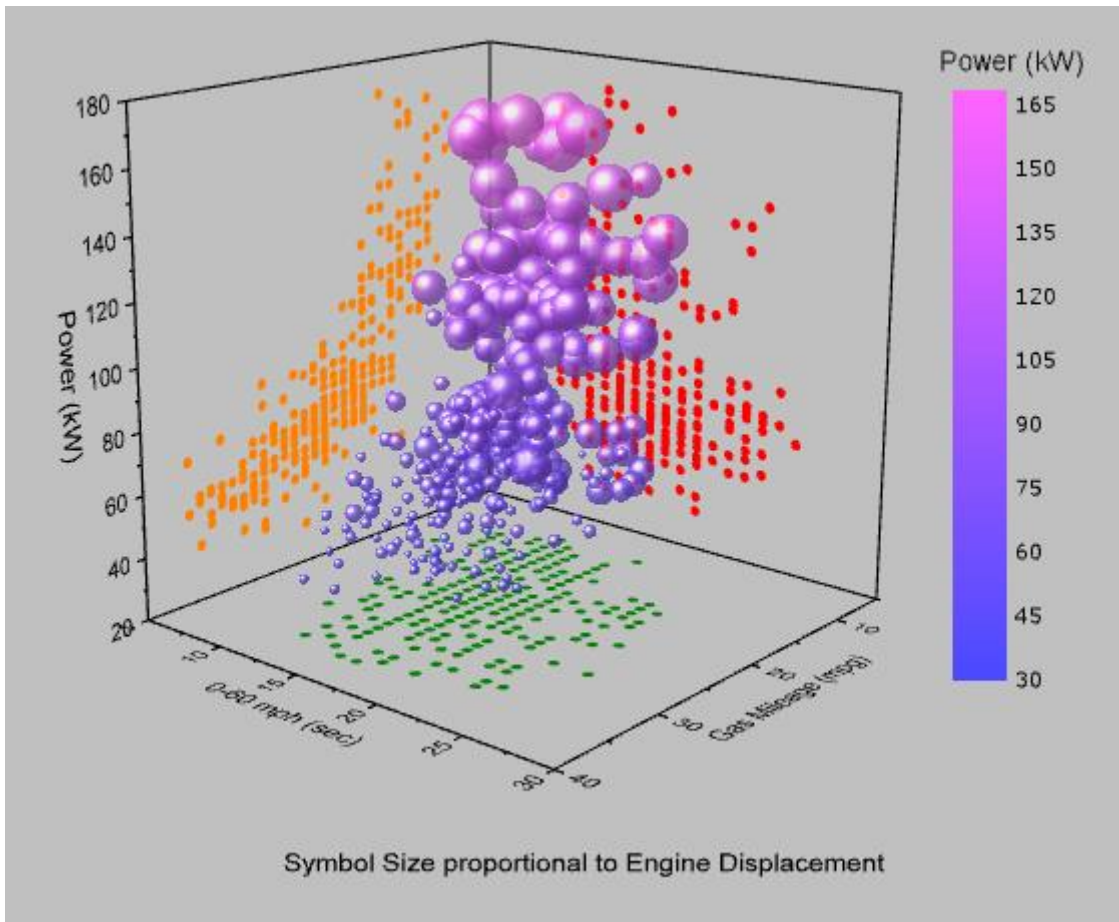

### 6.13.16 3D Scatter with Droplines

This graph consists of a flat surface and an XYZ scatter with labels. The US Map is a matrix with 1's and 0's, displayed as a flat surface. The population data is an XYZ scatter plot with droplines.

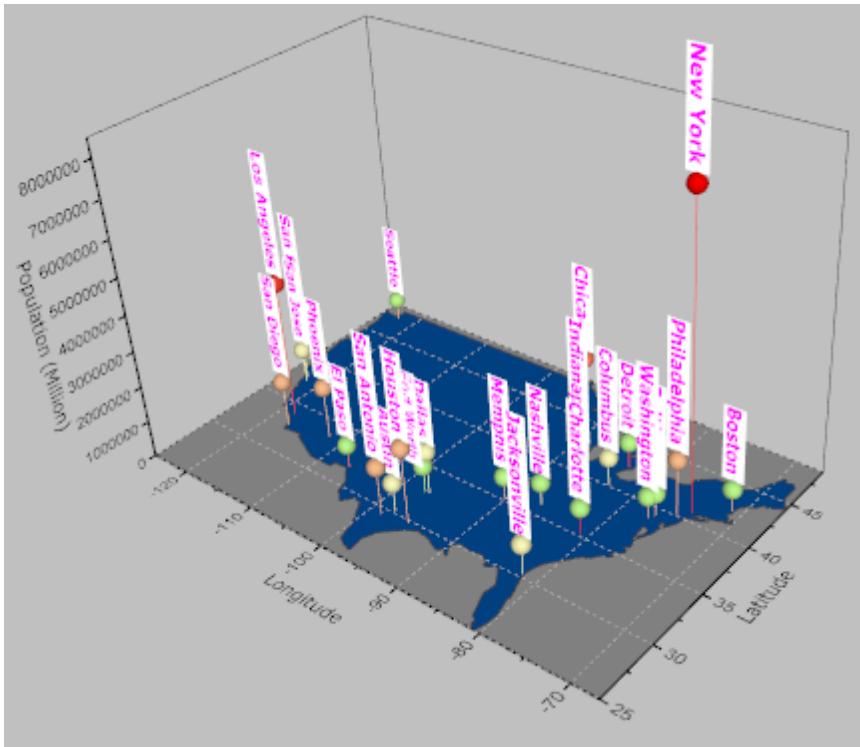

Minimum Origin Version Required: Origin 9.0 SR0

#### 6.13.16.1 What you will learn

This tutorial will show you how to:

- Plot a flat surface.
- Add a 3D scatter to the existing graph window.
- Turn on and customize the labels.

#### 6.13.16.2 Steps

This tutorial is associated with <Origin EXE Folder>\Samples\Tutorial Data.opj.

1. Open **Tutorial Data.opj** and browse to the **3D Scatter with Droplines** folder in **Project Explorer (PE)**.
2. Activate **MBook1B**, select **Plot > 3D : 3D Colormap Surface** from the main menu. A graph window will be generated.

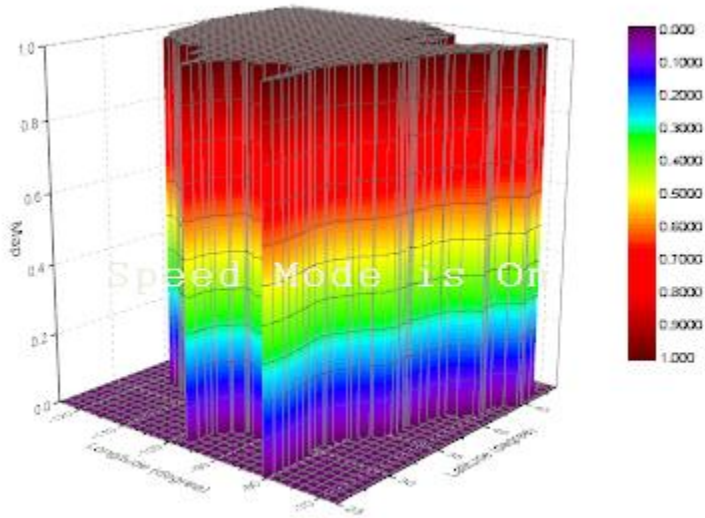

3. Double-click on the plot to open the **Plot Details** dialog. In the **Surface** tab, check the **Flat** check box.

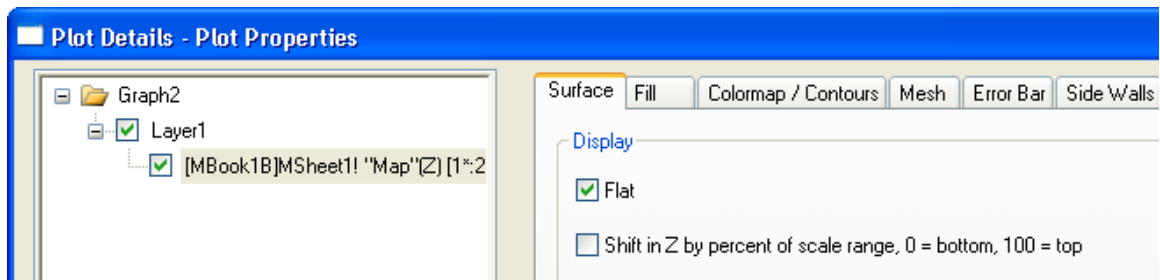

4. Go to the **Colormap/Contours** tab, click the **Fill...** header to open the **Fill** dialog. In this dialog, select **Limited Mixing** and set the **From** and **To** colors as shown below.



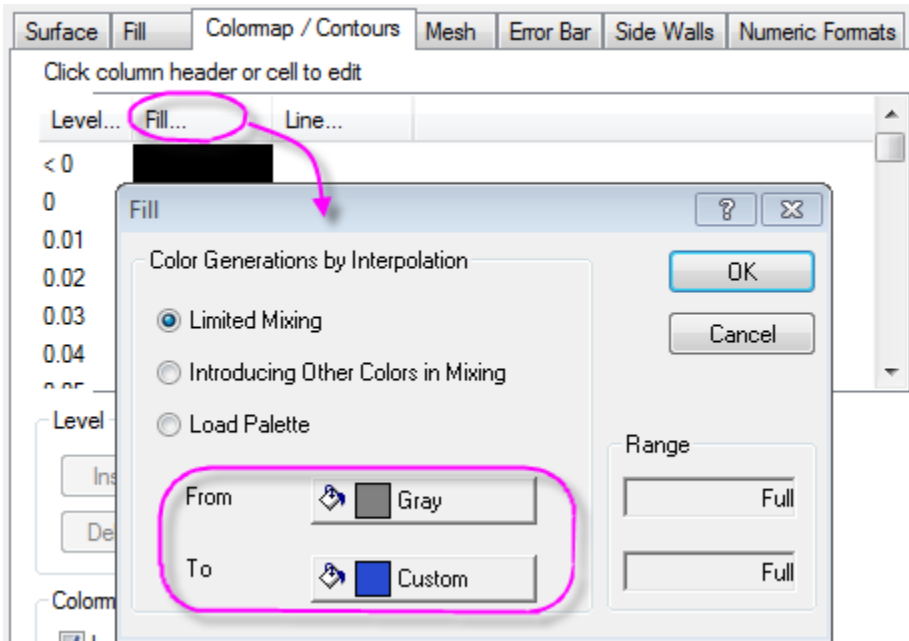

5. Click the **OK** button to close the **Fill** dialog.
6. Click the **Level...** header to bring up the **Set Levels** dialog. Set the levels as given below.

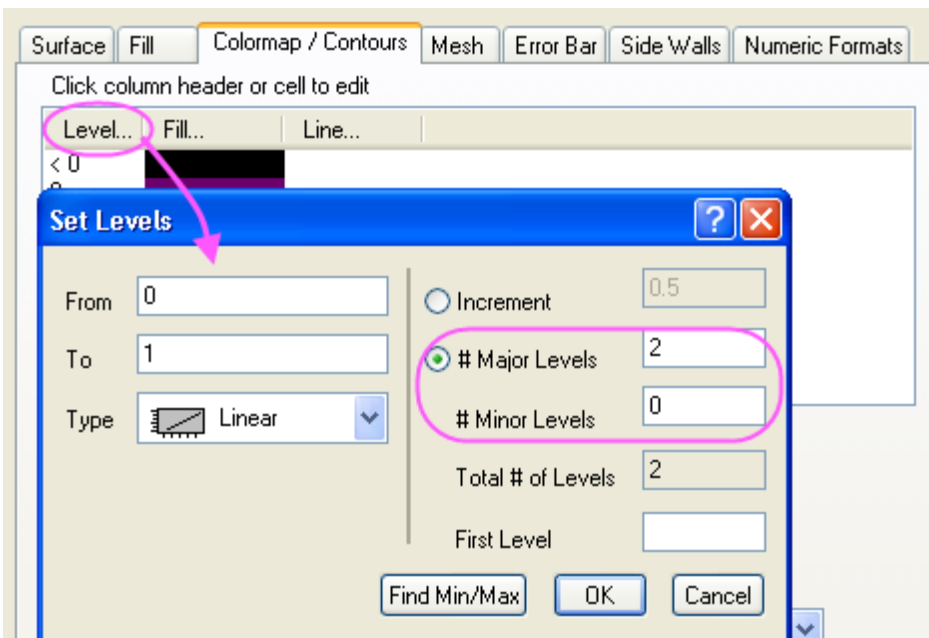

7. Click the **OK** button to close the **Set Levels** dialog.
8. Go to the **Mesh** tab, uncheck the **Enable** check box.

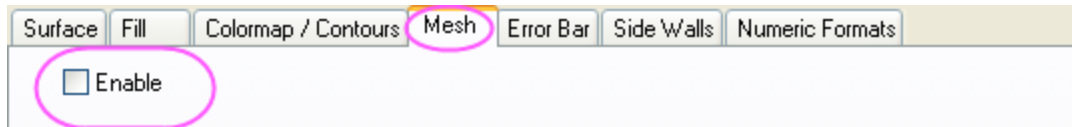

- Click the **OK** button to close the dialog. On the graph window, right-click on the layer icon to select **Layer Contents...** from the context menu to open the **Layer Contents** dialog. In this dialog, select **Worksheet in Folder** from the top-left drop-down list, select col(D) in the left panel and select **3D Scatter/Trajectory/Vector** as plot type, check the **Rescale on Apply** check box, and then click the arrow to add col(D) to the right panel as a 3D scatter plot.

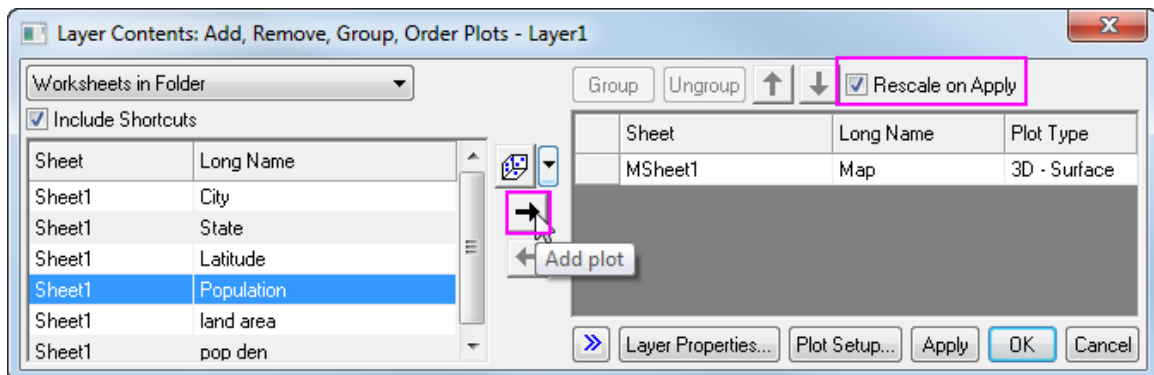
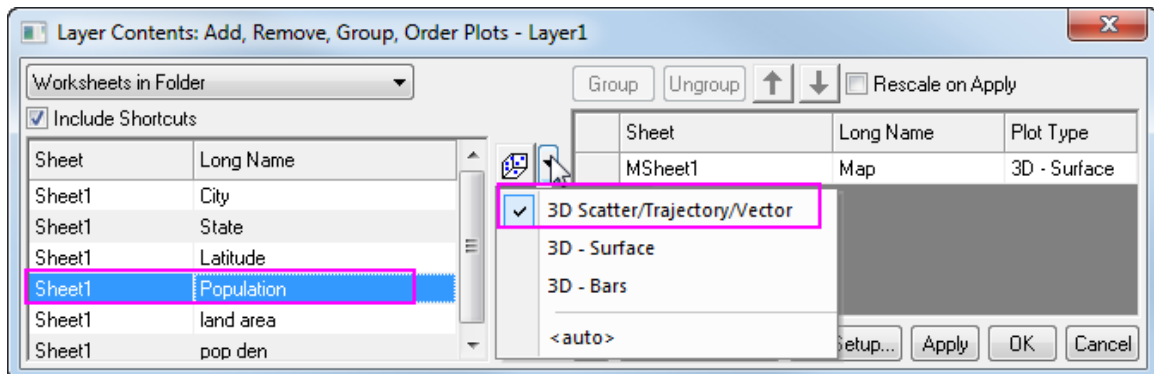

- Click **OK** button to close the **Layer Contents** dialog. The population data will be added to the graph as shown below.

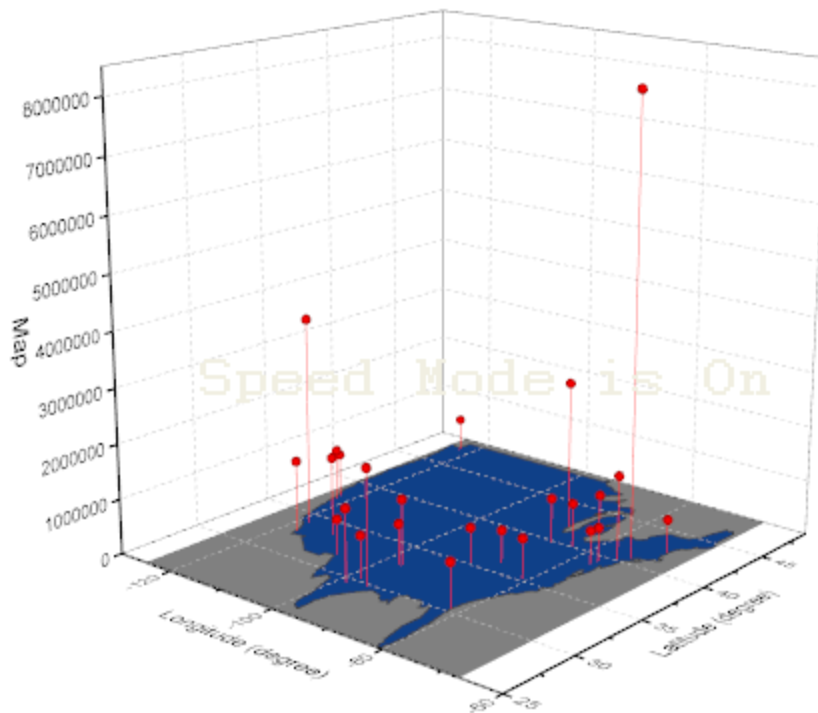

11. Double-click on the 3D scatter plot to open the **Plot Details** dialog. Go to the **Symbol** tab, set the **Size** as *18* and set the color as colormap defined by `col(Population)`.

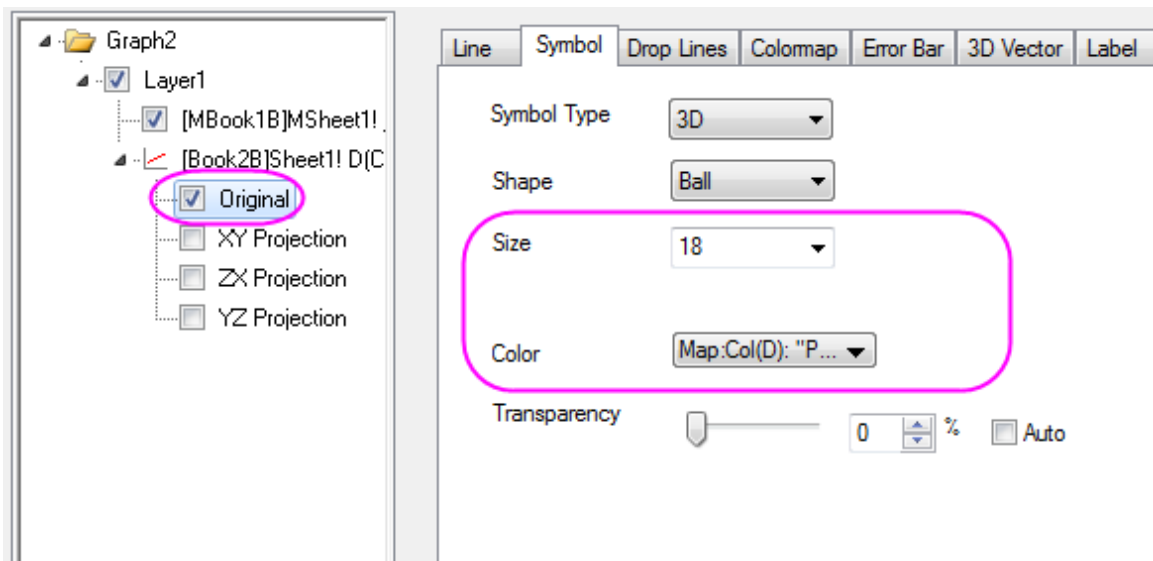

12. Go to the **Colormap** tab, click on the **Level...** header to open the Level dialog. Set the level as given below.

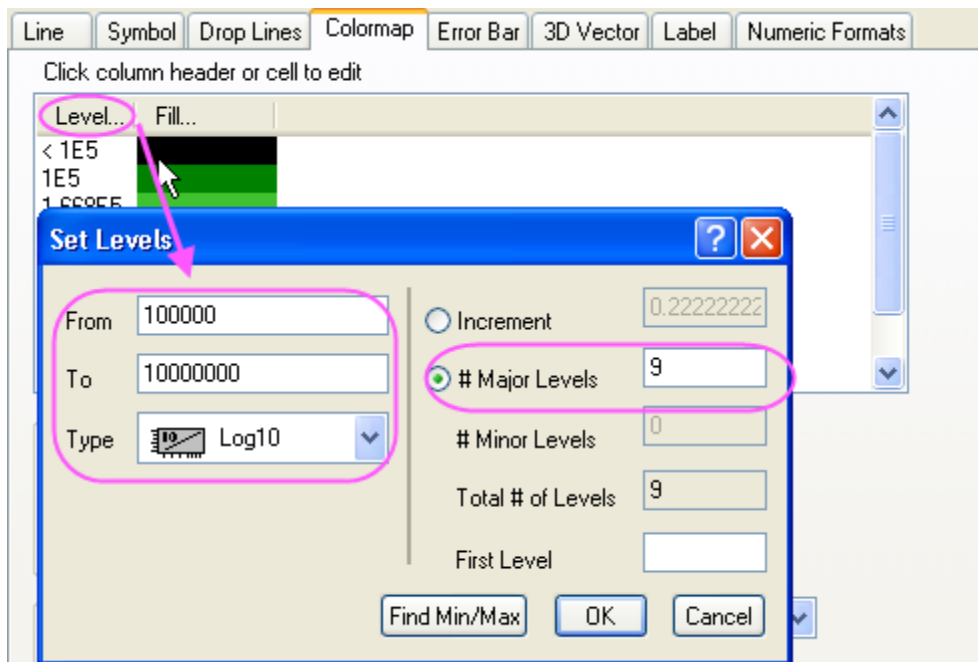

- Click **OK** to close the **Set Levels** dialog. Click on the **Fill...** header to open the **Fill** dialog. In the Fill dialog, select **Load Palette** and then click the **Select Palette** button to select the **Watermelon** palette. Click **OK** to close the **Fill** dialog.

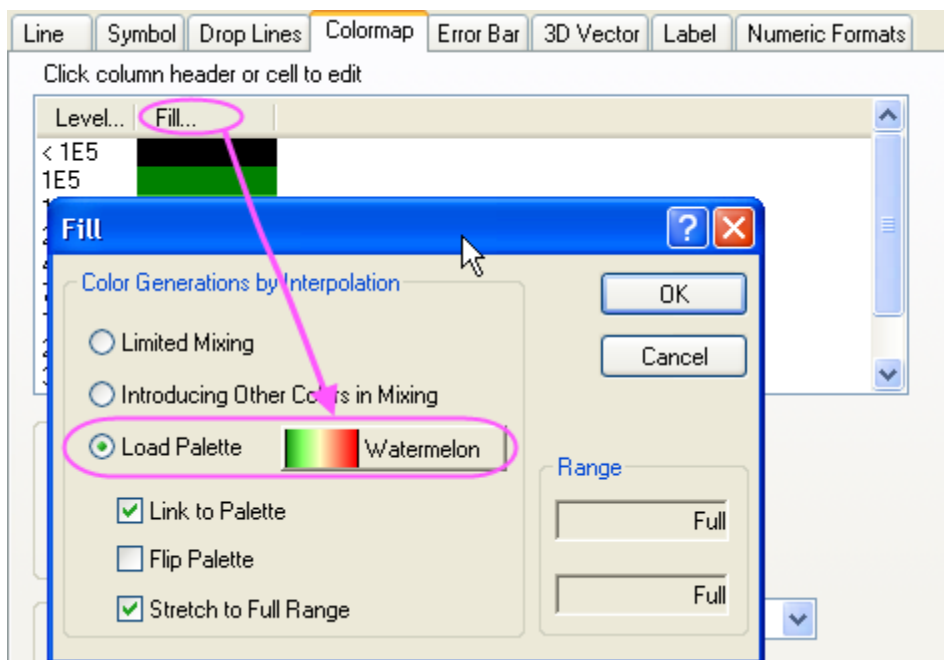

- Go to the **Label** tab, apply settings given below.

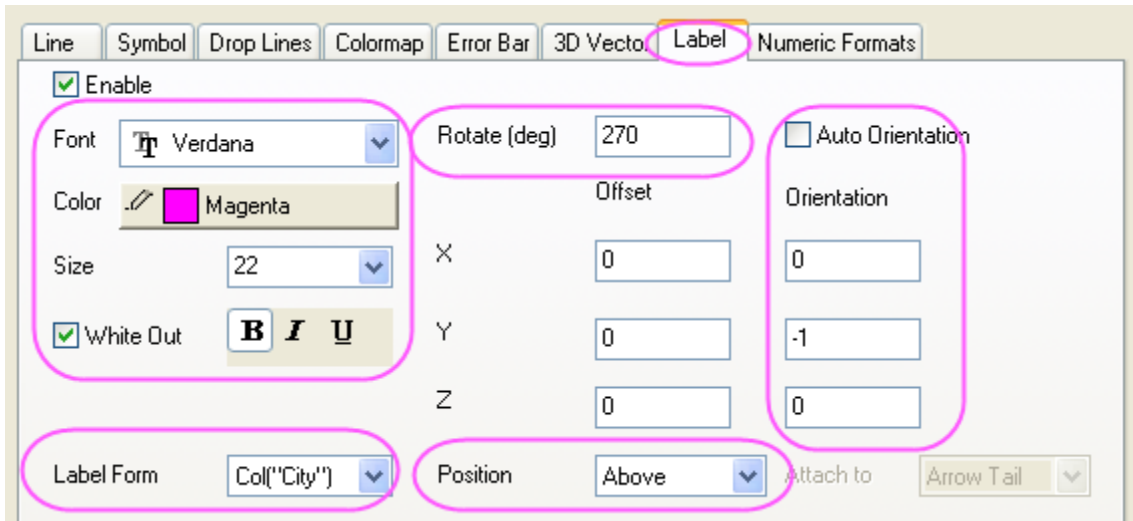

15. Select **Layer1** in the left panel and then go to the **Size/Speed** tab in the right panel. Uncheck the check boxes under **Speed Mode, Skip Points if needed**.

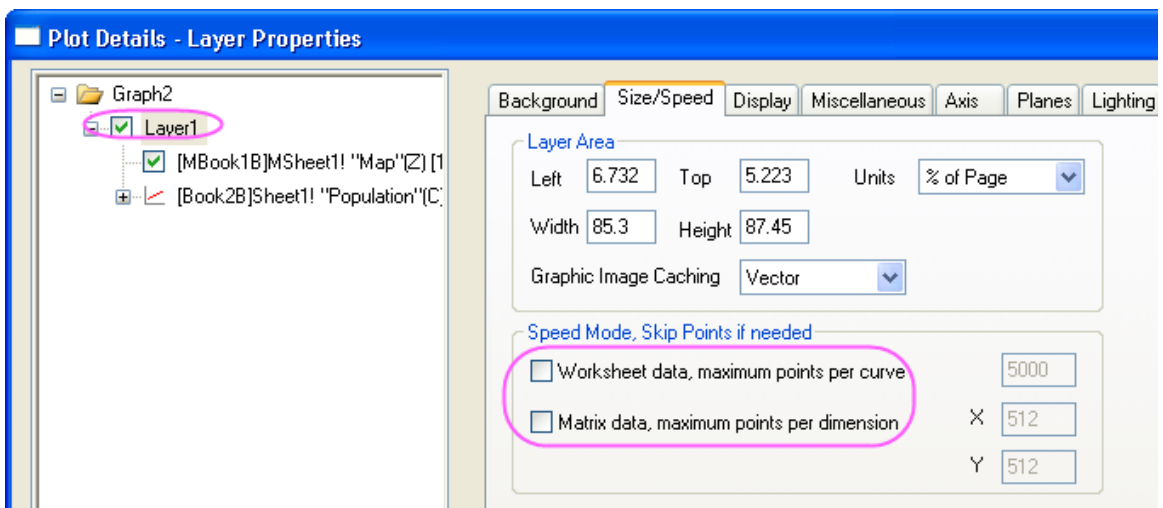

16. Select Graph level in the left panel and then go to the **Display** tab, set the **Color** as *LT Gray*.

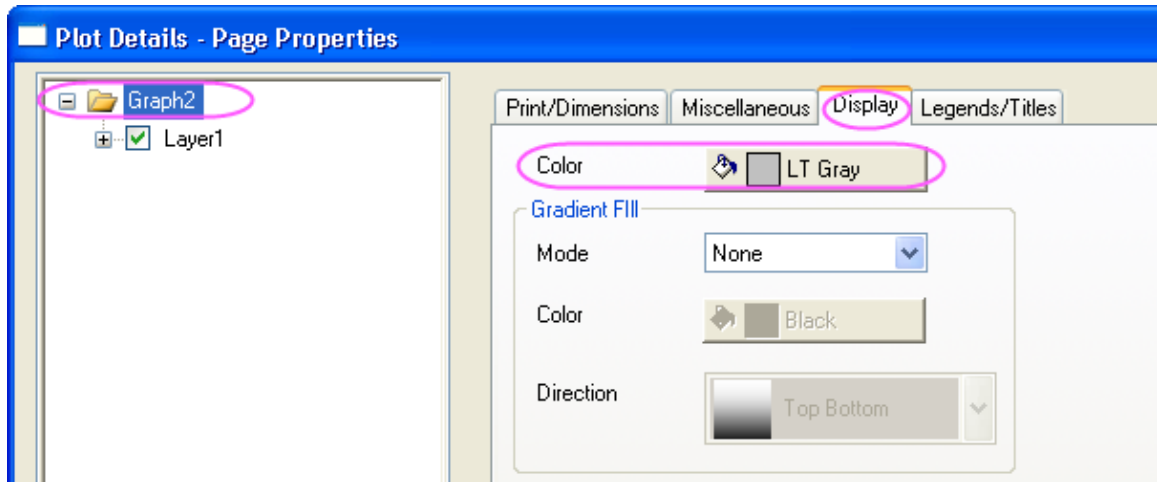

17. Click **OK** to close the **Plot Details** dialog. Finally, you will get the graph given below.

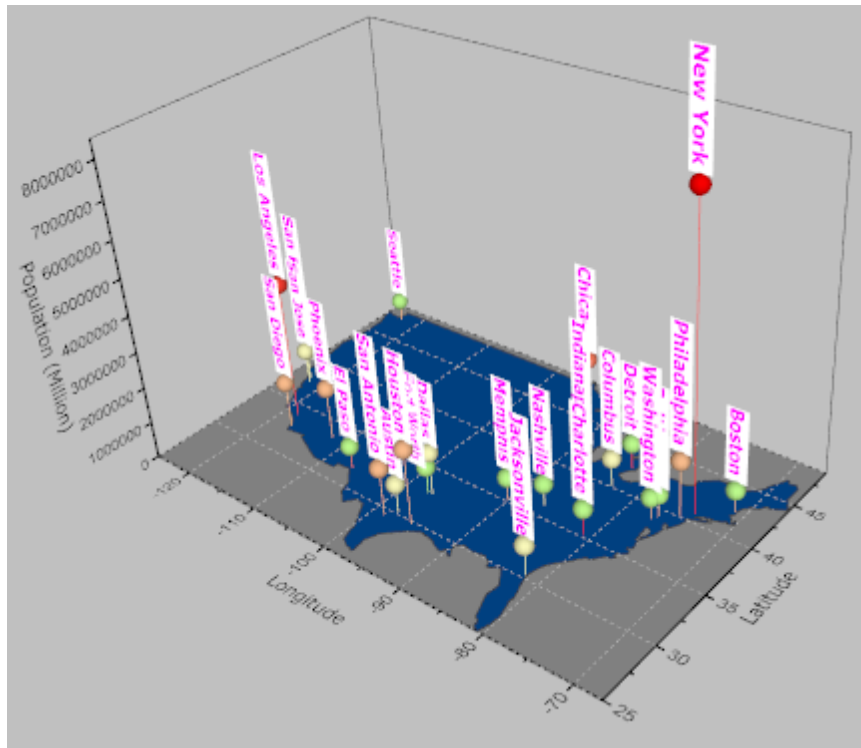

### 6.13.17 Surface With Transparent Plane

This graph shows the topography of Lake Ontario. It is a combination of a 3D surface and a transparent plane.

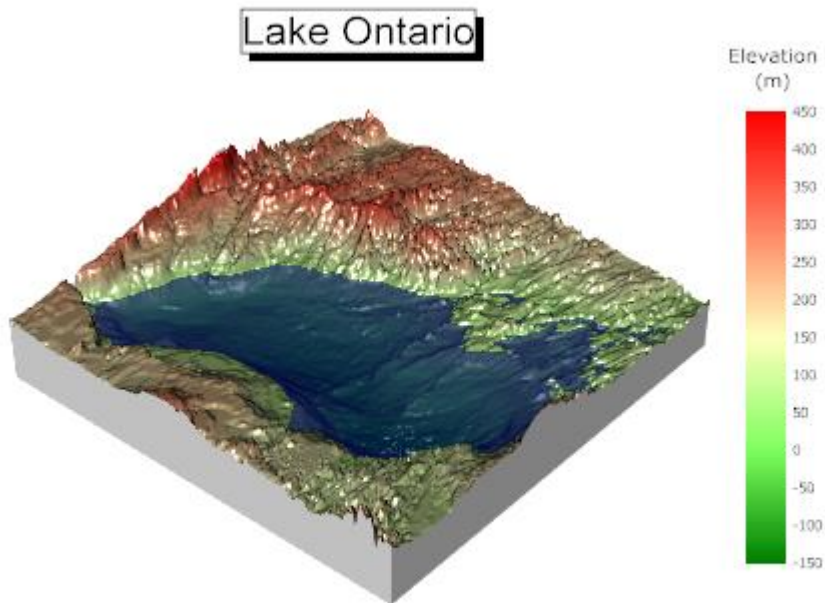

Minimum Origin Version Required: 2015 SR0

#### 6.13.17.1 What you will learn

This tutorial will show you how to:

- Plot a 3D color map surface graph
- Plot a transparent plane onto the existing 3D surface plot
- Set the lighting for a 3D surface plot

#### 6.13.17.2 Steps

This tutorial is associated with the **Tutorial Data** project: <Origin EXE Folder>\Samples\Tutorial Data.opj.

1. Open the **Tutorial Data** project and browse to folder *Surface With Transparent Plane* in **Project Explorer**.
2. Activate **MBook3L**, and highlight all data. Select **Plot > 3D : 3D Colormap Surface** from the main menu. A graph window will be generated as shown below:

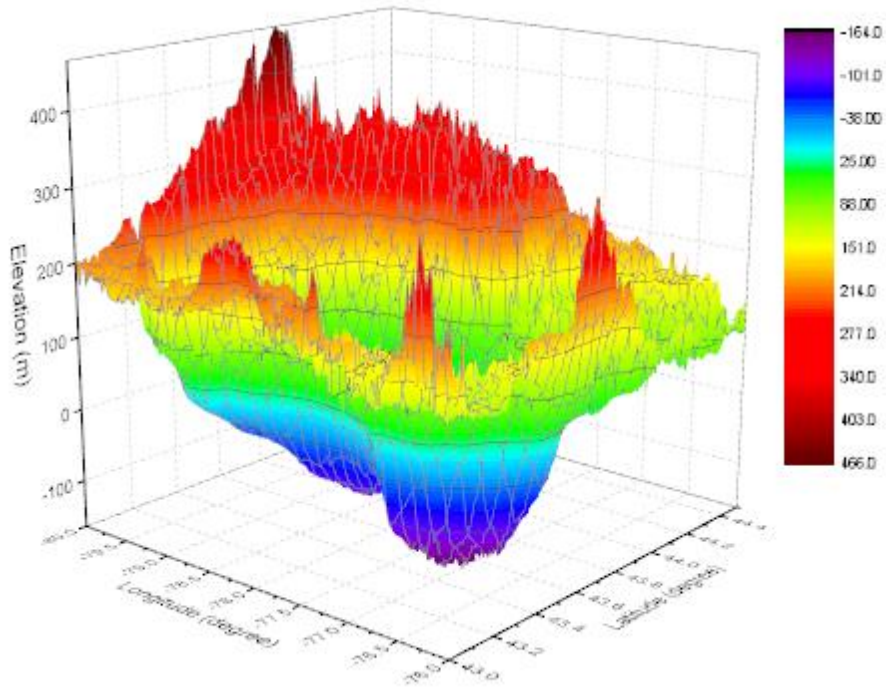

- Right click on the layer icon **1** at the top right of the graph and select **Layer Contents...**, add **MBook2** as a 3D surface into this layer by shifting it from the left panel to the right panel using the arrow button in the center of the dialog as shown below. Then click **OK** to close dialog.

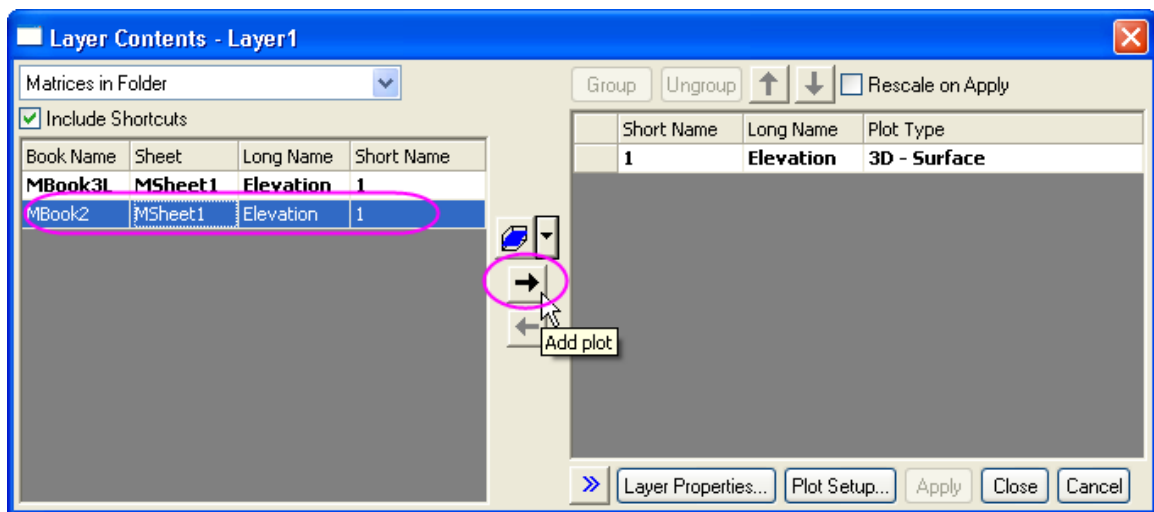

- Double-click on the graph to open the **Plot Details** dialog. If the left panel is not expanded use the  button. This dialog is where the 3D plot will be customized. Select *Layer1* in the left panel, and in the **Axis** tab in the right panel apply the settings shown below:



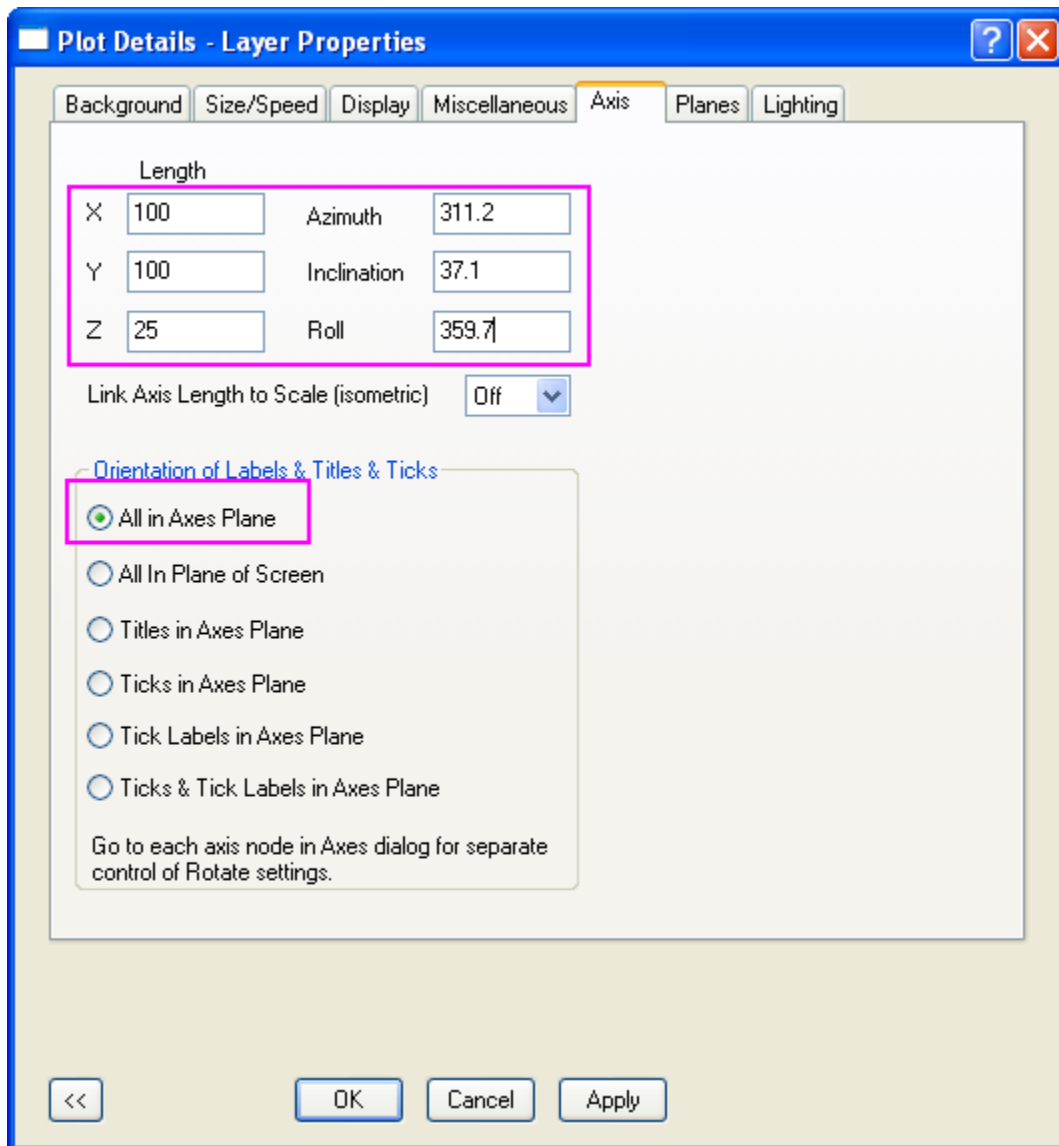

5. Select the first plot in the left panel under the **Layer1** option and in the **Colormap/Coutours** tab, click on the **Level...** header to open the **Set Levels** dialog. In this dialog, apply the settings below:

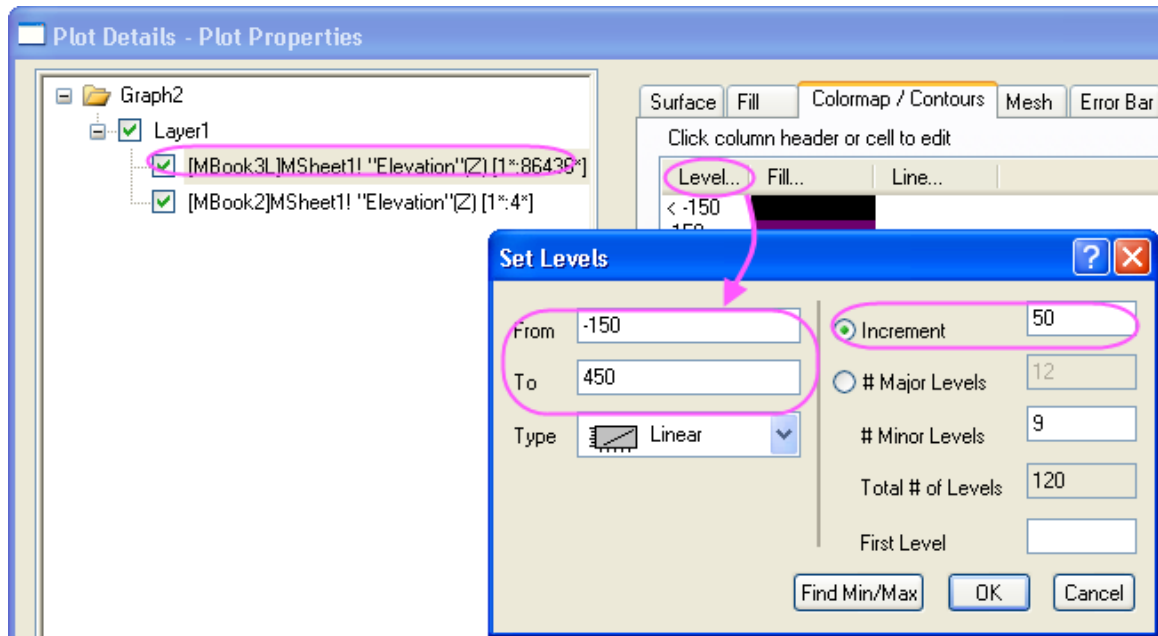

- Use the **OK** button to close the **Set Levels** dialog. Click on the **Fill...** header to open the **Fill** dialog. In the **Fill** dialog, select **Load Palette** and click the **Select Palette** button to select the **Watermelon** palette. Click **OK** to close the **Fill** dialog.

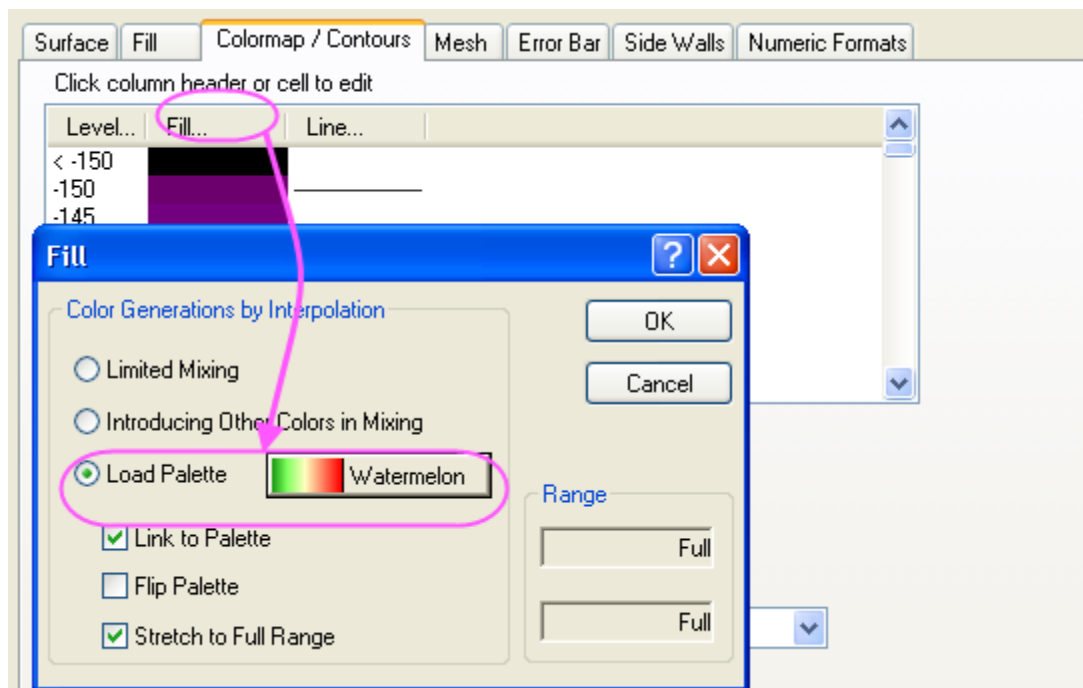

- To remove contours, in the **Colormap/Contours** tab deselect the **Enable Contours** check box as shown below:

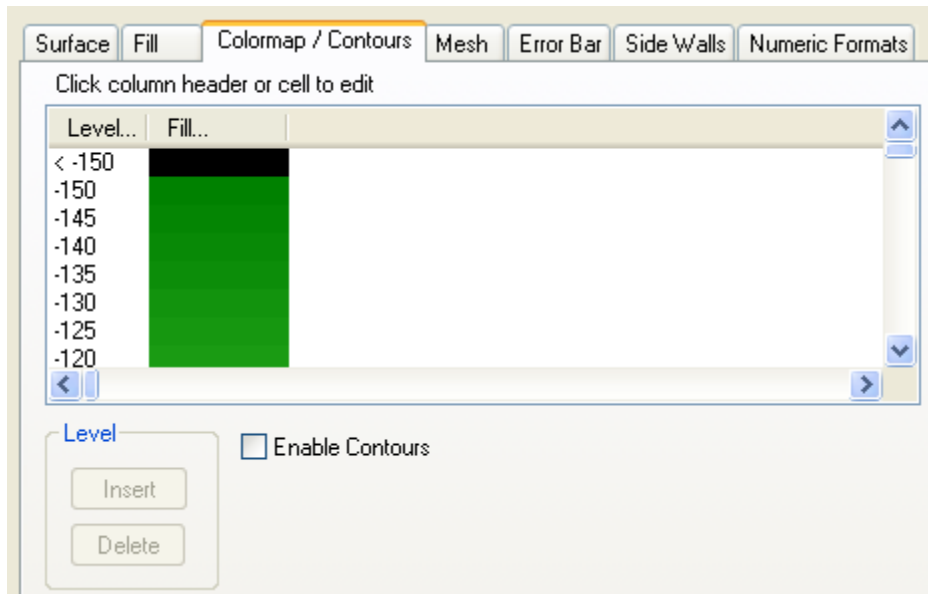

8. To remove the mesh, in the **Mesh** tab, deselect the **Enable** check box as shown below:

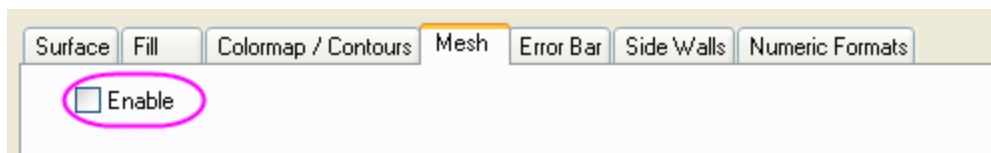

9. In the **Side Walls** tab, check the **Enable** box and set the X and Y side walls as shown below:

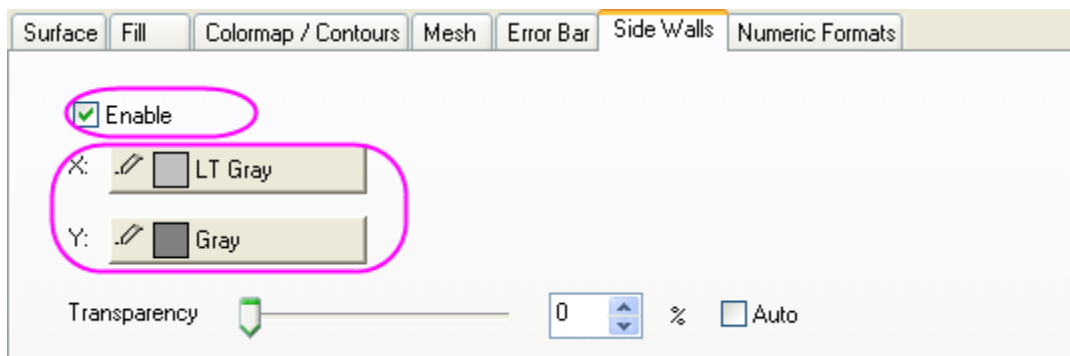

10. In the **Numeric Formats** tab, set **Decimal Places** to **0**.

11. Select the second plot in the left panel and in the **Surface** tab, set the **Transparency** as **48**:

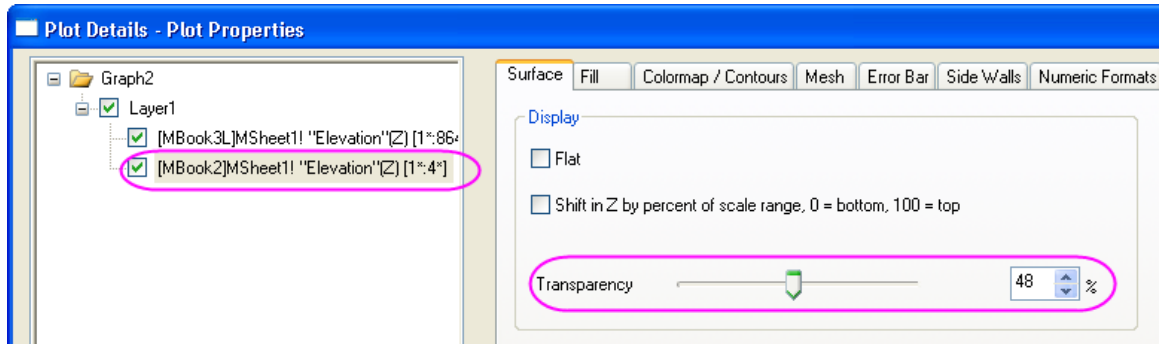

- Open the **Fill** tab of the **Plot Details** dialog, select **Fill piece by piece** and set the color as **Blue**. Click **Apply** to review changes.

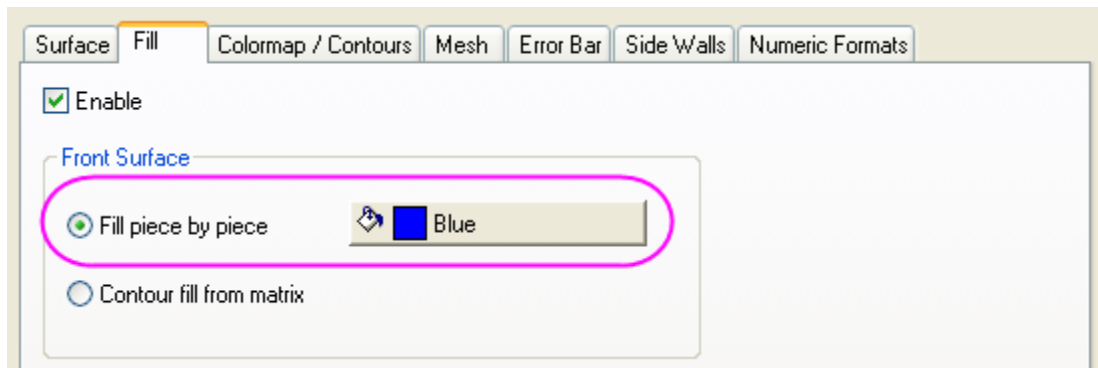

- The next step is to set the lighting effect. Select **Layer1** in the left panel and in the **Lighting** tab, apply the settings shown below:

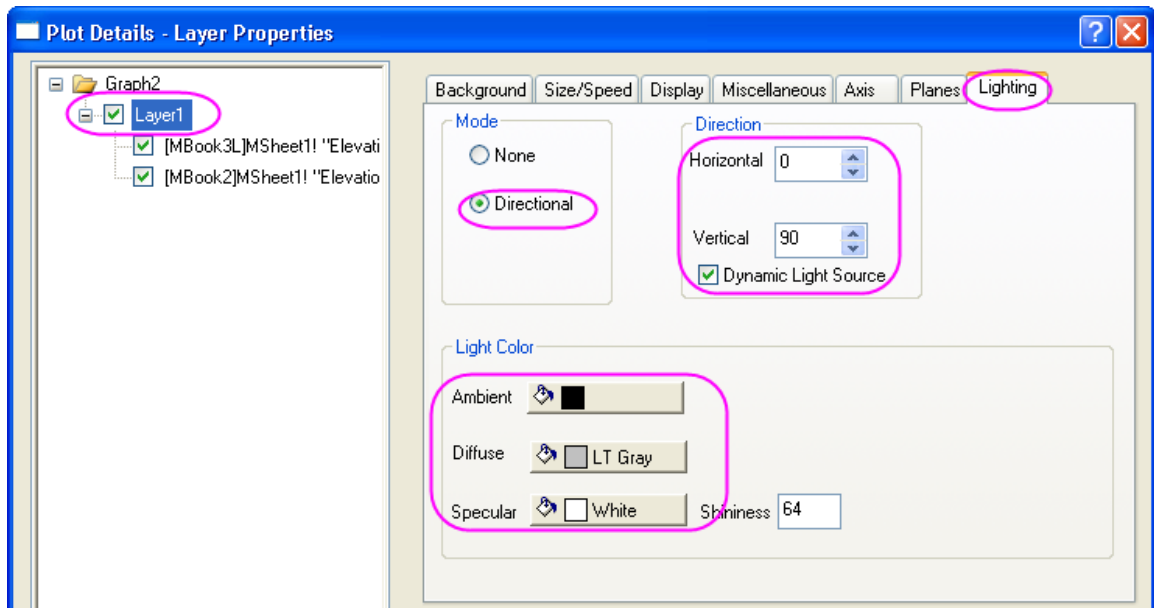

- In the **Planes** tab, deselect the **XY**, **YZ** and **ZX** plane boxes. Click the **OK** button to close the Plot Details dialog.

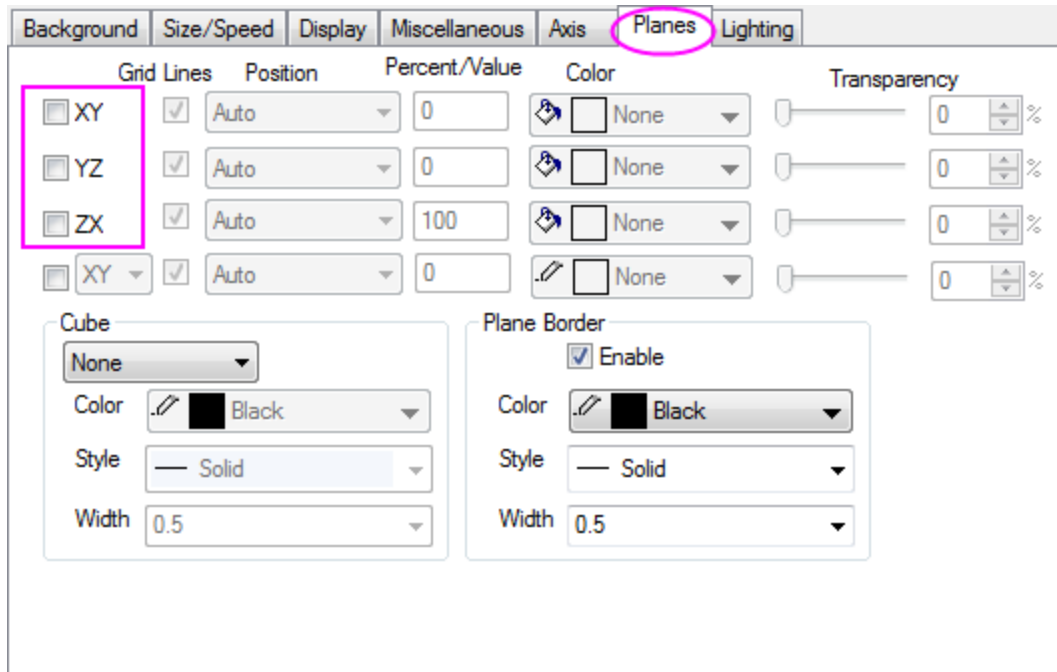

15. The next step is to add a title. Right-click on the blank area of the graph window and select **Add/Modify Layer Title** from the menu that appears, enter *Lake Ontario* as the layer title. Right-click on the title and select **Properties...** from the menu to open the **Object Properties** dialog. In the **Text** tab, set font size to *31*, then go to **Frame** tab and set **Frame** to **Shadow**.

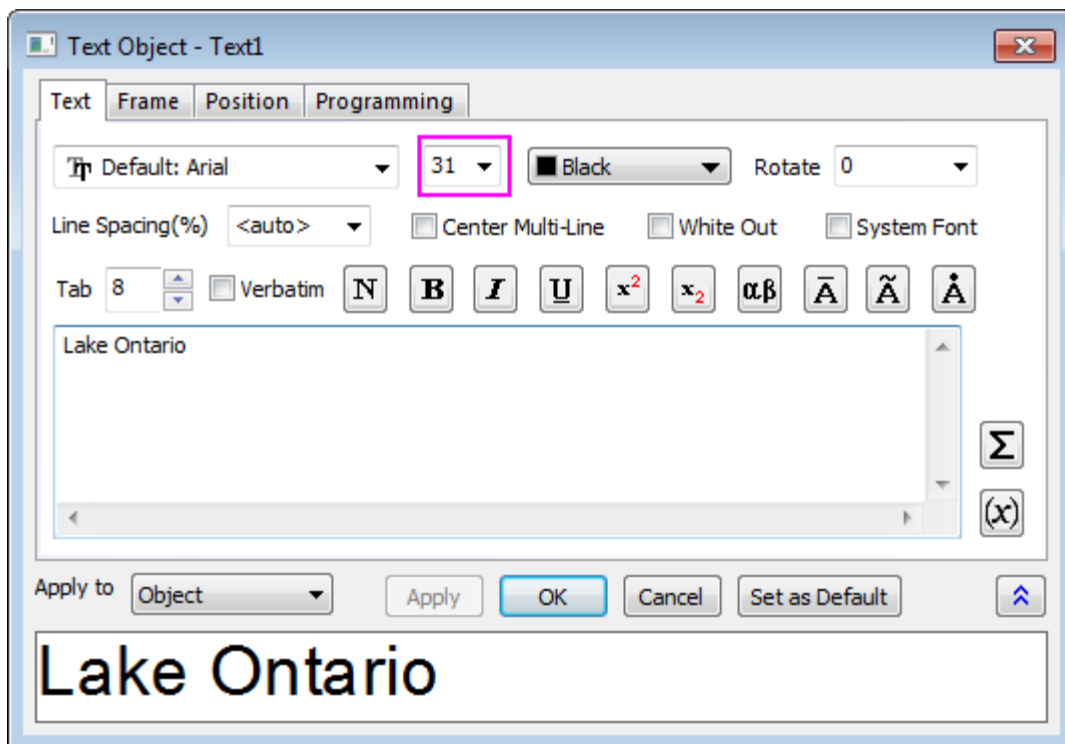

16. To customize the color scale, double-click on the color scale to open the **Color Scale Control** dialog. Select **Line and Ticks** on the left panel, on the right panel, deselect **Show Line and Ticks on the Right** and **Show Border** to hide the line, ticks and border.

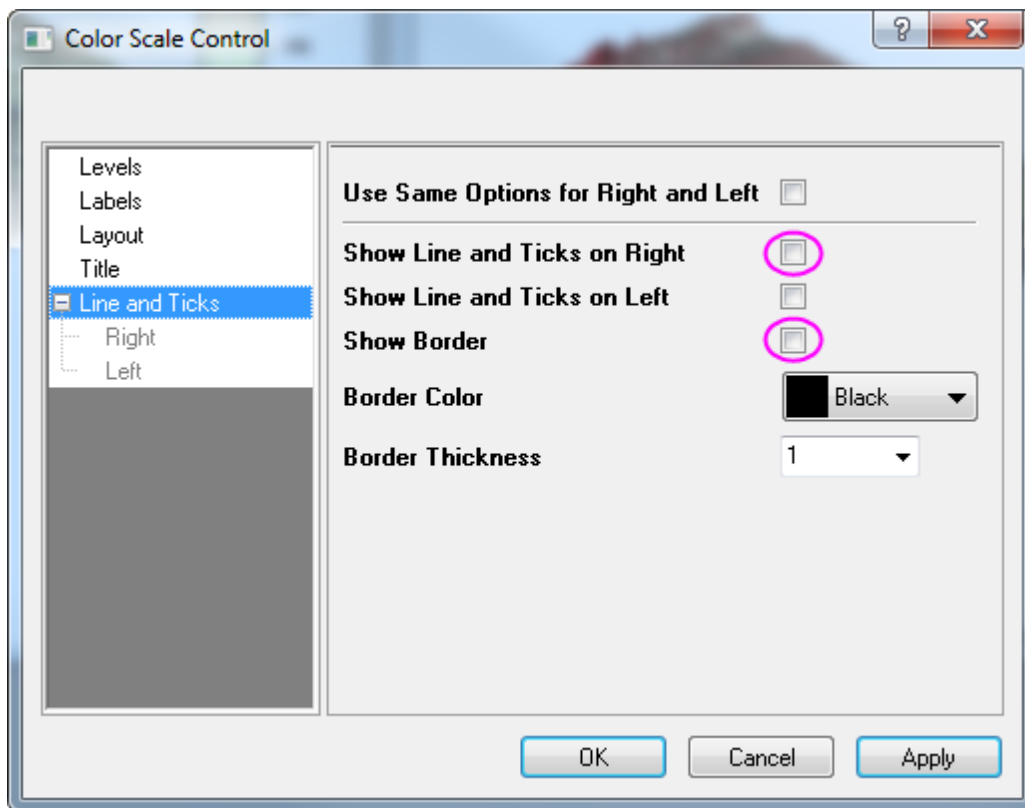

17. Select **Layout** on the left panel, modify **Color Bar Thickness** as *150* to change the width of the color scale, set **Label Offset from Bar Edge** as *0* to move the label closer to the color scale.

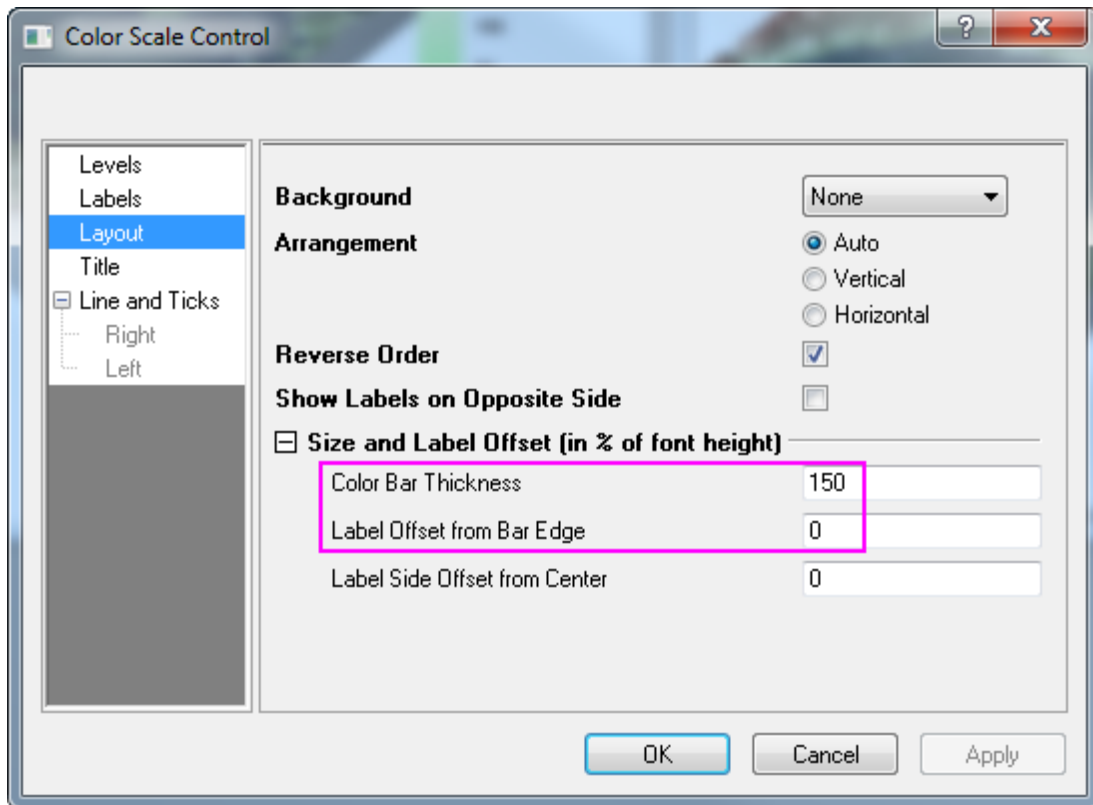

18. Select **Title** on the left panel, on the right select **Show** to display the title, and add (*m*) at the end of the **Title** text box to display the title as *Elevation(m)* for the color scale. Change **Size** under the **Font** branch as 18. Click **OK** to apply the settings and close the dialog.

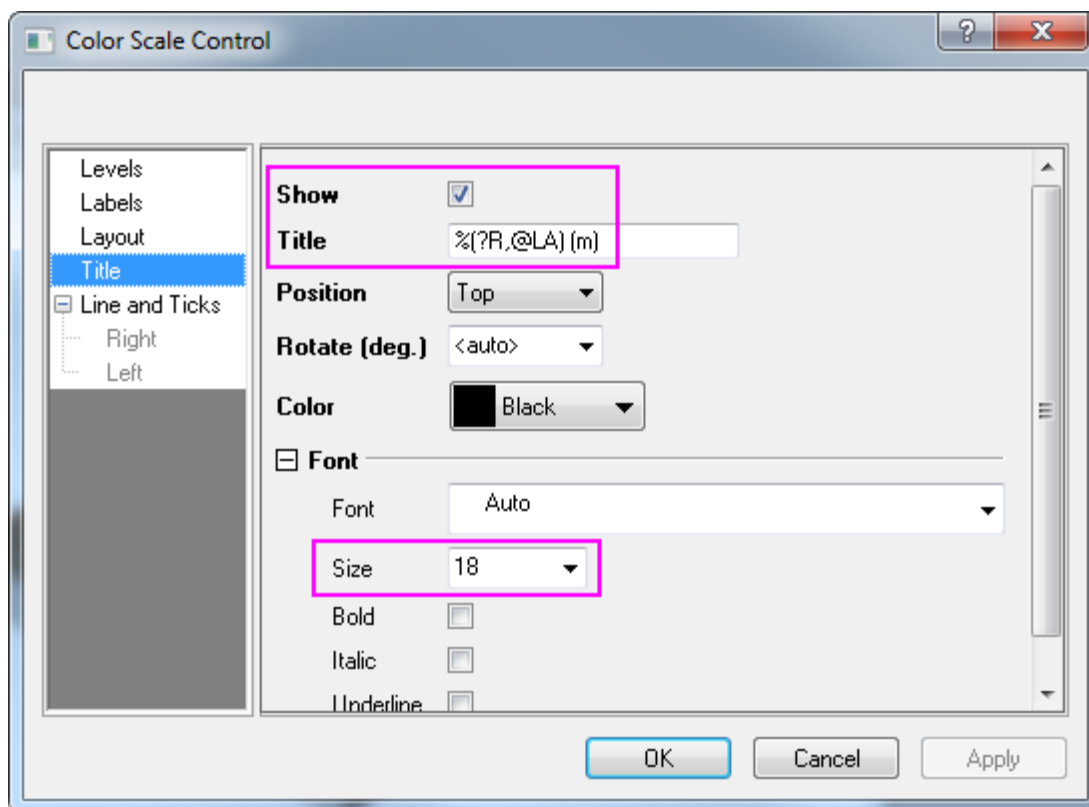

19. You can double click the color scale title to activate the in-place edit mode, place the cursor after  $\%(?R,@LA)$  and press ENTER on the keyboard to start a new line for  $(m)$ . The complete graph should appear as shown below:



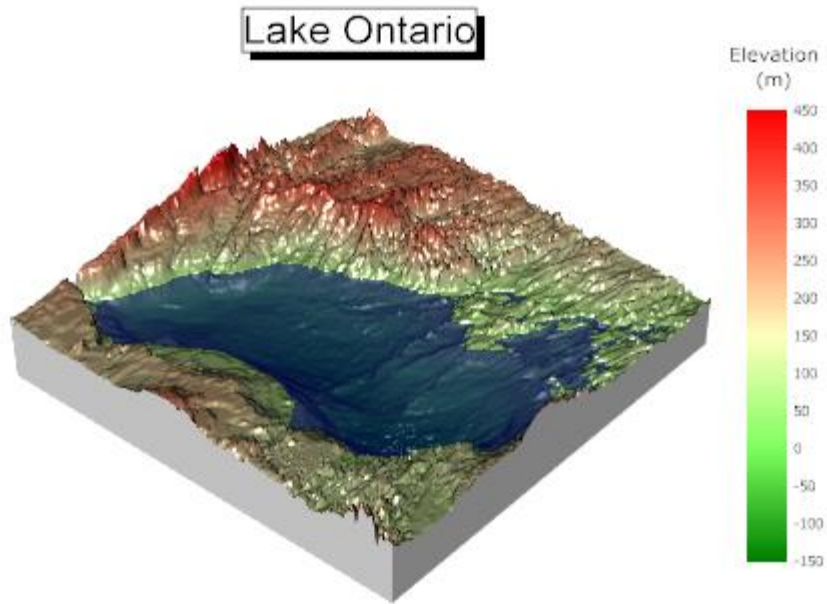

### 6.13.18 3D Bar on Flatten Surface

This graph is a combination of a flattened 3D surface of US Map with state divisions and 3D bars representing the city populations, the bars locate the longitude and latitude of the cities.

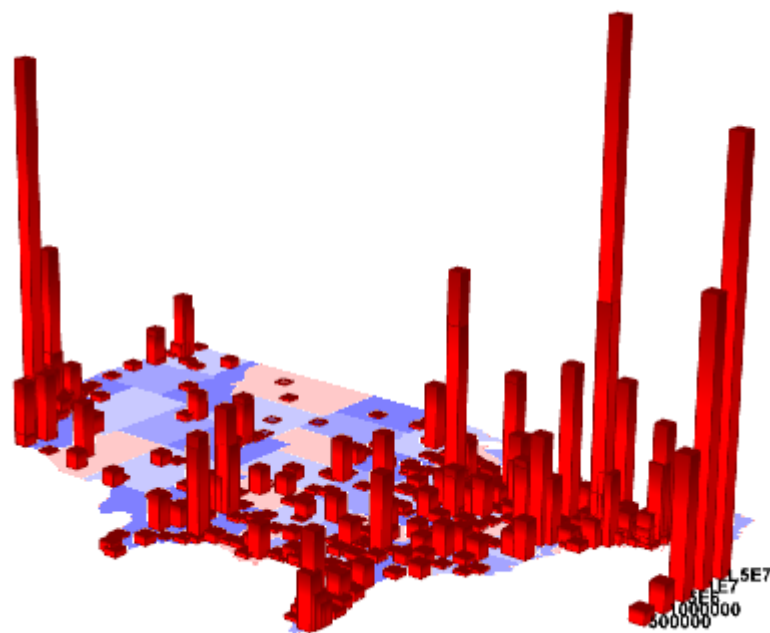

Minimum Origin Version Required: Origin 9.0 SR0

### 6.13.18.1 What you will learn

This tutorial will show you how to:

- Plot a flattened 3D surface.
- Add a 3D bar graph to an existing 3D surface graph.

### 6.13.18.2 Steps

This tutorial is associated with the **Tutorial Data** project: <Origin EXE Folder>\Samples\Tutorial Data.opj.

1. Open the **Tutorial Data** project and browse to folder *3D Bar on Flat Surface* in **Project Explorer**.
2. Activate **MBook1E**, select **Plot> 3D : 3D Colormap Surface** from the main menu. A graph window will be generated.

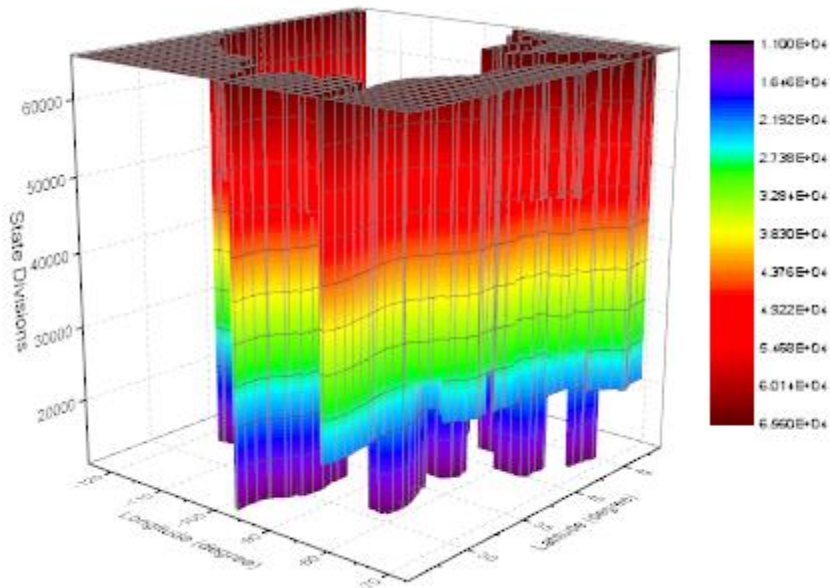

3. Double-click on the graph to open the **Plot Details** dialog. In the Surface tab, check **Flat** and **Shift in Z**, set the **Z offset** to 0 and the **Transparency** to 50.

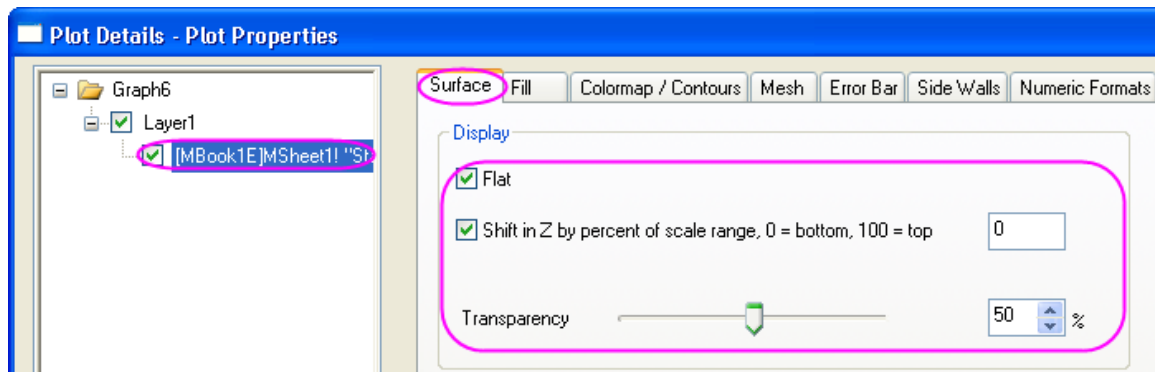

- Go to the **Colormap/Contours** tab, click on the **Level...** header to open the **Set Levels** dialog. In this dialog, set the **Major Levels** to 8, **Minor Levels** to 0.

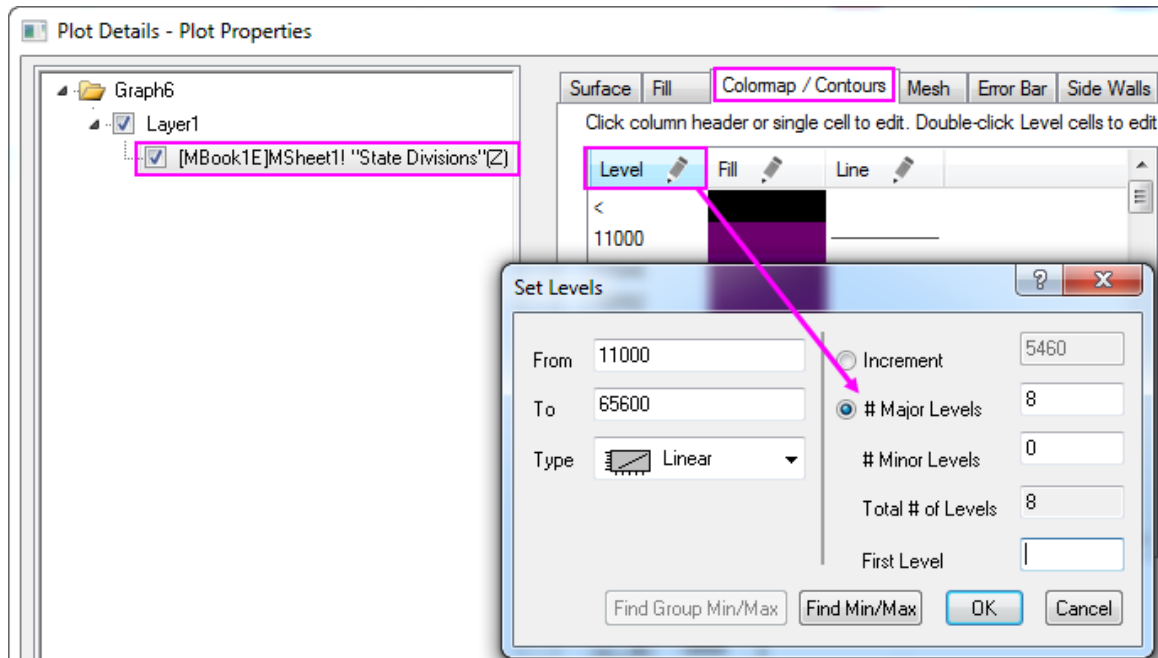

- Click the **OK** button to close this dialog. Click on the **Fill...** header to open the **Fill** dialog. In the **Fill** dialog, select **Load Palette**, click **Select Palette** button to select *Thermometer* palette and uncheck the **Link to Palette** check box.

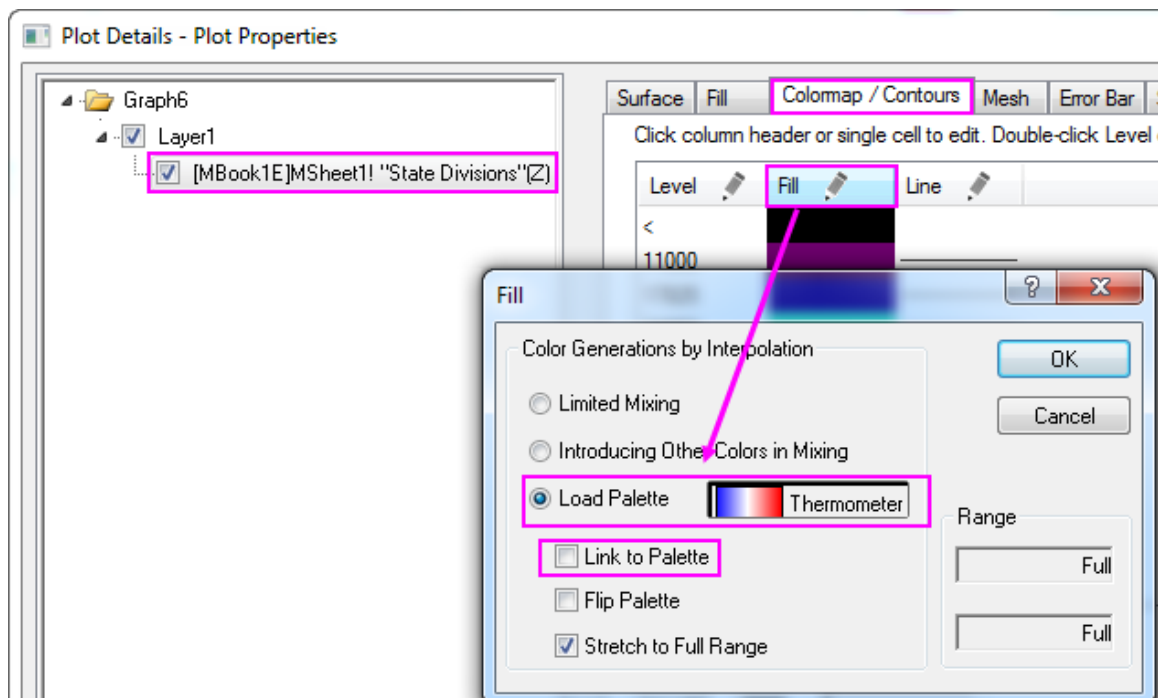

6. Click **OK** button to close the **Fill** dialog. Click the fill cell of last level and set its color as White.

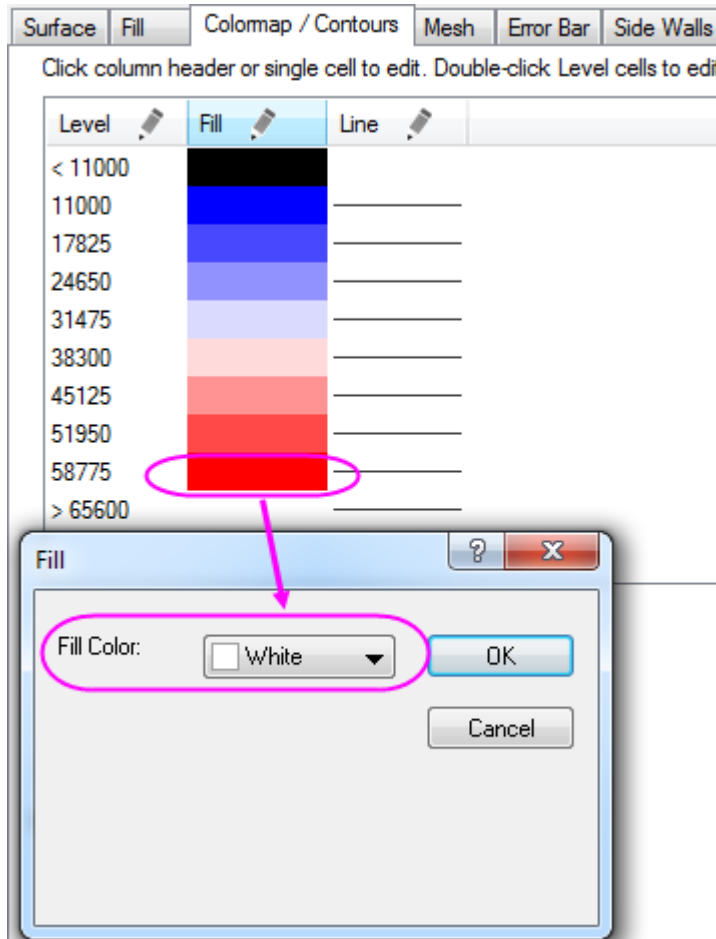

- Uncheck the **Enable Contours** in the **Colormap/Contours** tab.

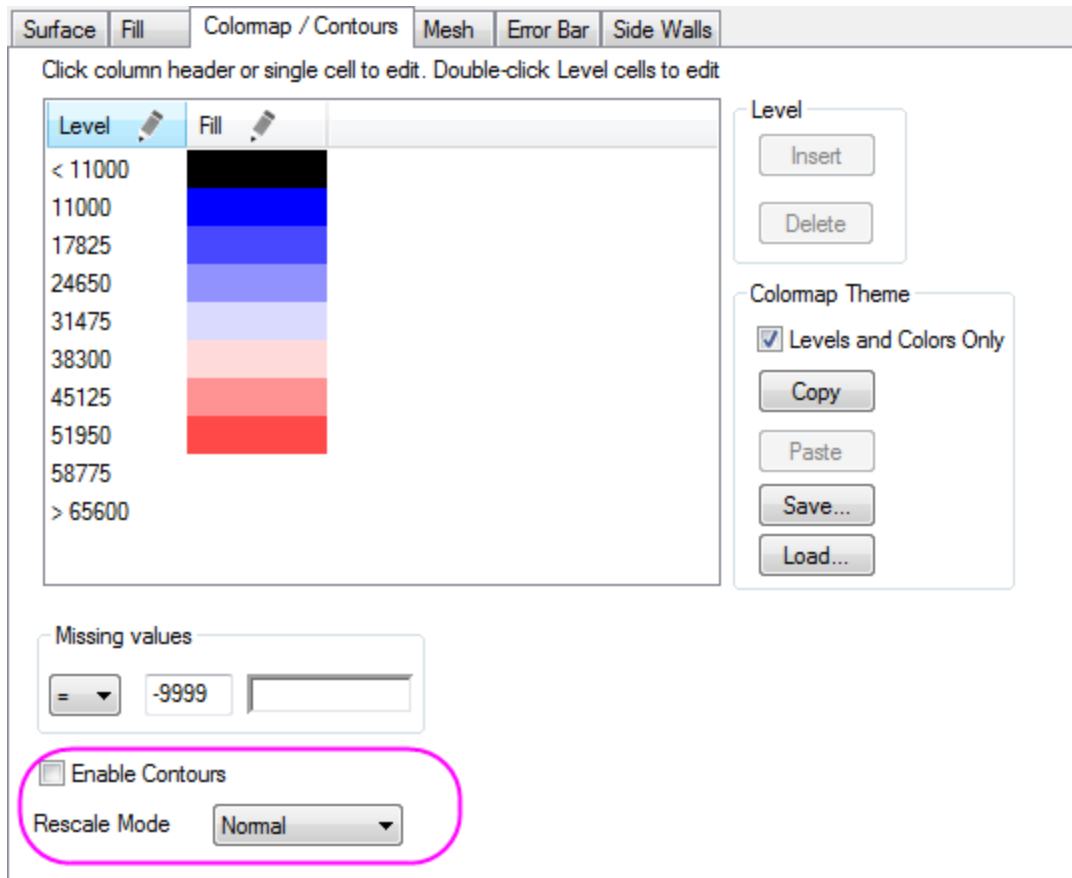

- Go to **Mesh** tab, uncheck the **Enable** check box.

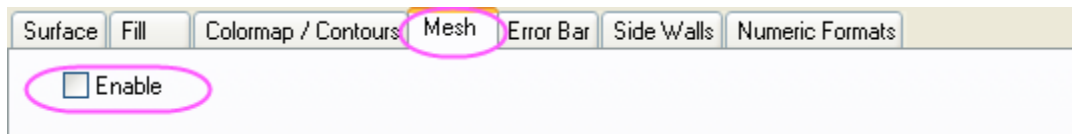

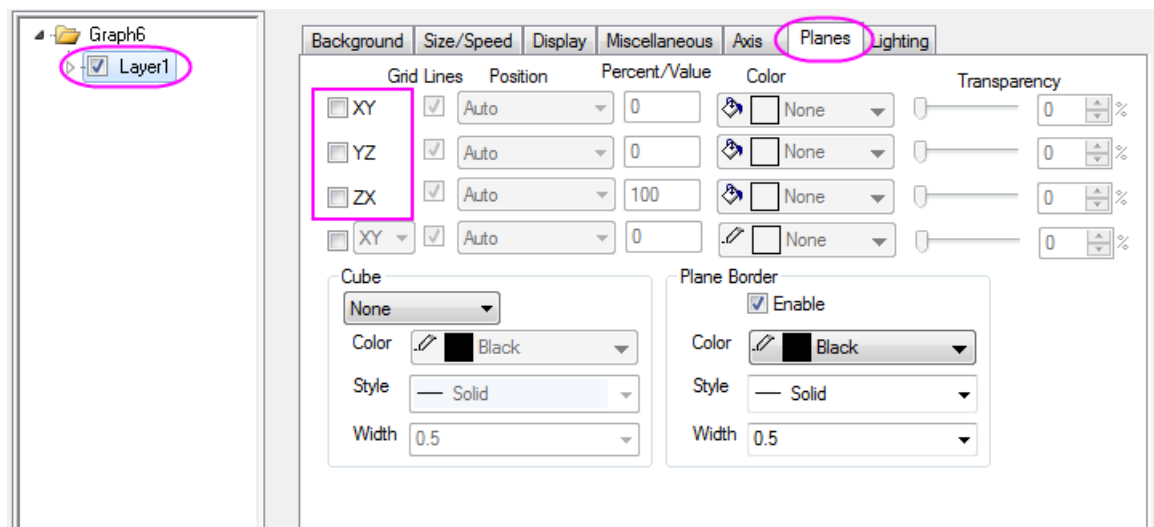

- Select **Layer1** in the left panel, go to the **Planes** tab in the right panel. Uncheck the **XY**, **YZ**, and **ZX** check boxes.

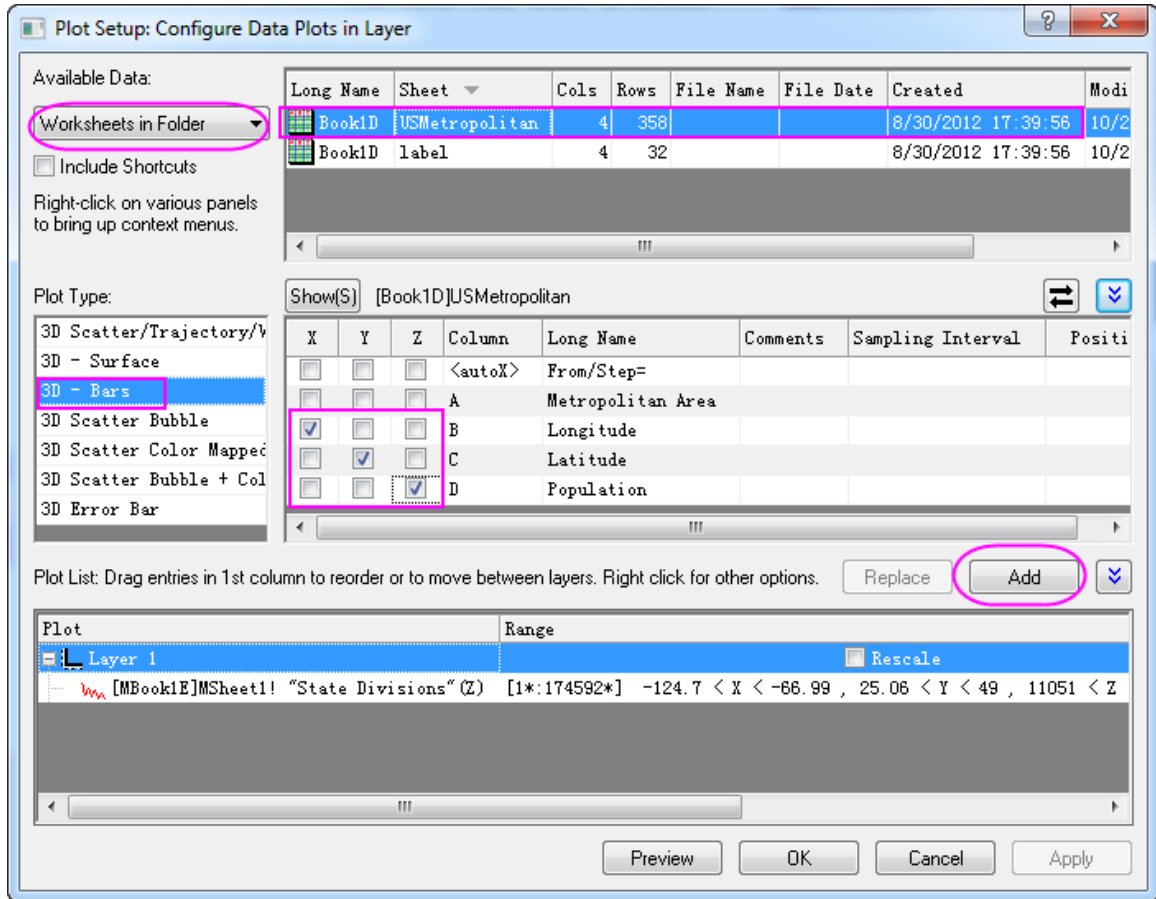

- Click **OK** to close the **Plot Details** dialog. Right-click on the layer icon and choose **Plot Setup** from the menu. In the **Plot Setup** dialog, choose **Worksheets in Folder** for Available Data, **3D-Bars** as Plot Type and **USMetropolitan** as the data source sheet. Set Longitude, Latitude, and Population as X, Y, Z respectively. Click **Add** to add the 3D bar graph to the current layer.



In order to show all three panels in **Plot Setup** dialog, please expand **Plot Type** panel by clicking  and expand **Available Data** panel by clicking  again.

Please refer to [Plotting using Plot Setup](#) for more information.

- Click **OK** to close the **Plot Setup** dialog. Select **Graph: Rescale to Show All** to rescale the graph.

12. Double-click on the 3D bar graph to open the **Plot Details** dialog. In the **Pattern** tab, set the color of **Border** and **Fill** as red, and set **Gradient Fill** as shown below.

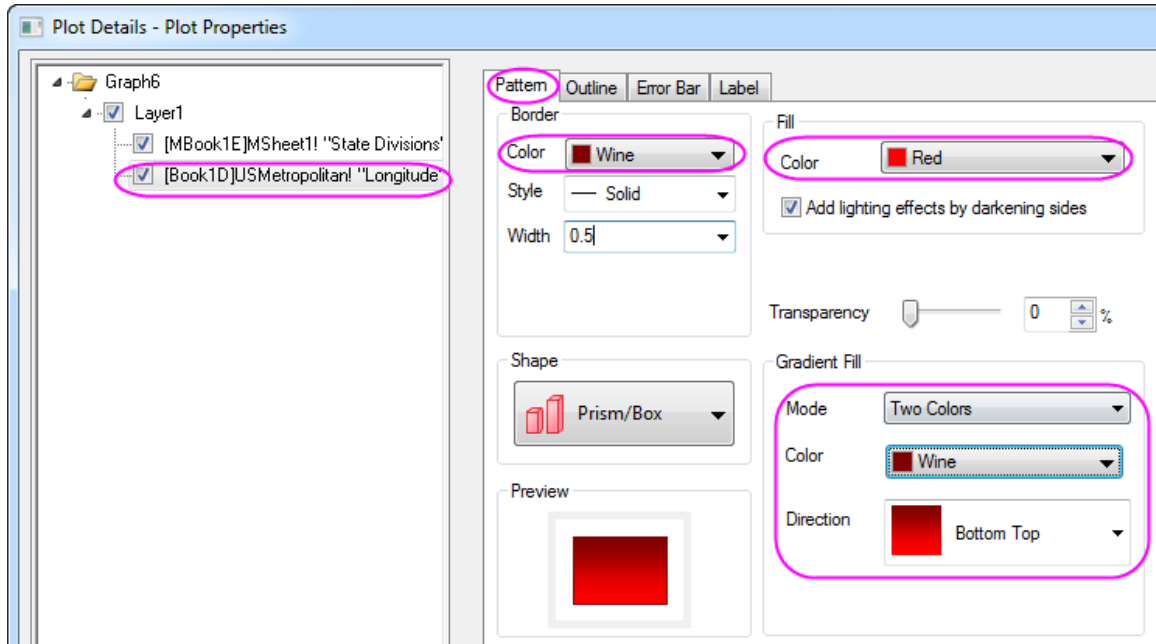

13. Click **OK** to close the **Plot Details** dialog. On the graph window, right-click on the layer icon and select **Layer Contents...** from the context menu to open the **Layer Content** dialog. In this dialog, select **Worksheets in Folder** for the top-left drop-down list, add col(C) and Col(D) in Sheet **Label** as a 3D bar graph and a 3D scatter respectively to the current layer.

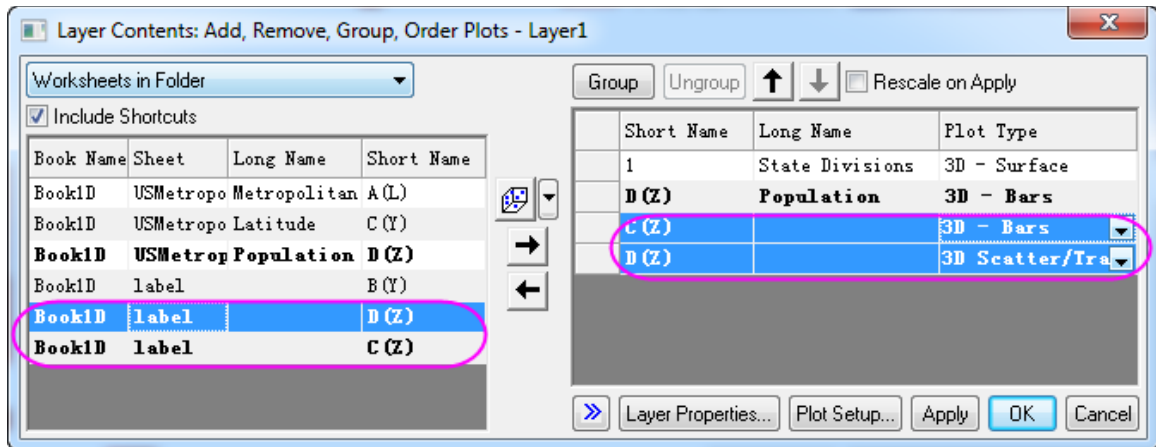

14. Click **OK** to close the **Layer Content** dialog. Double-click on the 3D bar graph to open the **Plot Details** dialog. Select the third plot in the left panel, and go to the **Pattern** tab, apply the settings given below.

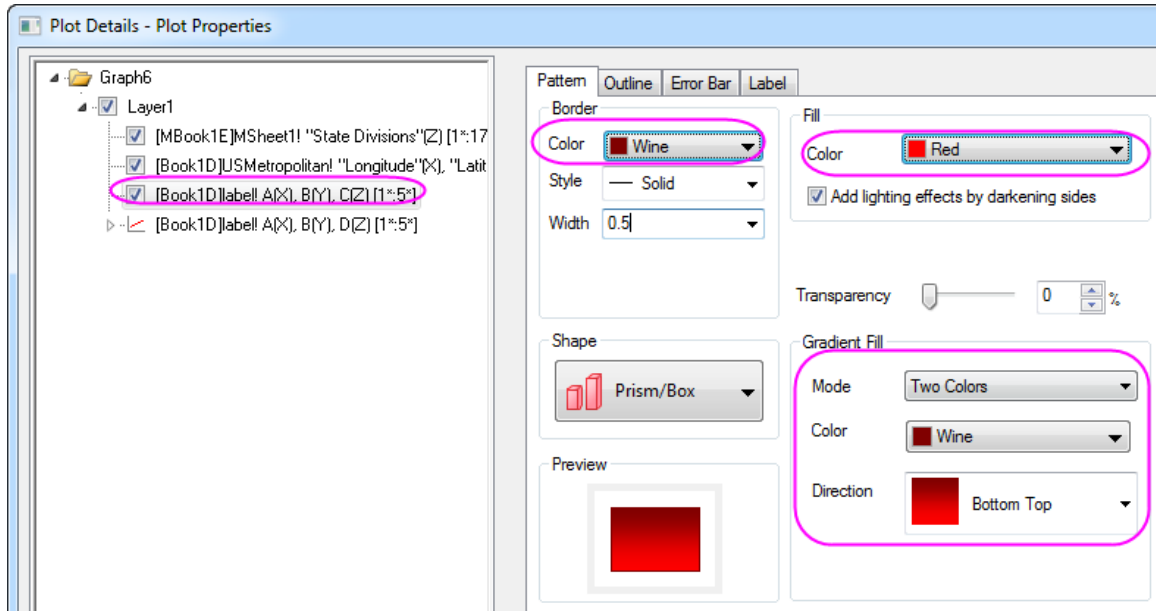

15. Go to the **Outline** tab, set the **Width(in%)** to 15 as below.

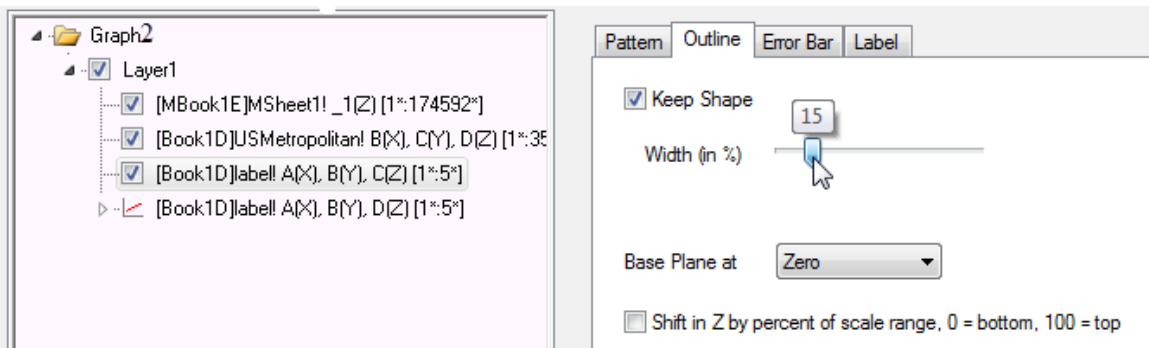

16. Select the fourth plot in the left panel, go to the **Label** tab and apply the settings below.

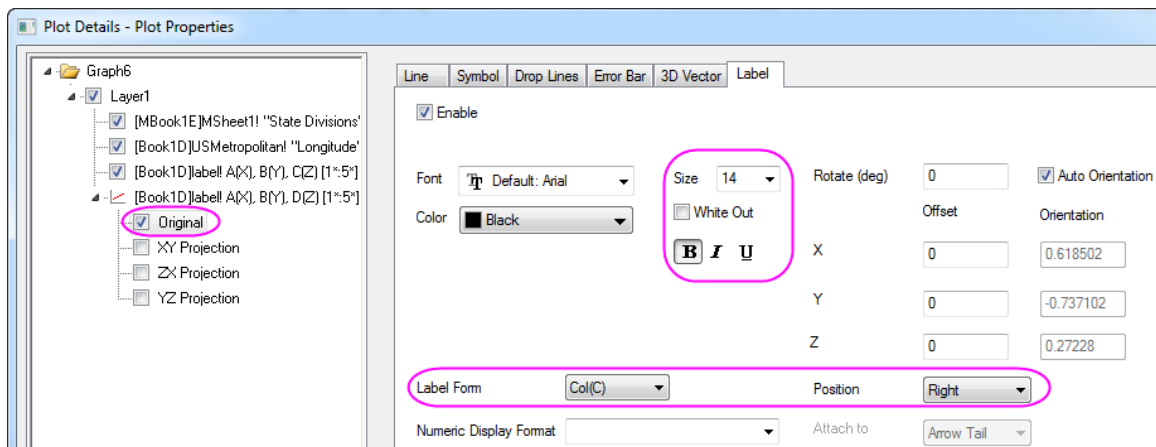



17. Finally, you will get the graph shown below.

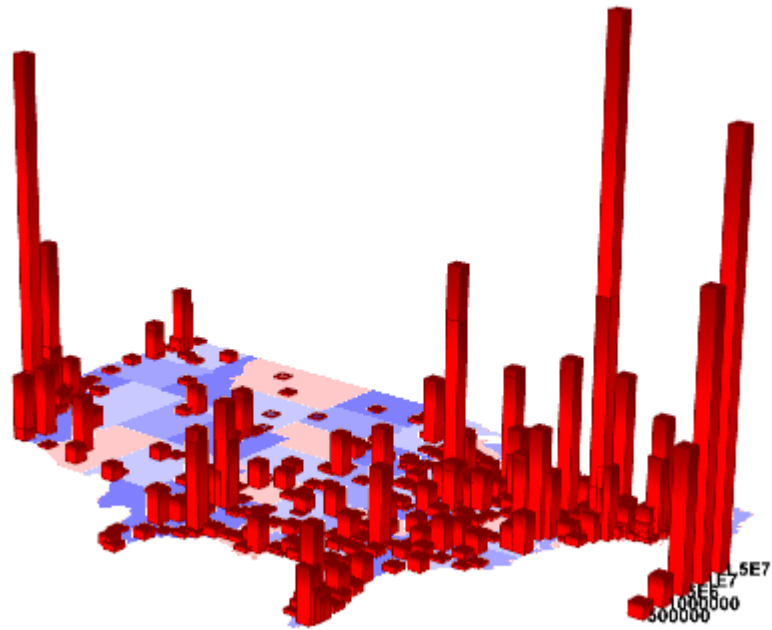

### 6.13.19 3D Surface with Point Label

#### 6.13.19.1 Summary

This tutorial will demonstrate how to add a 3D Scatter to a 3D Surface and include labels as shown below:

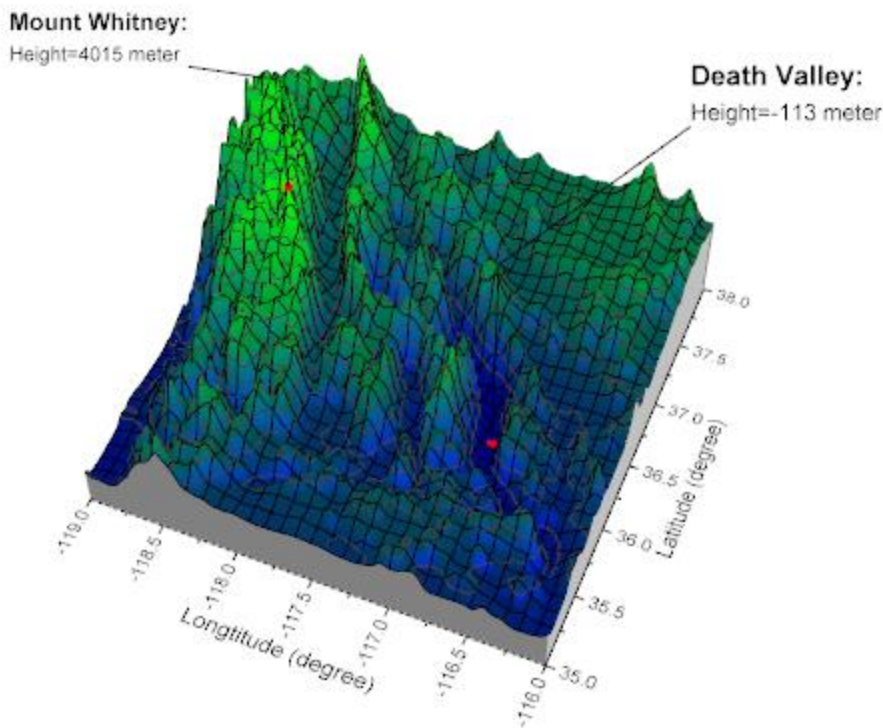

Minimum Origin Version Required: Origin 2015 SR0

### 6.13.19.2 What you will learn

This tutorial will teach you how to:

- Create the 3D Surface with side walls
- Add a 3D scatter to the 3D Surface and include labels
- Change the label position in 3D graphs
- Add a line to connect the symbol and the label

### 6.13.19.3 Steps

#### 6.13.19.3.1 Create the 3D Surface with side walls:

This tutorial is associated with <Origin EXE Folder>\Samples\Tutorial Data.opj.

Also, you can refer to this graph in Learning Center. (Select **Help: Learning Center** menu or press **F11** key , and then open **Graph Sample: 3D Surface**)

1. Open **Tutorial Data.opj** and browse to the **3D Surface with Point Label** folder in **Project Explorer** (PE).
2. Activate **MBook4**, and highlight everything. Select **Plot > 3D : 3D Colormap Surface** from the main menu. A 3D Colormap graph will be generated as shown below:

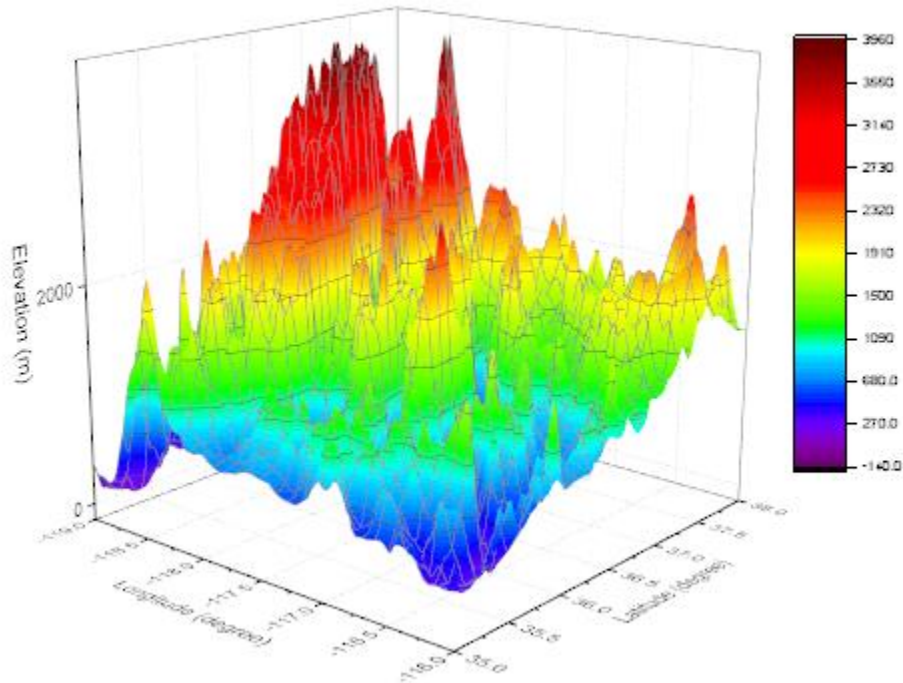

3. Select **Format: Axes: Z Axis...** in the menu to open the **Axes** dialog. (Or double-click one of the axes on the graph). Set Z axis scale **From: -500** and **To: 8000**. Click **OK**.

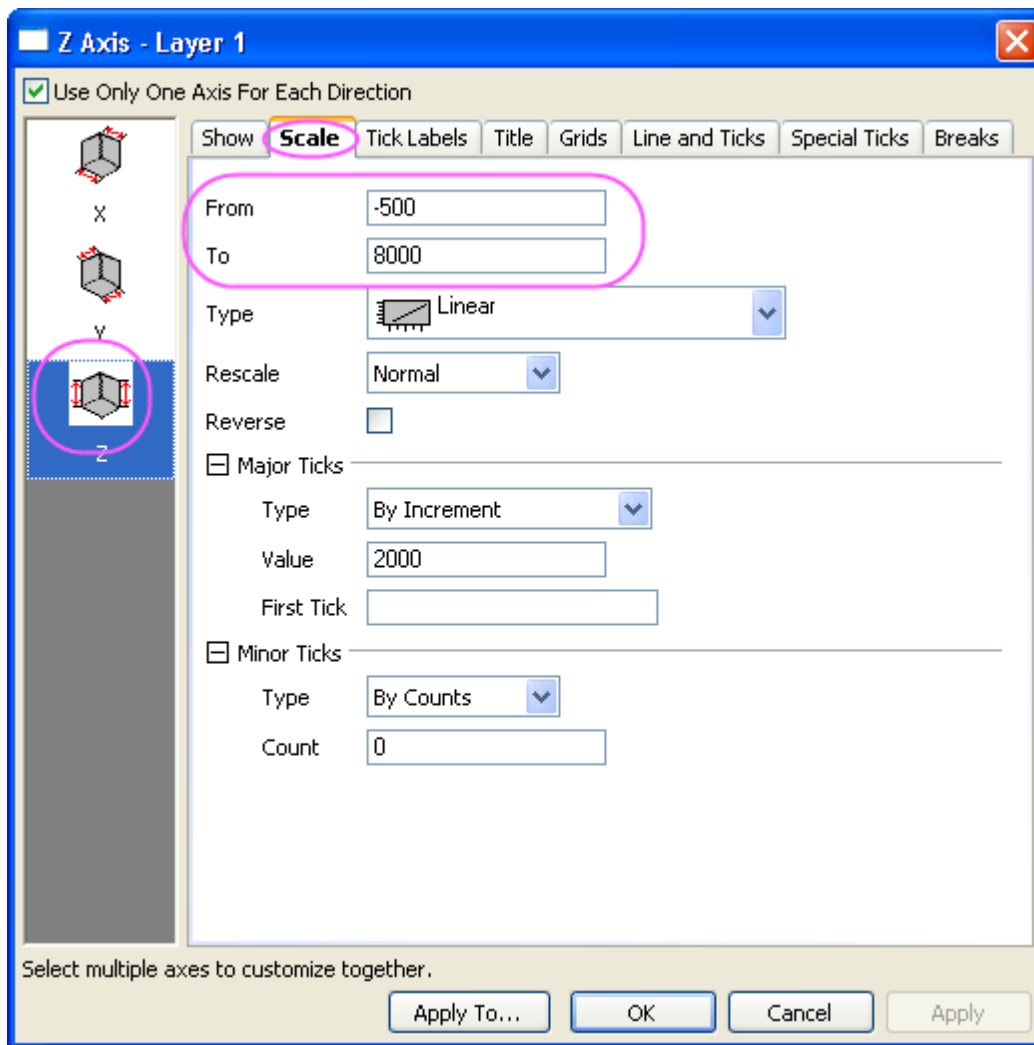

4. Select **Format: Plot** in the menu to open the **Plot Details** dialog. (Or double click anywhere on the

graph). If the left panel is not expanded use the  button on the bottom left of the dialog to expand it and select the first option under **Layer1**. In order to create and customize side walls, in the **Side Walls** tab, check the **Enable** box. Change the color of **X** and **Y** side walls to **Gray** and **LT Gray**.

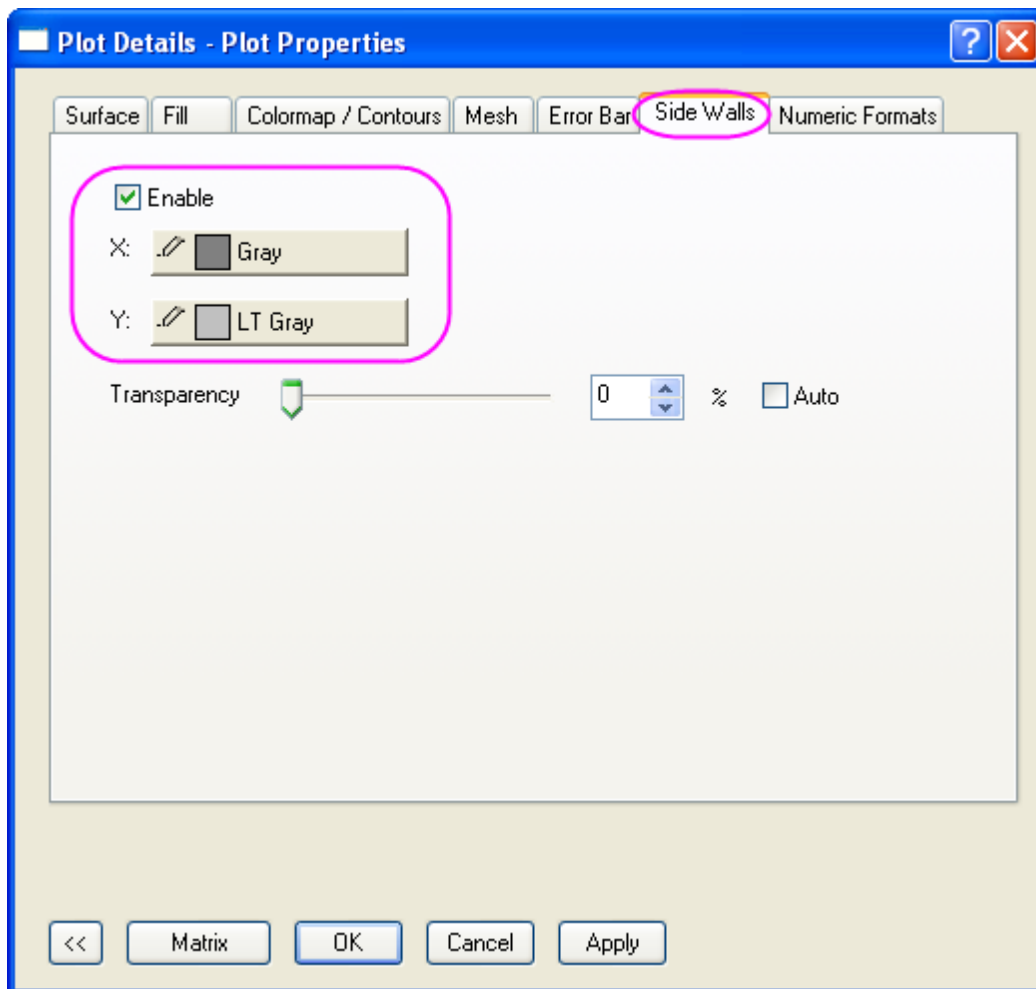

5. To adjust the color scale, in the **Colormap/Contour** tab, click on the **Fill** column header to open the dialog. Select the **Limited Mixing** option, and set **From: Blue** and **To: Green** as shown below. Click the **OK** button to close the **Fill** dialog.

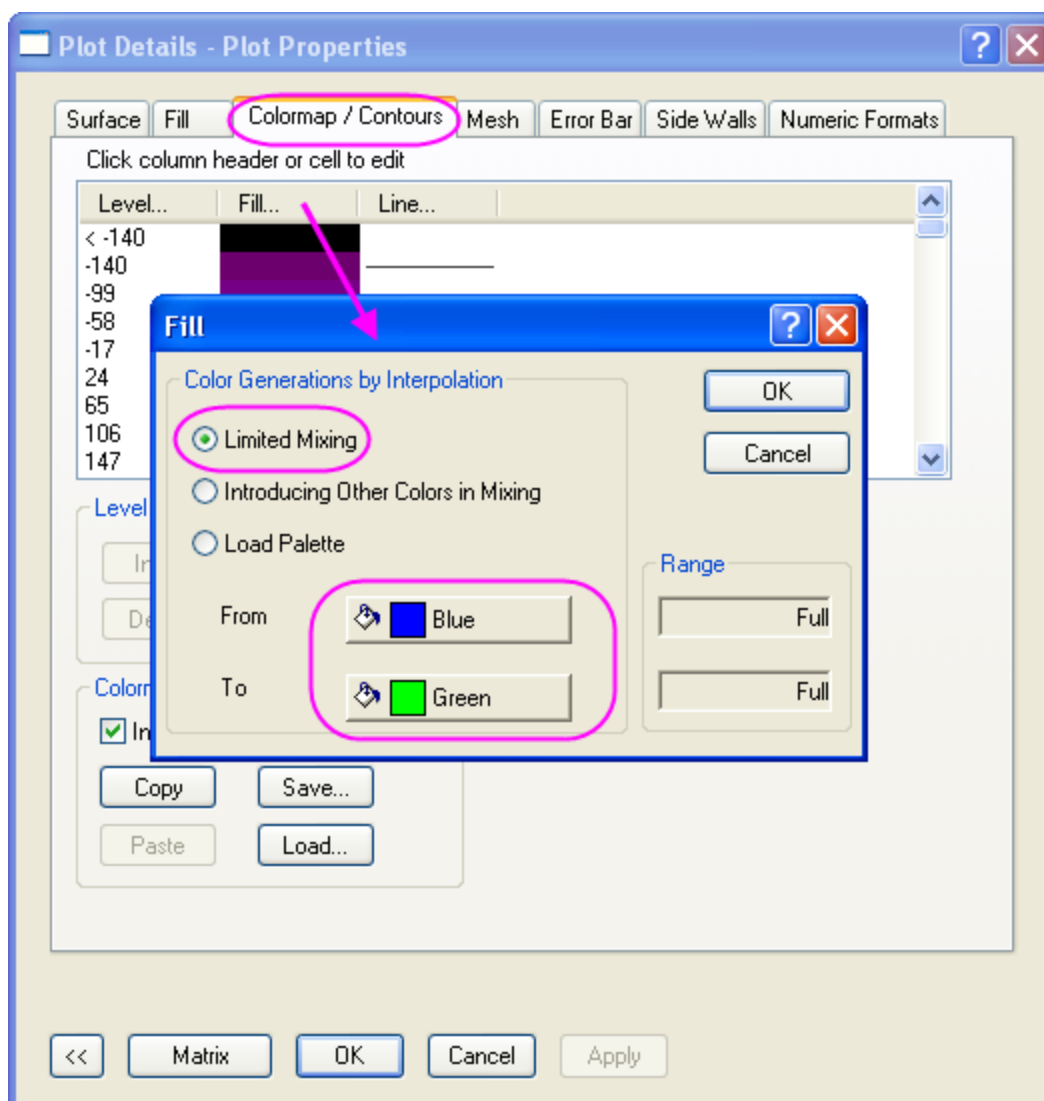

6. In the **Mesh** tab, select color of **Major Minor Lines** as **Black** and select apply **Apply**.

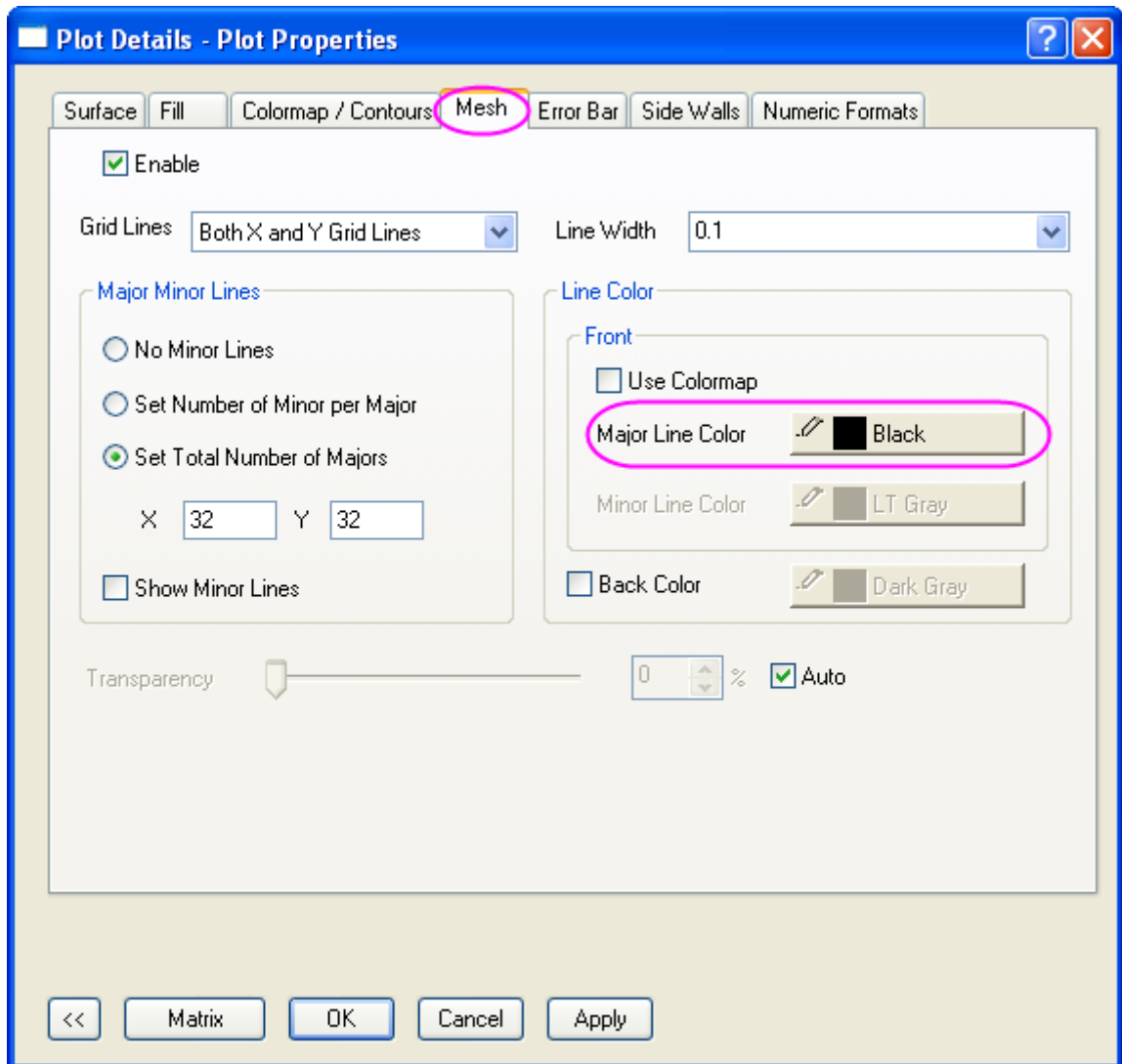

7. The next step is to add and customize the lighting effect. In the same **Plot Details** dialog, expand the left panel and select **Layer 1**. In the **Lighting** tab, choose the **Directional** Mode, enter **279** and **-3** in the **Horizontal** and **Vertical** boxes respectively. Set the **Ambient** color to **LT Yellow**.

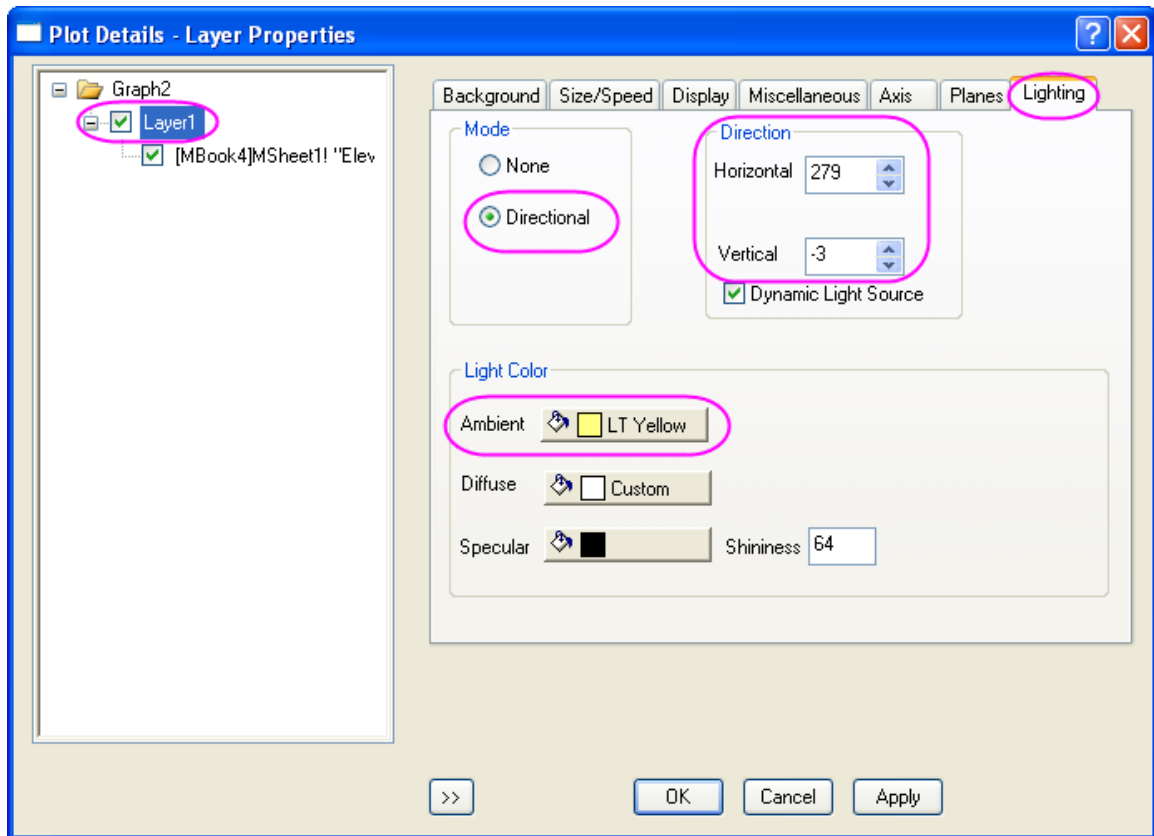

8. To adjust the planes, in the **Planes** tab deselect the **YZ** and **ZX** boxes to hide the two planes in the graph. Click the **OK** button.



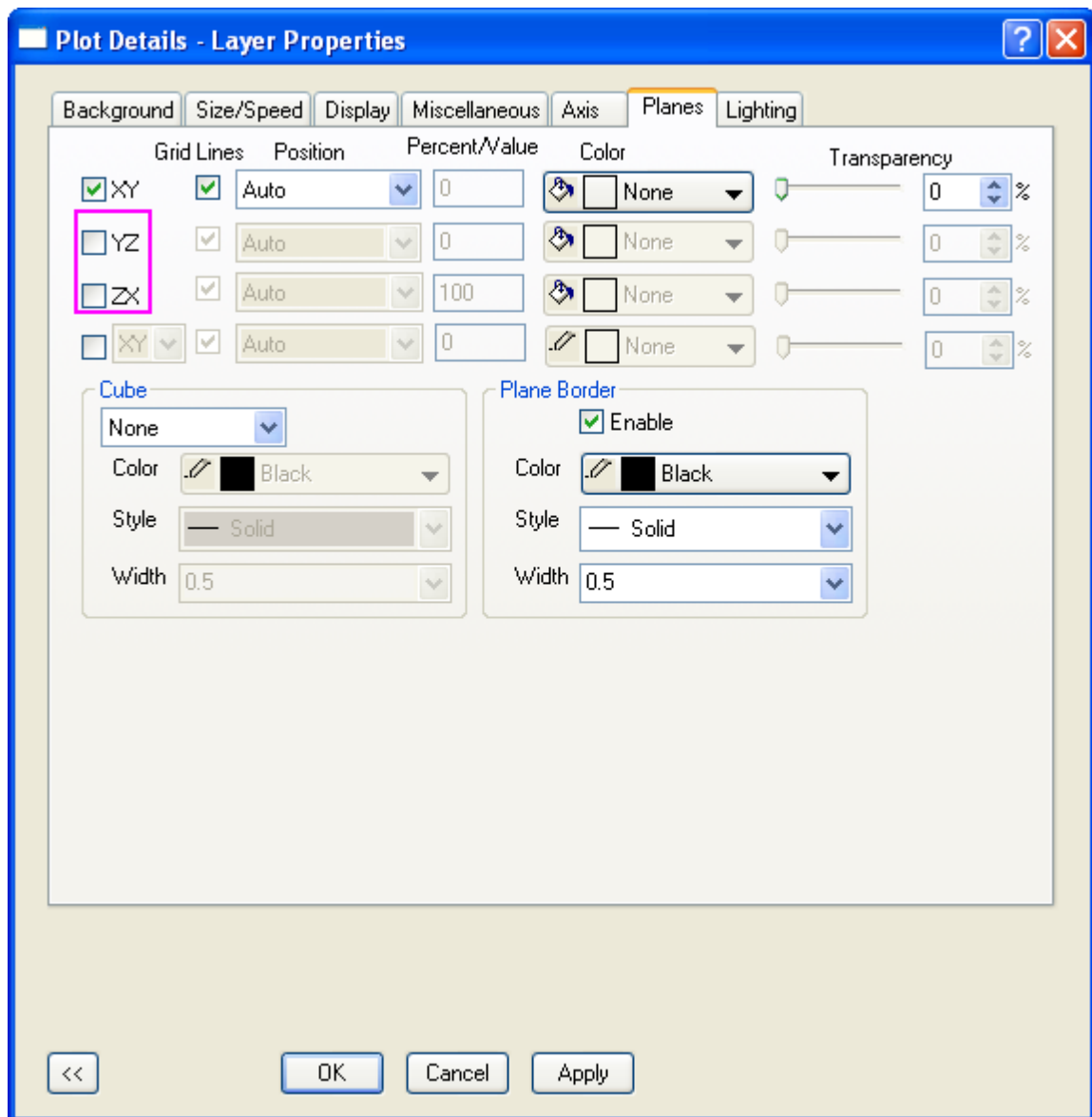



#### 6.13.19.3.2 Add the 3D scatter in the 3D Surface with labels:

1. In order to add symbols in the desired position on the 3D graph, select **Graph: Layer Contents** from the main menu to open the **Layer Contents** dialog (Or double click on the layer icon **1** on the top left of the graph). In the dialog that appears, select **Worksheet in Folder** from the drop-down on the top left.

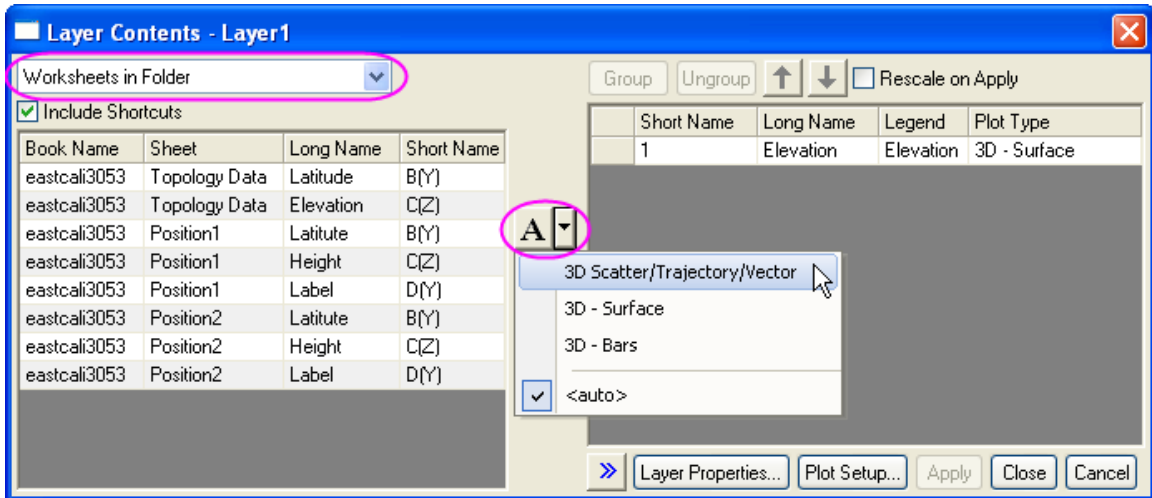
- Click on the **Plot Type** button shown below to specify **3D Scatter/ Trajectory/ Vector** as the plot type:



- To shift components from the left panel to the right panel, holding down the Ctrl key, select two **Height** columns in the left panel and click on the **Add plot** button . This will add the two columns to Layer1. Click the **OK** button.

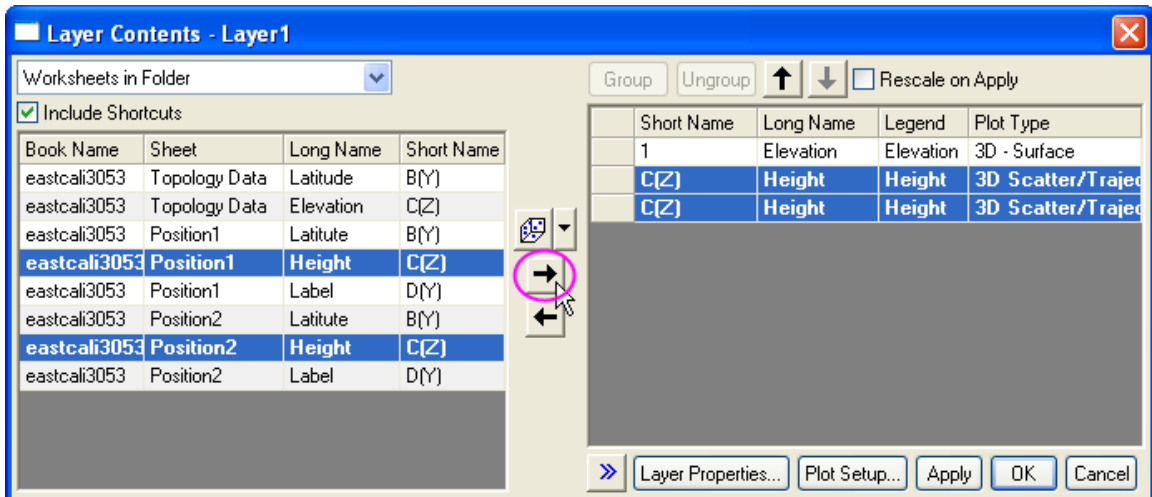

Use the  **Rotate Tool** button on the **Tools** toolbar or hold down the **R** key and use the mouse to rotate the graph. You can find two red symbols are added to the 3D surface and the graph will appear as shown below:

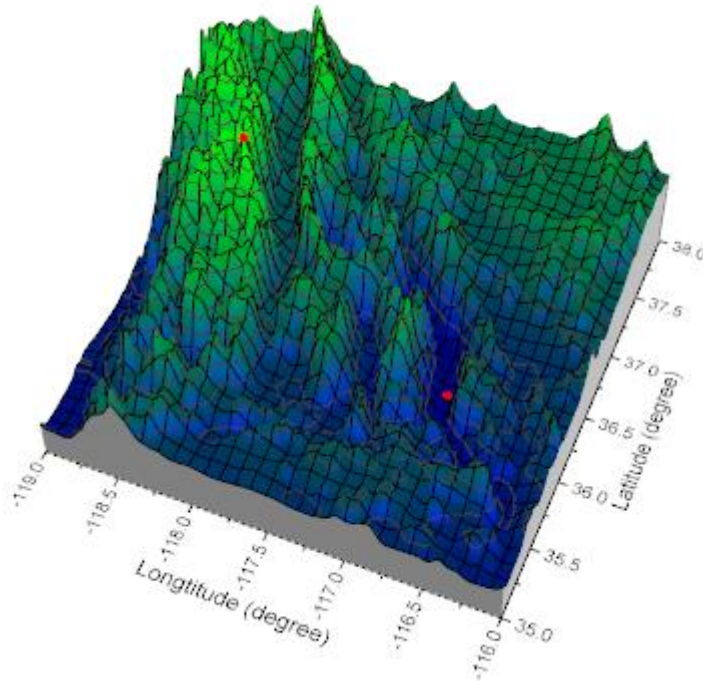

4. To add labels and leader lines to the two symbols, double click on either one to open the **Plot Details** dialog. Make sure the left panel of the **Plot Details** dialog box is expanded and displaying **Original** under the *Position1* plot-level. In the **Label** tab check the **Enable** box. In the **Label From** drop-down list, select **col("Label")** as the label source. Specify the **Offset**, **Position** and **Leader Line** for the label as shown in the image below:

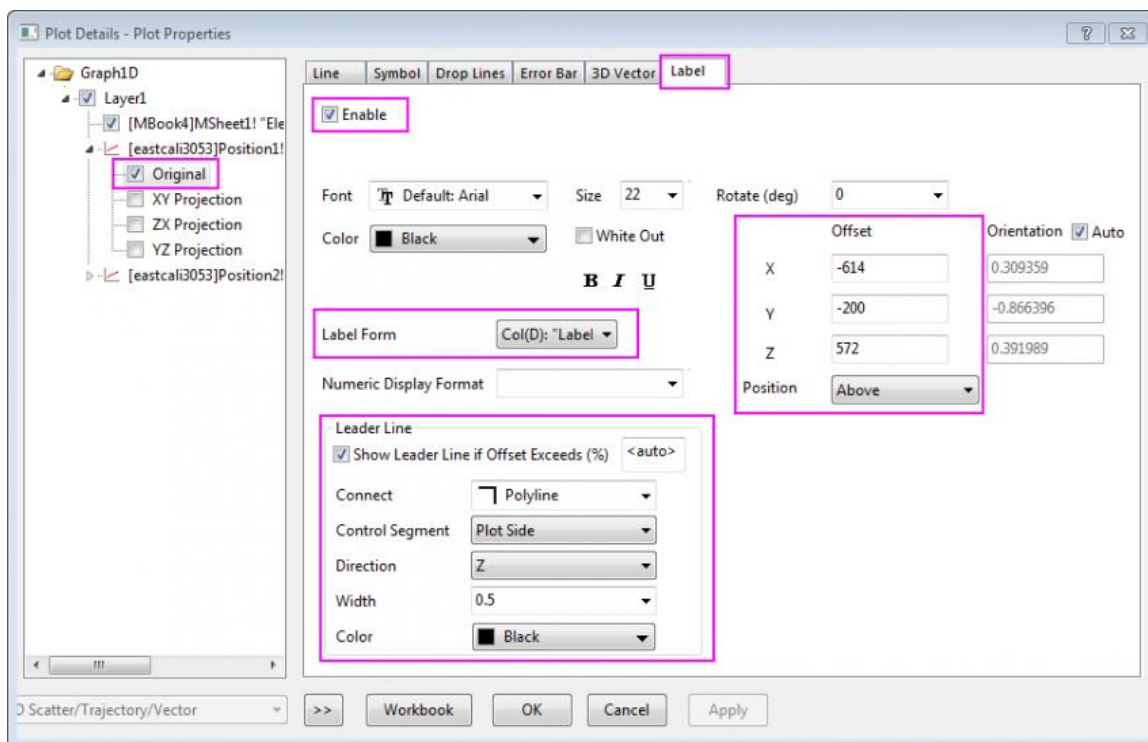

- In the left panel, click on **Original** under the *Position2* plot-level. In the **Label** tab repeat the above step making the selections given below.

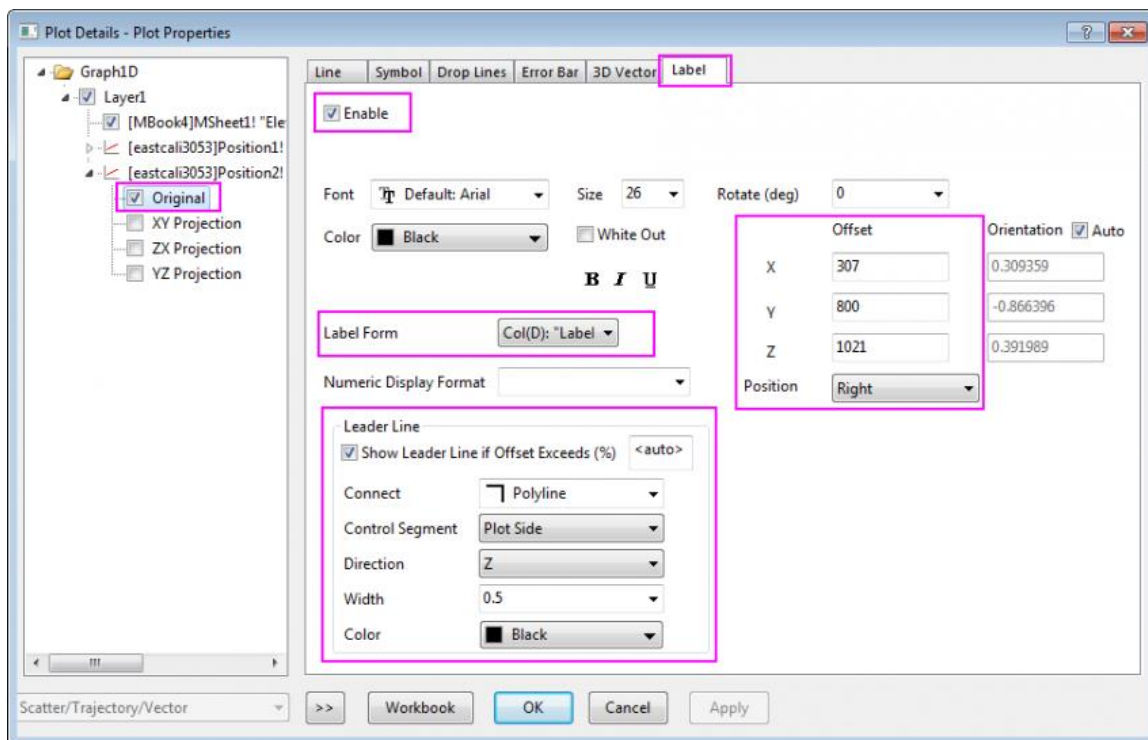

Click on the **OK** Button. Labels and Lead Lines should now appear on the graph.

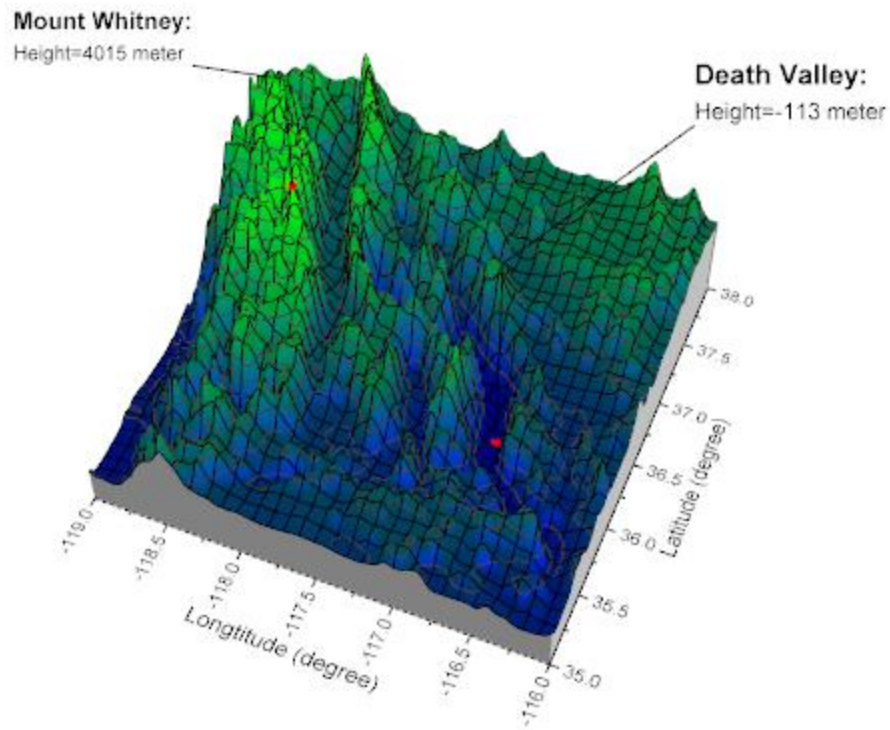

## 6.13.20 Transparent Parametric Surfaces combined with Scatter Plot

### 6.13.20.1 Summary

This tutorial will show you how to create 3D Scatter plots and combine them with 3D Parametric Surfaces.

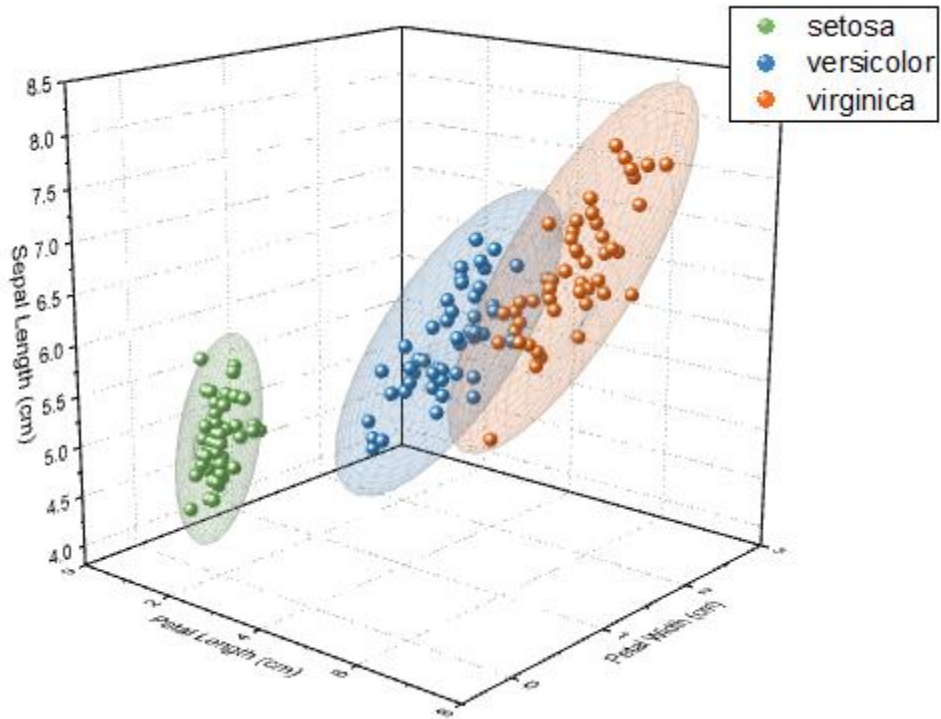

Minimum Origin Version Required: Origin 2016 SR0

#### 6.13.20.2 What you will learn

- How to create the 3D Scatter plot with symbol color indexing.
- How to plot 3D confidence ellipsoid by app

#### 6.13.20.3 Steps



##### 6.13.20.3.1 Create the 3D Scatter plot with color index

You can refer to this graph in Learning Center. (Select **Help: Learning Center** menu or press **F11** key , and then open **Graph Sample: 3D Symbol Bar and Wall**)

1. Import the file *<Origin EXE Path>\Statistics\Fisher's Iris Data.dat* into a new workbook.
2. Select **Plot > Templates: System Template Library** from the main menu. In the **System Templates** dialog, expand the **Graph Template -> 3D Symbols & Bars & Vectors** node, then select **gl3d**. Click the **Plot Setup...** button at the bottom left corner of the dialog.
3. In the **Plot Setup** dialog, set column C, D, and A as the X, Y, and Z columns, respectively. Click the **Show Plot List** button (double downward-pointing arrows in the lower right corner of Plot Setup) to

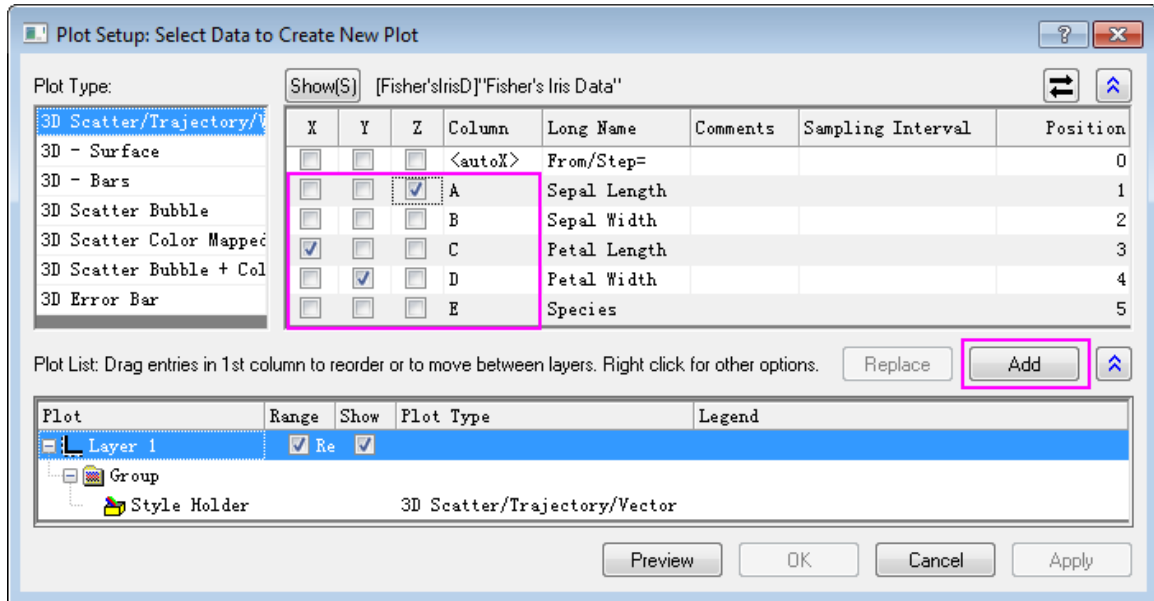
expand the dialog (if it is not already expanded) and select the **Add** button, then click **OK**.



In order to show all three panels in **Plot Setup** dialog, please expand **Plot Type** panel by clicking  and expand **Available Data** panel by clicking  again.

Please refer to [Plotting using Plot Setup](#) for more information.

4. Select **Format: Plot** in the menu to open the **Plot Details** dialog. In the **Symbol** tab, set **Color** as **Index: Col(Species)**.

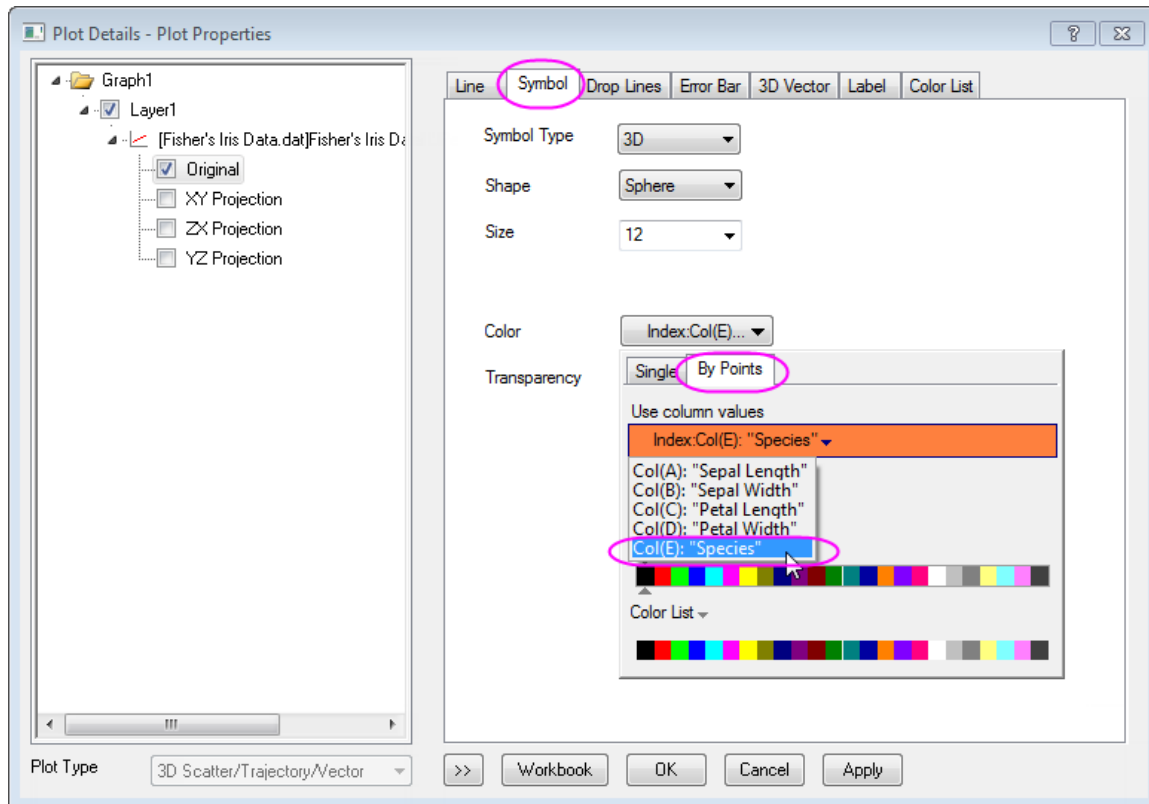



- Go to **Color List** tab, check the **Use custom increment list** check box, and custom the color list as the following image. Click **OK**.

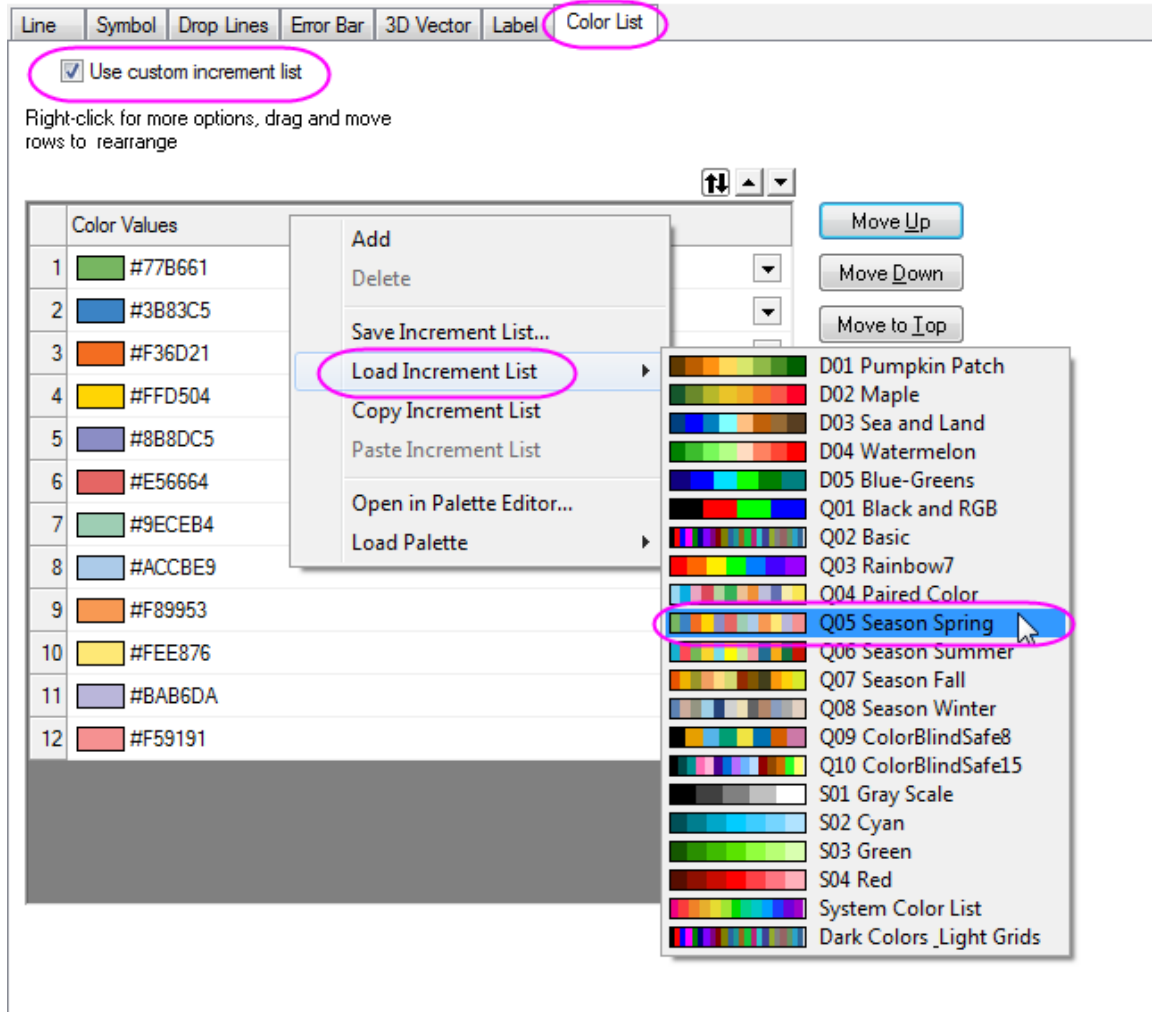

- Right-click on the graph legend and select **Legend: Reconstruct Legend** in the context menu.
- Right-click on the graph legend and select **Properties...** to open the dialog. Set the font size to **22**, and custom the text as following image:

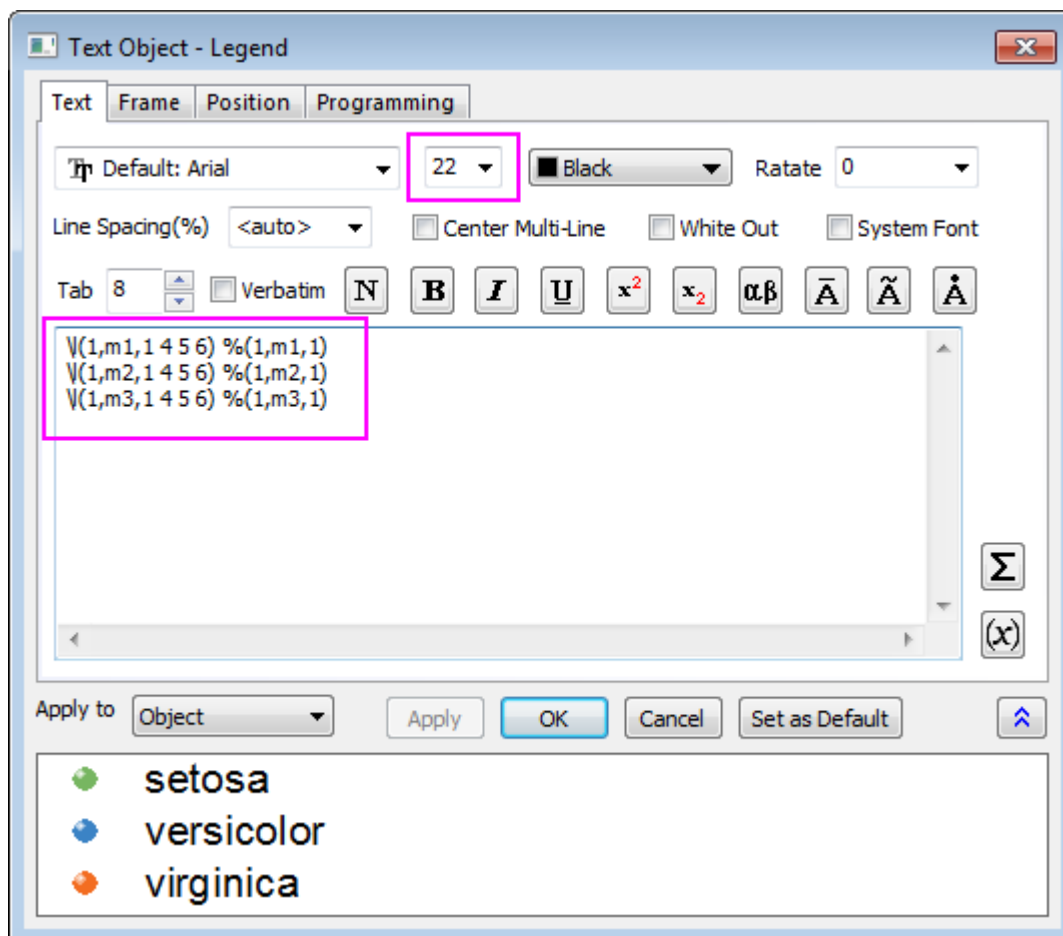

The 3D Scatter graph will be generated as shown below:

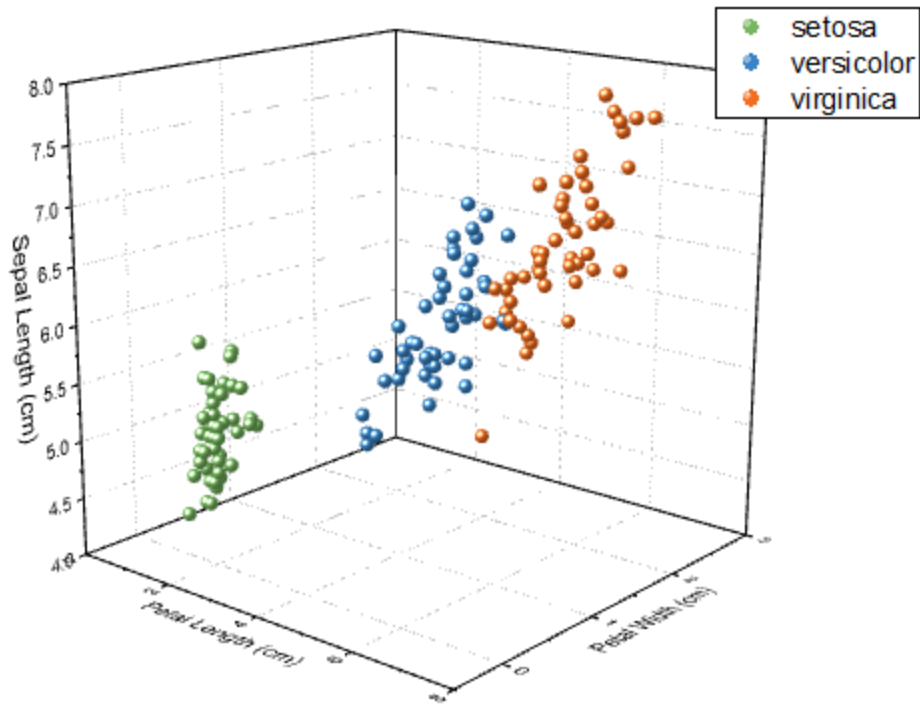

- To ensure that the legend is not overwritten during the next steps, select **Format: Page** in the menu to open the **Plot Details** dialog. Go to **Legends/ Titles** tab and choose **None** from the **Legend Update**

**Mode** drop-down list.

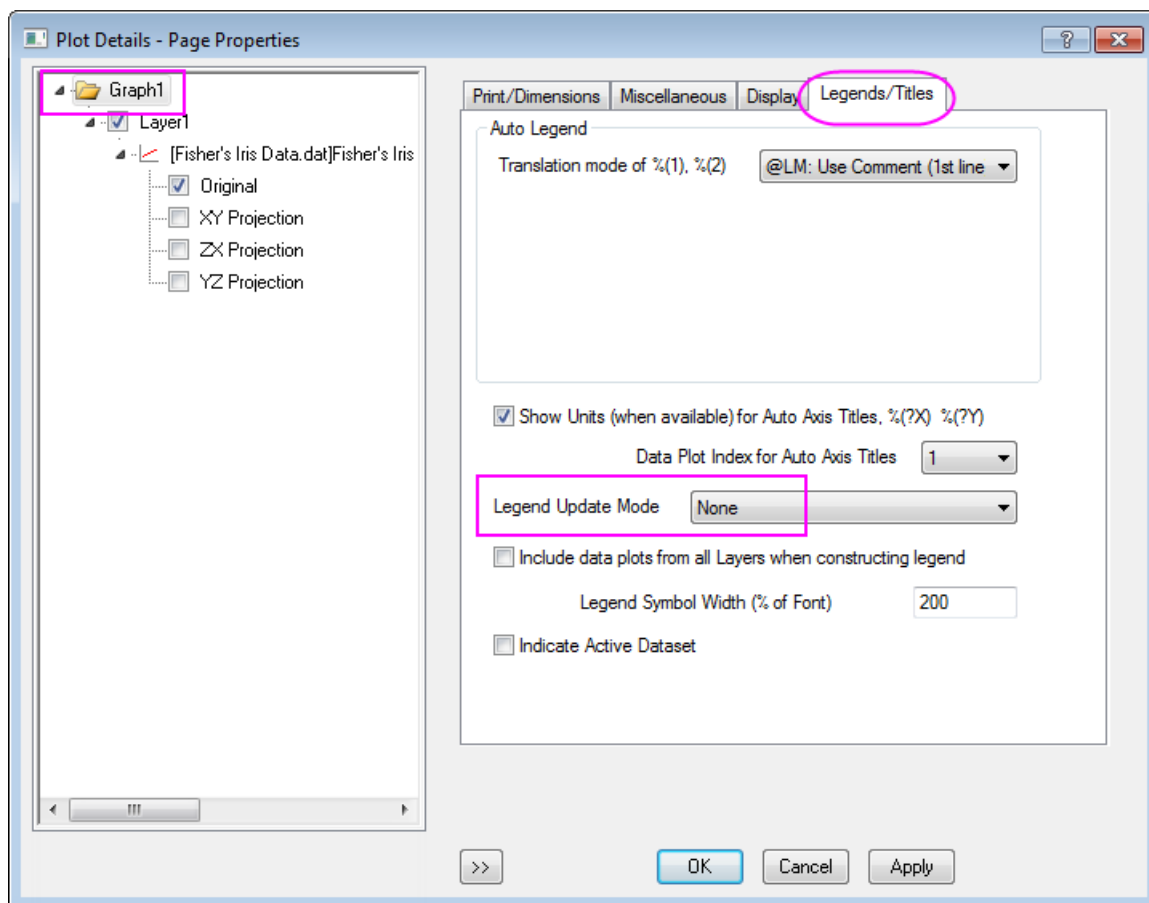

### 6.13.20.3.2 Add transparent parametric surfaces on the active graph

1. Download **3D Confidence Ellipsoid** app in this file exchange page: [3D Confidence Ellipsoid](#)
2. Drag- and-drop the app into Origin program to install it, then the **3D Confidential Ellipsoid** icon will be listed in the Apps Gallery

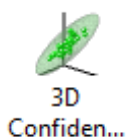

3. Active the graph and click this **3D Confidential Ellipsoid** button in the Apps Gallery. This will open the **Plot 3D Confidence Ellipsoid** dialog. Accept the default settings and click **OK**. Three ellipsoid are added to the graph, each envelops the group of data with the same color.

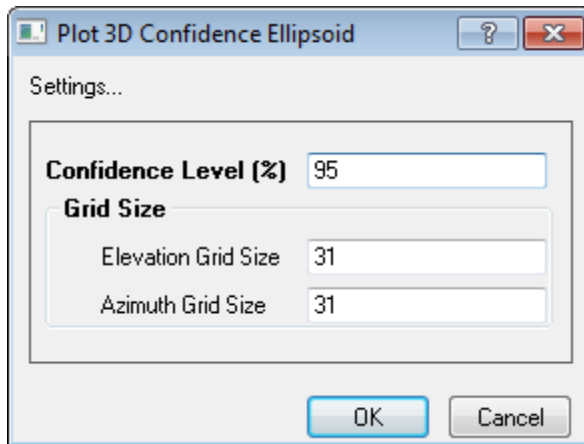

The final graph should appear as shown below:

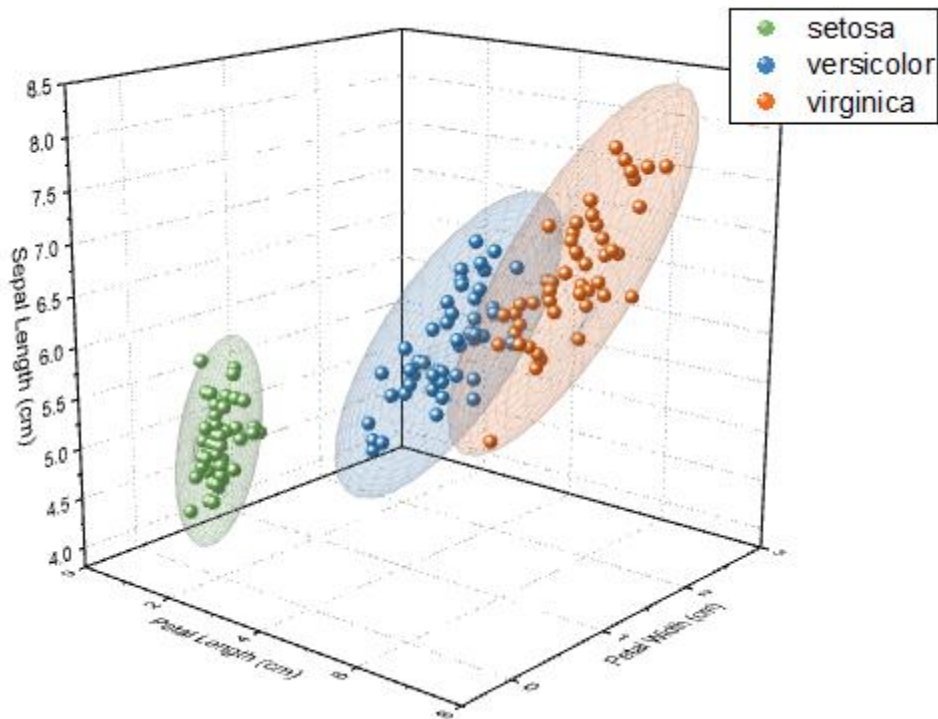

### 6.13.21 Convert Data from Spherical Coordinate to XYZ and Make a 3D Plot

#### 6.13.21.1 Summary

In this tutorial, we will look at what is involved in creating the 3D graph with spherical coordinate data, as well as using X-Function *sph2cart* to convert data in a workbook or matrix from spherical coordinate to Cartesian coordinates.

It is important to go over the [Converting Algorithm for sph2cart](#), and notice that Origin use  $\phi$  as the **elevation** and  $\theta$  as the **azimuth** in the transform formula.

$$x = r * \cos(\phi) * \cos(\theta);$$

$$y = r * \cos(\phi) * \sin(\theta);$$
$$z = r * \sin(\phi);$$

#### 6.13.21.2 What will you learn

- Convert data in a worksheet (virtual matrix) from spherical coordinate to Cartesian coordinates and make a 3D surface plot.
- Convert data in a matrix object from spherical coordinate to Cartesian coordinates and make a 3D surface plot.
- Convert data in three matrix objects from spherical coordinate to Cartesian coordinate and make a discrete 3D surface plot.
- Convert data in a worksheet(XYZ) from spherical coordinate to Cartesian coordinate(XYZ) and make a 3D space curve.

#### 6.13.21.3 Steps

##### 6.13.21.3.1 3D Surface plot with colormap for data in virtual matrix

Origin can create surface plot with data in virtual matrix (spherical coordinate) and add colormap for it. The following steps introduce the plot of a ellipsoid with colormap surface.

This tutorial is associated with <Origin EXE Folder>\Samples\Tutorial Data.opj.

1. Open the **Tutorial Data.opj** and browse to the folder: *Spherical Coordinates*.
2. Open the virtual matrix data *spheriPlot* in tutorial data, the structure of the virtual matrix is shown in graph below:

ellipsoid						
	A(X)	B(Y)	C1(Y)	C2(Y)	C3(Y)	C4(Y)
Long Name						
Units				azimuth		
Comments						
F(x)=						
1		0	4	8	12	16
2	-90	0.70711	0.70711	0.70711	0.70711	0.70711
3	-88	0.70733	0.70733	0.70733	0.70733	0.70733
4	-86	0.70799	0.70799	0.70799	0.70799	0.70799
elevation	-84	0.70907	0.70907	0.70907	0.70907	0.70907
	-82	0.71059	0.71059	0.71059	0.71059	0.71059
7	-80	0.71254	0.71254	0.71254	0.71254	0.71254
8	-78	0.71493	0.71493	radius	0.71493	0.71493
9	-76	0.71774	0.71774		0.71774	0.71774
10	-74	0.721	0.721	0.721	0.721	0.721
11	-72	0.72469	0.72469	0.72469	0.72469	0.72469
12	-70	0.72882	0.72882	0.72882	0.72882	0.72882
13	-68	0.73338	0.73338	0.73338	0.73338	0.73338
14	-66	0.73839	0.73839	0.73839	0.73839	0.73839
15	-64	0.74383	0.74383	0.74383	0.74383	0.74383
16	-62	0.74971	0.74971	0.74971	0.74971	0.74971

In this example, the azimuth  $\theta$  is from 0 to 360, and the elevation  $\phi$  is from -90 to 90. The unit used for angle is degree.

- Open the Script Window, type in code below and run:

```
sph2cart -d;
```

Setting the sph2cart dialog follows graph below, then click **OK**. Three new matrix objects will be created which are corresponded to XYZ.

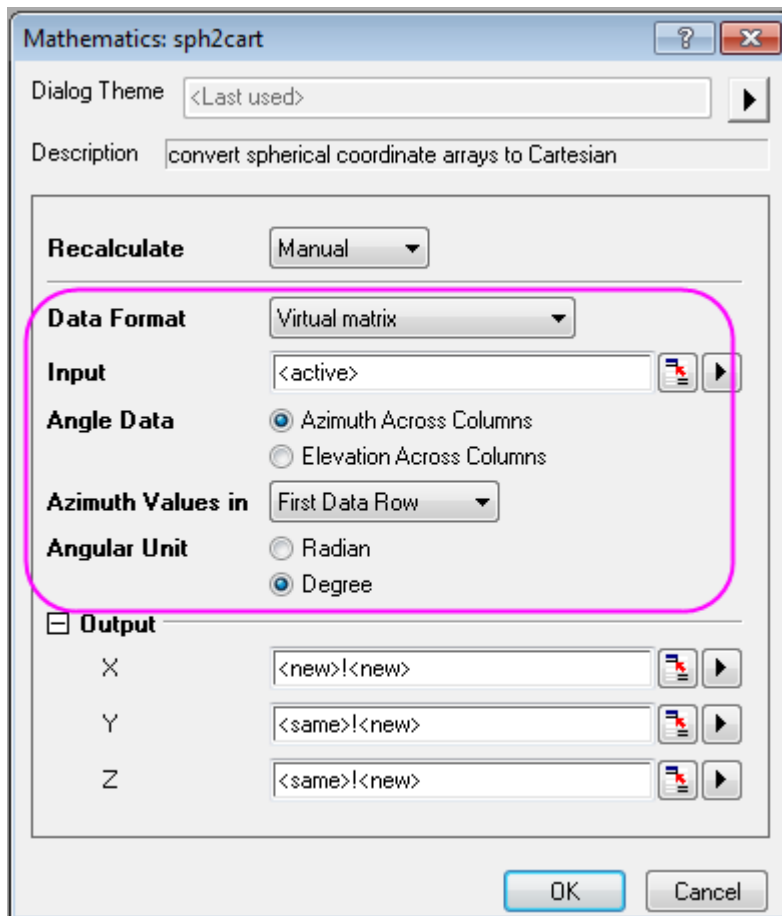

- Then add an extra matrix object after the matrix Z in Matrix Layer to act as the colormap.

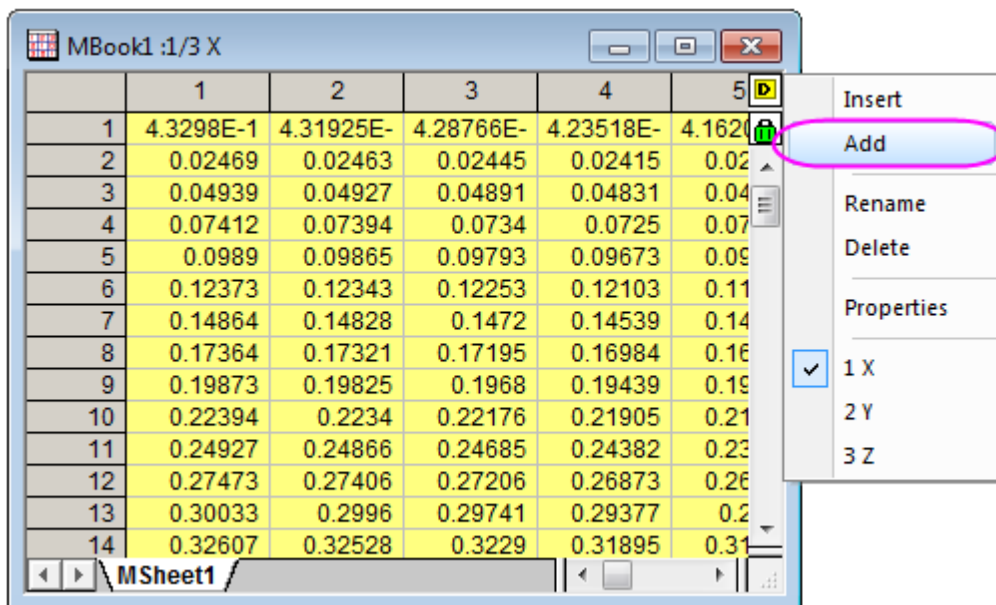



5. Copy the data in *colormap* matrix in Spherical Coordinates folder, paste the data to the new added matrix object.

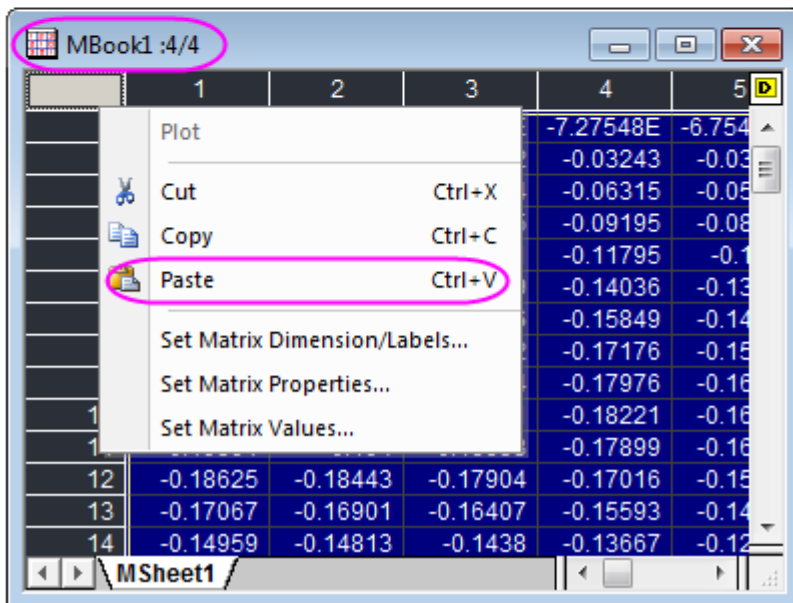
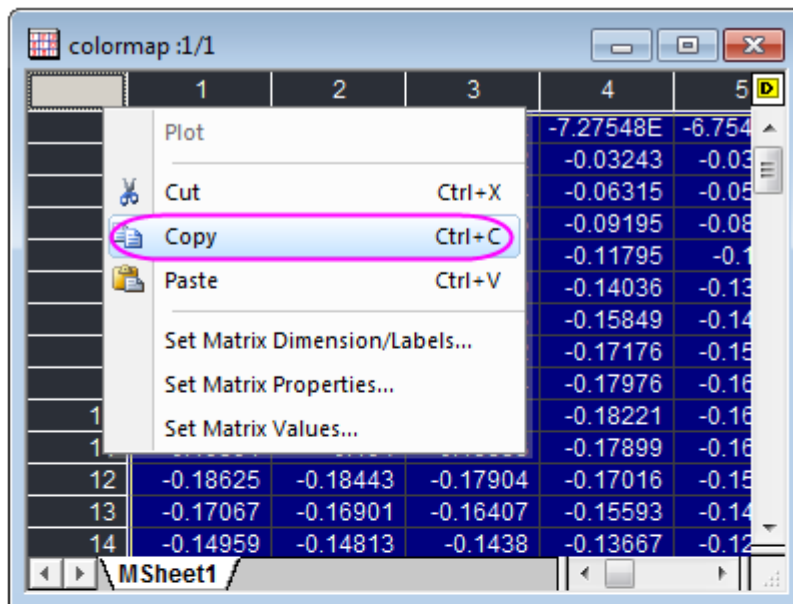

6. Now, you will plot the Matrix into a 3D surface, active the matrix object Z, click **Plot > 3D : 3D Colormap Surface**

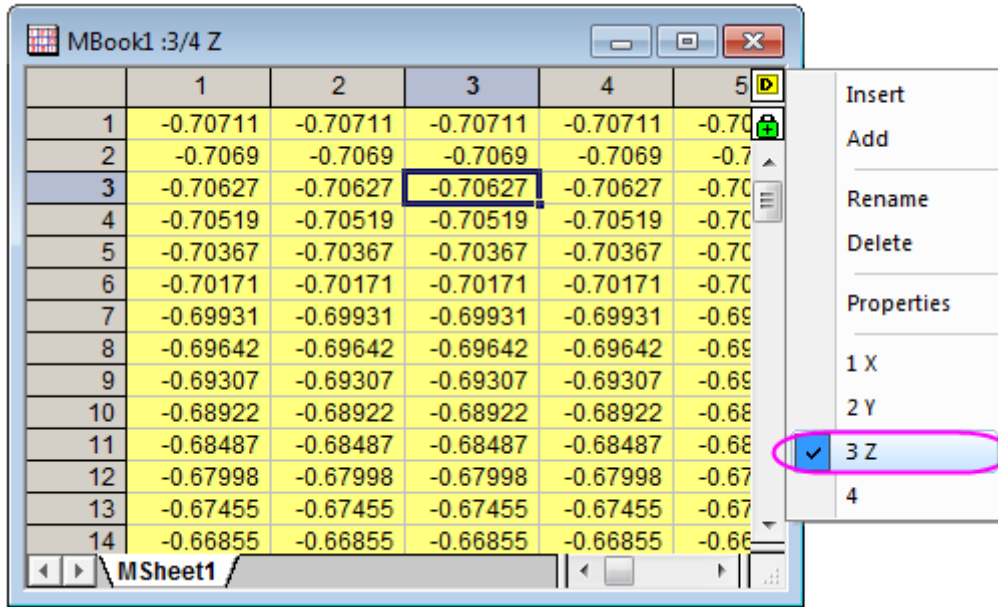

Double click the surface to open the Plot Properties dialog. Set the Parametric Surface in dialog follows graph below, and click **OK** to apply the settings.

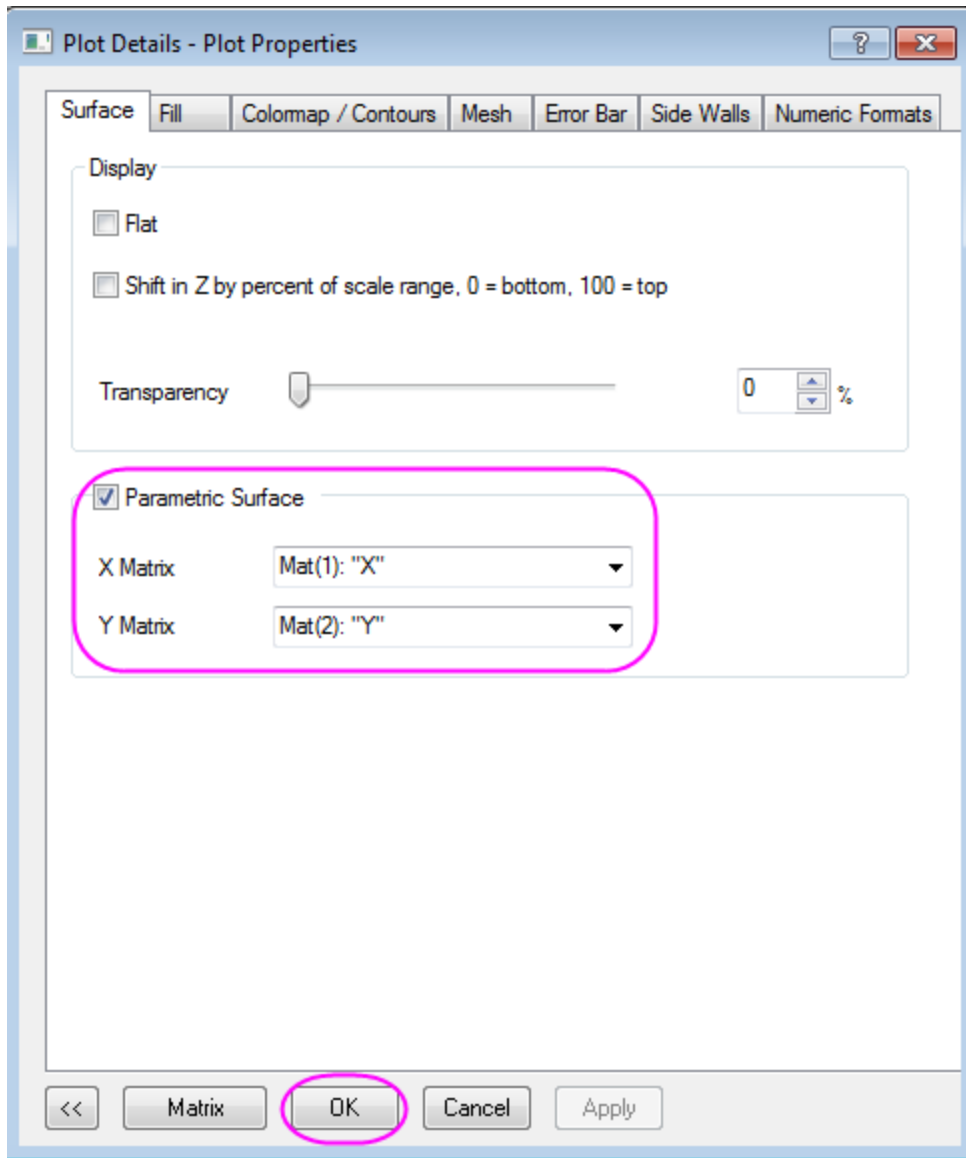

7. Click CTRL+R to rescale the axis, double click the axis to open the Axis dialog, change to scale for XYZ axis from  $-1.2$  to  $1.2$ , click **OK** to close the dialog.

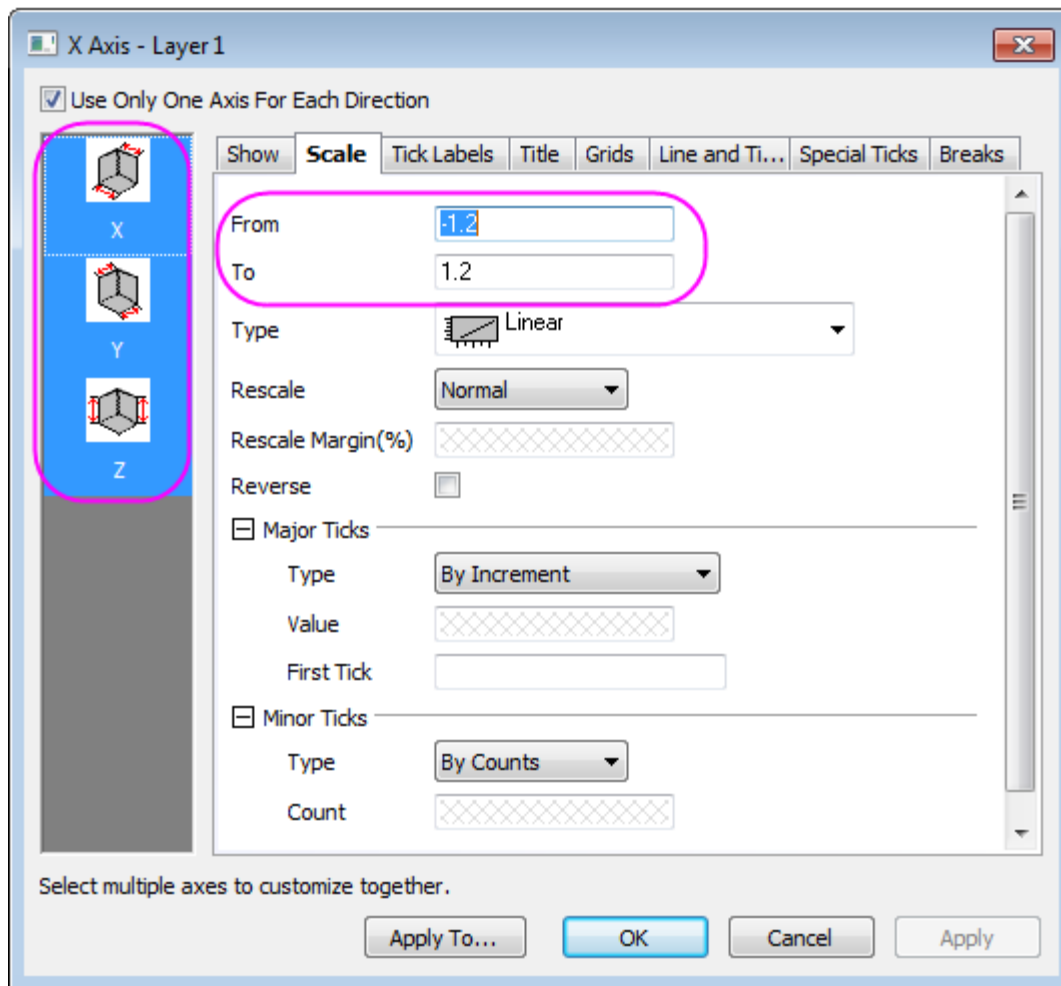

You graph may looks like this:

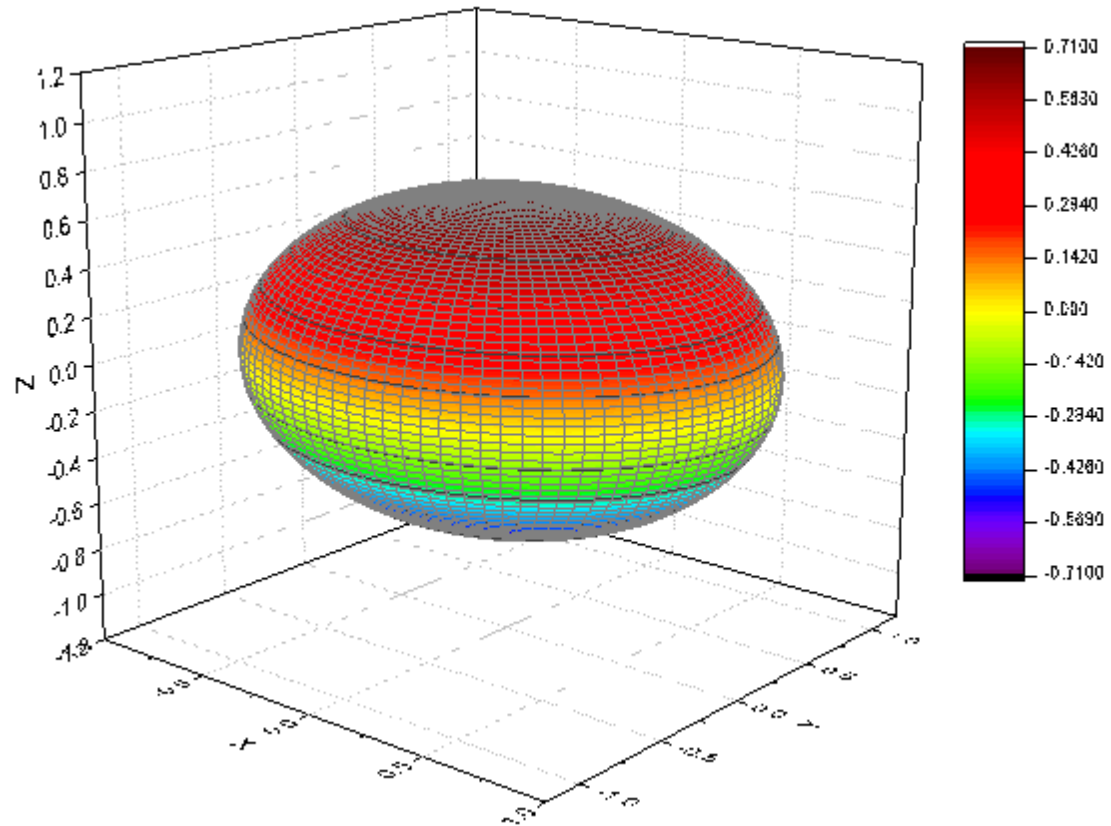

8. Next we will apply the colormap to the ellipsoid, double click the surface to open the **Plot Details** dialog, go to the **Fill** tab, change the **Contour fill from matrix** into Mat(4).

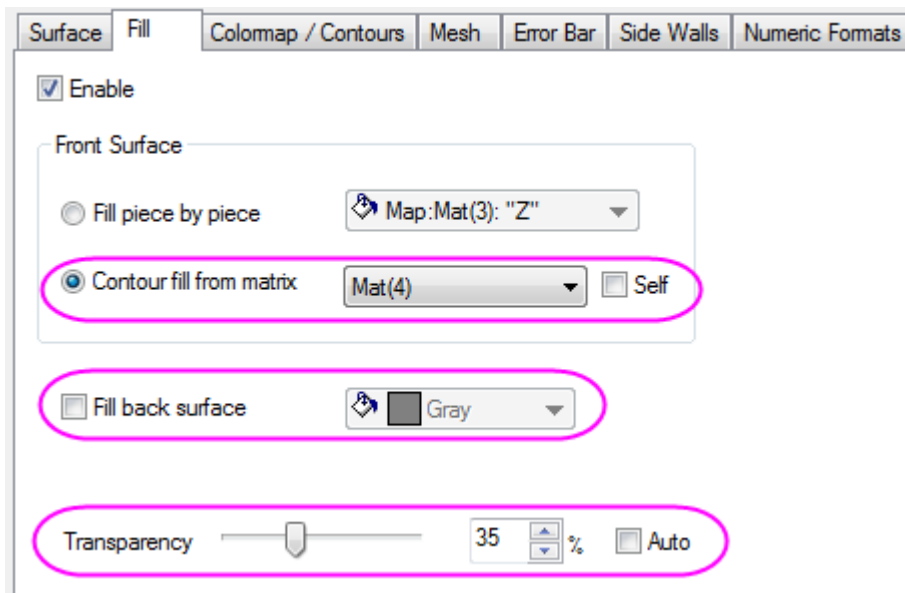

- Go to the Colormap/Contours tab, you can click the table head to open the Set Levels, Fill and Contour Lines dialog. Set the Level by **Find Min/Max**, click **OK** to apply, and set Fill by load palette "Maple", click **OK**, then select "Hide All" to hide all lines, click **Apply** to apply the settings.

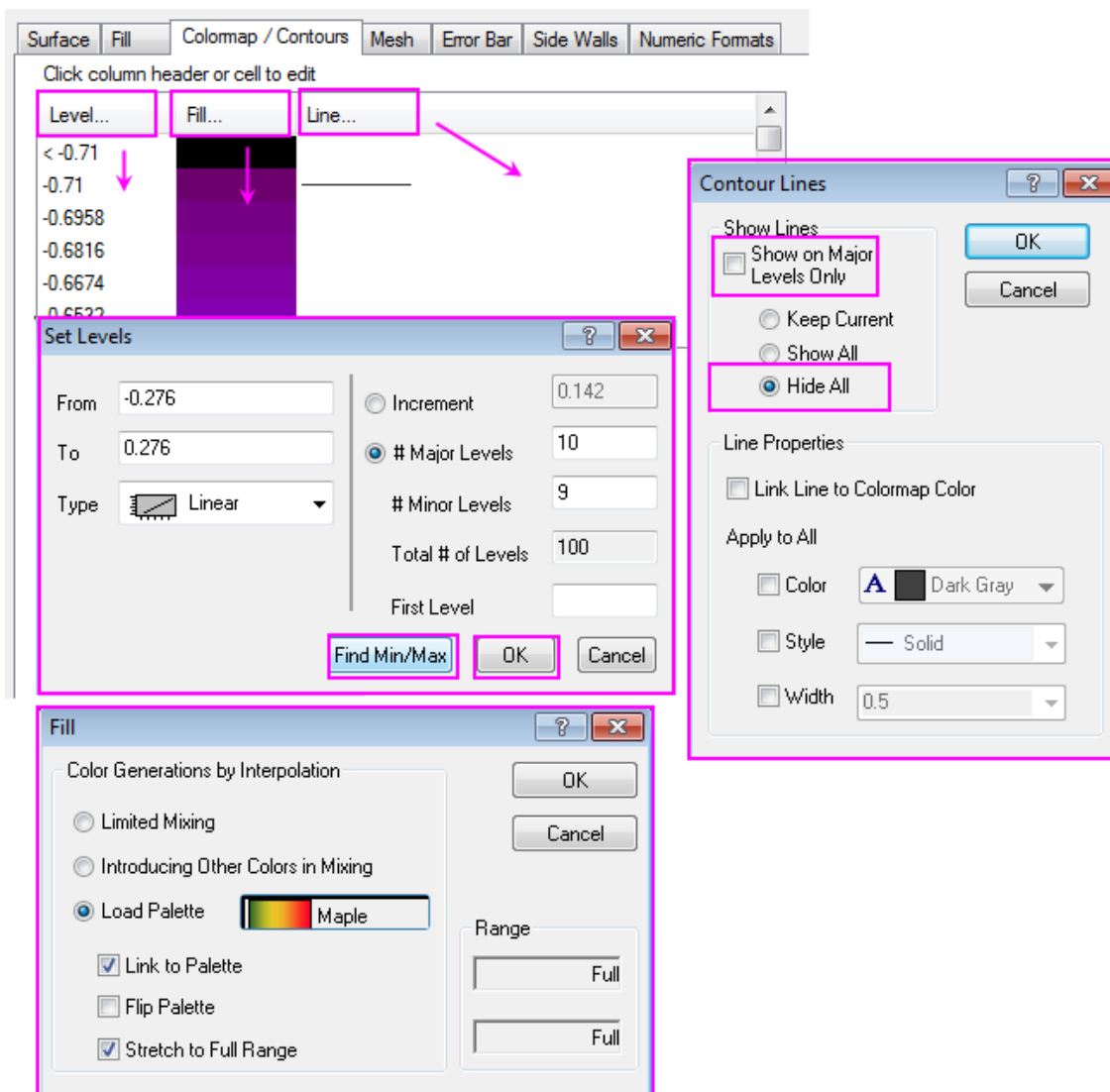

Go to the **Mesh** tab, deselect the **Enable** checkbox to close the mesh line, click **OK** to close the dialog.

- the finished graph is similar to this:

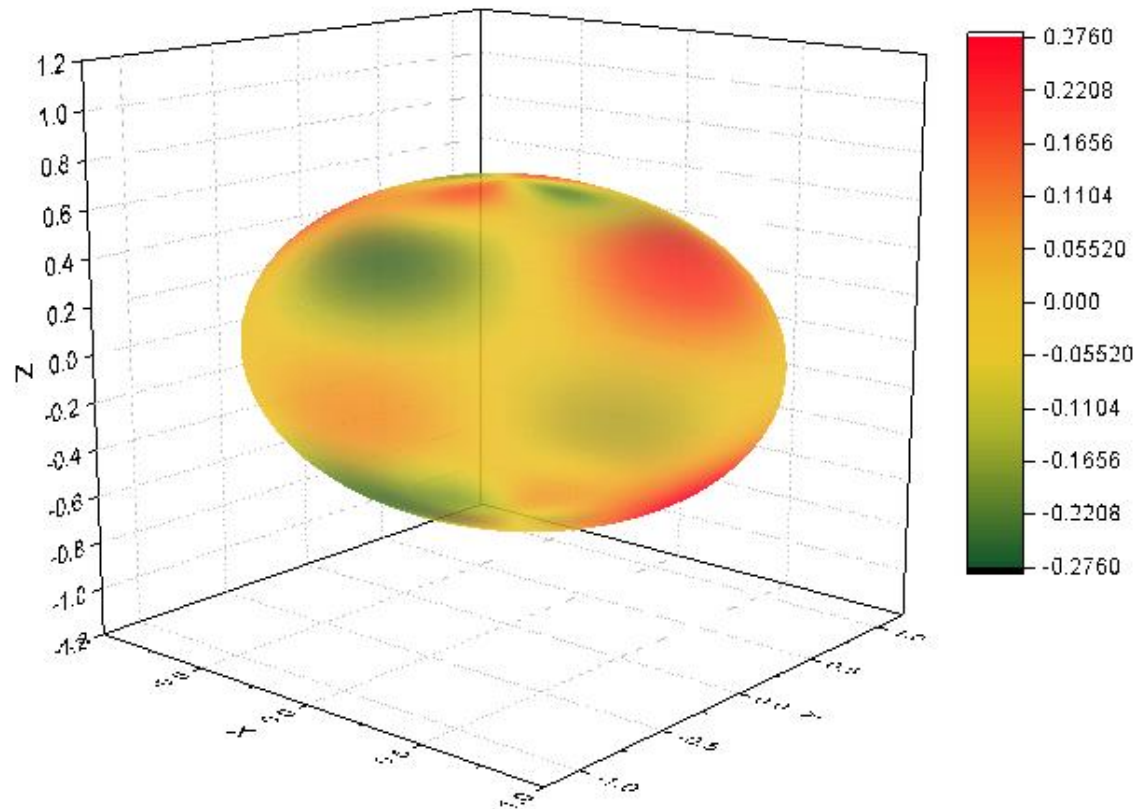

The azimuth and elevation can be unevenly spaced in  $(r, \theta, \varphi)$  space.

### 6.13.21.3.2 Convert data in a matrix object and make a 3D surface plot

1. Origin can construct a  $R(\theta, \varphi)$  surface function under spherical coordinates. The azimuth, elevation and radius are placed in the same matrix. Before set matrix values form a spherical coordinates equation, you can refer to [sph2cart](#) for the transforming relations and definition of azimuth and elevation in our system.
2. Create a new a matrix, and select **Matrix: Set Dimension and Labels** in main menu. Set the Dimension  $100 \times 100$ , and map Column to X by  $(0, 2\pi)$ , map Column to Y by  $(-\frac{\pi}{2}, \frac{\pi}{2})$ . X and Y are the Angle Data, where X is the azimuth which is across columns and Y is the elevation.

In this example, the azimuth  $\theta$  is from 0 to  $2\pi$ , and the elevation  $\phi$  is from  $-\frac{\pi}{2}$  to  $\frac{\pi}{2}$ . The unit used for angle is radian.

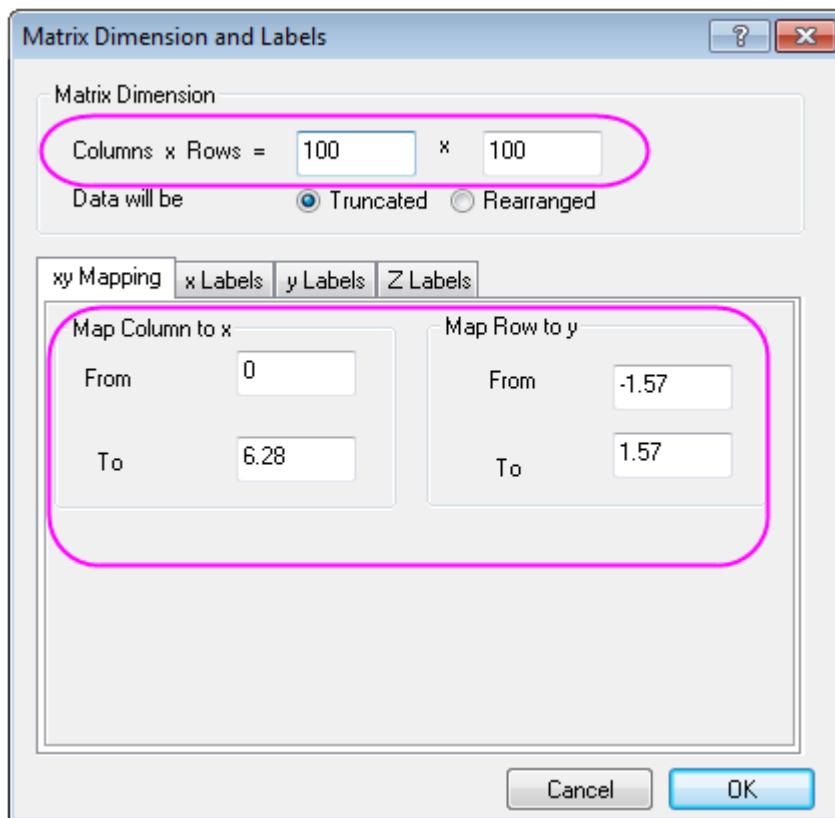

3. Select **Matrix: Set Values** in main menu. The formula entered in the Set Values dialog should be  
 $\text{abs}(\text{sqrt}(0.5) * 0.25 * (15/\pi)^{0.5} * \sin(\pi/2-y) * \sin(\pi/2-y) * (\sin(2*x) - \cos(2*x)))$

We set the matrix values by using spherical harmonics,  $Y_l^m$  is specific set of spherical harmonics, and the linear combinations of  $Y_l^m$  is corresponded to the d-orbitals of the hydrogen atom (i.e.  $d_{xy}$ ).

$$|d_{xy}| = \left| \sqrt{1/2}(Y_2^{-2} - Y_2^2) \right| \quad (1)$$

$Y_2^2$  and  $Y_2^{-2}$  in function (1) are:

$$Y_2^2 = \frac{1}{4} \sqrt{\frac{15}{\pi}} \sin^2\left(\frac{\pi}{2} - \varphi\right) \cos(2\theta)$$

$$Y_2^{-2} = \frac{1}{4} \sqrt{\frac{15}{\pi}} \sin^2\left(\frac{\pi}{2} - \varphi\right) \sin(2\theta)$$



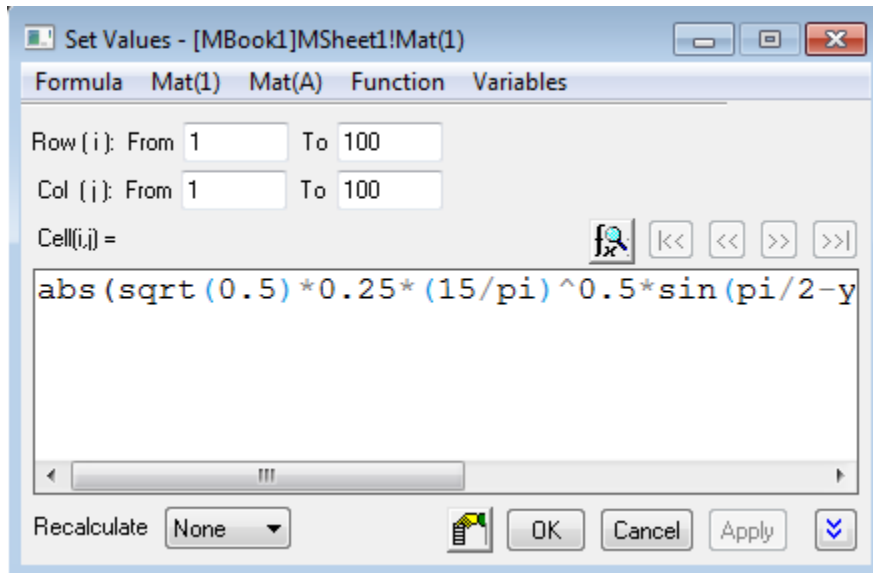

4. Next you can convert the matrix from spherical coordinates to Cartesian by using X-Function *sph2cart*. Select **Window: Script Window** in main menu, then enter the script below and click **Enter** to execute :

```
sph2cart -d
```

Set the sp2cart dialog follows graph below, the single matrix object is used as input data:

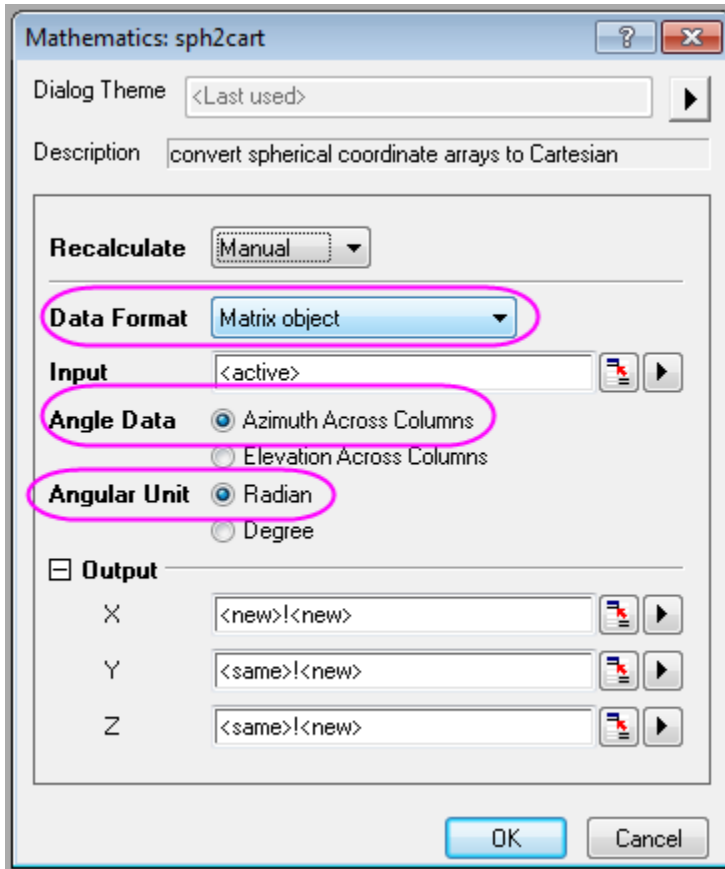

After clicking **OK**, the results will be created in a new Matrix Sheet (MSheet2).

- Now, you will plot the Matrix into a 3D surface. With Matrix object **Z** in **MSheet2** active,

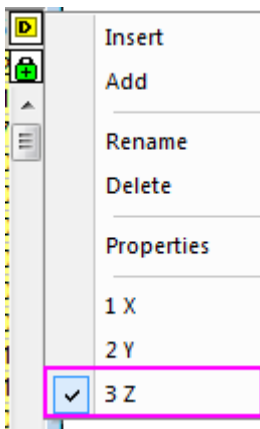

select **Plot > 3D : 3D Colormap Surface** in main menu.

- Double click the surface to open the **Plot Details** dialog, set the parametric surface follows graph below, and click **OK**.

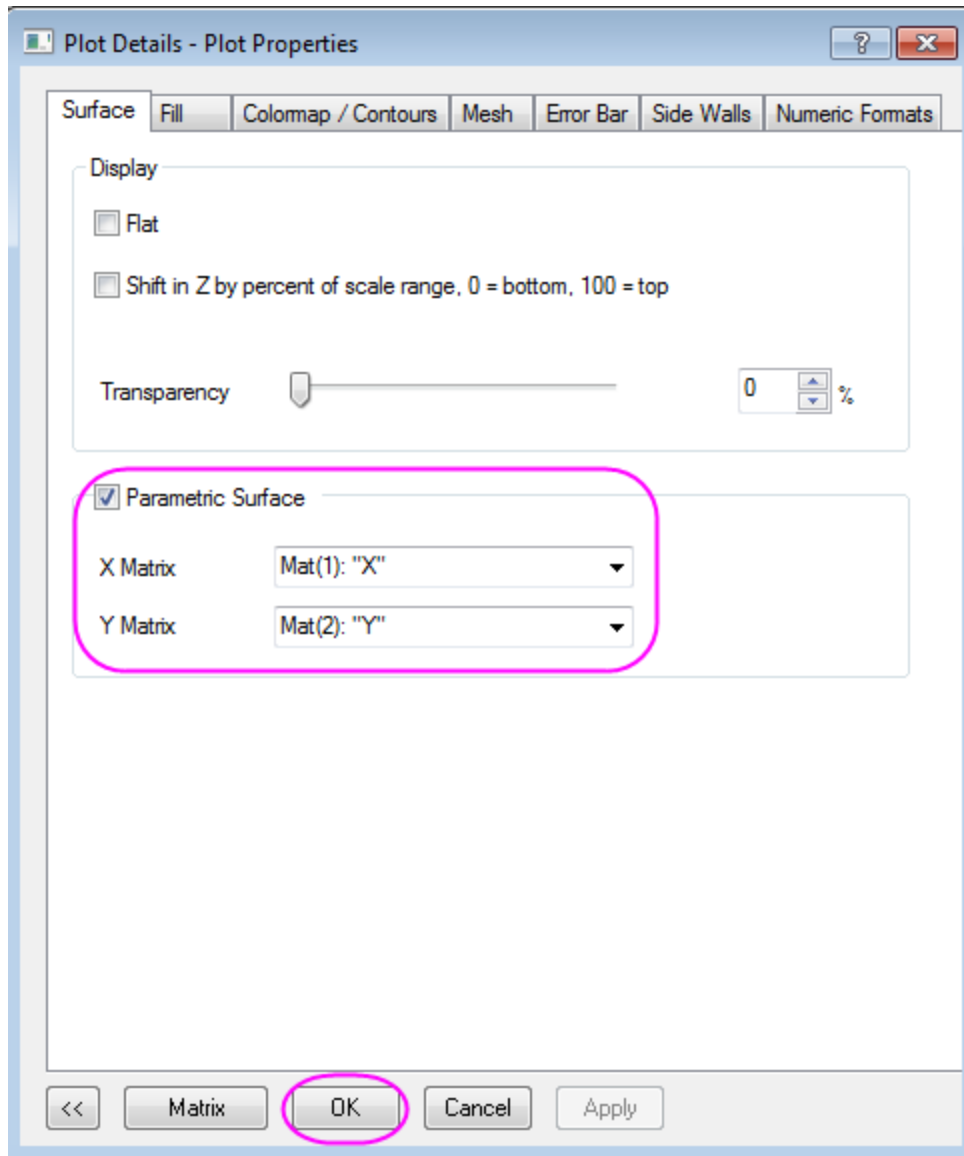

7. Click CTRL+R to rescale the axis, double click the axis to open the **Axis** dialog, change to scale for XYZ axis from -0.5 to 0.5, set the value for **Major Ticks** to 0.2, click **OK** to close the dialog.

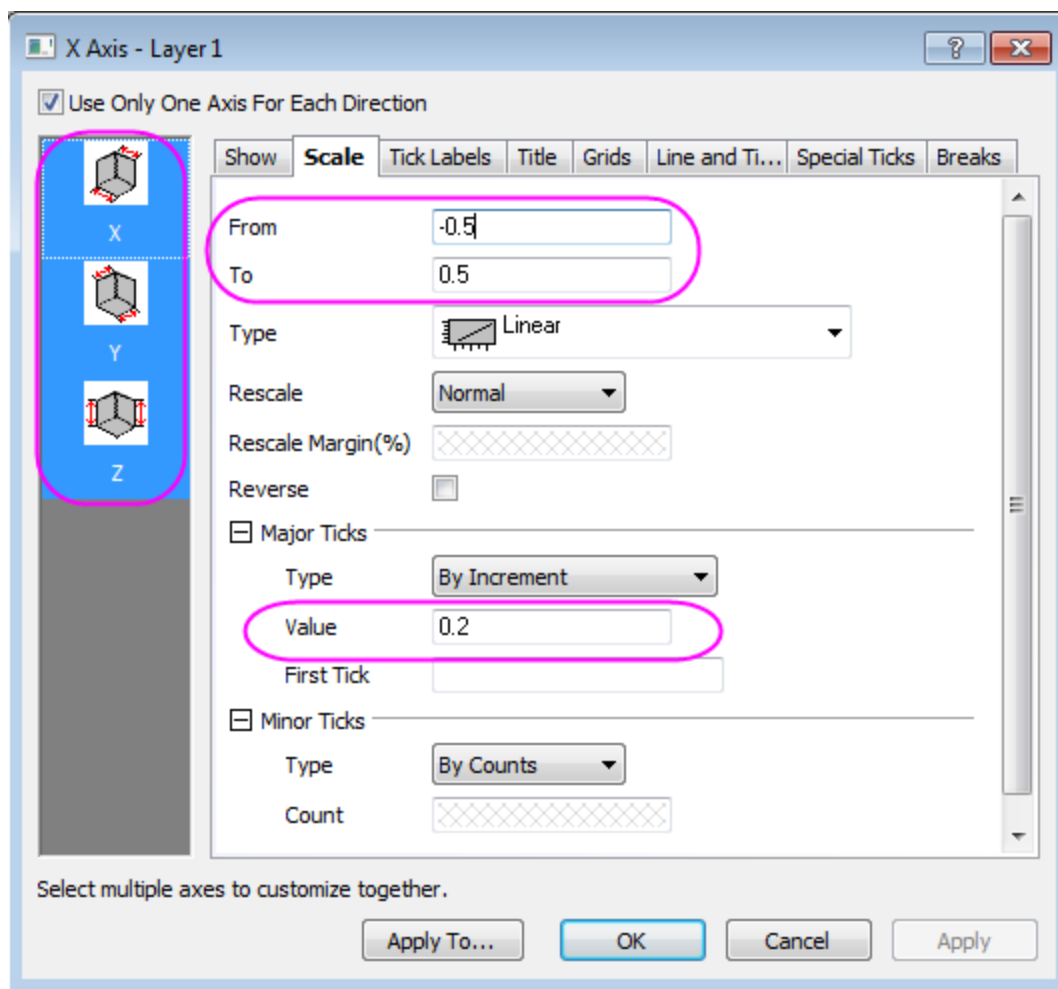

8. The graph created is similar to this:

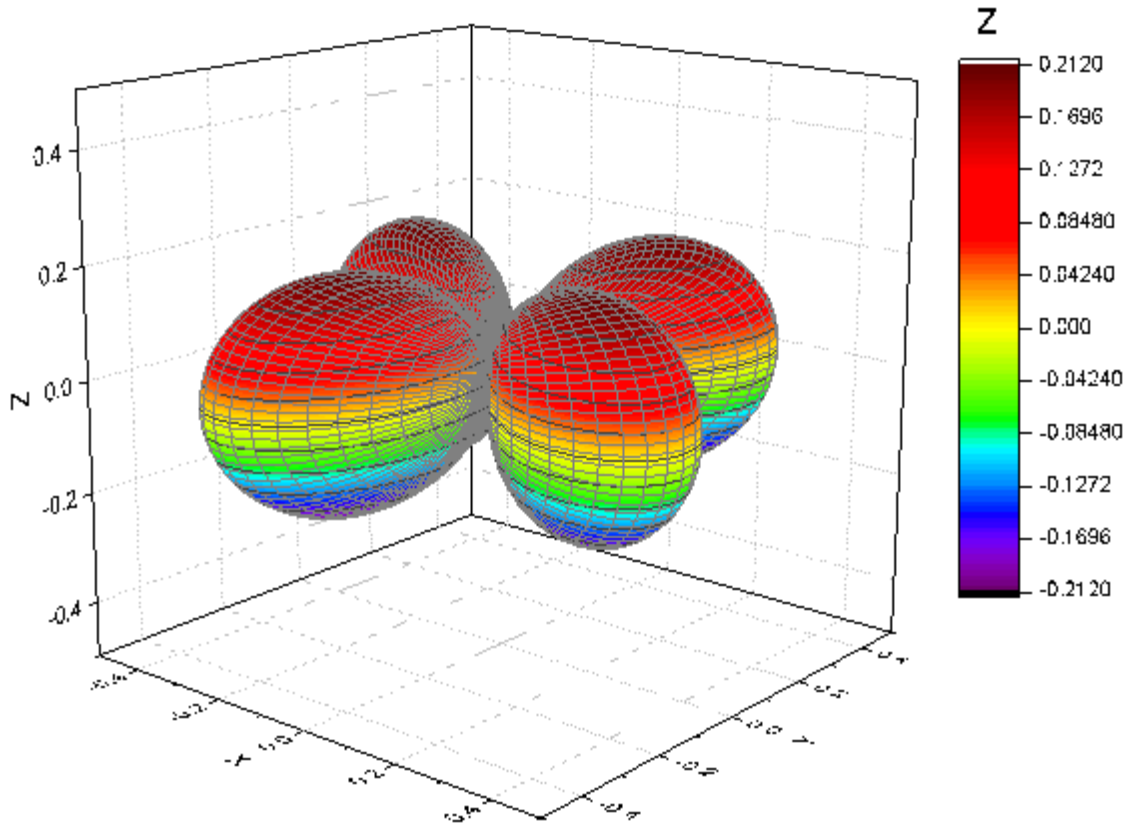

9. Double click the surface to open the **Plot Properties**. Go to the **Colormap/Contours** tab, click the Level/Fill/Line button and set the dialogs separately.

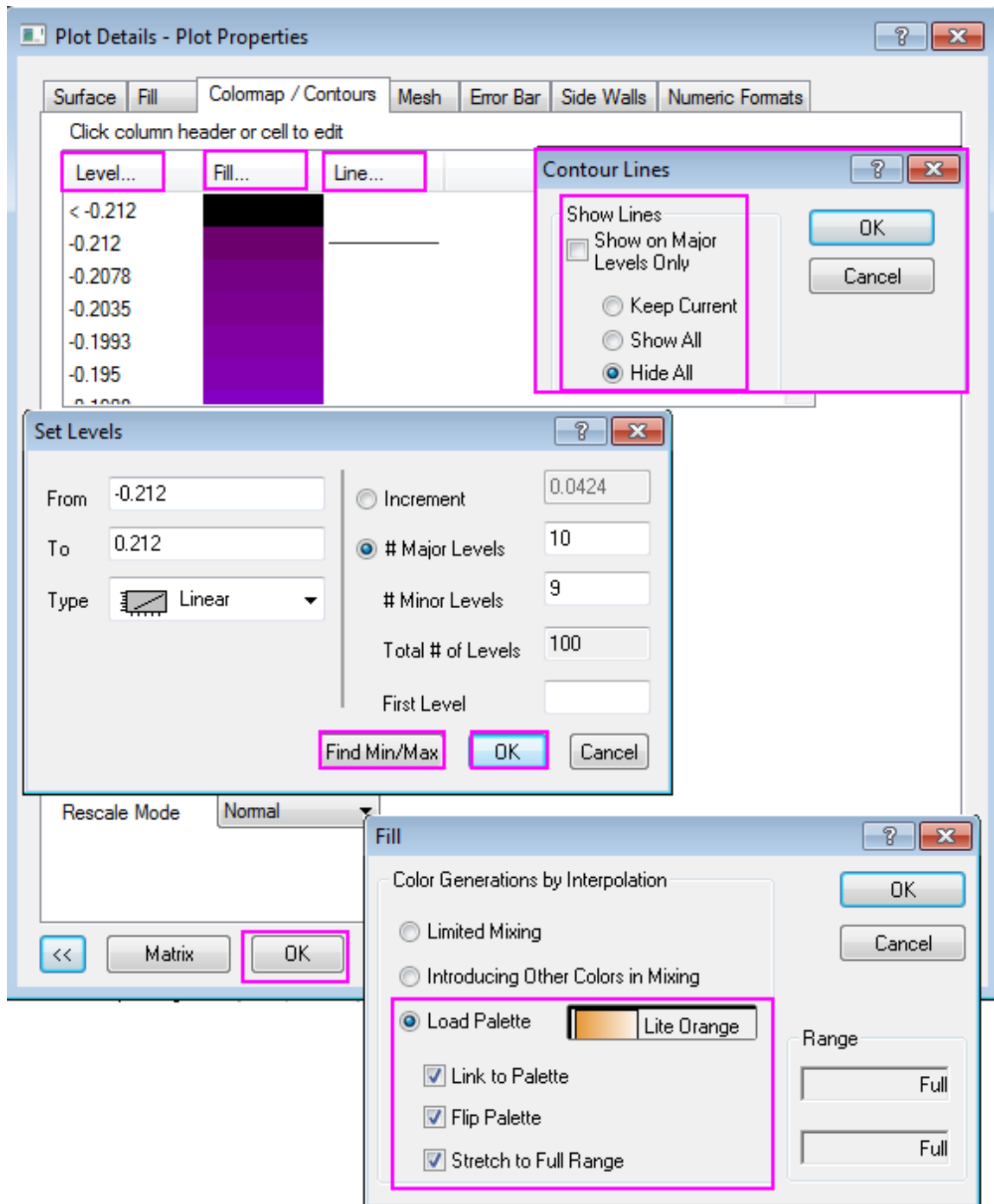

Then go to the **Mesh** tab, deselect the **Auto** checkbox for Transparency and change the value to about 70%.



You can refer to [Parametric Surface](#) tutorial for details about colormap setting. The finished Graph are shown below:

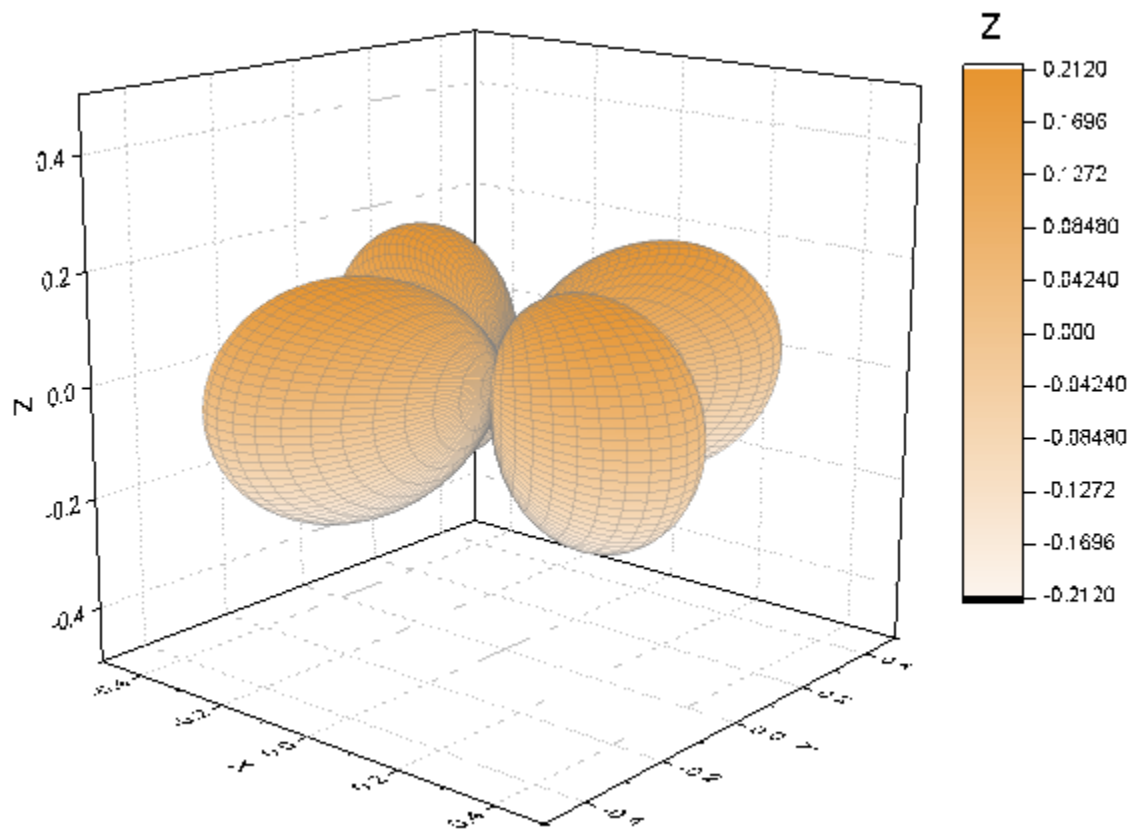

### 6.13.21.3.3 Convert data in three matrix objects and make a 3D surface plot

Origin can construct a  $R(\theta, \varphi)$  surface function under spherical coordinates. The azimuth, elevation and radius are placed in the different matrix. The following steps shows how to construct multiple surfaces by using three matrix and use **sph2cart** to convert them into XYZ space.

1. Create a new matrix. Set the Matrix Dimension  $98 \times 33$  in **Matrix Dimension and Labels** dialog, then click **OK**.
2. Click the D button on the right corner of the matrix and click **Add** to add another two matrix objects in MatrixBook.

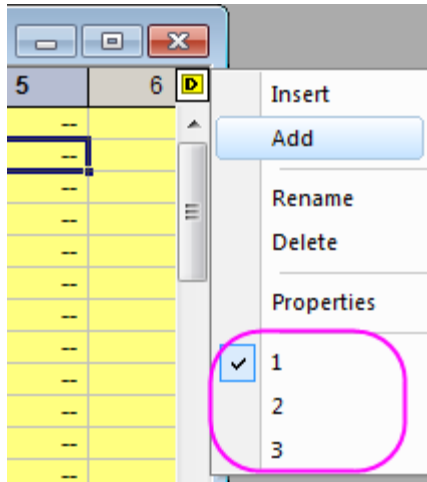

3. The azimuth will be put into the first matrix object. With the first matrix object active (Click the D button and switch between 1/2/3), click **Matrix: Set Values** in main menu. The matrix values for azimuth will be set in this way:

Column(j)	Data
0 to 32	$(0, 2\pi)$
34 to 65	$(0, 2\pi)$
66 to 98	$(0, 2\pi)$

4. Set the Matrix value use the expression below:

$(j==33 || j==66) ? 1/0 : (\pi/32 * j * (j < 33) + \pi/32 * (j - 33) * (j > 33 \&\& j < 66) + \pi/32 * (j - 66) * (j > 66))$

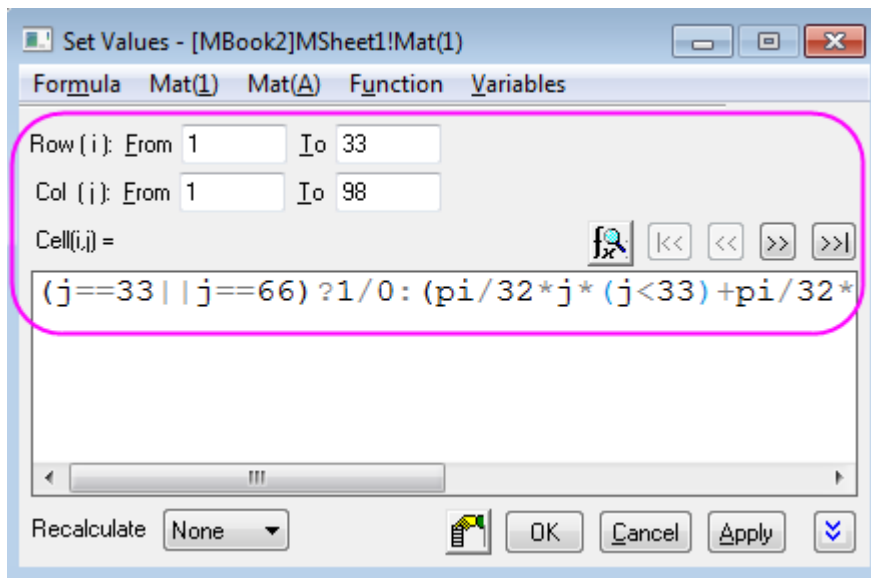

The value from 0 to  $2\pi$  loop 3 times, and the Column (33), Column (66) should be missing values.



5. The elevation will be put into the second matrix object (select matrix 2 in graph in step 2). Set the values for elevation by using expression:

$$\text{pi}/32*(i-17)$$

6. The radius (expression below) will be put into the third matrix object.

$$Col(i, j) = \begin{cases} 1 & \text{if } i \in [1, 32] \\ 0.7 & \text{if } i \in [33, 65] \\ 0.4 & \text{if } i \in [66, 98] \end{cases}$$

The way for setting the values for radius is also piecewise, you can refer to the step 3, 4, 5 and use the set value code below :

$$1*(j<33)+0.7*(j>33\&\&j<66)+0.4*(j>66)$$

7. After setting values for three matrix, you can convert the data to XYZ space by using **sph2cart**. Open the Script Window, type in code below and run:

```
sph2cart -d;
```

Setting the sph2cart dialog follows graph below, then click **OK**. Three new matrix for XYZ will be created.

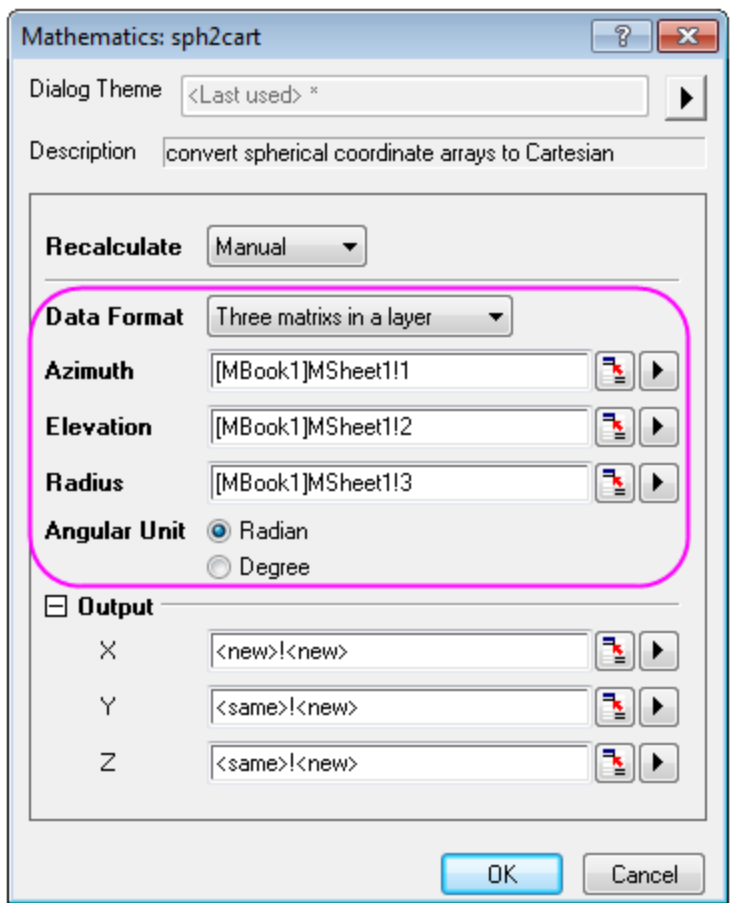

8. Create 3D surface graph by using XYZ matrix object created in new matrix layer. The steps are very similar to steps 5,6,7,8 in [above section](#) **Convert data in a matrix object and make a 3D surface plot.**

The finished Graph is showed below:

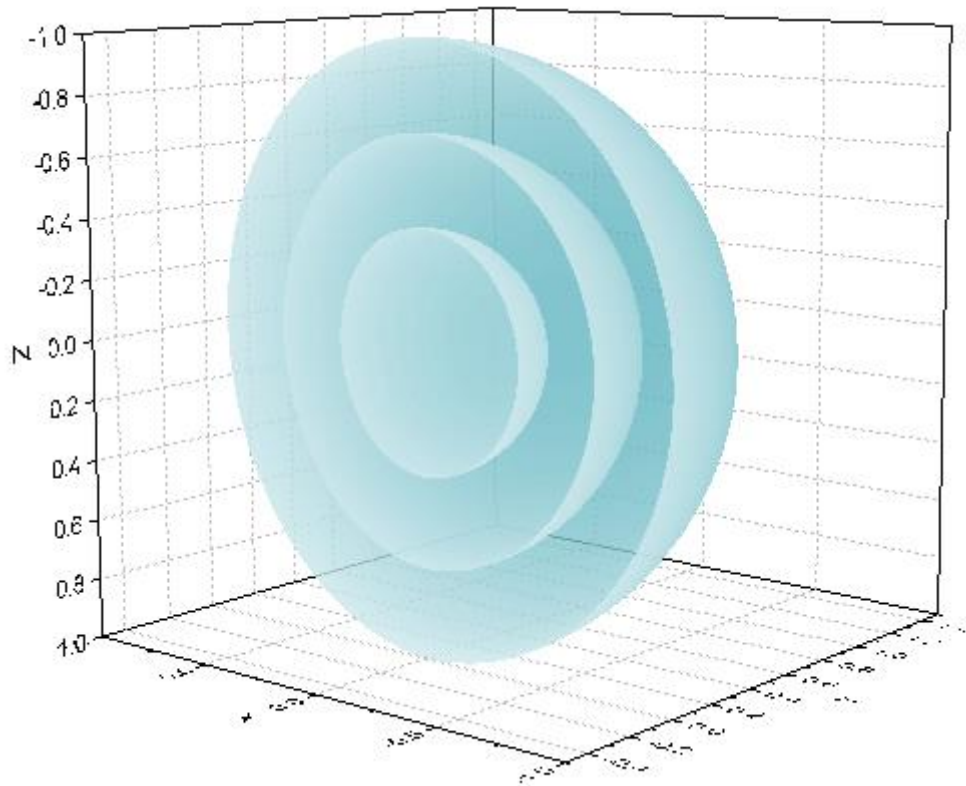

#### 6.13.21.3.4 Convert data in three columns and make a 3D space curve

Origin can create 3D space curve with unevenly spaced data in XYZ column (spherical coordinates). The following steps introduce the plot of a non-isometric spiral with a sphere shape.

1. Create a new workbook with three columns X, Y and Z. Set values from  $\frac{\pi}{100}$  to  $20\pi$  for X column by **Fill Column With: A set of Numbers**

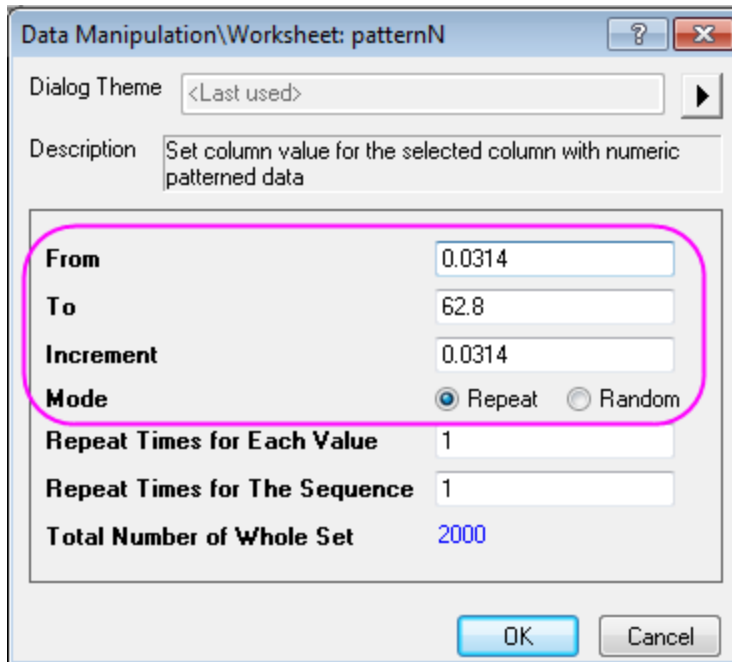

Set value for Y column by **Set Column Values**

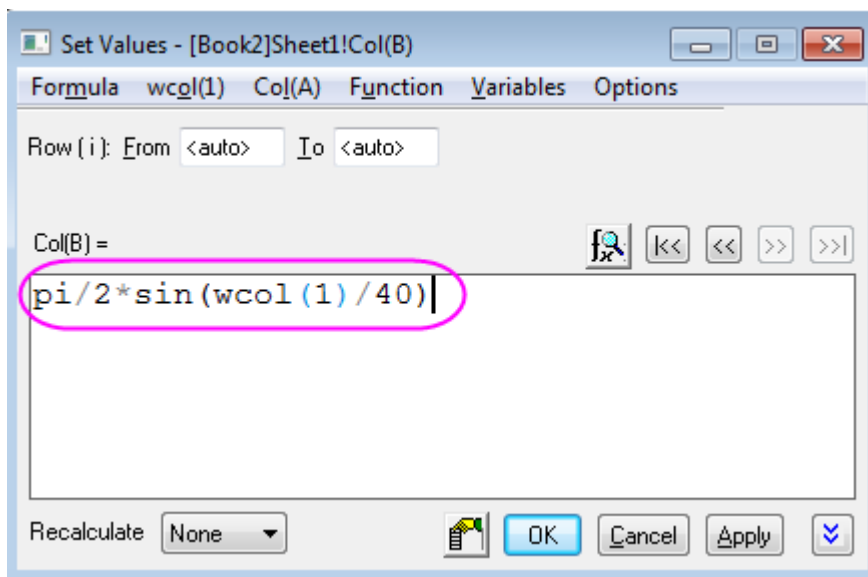

Set value for Z column by **Set Column Values** and set as constant value "4"

In this example, the X, Y, Z are corresponded to Azimuth, Elevation, Radius, respectively.

- Open the Script Window, type in code below and run:

```
sph2cart -d;
```

Setting the sph2cart dialog follows graph below, then click **OK**. Three new columns for XYZ will be created.

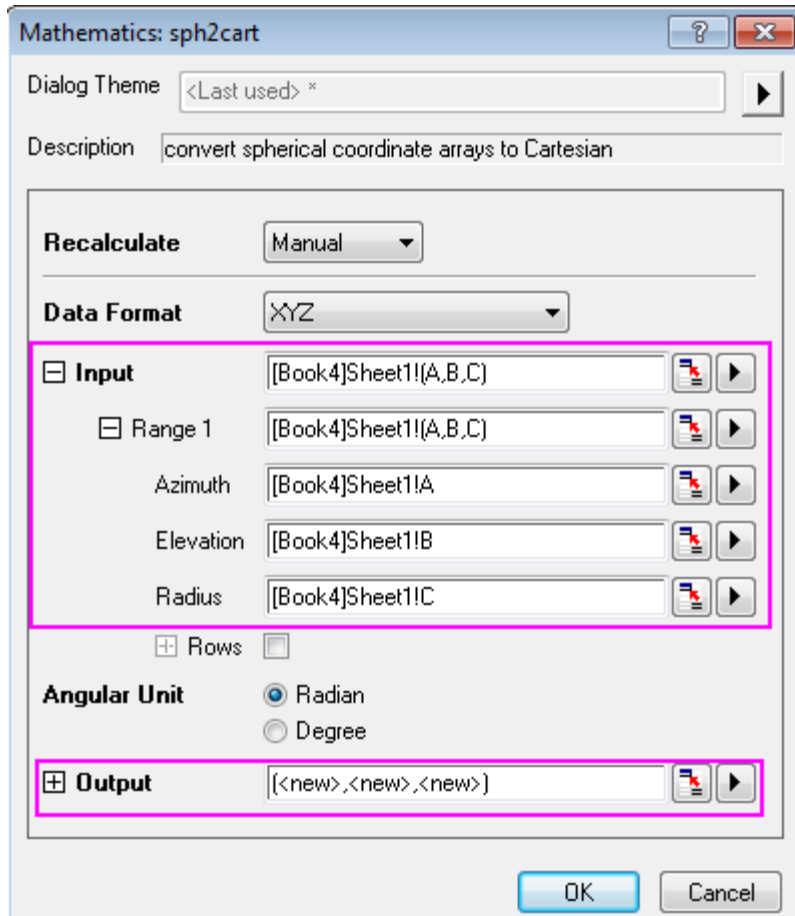

3. Plot the new XYZ with **Plot > 3D : 3D Scatter**. Set Symbol size to 0 and connect Symbols with line,click **OK**.

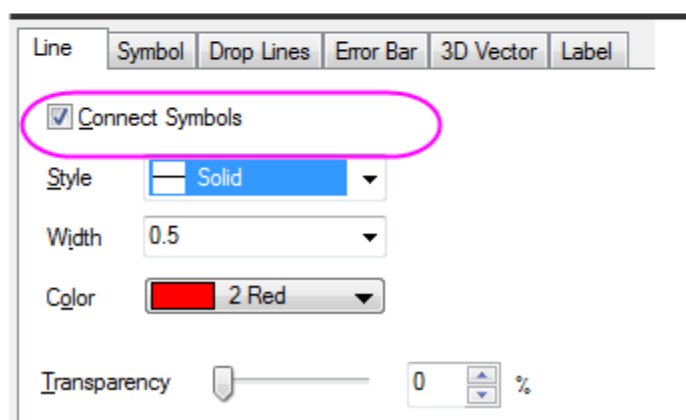
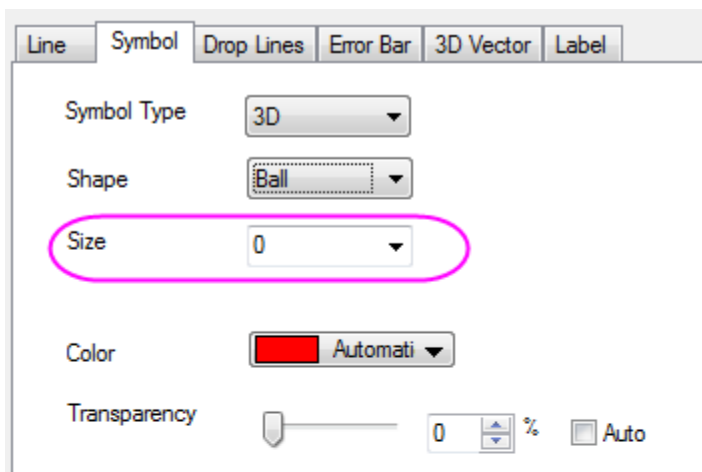

4. Further adjust the scales and the perspective view, the finished graph is similar to graph below:

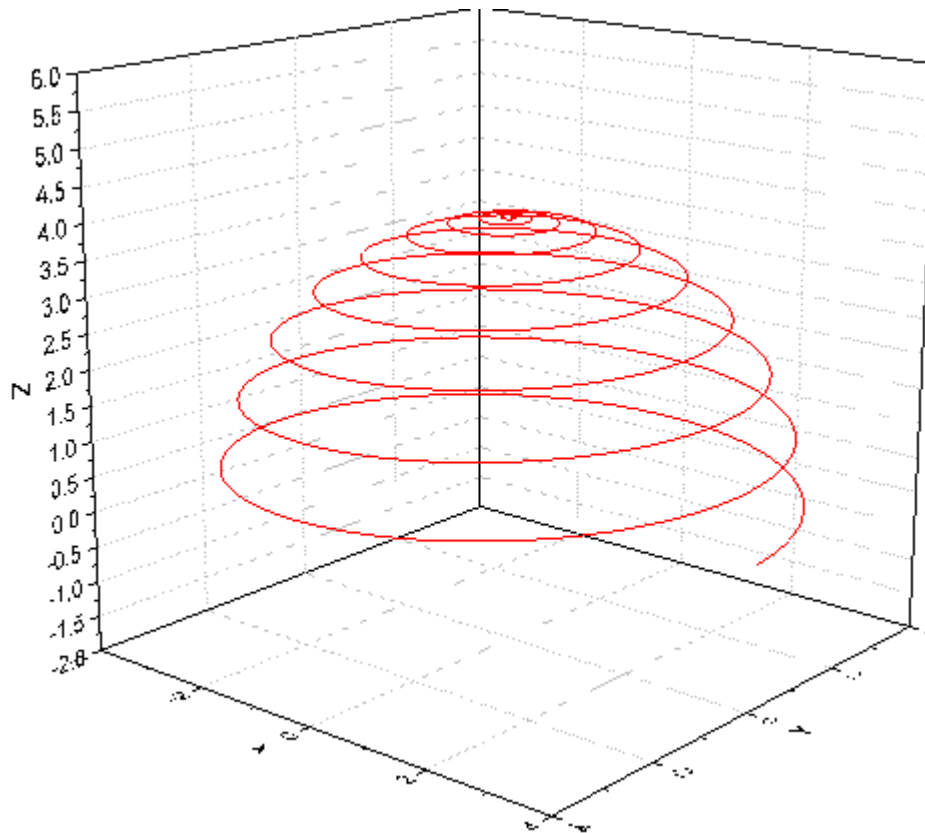

5. a 3D surface can be created with new created XYZ data as well by selecting **Plot > 3D : 3D Colormap Surface** with XYZ columns highlighted.



The azimuth and elevation in X and Y can be evenly or unevenly spaced in  $(r, \theta, \varphi)$  space.

### 6.13.22 Flattened Colormap Surfaces with Increasing Z Offset

#### 6.13.22.1 Summary

This tutorial will show you how to plot a stacked flattened colormap surface with Z offset.

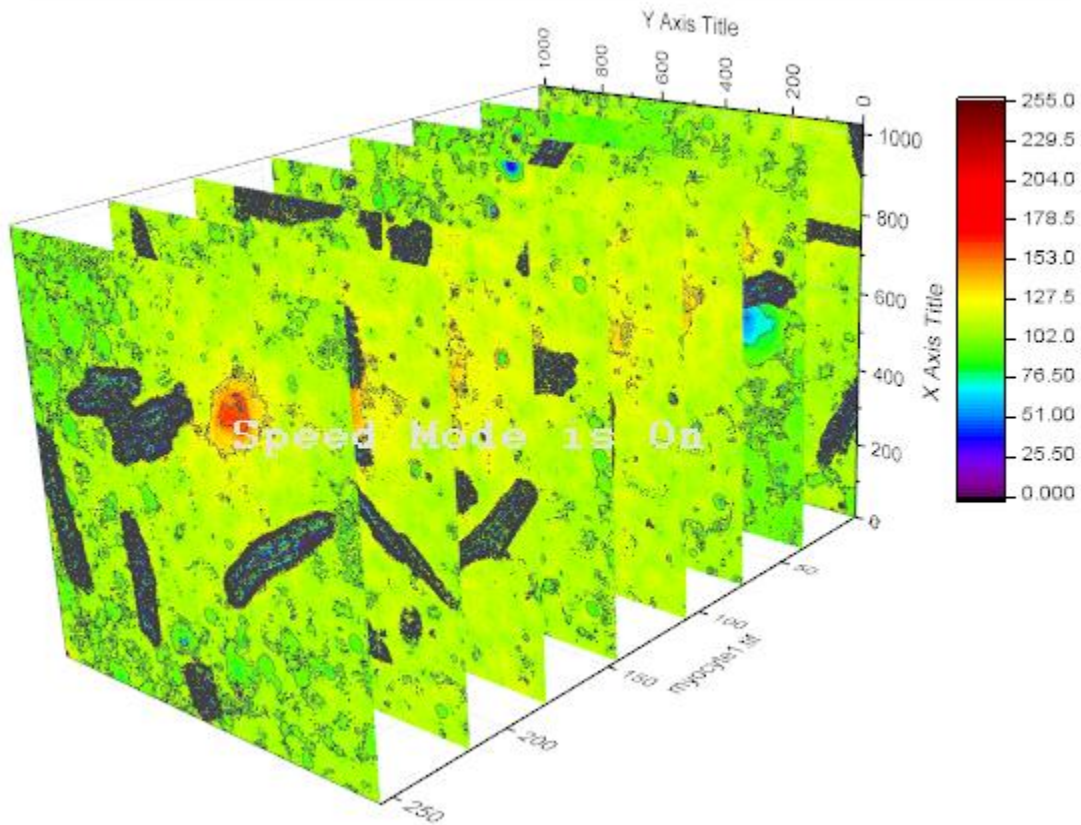

#### 6.13.22.2 What will you learn

- How to import multiple matrix into Origin as the matrix object.
- How to plot Multiple Colormap Surfaces in a graph layer.

#### 6.13.22.3 Steps

1. Create a new matrix and select **Data: Import from File: Image to Matrix** to import **myocyte1~myocyte8** under the *\Sample\Image Processing and Analysis* folder. In the **ImpImage** dialog, keep **Mult-File (except 1st) Import Mode** as **Start New Objects**.



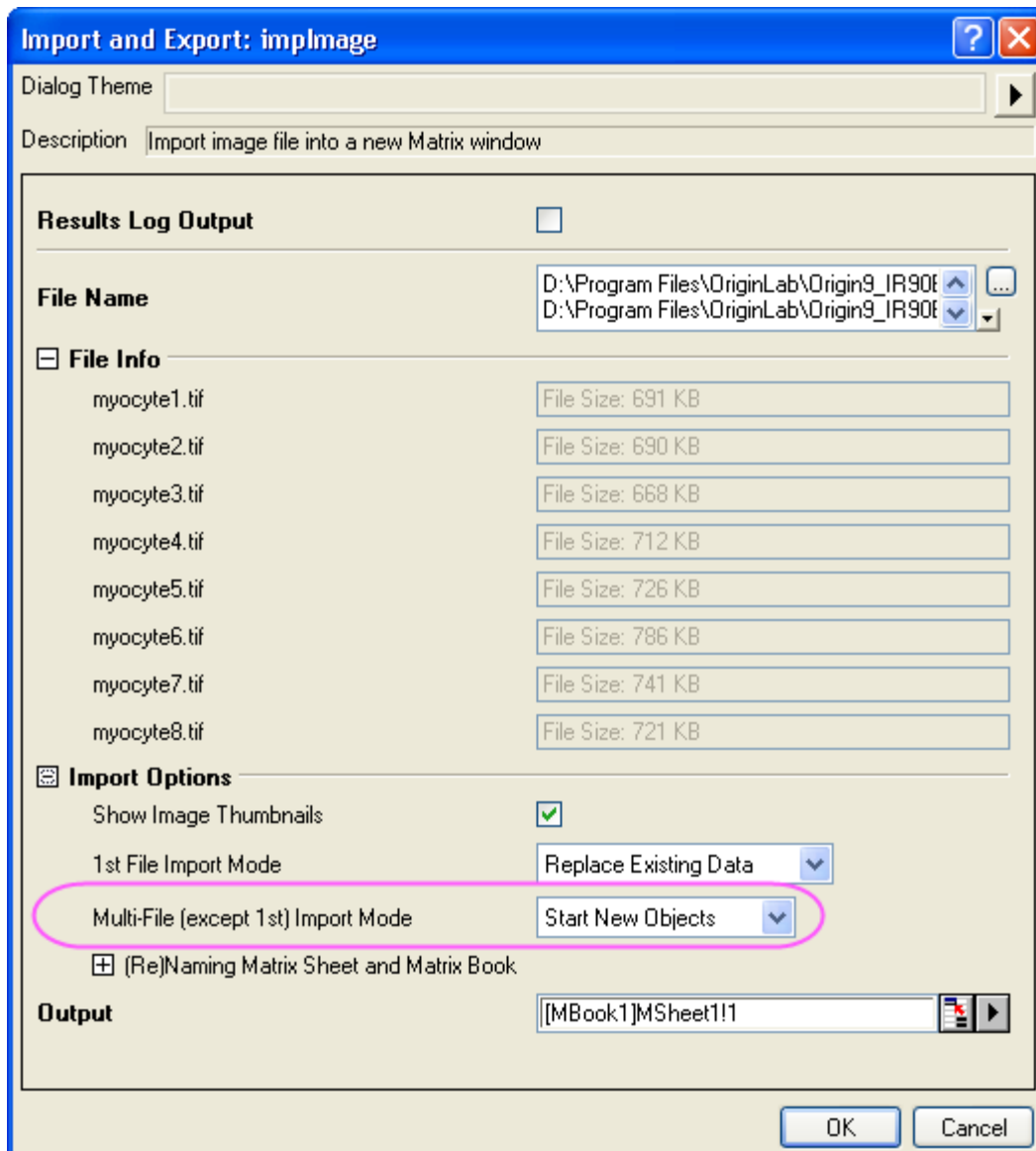

2. Click the OK button to import the files to matrix as matrix objects.



3. Select **Plot > 3D : Multiple Colormap Surfaces** from the main menu to plot a surface graph.

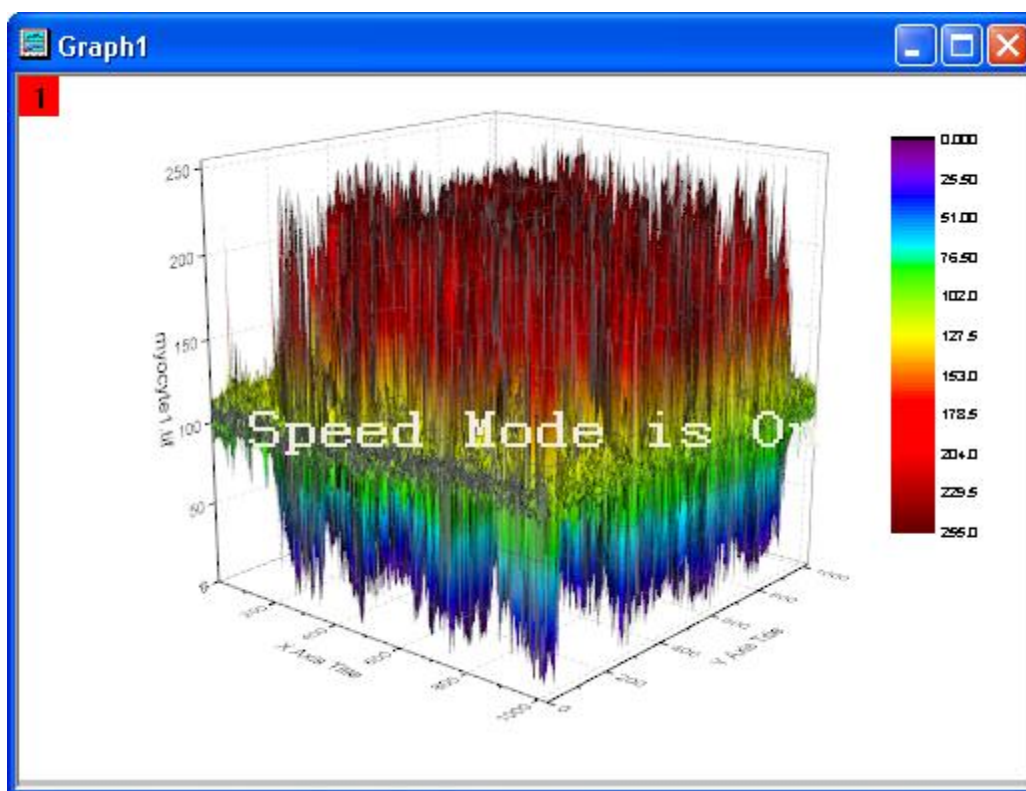

4. Select **Format: Plot** from the main menu to open the Plot Details dialog.
5. Select the first plot, check **Flat** and **Shift in Z by percent of scale range**, and set the shift value as 0. And go to the **Mesh** tab, uncheck the **Enable** check box to not show the grid lines.

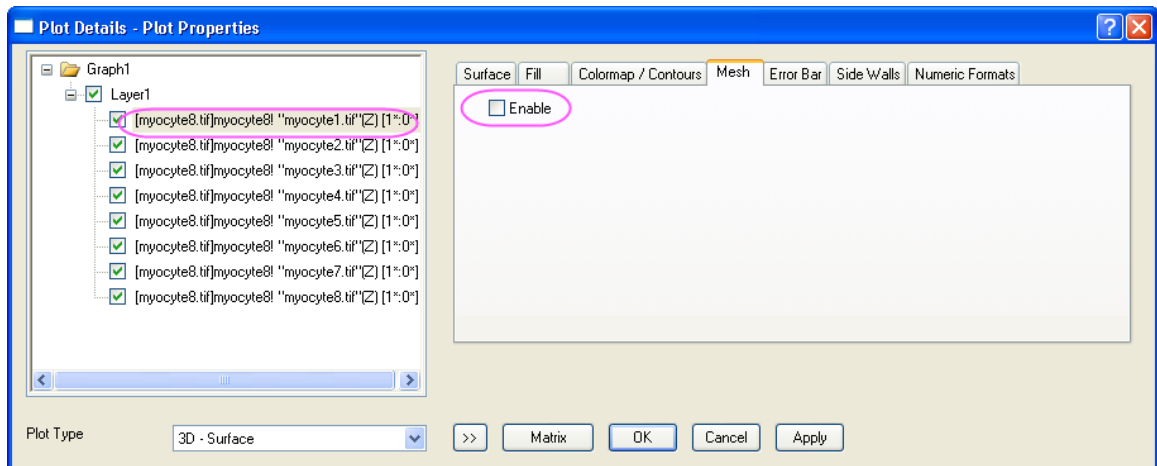
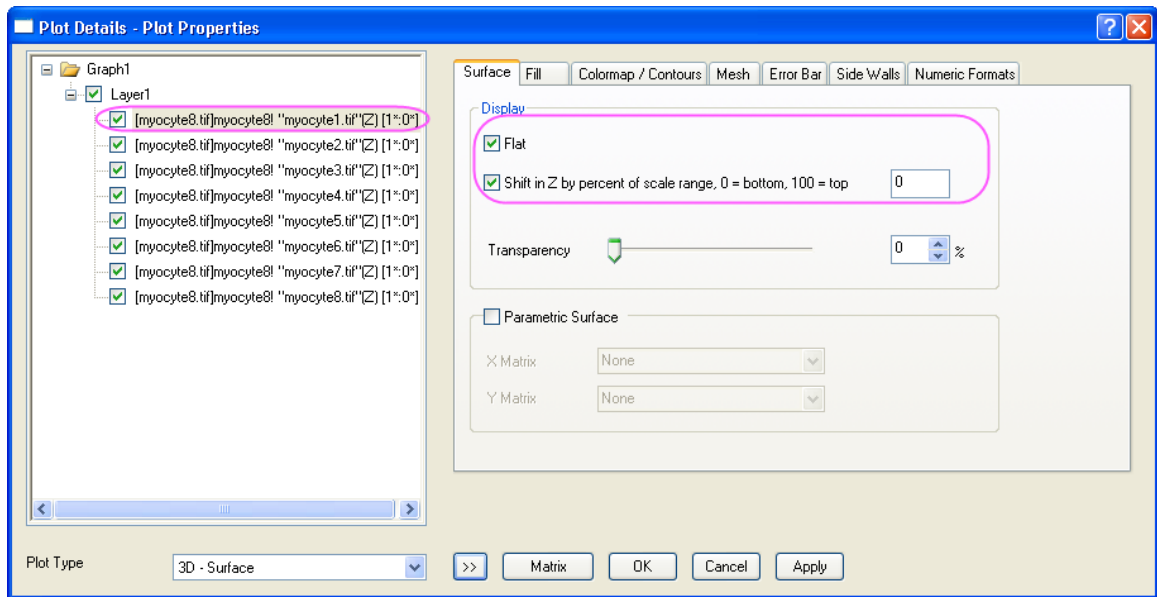

- Select the 2nd-8th plot in order, check **Flat** and **Shift in Z by percent of scale range**, and set the shift value as 14, 29, 42, 57, 71, 85 and 100. And go to the **Mesh** tab, uncheck the **Enable** check box to not show the grid lines. Click the OK button to close the dialog.

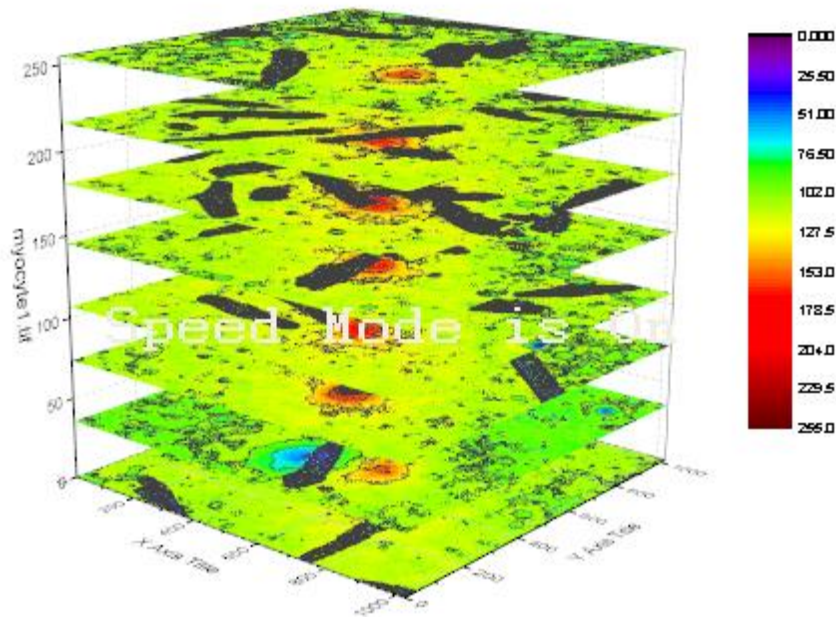

7. Rotate the graph to get a flattened colormap surface as shown below:

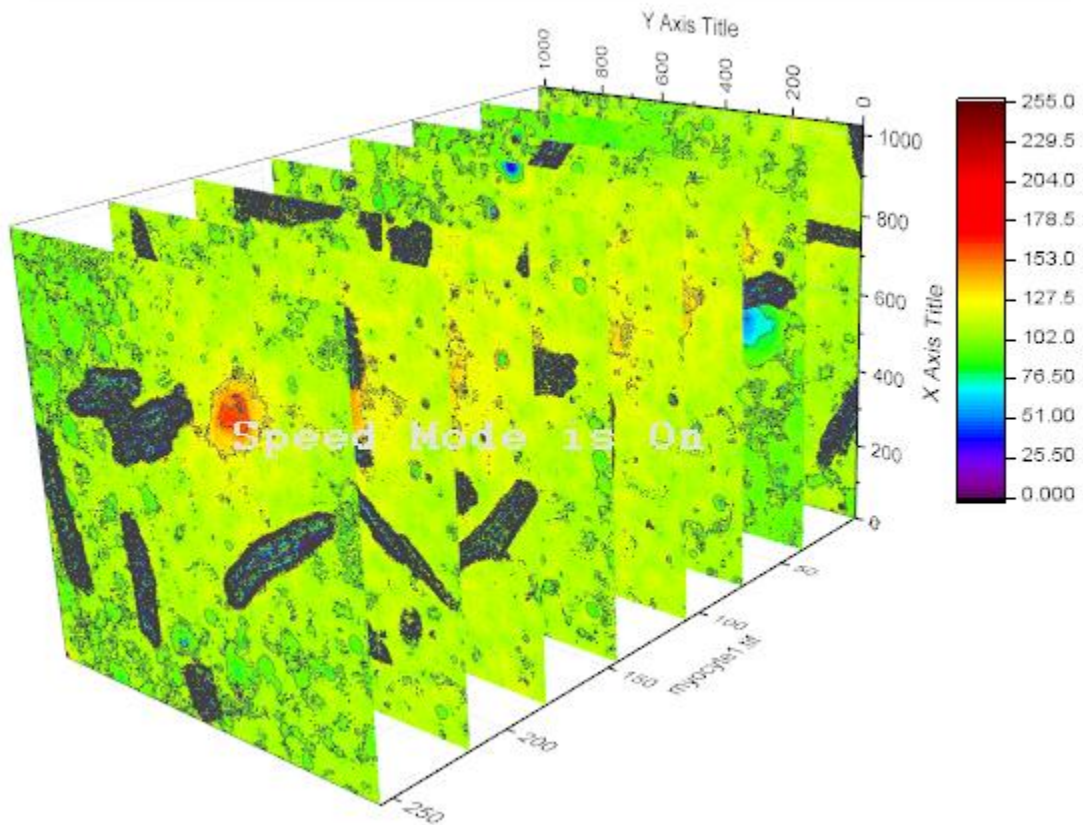

### 6.13.23 3D Ternary Colormap Surface with Contour Lines Projection

### 6.13.23.1 Summary

In this tutorial, a 3D ternary surface with Z colormap and its projection with contour lines are generated from XYZ worksheet data.

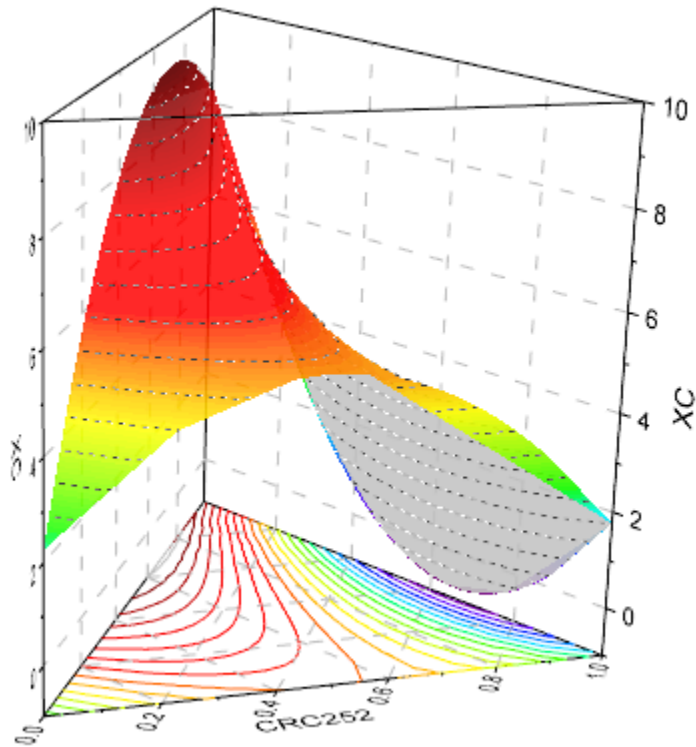

Minimum Origin Version Required: Origin 2015 SR0

### 6.13.23.2 What you will learn

This tutorial will show you how to:

- Generate a 3D ternary surface plot with Z colormap.
- Project color-mapped contour lines onto the XYZ axis plane.

### 6.13.23.3 Steps

#### 6.13.23.3.1 **Creating 3D ternary surface**

This tutorial is associated with the Tutorial Data project: <Origin EXE Folder>\Samples\Tutorial Data.opj.

1. Open the Tutorial Data project and browse to folder *3D Ternary Surface*.
2. Activate the worksheet **Ternary Surface** in **Book1F**, and highlight col(C) and col(D). Select **Plot > 3D :3D Ternary Colormap Surface** to generate a colormap surface.

- We will modify the plot to show the edges of the 3D prism. Double-click on the plot to open the **Plot Details** dialog box. Highlight **Layer1** in the left panel (take care not to clear the check mark beside the Layer1 icon). Go to the **Plane** tab, set **Prism** to **Whole Prism** and enable **Plane Border**.

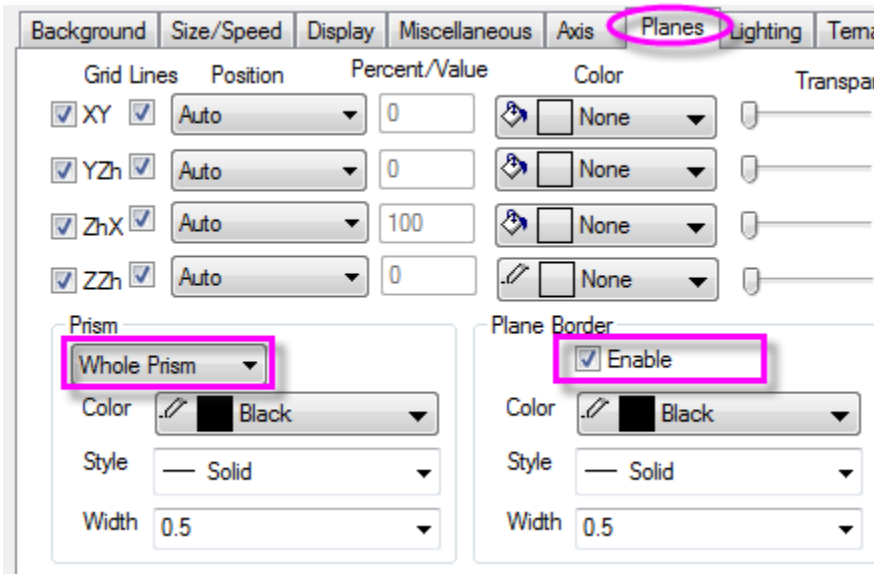

- Expand the **Layer1** node, highlight the dataplot icon and click the **Fill** tab. Check **Enable** box and select **Colormap**. Check the box beside **Fill back surface** and set color as **LT Gray**.

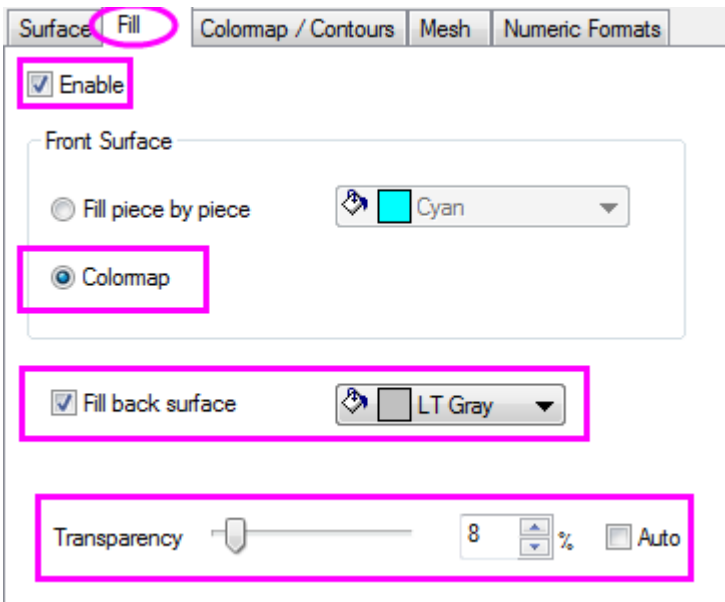

- Click the **Colormap / Contours** tab. Click the **Level** heading and in the **Set Level** dialog box, set controls as follows, then click **OK** to close the dialog box.

From: -0.8

To: 9.45

Type:  Linear

Increment: 0.5125

# Major Levels: 20

# Minor Levels: 5







Total # of Levels: 120

First Level:

6. To add contour lines on the ternary surface, check the box next to **Enable Contours**.

Surface Fill **Colormap / Contours** Mesh

Click column header or cell to edit

Level...	Fill...	Line...
< -0.8		
-0.8		.....
-0.7146		
-0.6292		
-0.5437		
-0.4583		
0.3728		

Level

Enable Contours

Insert

7. To customize the contour lines, click the **Line** heading to open the **Contour Lines** dialog. Under *Line Properties*, check the box before **Color** and **Style** and set the Color as **Dark Gray** and Style as **Short Dash**, then click **OK**.

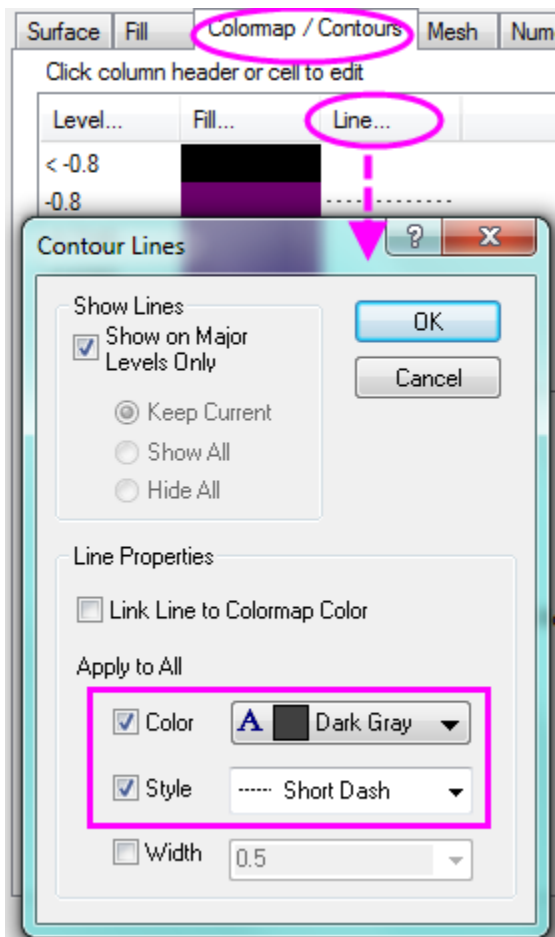

- Go to the **Mesh** tab, clear the **Enable** box, then click the **OK** button.

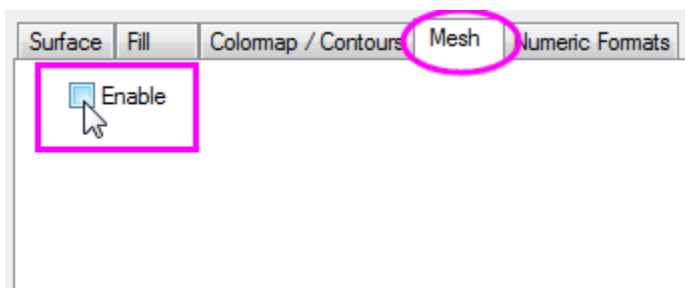

- To customize the scale and the major ticks of the X/Y/Z axes, click on a graph axis to open the **Axis Dialog** box. Expand the X, Y and Z nodes, then press CTRL while selecting **Scale** for the **X**, **Y** and **Z** axes. Set **Major Ticks > Value** to **0.2**.



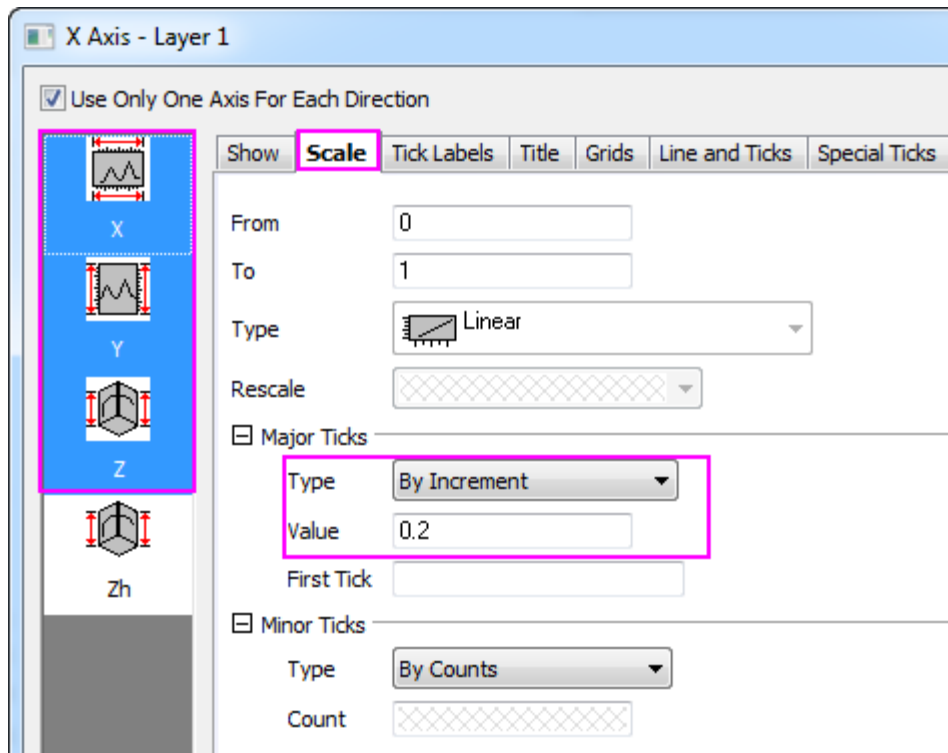

10. Expand the Zh axis node and select **Scale**. Duplicate the scale range and the **Major Ticks > Value** settings as shown below.

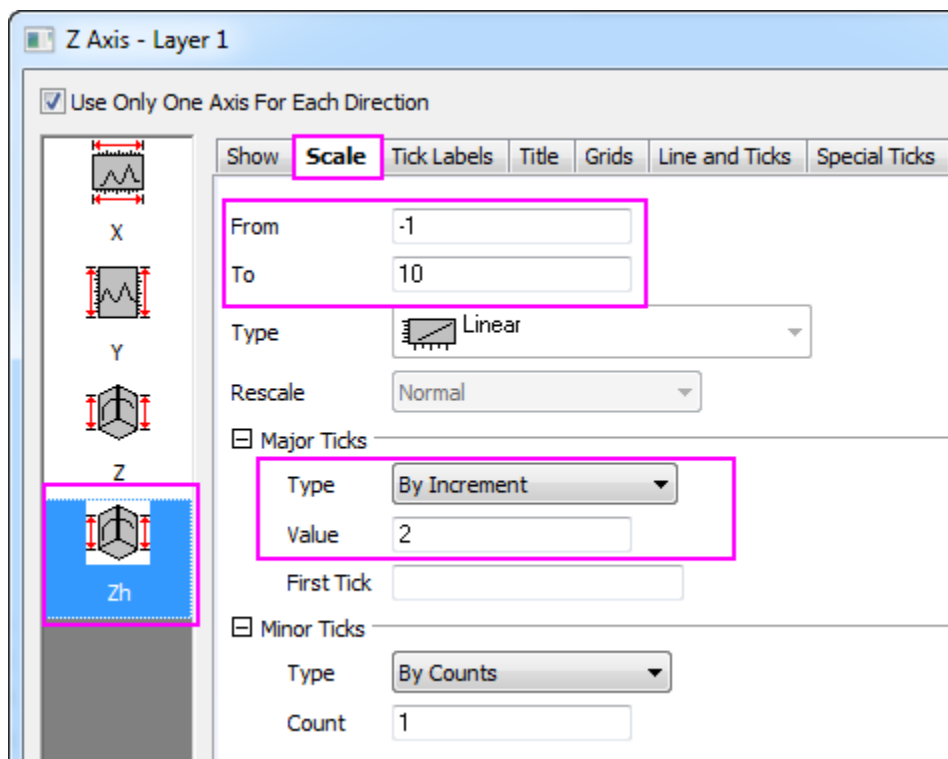

11. Click **OK** to close the **Axis Dialog** box.

### 6.13.23.3.2 Creating projection with contour lines

1. With the graph page active, select **Graph: Layer Contents** from the main menu to open the Layer Contents dialog. Select **Worksheets in Folder** from the drop-down.
2. To add another ternary surface to the graph, press CTRL and in the left panel, select the datasets **XC** and **CRC299** of sheet "Ternary Surface", then click the **Add plot** button  to add them to the right panel. Click **OK**.

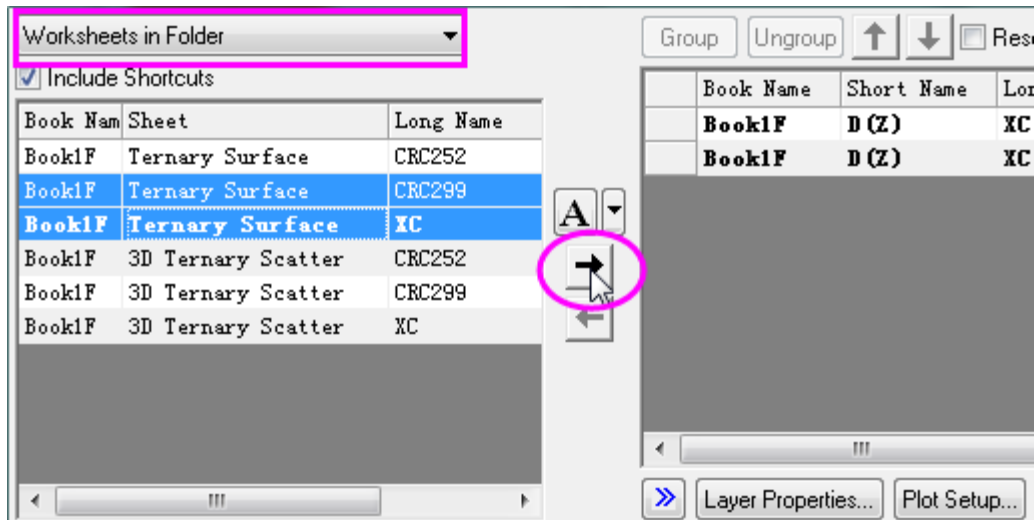

3. Double-click on the plot to bring up the **Plot Details** dialog box. Under **Layer1**, click on the second plot, then click on the **Surface** tab. Under **Display**, choose **Flat** and **Shift in Z by percent of scale range, 0 = bottom, 100 = top**.

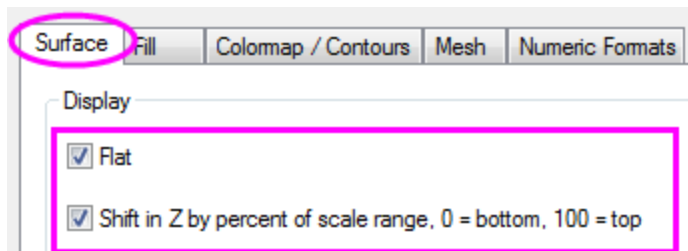

4. On the **Colormap / Contours** tab, select **Enable Contours**. Click the **Line** heading and edit the **Contours Lines** dialog box settings as in the following image and then click **OK**.

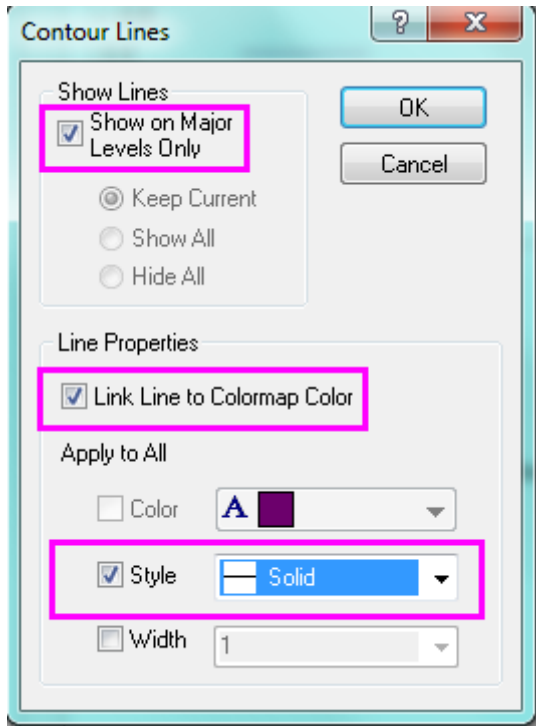

- On the **Colormap / Contours** tab, click the **Level** heading and in the **Set Level** dialog box, set **# Major Levels** to **20** and **# of Minor Levels** to **5**. Click **OK** to close the dialog box.
- Go to **Fill** tab and clear the **Enable** box.

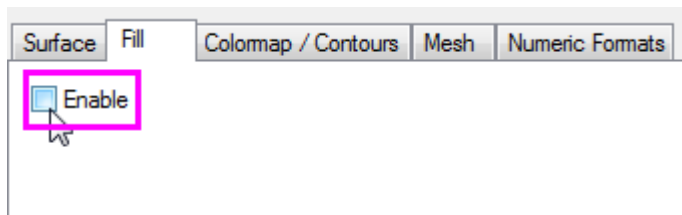

- On the **Mesh** tab, clear the **Enable** box. Click **OK** to close the dialog box.
- To change the grid lines on the axis planes dashed lines, double click the axis to bring up the **Axis Dialog** box. In the left panel, expand the **X** node and select **Grids**. Press **Select Others** to choose grids for all the axis planes. Customize the *Major Grid Lines* section as follows:

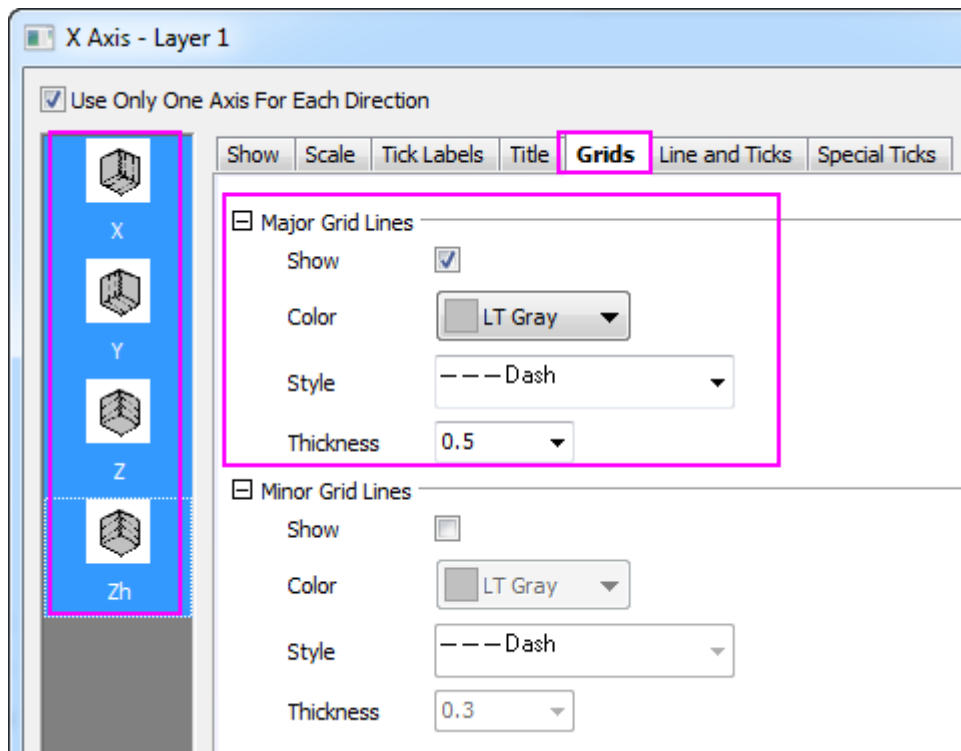

9. Rotate the plot by dragging a hotspot (hint: click once inside the graph frame - but not on the plot -- to activate the move/resize/rotate functions). Alternately, you can use the tools on the 3D Rotation toolbar.

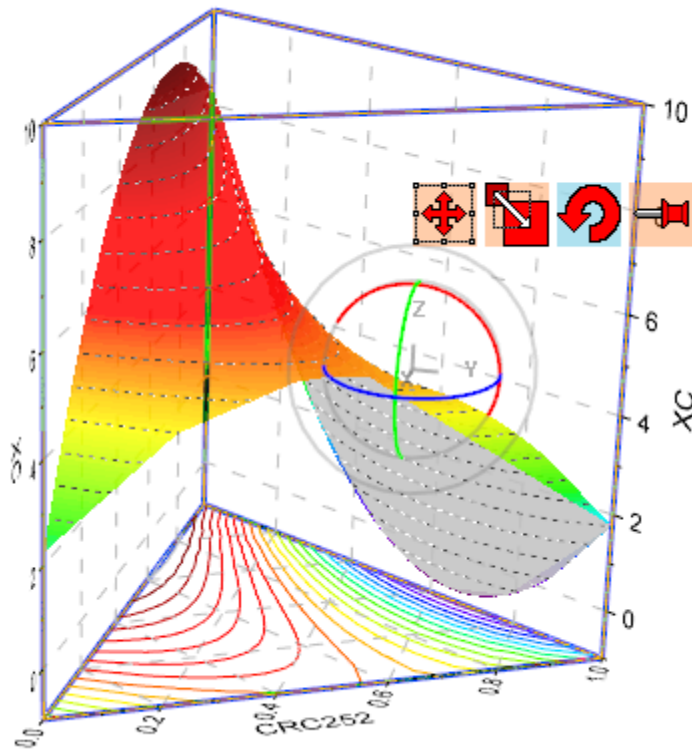

## 6.14 Plot Functions with Parameters Defined in a Worksheet

### 6.14.1 Summary

Origin can plot functions. It also can plot functions with parameters defined in a worksheet. The function graph can be updated automatically as the parameters in the worksheet change.

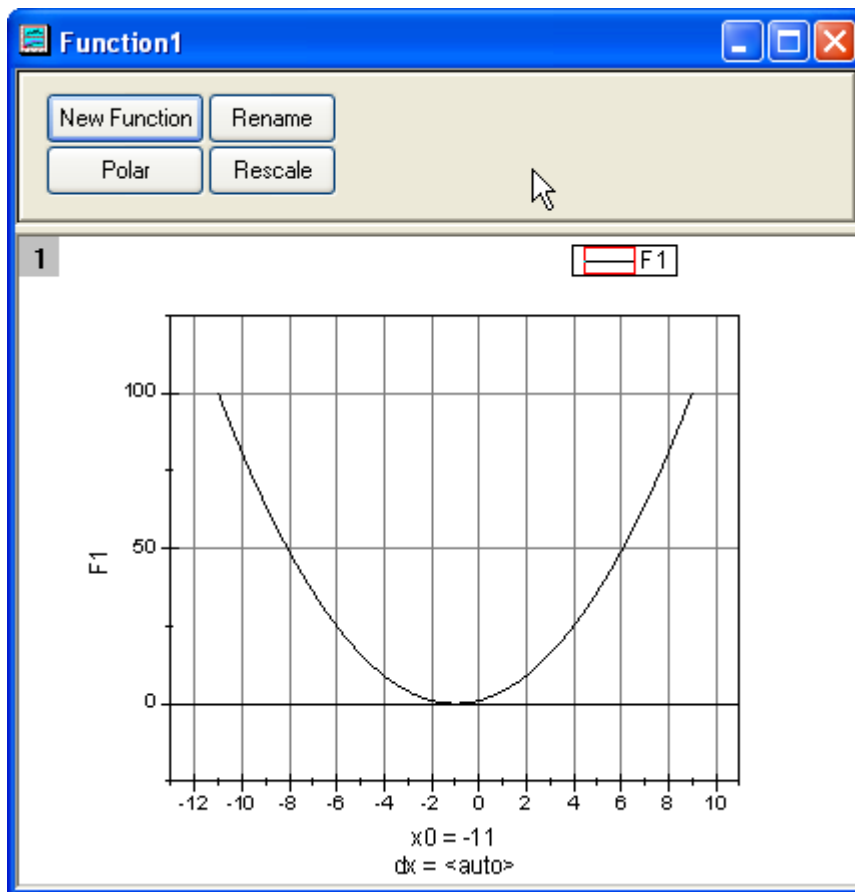

Minimum Origin Version Required: Origin 8.0 SR6

### 6.14.2 What you will learn

This tutorial will show you how to:

- Define variables from a worksheet in the **Set Values** dialog box.
- Plot a function graph with parameters.
- Update a graph automatically when parameters are changed.

### 6.14.3 Steps

Let us use this function as an example:  $y=p_0+p_1*x+p_2*x^2$

1. Set up a worksheet with three parameters  $p_0$ ,  $p_1$ ,  $p_2$  stored in Column A, Column B, Column C as shown below.

	A(Y)	B(Y)	C(Y)
Long Name	p0	p1	p2
Units			
Comments			
1	1	2	1
2			

2. Click on the **Add New Columns** button  on the **Standard** toolbar to add a new column to the worksheet.

	A(Y)	B(Y)	C(Y)	D(Y)
Long Name	p0	p1	p2	
Units				
Comments				
1	1	2	1	
2				

3. Highlight Column D and then select **Column: Set Column Values**. Select **Auto** from the **Recalculate** drop-down. Type the [script](#) shown below to define the parameters in the **Before Formula Scripts** edit box. Click the **OK** button to close the dialog box.

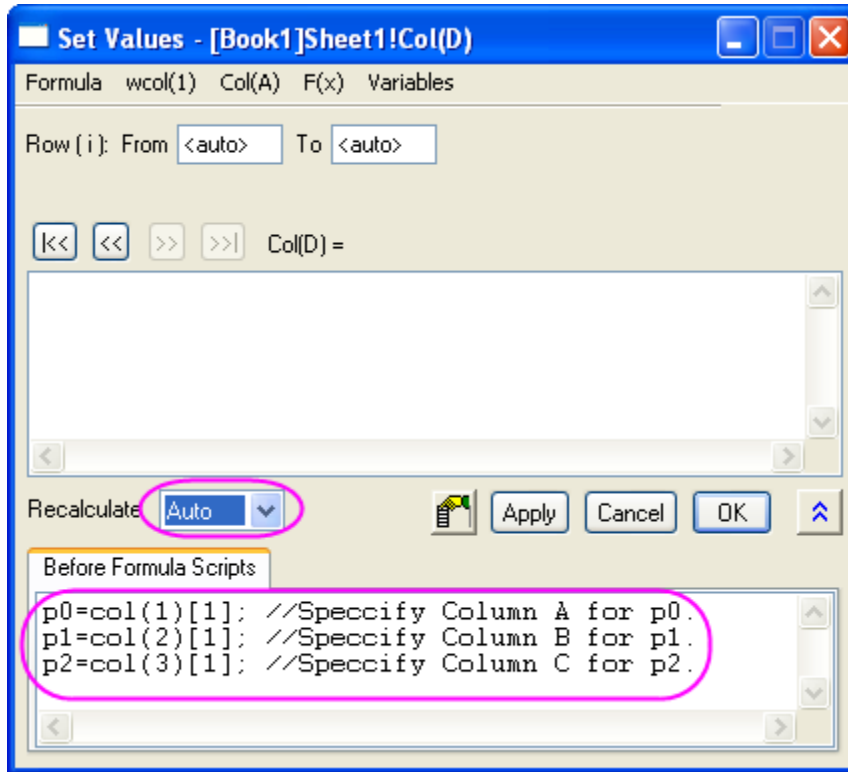

Note that there is a green lock icon  on the top right corner of Column D which indicates that the Recalculate Mode is Auto.

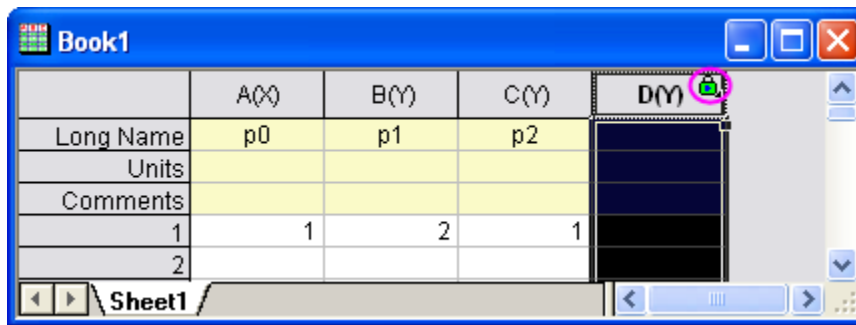

- Click on the **New Function** button  on the **Standard** toolbar (If there is not **New Function** button, select **View: Toolbar** to open the **Customize** dialog, and then go to **Button Groups** tab, select **Standard** group, and then drag the **New Function** button to **Standard** toolbar. ). The **Plot Details** dialog opens.
- In the **Plot Details** dialog, set the options as follows and click the **OK** button to close the dialog box.



Plot Details - Plot Properties

Line Function

Points From To

x 100 -11 9  Auto

Y(x) =  $p_0 + p_1 * x + p_2 * x^2$

Before Formula Script

<< Workbook OK Cancel Apply

Click on the **Rescale** button  on the **Graph** toolbar to adjust the graph's scales.

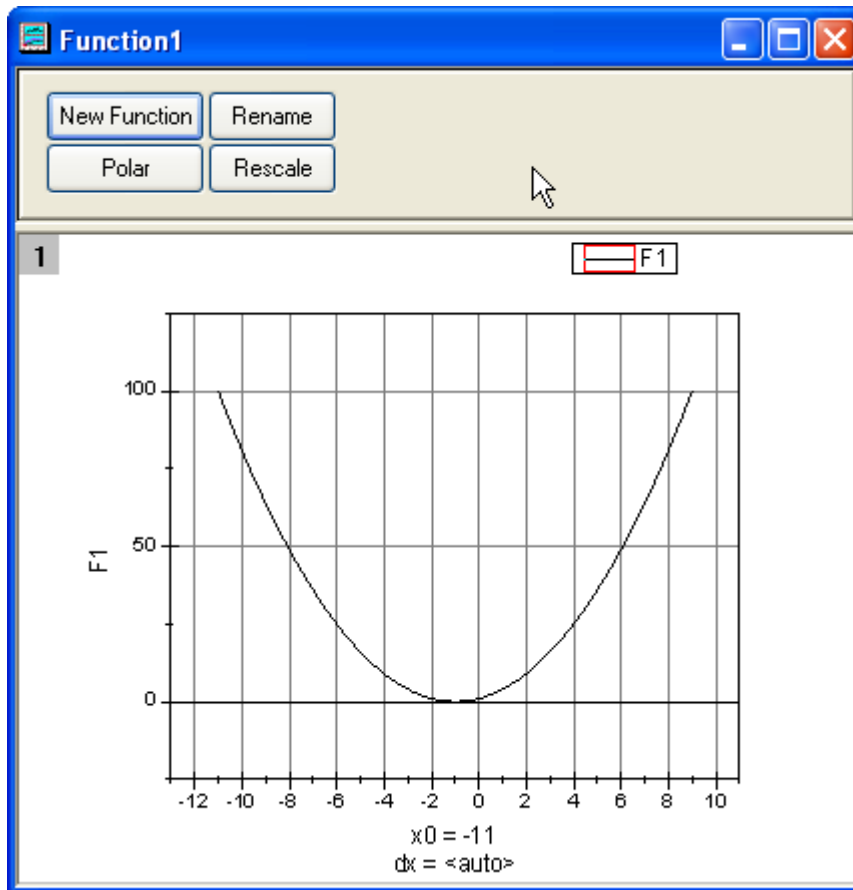

- The function graph can be updated automatically when the parameters in the first row of the worksheet change. Change the value in the first row of Column 2 from **2** to **3**. Click outside this cell to finish editing.

	A(Y)	B(Y)	C(Y)	D(Y)
Long Name	p0	p1	p2	
Units				
Comments				
1	1	3	1	
2				

The function graph updates to reflect this change.

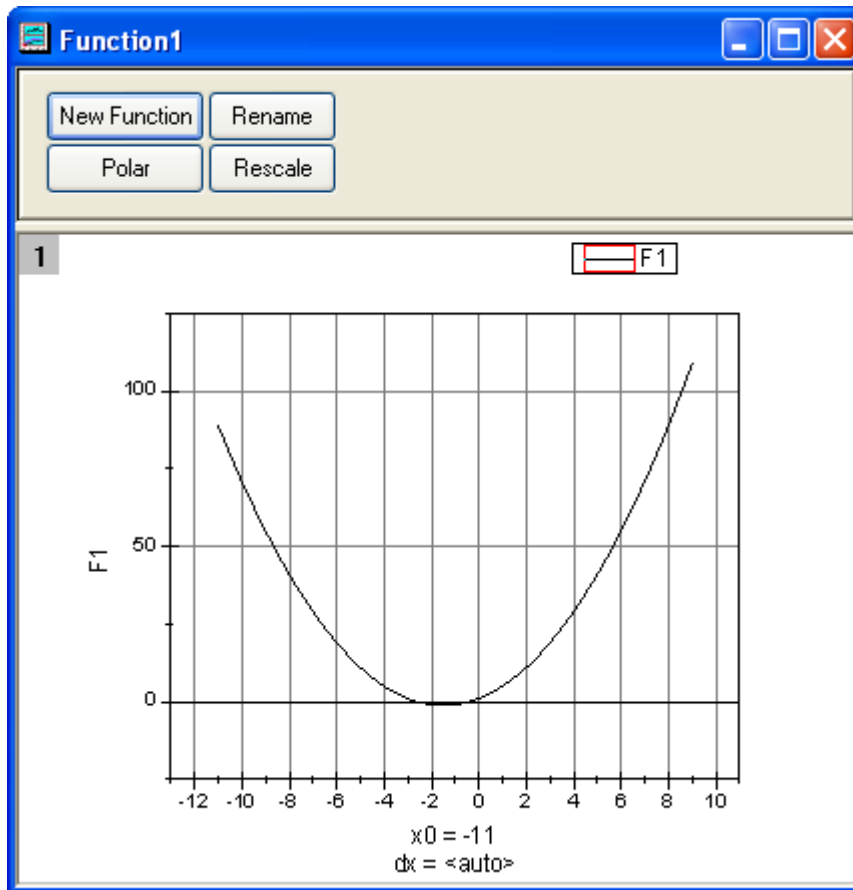

#### 6.14.4 Scripts

The script used in the **Before Formula Scripts** edit box of the **Set Values** dialog box is:

```
p0=col(1)[1]; //Specify Column A for p0.
p1=col(2)[1]; //Specify Column B for p1.
p2=col(3)[1]; //Specify Column C for p2.
```

The function in the **F1(x)** edit box of the **Plot Details** dialog box is as follows:

```
p0+p1*x+p2*x^2
```

### 6.15 Windrose Graph

#### 6.15.1 Summary

Windrose graphs are used to present wind speed data and wind direction data collected over time at a particular location. This tutorial will demonstrate how to create windrose graphs from both raw and indexed data:

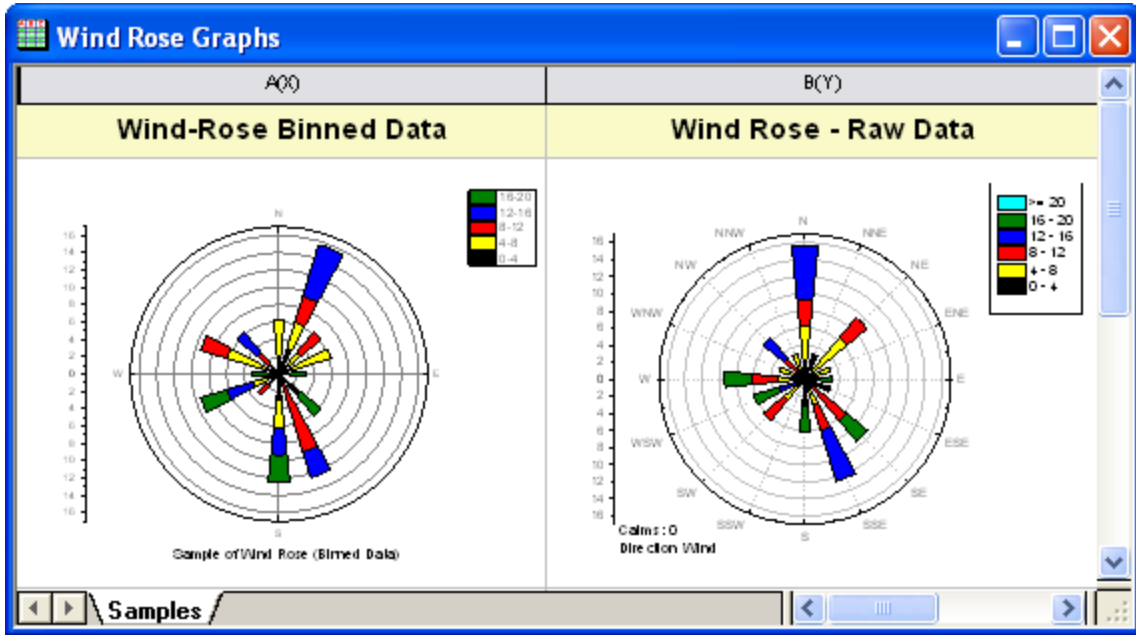

Minimum Origin Version Required: Origin 9.1 SR0

### 6.15.2 What will you learn

This tutorial will show you how to:

- Create a windrose graph from binned data
- Customize the direction tick labels on the windrose graph
- Create a windrose graph from raw data

### 6.15.3 Steps

This tutorial is associated with <Origin EXE Folder>\Samples\Tutorial Data.opj.

Also, you can refer to this graph in Learning Center. (Select **Help: Learning Center** menu or press **F11** key , and then open **Graph Sample: Specialized Graphs**)

#### 6.15.3.1 Part 1: Create a Windrose Graph from Binned Data

1. Open **Tutorial Data.opj** and browse to the **Wind Rose** folder in **Project Explorer** (PE).  
(If you don't have the project file, please import the sample data from [here](#)).
2. Activate the **Book6E** workbook. Highlight all worksheet columns and click the **Wind Rose - Binned Data** button on the **2D Graphs** toolbar as shown below or select **Plot: Specialized: Wind Rose-Binned Data** from the main menu.

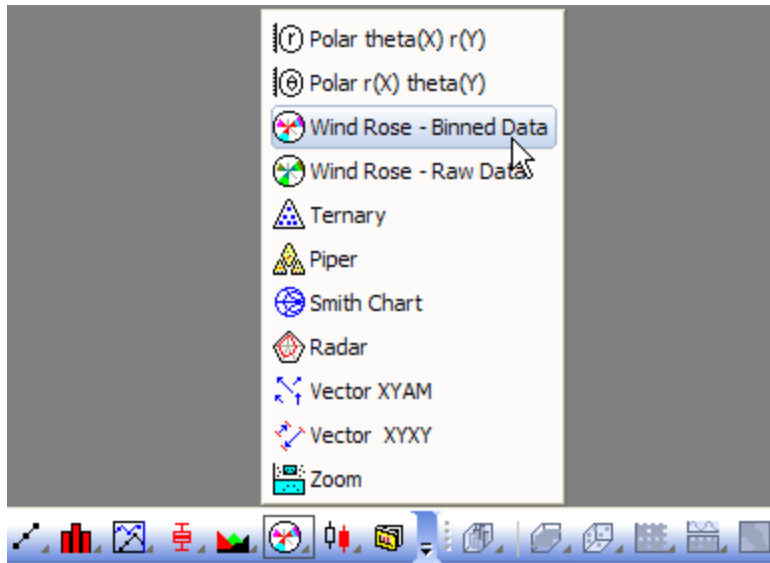

The wind rose graph should look like the following image:

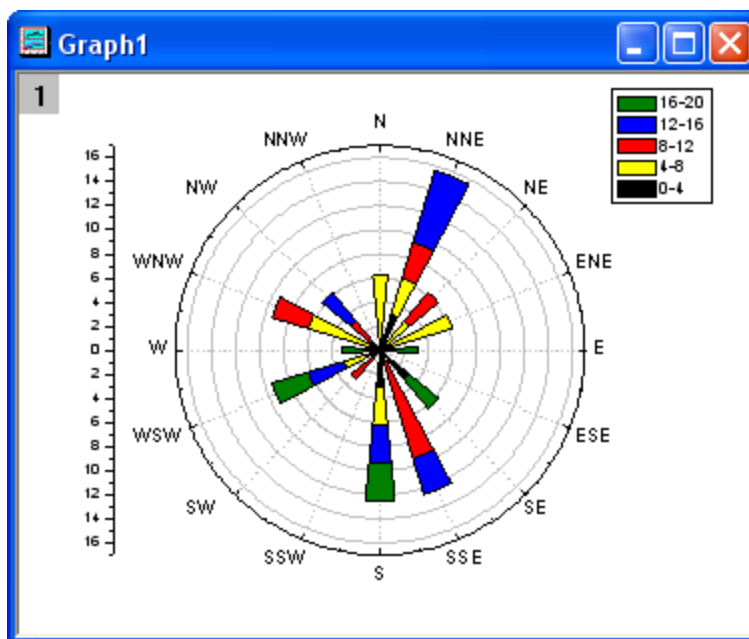

- To change the wind direction to show only N,E,S,W double-click on the angular axis (the outermost ring) to open the **Axis** dialog box. Go to **Scale** tab and choose **Angular** axis in the left panel. Under **Major Ticks** section, set **Type** to **By Increment** and **Value** to **90**

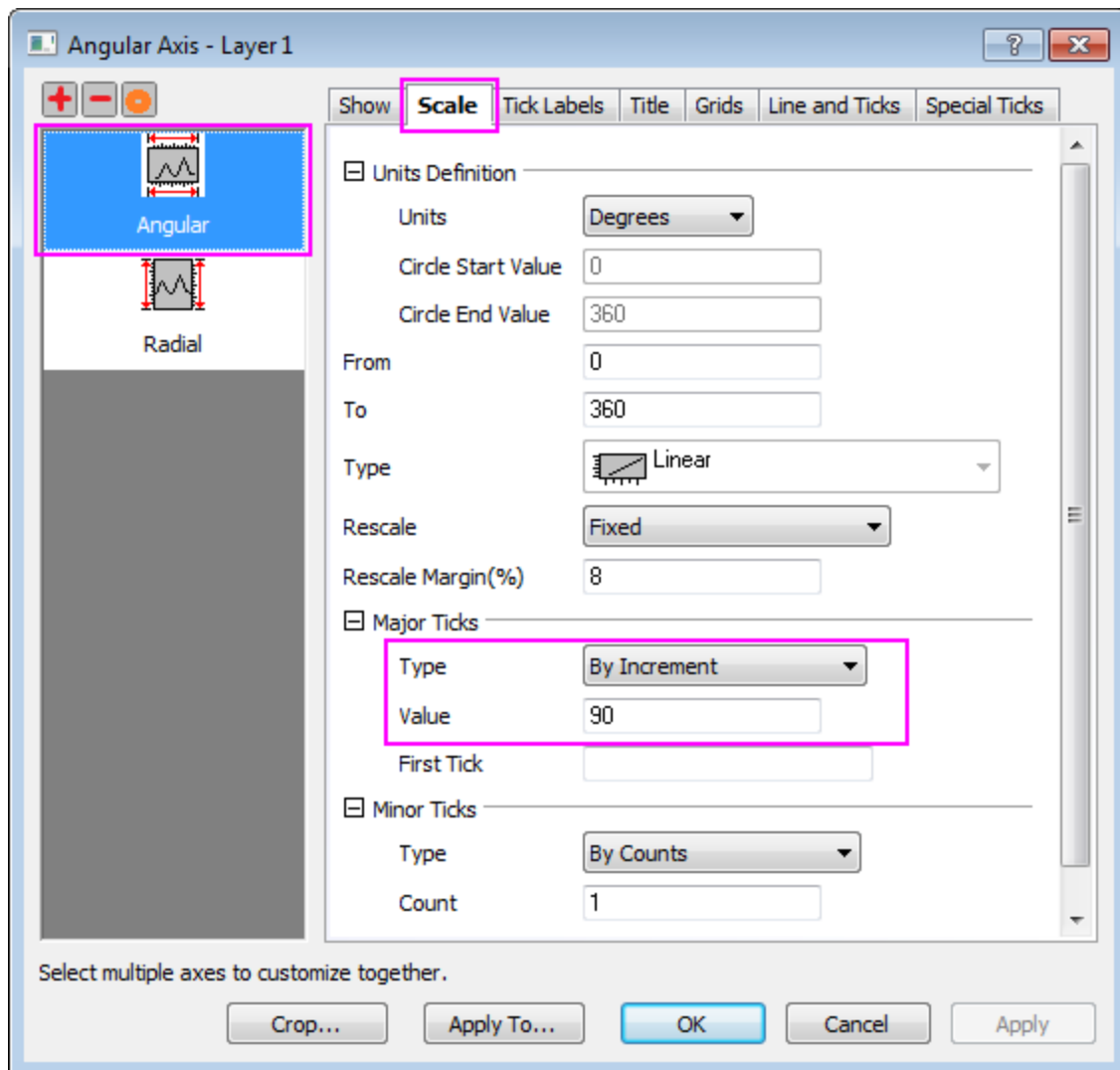

4. Go to **Tick Labels** tab, make sure the **Angular - Outer** axis is selected in the left panel, and duplicate the following settings:

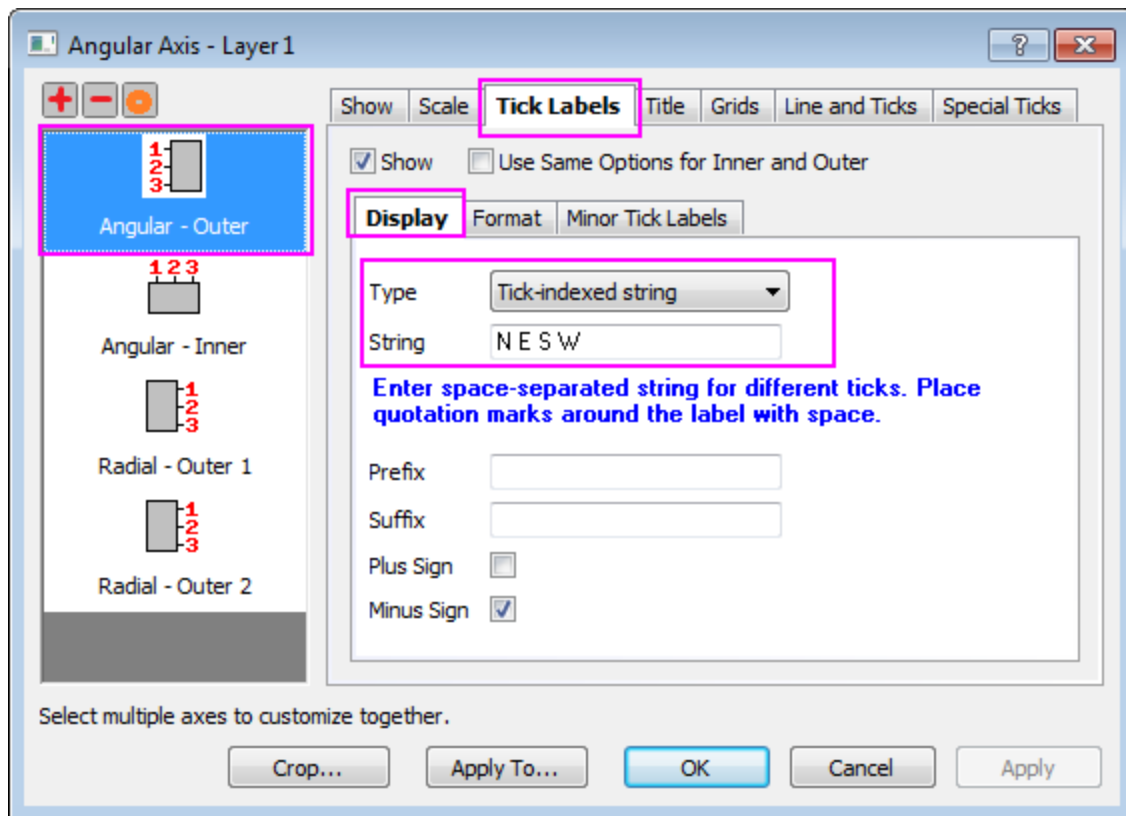

5. Click **OK**. The graph should look like this:

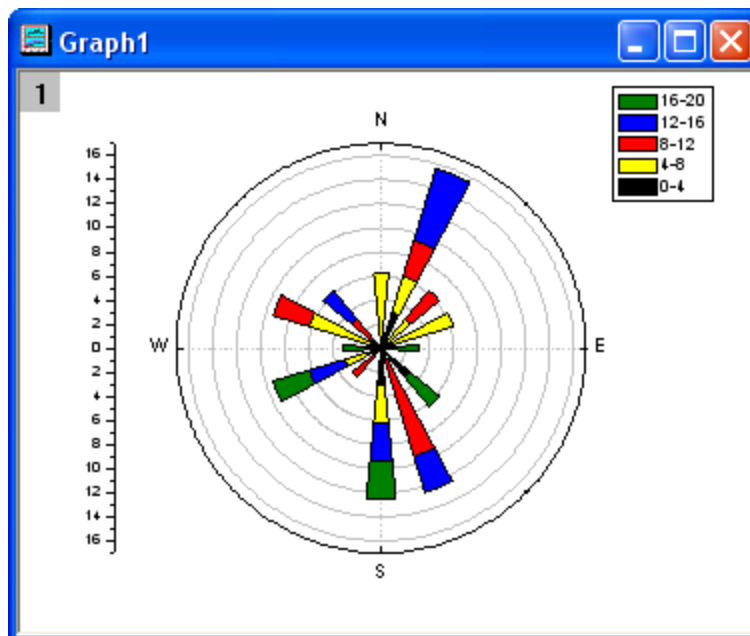

- Click on the **Text Tool** button  to add a **Text** object as graph title. And enter *Sample of Wind Rose (Binned Data)* in that **Text** object.

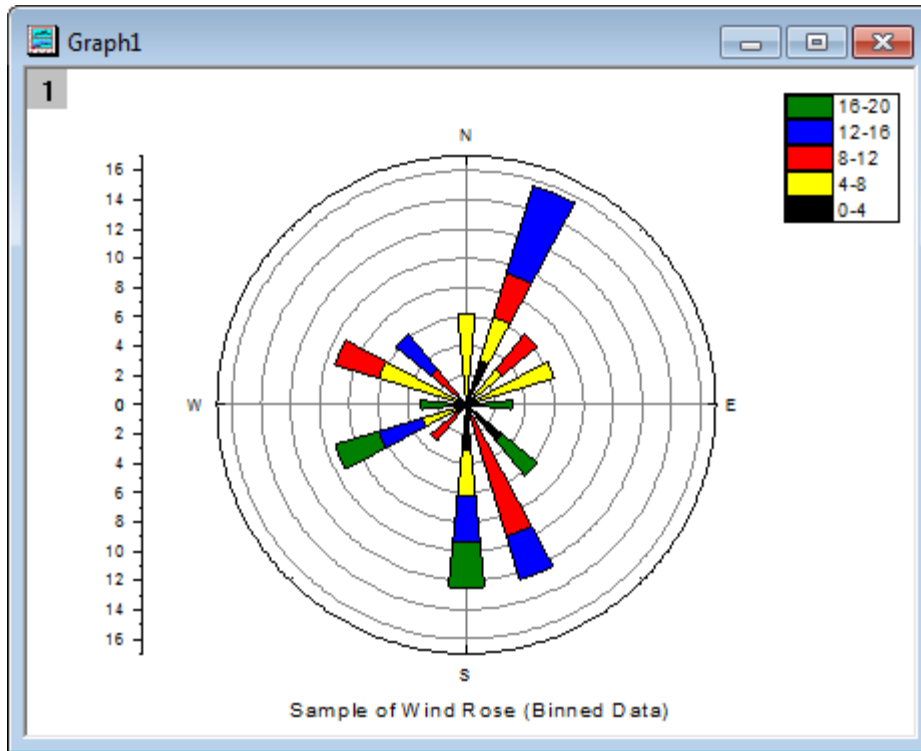

#### 6.15.3.2 Part 2: Create a Windrose from Raw Data

- Go to the project folder *Statistical and Specialized Graphs: Specialized: Wind Rose* and activate the **Book7E** workbook, **Raw Data** worksheet. (If you don't have the project file, please import the [sample data](#) from here).
- Highlight columns A & B. Click the **Wind Rose - Raw Data** button on the 2D Graphs toolbar as shown below or select **Plot: Specialized: WindRose - Raw Data** from the main menu.



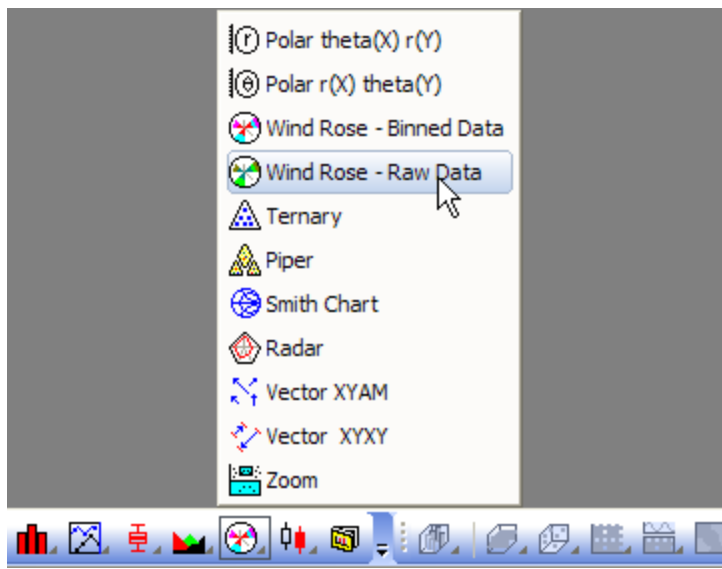

- Use the settings below to create the wind rose graph:

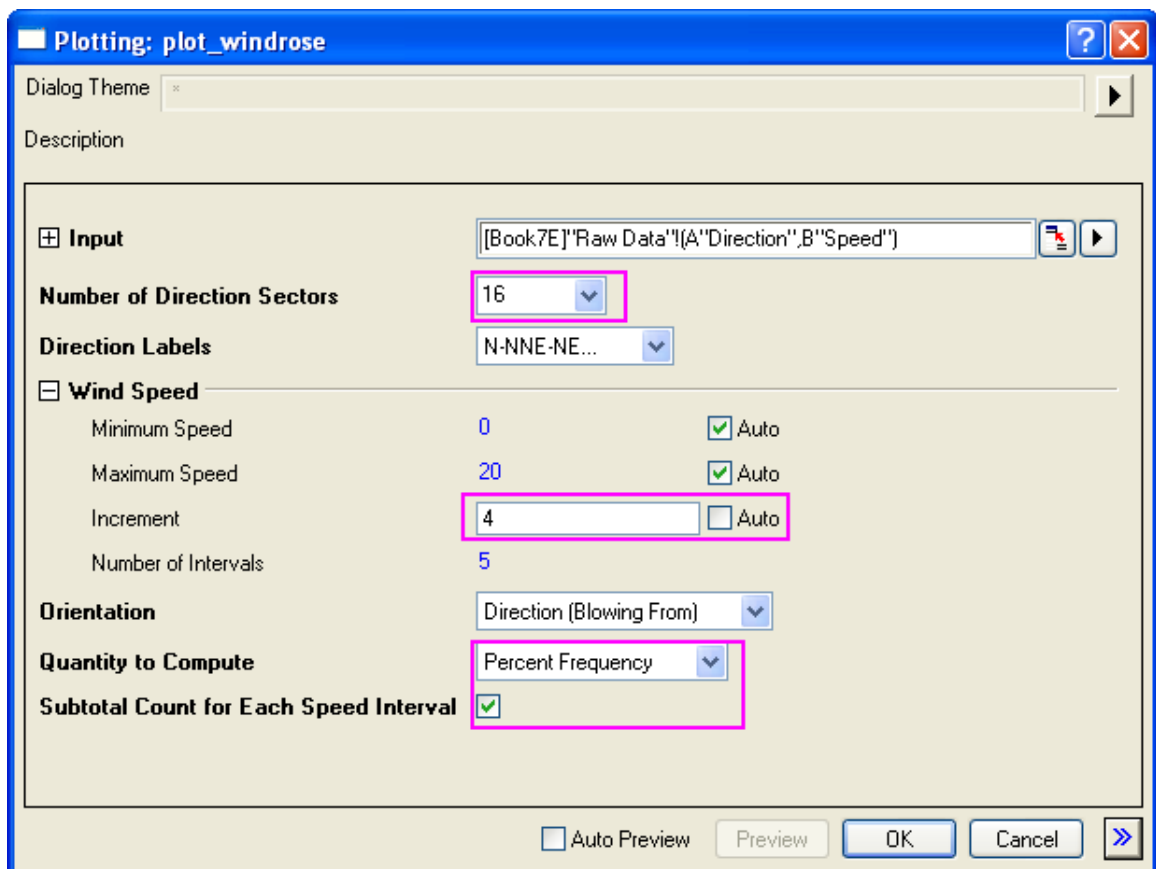

The final graph should resemble the image shown below:

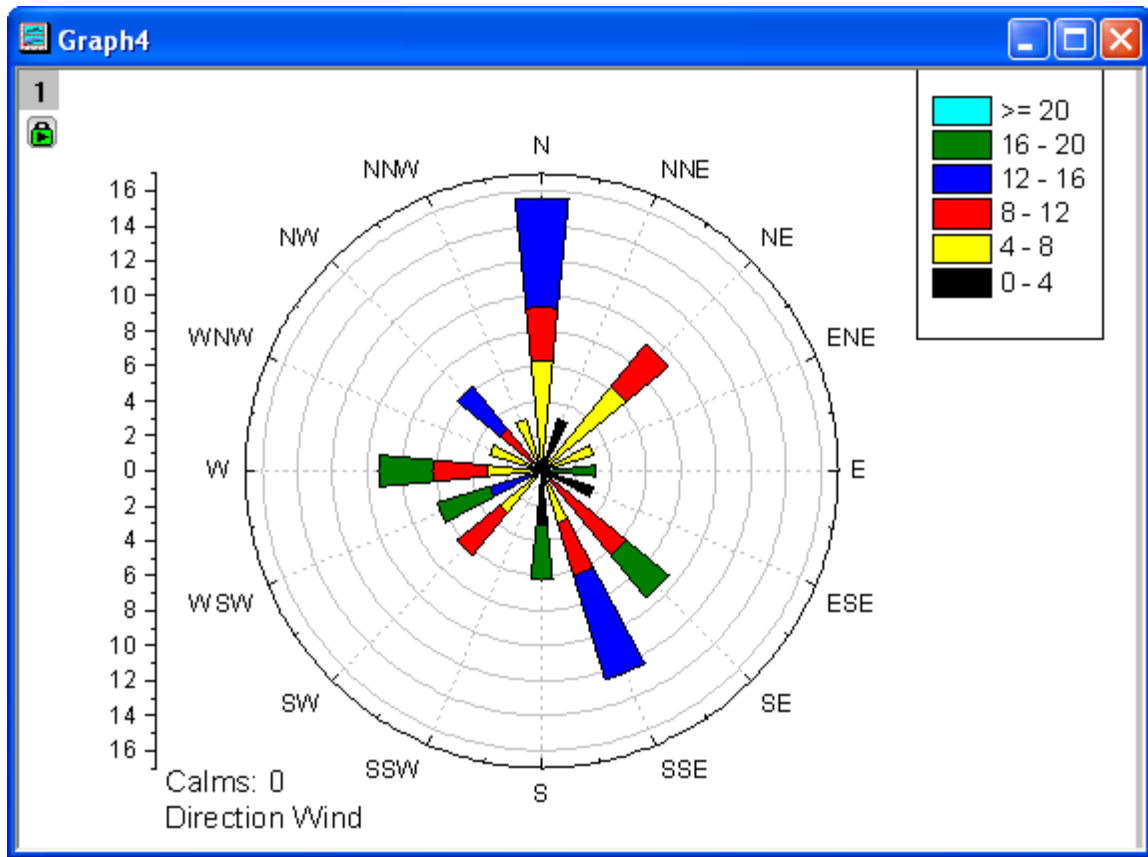

### 6.15.4 Sample Data

#### 6.15.4.1 Binned Data

To import **Binned Data** to a worksheet, copy the **Binned Data 1** (including the heading) and select **File: Import Wizard**. Select the **Clipboard** checkbox in the **DataSource** group and click the **Finish** button to import the data into Origin.

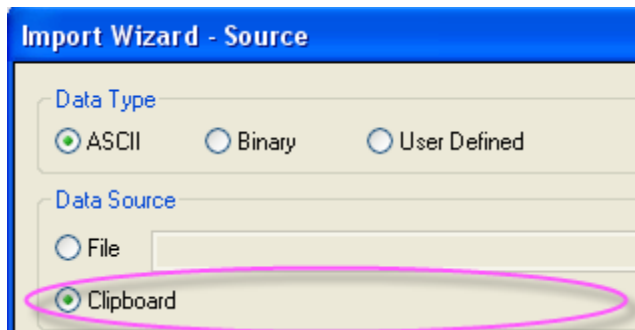

Direction	0-4	4-8	8-12	12-16	16-20
-----------	-----	-----	------	-------	-------

22.5	3.125	3.125	3.125	6.25	0
45	0	3.125	3.125	0	0
67.5	0	6.25	0	0	0
90	0	0	0	0	3.125
112.5	0	0	0	0	0
135	3.125	0	0	0	3.125
157.5	0	0	9.375	3.125	0
180	3.125	3.125	0	3.125	3.125
202.5	0	0	0	0	0
225	0	0	3.125	0	0
247.5	0	3.125	0	3.125	3.125
270	0	0	0	0	3.125
292.5	0	6.25	3.125	0	0
315	0	0	3.125	3.125	0
337.5	0	0	0	0	0
360	0	6.25	0	0	0
382.5	0	0	0	0	0

6.15.4.2 Raw Data

To import **Raw Data** to worksheet, you can copy the **Raw Data** (including the heading) and then select **File: Import Wizard**. Select the **Clipboard** checkbox in **DataSource** group and then click **Finish** button to import the data into Origin.

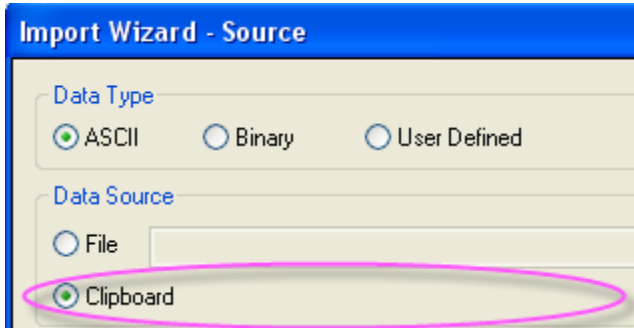

Direction	Speed
311.5	12.75
142.7	11.18
161.6	5.9
277.3	8.24
155.3	13.46
40.8	8.57
43.4	4.38
1.3	10.91
78.8	18.72
237.8	16.22
114.6	0.88
2.1	12.05

290.5	4.6
174.1	3.29
267.6	16.64
8	5.6
213.9	8.04
134.8	17.26
137.6	11.87
46.1	5.48
4.5	13.47
311.2	10.17
154.4	11.17
176.2	18.91
348.1	4.11
225.2	6.65
236.4	12.87
11.7	1.07
278.9	4.36
356.5	5.01

58.9	7.3
161.8	15.6

## 6.16.2D Vector Graph

### 6.16.1 Summary

A vector plot is a multidimensional graph used in industries such as meteorology, aviation, research, and construction that illustrate flow patterns (e.g. of wind, water, magnetic fields, etc.). Both direction and magnitude are represented in a vector graph. Origin includes two types of vector plots:

1. **Vector XYAM** - takes a starting XY location for the vector tail (by default), an angle and a magnitude.
2. **Vector XXYX** - takes two XY positions and connects them with a vector.

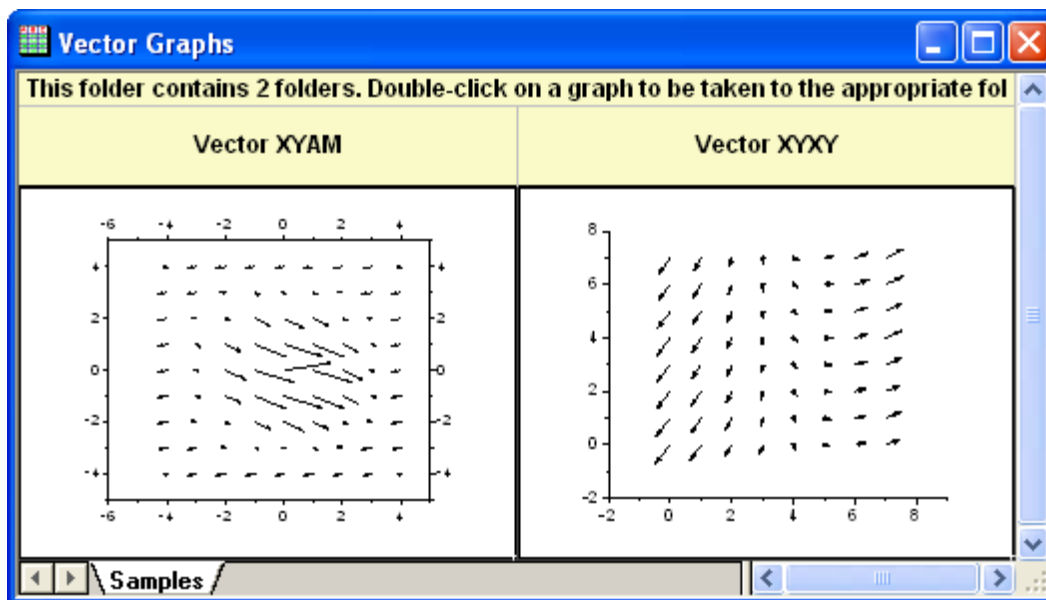

Minimum Origin Version Required: Origin 2015 SR0

### 6.16.2 What you will learn

This tutorial will show you how to:

- Use Two data organizing mode to plot a vector graph.
- Use Plot Setup to assign plot data

### 6.16.3 Steps

This tutorial is associated with <Origin EXE Folder>\Samples\Tutorial Data.opj.

Also, you can refer to these graphs in Learning Center. (Select **Help: Learning Center** menu or press **F11** key, and then open **Graph Sample: Specialized Graphs**)



To create a vector plot, you need four data columns, and to organize your data into two modes:

### 6.16.3.1 Vector XYAM

XYAM stands for X, Y, Angle and Magnitude. Vectors will start from point (X, Y), and rotate a specified angle. The following example uses XYAM data mode to create a vector graph.

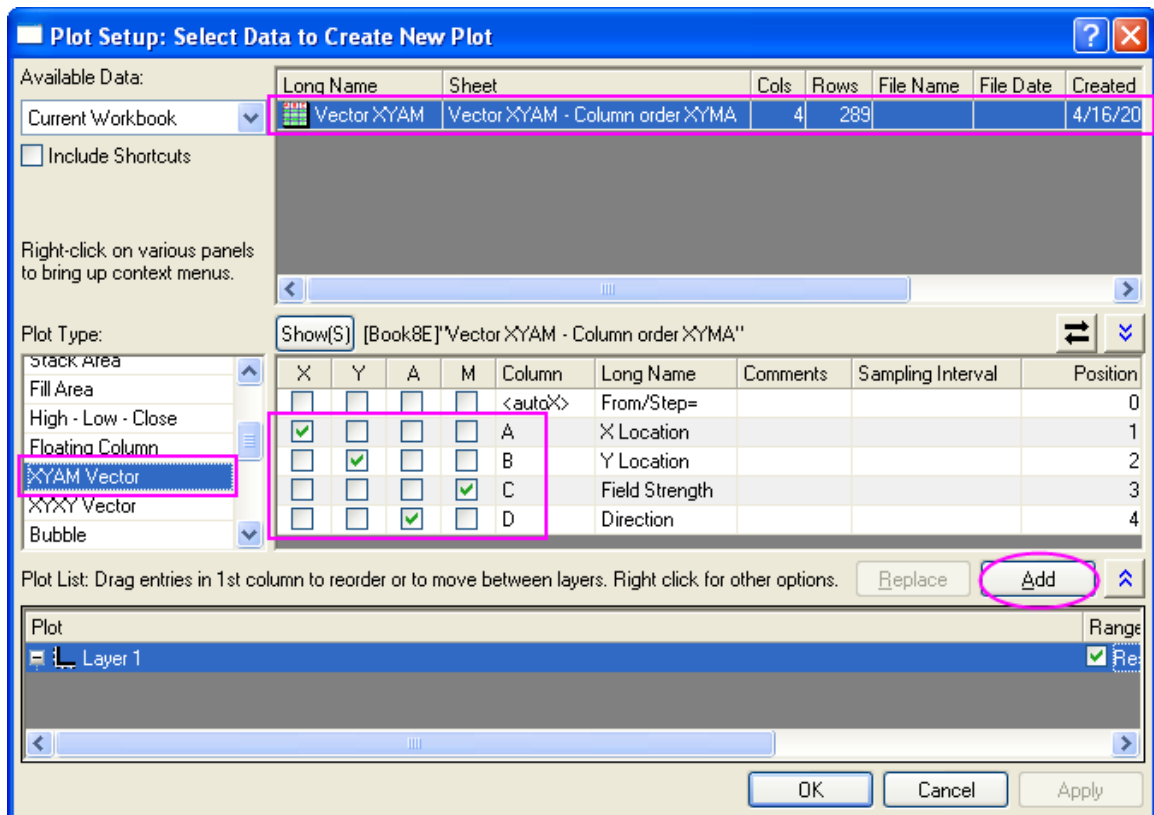
1. Open **Tutorial Data.opj** and browse to the **2D Vector** folder in **Project Explorer** (PE).
2. Activate the data worksheet **Book8E**. Without highlighting any columns, select **Plot: Specialized: Vector XYAM** from the main menu to open the **Plot Setup** dialog. Assign columns A, B, D, C to X, Y, A, M as shown below, then click **OK** to plot the graph.



In order to show all three panels in **Plot Setup** dialog, please expand **Plot Type** panel by clicking  and expand **Available Data** panel by clicking  again.

Please refer to [Plotting using Plot Setup](#) for more information.

3. Select **Format:Plot...** to pull up the plot level of the **Plot Details** dialog. In the **Vector** tab change the **Magnitude Multiplier** drop-down list to 75. Click the **OK** button to close **Plot Details** dialog.
4. Double-click the X or Y axis to open the **Axis** dialog. Go to the **Line and Ticks** tab, in the left panel, hold **Ctrl** key to select both **Bottom** and **Left** icons, check the **Use Same Options for Bottom and Top** check box. This will apply the settings in bottom X to top X, and those in left Y to right Y.
5. Go to the **Tick Labels** tab, hold **Ctrl** key to select both the **Top** and **Right** icons in the left panel, check **Show** check box. Click **OK** to apply the setting and close the **Axis** dialog.
6. Right click on the legend box to bring up the context menu. Select **Properties...** to open the **Object Properties** dialog. Type **\I(1) Field Strength** in the text box and click **OK**.
7. Add a layer title: **Spot Write Effectiveness**.

#### 6.16.3.2 Vector XYXY

Another data organizing mode is XYXY; where the first X, Y is the vector starting point, while the last X, Y is the ending point.

To create such a vector graph, activate workbook **Book9E** under the *2D Vector* folder, highlight all of the four data columns in it, and select **Plot: Specialized: Vector XYXY** from the main menu. Delete the axis titles if necessary.

## 6.17 Piper Diagram

### 6.17.1 Summary

Piper diagram (or Trilinear diagram) is used as an effective graphical representation of chemistry in water samples in hydro-geological studies. The percentage values of six ion groups are considered in the plot, they are calcium, magnesium and sodium plus potassium cations, and sulfate, chloride and carbonate plus hydrogen carbonate anions.

The cations and anions are shown by two separate ternary plots and both are then projected onto a rhomb. In Origin they are plotted as a three layer graph.



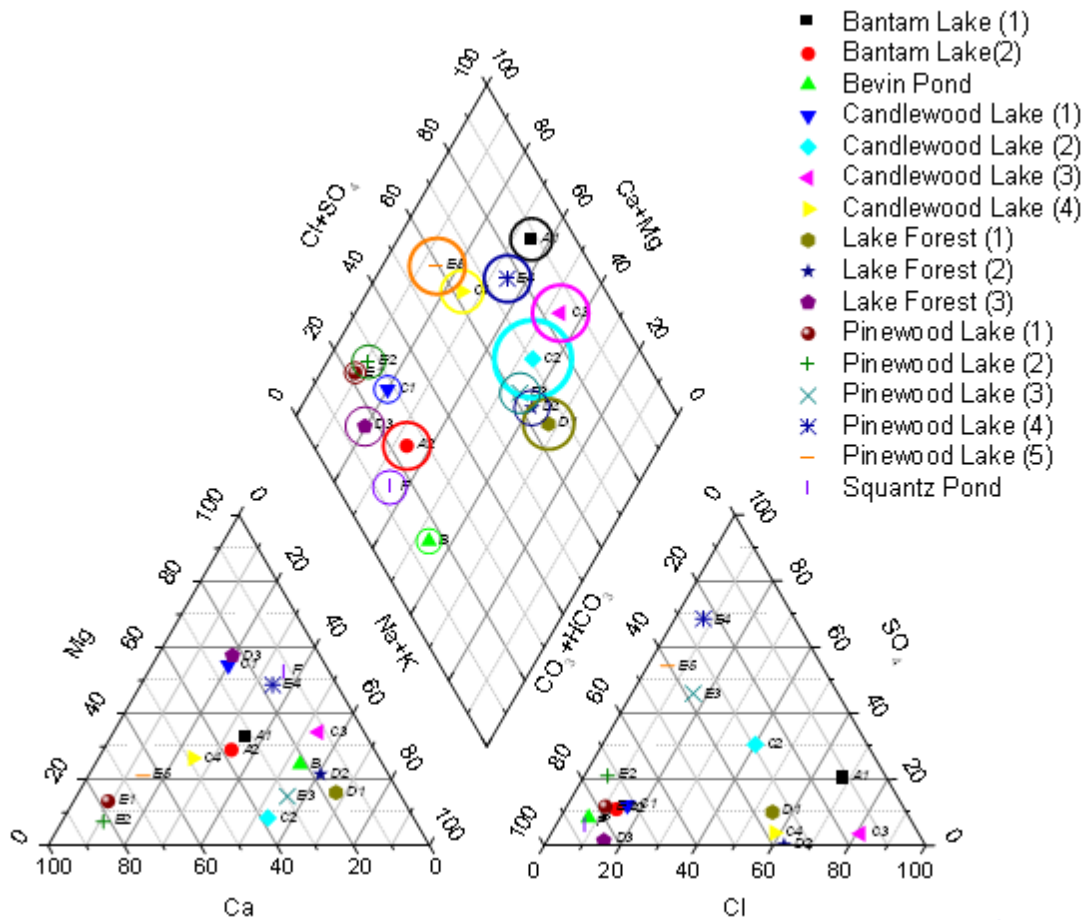

Minimum Origin Version Required: 9.1 SR0

### 6.17.2 What will you learn

This tutorial will show you how to:

- create a piper plot from percentage data
- customize the gap between ternary and rhomb in piper graph
- add data labels in the piper plot

### 6.17.3 Steps

1. Start a new workbook and click the  button to import the file **Piper.dat** under *<Origin EXE Folder>\Samples\Graphing* path.
2. In the imported worksheet, column **A** is the Sample ID. Column **B** through **G** are the percentage values for the six ion groups in the order of **Ca, Mg, Na+K, Cl, SO4, and CO3+HCO3**. column **H** is

the amount of total dissolved solids in water. The percentage for cation groups is relative to the total amount of cations and that of anion groups is calculated by the same manner.

**Note:** We have some built-in workbook templates to help you convert data from different units (MEq/mg/L/PPM) to percentage (open from **File:New:From Template:**). For details, please refer to [this help file](#).

- Highlight column **B** through **G** and select **Plot > Specialized : Piper** from the top menu to open the **plotpiper** dialog.
- Select column **A** for **Sample ID** and column **H** for **Total Dissolved Solids**.

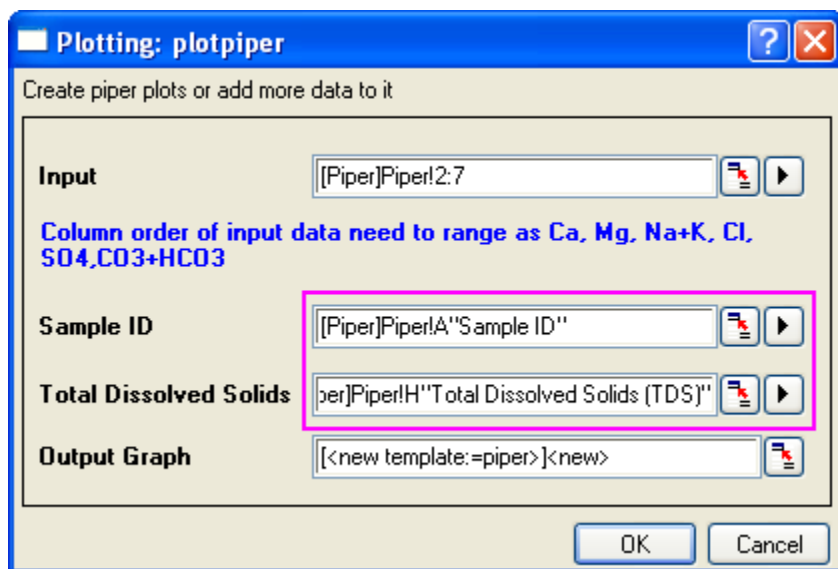

**Note:** You can select an existing piper diagram as the **Output Graph** and add the selected new data into this piper diagram.

- Click **OK** to generate the piper plot:

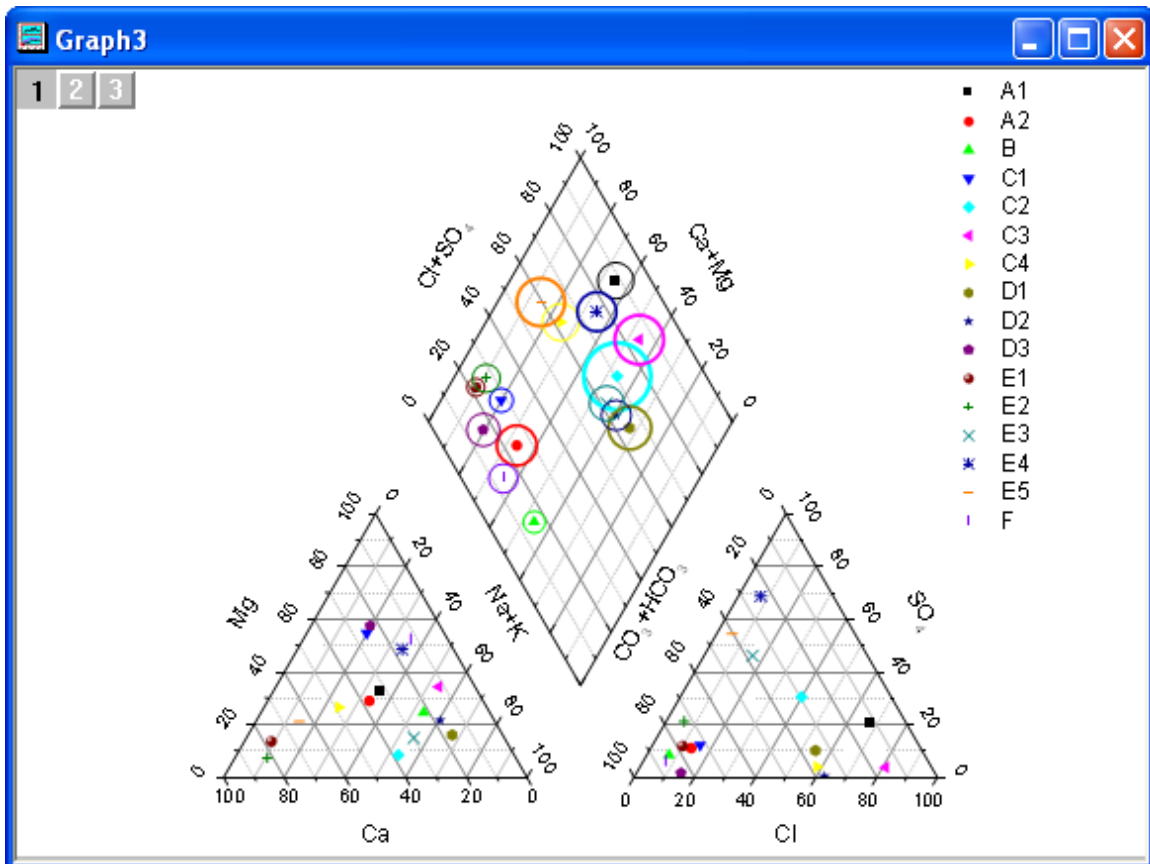

Sample ID and TDS are optional when plotting piper diagram. If Sample ID is specified, symbol color and shape will be controlled by it. If TDS is specified, open circle in the rhomb (Layer 1) will show and the size will be controlled by it. Also Piper diagram shows each sample in legend.

#### 6.17.4 More Customization Steps

The following steps can further customize the graph to be exactly the same as the image in **Summary**.

1. To change the gap between the ternary plots and the rhomb, double click the bottom left ternary to open the **Plot Details** dialog. On the left panel, select **Layer 2**. On **Size/Speed** tab, change the **Left** value to be **130**, so that the distance between the top vertex of rhomb and the top vertex of the ternary in Layer 2 will be 130% of the side length of rhomb. Click **Apply** button.

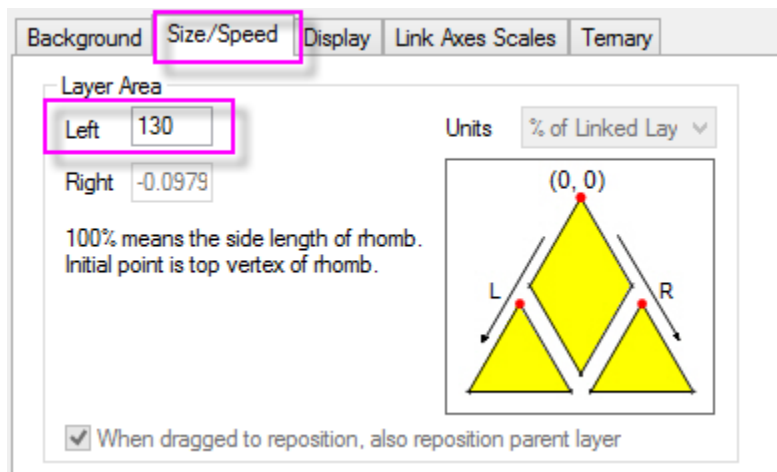

- To change the symbol color or shape increment list, select the data plot under **Layer 1** node on the left panel. Then go to the **Color List** or **Shape List** tab to customize them.

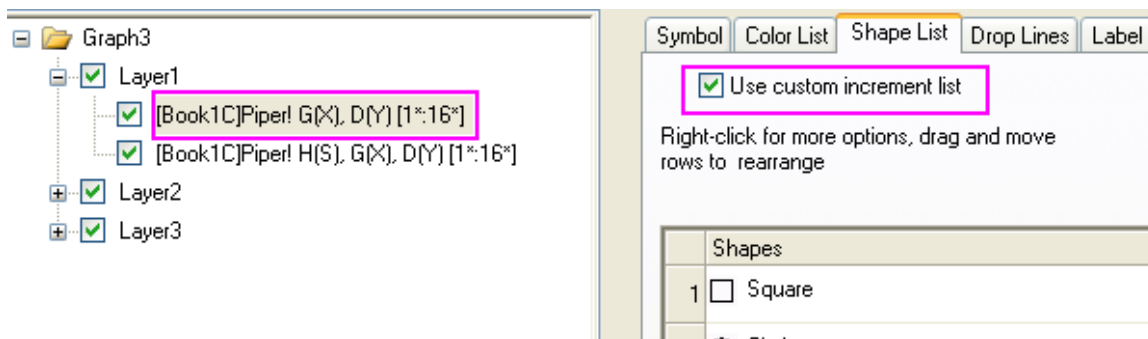

- To add **Sample ID** as data label in the rhomb, Select 1st data plot under **Layer 1** node on the left panel. Go to **Label** tab and set as follows:

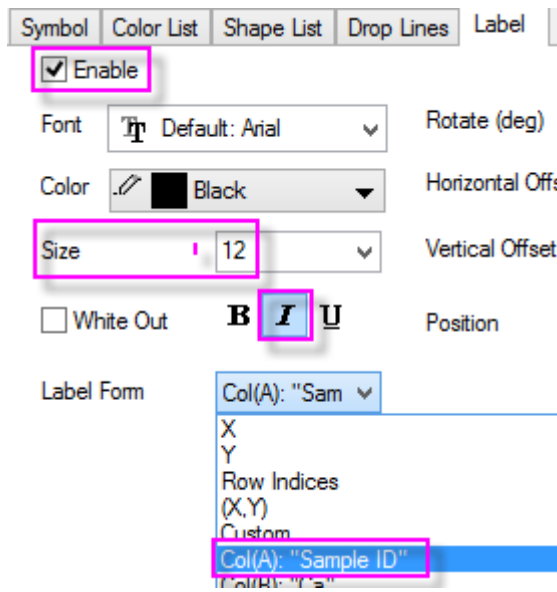

To add data labels to two ternaries in the graph, please select plot under **Layer2** and **Layer3** nodes in the **Plot Details** dialog and do the same.

4. The 2nd data plot under **Layer1** node in the **Plot Details** dialog is the open circle for TDS. Select the data plot on left panel and select the **Symbol** tab. You can see the Size of the open circle is controlled by Col(H). The Scaling Factor is auto determined to get a proper display. Change the **Scaling Factor** to **0.03** to see the change.
5. By default Sample ID shows in legend. To show sampling location's information in legend, right click on the legend and select **Legend:Point by Point...** to open the **Update Legend Point by Point** dialog. Select **Custom** for the **Label Form** drop-down list and then select **wcol(1): wcol(9)** from the menu. wcol(9) refers to the 9th's column in worksheet, which is the Sampling Location column.

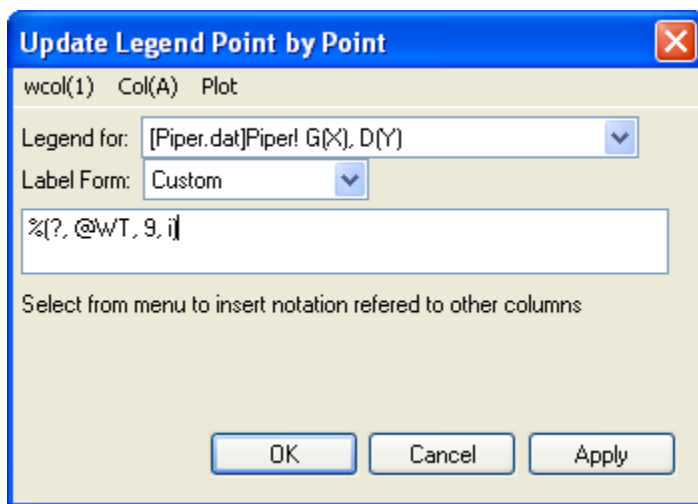

## 6.18 Waterfall

### 6.18.1 Waterfall

- [2D Waterfall](#)
- [3D Waterfall](#)

### 6.18.2 2D Waterfall

#### 6.18.2.1 Summary

Origin's **Waterfall** plot uses a dataset stored in a parameter row to set the Z offset and create a color map with Y or Z values.

#### 6.18.2.2 What you will learn

This tutorial will demonstrate how to:

- Create a 2D Waterfall color map with Y or Z values
- Customize colormap levels and palette

### 6.18.2.3 Steps

This tutorial is associated with the **Tutorial Data** project: <Origin EXE Folder>\Samples\Tutorial Data.opj.

#### 6.18.2.3.1 Create Waterfall with Y Colormap

1. Open the **Tutorial Data** project and browse to folder *Waterfall* in **Project Explorer**. Select the **Book4G** window to activate it. Click in the upper left corner of the worksheet to select all data.
2. Right-click and select **Plot > 3D : Waterfall Y:Color Mapping** to create a Waterfall with Y color mapping. (Alternatively, select the **Waterfall Y:Color Mapping** button from the 2D Graphs toolbar.)  
A graph resembling the image below will appear:

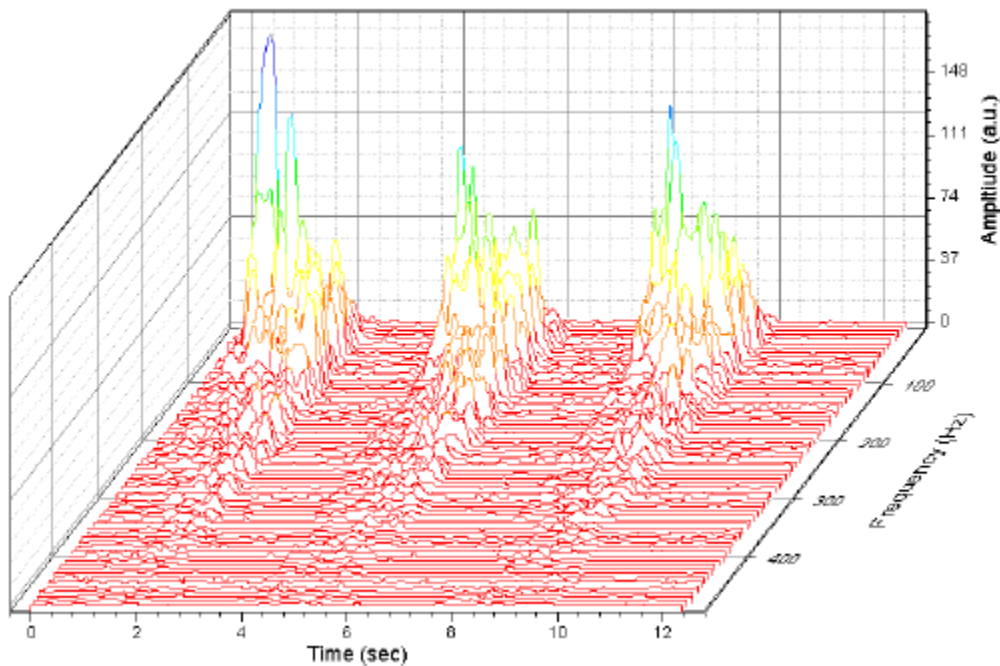

Note that the values stored in the user-defined parameter row **Frequency (Hz)** have been automatically picked up as the Z Value Source. Confirm this by double-clicking the plot to open the **Plot Details** dialog box and selecting **Layer1** in the left panel. Select the **Waterfall** tab and observe that the **Z Value Source** is set to **Frequency (Hz)**.

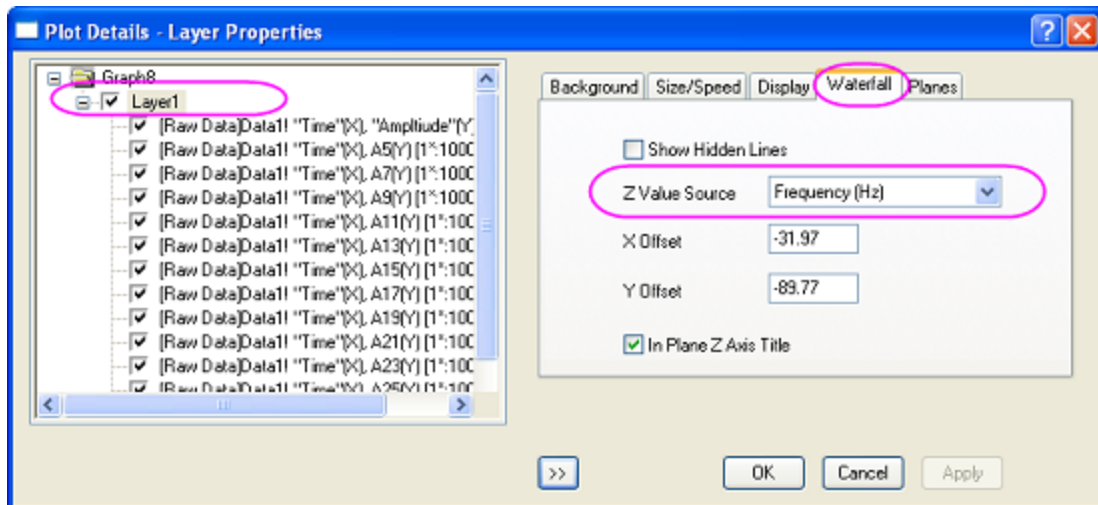

- With the Plot Details dialog box still open, in the left panel, select the first line plot under Layer1. Select the **Colormap** tab in the right panel. Click on the **Level...** column header to open the **Set Levels** dialog box. Set levels as shown below:

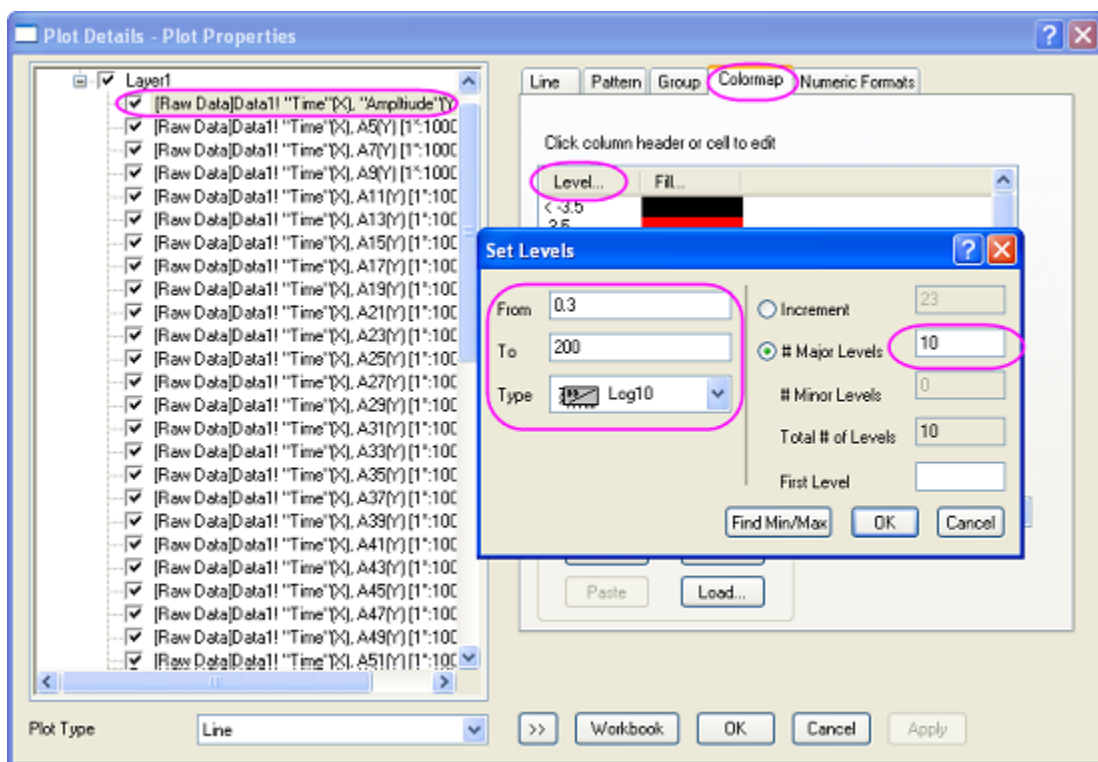

Click **OK** to close the Set Levels dialog box.

- Click on the **Fill...** column header to open the **Fill** dialog box. Select **Load Palette**, and choose the **Rainbow** palette from the palette list. Click **OK** button to close the **Fill** dialog box.

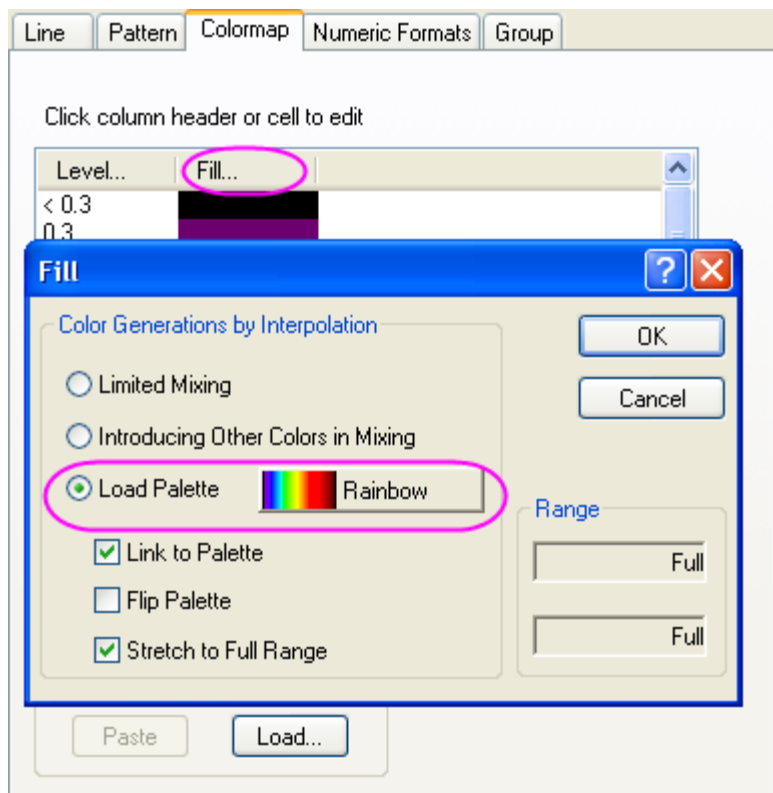

Click **OK** to apply these settings and close the **Plot Details** dialog box.

5. Double-click the plot's Z axis to open the Axis dialog box. Go to the **Scale** tab and set the major tick **Value** to **50**.



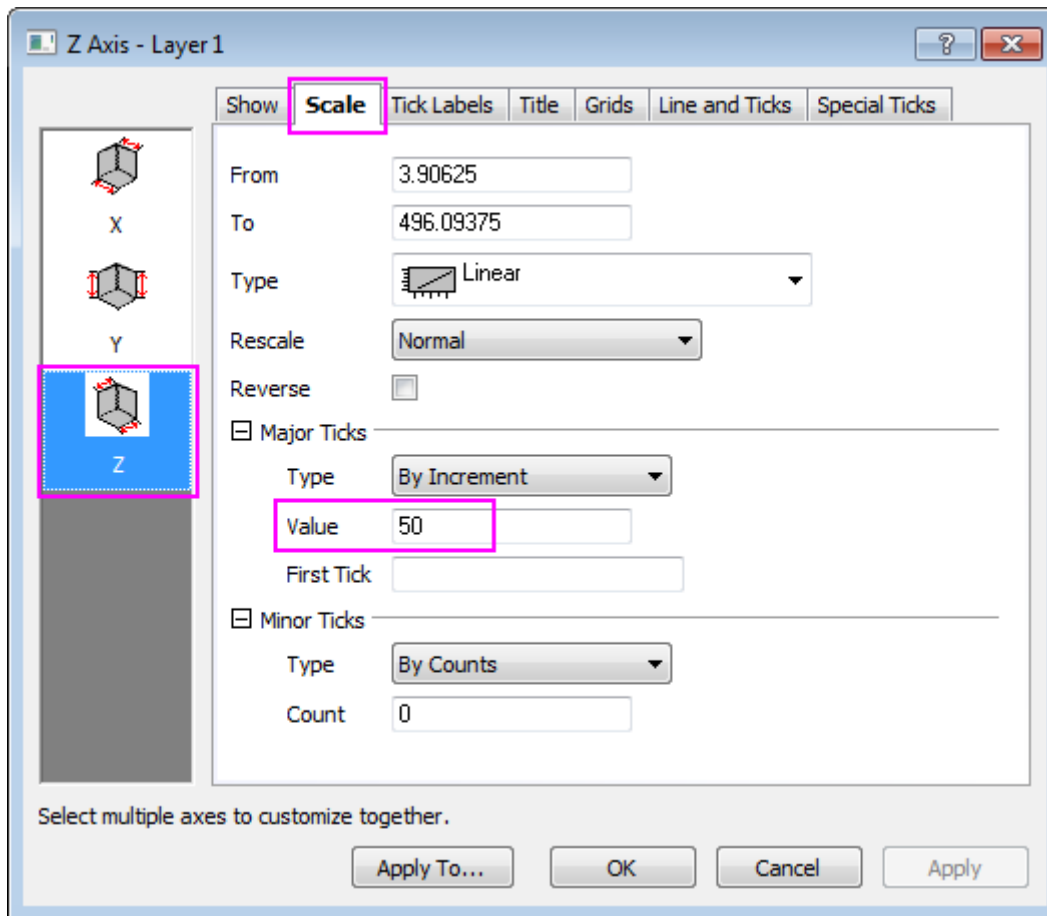

6. Go to the **Grid** tab. Press the **Ctrl** key to select the **X** and **Y** axes in the left panel, and then clear the **Minor Grids** check box.

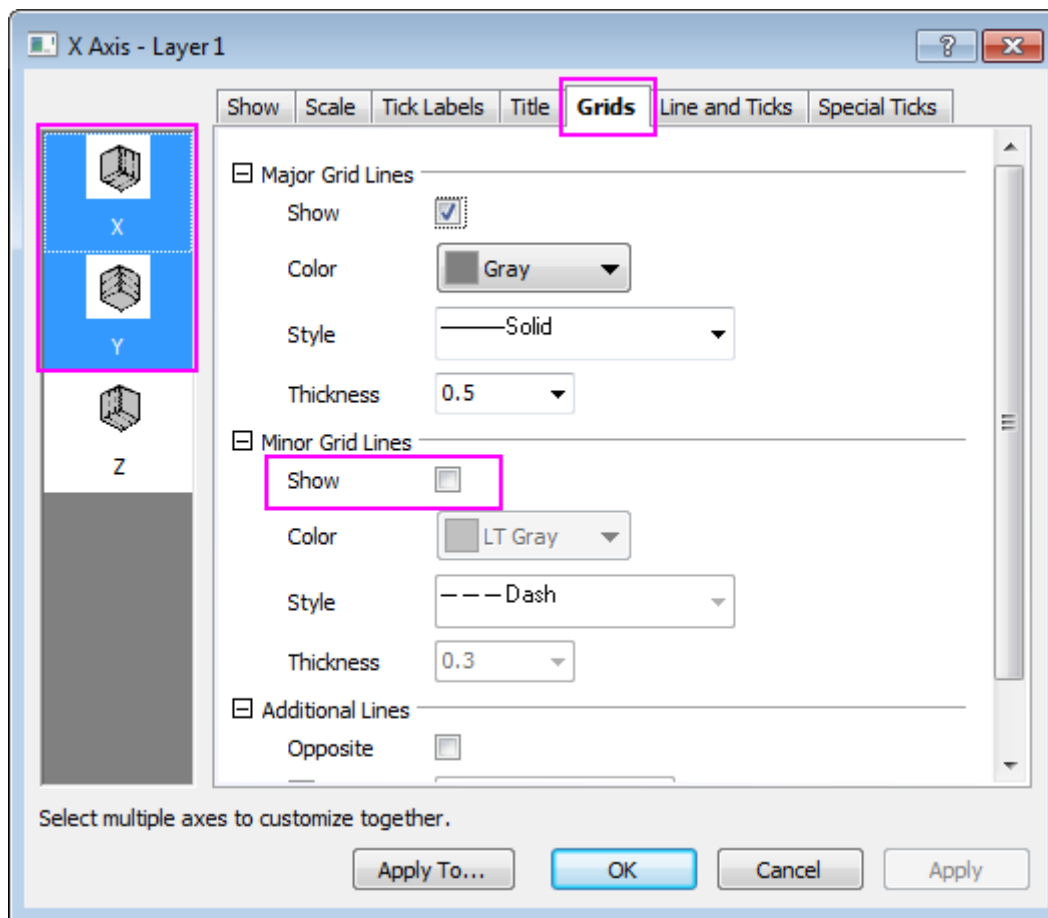

Click **OK** to apply changes and close the dialog box. The final graph should look like this:

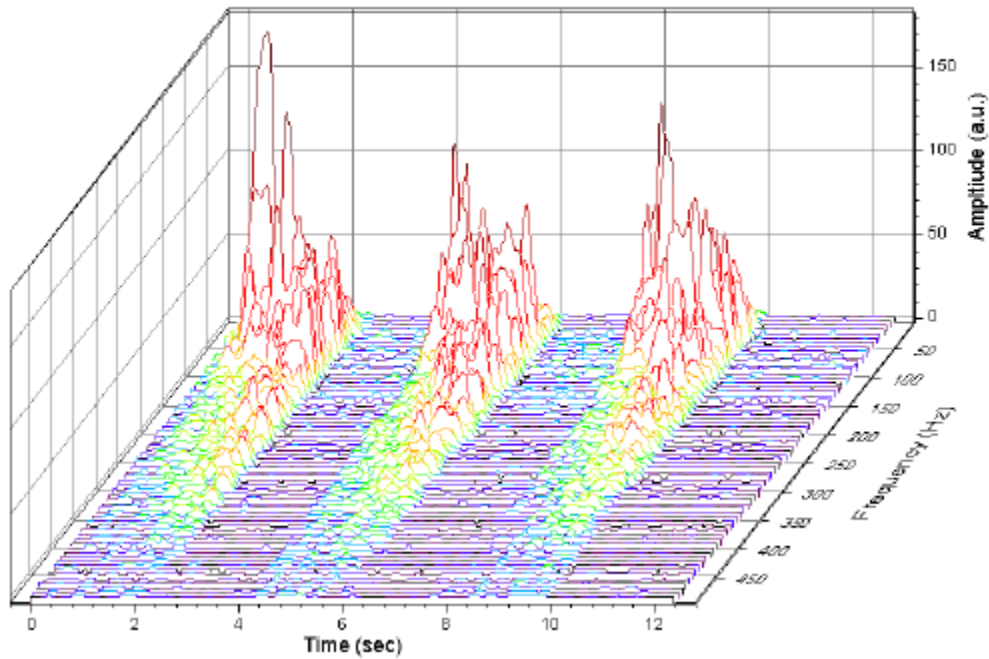

#### 6.18.2.3.2 Create Waterfall with Z Colormap

1. In the Project Explorer (usually at the left of the screen), browse to **\2D and Coutour Graphs\Waterfall**. Select the **Book4G** window to activate. Click in the upper left corner of the worksheet to select all data.
2. On the main menu, click **Plot**, then point to **Y-offset/Waterfall**, and then select **Waterfall Z:Color Mapping** to create a Waterfall with Z color mapping. (Alternatively, select the **Waterfall Z:Color Mapping** button from the 2D Graphs toolbar.)

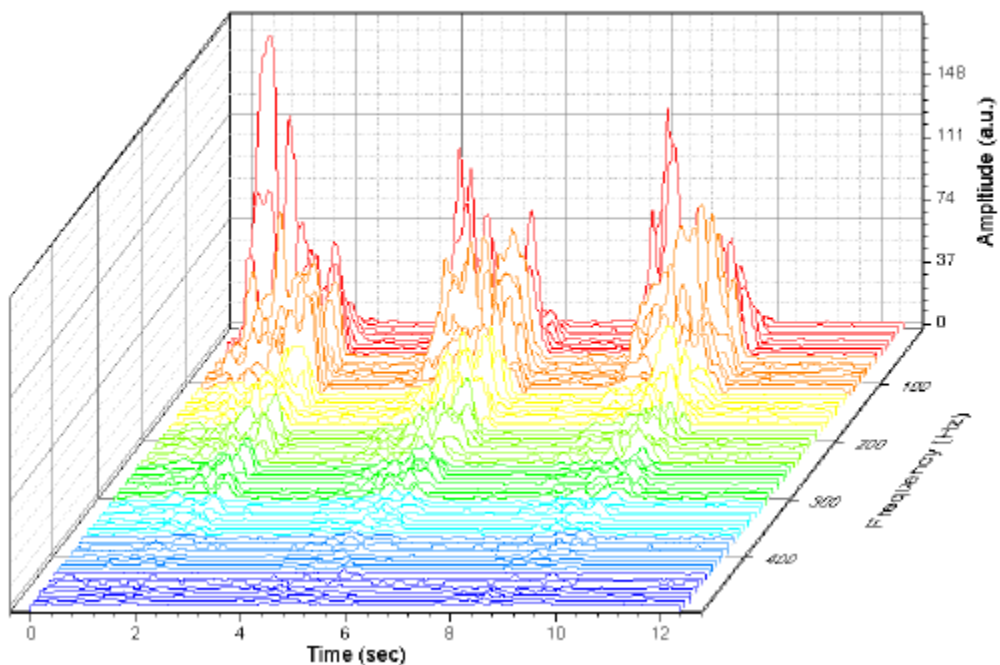

3. Double-click the plot to open the Plot Details dialog box. In the left panel, select the first line plot under Layer1. Select the **Colormap** tab in the right panel. Click the **Level...** column header to open the Set Levels dialog box. Set **Major Levels** to **10**.

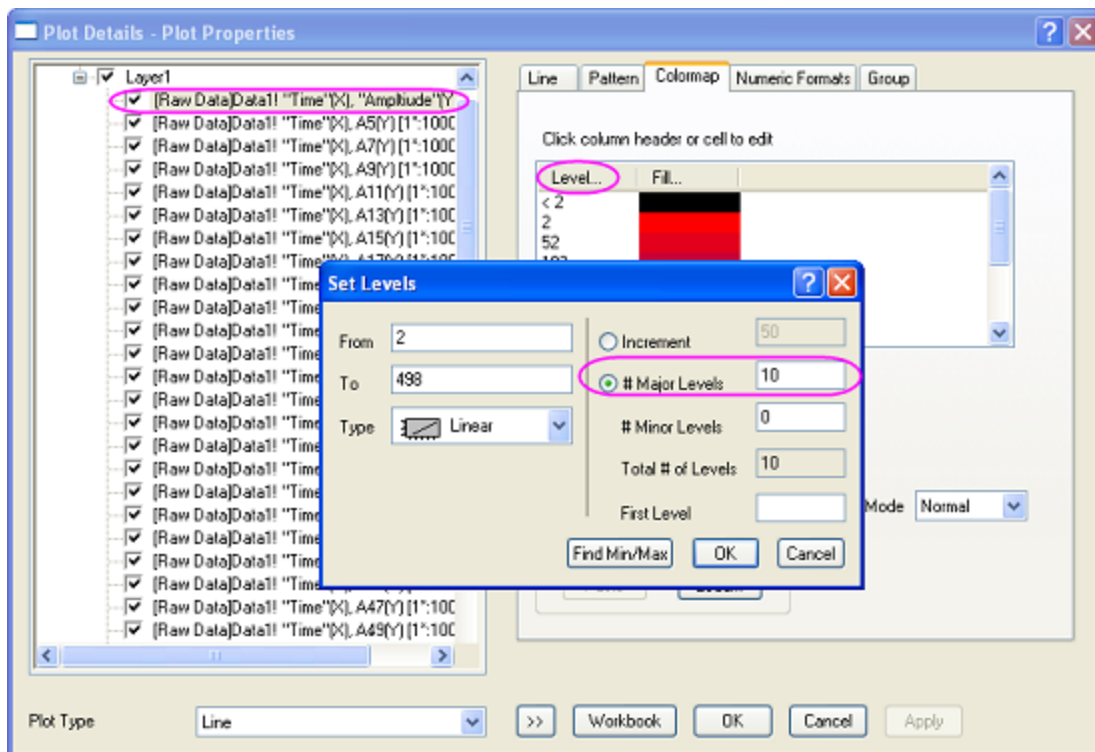

Click **OK** to close the Set Levels dialog box.

4. Click the **Fill...** column header to open the Fill dialog box. Select **Limited Mixing** and set the **From** color to **red** and the **To** color to **blue**. Click **OK** to apply these settings and close the dialog box. Click **OK** to close the Plot Details dialog box.

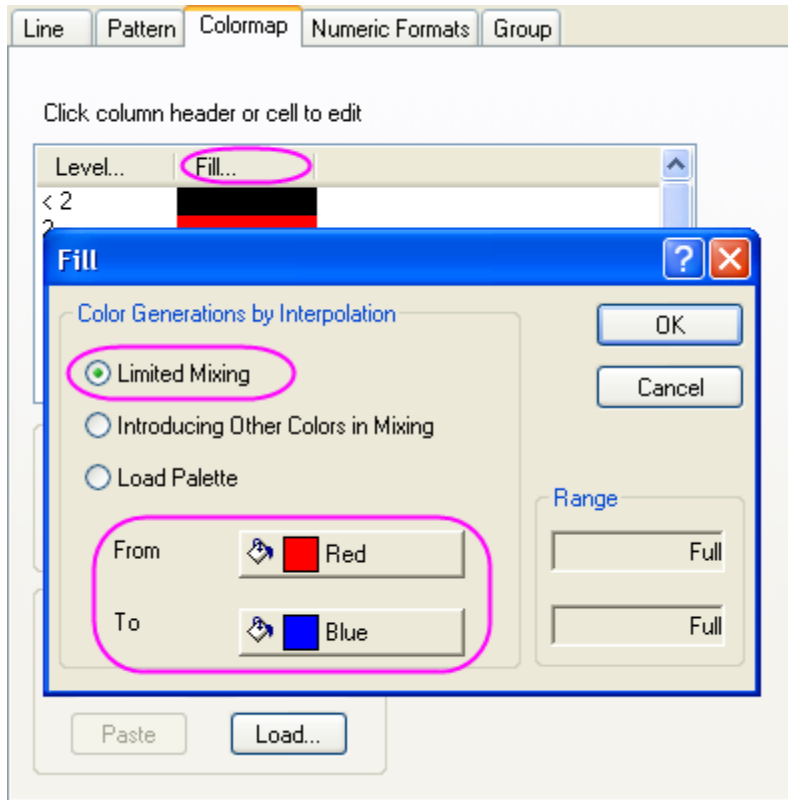

5. Double-click the Y axis to open the **Axis** dialog box. Set the vertical **Increment** to **50**. Select the **Grid Lines** tab. Select **Horizontal** from the **Selection** box, and clear the **Minor Grids** check box. Select **Vertical** from the **Selection** box and clear the **Minor Grids** check box. Click **OK** to close the Axis dialog box.

Your final graph should look like this:

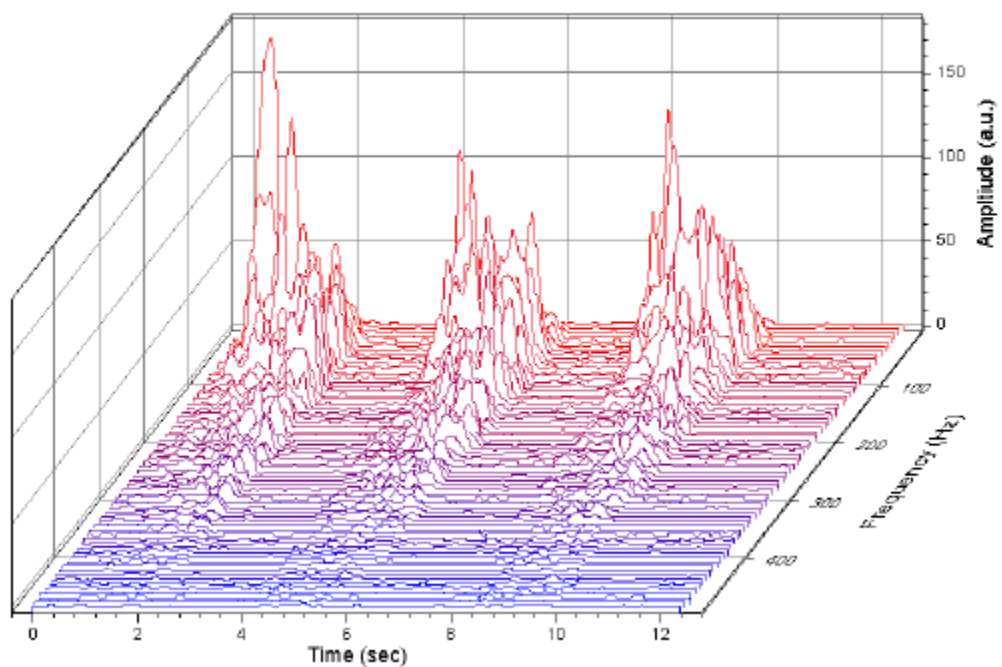

### 6.18.33D Waterfall

#### 6.18.3.1 Summary

Origin features an OpenGL-supported 3D waterfall graph. The 3D waterfall is a specific type of 3D wall graph with a wall width = 0. You can [rotate, resize, stretch and skew the graph](#) as with other Origin 3D graphs.

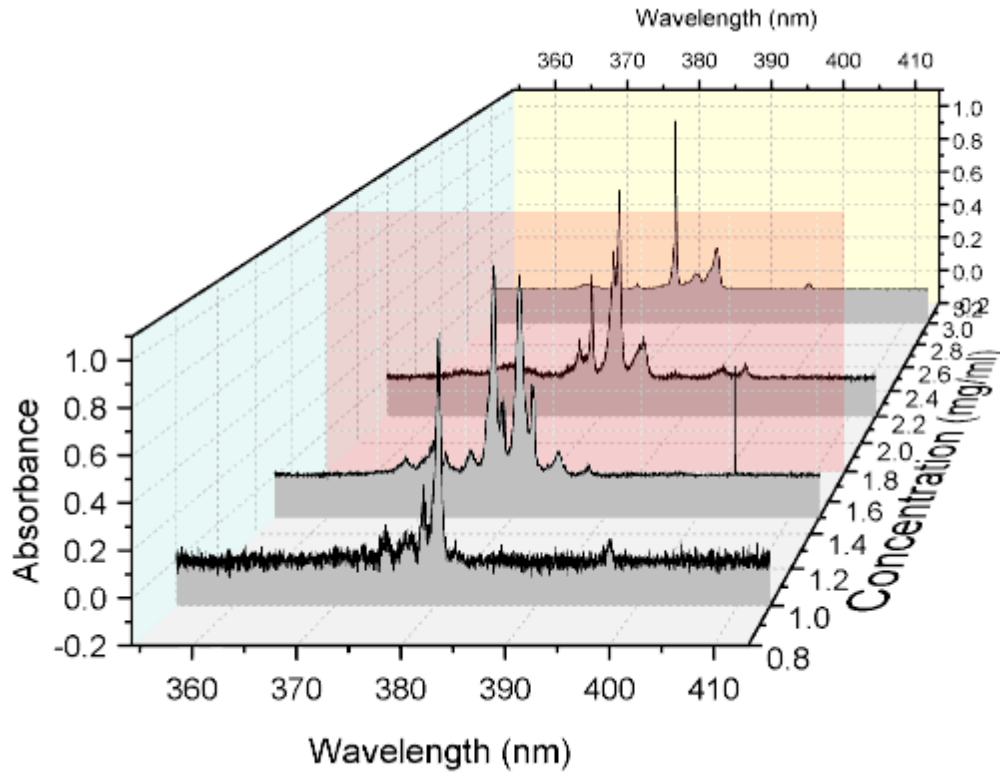

Minimum Origin Version Required: 2015 SR0

#### 6.18.3.2 What you will learn

This tutorial will show you how to:

1. Plot a 3D waterfall graph
2. Add a plane at the specified position in the graph
3. Skew the 3D waterfall graph

#### 6.18.3.3 Steps

This tutorial is associated with the Tutorial Data project: <Origin EXE Folder>\Samples\Tutorial Data.opj.

1. Open the Tutorial Data project and browse to folder *3D Waterfall*.
2. Activate workbook **Book4I** by locating it in Project Explorer and double-clicking to show the window. Highlight all columns. Select **Plot > 3D : 3D Waterfall** from the main menu to plot a 3D waterfall graph.

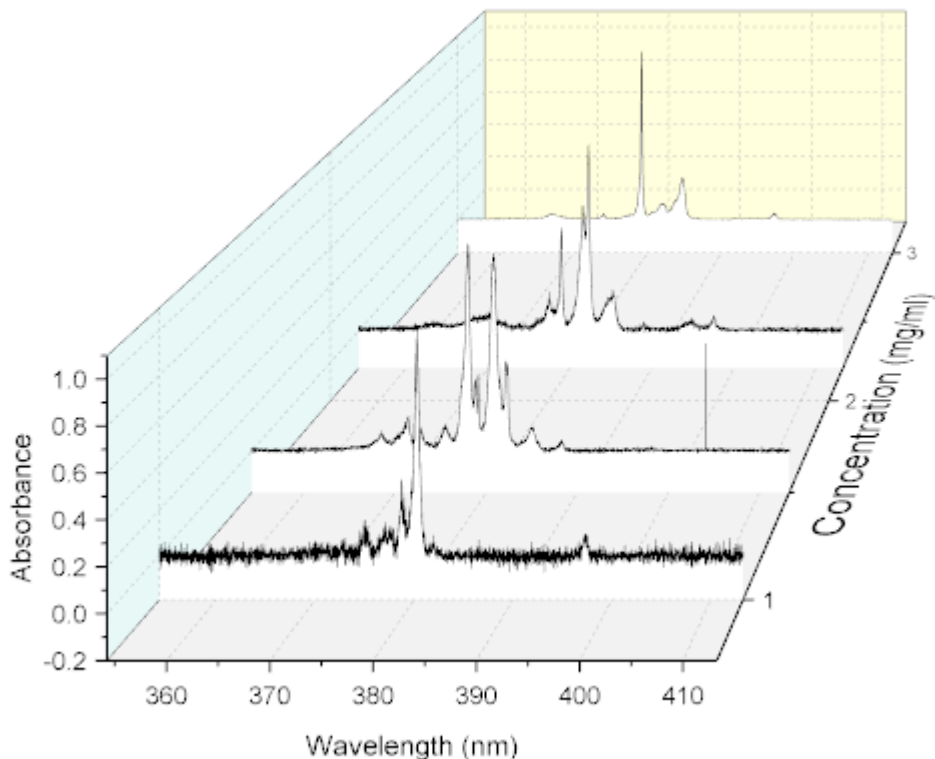

3. Select **Format:Layer** from the menu to open the **Plot Details** dialog box. Go to the **Planes** tab, check the box to add an XY plane to the graph , uncheck the **Enable** check box in the **Plane Border** group, then set the remaining controls as shown in the following image:

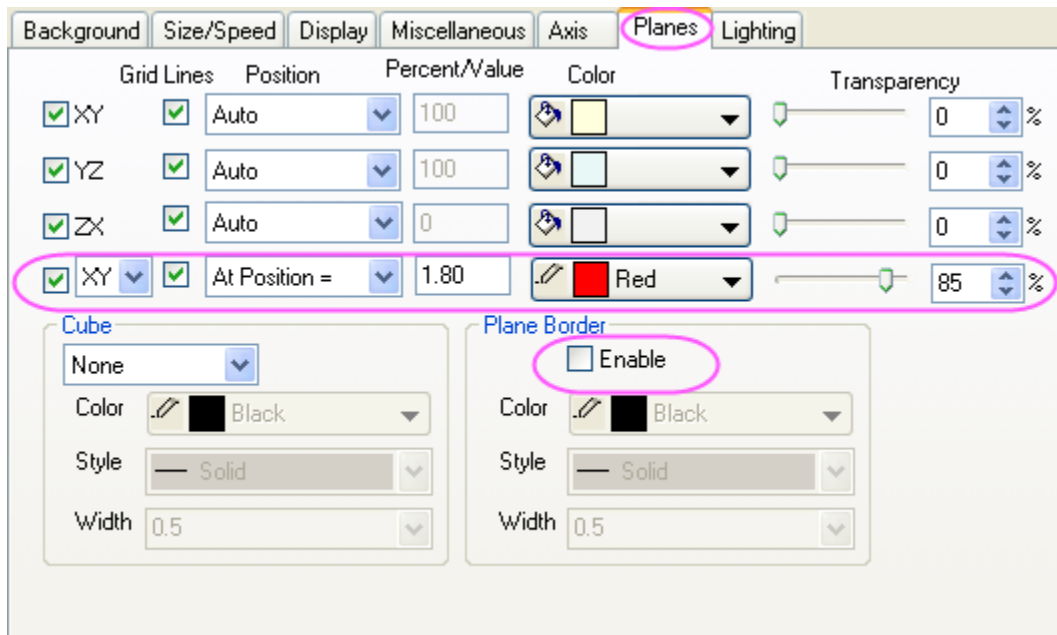



- Click the arrow icon to the left of **Layer1** to show all plots in the layer. Select the first plot in the layer (take care not to clear the check box next to the dataset icon), then click the **Pattern** tab and set the **Fill Color** as *LT Gray*.

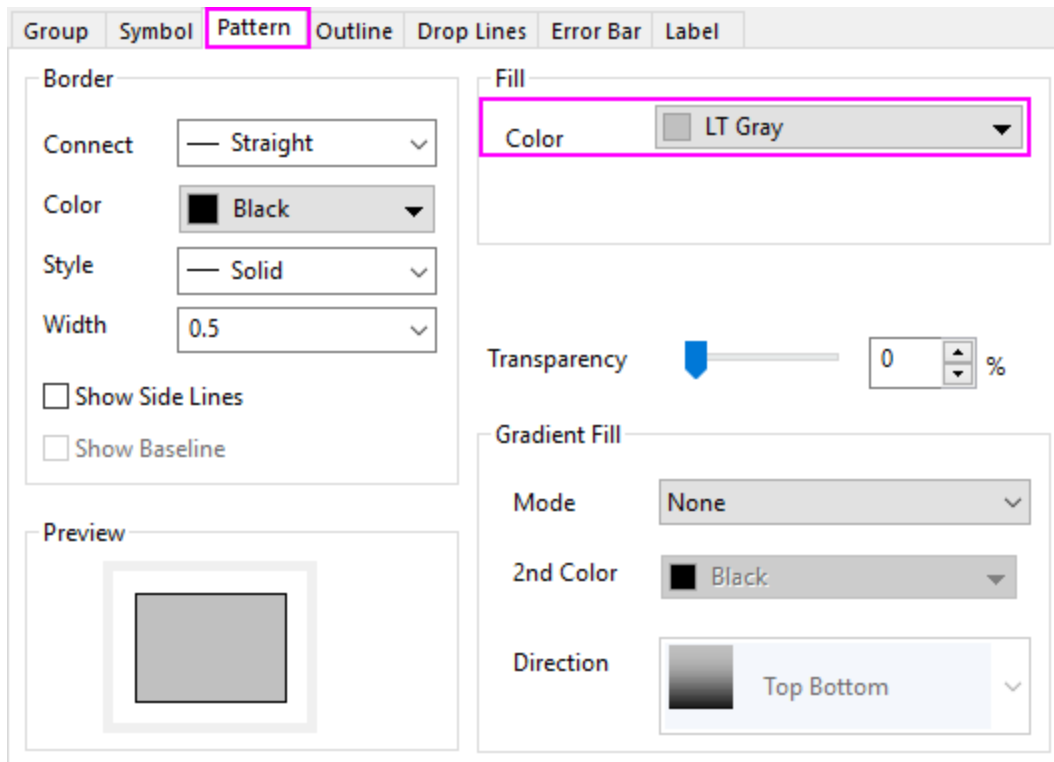

- Click **OK** to close the dialog box. Double-click on a graph axis to open the **Axis** dialog box. Clear the **Use Only One Axis For Each Direction** check box. Go to the **Scale** tab and select **Z** axis icon in the left panel and set **From** and **To** to *0.8* and *3.2*, and set the increment value of **Major Ticks** to *0.2*.

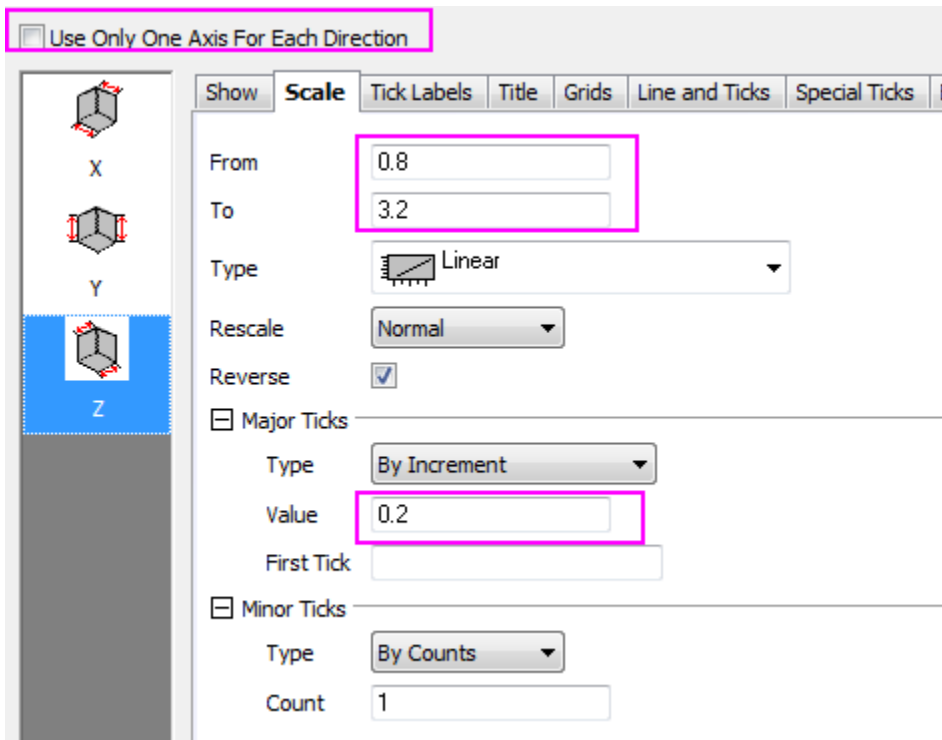

- o Go to the **Tick Labels** tab, make sure **Top - Z** icon is selected and clear the **Show** check box to hide the tick labels on top Z axis.

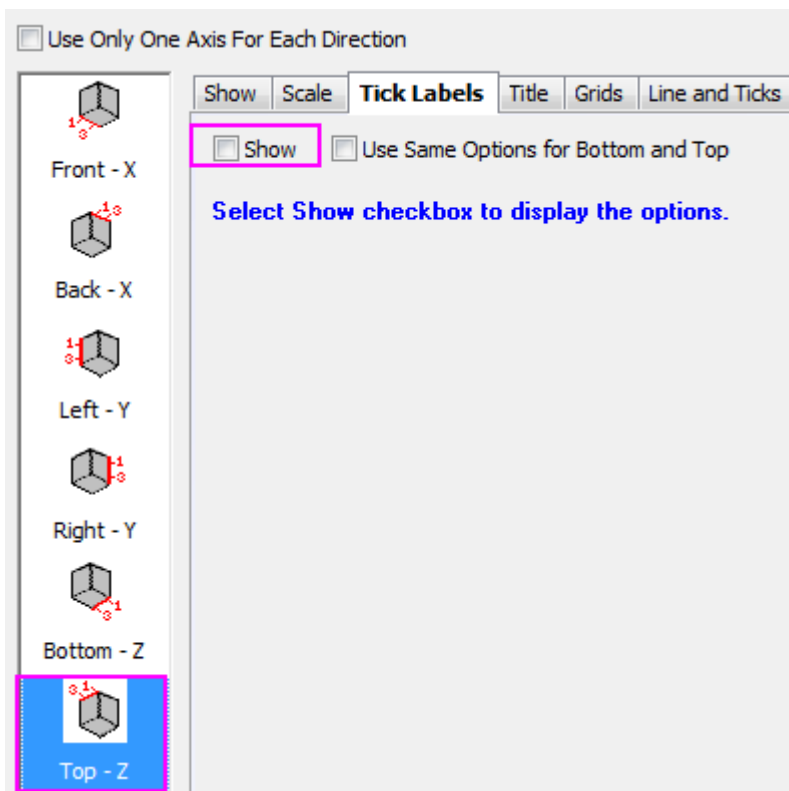

6. Go to the **Line and Ticks** tab, make sure **Top - Z** icon is selected and set **Major Ticks** and **Minor Ticks** to **None**.

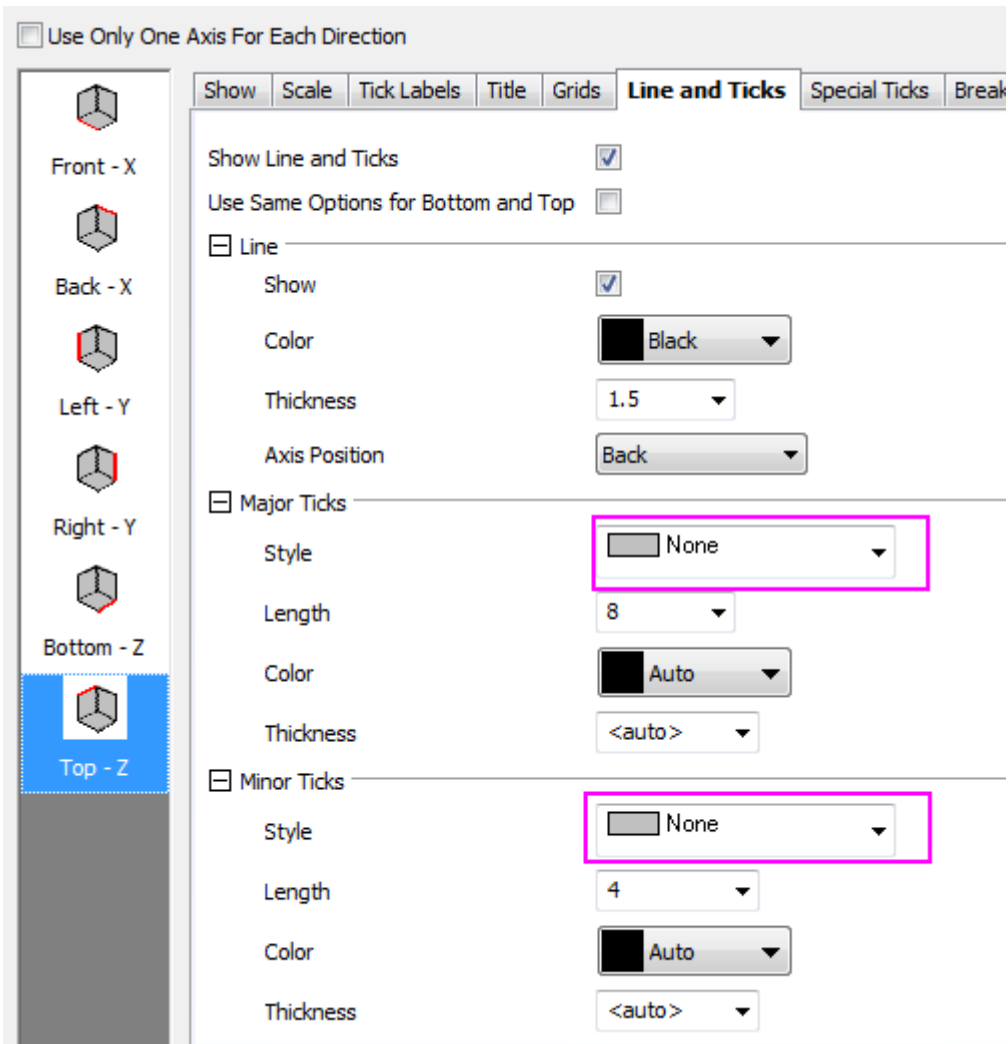

7. Click **OK** to close the dialog. Click on the cube to activate the five red graphical editing icons. Click on the fourth button - the **Skew** button - and drag the X/Y hotspots to skew the graph in X/Y direction so that it looks approximately like this:

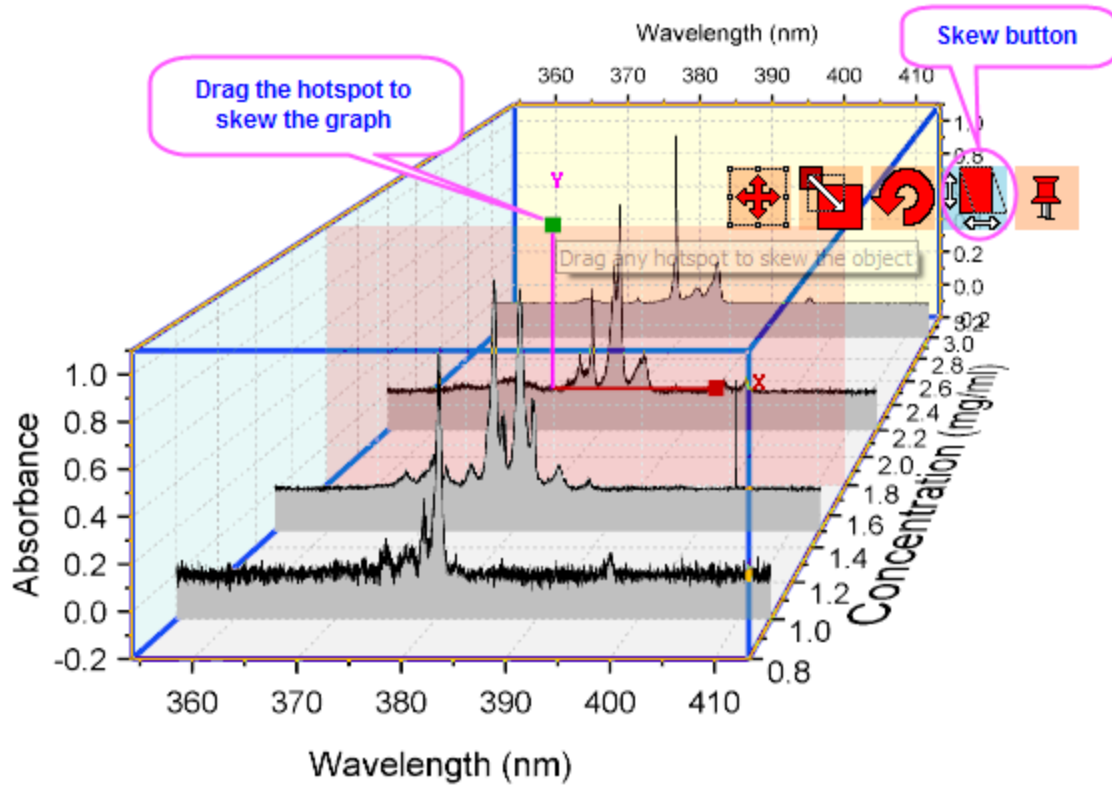

## 6.19 Open-High-Low-Close-Volume Stock Chart

### 6.19.1 Summary

This tutorial will show you how to create a stock chart to display open, high, low, and close prices, along with trading volume.

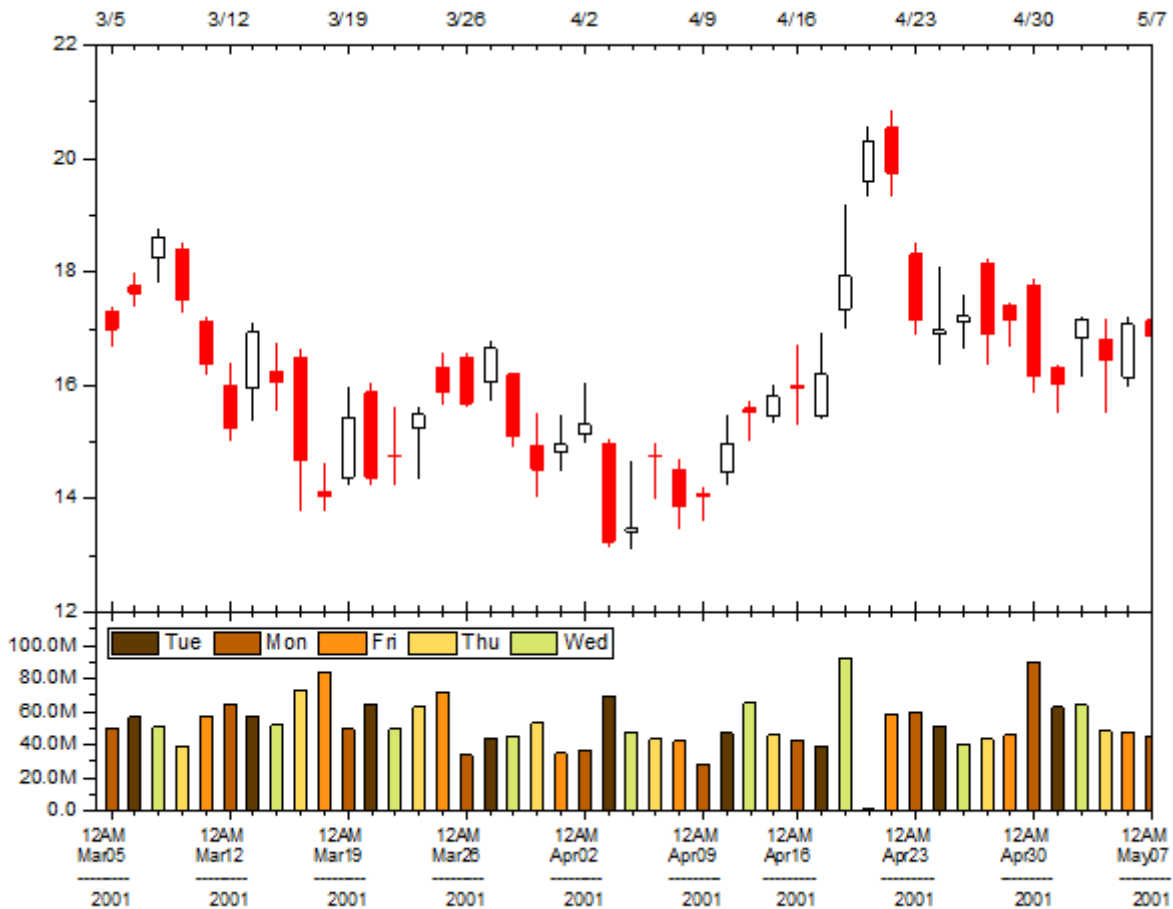

Minimum Origin Version Required: Origin 2016 SR0

### 6.19.2 What you will learn

- Create a stock chart with open, high, low, and close prices, and trading volume
- Set axis Scale Type to skip market-closed days
- Set format for tick labels(Multi-Line label)
- Categorize the volume columns according to their weekday by filling different colors
- Create the Legend to annotate the columns with different fill color

### 6.19.3 Steps

You can refer to this graph in Origin Central. (Select **Help: Origin Central** menu or press **F11** key, and then open **Graph Sample: Financial Plots**)

1. Highlight Col(C)~Col(G) in the worksheet, and then choose **Plot > Specialized : OHLC-Volume** to create a graph.

- Double click on the bottom X axis of Layer2 to open the **X Axis** dialog. Switch to the **Scale** tab. You can see the **Type** is set to **Discrete** by default. This is why the X axis skips all weekends and holidays automatically.

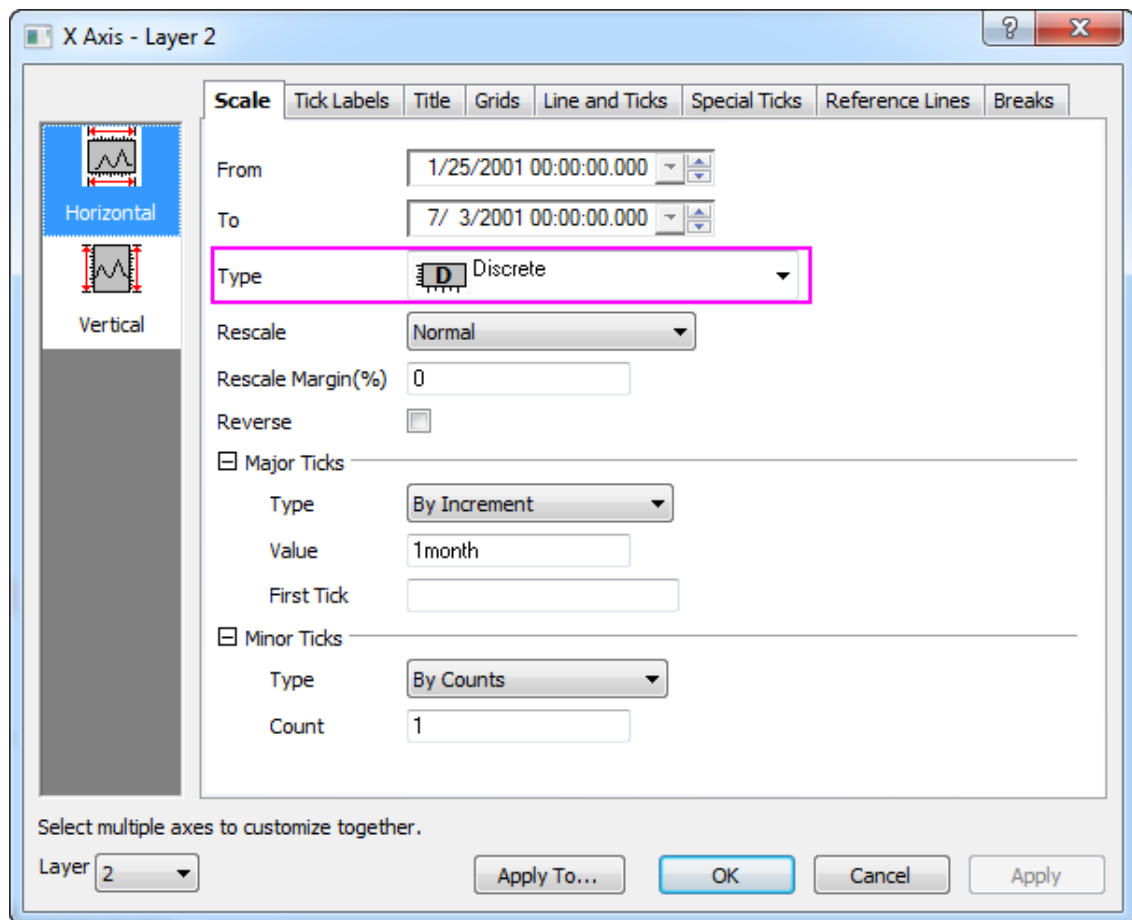

- Change the axis rang From 3/3/2001 To 5/7/2001. Under the **Major Ticks** branch, make sure **Type** is set to *By Increment*. Type *1week* for **Value**. Under the **Minor Ticks** branch, make sure **Type** is set to *By Counts*. Type *5* for **Count**. Click **Apply** button. You can see weekend and holidays are skipped

clearer.</br>

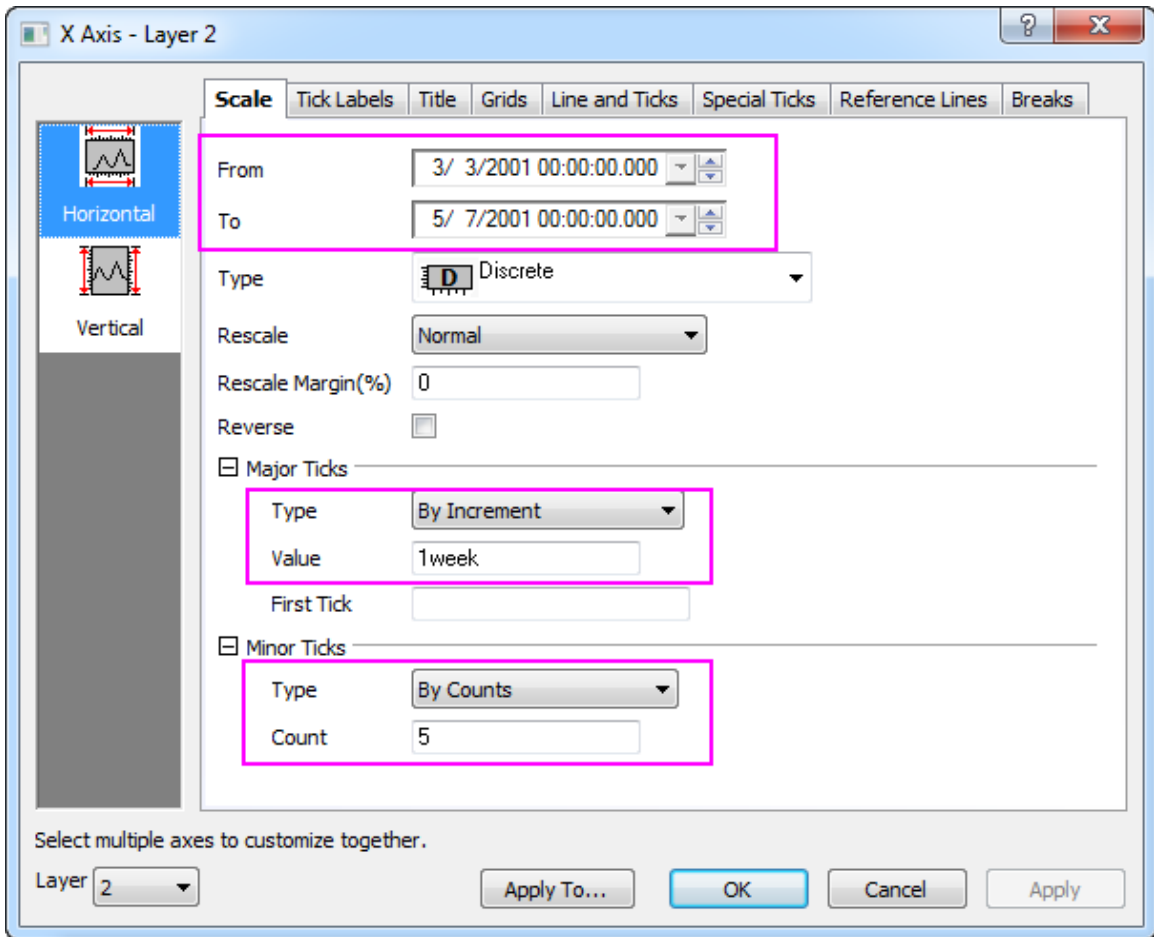

- To show bottom axis label as multiple lines, switch to the **Tick Label** tab. Activate the **Dsisplay** sub-tab. Select **Custom Display** for **Display** drop-down list. Enter the text below in **Custom Display** text box.

hhtt      MMMdd      -----      YYYY

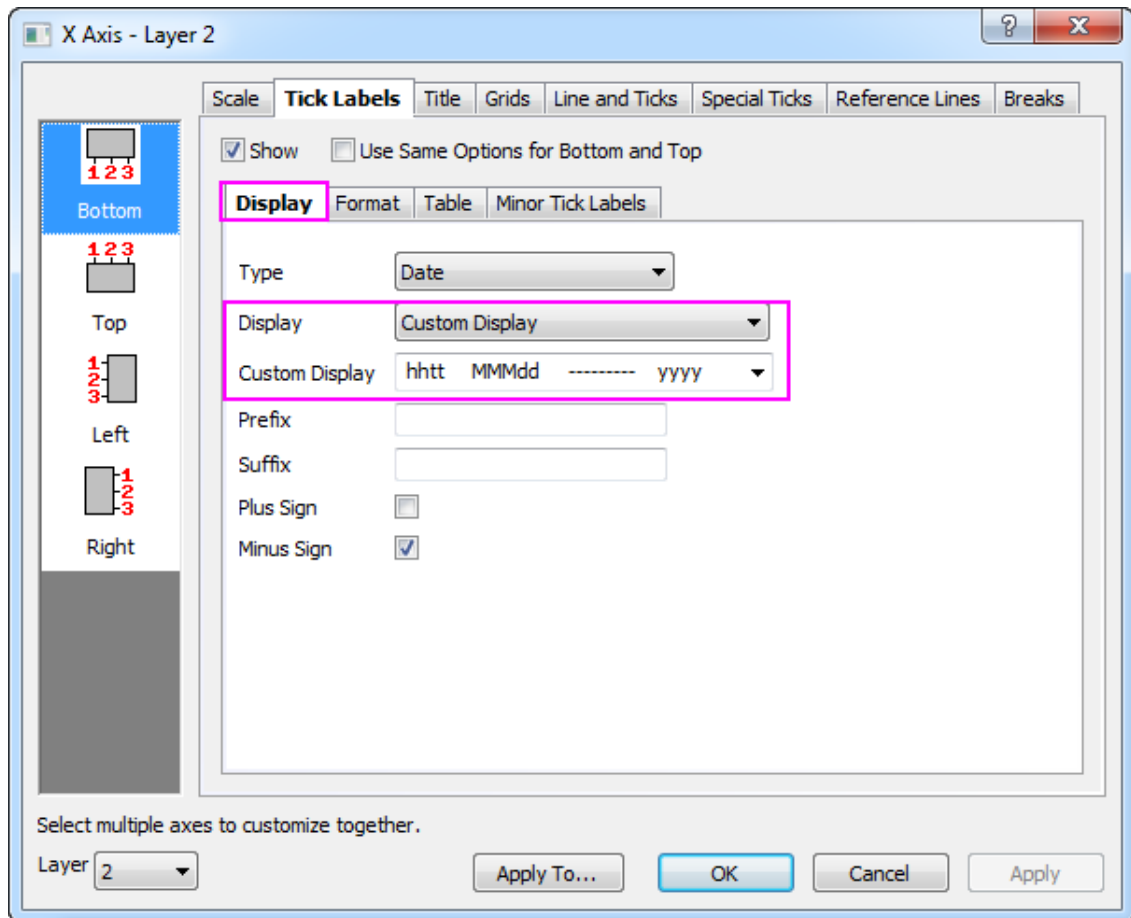

Go to **Format** sub-tab, set Font Size to 10 and check **Wrap Text** check box.



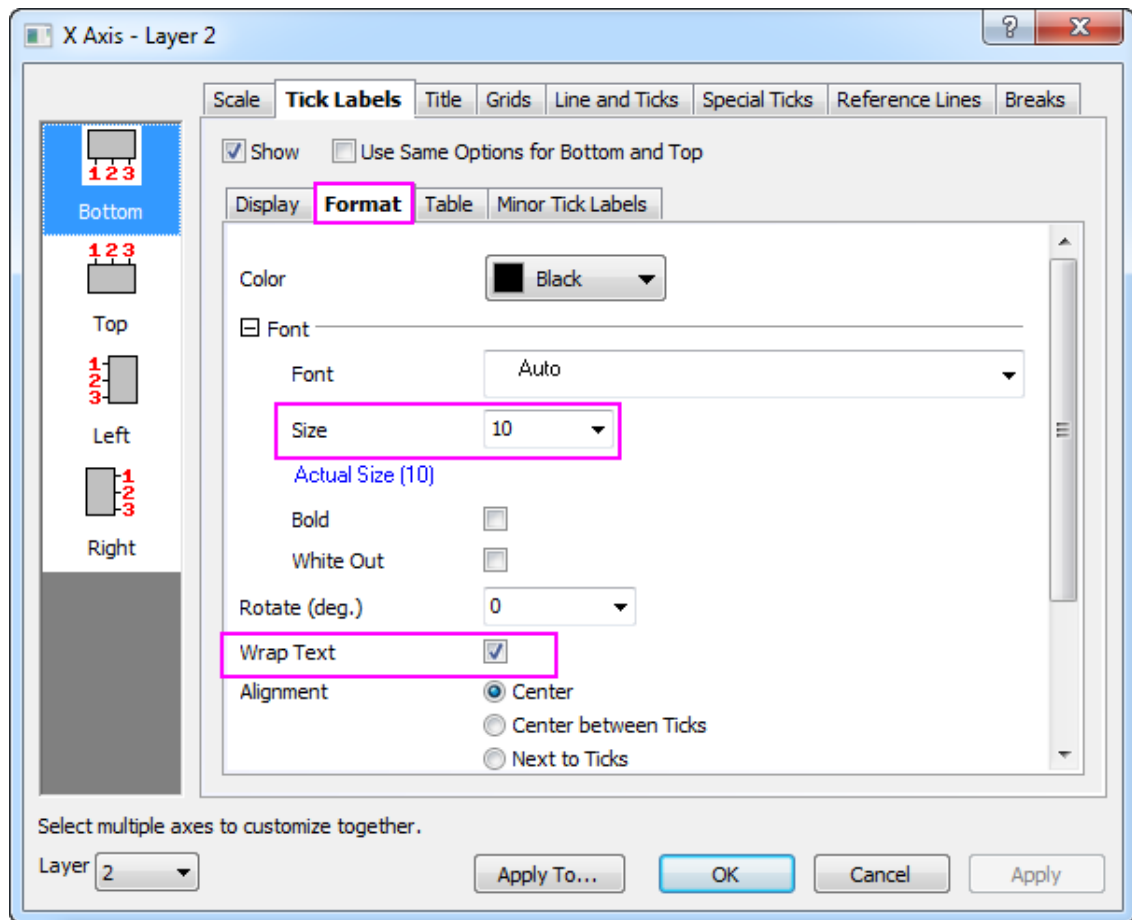

Click **Apply** button.

6. Go back to **Scale** tab, select **Vertical** icon at the left panel, then set **From** and **To** to 0 and 120M. Click **Apply** button.
7. Select 1 under the **Layer** drop-down list which locates at the left-bottom corner of the dialog to switch to **Layer 1**. Then with **Vertical** icon still chose, set **From** and **To** to 12 and 22. Click OK button to close the

dialog.

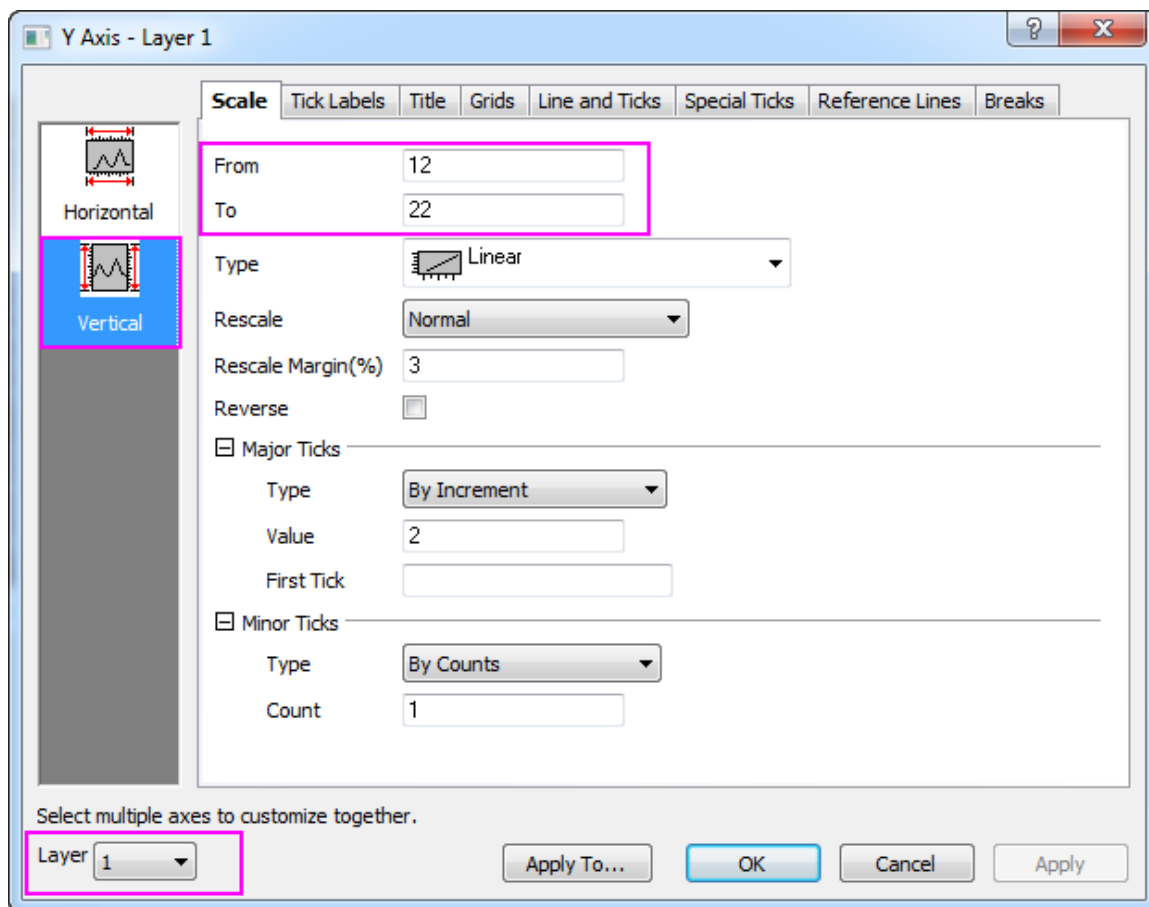

8. Double-click on the column plot at Layer 2 to open the **Plot Details** dialog. In the Pattern tab, expand the **Fill Color** drop-down list, go to **By Points** sub-tab, under the **Index** list, select **Col(B) : "Week Day"**,

then select **D01 Pumpkin Patch** under **Color List**. Click OK button to close this dialog.

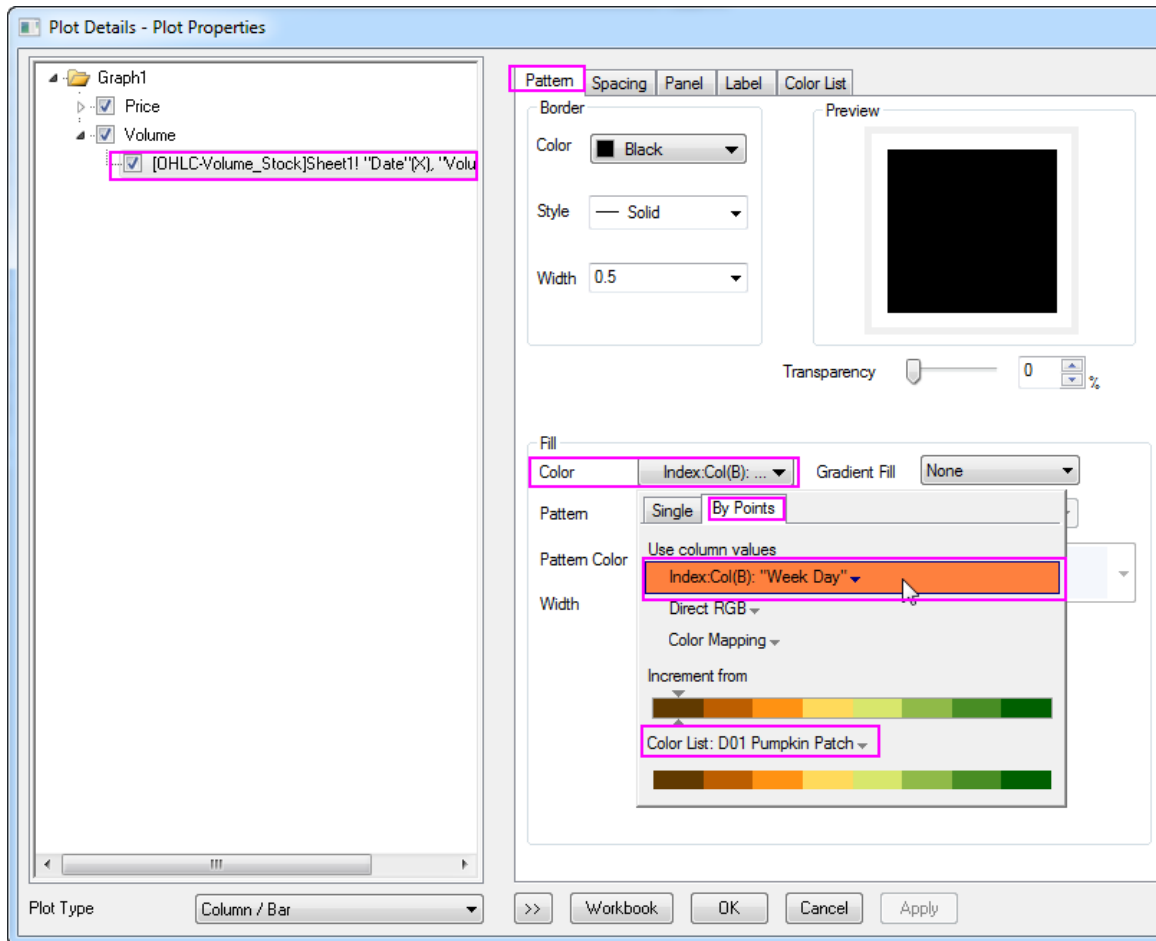

9. With Layer 2 activated, select **Graph: Legend : Categorical Values** menu. In the dialog opened, keep the default settings, click **OK** button. A legend will be added onto graph. Select the legend to show up the legend border, press the **Ctrl** key to drag the legend border to make the legend items arranged in one line.
10. Resize and re-position the legend box. The Final graph should appear as shown below:

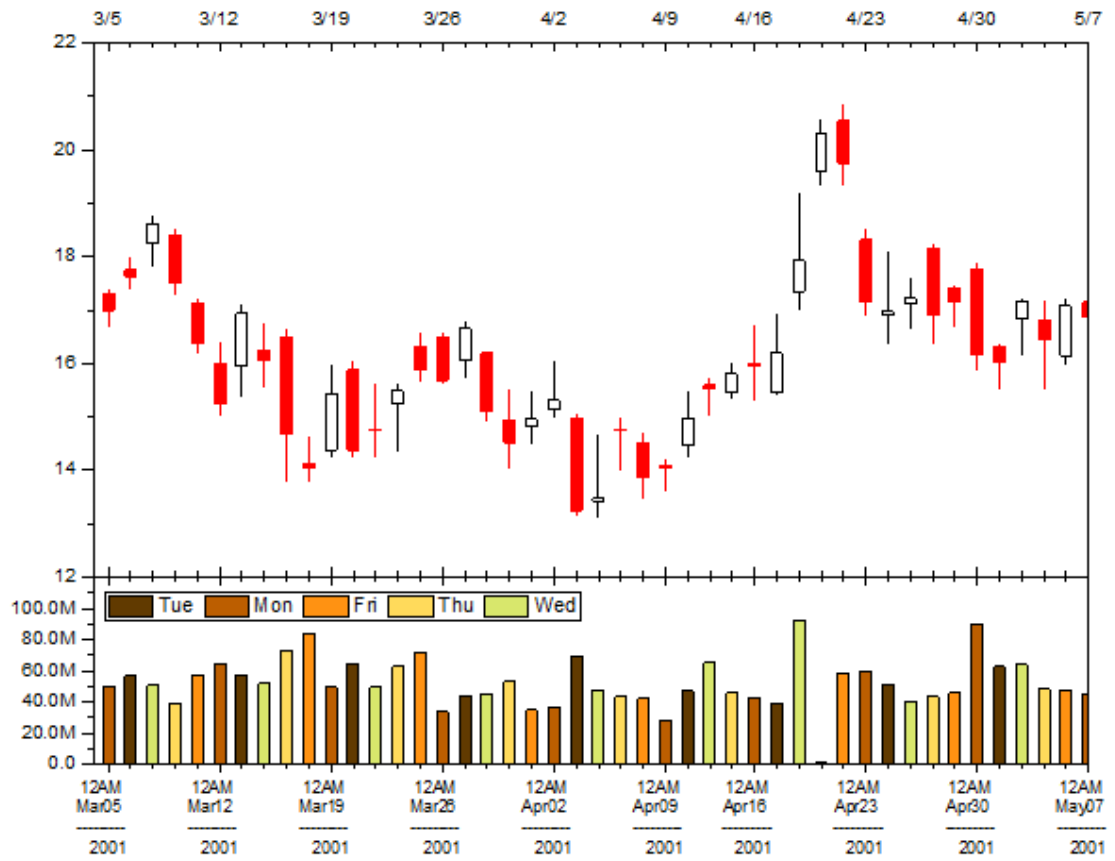

11.

## 7 Data Management

### 7.1 Data Management

- [Working with Multi-Sheet Workbooks](#)
- [Adding Objects to Worksheet](#)

### 7.2 Working with Multi-Sheet Workbooks

#### 7.2.1 Summary

Origin workbooks are similar to spreadsheets and can have multiple worksheets. Multi-sheet workbooks allow for better organization and higher information density.

#### 7.2.2 What you will learn

This tutorial will teach you how to:

- Add and arrange worksheets.
- Handle metadata.
- Split the worksheet into Panels using Dividers.

#### 7.2.3 Steps

##### 7.2.3.1 [Adding and Arranging Worksheets](#)

1. Click the **New Project** button  on the **Standard Toolbar**.
2. Right-click on the **Sheet1**' *tab and choose Name and Comments*. Enter **Subjects** as the **Short Name** in the **Name and Comments** dialog.
3. Right-click on the tab of the sheet that was renamed in the last step, and choose **Add**. A second sheet, named **Sheet1**, will be added to the book.
4. Double-click on the new **Sheet1** tab and enter **2nd Test** as the name in the font box that appears. (Alternately, right-click and use the the **Name and Comments** option again.)
5. Right-click on the **2nd Test** name and choose **Insert**. A new sheet, named **Sheet1**, is inserted between **Subjects** and **2nd Test**. Rename the new sheet **1st Test**.
6. Left-click and hold down the mouse button on the **1st Test** sheet name, drag the mouse over the Origin Workspace and release. The **1st Test** sheet will now appear in its own workbook.

7. Select **Window: Tile Vertically** to arrange the workbooks side by side as shown below:

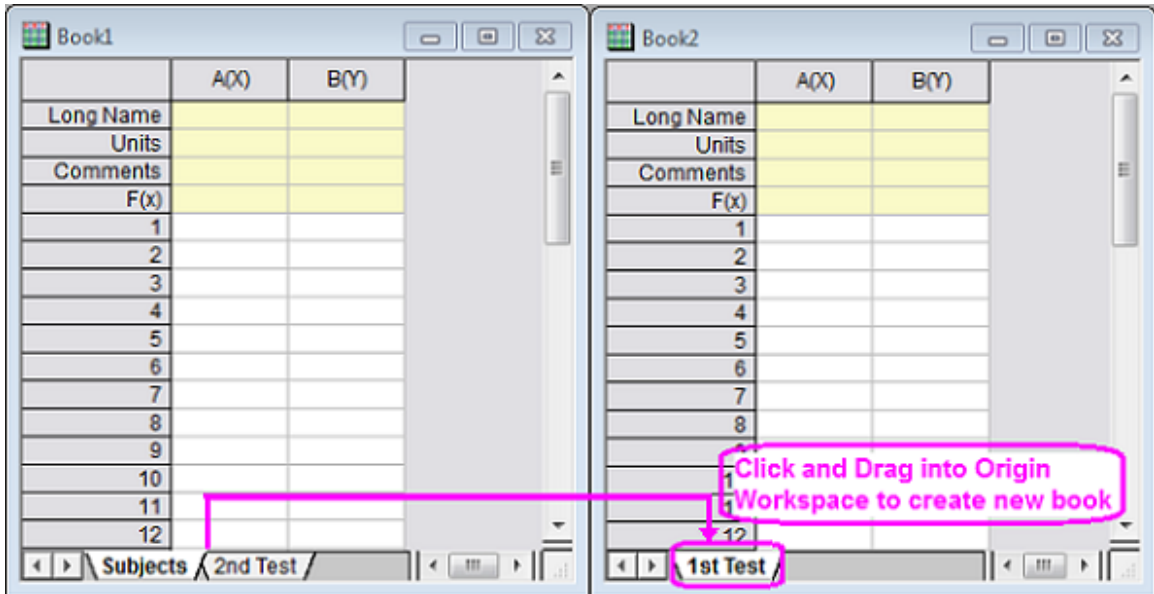

8. Drag **2nd Test** to the second workbook. This will move the **2nd Test** sheet from the original workbook to the new workbook as shown below:

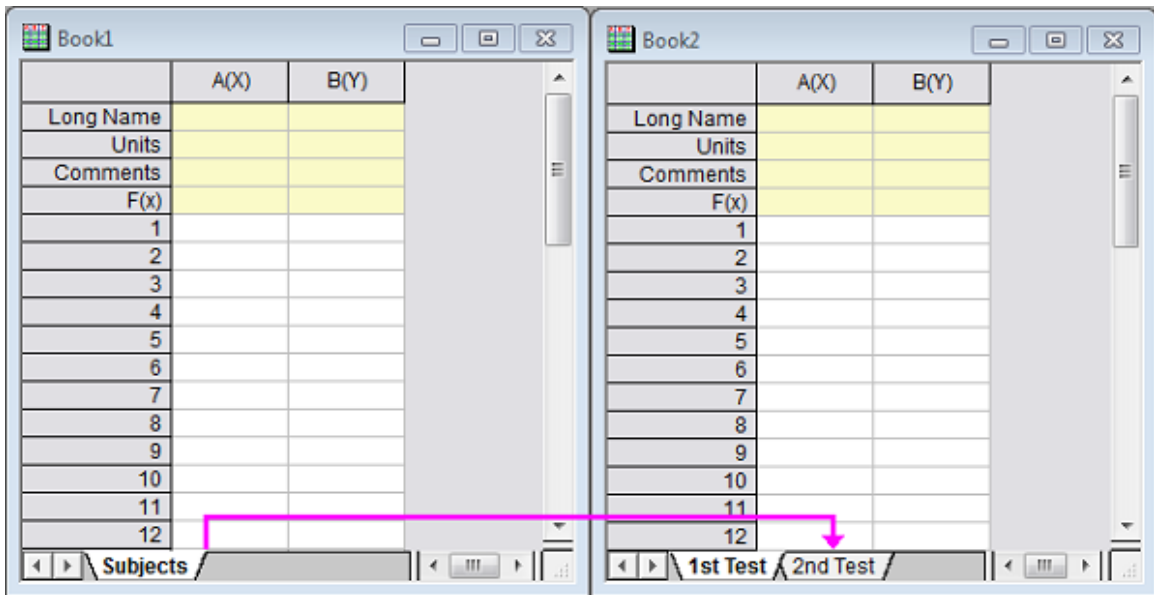

9. Click the **Save** button . The **Save As** dialog will open since the project is yet to be saved. Save this in the User Files Folder as **Multi-Sheet Workbooks.opj**

**Note:** It is also possible to drag and drop sheets within the workbook to change the order. Right-click on any sheet name and note these additional options: **Duplicate Without Data**, **Duplicate**, **Delete** and

**Navigate.**

### 7.2.3.2 Handling Metadata

#### 7.2.3.2.1 Add Metadata to the Worksheet

1. Click the **New Project** button  on the **Standard Toolbar**.
2. Select **Format: Worksheet** from the Origin menu (Alternatively press **F4** or double-click on the gray area to the right of the columns). The **Worksheet Properties** dialog opens:

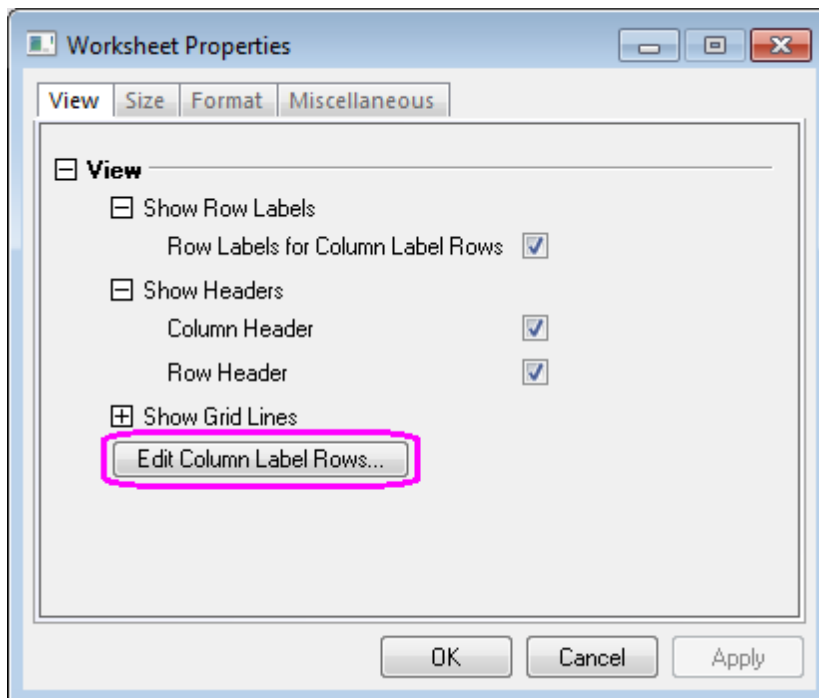

3. On the **View** tab, click the **Edit Column Label Rows** button. The **Column Label Rows** dialog opens.
4. Right-click on the table and select **Add User-Defined Parameter**. Scroll down to note that a **UserDefined** label has been added. The **Show** box is checked by default.

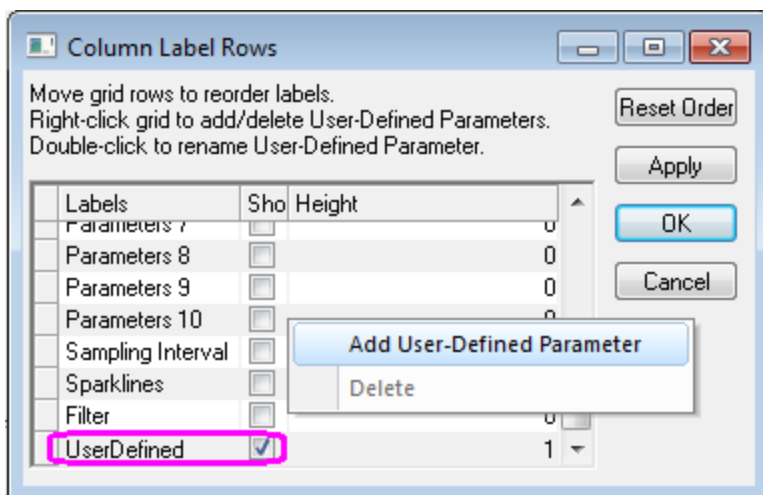

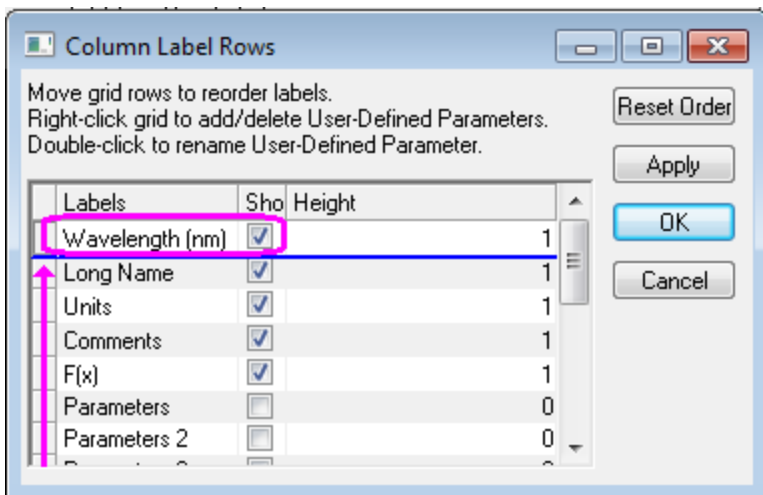

5. Double-click on the **UserDefined** text (or single-click and press F2), and change the **UserDefined** text to **Wavelength (nm)**.
6. Click in the box to the left of **Wavelength (nm)** and drag it to the top of the list, dropping it above **Long Name**. This will change the order of the rows as shown below:



7. Click **OK** to close the Column Label Rows dialog.
8. Select the **Format** tab in the **Worksheet Properties** dialog, and choose **LongName** from the **Apply To** drop-down. Check the **Rich Text** box.

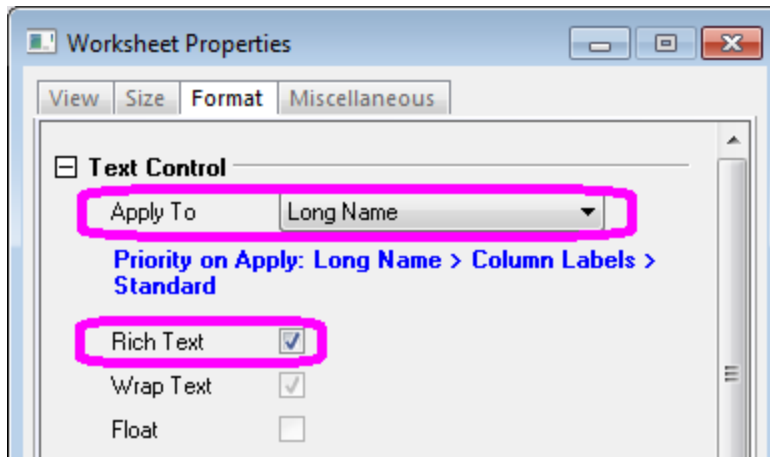



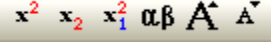

9. Click **OK** to close the **Worksheet Properties** dialog box.
10. Highlight the **Comments** row and click the **Merge Cells** button  on the **Style Toolbar** to create a row with one cell.
11. Enter the values shown below in the Columns A and B header region (**Wavelength** to **Comments**).  
(Note: Once the Rich Text box is checked for specified cells, double-clicking in the cells to edit them will activate the format buttons . These can be used to apply rich text formatting as shown below):

	A(X)	B(Y)
Wavelength (	650	700
Long Name	1 <sup>st</sup> Sample	2 <sup>nd</sup> Sample
Units	nm	nm
Comments	IR	
F(x)		
1		
2		
3		

### 7.2.3.2 View Metadata in the Workbook Organizer

1. Click on the **New Folder** button .
2. Click on the **Import Single ASCII** button .
3. Browse to file **S15-125-03.dat** in Origin's *Sample\Import and Export* folder. The **Show Options Dialog** checkbox should be deselected by default. Click **Open** to import the file to Origin.
4. Right-click on the workbook window title and choose **Show Organizer** from the context menu. The **Worksheet Organizer** will appear at the bottom of the worksheet.

- Expand the **Imported Files** branch and view the stored metadata.

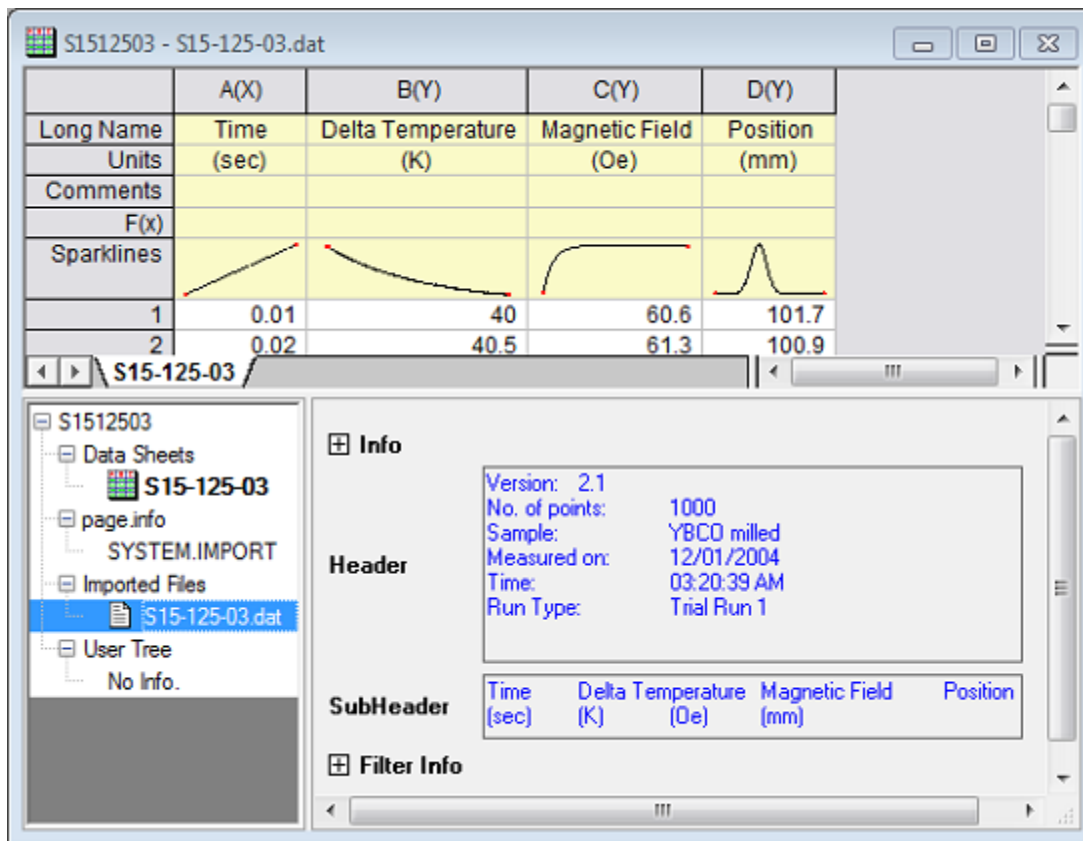

### 7.2.3.3 Splitting Worksheets into Panels using Dividers

#### 7.2.3.3.1 Split from Menu

1. Activate the worksheet and highlight a cell.
2. Select **Window: Split** from the Origin menu.
3. The worksheet or matrix sheet will be divided into 4 panels by a horizontal and vertical Divider at the highlighted cell. To move the Divider to a new location, drag it to the desired row or column.
4. Select **Window:Remove Split** from the Origin menu to hide the split pointers.  
(Note: This process is the same for worksheets and matrix sheets).

#### 7.2.3.3.2 Split by Dragging the Divider

1. Point the cursor to the bottom right of the sheet at the end of the vertical scroll bar (for a horizontal Divider) or at the right end of the horizontal scroll bar (for a vertical Divider) as shown below:
2. When the pointer changes to a split pointer, drag it to the desired position. A horizontal or vertical Divider will be created.

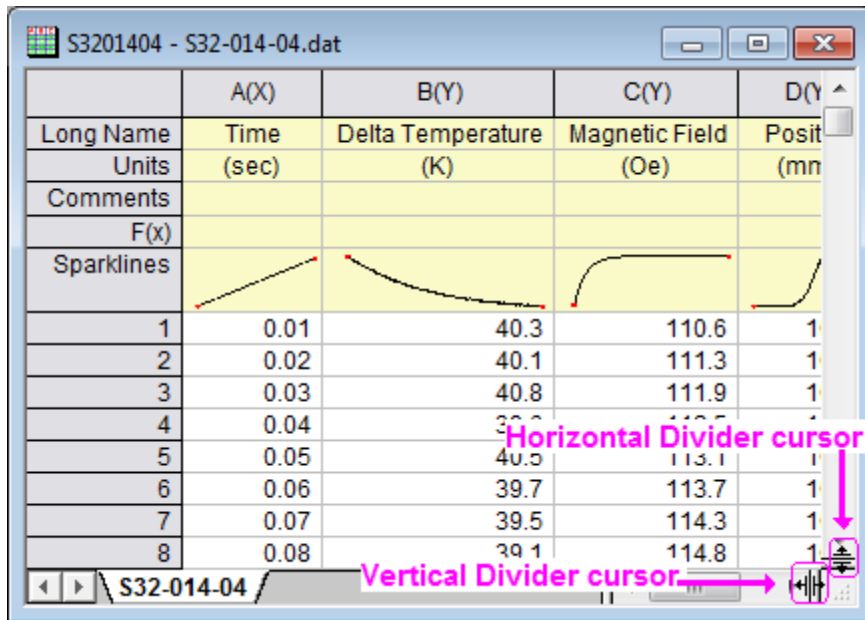

A worksheet with horizontal and vertical Dividers is shown below:

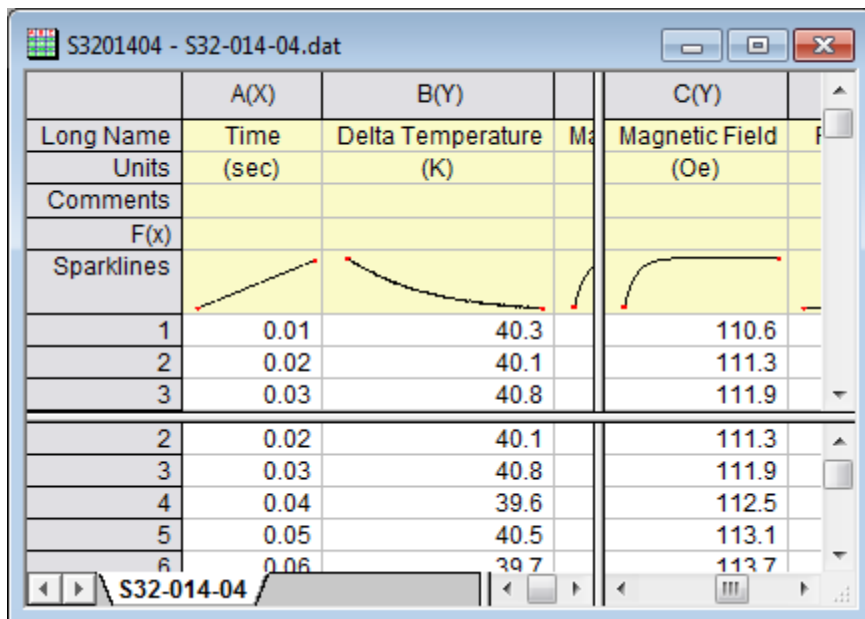

## 7.3 Adding Objects to Worksheet

### 7.3.1 Summary

Both worksheet header rows and data cells can contain embedded objects, linked objects as well as formatted text. In addition, floating graphs can be added to the worksheet like Excel.



**Note:** Beginning with Origin 2018, any inserted graph, whether it be a an **editable graph**, a graph inserted as a **linked or static picture**, an **image inserted from file**, or a **sparkline**, will generate a pop-up preview when you hover on the containing worksheet cell.

## 7.3.2 What you will learn





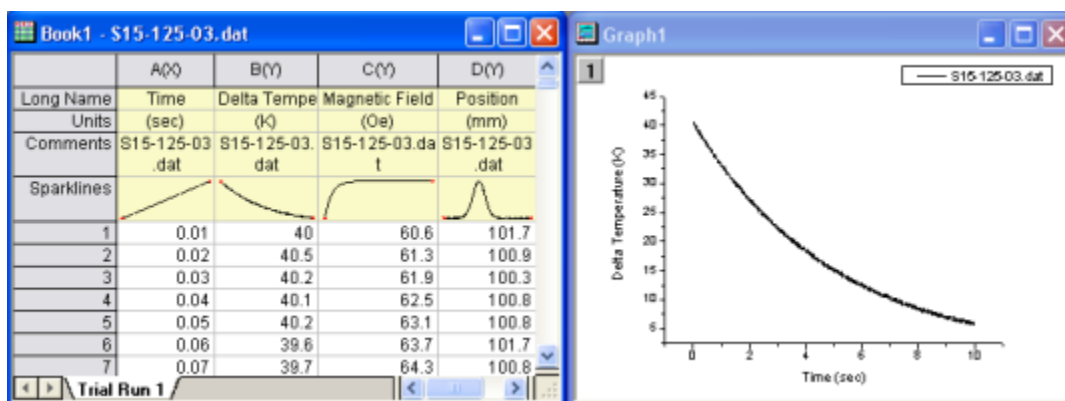

- How to insert various objects into a worksheet cell.
- How to add floating graph to worksheet.

## 7.3.3 Steps

### 7.3.3.1 Inserting Objects in Cells

1. Start with a New Project by clicking on the **New Project** button .
2. Click on the **Import Wizard** button . In the **Import Wizard - Source** page, browse to select *S15-125-03.dat* file in Origin's *Sample\Import and Export* folder. Click on the Finish button to complete the importing.
3. Highlight columns **A(X)** and **B(Y)**, choose **Plot > 2D: Scatter: Scatter** from the menu or click on the **Scatter Plot** button  to create a graph.



4. Return to the workbook and select the **Column: Add New Columns...** from the menu or click on the **Add New Columns** button  to add 3 columns.
5. Expand the workbook so you can see all 7 columns.
6. In the row **1** of **E(Y)**, type **New Features** and press Enter.
7. Select cell **E1**, and then click the **Bold** button  on the **Format Toolbar**.
8. Click the **Font Color** button  on the **Format Toolbar** and pick **Yellow** as the color.
9. Click the **Fill Color** button  on the **Style Toolbar** and pick **Blue** as the color.
10. Select the range **E1** to **F1**, click the **Merge cells** button .
11. Right-click on cell **G1** and choose **Insert Arrow: Left** from the context menu to insert a arrow to the cell.
12. Select the range **E2** to **G12**, click the **Merge cells** button .
13. Right-click on the cell and choose **Insert Graph**.

14. In the **InsertGraph** dialog, type **Graph1** in the large Graphs box or click on the **Browse** button  to select Graph1.

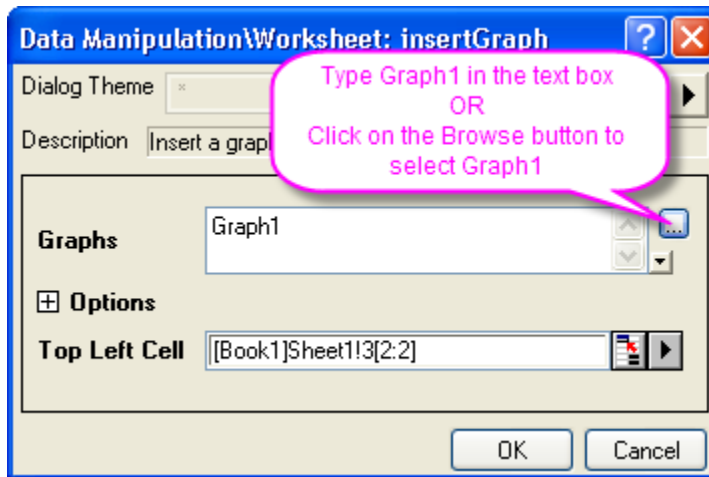

15. Click **OK** to close this dialog.
16. Right-click on **E13** to choose **Insert Images from Files** from the context menu.
17. Click the **Browse** button  and change the **Files of Type** to **Bitmap (\*.bmp)**.
18. In the Origin User File Folder, select the **Userdef.BMP**, click **Add File(s)** button and then click **OK** button.
19. Click **OK** button to close the **InserImg** dialog.
20. Right-click on cell **F13** to choose **Insert Notes**.
21. Double-click on cell **F13**. Modify the text and then close the **Notes** window. A note will be saved in the cell.
22. Right-click in **E14** and choose **Insert Sparklines** to open the **InsertSparklines** dialog.
23. In the dialog, click the **Data Columns** fly-out button to choose **C(Y)**. Uncheck **Long Name in 1st Column** check box.

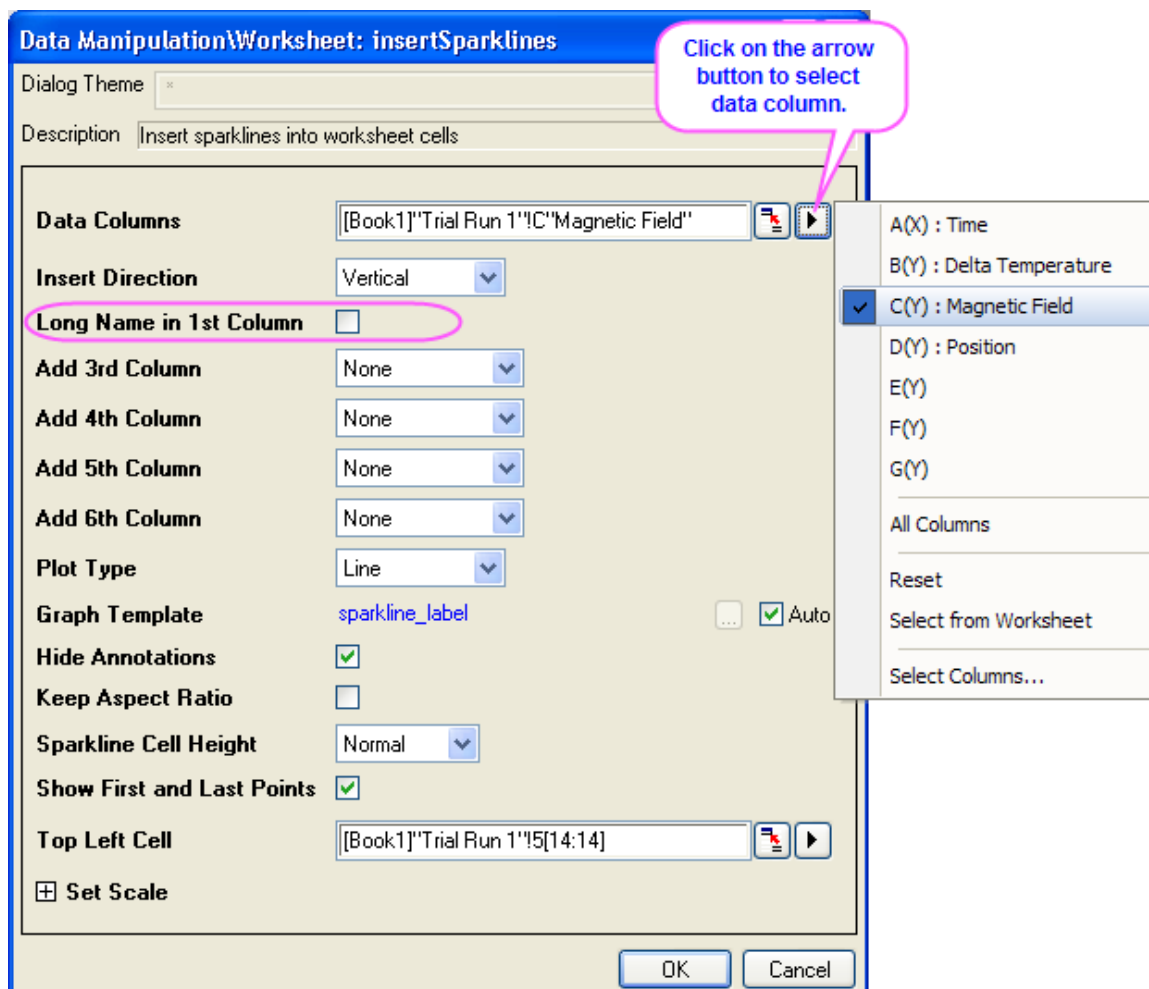

24. Click **OK** to close the dialog. A sparkline will appear in the cell.
25. Click on cell **E15** and type: <http://www.originlab.com> and press Enter.
26. Click on the text in **E15** which opens your web browser to the OriginLab web site.
27. Click on cell **E16** to choose **Insert Variables** from the context menu. The **Insert Variable** dialog opens.
28. with the worksheet **Book1** is selected in the right panel, go to the **Info** tab, expand the **USER.VARIABLES** branch, select **SAMPLE** and then click on the **Insert** button. A variable will be inserted to the cell.

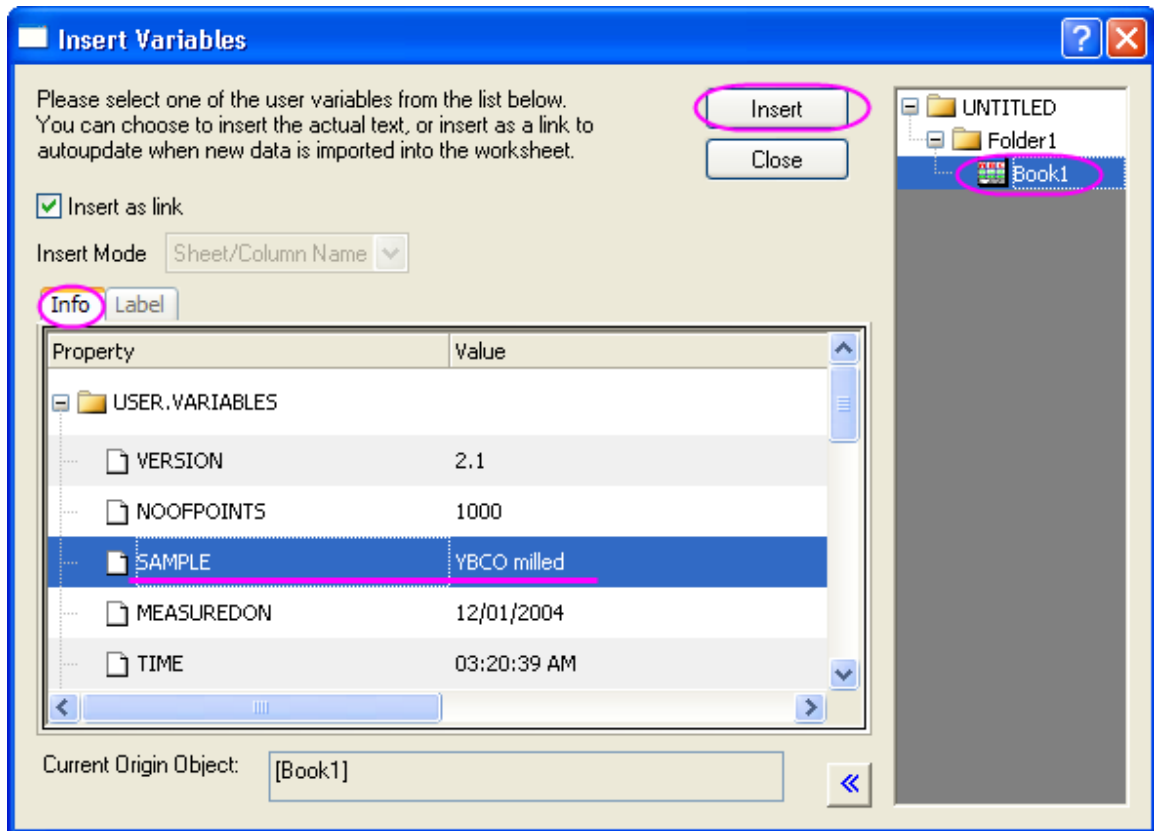

29. Double-click on the cell **E16**, the text will change to a variable string.

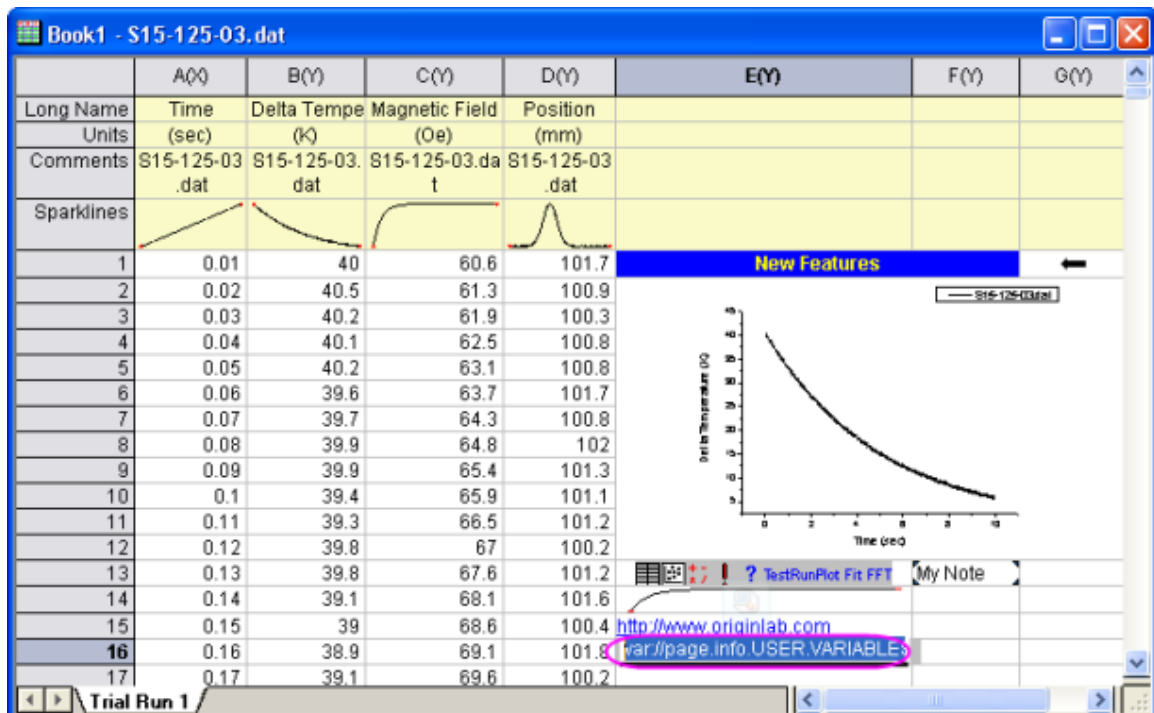

The Graph, Notes and Sparklines in the above lesson are all examples of embedded objects (the Insert Graph could be either Embedded or Linked.) Embedded objects present a visual of a hidden external object that can be opened by double-clicking. Changes to the object can be made and then the object window can be closed and the source worksheet cell is updated.

### 7.3.3.2 Adding floating Graph to worksheet

1. Continue the above project. Highlight Col(D) in Book1 to plot a line graph.

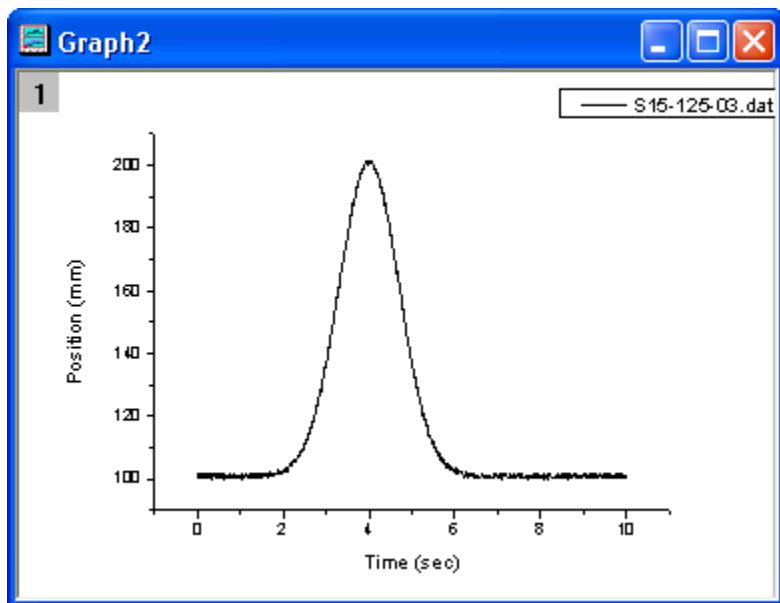

2. In Book1, right-click the empty area or title of the book to select **Add Graph:Graph1** from the context menu. The graph is added to the sheet. **Note:** Origin pre-loads the last-created graph to the **Add Graph** shortcut command. If you only see the shortcut **Add Graph** (no named graph following the shortcut command), clicking **Add Graph** will open the **Graph Browser**. In the **Graph Browser**, select your graph and click **OK** to insert the graph and return to the worksheet.
3. Left-click and hold down the mouse button on the graph and drag it to reposition it on the worksheet.



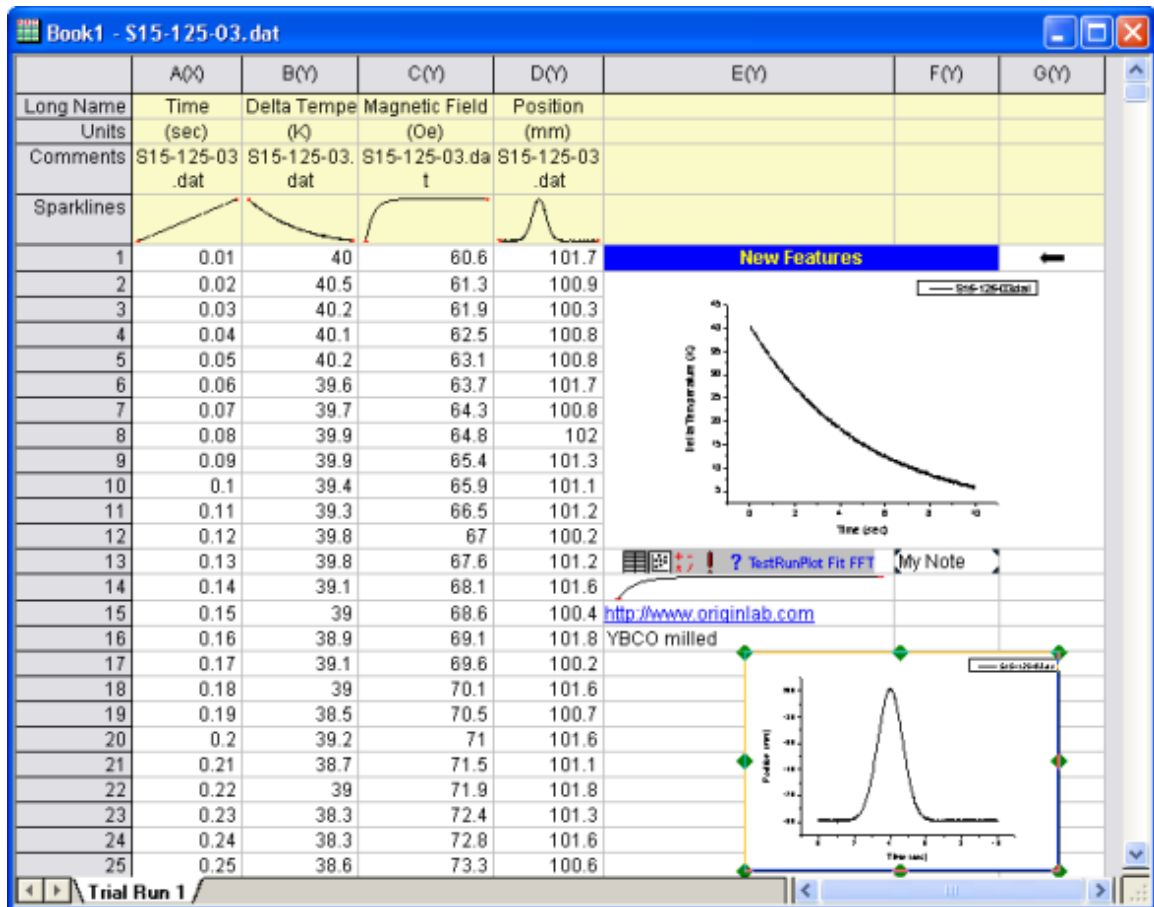



## 8 Data Exploration

### 8.1 Data Exploration

- [Data Reader Tool](#)
- [Use Data Cursor to Show the Difference between the Data](#)

### 8.2 Data Reader Tool

#### 8.2.1 Summary

The **Data Reader**  is an exploratory tool that uses the **Data Info** window to display information about a selected data point in a graph. Essentially anything that is contained in the worksheet, in association with a plotted data point, can be shown in the **Data Info** window. This includes coordinate values, column headers, or even cell-embedded images. In addition, you can customize the window to display numeric values using a custom format (e.g. date-time, Lat/Lon, etc.), or to change window background color, add a window title, etc.

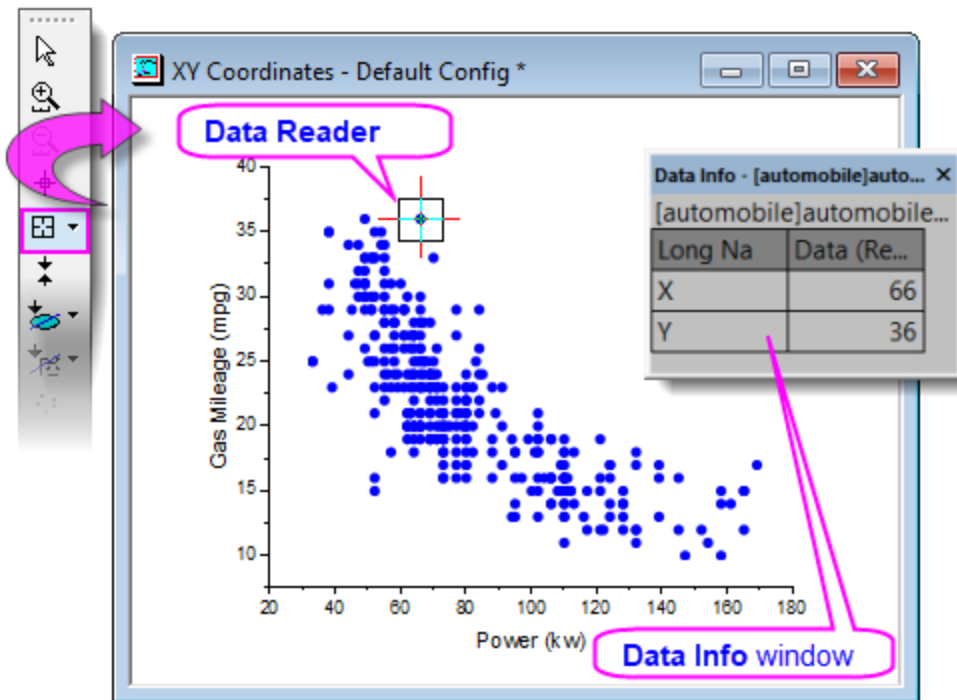

Minimum Origin Version Required: Origin 2019



Beginning with Origin 2019, you can read data point coordinates in a 2D graph by hovering on the data point. This **Data Point Tooltip** is highly customizable, mimicking **Data Info** window functionality. For more information, see [Data Point Tooltips](#).

## 8.2.2 What you will learn

This tutorial will demonstrate how to:

- Use the **Data Info** window to view information for a selected data point in the graph.
- Customize **Data Info** window content, to include the display of images (Tutorial 1).
- Customize **Data Info** window content, to display numeric data using custom formatting (Tutorial 2).

## 8.2.3 Tutorial 1: Basic Usage

1. Select **File: Open...** to open the *Alkanes.opj* in the <Origin Folder>\Samples\Data Exploration folder.
2. Highlight Column D in Book1 Sheet1, and select **Plot > 2D: Scatter: Scatter** to create a new graph.
3. Click the **Data Reader**  button from the **Tools** toolbar, and click on the *Isobutane* data point on the new graph.

The **Data Info** window showing the X and Y coordinates of the data point selected will appear.

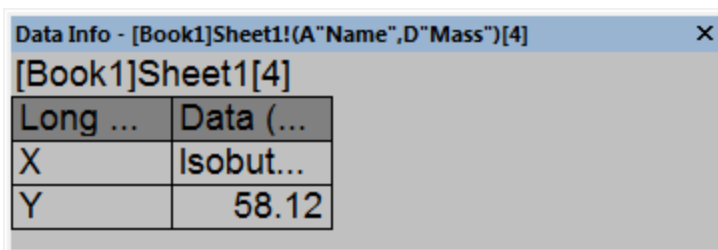

4. Right-click on the **Data Info** window, and select **Preferences** from the context menu to open the **Data Info Report Settings** dialog.

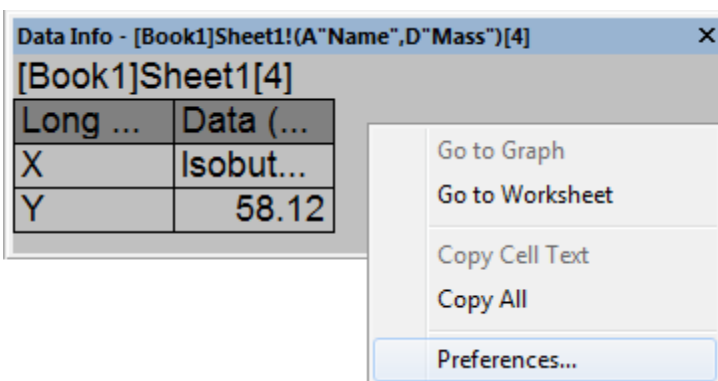

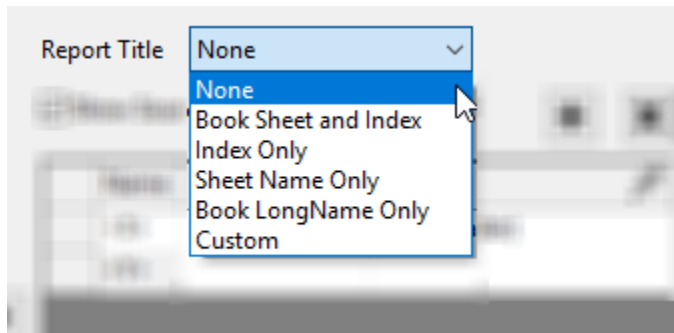

5. To remove the book and sheet name from the **Data Info** window, set the **Report Title** drop-down to **None**.

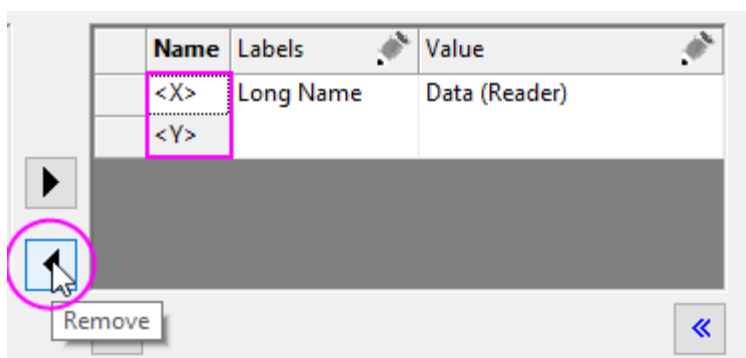

6. In the center portion of the dialog, remove the X coordinate by clicking on <X>, then clicking the Remove button. Do the same for the Y coordinate (<Y>).

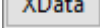

7. In the upper-left corner of the dialog, click the **X Data**  button, then the **Y Data**  button to add the X and Y data source. Note the use of dataset **Long Names** in the **Preview**.
8. All source worksheet columns that can be added to the **Data Info** window are listed in the left panel. Highlight the **B, C, E, G, and H** columns and add them to the center panel by clicking the **Select** button. Note that at this point, the **Preview** shows that our window has two columns.

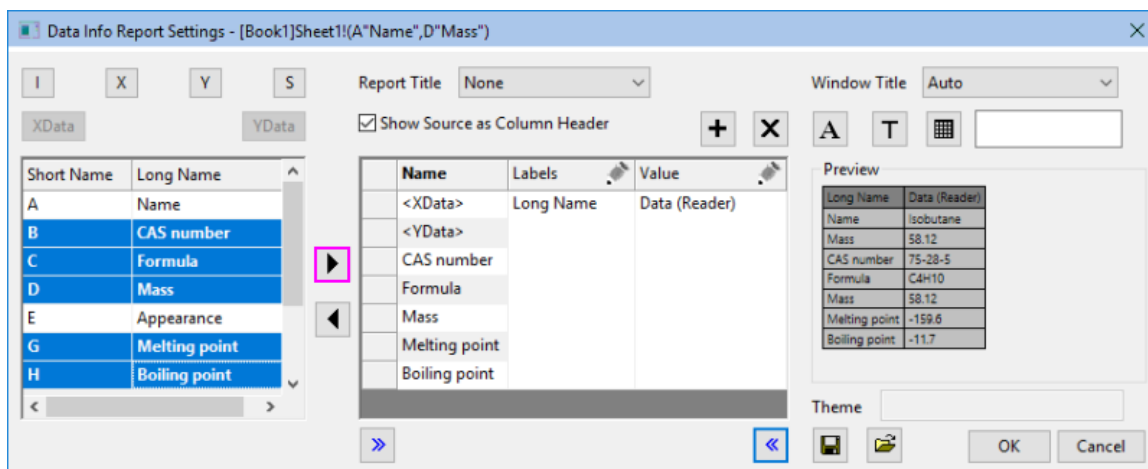

9. Click the **Add Column** button to add a third column to our table. Click the pencil icon above the third column and in the **Column Settings** dialog, set **Type** = *Single Cell* and **Source** = *J "Ball and stick model"*. Set **Column Width** = 20 and click **OK**. Click the pencil icon above the first and second columns

and set **Column Width** = 15 and 20, respectively.

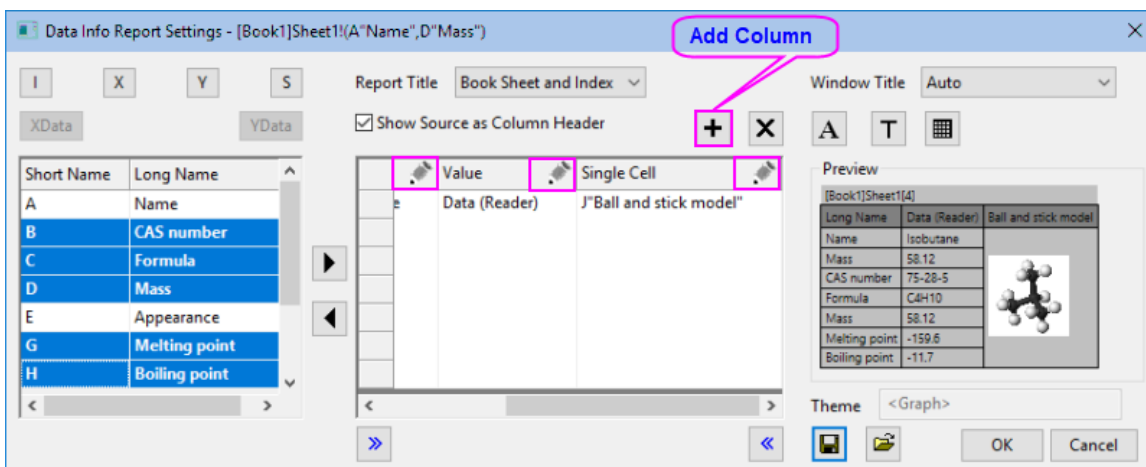

10. Click the **Font** button to open the Tooltip Font dialog. Set **Minimum Font Size** and **Maximum Font Size** to 10 and 16 respectively. This will for text to automatically resize as the **Data Info** window is resized. Note that this limits the resizing of the **Data Info** table, as well. Set the **Font Color** to **Royal** and click **OK**. Click the **Background** button, set **Background** = **White** and click **OK**.
11. Click on the **Theme** button and select **Save to <Graph>** in the fly-out menu. This ensures that your **Data Info** dialog settings will be saved to the active graph, then click **OK** to close the **Data Info Report Settings** dialog.

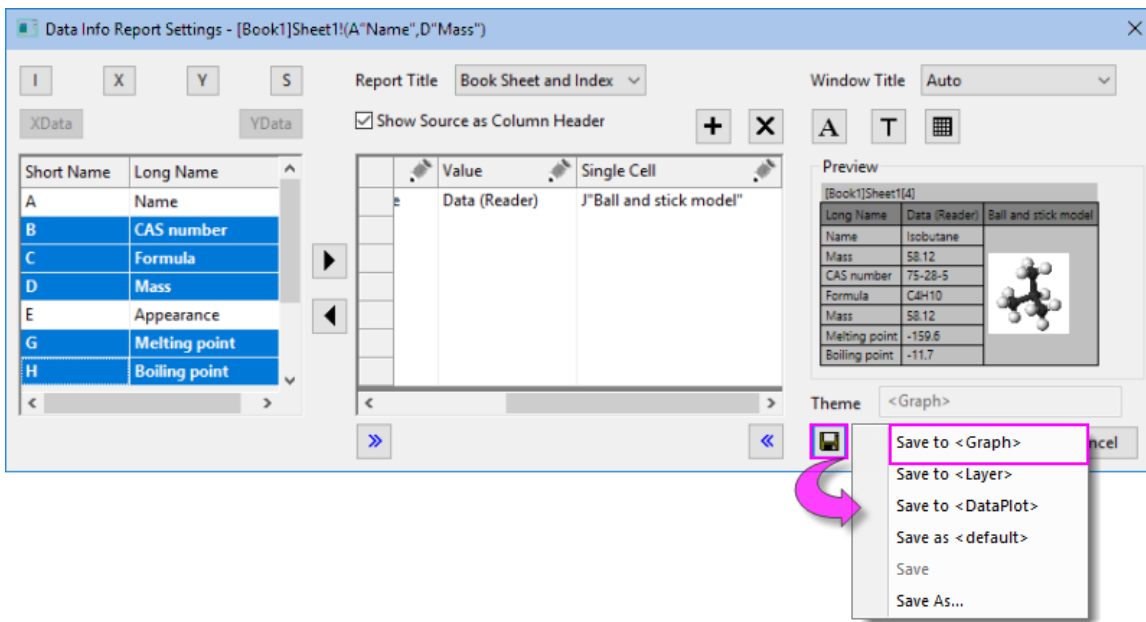

12. Resize the **Data Info** window by dragging a window corner. Note that the font size range that we specified previously, set limits on window resizing.

Drag a window corner to resize the display

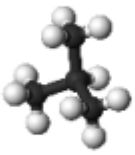
Long Name	Data (Reader)	Ball and stick model
Name	Isobutane	
Mass	58.12	
CAS number	75-28-5	
Formula	C4H10	
Mass	58.12	
Melting point	-159.6	
Boiling point	-11.7	

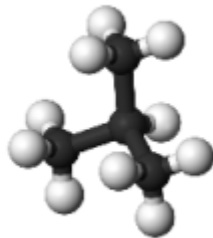
Long Name	Data (Reader)	Ball and stick model
Name	Isobutane	
Mass	58.12	
CAS number	75-28-5	
Formula	C4H10	
Mass	58.12	
Melting point	-159.6	
Boiling point	-11.7	

## 8.2.4 Tutorial 2: Custom Numeric Display Format

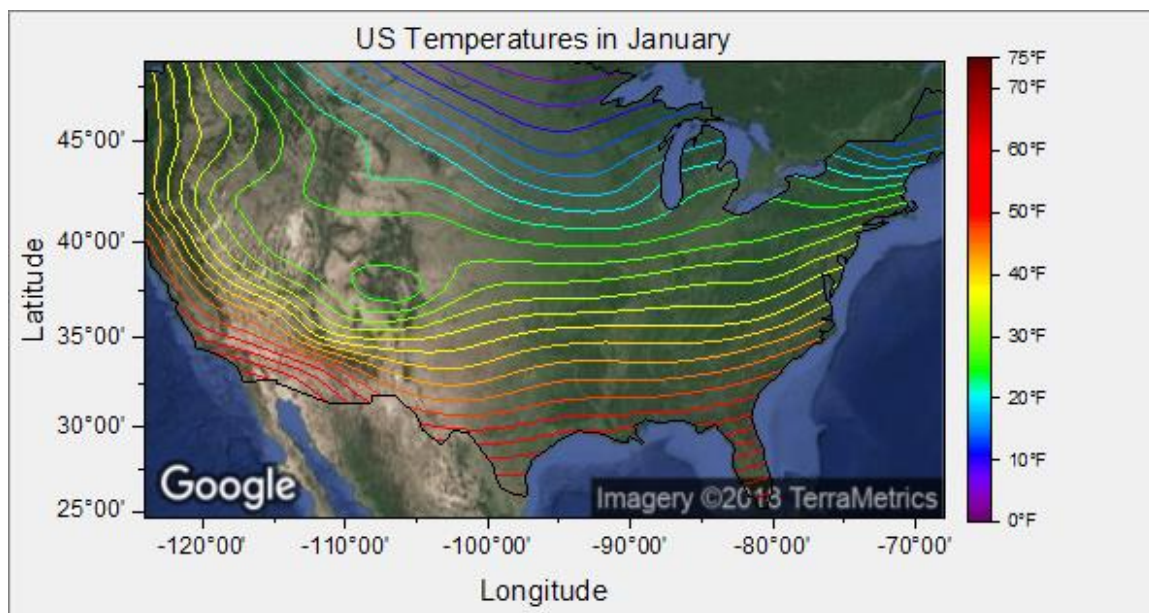

In this tutorial, we'll learn how to apply a custom display format to numeric data shown in the **Data Info** window.

1. Press F11 to open the **Learning Center**, click the **Graph Samples** tab and search on the phrase "Google Map Temperature". Double click on the sample to open this project file containing the following map of the continental US with a contour plot overlay of mean January temperatures.



- 2.

- Double-click on the map + contour plot to open the **Plot Details** dialog box. Click on the **Colormap/Contours** tab and enable **Show Data Points** and click **OK**. What you are now seeing are the US cities where the January temperature data in the map overlay, were recorded. Enlarge the size of the window so that you can get a comfortable view of all scatter points.

- Pick the **Data Reader** tool  from the Tools toolbar (**hint**: it is on a split button with the **Data Cursor**  and the **Data Highlighter** ), then click on one of the scatter points on the map. The Data Info window should open and look something like the following image.

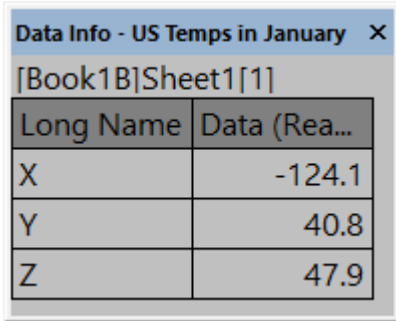

Long Name	Data (Reader)
X	-124.1
Y	40.8
Z	47.9

The information, as reported, is not very user-friendly so we will customize the **Data Info** window to report more useful information.

- Double-click on the Data Info window to open the **Data Info Report Settings** dialog box. Under the **Name** column in the center panel, click on and remove -- one by one -- the **<X>**, **<Y>** and **<Z>** coordinates from the center panel, using the **Remove** button .

- Now click the **XData**, **YData** and **ZData** buttons in the upper-left corner of the dialog to move the X, Y and Z source data, labeled with the column **Long Name**, to the center panel. You can see the result by looking at the **Preview** to the right side of the dialog box.

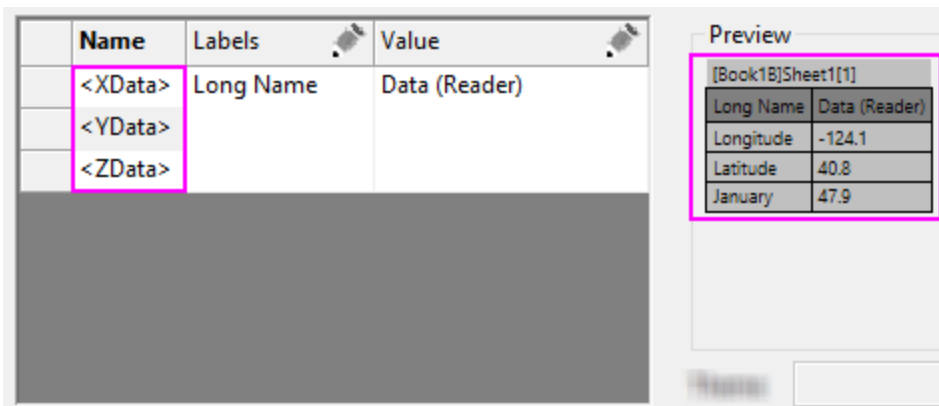

Name	Labels	Value
<XData>	Long Name	Data (Reader)
<YData>		
<ZData>		

Long Name	Data (Reader)
Longitude	-124.1
Latitude	40.8
January	47.9

Currently, our **Data Info** displays two columns, one with column Long Names (*Longitude, Latitude, January*) and a second column with the numeric data associated with *Longitude, Latitude, January*. What



we will do is to apply formatting to these numbers so that they do not simply display as generic decimal numbers.

7. Click the **Add Column** button to add a third column to the Data Info table, then click the pencil icon in the newly-added column to open the **Column Settings** dialog box. Set the **Type** drop-down list to **Numeric Display Format** and click **OK**.

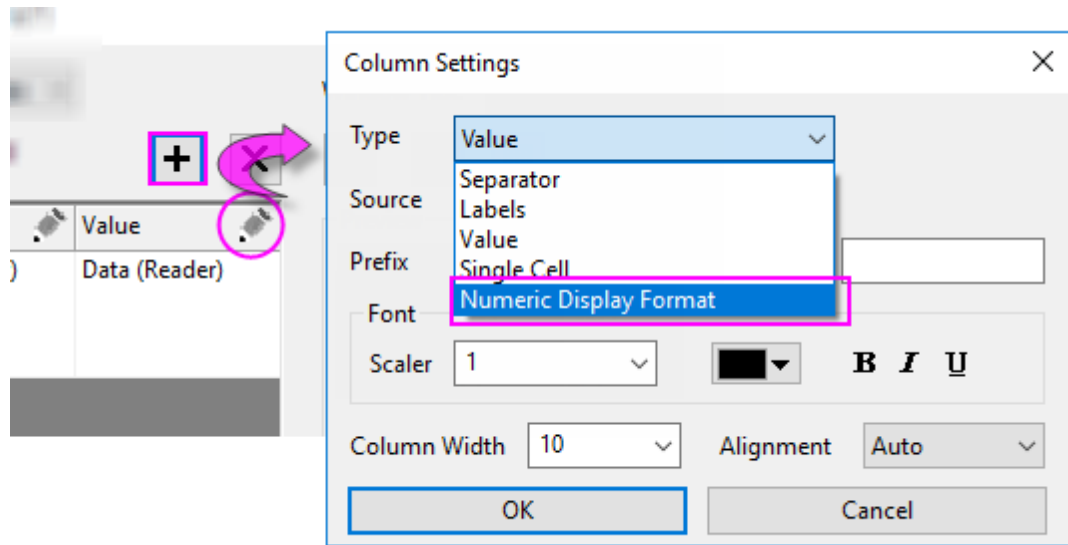

- 8.
9. Click into the first cell below the **Numeric Display Format** heading and you will see a list control that you can click to show a list of custom formatting options. Firstly, note that this list is not exhaustive but contains suggestions for [custom formats](#). Secondly, you can type directly into this box to specify a custom format.

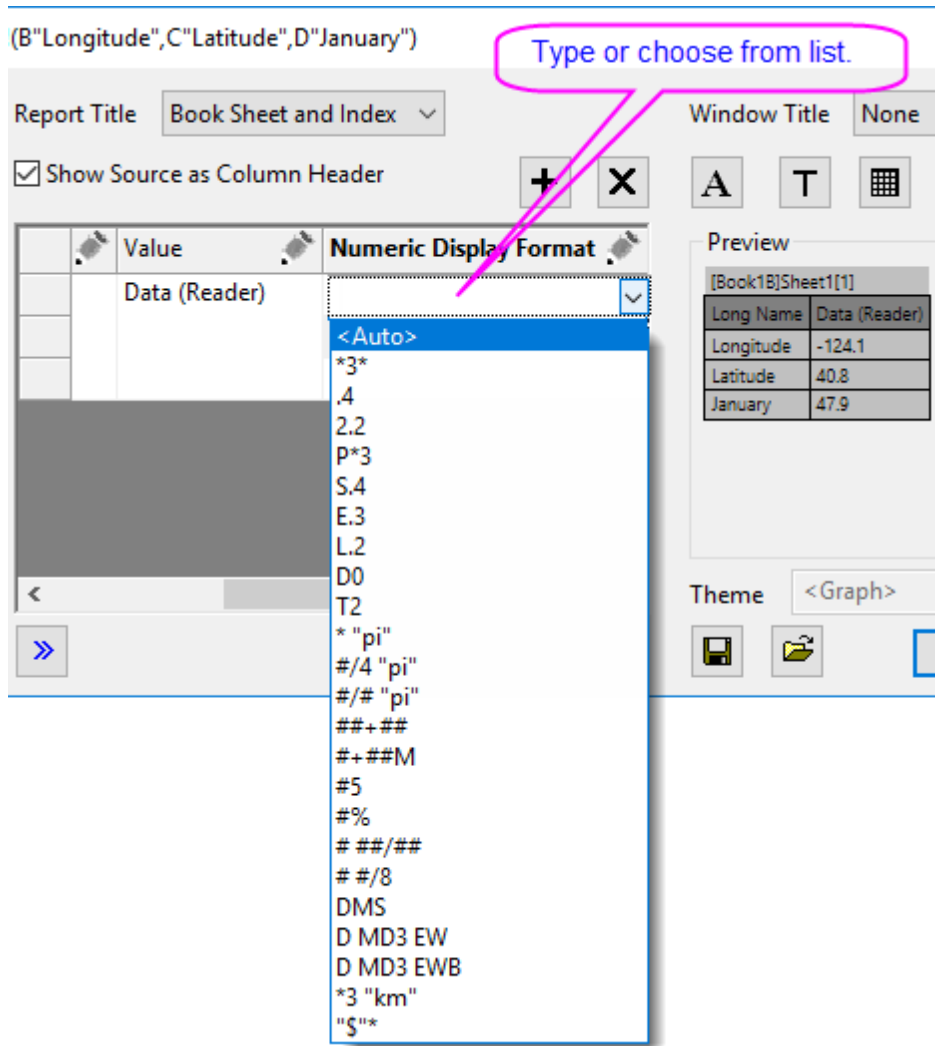

10.

11. In the first row list control, type the following (degrees-minutes east-west, with units before):

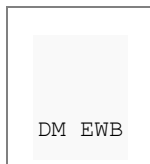

12. In the second row list control, type the following (degrees-minutes north-south, with units before):



13. In the third row list control, type the following (one decimal place + suffix string "deg F"):

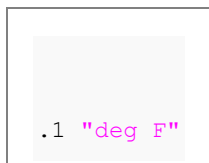

14. Click the **Add Column** button to add a column to the Data Info table, then click the pencil icon in the newly-added column to open the **Column Settings** dialog box. Set the **Type** drop-down list to **Single Cell**, Source to **A "City"**, **Column Width** to **30** and click **OK**.
15. Click the **Save Theme** button and choose *Save to <Graph>* to save the current Data Info window configuration to the graph window. Click **OK** to close the dialog box.

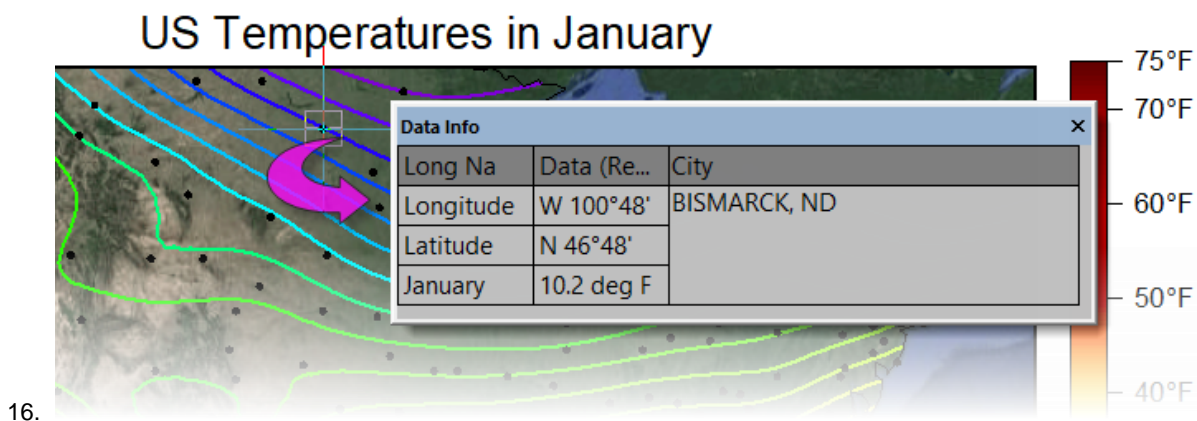

## 8.3 Use Data Cursor to Show the Difference between the Data

### 8.3.1 Summary

In Origin, the Cursor tool is used to measure the X and Y distance between two points. You can place cursor objects on the same curve or on different curves, then use the **Data Info** window to display the relative positions of the cursor objects.

Minimum Origin Version Required: Origin 2019

### 8.3.2 What you will learn

This tutorial will show you how to:

- Customize the **Data Info** window
- Read relative positions of two data points

### 8.3.3 Steps

1. Start with a new worksheet.
2. Select **File: Import: Multiple ASCII** from the main menu. Go to the folder `\Samples\Spectroscopy\Chromatography`, select *GPC Single Channel Chromatogram 1.dat* and *GPC Single Channel Chromatogram 3.dat*. Click **Add Files**, make sure that **Show Options Dialog** is

selected, and click **OK**. This opens the **ImpASC** dialog box. In this dialog, set the **Multi-File Import Mode** to **Start New Columns**, check the **Append Filename to Column Comment** check box and uncheck the **Include File Path when Appending Filename** check box in the **Re(Naming) Worksheet and Workbook** branch. Click **OK** to import these two files into a worksheet.

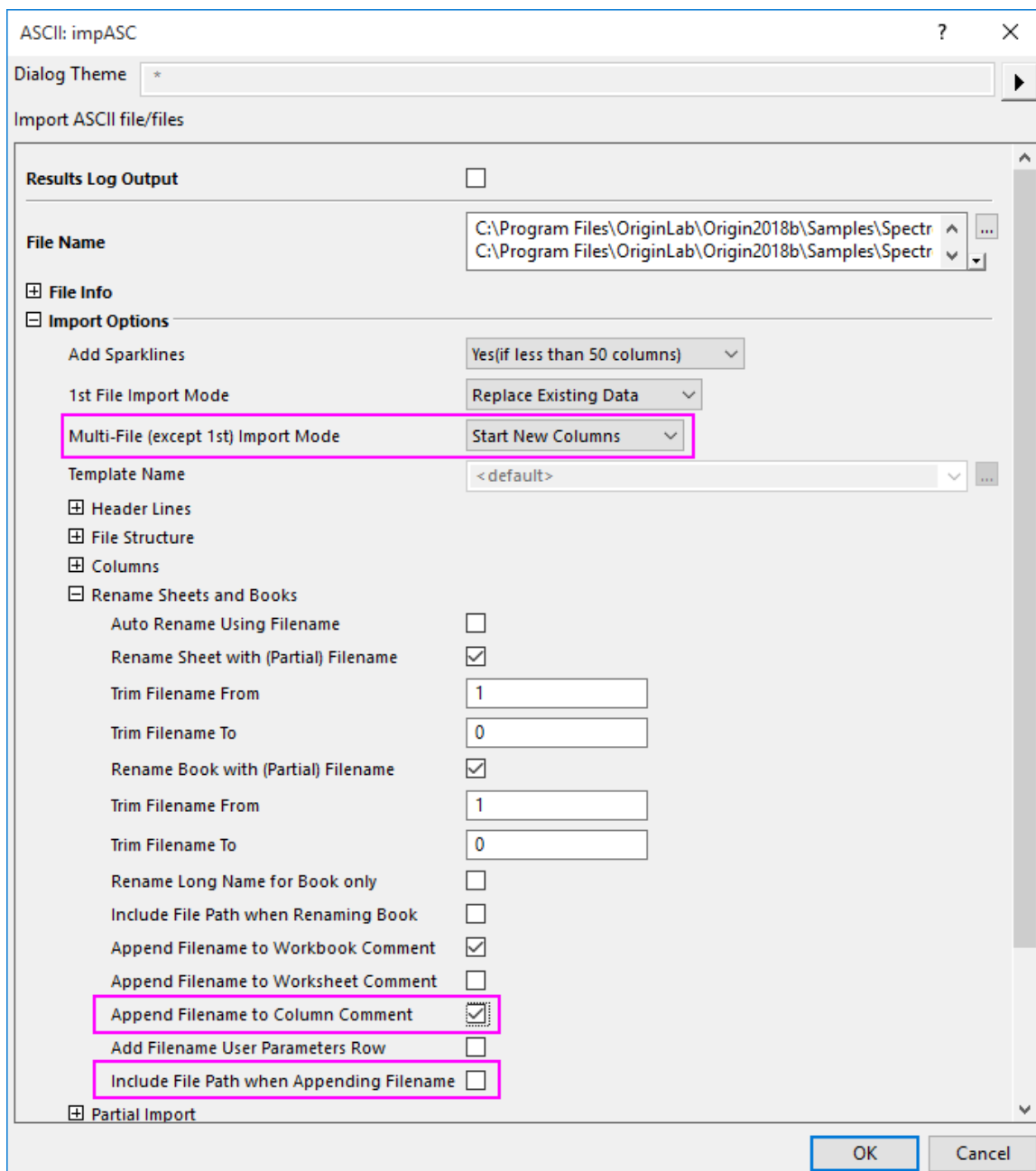

3. Highlight all columns and right-click to select **Set As: XY XY** from the context menu. With all columns highlighted, choose **Plot:Line:Line**.

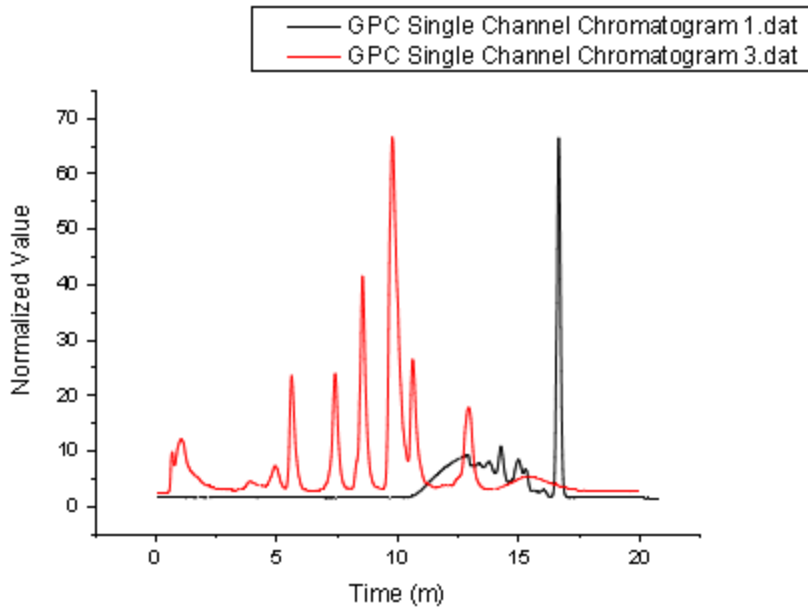

4. Press and hold the **Data Reader** button and select the **Data Cursor** from the list.

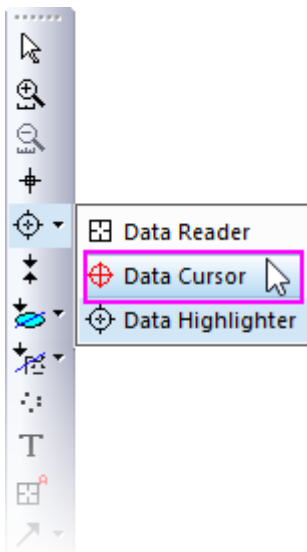



5. The **Data Info** window opens.

Data Info - [GPCSingleChan]"GPC Single Channel ...	
[GPCSingleChan]"GPC Single Channel C...	
Long Name	Data (Rea...
Time	0
Normalize...	1.5924

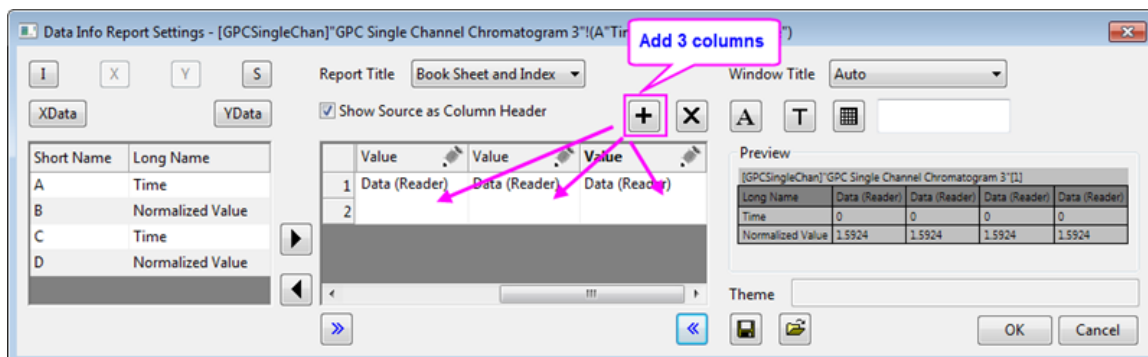
- Right-click on the **Data Info** window and select **Preferences...** from the shortcut menu. This opens the **Data Info Report Settings** dialog box.
- Click the **Add Column** button three times to add a total of three columns to the **Preview** table.



- Click the pencil icon  above the first added column and change **Source** to **Data (Cursor 1)** and set **Column Width = 30**. Click **OK**.
- Click the pencil icon  above the second added column and change **Source** to **Data (Cursor 2)** and set **Column Width = 30**. Click **OK**.
- Click the pencil icon  above the third added column and change **Source** to **Relative (Cursor 2 - Cursor 1)** and set **Column Width = 40**. Click **OK**.

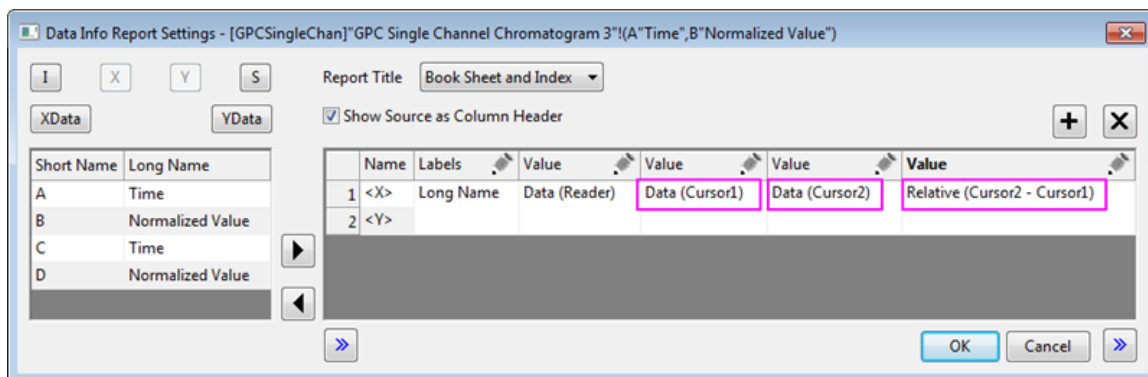

- Click **OK** to close this dialog. The Data Info window will display three new columns.

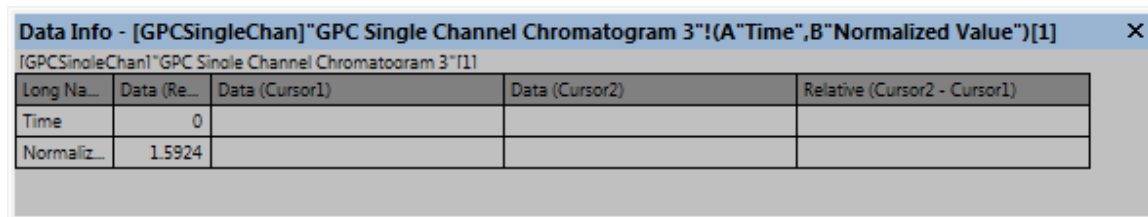

- Double-click on a data point in the graph to add the first cursor. Select the **Data Cursor** button again and add another cursor to the graph by double-clicking on the desired data point.

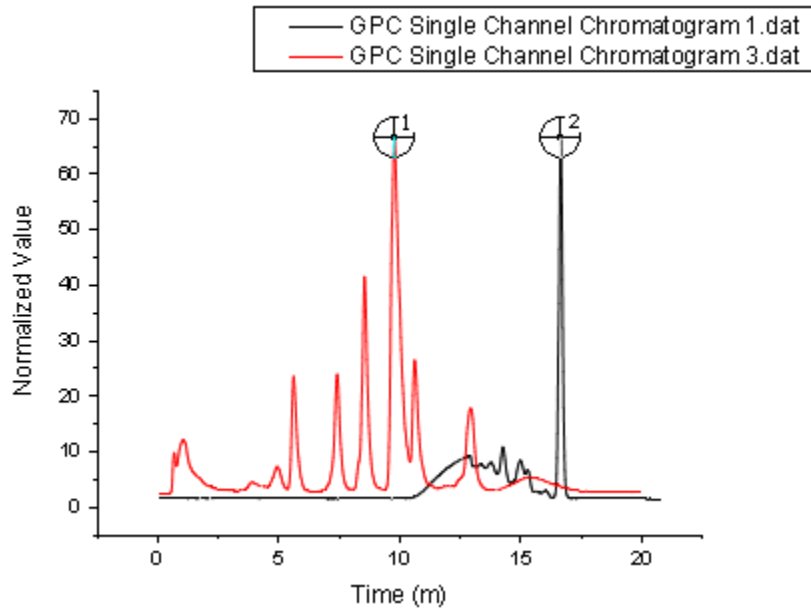

**Note:** After you add all the columns in the **Data Info Report Settings** dialog, you can save the settings as a Theme by clicking the **Save Theme** button  and choosing an option from the popup menu. Note that you can save settings to the graph (maximum portability) or to a named Theme file (and subsequently applied to any graph window).

12. The **Data Info** window will be updated with the values of the two points and their relative values.

Long Na...	Data (Re...	Data (Cursor1)	Data (Cursor2)	Relative (Cursor2 - Cursor1)
Time	16.65	9.7833	16.65	6.8667
Normaliz...	66.4181	66.54	66.4181	-0.1219

13. Right-click the **Data Info** window and select **Copy All** from the shortcut menu, then paste the table into a clean worksheet as shown below.

	A(X)	B(Y)	C(Y)	D(Y)	E(Y)
Long Name					
Units					
Comments					
	Long Name	Data (Reader)	Data (Cursor1)	Data (Cursor2)	Relative (Cursor2 - Cursor1)
F(x)=					
1	Time	16.65	9.7833	16.65	6.8667
2	Normalized Value	66.4181	66.54	66.4181	-0.1219
3					
4					

14.



You can promote any worksheet row to the column label rows (header) area by right-clicking on the row and choosing one of the **Set As...** or **Append To...** options.



## 9 Importing Data

### 9.1 Importing Data

#### 9.1.1 ASCII

- [Importing Data](#)
- [Single ASCII](#)
- [Import Wizard](#)
- [Import Time Data](#)
- [Post Processing with Import Filter](#)
- [Importing Multiple Files into Workbooks Cloned from Active Workbook](#)

#### 9.1.2 Database

- [Import Data from a Database](#)
- [Import Data from a Database for Analysis](#)
- [SQL Editor for Database Analysis](#)
- [Update Database Importing By LabTalk Substitution](#)
- [Update Graph By Reimport Data From Database](#)

#### 9.1.3 Digitizer

- [Digitizer Tool](#)
- [Enhanced Digitizer](#)

### 9.2 ASCII

#### 9.2.1 ASCII

- [Importing Data](#)
- [Single ASCII](#)
- [Import Wizard](#)
- [Import Time Data](#)
- [Post Processing with Import Filter](#)
- [Importing Multiple Files into Workbooks Cloned from Active Workbook](#)

## 9.2.2 Importing Data

### 9.2.2.1 Summary

Origin provides flexible ways of importing data including simply dragging and dropping data files, using the ASCII import dialog to customize settings, using the Import Wizard for advanced customization and for extracting variables from header lines, and supporting custom file formats for many third-party files. This tutorial will highlight some of these features.

**Note:** This tutorial requires you to drag-and-drop data files onto Origin, so [please make sure you are not running Origin as administrator.](#)

### 9.2.2.2 What you will learn

This tutorial will show you how to:

- Import files by drag-and-drop
- Import multiple ASCII files by customizing settings
- Saving settings for future use
- Import Wizard and import filters

### 9.2.2.3 Drag and Drop Importing of ASCII Files

1. Start with an empty worksheet. Open Windows Explorer to the **\Samples\Curve Fitting** subfolder of your Origin installation folder. Drag and drop the file **sensor01.dat** from the Windows Explorer window into the empty Origin worksheet.

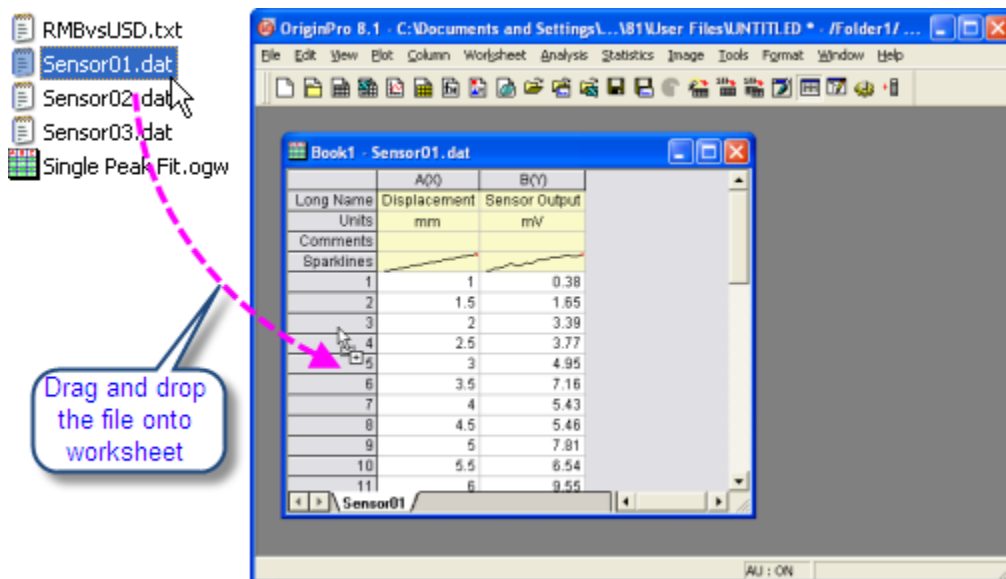

2. Data comes into the sheet. Now select two files: **sensor02.dat** and **sensor03.dat** and drop into the same worksheet. You will see that the first file replaces the data already in the worksheet, and the others create new workbooks, as the default setting is to create new books for the 2nd file.



The default setting when dragging and dropping is to replace existing data. If you have some other data already in the sheet, you can drop the file onto the gray area outside of any window, or into a graph window, and Origin will create a new book and import the data.

#### 9.2.2.4 Customizing ASCII Import Dialog Settings and Saving a Theme

ASCII import and custom-file-format import both provide an *options* dialog where a user can customize import settings and then save settings for later use on similar files.

1. Start with a new book and click the **Import Multiple ASCII** button  on standard toolbar.
2. Select the files **sensor01.dat**, **sensor02.dat** from **\Samples\Curve Fitting** and add to lower panel of the file dialog. Click the file name column header in lower panel to sort the files by name. Keep the **Show Options Dialog** box checked and click **OK**. This will open a dialog for import settings.

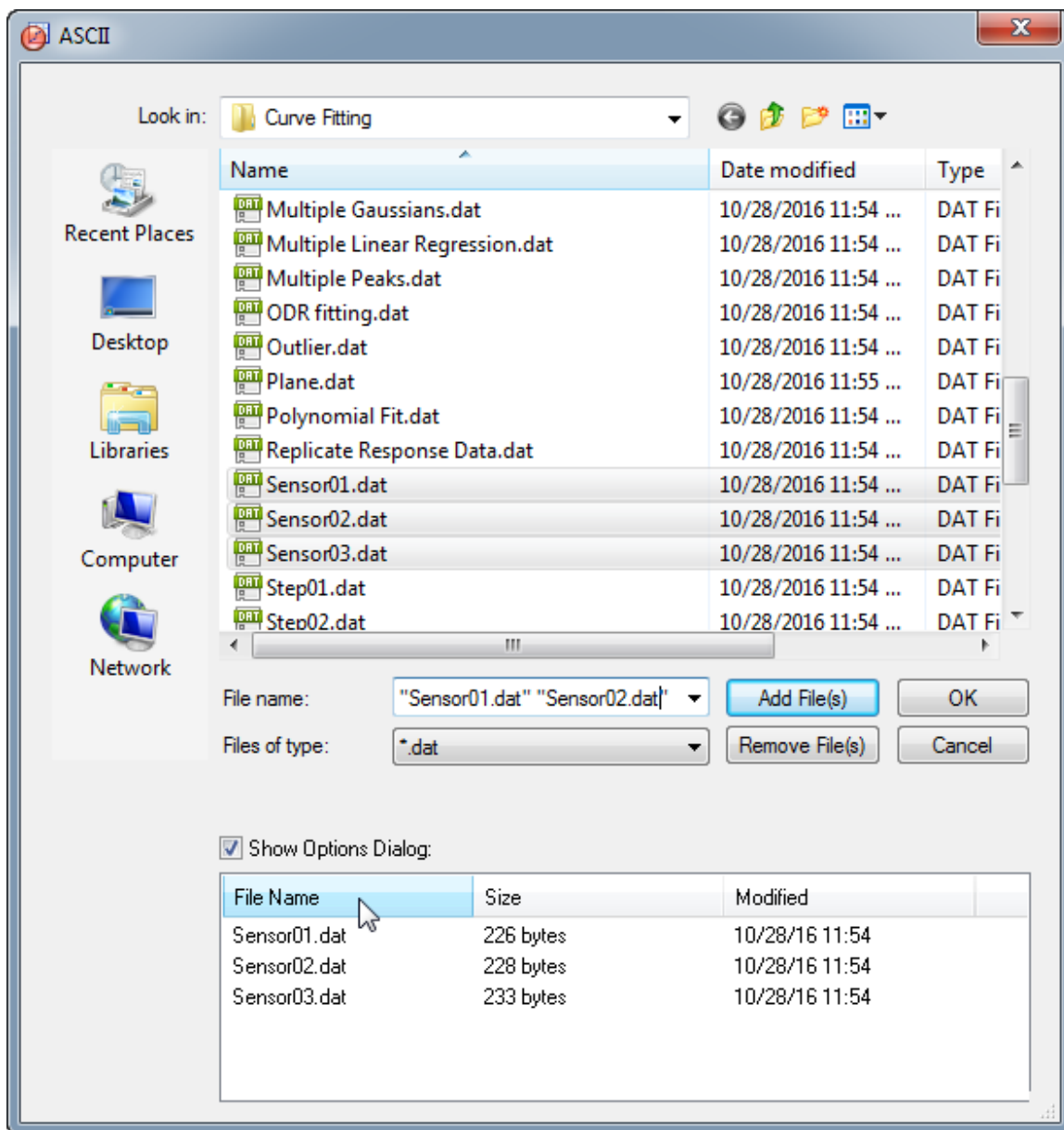

3. Change import mode to **Start New Sheets**. Expand **(Re)Naming Worksheet and Workbook** node and change settings so that only sheet gets renamed.

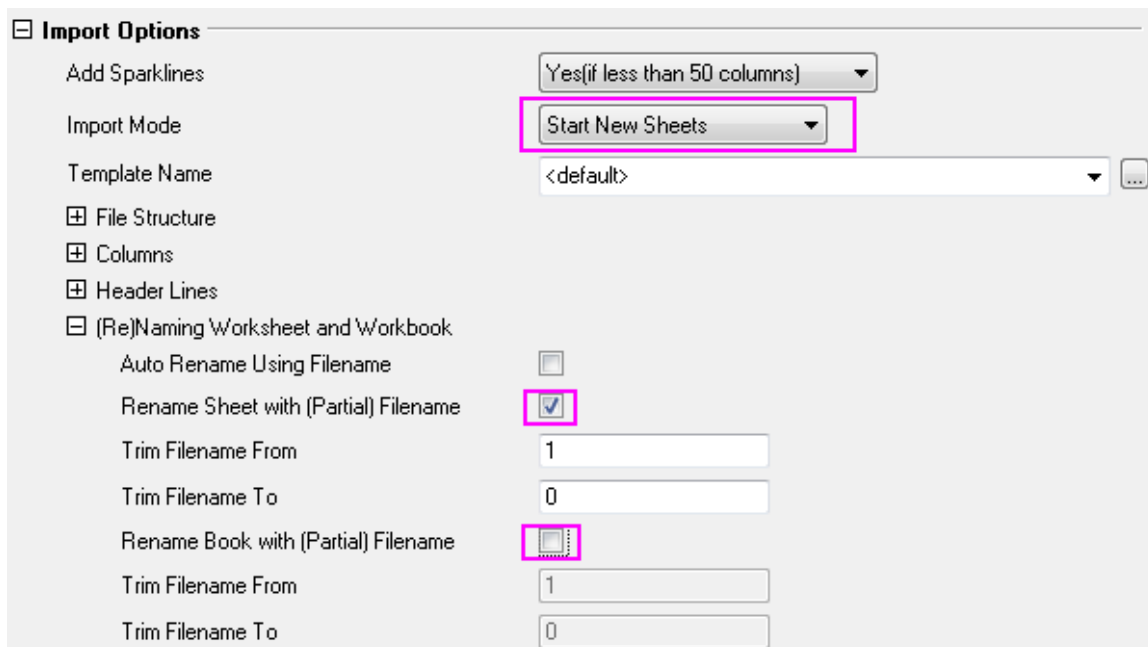

- Click on right arrow button at the top of the dialog and select **Save As**, then give it a name such as **My Multifile Import** and click **OK**. This saves your settings to a theme file on disk.

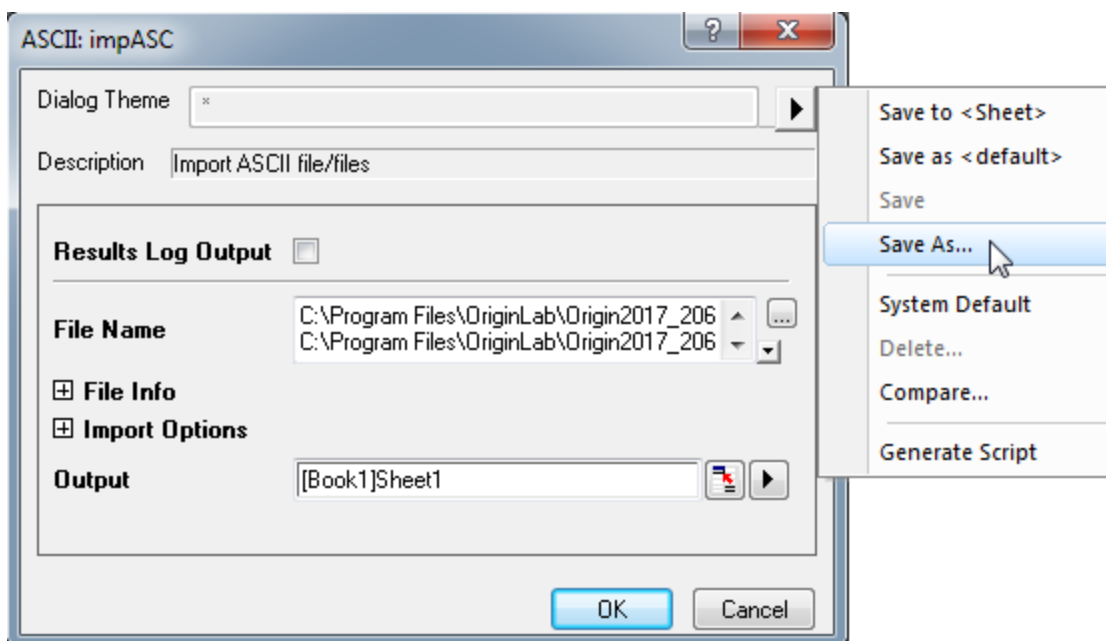

- Click **OK** and the 1st file gets imported into the current sheet, and a new sheet is created for the 2nd file. File names are used as sheet names.

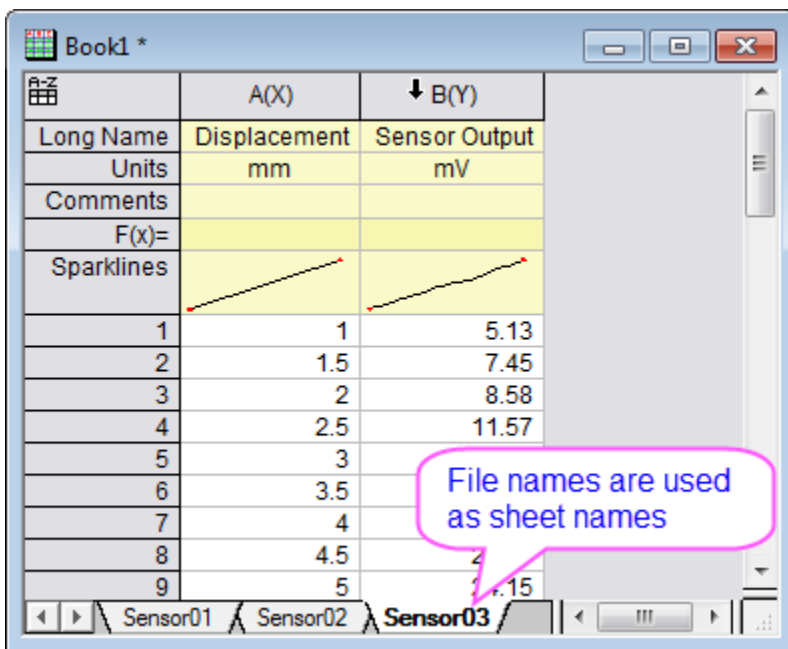

- Now start a new book and invoke the menu **Data: <Recent used items> impASC: My Multifile Import**. In the file dialog pick the three files: **step01.dat**, **step02.dat**, **step03.dat** from **\Samples\Curve Fitting**. Click the file name column header in lower panel to sort the files by name. Click **OK**. The settings from the theme you saved and selected here are used to perform the importing.



When doing serial import of files to new sheets (**Start New Sheets**), note that the workbook can contain a maximum of 255 sheets (prior to Origin 2018) or 1024 sheets (Origin 2018 and later). When the maximum number of sheets is reached, a new book is created.

### 9.2.2.5 Saving ASCII Import Settings to Worksheet

Custom ASCII import settings is by default saved into the worksheet itself. It can also be saved as a theme file to disk. Please note that settings saved in this way can only be reused when import with the **impASC** dialog. If you want to use the settings when drag-n-drop to import a data file, you will need to use **Save Settings for Drag and Drop** menu.

- Start with new book and invoke **Data: Import from File: Single ASCII** from menu, and select the file **sensor01.dat** from **\Samples\Curve Fitting** subfolder, and keep the **Show Options Dialog** checked and click **OK**.
- In the **impASC** dialog, unfold Import Options branch, select **No** with the **Add Sparklines** drop-down list. Expand **(Re)Naming Worksheet and Workbook** node and change settings so that only sheet gets renamed by file name, not book.
- Click on Top Arrow icon and select **Save Settings for Drag and Drop** and click **OK**. Then your custom settings get saved to the sheet and data is imported.
- Select **File: Save Template As** from the main menu. Enter **SensorImport** as the template name. Click **OK** to save the workbook template. This template contains both the import settings and the worksheet properties settings.

- Now we create a new workbook from this template. Click the **Open Template** button on the **Standard** toolbar. Select SensorImport.otw under your User Files Folder and then click **Open**. A workbook is created from the template.
- With this book active, drag and drop the file **sensor02.dat**. The data gets imported and only sheet name changes to the new file name. The sparklines were not turned on.



When saving custom settings to a worksheet, it is useful to then save the sheet, along with other desired analysis operations, as an **Analysis Template** for repeat analysis of similar data from multiple files. See the Batch Processing tutorial for details.

#### 9.2.2.6 Import Wizard and Import Filters

The Import Wizard allows you to step through your data file, customize settings including how to parse header lines to create variables, and then save all of your custom settings as an import filter (.OIF) file for repeat use. The filter file can reside in the data folder, in the **\Filters** sub folder of your **User Files Folder**, or even saved to the worksheet itself for use with **Analysis Templates**. The Wizard is typically useful when the file has header lines that need to be parsed, or the file needs custom settings such as fixed width, or for executing LabTalk script at the end of the import for post processing.

- Start with a new book. Click on the Import Wizard button  in the Standard toolbar to launch the wizard.
- Select the file **\Samples\Import and Export\S15-125-03.dat**.
- Note that the **Import Filter for Current Data Type** drop-down changes to show **Data Folder: VarsFromFileNameAndHeader**, this is a filter already created for this file and shipped with Origin, and is automatically picked up from the same folder as the data file you chose. Then change **Import Mode** to **Replace Existing Data**.

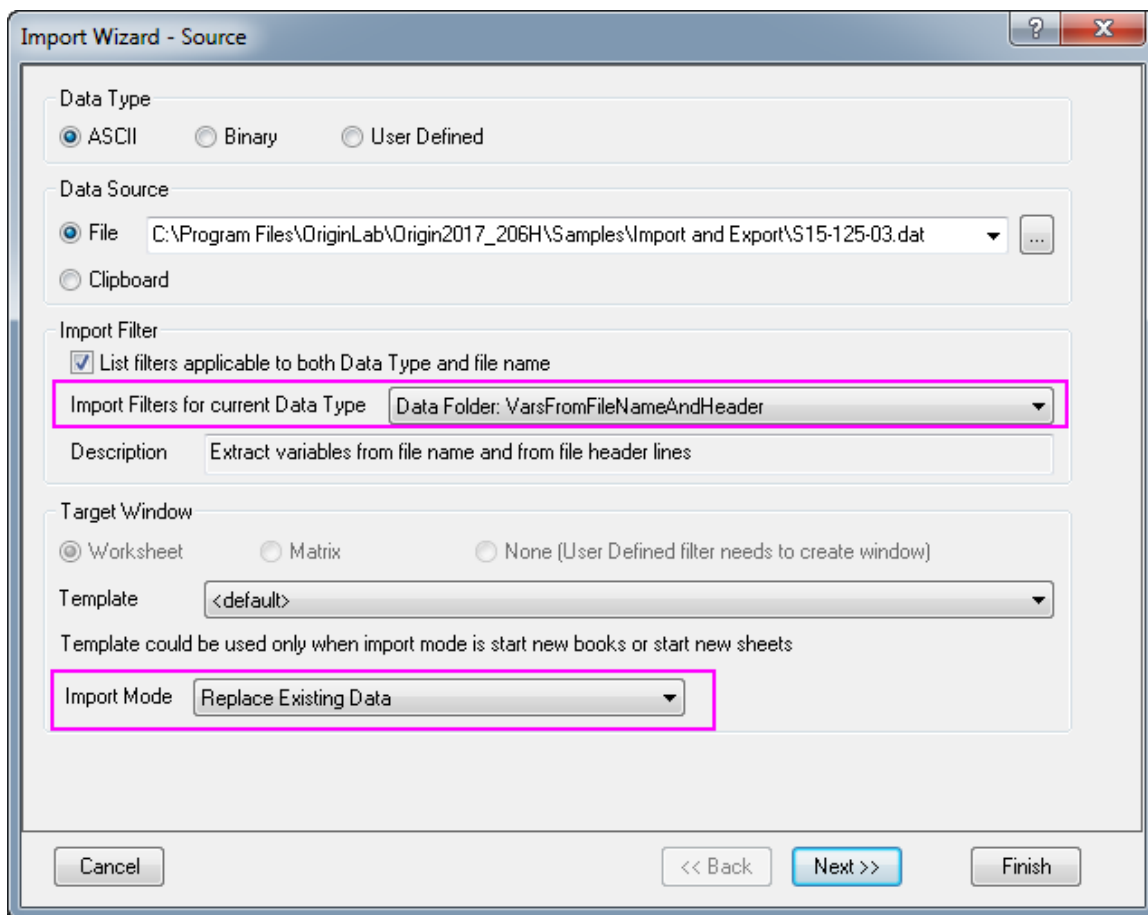

4. Click **Next** and walk through the pages. Notice controls on **Header Lines** pages that allows flexible definition of where the header lines end, where the sub header lines are located, and what gets assigned to long name and units etc.
5. For this file the **Variables Extraction** and **Variables Extraction by Delimiter** page define how to parse the header lines to extract values from them.
6. Click **Next** until you get to the **Save Filters** page. Check the **Save filter** box and change the radio button to **In the Window**. This will save the filter in the active worksheet.



Import Wizard settings can be saved to a filter file for re-use. Filter files can be selected on the first page of this wizard.

Once saved, import filters can also be used to automatically determine import settings when dragging and dropping data files into Origin and when opening data files with the File:Open menu item.

Save filter

In the data file folder C:\Program Files\OriginLab\Origin2017\_206H\Samples\Import and Export\

In the User Files folder C:\Users\shirley.OLABGZ\Documents\OriginLab\2017\UserFiles\_206H\Filters\

In the Window

Show Filter in File:Open List

Filter Description Extract variables from file name and from file header lines

Filter file name (.DIF extension will be appended) VarsFromFileNameAndHeader

Specify data file names to which this filter will be associated. You can use wild cards, and can specify multiple names separated by '|'  
S\*.\*.dat  
Ex: \*.txt or \*.txt; \*.dat; mydata????.\*

Specify advanced filter options

Cancel << Back Next >> Finish

7. Now check the **Specify advanced filter options**. It brings you to a last page where script (to run at the end of the import) can be specified. In **Script after Each File Imported** edit box enter:

```
col(E)=col(2)-273.15;

col(E)[u]$(\+(0)C);

col(E)[1]$(Delta Temperature;
```

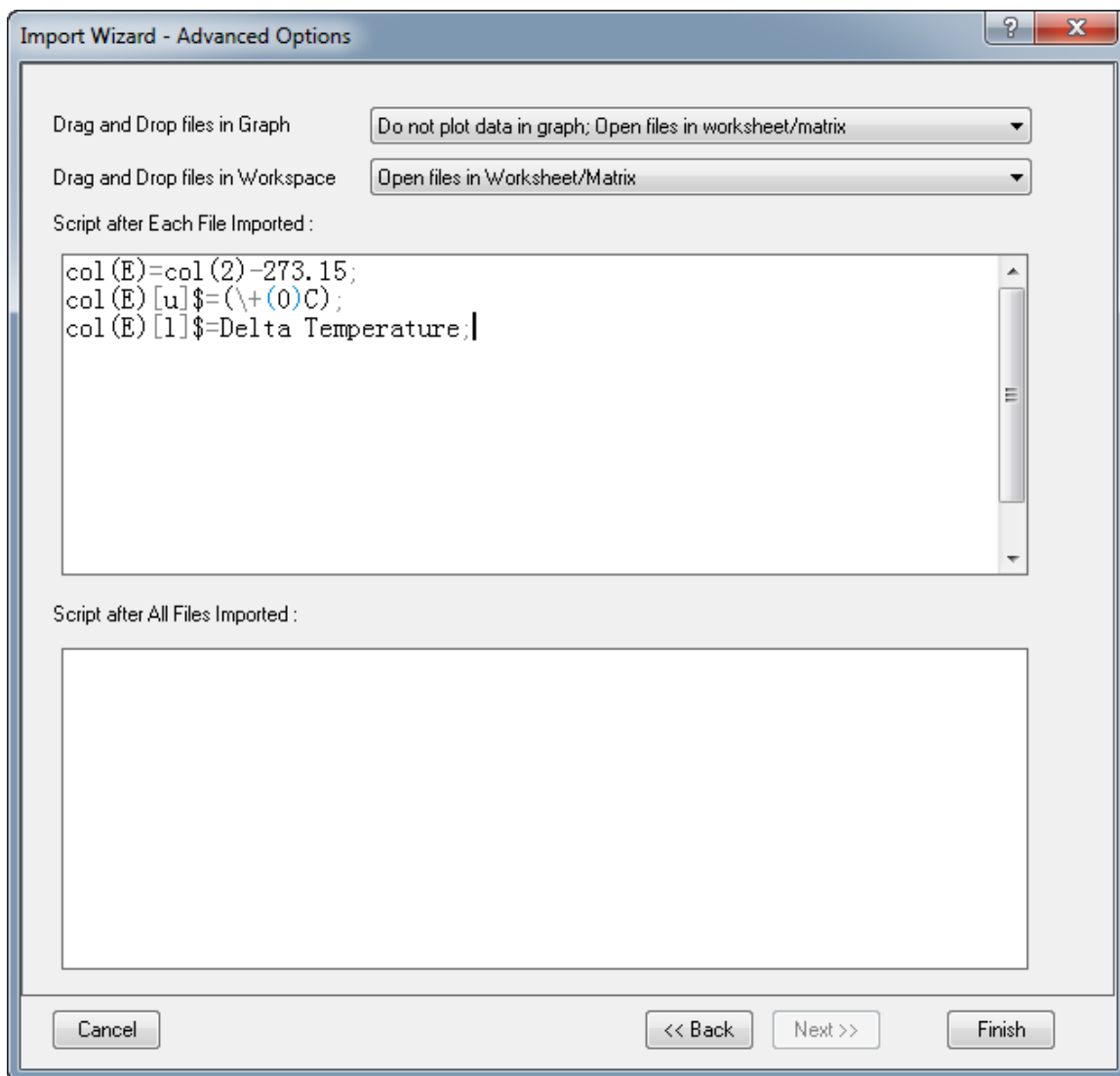

8. Click **Finish**, the file gets imported and the import filter is now saved in your worksheet. The fifth column is a column added by the script. It is the Delta Temperature data in Degree Celsius.
9. With the worksheet active, click **Import Wizard** button again and pick file `\S21-235-07.dat`. Note that the **Import Filter for Current Data Type** drop-down shows *<use filter in active window>*, so Origin picks up the filter settings that were saved in the worksheet.

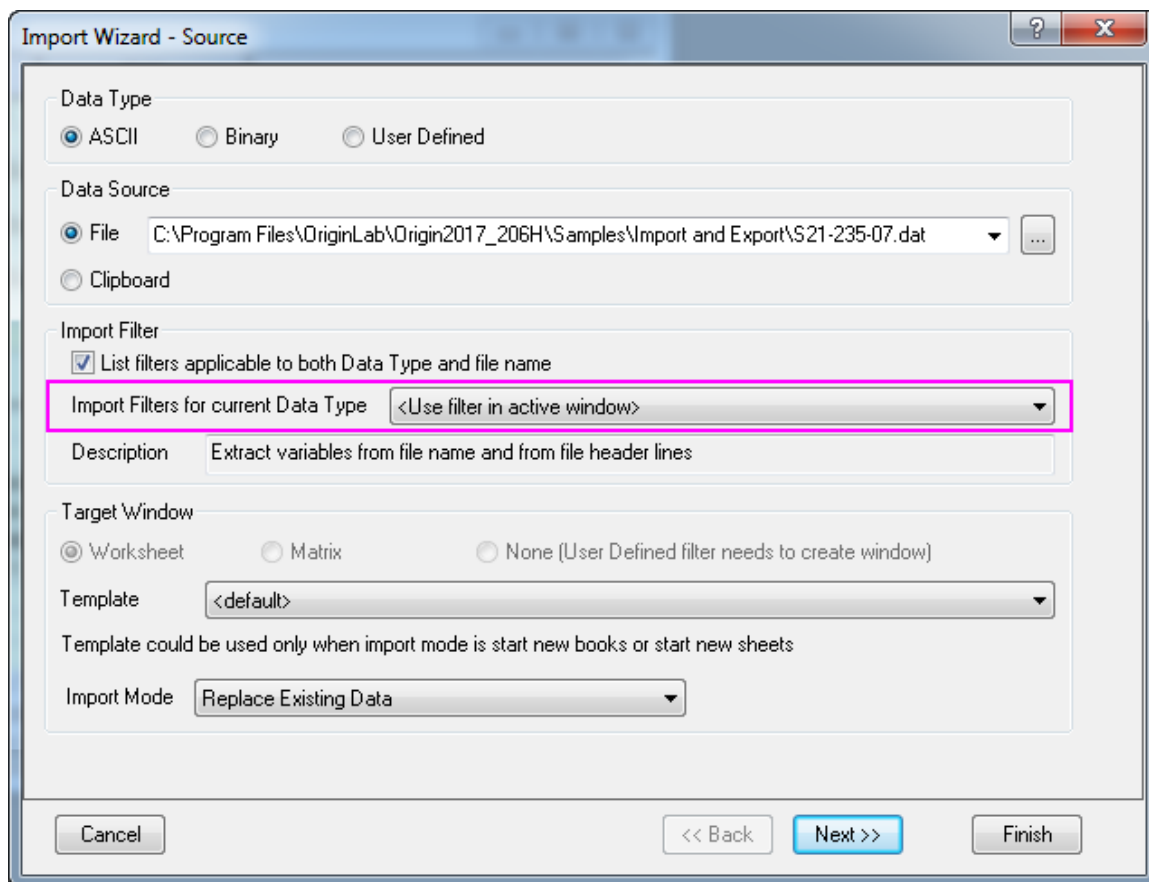

10. Click **Finish** and the file gets imported and the script gets executed (the values in column 5 is updated).



You can save the import settings to the worksheet, perform analysis on the imported data, and save the workbook as an **analysis template** for repeat processing of similar data files. See the tutorial on batch processing for more information.

## 9.2.3 Single ASCII

### 9.2.3.1 Summary

The **Data: Import from File: Single ASCII** menu allows you to automatically import a single ASCII file where the data columns are delimited orderly and it consists of few header lines (maybe just a short description for the file and then names and units for the columns).

Minimum Origin Version Required: Origin 8.0 SR6

### 9.2.3.2 What you will learn

This tutorial will show you how to Import ASCII files.

### 9.2.3.3 Steps

Using Windows Explorer, browse to the `\Samples\Import and Export` subfolder of the Origin program folder (by default installed in the Program Files folder). Open the file `S15-125-03.dat` in Windows Notepad. You can see that this file includes header lines and data lines. For Single ASCII files, Origin can auto detect file header/subheader and extract this information to the worksheet headers, such as *Long Name*, *Units*, etc.

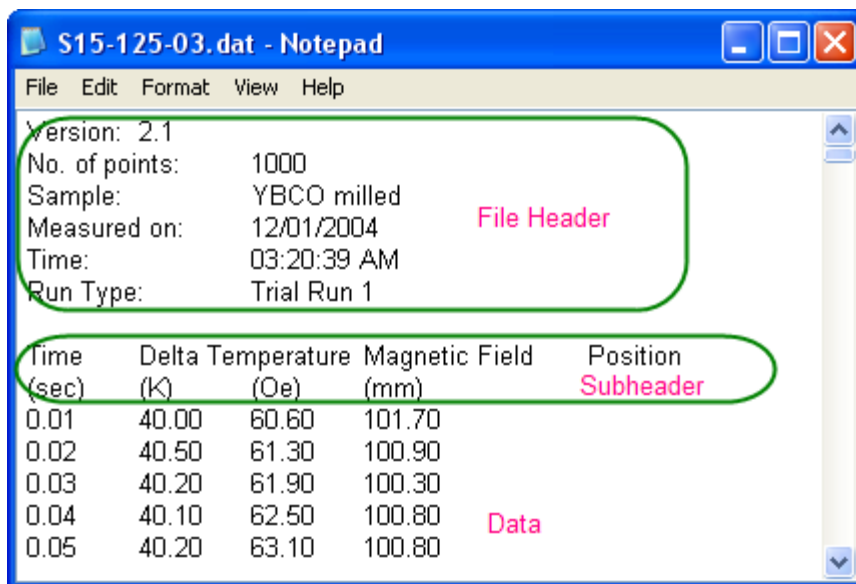

**Note:** Header lines are lines of text that are not part of the data and do not share the same delimiter formatting as the data. Subheader lines also are not part of the data, but share the same delimiter formatting and therefore correspond to particular columns of data.

To Import this file

1. Select **Data: Import from File: Single ASCII** from the menu to open the File Import dialog. Browse to the `\Samples\Import and Export` subfolder of the Origin program folder. Highlight the file `S15-125-03.dat`.
2. If you double-click this file or click the **Open** button, Origin will import the file automatically. To view the settings for how Origin will import the file, check the **Show Options Dialog** checkbox at the bottom of the dialog and then click **Open**. This will bring up the *impASC* X-Function dialog.

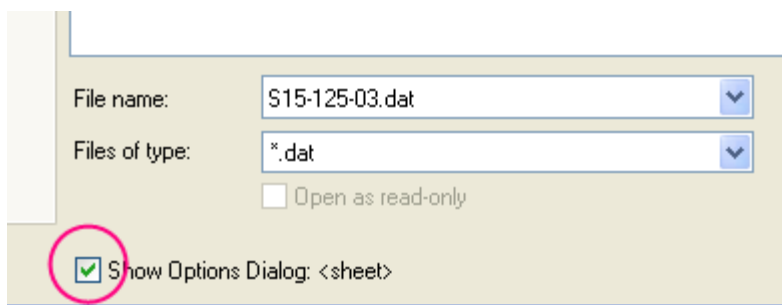

3. Expand the **Import Options: Header Lines** tree node.

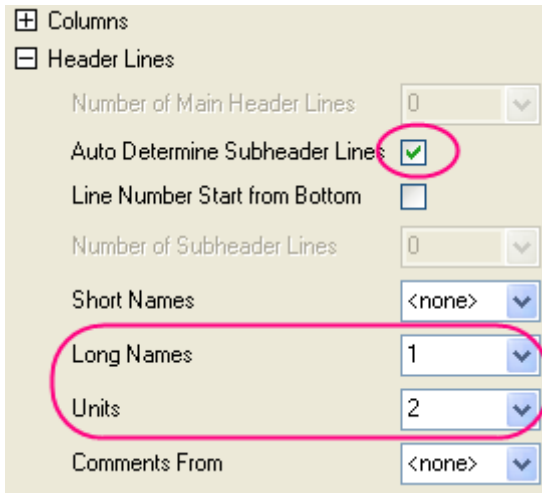

By default, Origin auto detects the subheader, and data will be imported from subheader. In this example, Origin automatically set the first line,

Time Delta Temperature Magnetic Field Position  
 as the worksheet column Long Name and the second line,  
 (sec) (K) (Oe) (mm)  
 as Units.

4. Click **OK** to accept these settings and import data into worksheet.

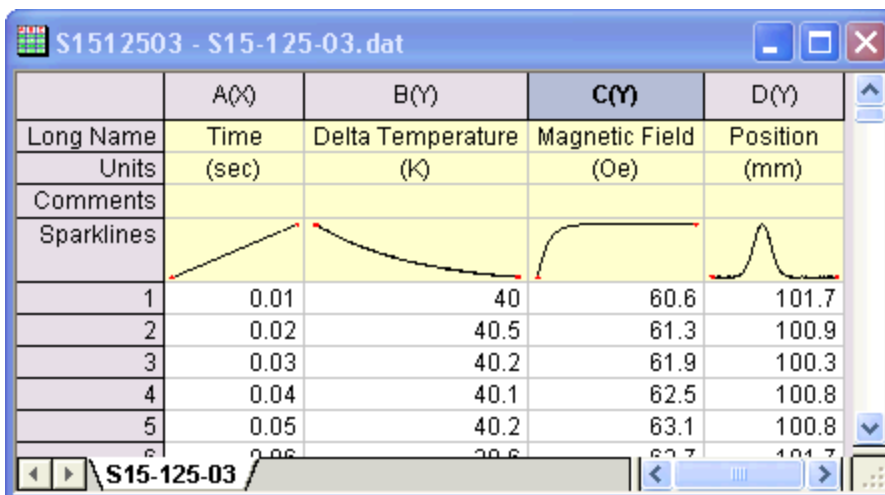

## 9.2.4 Import Wizard

### 9.2.4.1 Summary

The **Import Wizard** allows you to preview your ASCII file. This is especially helpful when you are importing a file with many lines of header, and want to extract variables from both the file name and file headers for use in annotating a graph.

Minimum Origin Version Required: Origin 8.0 SR6

#### 9.2.4.2 What you will learn

This tutorial will show you how to use the **Import Wizard**.

#### 9.2.4.3 Steps

The **Import Wizard** allows you to import complicated ASCII files, extract variables from the import file name and header (for reuse in Origin), specify custom delimiters and date formats, or handle post-processing of your imported data using a custom LabTalk script. Another chief advantage of using the Wizard to import your data files is that you can save your custom settings to a filter that can be used repeatedly to import the same or similarly-structured files.

1. Create a new workbook. Click **File**, point to **Import**, and then click **Import Wizard** to open the *Import Wizard* dialog. Click the browser button  to the right of the **File** box. Browse to the \Samples\Import and Export folder and open the file *F1.dat*. Click **Next** to navigate to **Header Lines** page.
2. This page enables you to easily customize the worksheet headers. For example, to specify the worksheet long name, clear **Auto determine header lines** check box, place your cursor on the relevant line in the lower panel, and then click the button next to *Long Names*.

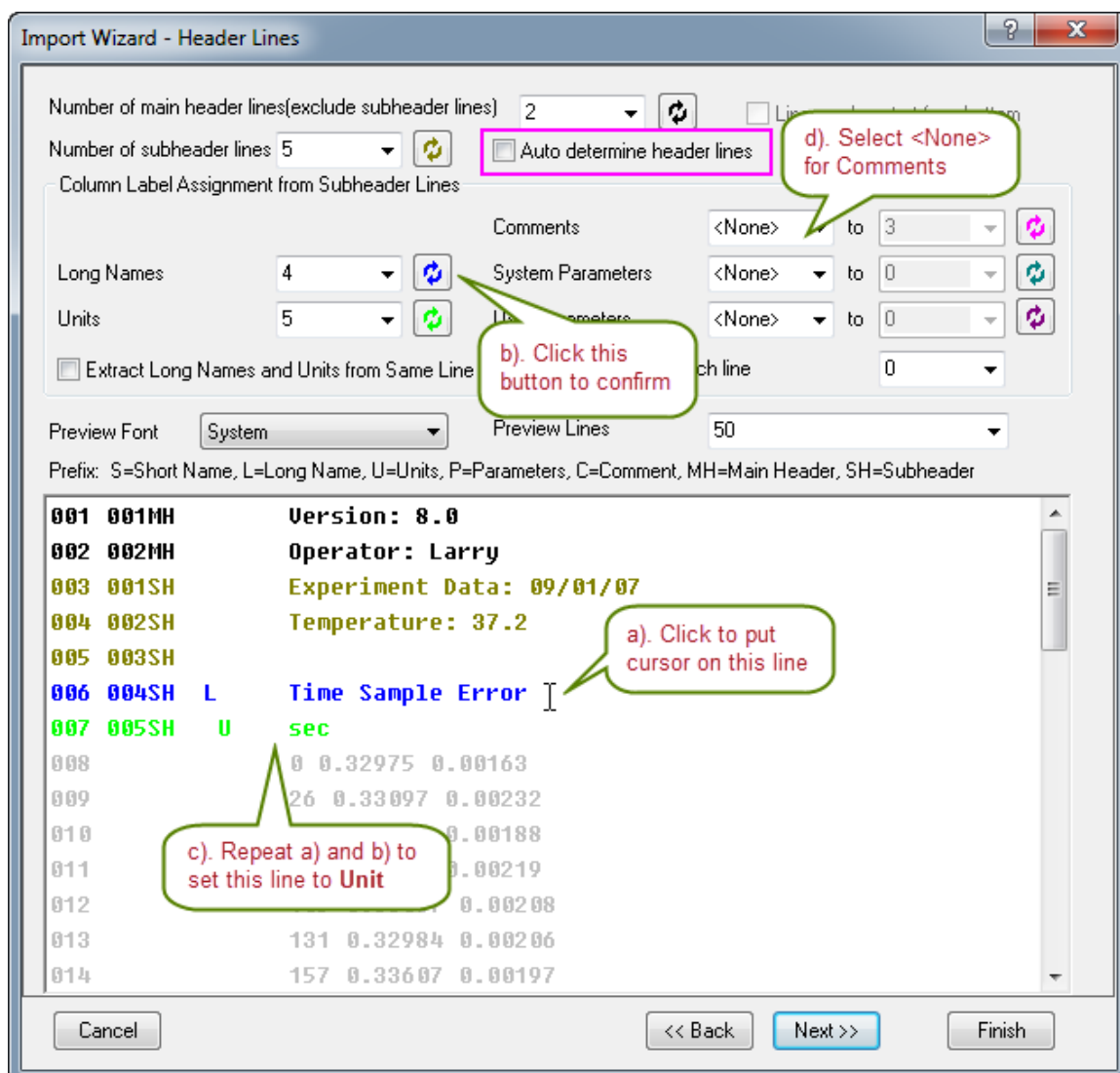

Similarly, specify the *Unit* line and select *<None>* for *Comments*.

3. Click **Next** to navigate to **File Name Options** page. Make sure the **worksheet with file name** box is checked to rename worksheet by imported file name.

- Click **Next** to go to the **Data Columns** page. Select **(XYE)** from the *Column Designations* drop-down menu and click **Apply**.

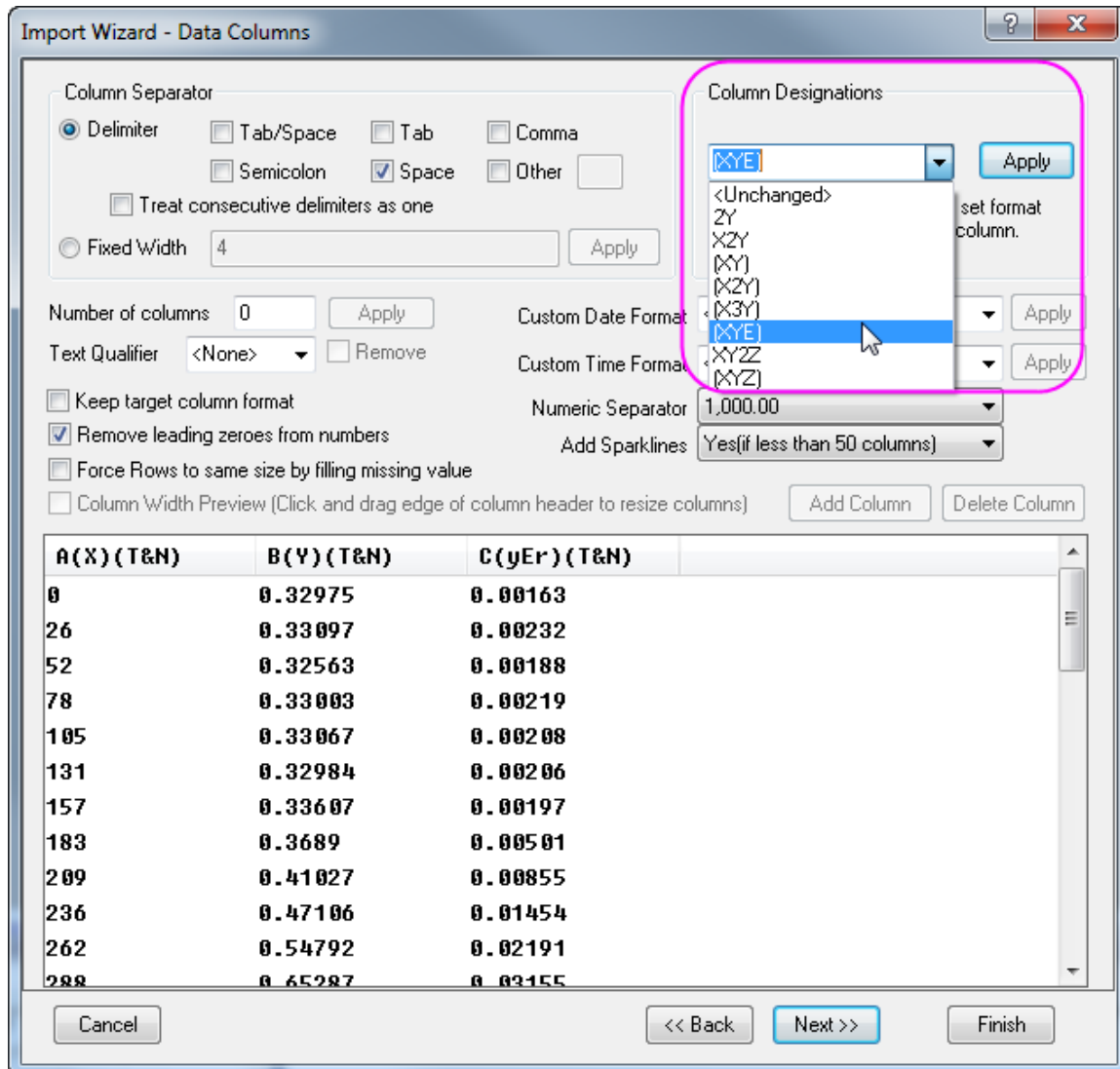

- Click **Next** twice to go to the **Save Filters** page. To use these settings again, you can save this import procedure as a filter. Select the **Save filter** check box and type a filter name in the **Filter file name** text box (*MyFilter* in this example).



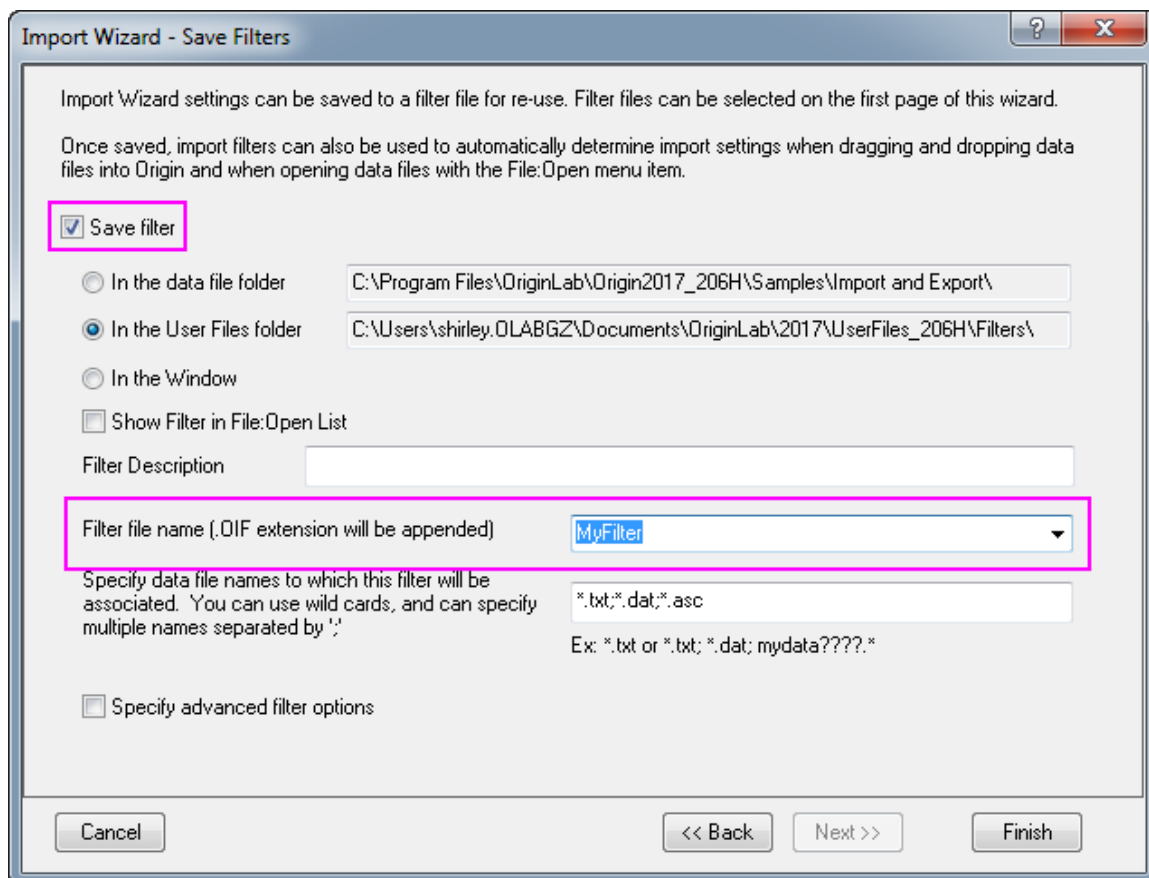

Click **Finish** to import the data.

- Open Windows Explorer and browse to *<Origin installation folder>\Samples\Import and Export\*. Locate the file *F2.dat*, drag and drop it to Origin workspace. The Select Filter dialog will open asking you to select a filter.

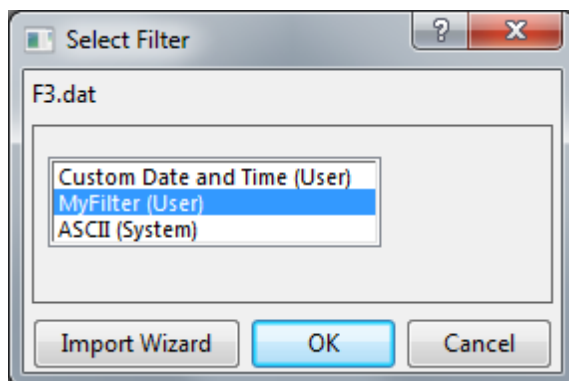

Select *MyFilter* filter just saved. It will be used to import the file.

## 9.2.5 Import Time Data

### 9.2.5.1 Summary

Origin interprets *Dates* based upon the Gregorian Calendar, while *Time* is interpreted in *hours:minutes:seconds*. When working with [Date and Time data](#), Origin displays these data in different formats, but internally uses underlying numeric values for calculations and certainly plotting operations. This tutorial shows you how to import custom date/time data.

Minimum Origin Version Required: Origin 8.0 SR3

### 9.2.5.2 What you will learn

This tutorial covers:

- How to import data using multiple delimiters.
- How to define a custom date/time format
- How to change the display settings for the custom date/time format
- How to save import settings in a filter for reuse

### 9.2.5.3 Steps

1. We will import `\Samples\Import and Export\Custom Date and Time.dat` in this tutorial. Before importing the file, let's look at the data structure first.

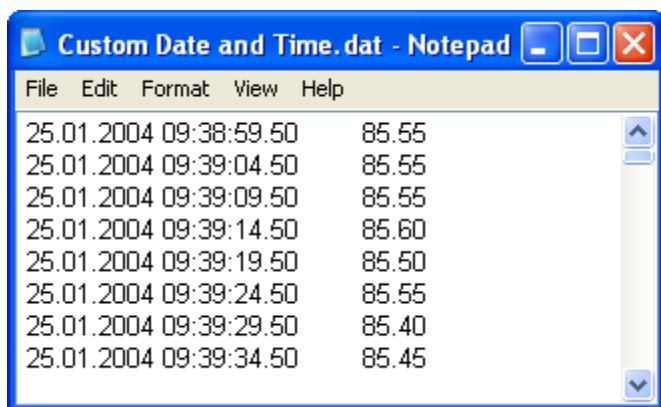

We can see that there is a space between *Date* and *Time*, and it uses Tab to separate *Time* from the rest of the data. So we will use multiple delimiters to import this data file.

2. Open the file in **Import Wizard**. Accept the default settings on all pages until you get to the **Data Columns** page. Origin will, by default, use Tab to separate the data into two columns. To divide *Date* and *Time*, check the **Tab/Space** checkbox in the **Column Separator** group.

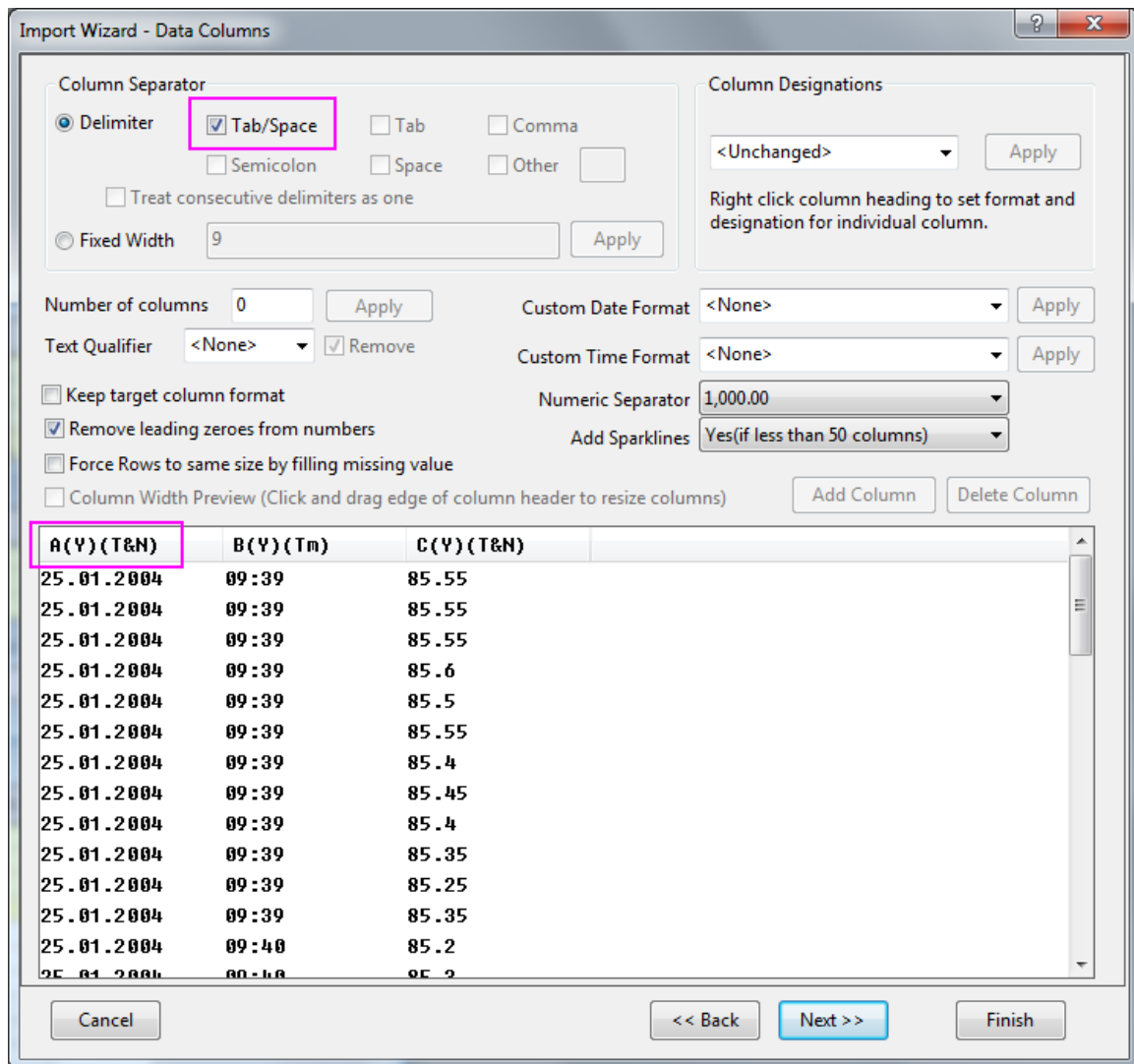

Note in the preview box that the column title is **A(Y)(T&N)**, where **(T&N)** means the data format is *Text & Numeric*. Because the date uses "." to separate day, month and year, Origin by default treats the first column as *Text*. For the second *Time* column, Origin shows the underlying numeric values. To import data correctly, we should change the column properties.

3. In the **Custom Date Format** edit box, enter:

```
dd'.'MM'.'yyyy
```

where *dd*, *MM* and *yyyy* mean the days, months, and year respectively. Since the "." is used as a separator, we need to put single quotation marks around it in the format specification. After entering the custom format, press the **Apply** button next to the edit box. Then right-click on the header of the first column in the preview and select *Date* from the context menu:

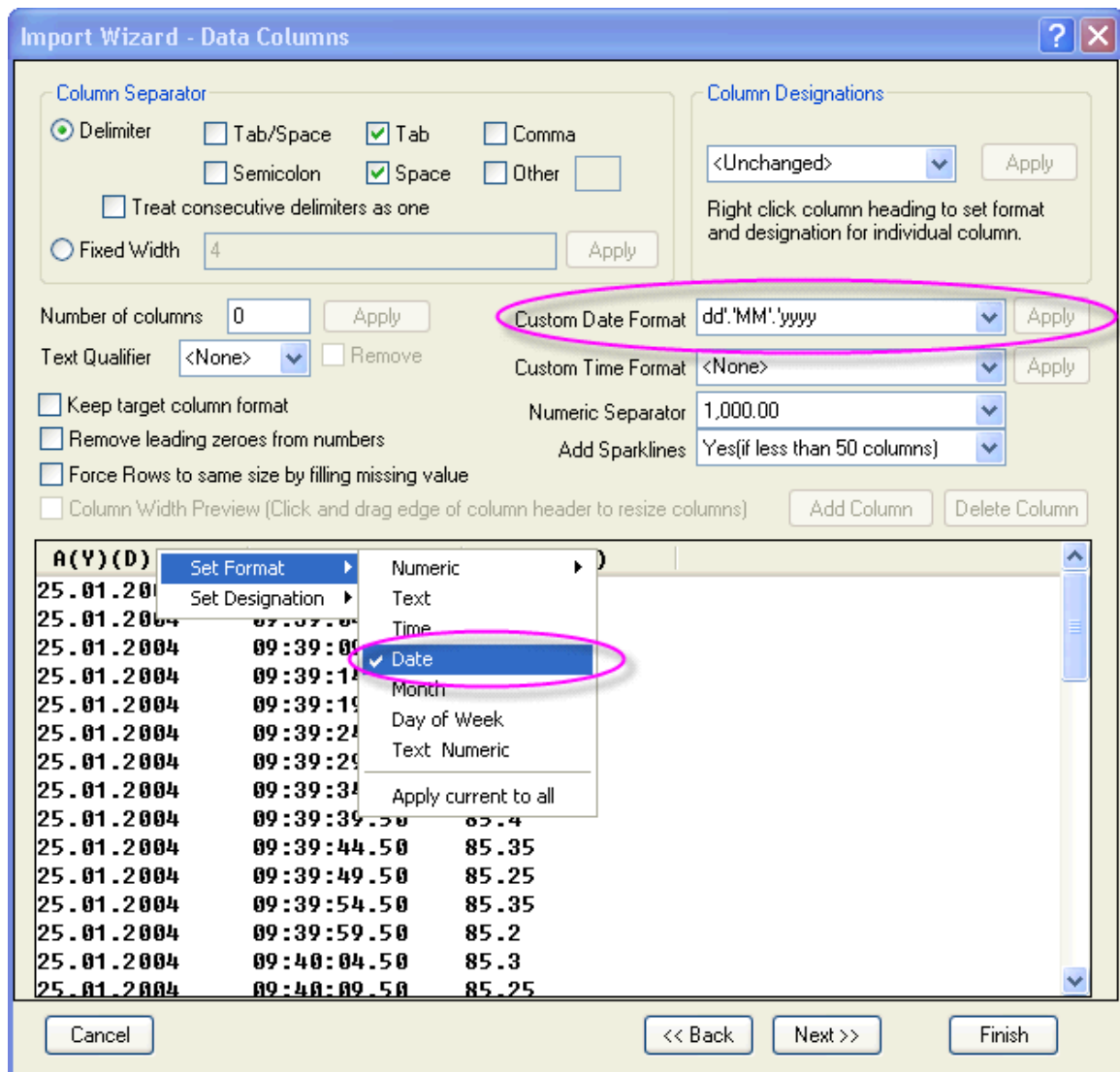

Then the column title will turn into **A(Y)(D)** which means this is now a *Date* data column.

- Similarly, right-click on the header of the second column and select *Time* to set that column as a time column:

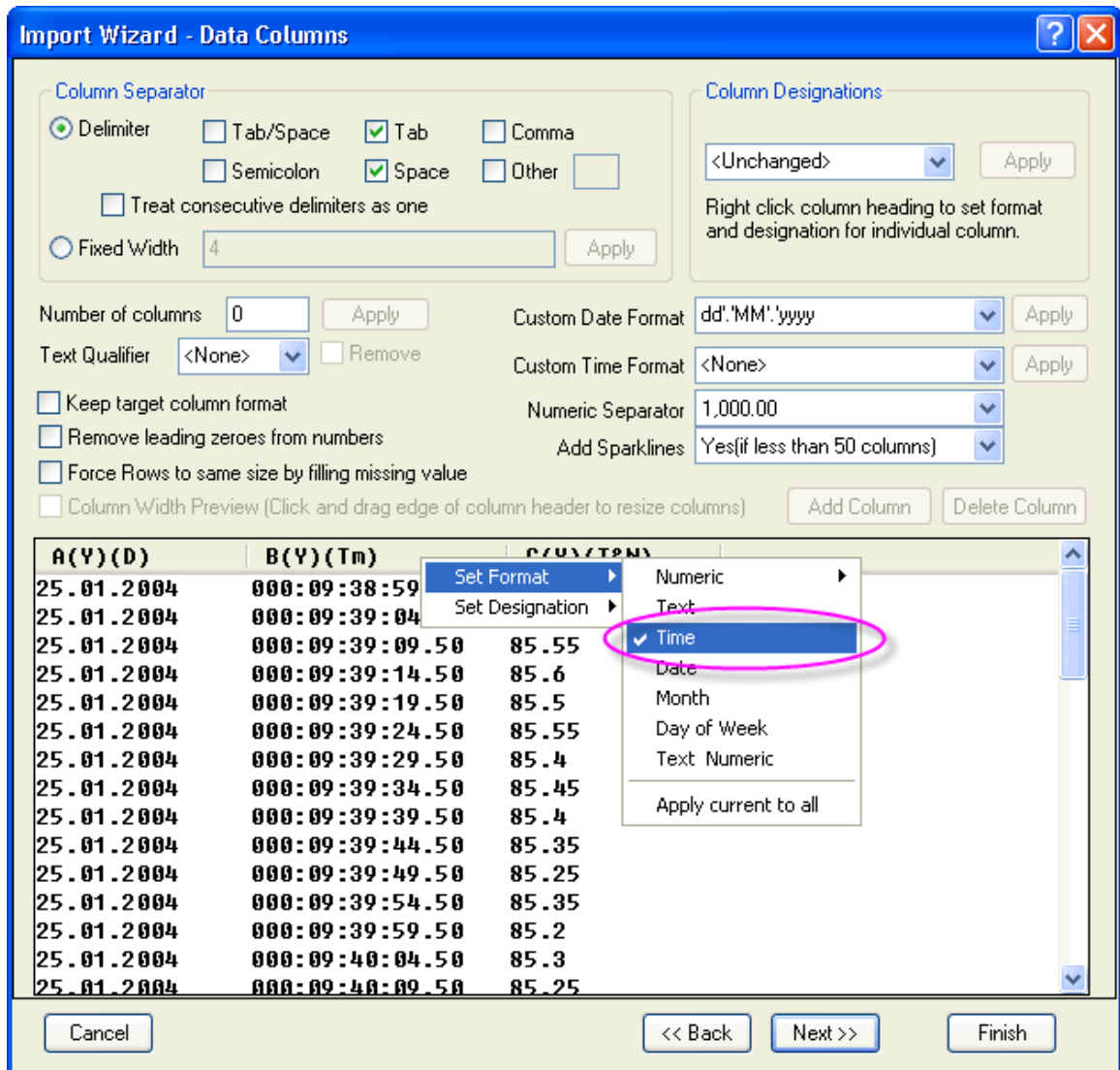

You can see the time data display in long format. We can change the display setting after imported.

5. Click **Next** twice to go to the **Save Filters** page. Select **Save filter** checkbox and **In the User File folder** radio box to save the import settings to a filter. Enter the filter file name as **Custom Date and Time** in the **Filter file name (.OIF extension will be appended)** edit box.
6. Click **Finish** button to import data. Then double-click the second column title to open the **Column Properties** dialog, and set the Time display as:

HH:mm:ss.##

The final worksheet data after imported will look like:

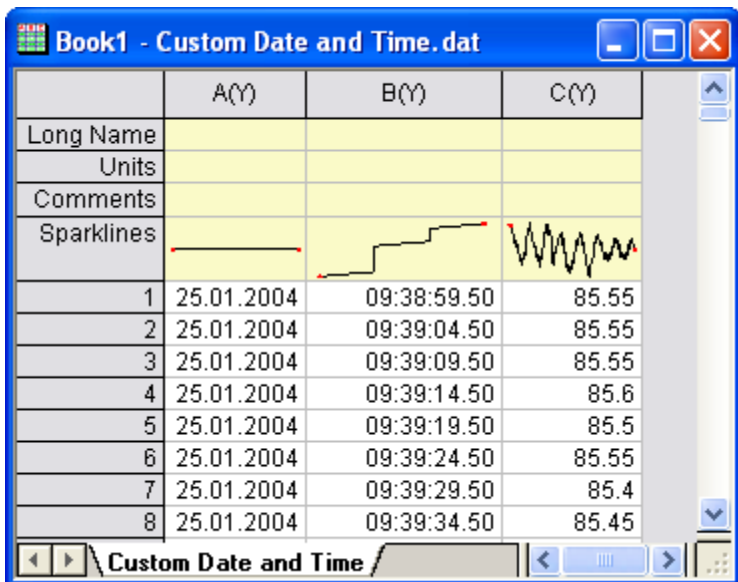

- Open Windows Explorer and browse to folder `\Samples\Import and Export\`. Locate the file *Custom Date and Time.dat*, drag and drop it to Origin workspace. The **Select Filter** dialog will open asking you to select a filter.

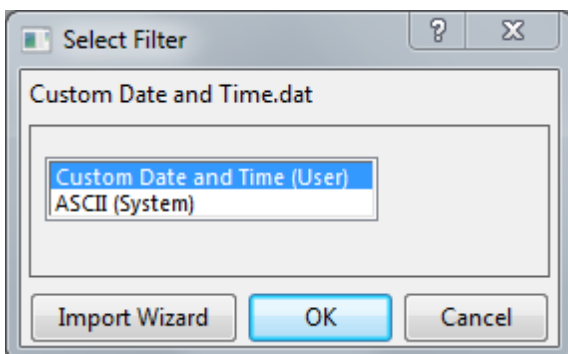

Select **Custom Date and Time** filter just saved. It will be used to import the file.

**Note:** In the case of this particular data file, the first column simply has the exact same date in every row. So at this point you may want to set this first column as Disregard by right-clicking on the column header and selecting *Disregard* from the context menu. Then you can set the 2nd column as type X, and plot the data in the third column against the time data in the 2nd column.

## 9.2.6 Post Processing with Import Filter

### 9.2.6.1 Summary



The Import Wizard allows defining a custom filter to import ASCII and simple binary files. The filter can then be reused with similar data files once created. The filter mechanism also allows including LabTalk script lines that will then be run at the end of the import. This capability allows user to add post-processing script code to the filter.

Minimum Origin Version Required: Origin 8.0 SR6

### 9.2.6.2 What you will learn

- How to add post processing script to existing import wizard filter

### 9.2.6.3 Steps

1. Start a new workbook by clicking the **New Workbook** button  on the Standard toolbar.
2. Click the **Import Wizard** button  on the Standard toolbar to open the wizard.
3. In the **Data Source** group, click the  button to the right of **File** and navigate to and add the file **Samples\Import and Export\S15-125-03.dat**.
4. A suitable filter for importing this file already exists in the data folder. Click the **Next** button to proceed thru all the pages of the wizard till you get to the **Save Filters** page.
5. On this page, check the **Save Filter** checkbox and select the option of **In the User Files folder**. Then specify the filter name as **fil\_01** in the **Filter file name(.OIF extension will be appended)** area.
6. Check the **Specify advanced filter options** checkbox and then click **Next**. This will bring you to the **Advanced Options** page.
7. On this page, copy and paste the following lines in the **Script after Each File Imported** edit box:

```

nlbegin iy:=(1,4) func:=gauss;

nlfitt;

nlend output:=1 autoupdate:=au_auto;

```

8. Click **Finish**. This will save the filter along with these added lines of script, and the file will be imported and the script will run. The workbook will then have three sheets, which will include the custom report sheet and the fitted curve sheet, which are results of Gauss function fit to column 4 of the imported data.
9. Start a new project and open import wizard again and add all three files **S15\_125\_03.dat**, **S21-235-07**, **S32-014-04** in the file open dialog.
10. Under *Import Filter*, check **List filters applicable to both Data Type and file name** checkbox and select **User File Folder:fil\_01** from the **Import Filters for current Data Type** drop-down list.
11. Under *Target Window*, select **Start New Books** from the **Import mode** drop-down list then click **Finish**. Your modified filter will be used and after each file is imported, the 4th column will be fit with the Gauss function.

## 9.2.7 Importing Multiple Files into Workbooks Cloned from Active Workbook

### 9.2.7.1 Summary

Origin provides a quick yet powerful way to clone current workbook/sheet when importing data, so that each new data will be imported to workbook/worksheet with same customization and analysis. This feature is implemented for most of Origin's supported import file types, e.g., ASCII, CSV, Excel, etc. This tutorial will highlight this feature with commonly used ASCII files.

#### 9.2.7.2 What you will learn

This tutorial will show you how to:

- Create a Prototype Workbook
- Import Multiple Files into the Cloned Workbook

#### 9.2.7.3 Import Multiple ASCII Files into Cloned Workbooks

##### 9.2.7.3.1 Create a Prototype Workbook

In this example we will import a file and do a linear fitting with it.

1. Start a new project. Click the **Import Single ASCII** button  on standard toolbar.
2. Browse to <Origin Installation Path>\Samples\Curve Fitting\ folder to select *Sensor01.dat*.
3. Check **Show Options Dialog** checkbox and click **Open** button.
4. Under the **Import Options** -> **Rename Sheets and Books** node, uncheck the **Rename Sheet with (Partial) Filename** box.
5. Click **OK** button to finish import. You can see after import, Sheet name is still **Sheet1**.
6. Highlight column **B** (*Sensor Output*) and choose **Plot: 2D: Scatter : Scatter** to plot a scatter graph.
7. Double click on X axis to open the **Axis** dialog. Activate **Scale** tab. Choose both **Horizontal** and **Vertical** on left panel and set **Rescale** as **Auto**. Click OK.
8. Choose **Analysis: Fitting: Linear Fit** menu to open **Linear Fit** dialog. Select **Recalculate** mode as **Auto**, click **OK** button to perform the fit. Select **No** radio box and click **OK** button in appeared prompt.
9. Right click in gray area on **Sheet 1** worksheet and choose **Add Graph...** context menu. Choose **Graph1** and click OK. Scatter plot with linear fit curve will show as a floating graph on **Sheet1**.



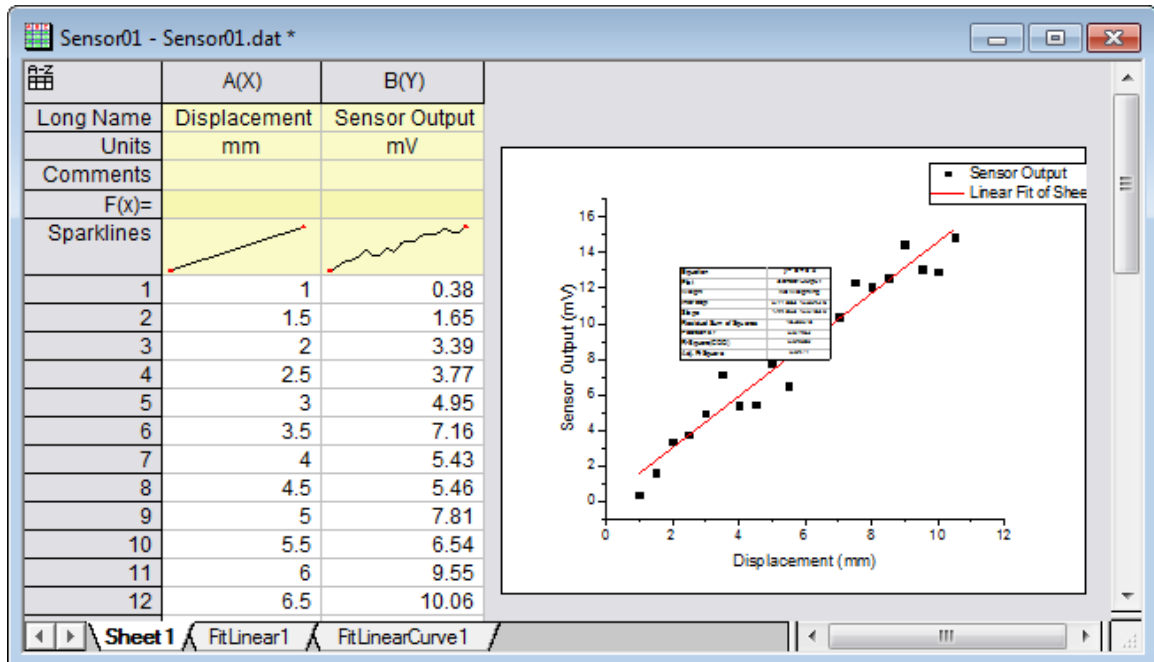

In step 8., you were asked to set the **Recalculate** mode to **Auto**. Beginning with Origin 2018b, this step is not necessary as cloned imports automatically trigger recalculation. Earlier versions of Origin will behave in the same way if you put the following line of LabTalk script into **Script after Each File Imported** box in the Import Multiple ASCII dialog box.

```
run -p au;
```

Script

Script after Each File Imported

```
run -p au;
```

Script after All Files Imported

Output

### 9.2.7.3.2 Import Multiple Files into the Cloned Workbook

Now we want to import more Sensor data and do the same linear fit.

1. Make sure **Sheet1** sheet is active and click the **Import Multiple ASCII** button  on standard toolbar.
2. Select the files *Sensor02.dat*, *Sensor03.dat* from **\Samples\Curve Fitting** and add to lower panel of the file dialog. Keep the **Show Options Dialog:<sheet>** box checked and click **OK**. This will open a dialog for import settings.

- Expand **Import Options** node and set **1st File Import Mode** and **Multi-File (except 1st) Import Mode** to **Start New Books**. To clone current workbook, select **<clone>** from **Template Name** drop-down list.

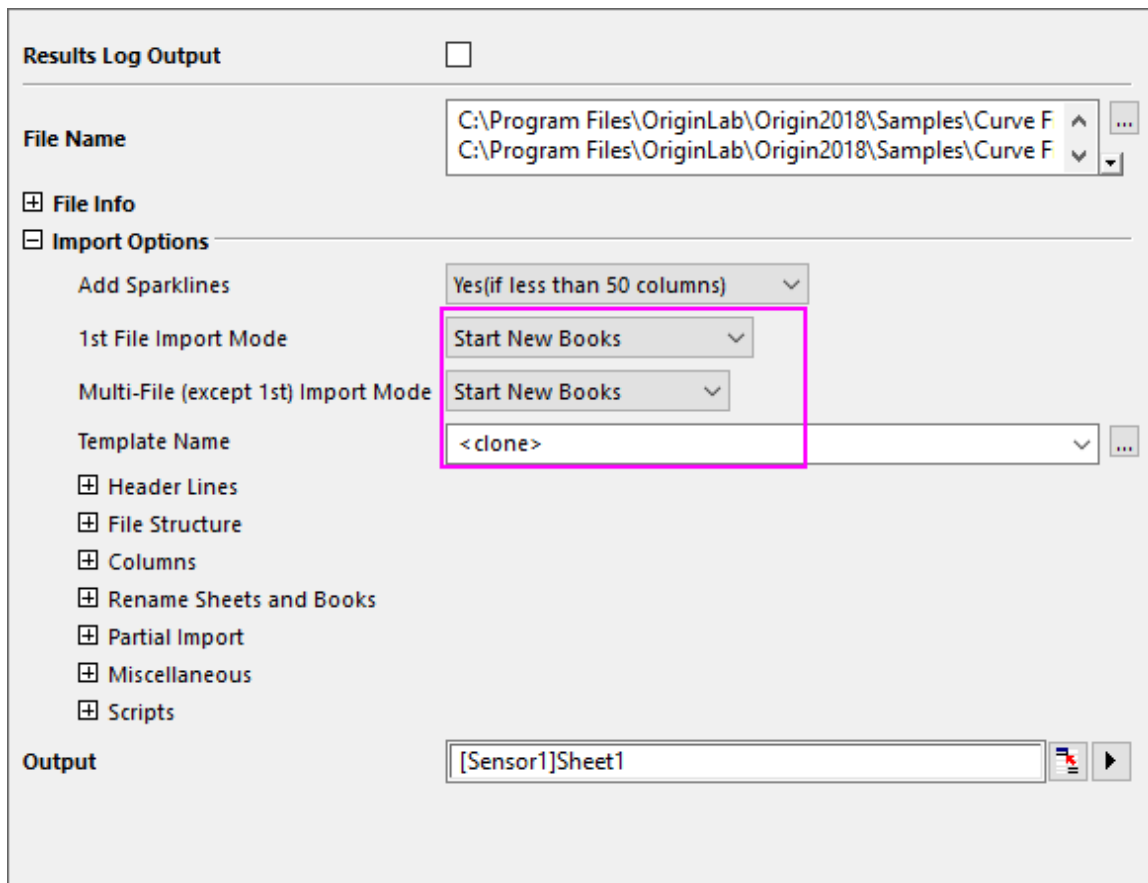

- Click **OK** button to import multiple files. Each data file is stored in a new workbook with same analysis done as in prototype workbook.

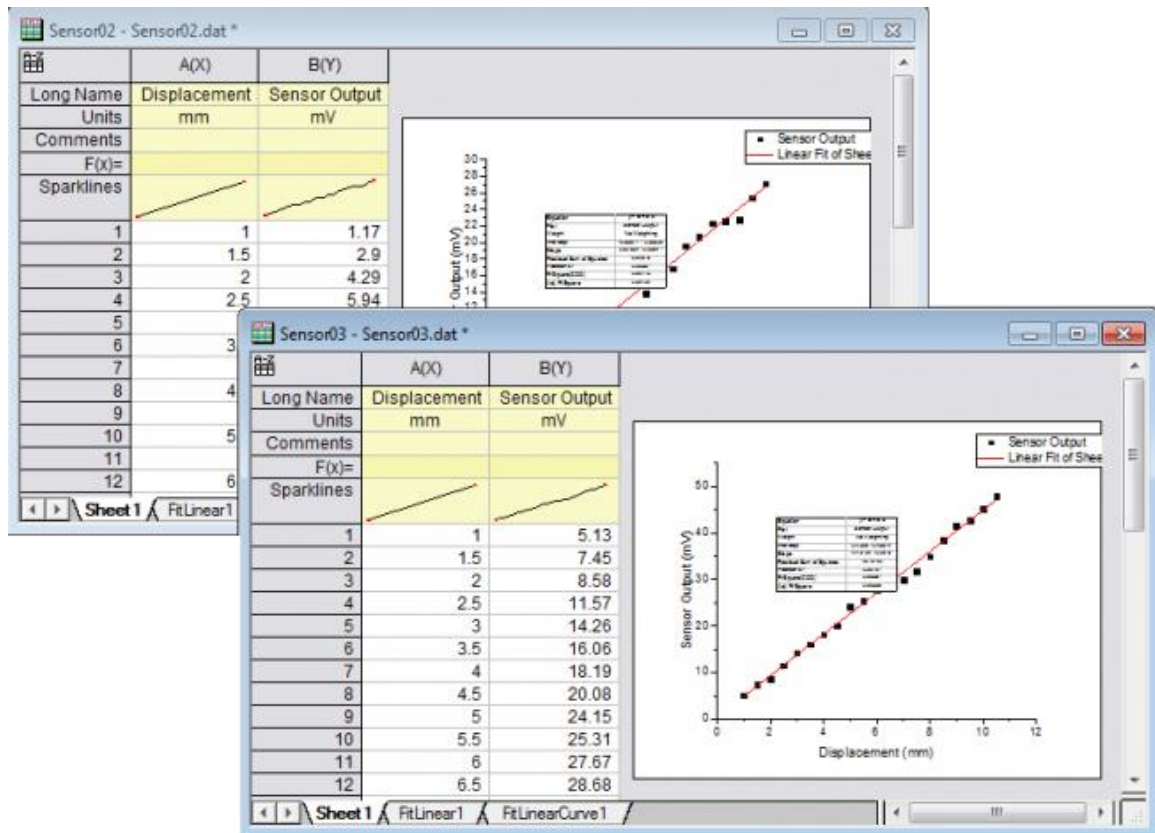

## 9.3 Database

### 9.3.1 Database

- [Import Data from a Database](#)
- [Import Data from a Database for Analysis](#)
- [SQL Editor for Database Analysis](#)
- [Update Database Importing By LabTalk Substitution](#)
- [Update Graph By Reimport Data From Database](#)

### 9.3.2 Import Data from a Database

#### 9.3.2.1 Summary

There are two tools to import data from a database in Origin.

- **Query Builder** (Origin 32-bit only) -- a graphic dialog to build the SQL query.
- **SQL Editor** (both Origin 32-bit and 64-bit) -- editor to directly write and edit SQL query. It is more convenient for skilled database users. It also allows users to define LabTalk variables in the SQL script.

In both tools, **Database Connection** can be saved as **ODS** file and **Database Connection and Query** can be saved as **ODQ** file for future use. Importing from database in Origin 64-bit is faster so users can build ODS and ODQ file in **Query Builder** if they are not familiar with SQL language, and later run Origin 64-bit to load the ODQ in **SQL Editor** for the real import.

This tutorial will show you how to build the connection to a SQL server and extract desired data from specified tables using **SQL Editor** and **Query Builder**. The SQL database we use here is [AdventureWorks database](#). For detailed information of how to attach an AdventureWorks database, please refer to [CodePlex website](#).



The tutorial only works in **32-bit Origin** as **Query Builder** is only supported in 32-bit Origin



Steps in the tutorial are only illustrative of what users could be doing with your database locally. Please don't follow to test.

### 9.3.2.2 What you will learn

This tutorial will show you how to:

- Import data from database using the SQL Editor.
- Import data from database using Query Builder.
- Reimport data.
- LabTalk support in the SQL Editor.

### 9.3.2.3 Steps

**Suppose we have already set up a SQL server named *AdventureWorks2008* on a server machine *noho*.**

#### 9.3.2.3.1 Import data using SQL Editor

1. Start a new project. Open **SQL Editor** by clicking the **Open SQL Editor** button on the **Database Access** toolbar.

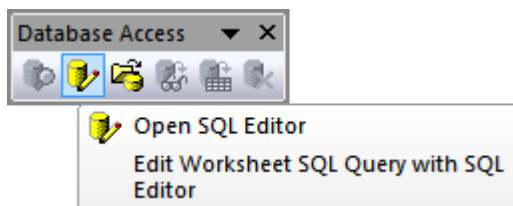

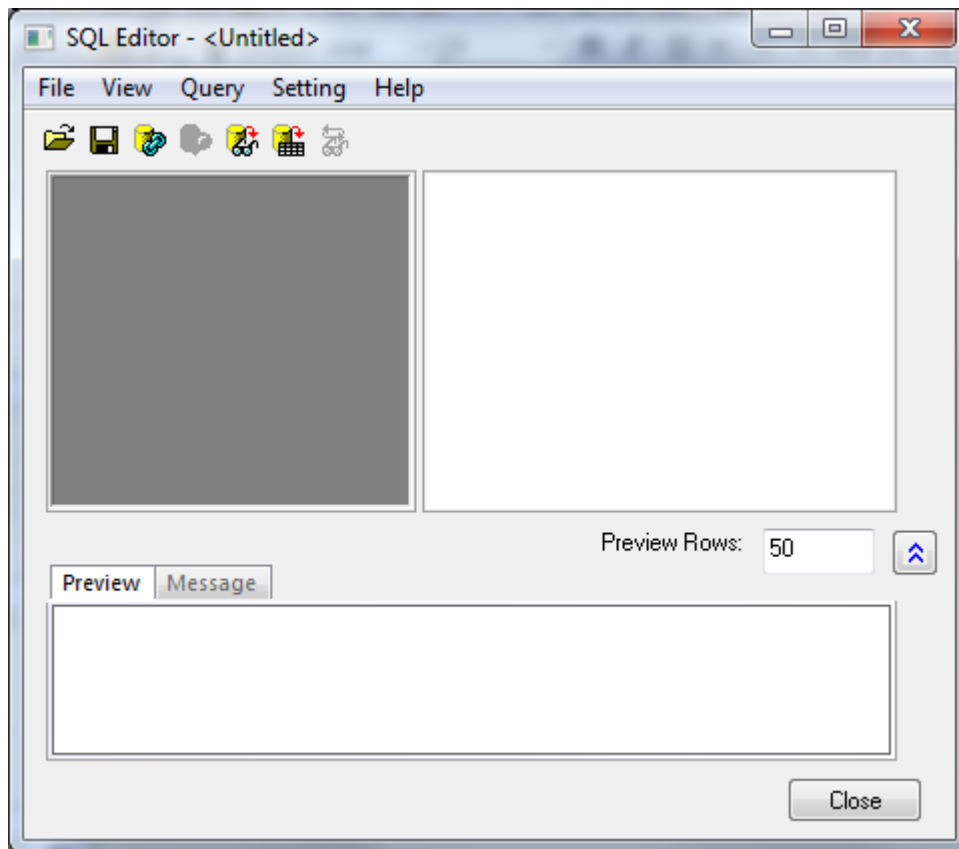

2.

3. Now we are going to create the connection to the *AdventureWorks2008R2* database. Click  button or select **File: New...** menu to bring up the **Data Link Properties** dialog.

4. Select Microsoft OLE DB Provider for SQL Server on the **Provider** tab. Click **Next>>** button.

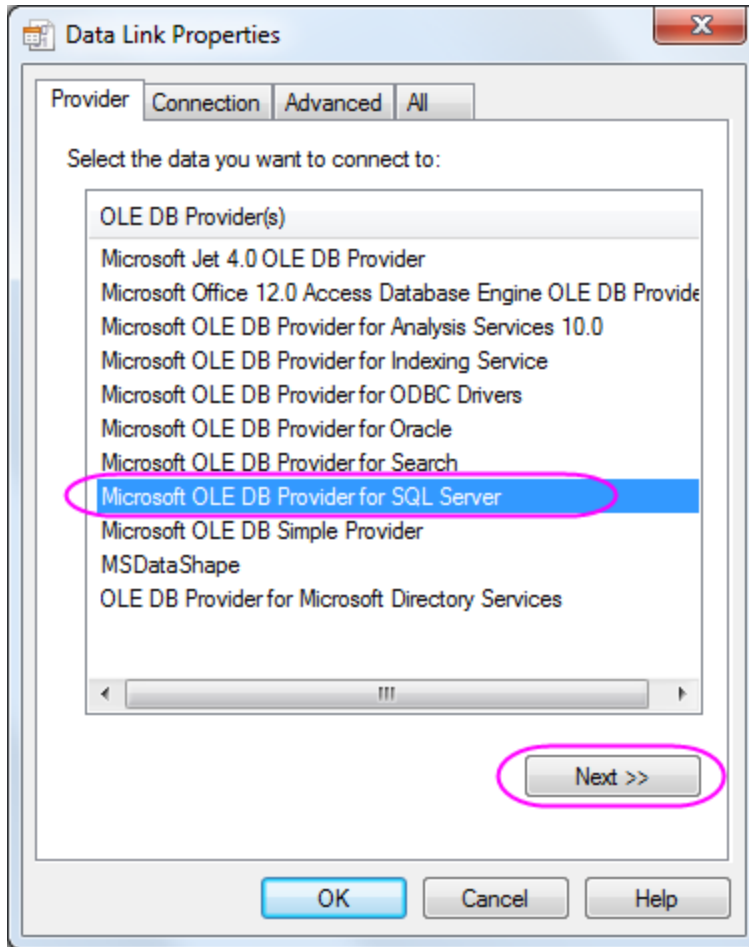

5. On the **Connection** tab that is active, specify the server information, including server name, log-in user name and password (if needed, in this example labtalk2015), and database name. Click **Test Connection** to make sure the connection is successful.

The screenshot shows the 'Data Link Properties' dialog box with the 'Connection' tab selected. The dialog is titled 'Data Link Properties' and has a close button (X) in the top right corner. Below the title bar are four tabs: 'Provider', 'Connection', 'Advanced', and 'All'. The 'Connection' tab is active, and the text 'Specify the following to connect to SQL Server data:' is displayed. The dialog contains three main sections:

- 1. Select or enter a server name:** A dropdown menu shows 'noho' and a 'Refresh' button is to its right.
- 2. Enter information to log on to the server:** There are two radio buttons: 'Use Windows NT Integrated security' (unselected) and 'Use a specific user name and password:' (selected). Below the second radio button are two text boxes: 'User name:' containing 'CONNECT' and 'Password:' containing ten black dots. There are also two checkboxes: 'Blank password' (unchecked) and 'Allow saving password' (checked).
- 3. Select the database on the server:** A radio button is selected next to 'Select the database on the server:', followed by a dropdown menu showing 'AdventureWorks2008'. Below this is another radio button for 'Attach a database file as a database name:', which is unselected. This section includes a text box with 'AdventureWorks2008', the text 'Using the filename:', another text box, and a browse button (...).

At the bottom of the dialog are three buttons: 'OK', 'Cancel', and 'Help'. A 'Test Connection' button is located above the 'OK' button.

6. Click **OK** button. All tables in database AdventureWorks2008 are listed in the left panel. The Connection string is in the Message tab.

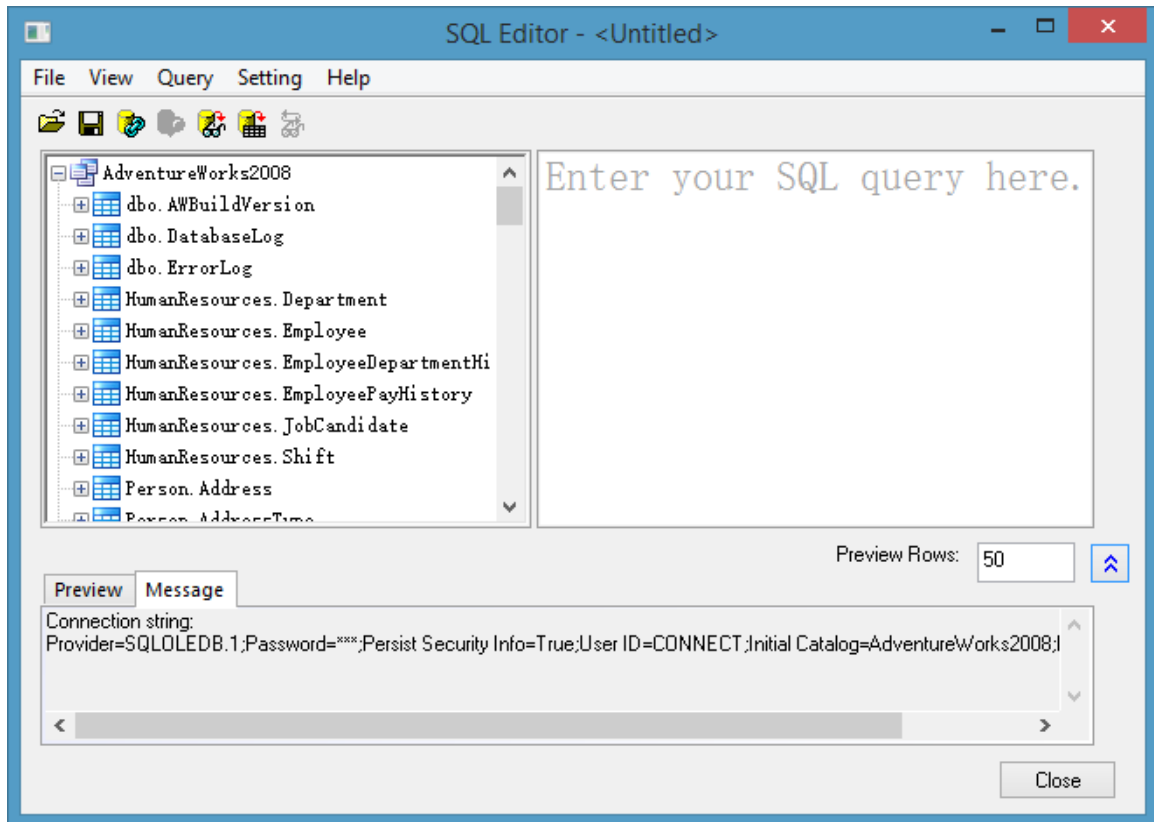

7.

Alternatively if you already have connection string, you can select **File: Edit Connection String...** menu to open the **Connection String Editor** dialog. Enter the following SQL string and then click **OK** button to create the connection.

```

Provider=SQLOLEDB.1;

Password=labtalk2015;

Persist Security Info=TRUE;

USER ID=CONNECT;

Initial Catalog=AdventureWorks2008;

DATA SOURCE=noho

```

8. Select **File: Save Connection As...** to save the data source file as *MyDataSource.ods*.



9. Now we are going to extract data from 9 tables to construct the employee list. You can write SQL script from scratch. Double click node on left panel will help you add the table and field name in the editor. For now, just copy following SQL scripts in the right panel.

```

SELECT

    e.BusinessEntityID, p.Title, p.FirstName, p.MiddleName, p.LastName,

    p.Suffix, e.JobTitle, pp.PhoneNumber, pnt.Name AS PhoneNumberType,
    ea.EmailAddress,

    p.EmailPromotion, a.AddressLine1, a.AddressLine2, a.City, sp.Name AS
    StateProvinceName,

    a.PostalCode, cr.Name AS CountryRegionName,

    p.AdditionalContactInfo

FROM

    HumanResources.Employee AS e INNER JOIN

    Person.Person AS p ON p.BusinessEntityID = e.BusinessEntityID INNER
JOIN

    Person.BusinessEntityAddress AS bea ON bea.BusinessEntityID =
    e.BusinessEntityID INNER JOIN

    Person.Address AS a ON a.AddressID = bea.AddressID INNER JOIN

    Person.StateProvince AS sp ON sp.StateProvinceID = a.StateProvinceID
INNER JOIN

    Person.CountryRegion AS cr ON cr.CountryRegionCode =
    sp.CountryRegionCode LEFT OUTER JOIN

    Person.PersonPhone AS pp ON pp.BusinessEntityID = p.BusinessEntityID
LEFT OUTER JOIN

```



```

Person.PhoneNumberType AS pnt ON pp.PhoneNumberTypeID =
pnt.PhoneNumberTypeID LEFT OUTER JOIN

Person.EmailAddress AS ea ON p.BusinessEntityID = ea.BusinessEntityID

WHERE sp.Name='Washington'

ORDER BY e.BusinessEntityID
    
```

- Click the **Preview the result data** button  to preview the data. If the preview is fine, click the **Import data to worksheet** button  to import these data. Once imported, the worksheet is connected to the database, and a yellow icon will appear at the top-left of the worksheet.

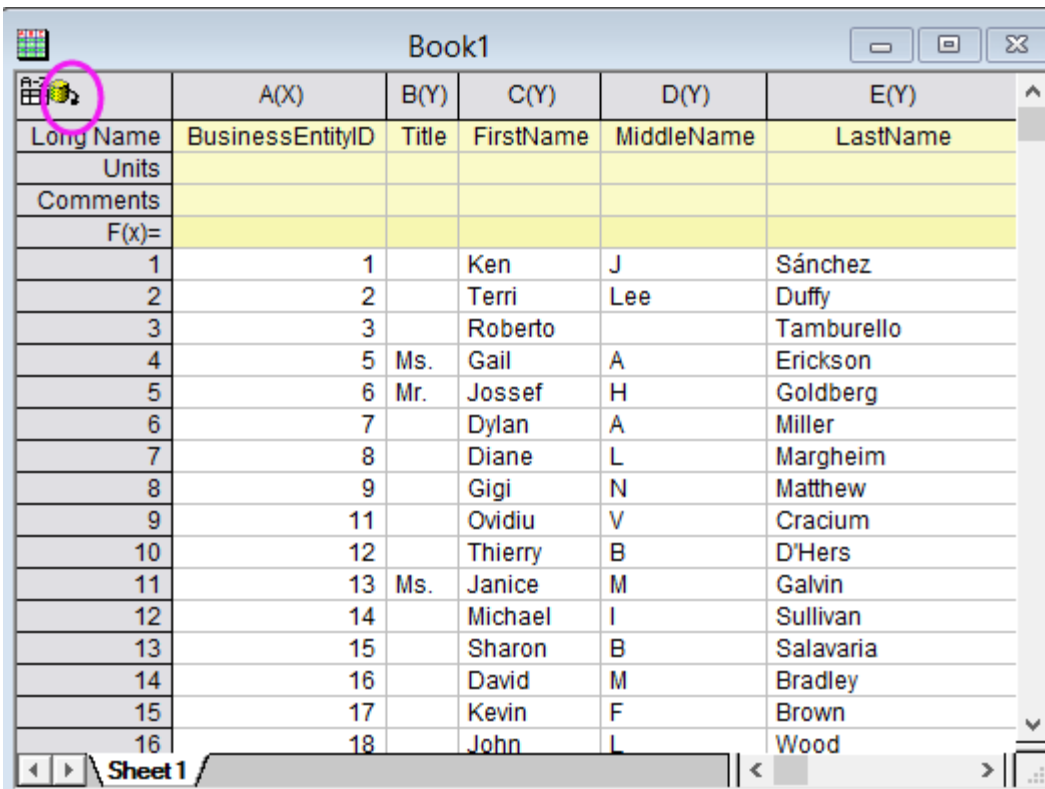

	A(X)	B(Y)	C(Y)	D(Y)	E(Y)
Long Name	BusinessEntityID	Title	FirstName	MiddleName	LastName
Units					
Comments					
F(x)=					
1	1	Ken	J	Sánchez	
2	2	Terri	Lee	Duffy	
3	3	Roberto		Tamburello	
4	5	Ms. Gail	A	Erickson	
5	6	Mr. Jossef	H	Goldberg	
6	7	Dylan	A	Miller	
7	8	Diane	L	Margheim	
8	9	Gigi	N	Matthew	
9	11	Ovidiu	V	Cracium	
10	12	Thierry	B	D'Hers	
11	13	Ms. Janice	M	Galvin	
12	14	Michael	I	Sullivan	
13	15	Sharon	B	Salavaria	
14	16	David	M	Bradley	
15	17	Kevin	F	Brown	
16	18	John	L	Wood	

- Select **File: Save Connection and Query As...** from menu to save the connection and query as *MyQuery.odq*. Close the **SQL Editor**.

**9.3.2.3 Import data using Query Builder in Origin 32 bit**

- If you are running Origin 32-bit, you can use **Query Builder** to visually build your SQL scripts
- Start a new project. Click **Query Builder** button  on **Database Access** toolbar.

3. Select **Query: Data Source: Open...** menu to load *MyDataSource.ODS*. All tables in database *AdventureWorks2008* will show in right panel.

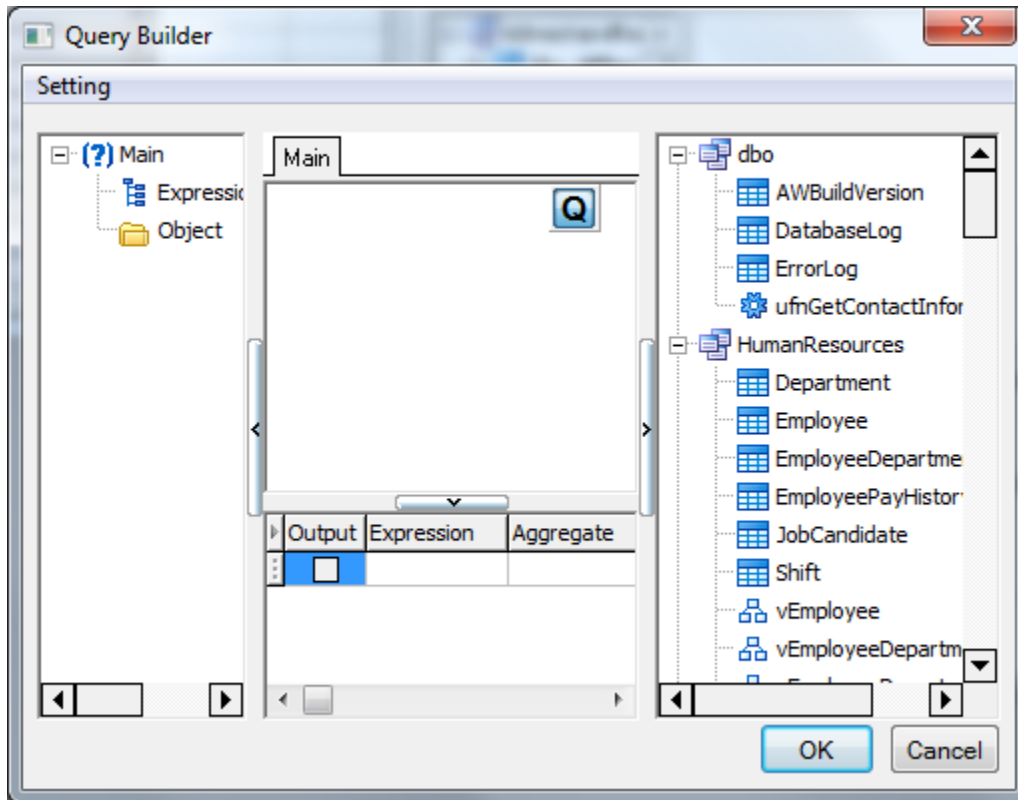

4. Drag and drop the following 9 tables from the right panel to the Main panel in the middle:

HumanResources.Employee
Person.Address
Person.BusinessEntityAddress
Person.CountryRegion
Person.EmailAddress
Person.Person
Person.PersonPhone

Person.PhoneNumberType
Person.StateProvince

- Drag main key **BusinessEntityID** from table *HumanResources.Employee* and drop it to that key in table *Person.BusinessEntityAddress* to join these two table. A join line will connect between them.

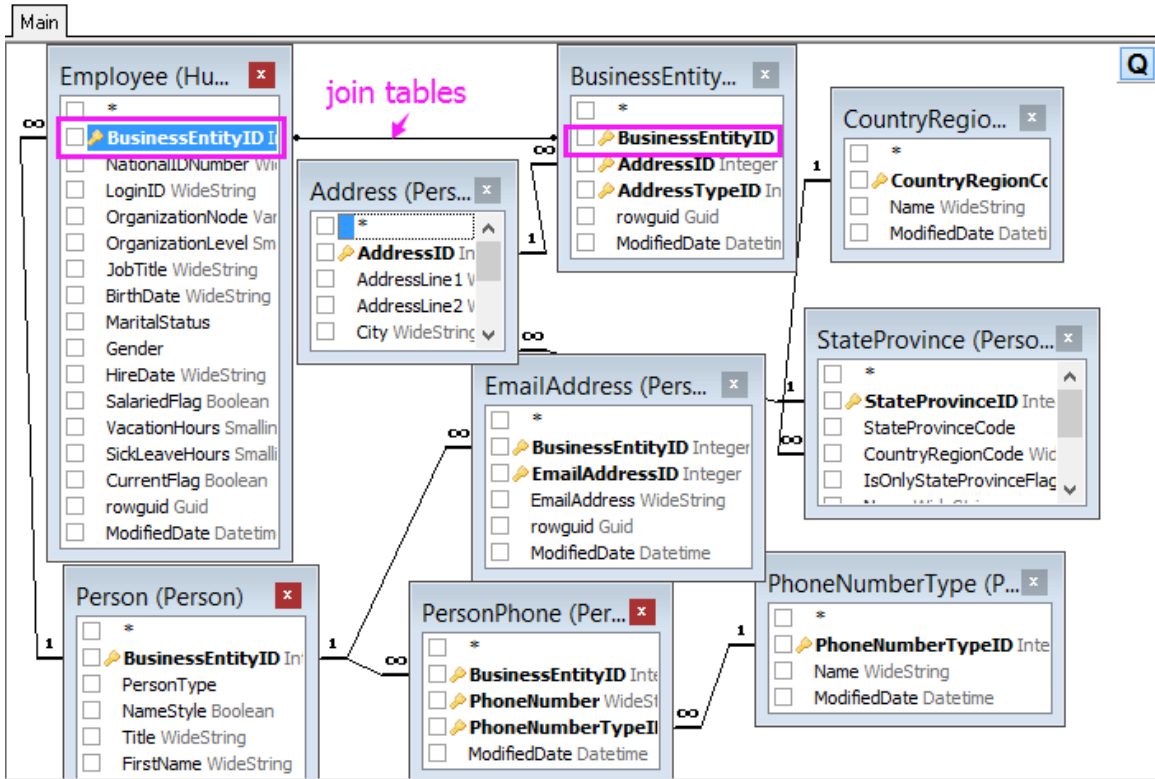

- Select the checkbox in front of the following columns from the corresponding tables to add them to the lower panel.

Table	Column
HumanResources.Employee	<ul style="list-style-type: none"> <li><input type="radio"/> BusinessEntityID</li> <li><input type="radio"/> JobTitle</li> </ul>
Person.Person	<ul style="list-style-type: none"> <li><input type="radio"/> Title</li> <li><input type="radio"/> FirstName</li> <li><input type="radio"/> MiddleName</li> <li><input type="radio"/> LastName</li> <li><input type="radio"/> Suffix</li> </ul>

	<ul style="list-style-type: none"> <li>○ EmailPromotion</li> <li>○ AdditionalContactInfo</li> </ul>
Person.Address	<ul style="list-style-type: none"> <li>○ AddressLine1</li> <li>○ AddressLine2</li> <li>○ City</li> <li>○ PostalCode</li> </ul>
Person.StateProvince	<ul style="list-style-type: none"> <li>○ Name</li> </ul>
Person.CountryRegion	<ul style="list-style-type: none"> <li>○ Name</li> </ul>
Person.PersonPhone	<ul style="list-style-type: none"> <li>○ PhoneNumber</li> </ul>
Person.PhoneNumberType	<ul style="list-style-type: none"> <li>○ Name</li> </ul>
Person.EmailAddress	<ul style="list-style-type: none"> <li>○ EmailAddress</li> </ul>

7. In the lower panel, drag and drop the first cell of a row to re-arrange column order as needed. E.g. JobTitle is moved after Suffix.

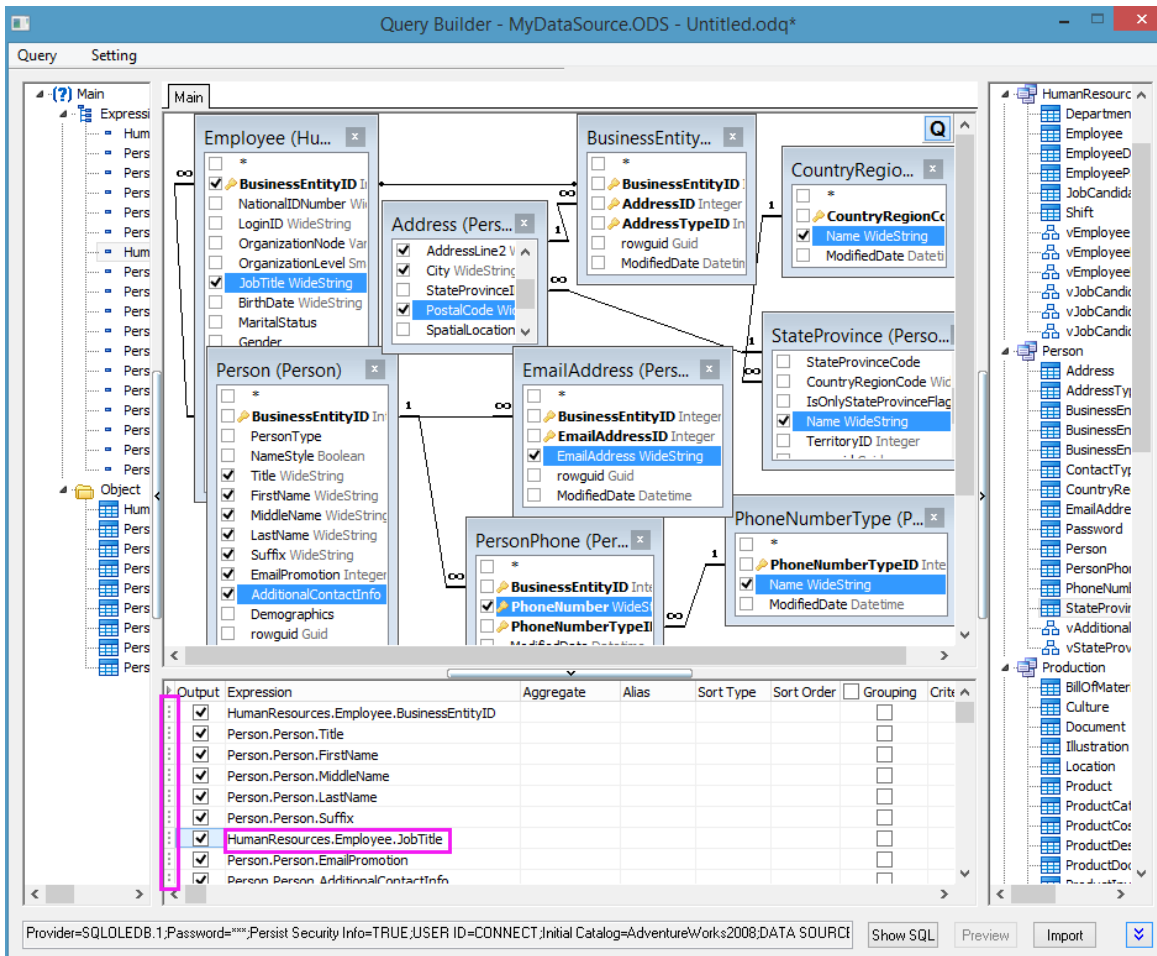

8. Select Ascending from Sort Type drop-down list in the first row *HumanResources.Employee.BusinessEntityID* to sort the whole worksheet according to this column ascendingly.
  
9. As Criteria = 'Washington' on *Person.StateProvince.Name* row.

Output	Expression	Aggreg Alias	Sort Type	Sort Order	Grouping Criteria	Or...	Or..
<input checked="" type="checkbox"/>	HumanResources.Employee.BusinessEnt		Ascending	1	<input type="checkbox"/>		
<input checked="" type="checkbox"/>	Person.Person.Title				<input type="checkbox"/>		
<input checked="" type="checkbox"/>	Person.Person.FirstName				<input type="checkbox"/>		
<input checked="" type="checkbox"/>	Person.Person.MiddleName				<input type="checkbox"/>		
<input checked="" type="checkbox"/>	Person.Person.LastName				<input type="checkbox"/>		
<input checked="" type="checkbox"/>	Person.Person.Suffix				<input type="checkbox"/>		
<input checked="" type="checkbox"/>	HumanResources.Employee.JobTitle				<input type="checkbox"/>		
<input checked="" type="checkbox"/>	Person.Person.EmailPromotion				<input type="checkbox"/>		
<input checked="" type="checkbox"/>	Person.Person.AdditionalContactInfo				<input type="checkbox"/>		
<input checked="" type="checkbox"/>	Person.Address.AddressLine1				<input type="checkbox"/>		
<input checked="" type="checkbox"/>	Person.Address.AddressLine2				<input type="checkbox"/>		
<input checked="" type="checkbox"/>	Person.Address.City				<input type="checkbox"/>		
<input checked="" type="checkbox"/>	Person.Address.PostalCode				<input type="checkbox"/>		
<input checked="" type="checkbox"/>	Person.StateProvince.Name				<input type="checkbox"/>	= 'Washington'	
<input checked="" type="checkbox"/>	Person.CountryRegion.Name	Name1			<input type="checkbox"/>		
<input checked="" type="checkbox"/>	Person.PersonPhone.PhoneNumber				<input type="checkbox"/>		
<input checked="" type="checkbox"/>	Person.PhoneNumberType.Name	Name2			<input type="checkbox"/>		
<input checked="" type="checkbox"/>	Person.EmailAddress.EmailAddress				<input type="checkbox"/>		

- Click the **Preview** button to preview the data in bottom panel. If the preview is fine, click the **Import** button to import into data into worksheet. Once imported, the worksheet is connected to the database, and a yellow icon will appear at the top-left of the worksheet.

Long Name	A(X)	B(Y)	C(Y)	D(Y)	E(Y)	F(Y)	G(Y)
BusinessE	Title	FirstName	MiddleNa	LastName	Suffix	JobTitle	
Units							
Comments							
F(x)=							
1	1		Ken	J	Sánchez		Chief Executive Officer
2	2		Terri	Lee	Duffy		Vice President of Engineering
3	3		Roberto		Tamburello		Engineering Manager
4	5	Ms.	Gail	A	Erickson		Design Engineer
5	6	Mr.	Jossef	H	Goldberg		Design Engineer
6	7		Dylan	A	Miller		Research and Development Manager
7	8		Diane	L	Margheim		Research and Development Engineer
8	9		Gigi	N	Matthew		Research and Development Engineer
9	11		Ovidiu	V	Cracium		Senior Tool Designer
10	12		Thierry	B	D'Hers		Tool Designer
11	13	Ms.	Janice	M	Galvin		Tool Designer
12	14		Michael	I	Sullivan		Senior Design Engineer
13	15		Sharon	B	Salavaria		Design Engineer
14	16		David	M	Bradley		Marketing Manager
15	17		Kevin	F	Brown		Marketing Assistant
16	18		John	L	Wood		Marketing Specialist
17	19		Mary	A	Dempsey		Marketing Assistant
18	20		Wanida	M	Benshoof		Marketing Assistant





- Select **File: Save Connection and Query As...** from menu to save the connection and query as a ODQ file *MyQuery2.odq*. Close the **Query Builder**.

### 9.3.2.3.3 Reimport from Database

No matter using **SQL Editor** or **Query Builder** to import data from database, the connection and the query are automatically saved in the worksheet. You can click the **Import data**  button on **Database Access** toolbar anytime to import the data from the database again. Try the following steps.

1. Delete some data in the worksheet with database connection.
2. Click the **Import data**  button. The data should be back.
3. To import the database in a new workbook, choose **File: Database Import** menu. All saved ODQ files are listed here.
4. Choose MyQuery.ODQ. A new workbook will be created with data from database.



1. If your database is big, the saved workbook file will be big. You can choose **Worksheet: Clear Worksheet** to clear the data and then save the workbook. Later you can load the workbook and click the **Preview the result data**  button to preview 50 rows of the data or click the **Import data**  button to import from database.
2. If you need to modify the query, with the worksheet active, click the **SQL Editor** button  or **Query Builder** button .

#### 9.3.2.3.4 LabTalk Support in SQL Editor

In above examples, we only imported data for Washington state. But it's hard coded so if you want to do a query of another State, you need to change the query. This section will show you how to define a Labtalk string variable for state name so it's easier to change the query in the future.

1. Start with a new project. Choose **File: Database Import: MyQuery.ODQ to import data directly into worksheet.**
2. Click the **Open SQL Editor** button  to open the **SQL Editor**.
3. To add a Labtalk string variable, select **Query: LabTalk...** to open the **LabTalk Support Setting** dialog.

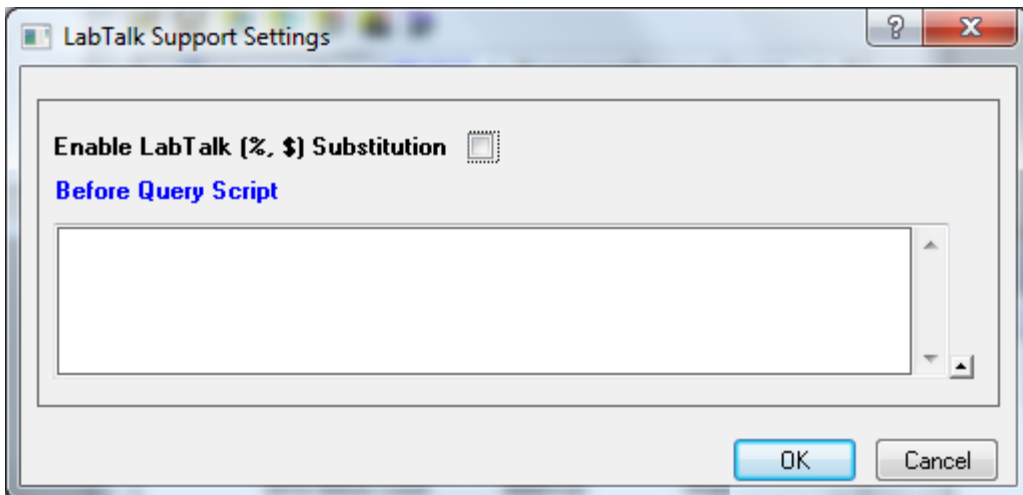



4. Check the **Enable LabTalk (%,\$) substitution** checkbox.
5. Type the script below to define a LabTalk string variable **strCond** to represent the Washington State.

```
string strCond$ = "Washington";
```

in the **Before Query Script** box. Click **OK**.

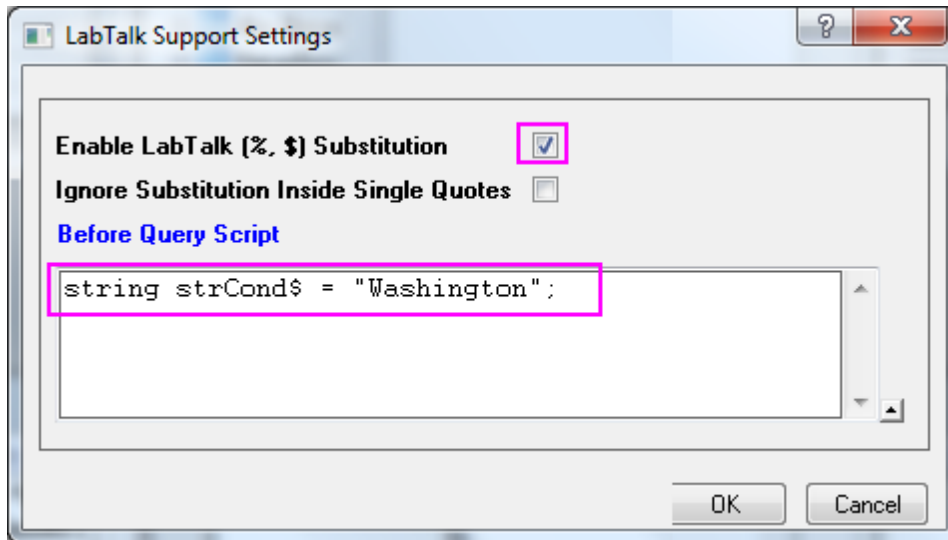

6. At the end of SQL Script on right panel, change **WHERE** statement into

```
WHERE sp.name = '%(strCond$)'
```

7. Click the  button to preview the SQL query string in with labtalk variable substituted the SQL Editor box.

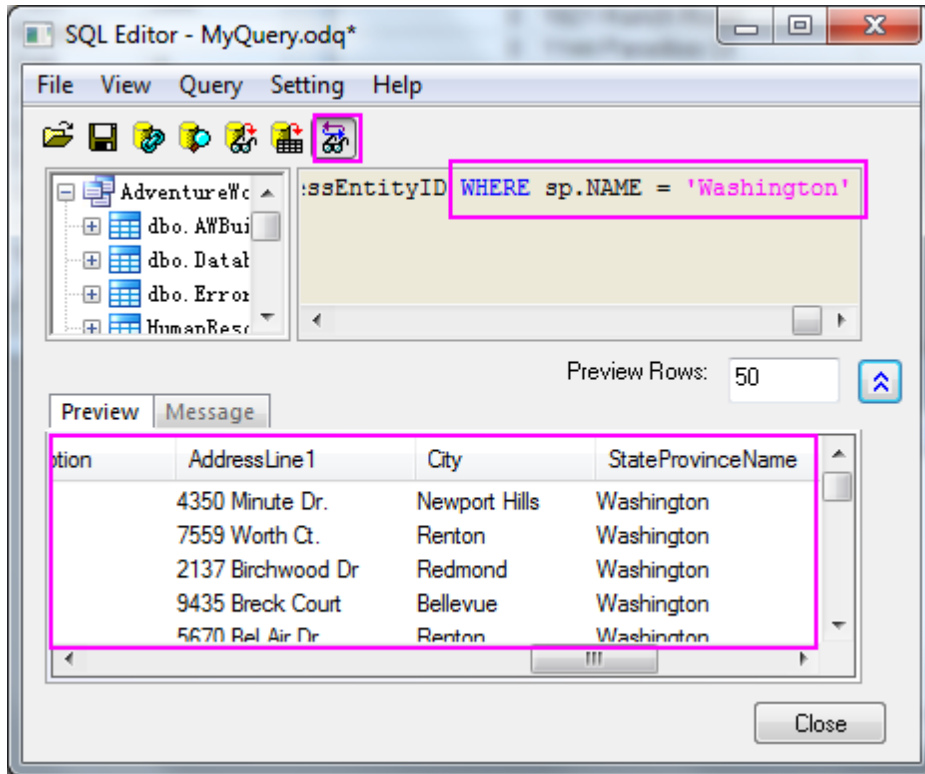

8. Click the **Import data to worksheet** button  to import these data. Close the dialog and choose **Yes** to resaved the SQL Query into worksheet.
9. From now on, you only need to change the strCond\$ value in **LabTalk Support Settings** dialog to change the State name. No need to change the SQL Query.

### 9.3.3 Import Data from a Database for Analysis

#### 9.3.3.1 Summary

This tutorial shows how to import data from database into Origin worksheet by using SQL Editor. And then perform some operations on the data, such as filter, statistics, etc., so to get the desired results for the graphing.

The SQL database we use here is [AdventureWorks database](#). For detailed information of how to attach an AdventureWorks database, please refer to [CodePlex website](#).

Minimum Origin Version Required: Origin 9.0 SR0

#### 9.3.3.2 What you will learn

This tutorial will show you how to:

- Import two SQL queries of same database into two sheets of a workbook data using SQL Editor.
- Apply data filter to the worksheet data.
- Perform descriptive statistics on columns.
- Make graphs such as column plot, etc.

9.3.3.3 Steps

Suppose we have already set up a SQL server named AdventureWorks2008 on a server machine noho.

## 9.3.3.3.1 Import Data from Database

1. Start a new project. Open SQL Editor by clicking the **Open SQL Editor** button on the **Database Access** toolbar.

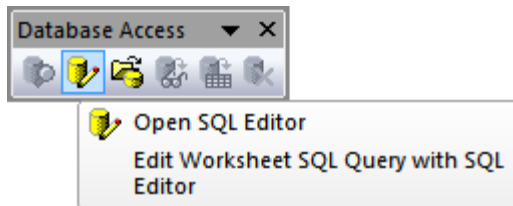

2. Select **File: Edit Connection String...** menu and put the connection string below to the text box.

```

Provider=SQLOLEDB.1;

Password=labtalk2015;

Persist Security Info=TRUE;

USER ID=CONNECT;

Initial Catalog=AdventureWorks2008;

DATA SOURCE=noho

```

3. Click the **Test** button to test if the connection is fine. If fine, click the **OK** button to connection to the database.
4. From the top left panel, double click on *Production.Product* table to add the table name on right panel.
5. Click the **Preview the result data** button  to view the data in the bottom panel.

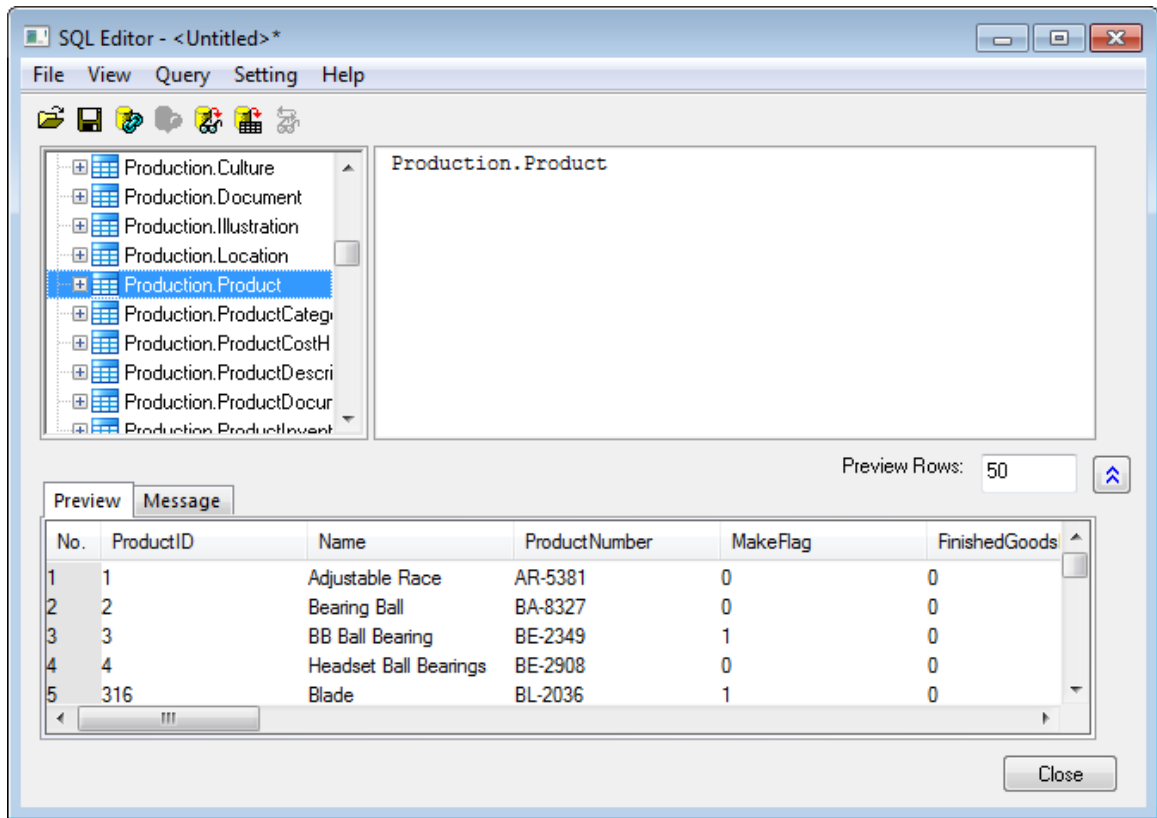

- Click the **Import data to worksheet** button  to import the data in the table to the active worksheet.

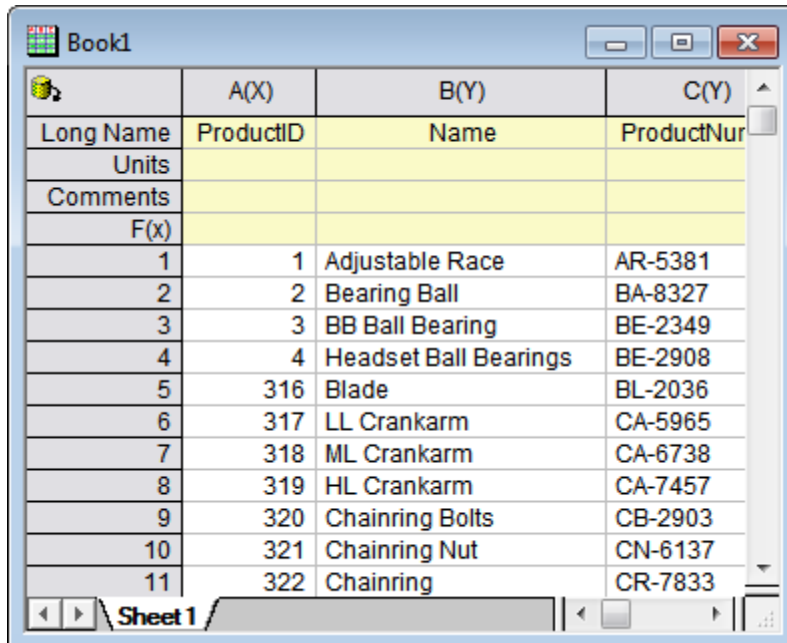

7. To import data based on another SQL query from the same database to new sheet, click the minimum button on the title bar of **SQL Editor** dialog to make it shrink into a bar.
8. Right click on Sheet1 tab and choose **Add** to add a new sheet.

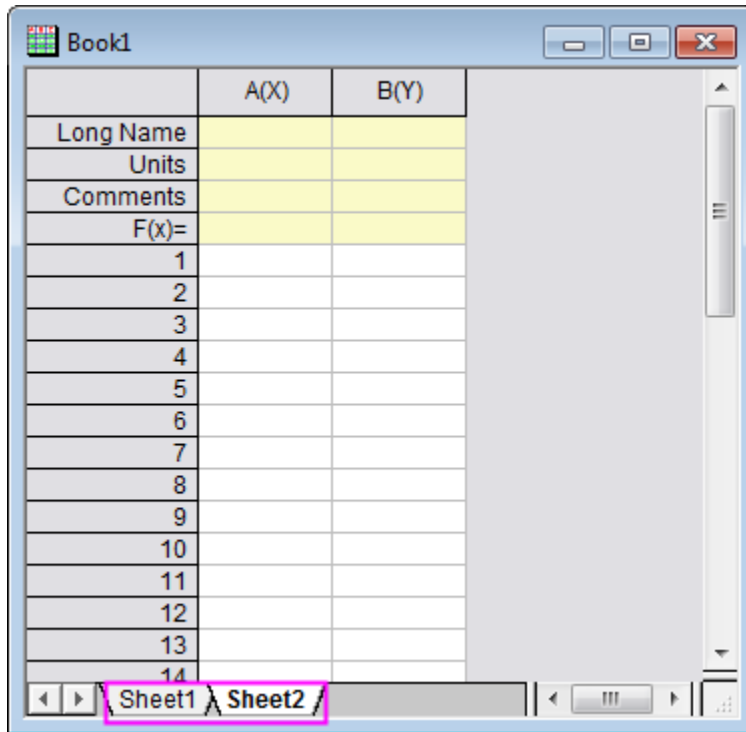

9. Click the minimum button of **SQL Editor** dialog again to expand the dialog. You can see *Production: Product* still shows in right panel. You can ignore it for now.
10. Select **Query: LabTalk...** menu to open the **LabTalk Support Settings** dialog. Check the **Enable LabTalk (% , \$) Substitution** checkbox, and put the following script to the text box.

```
string strDateBegin1$ = "1/1/2003";
string strDateEnd1$ = "12/31/2003";
string strDateBegin2$ = "1/1/2004";
string strDateEnd2$ = "12/31/2004";
```

The dialog will look like this.

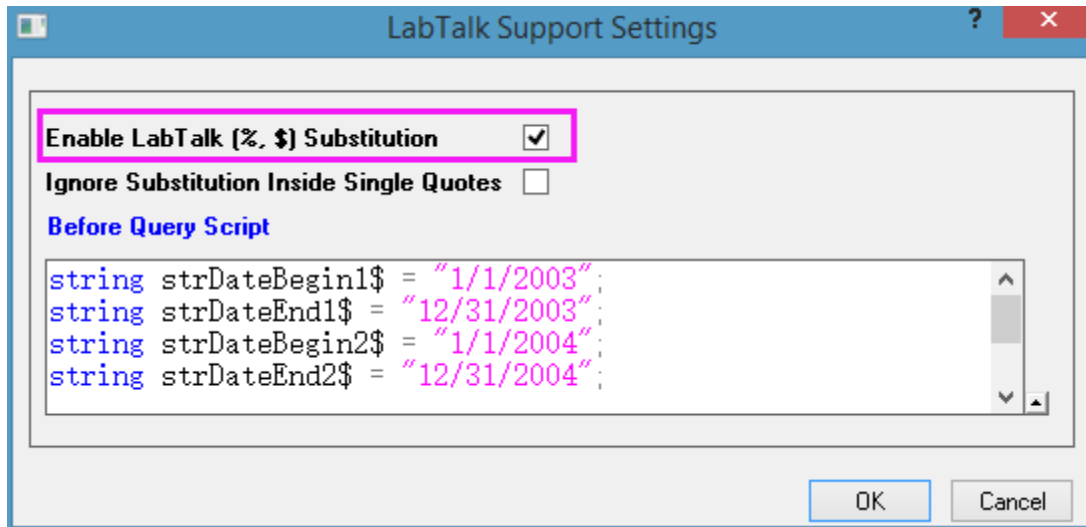

- Click **OK** to go back SQL Editor. Then put the following SQL script to the top right panel to replace existing content *Production.Product*. This script is going to query three columns from the database, one is the product's category name, other twos are line total for each category on year 2003 and 2004 respectively.

```

SELECT TABLE2003.Name, TABLE2003.LineTotalFor2003,
TABLE2004.LineTotalFor2004

FROM

    (SELECT Production.ProductCategory.Name,
LINETOALANDNAME2003.LineTotalFor2003

    FROM

        (SELECT SUM(SALEANDPRODUCT2003.LineTotal) AS
LineTotalFor2003, Production.ProductSubcategory.ProductCategoryID

    FROM

        (SELECT SALEINFO2003.LineTotal,
PRODUCTINFO2003.ProductSubcategoryID

    FROM

        (SELECT Sales.SalesOrderHeader.OrderDate,

```

```

Sales.SalesOrderDetail.LineTotal, Sales.SalesOrderDetail.ProductID

        FROM Sales.SalesOrderHeader

        INNER JOIN Sales.SalesOrderDetail

        ON

Sales.SalesOrderHeader.SalesOrderID=Sales.SalesOrderDetail.SalesOrderID

        WHERE Sales.SalesOrderHeader.OrderDate
BETWEEN '%(strDateBeginl$)' AND '%(strDateEndl$)' AS SALEINFO2003

        INNER JOIN

        (SELECT Production.Product.ProductID,
Production.Product.ProductSubcategoryID

        FROM Production.Product) AS

PRODUCTINFO2003

        ON

SALEINFO2003.ProductID=PRODUCTINFO2003.ProductID) AS SALEANDPRODUCT2003

        INNER JOIN Production.ProductSubcategory

        ON

SALEANDPRODUCT2003.ProductSubcategoryID=Production.ProductSubcategory.Prod
uctSubcategoryID

        GROUP BY Production.ProductSubcategory.ProductCategoryID)
AS LINETOALANDNAME2003

        INNER JOIN Production.ProductCategory

        ON

LINETOALANDNAME2003.ProductCategoryID=Production.ProductCategory.ProductCa
tegoryID) AS TABLE2003

        INNER JOIN

        (SELECT Production.ProductCategory.Name,

```

```

LINETOTALANDNAME2004.LineTotalFor2004

        FROM

                (SELECT SUM(SALEANDPRODUCT2004.LineTotal) AS
LineTotalFor2004, Production.ProductSubcategory.ProductCategoryID

        FROM

                (SELECT SALEINFO2004.LineTotal,
PRODUCTINFO2004.ProductSubcategoryID

        FROM

                (SELECT Sales.SalesOrderHeader.OrderDate,
Sales.SalesOrderDetail.LineTotal, Sales.SalesOrderDetail.ProductID

        FROM Sales.SalesOrderHeader

        INNER JOIN Sales.SalesOrderDetail

        ON

Sales.SalesOrderHeader.SalesOrderID=Sales.SalesOrderDetail.SalesOrderID

        WHERE Sales.SalesOrderHeader.OrderDate
BETWEEN '%(strDateBegin2$)' AND '%(strDateEnd2$)' ) AS SALEINFO2004

        INNER JOIN

                (SELECT Production.Product.ProductID,
Production.Product.ProductSubcategoryID

        FROM Production.Product) AS

PRODUCTINFO2004

        ON

SALEINFO2004.ProductID=PRODUCTINFO2004.ProductID) AS SALEANDPRODUCT2004

        INNER JOIN Production.ProductSubcategory

        ON

```



```

SALEANDPRODUCT2004.ProductSubcategoryID=Production.ProductSubcategory.Prod
uctSubcategoryID



GROUP BY Production.ProductSubcategory.ProductCategoryID)
AS LINETOALANDNAME2004

INNER JOIN Production.ProductCategory

ON

LINETOALANDNAME2004.ProductCategoryID=Production.ProductCategory.ProductCa
tegoryID) AS TABLE2004

ON TABLE2003.Name=TABLE2004.Name
    
```

- Click the last button  to view the SQL query script with substituted variable. Click **Preview the result data** button  to view the data in the bottom panel.

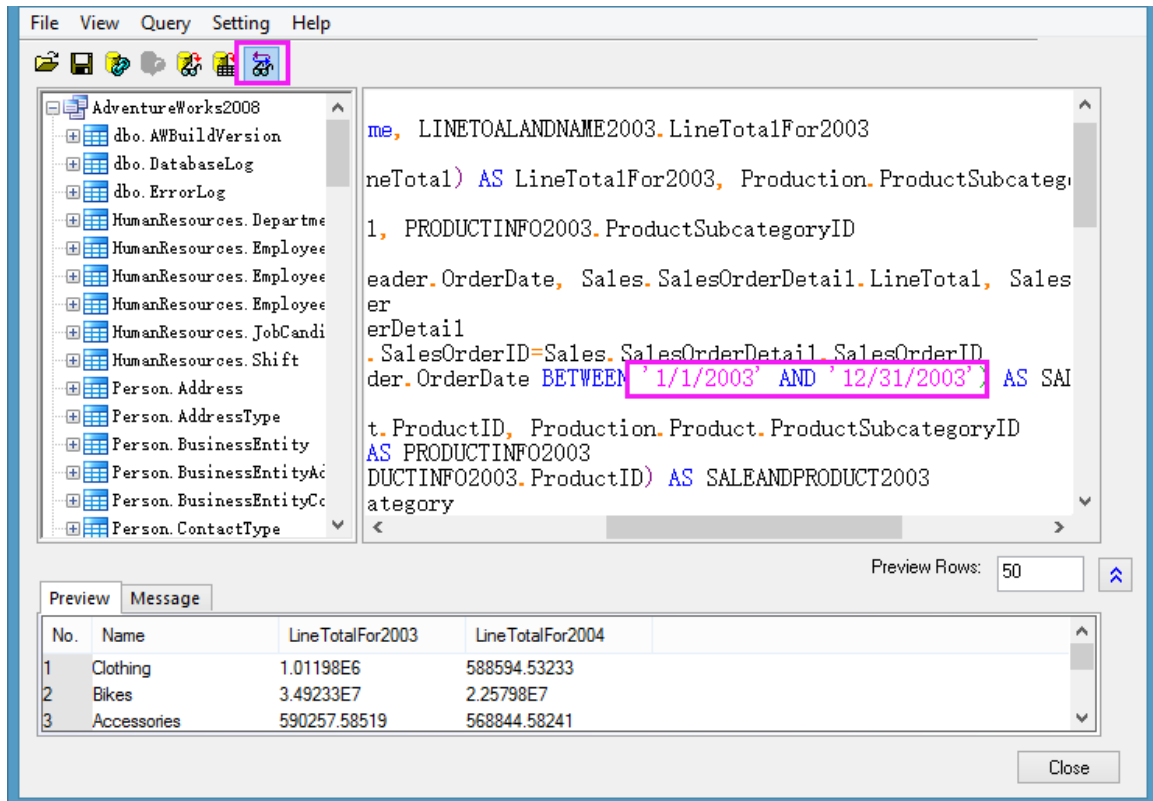

The screenshot shows the Microsoft Access interface. The top menu bar includes File, View, Query, Setting, and Help. The left pane shows a database structure for AdventureWorks2008. The main area displays a SQL query with a date range highlighted in pink: `BETWEEN '1/1/2003' AND '12/31/2003'`. Below the query, the 'Preview' tab is selected, showing a table with the following data:

No.	Name	LineTotalFor2003	LineTotalFor2004
1	Clothing	1.01198E6	588594.53233
2	Bikes	3.49233E7	2.25798E7
3	Accessories	590257.58519	568844.58241

- Click the **Import data to worksheet** button  to import the query into the the active Sheet2.

	A(X)	B(Y)	C(Y)
Long Name	Name	LineTotalFor2003	LineTotalFor2004
Units			
Comments			
F(x)=			
1	Clothing	1.01198E6	588594.53233
2	Bikes	3.49233E7	2.25798E7
3	Accessories	590257.58519	568844.58241
4	Components	5.48551E6	2.09151E6
5			
6			
7			
8			
9			
10			

14. Close SQL Editor. You will be prompted to save the change. You can choose **No** since the query settings are saved in corresponding sheet automatically when clicking Import button. You can also choose **Yes** to save the query of active sheet as an ODQ file for future use.

### 9.3.3.3.2 Data Filter and Statistics

1. Go to the first worksheet with the imported data from *Production.Product* in the above section.
2. Select column **I** (long name is StandardCost), and then add a data filter to this column by clicking the **Add/Remove data filter** button on the **Worksheet Data** toolbar.

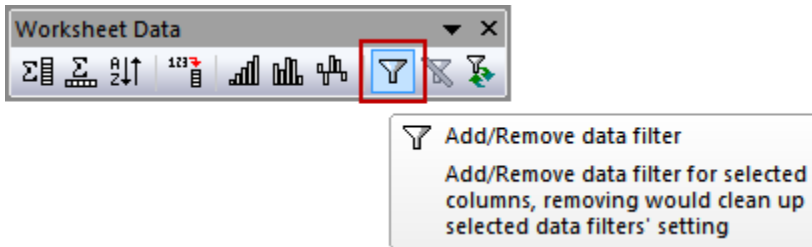

3. Then there will be a filter icon on the top left corner of the column header. Click on it, and then select **Greater Than...** from the context menu.

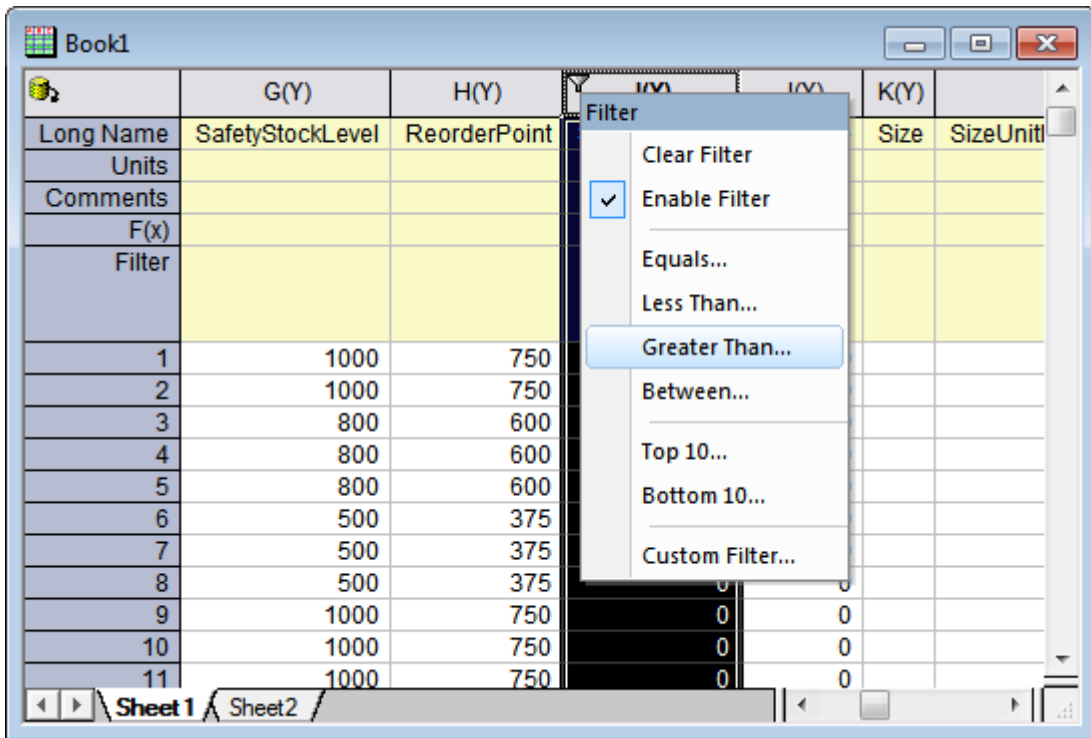

- There will be a dialog open, just keep the default **Value** to be 0 and click **OK** button.

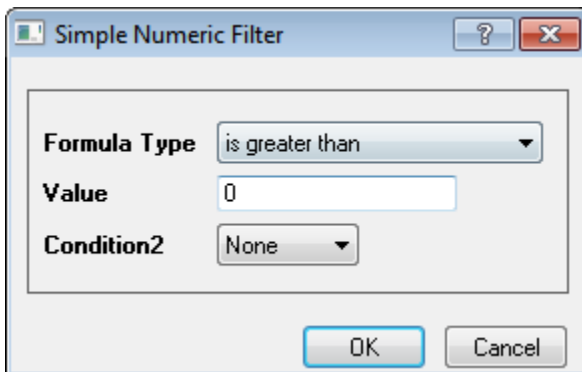

- Add a filter in column P (long name is ProductLine) as well with condition as follows.

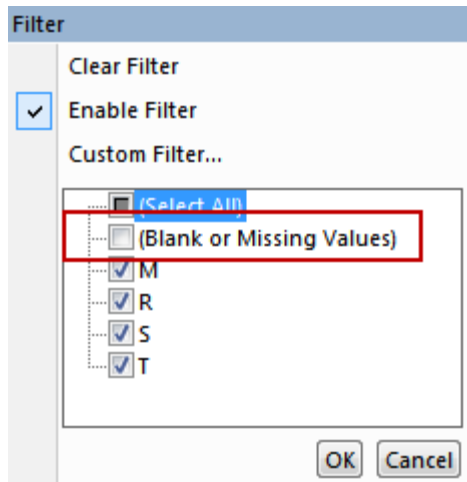

6. Select column I and J (StandardCost and ListPrice), then select menu **Statistics: Descriptive Statistics: Statistics on Columns** to open the **Statistics on Columns** dialog.
7. In the open dialog, set **Grouping Range** to be column P. You can just click the triangle button to select column P from list on the right. And in the **Plots** tab, check **Box Charts** checkbox.

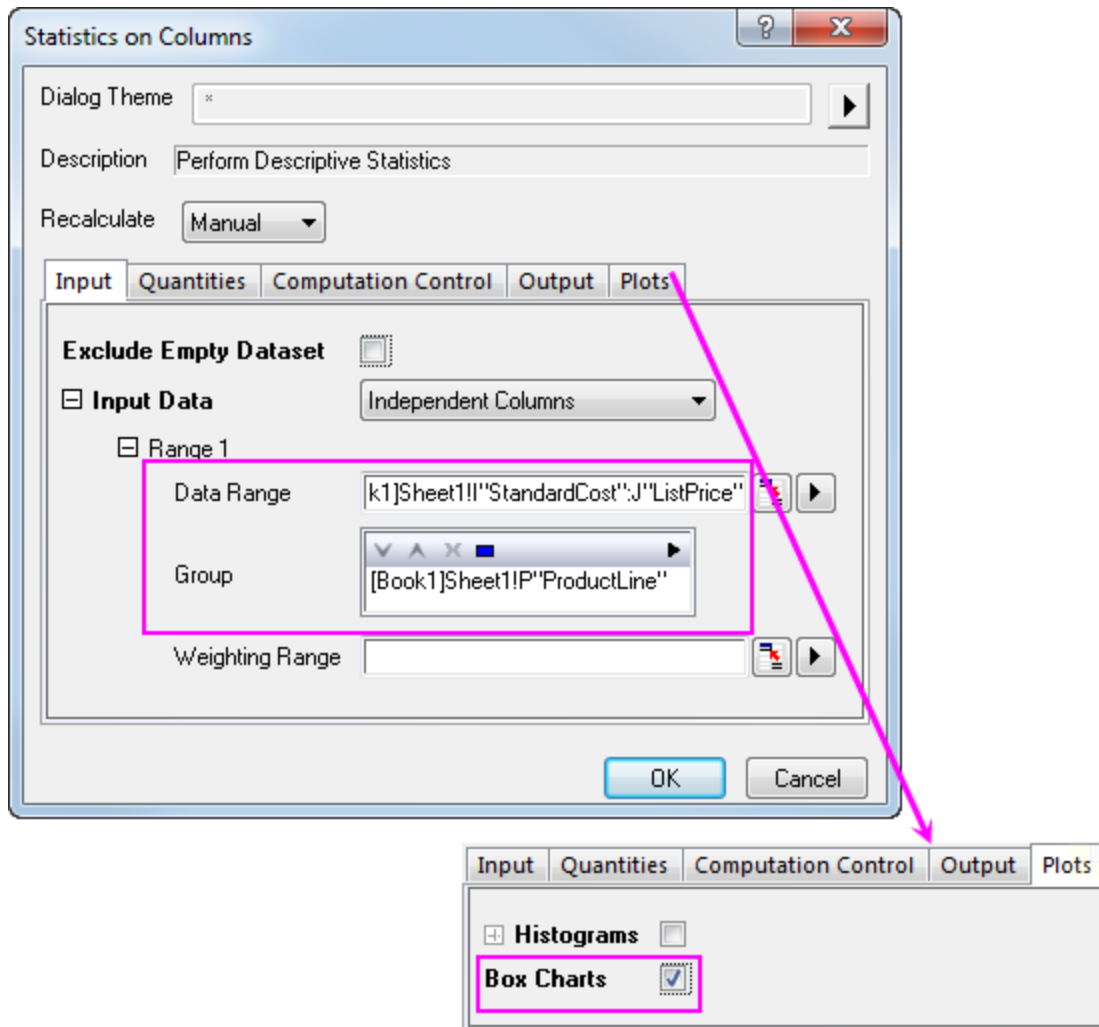

8. Click **OK** button to get the results.

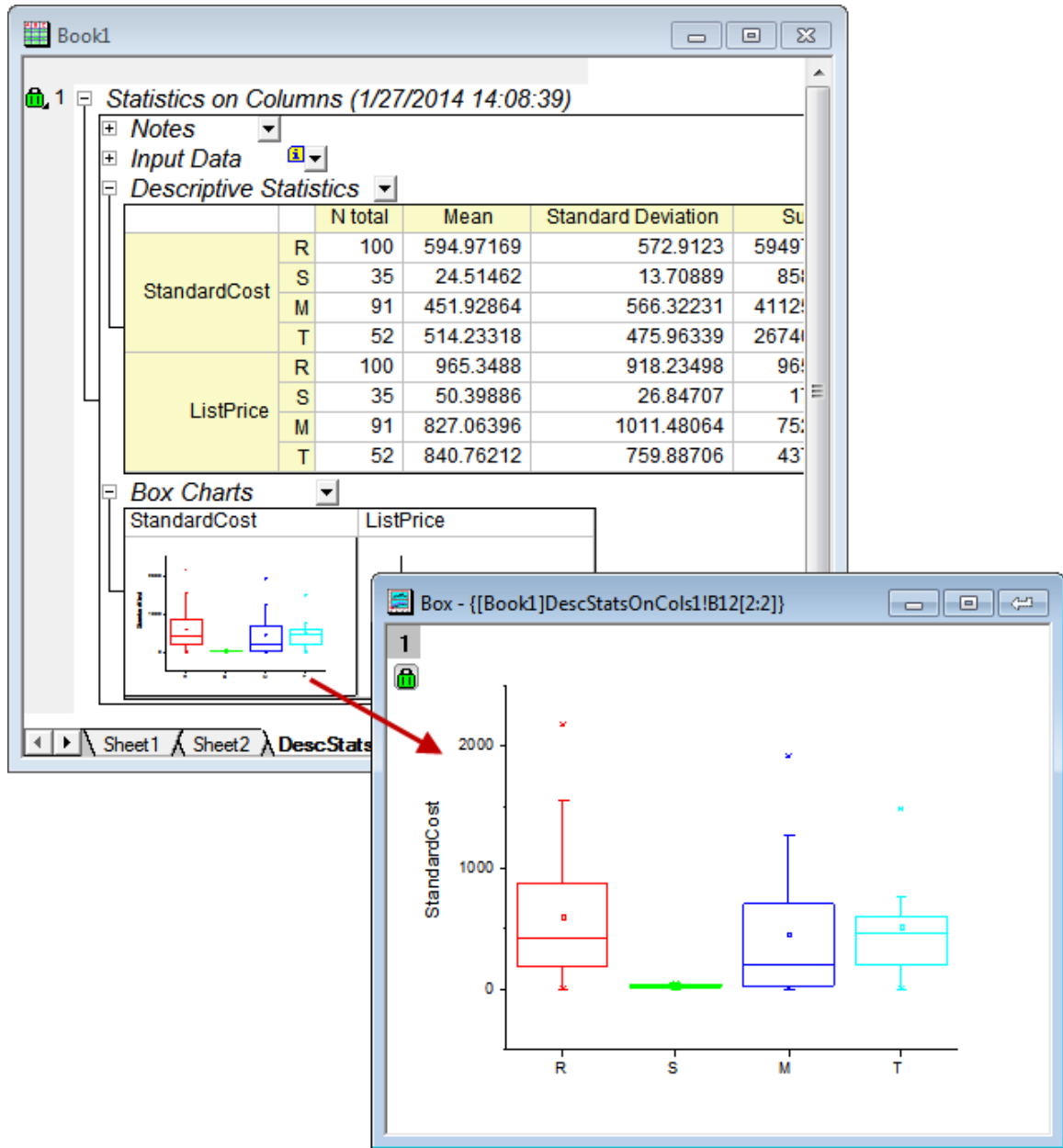

### 9.3.3.3 Radar Plot

1. Go to the **Sheet2**.
2. Highlight all three columns, and select **Plot: Specialized: Radar** menu to make a radar plot.

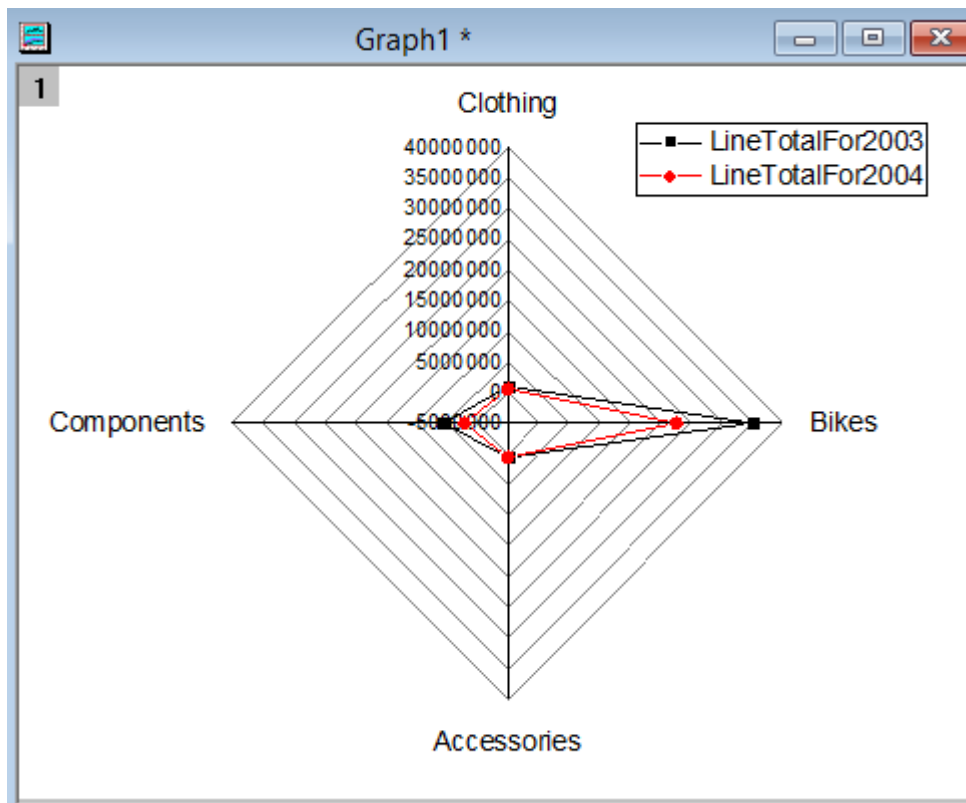

3. Double click on the *Clothing* axis to open the **Axis Dialog**. Please note that the below procedure is based on Origin 2017.
4. With **Scale** selected on the left panel. Make sure **Use Same Options for All Axes** checkbox is unchecked. Select Axis1 to Axis4 on the left panel. Then set **From** to 0, and choose **By # of Majors** for **Major Ticks** with value of 6. Click **Apply** button.

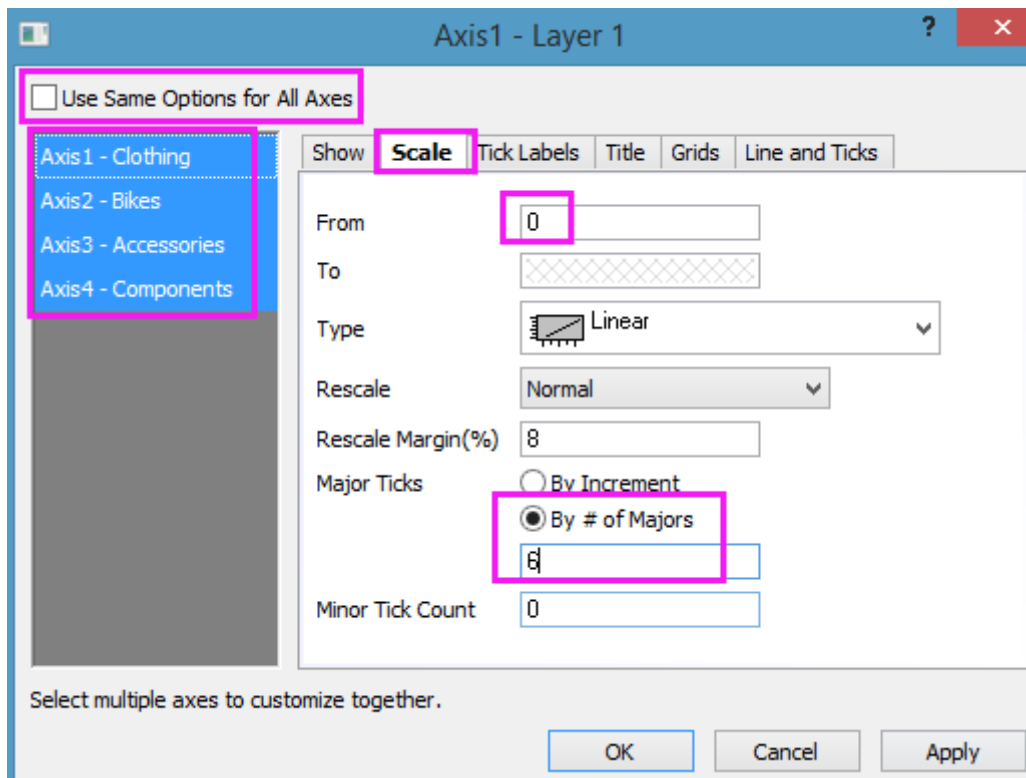

5. Still with Axis1 to Axis4 selected on the left, go to **Tick Labels** tab. **Before Axis** is chosen in **Show Tick Labels**. Please expand the dropdown list and choose *Before Axis* again since we want to apply it to all Axes.
6. Set **Display** to *Decimal: 1000*, and **Divide by Factor** to 1000000 (one million). Click **Apply** button.



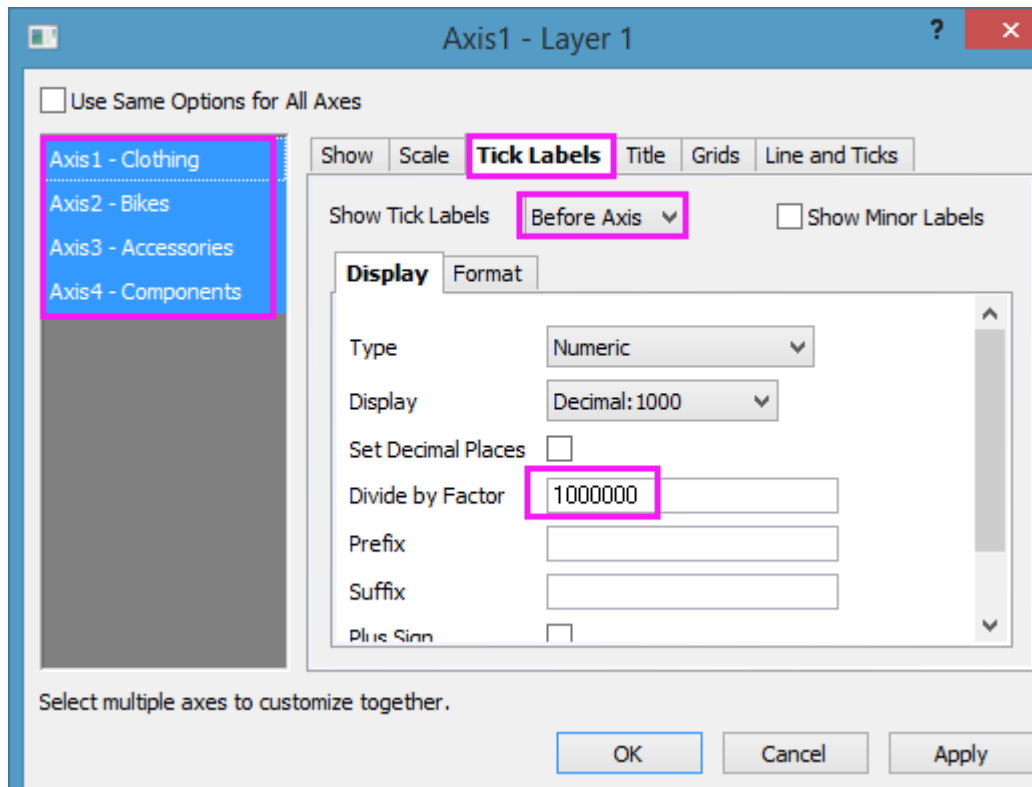

7. Now go back to **Scale** tab. Select **Axis1 - Clothing** only on the left and change **To** value to *1.5*. Repeat this operation for **Axis3 - Accessories** and **Axis4 - Components**, with values of *0.7* and *6* respectively. Note: because Divide by Factor was set to 1000000 in the previous step, it's much easier to type the To value now.
8. Click **OK** button.

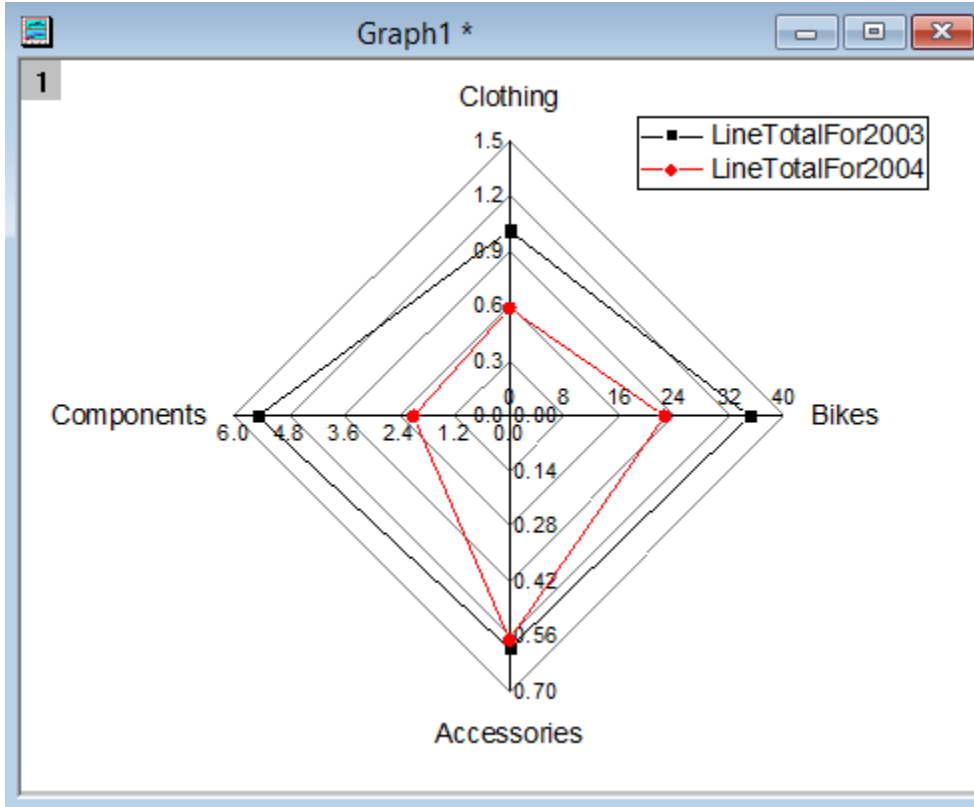

We can see that, for all four categories, line totals for 2004 is bigger than that for 2003. And Bikes is the biggest.

### 9.3.4 SQL Editor for Database Analysis

#### 9.3.4.1 Summary

Origin supports importing data from many popular databases using ADO or ODBC. Once the data is in, Origin's data filtering and analysis features allow you to set up an Analysis template. This tutorial illustrate how to setup such an analysis template and use it to import data from database with updated analysis result.

The SQL database we use here is [AdventureWorks database](#). For detailed information of how to attach an AdventureWorks database, please refer to [CodePlex website](#).

Minimum Origin Version Required: Origin 9.0 SR0

#### 9.3.4.2 What you will learn

This tutorial will show you how to:

- Use SQL Editor to import data from database for a specific year.
- Add column filter to only show products of interest.
- Create a pivot table for total cost of different products in different countries.
- Plot column graph to visualize the result.

- Insert the graph into the worksheet as a floating graph and save such self-contained workbook as analysis template.
- Load the analysis template and change the SQL query, reimport database to do analysis for another year.

#### 9.3.4.3 Steps

Suppose we have already set up a SQL server named *AdventureWorks2008* on a server machine *noho*.

##### 9.3.4.3.1 Import Data from Database

1. Start a new project. Open SQL Editor by clicking the **Open SQL Editor** button on the **Database Access** toolbar.

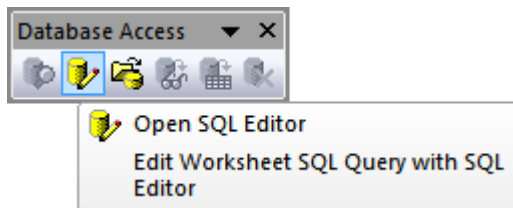

2. Select **File: Edit Connection String...** menu and put the connection string below to the text box.

```

Provider=SQLOLEDB.1;

Password=labtalk2015;

Persist Security Info=TRUE;

USER ID=CONNECT;

Initial Catalog=AdventureWorks2008;

DATA SOURCE=noho

```

3. Click the **Test** button to test if the connection is fine. If fine, click the **OK** button to connection to the database.
4. Copy and paste the following query into the SQL Editor text box. The query shows data for the year 2003:

```
SELECT CR.Name AS CustomerCountry,

       Pr.Name AS ProductName,

       Pr.Color AS ProductColor,

       PC.Name AS ProductCategory,

       PS.Name AS ProductSubcategory,

       SOH.OrderDate AS OrderDate,

       SOD.OrderQty AS OrderAmount,

       SOD.LineTotal AS TotalCost

FROM Person.CountryRegion AS CR

INNER JOIN Person.StateProvince AS SP

ON SP.CountryRegionCode = CR.CountryRegionCode

INNER JOIN Person.Address AS A

ON A.StateProvinceID = SP.StateProvinceID

INNER JOIN Person.BusinessEntityAddress AS BEA

ON BEA.AddressID = A.AddressID

INNER JOIN Person.Person AS P

ON P.BusinessEntityID = BEA.BusinessEntityID

INNER JOIN Sales.PersonCreditCard AS PCC

ON PCC.BusinessEntityID = P.BusinessEntityID

INNER JOIN Sales.SalesOrderHeader AS SOH

ON SOH.CreditCardID = PCC.CreditCardID
```

```

INNER JOIN Sales.SalesOrderDetail AS SOD

ON SOD.SalesOrderID = SOH.SalesOrderID

INNER JOIN Production.Product AS Pr

ON Pr.ProductID = SOD.ProductID

INNER JOIN Production.ProductSubcategory AS PS

ON PS.ProductSubcategoryID = Pr.ProductSubcategoryID

INNER JOIN Production.ProductCategory AS PC

ON PC.ProductCategoryID = PS.ProductCategoryID

WHERE SOH.OrderDate BETWEEN '1/1/2003' AND '12/31/2003'
    
```

5. Click the preview button to view the data the query produced in the bottom panel.

The screenshot shows the SQL Editor interface with a query window and a preview window. The query window contains the following SQL code:

```

INNER JOIN Sales.SalesOrderHeader AS SOH
ON SOH.CreditCardID = PCC.CreditCardID
INNER JOIN Sales.SalesOrderDetail AS SOD
ON SOD.SalesOrderID = SOH.SalesOrderID
INNER JOIN Production.Product AS Pr
ON Pr.ProductID = SOD.ProductID
INNER JOIN Production.ProductSubcategory AS PS
ON PS.ProductSubcategoryID = Pr.ProductSubcategoryID
INNER JOIN Production.ProductCategory AS PC
ON PC.ProductCategoryID = PS.ProductCategoryID
WHERE SOH.OrderDate BETWEEN '1/1/2003' AND
    
```

The preview window displays the following data:

No.	CustomerCountry	ProductName	ProductColor	ProductCategory	F
1	Germany	Road-250 Black, 48	Black	Bikes	Rc
2	France	Road-250 Black, 48	Black	Bikes	Rc
3	United States	Road-550-W Yellow, 42	Yellow	Bikes	Rc
4	Australia	Road-250 Red, 48	Red	Bikes	Rc
5	United States	Mountain-200 Silver, 38	Silver	Bikes	Mt
6	United States	Road-650 Black, 52	Black	Bikes	Rc
7	United States	Road-650 Red, 44	Red	Bikes	Rc
8	Australia	Road-550-W Yellow, 40	Yellow	Bikes	Rc

- In the SQL Editor dialog, click **File: Save to Active Worksheet** menu to save database connection and query to the active worksheet. Close the SQL Editor.
- Click **Import data** button to import data into worksheet. The icon on the top left of the workbook indicates the sheet contains an SQL query.

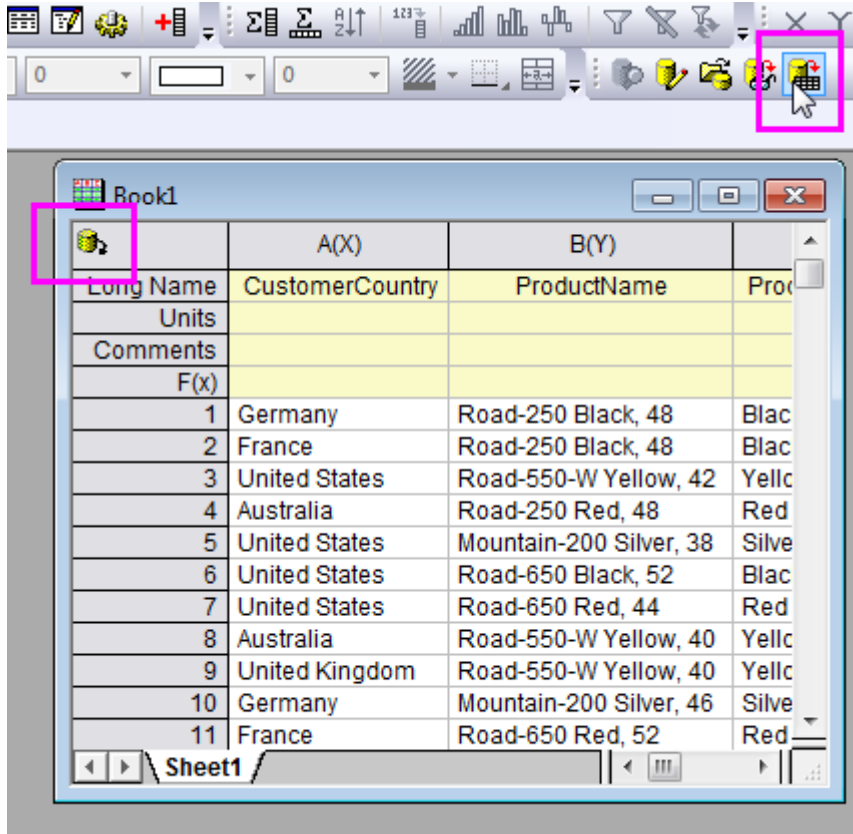

### 9.3.4.3.2 Filter Data

- Origin has a data filter feature similar to Excel. We can use this feature to choose specific data for graphing and analysis without removing the rest of the data.
- Select *column E* (Long Name: Product Subcategory). In order to choose just the bike data for analysis, add a data filter to this column by clicking the **Add/Remove data filter** button on the **Worksheet Data** toolbar.

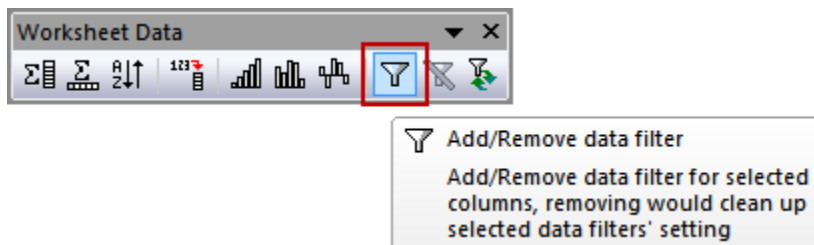

3. A filter icon will appear on the top left corner of the column header. Click on it, and from the list that appears, uncheck *Select All* and then select *Mountain Bikes*, *Road Bikes* and *Touring Bikes*.

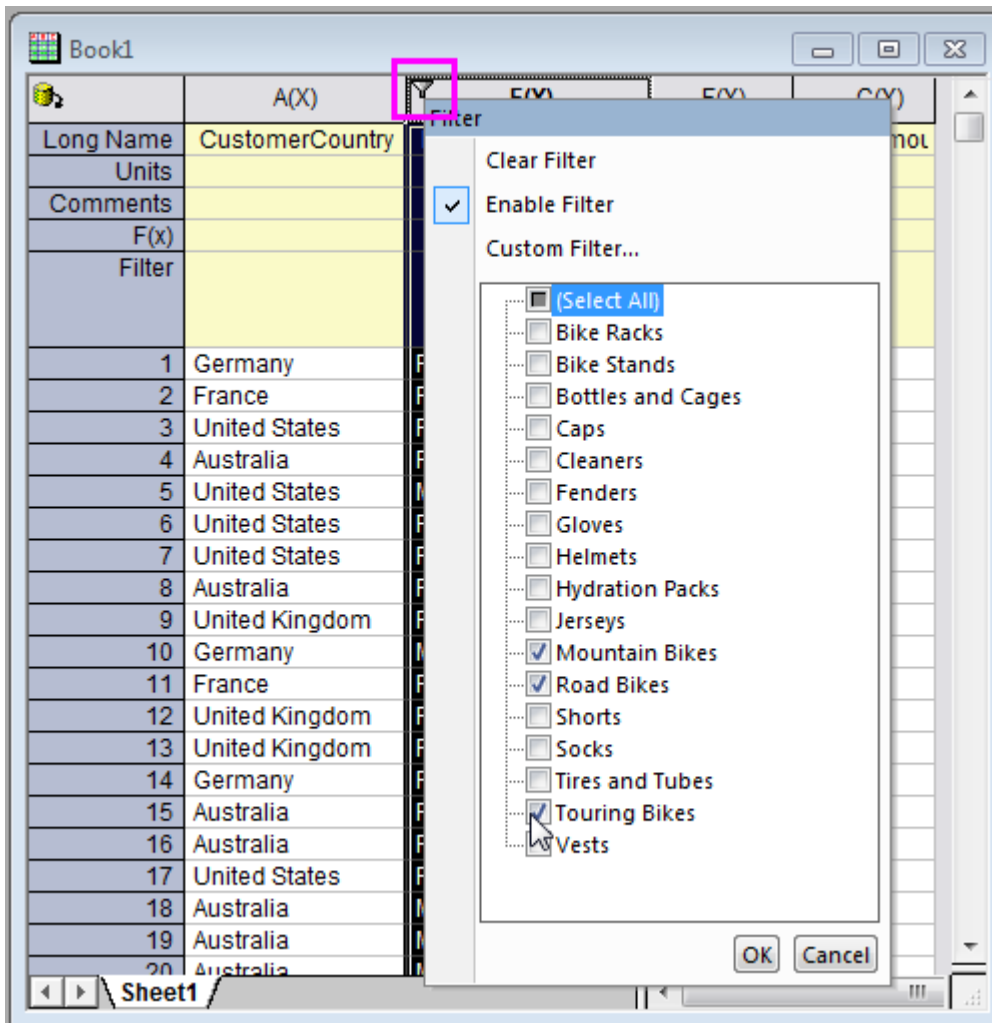

4. If a reminder message about hidden data appears, select the **Yes** radio button and click **OK**.
5. The sheet will now show data for just those 3 bike types.

#### 9.3.4.3.3 Create Pivot Table and Plot Column Graph

1. We can create a pivot table to see total costs of each bike type in different countries.
2. With nothing selected in worksheet, select **Worksheet: Pivot Table: Open Dialog...**
3. In the dialog that opens set the **Row Source** as *CustomerCountry*.
4. Set the **Column Source** as *ProductSubcategory* (the column with the filter on it).
5. In order to see the Total Cost, set the **Summarize by** option as **Sum**, and set the **Pivot Table Data Source** option that appears as *TotalCost*.

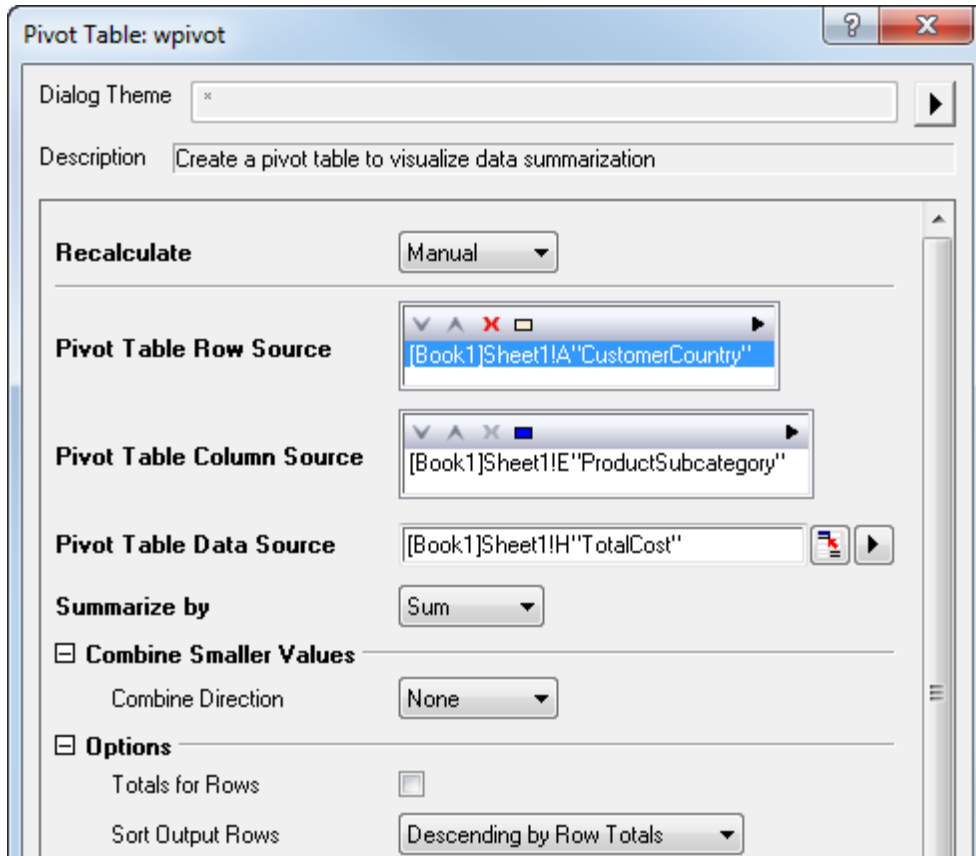

6. Click **OK**. A new worksheet is created named *Pivot1*.
7. Click on the green lock located on the top right of the first column and set the **Recalculate Mode: Auto** in the context menu. This will make the pivot table manipulation update if the data is re-imported from the SQL Editor.



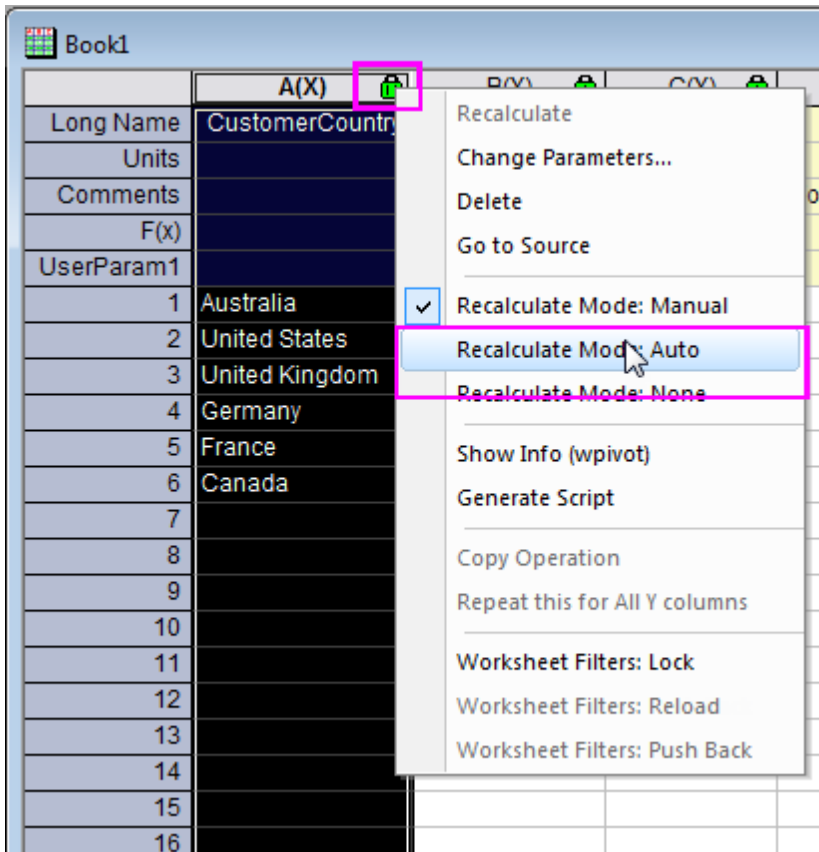

- Now highlight the pivoted data and click on the **Column Plot** button to create a column plot.

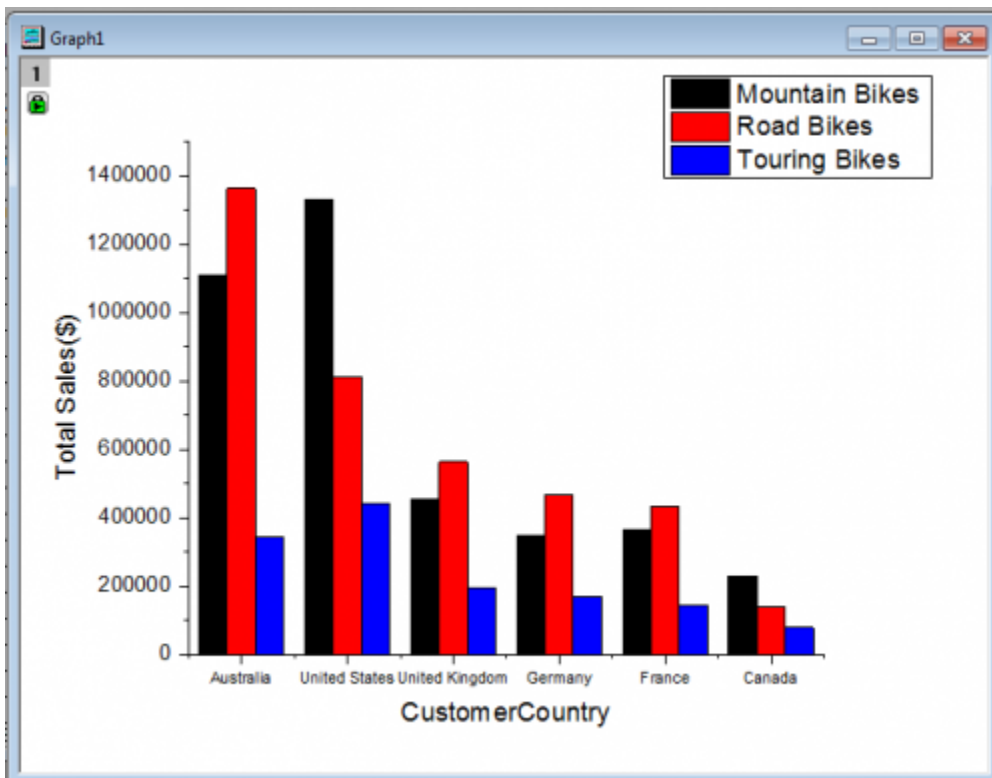

#### 9.3.4.3.4 Customize Graph and Create Analysis Template

1. Double click the Y axis title and set it as **Total Sales (\$)**
2. Double click on the Y Axis to open the **Axis** dialog.
3. On the Y axis **Scale** page, set the **Rescale** dropdown to **Auto**. Click OK.

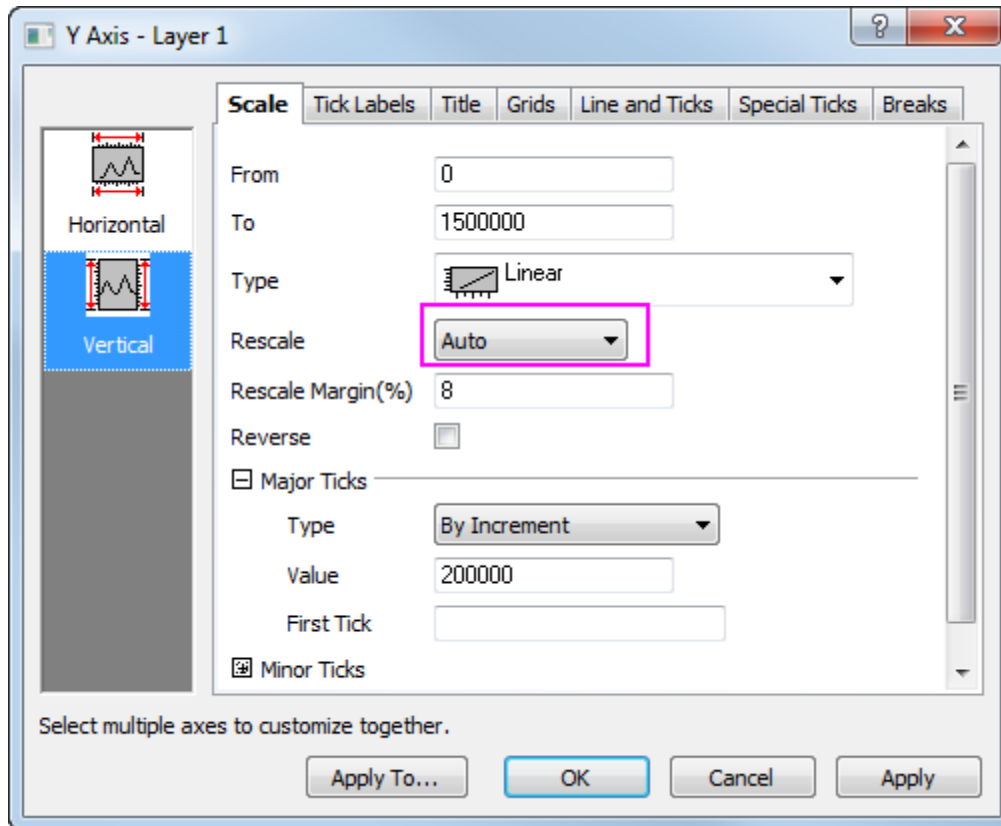

4. Right click on the graph and select **Add/Modify Layer Title** from the context menu. Set the Title as **Bike Sales by Year**. If needed, a year title can be added this way as well.

#### 9.3.4.3.5 Add Floating Graph in Worksheet and Save Analysis Template

1. Add the graph to the worksheet with the original data by right clicking gray area in worksheet and from the context menu selecting **Add Graph....**
2. In the **Graph Browser** dialog, select the graph and click **OK**. Resize and move as needed. If you need to customize the graph further, double click it to bring up the independent graph window again to customize. And then click the return button on graph window title to bring it back to worksheet.
3. workbook is self-contained with everything: database connection, data filtering, analysis (pivot table) and graph.
4. Choose **Worksheet: Clear Worksheet...** menu and choose Yes when prompt shows to clear data from workbook. Note: Usually saving analysis template will clear data automatically but for database connection, it doesn't happen automatically. So we need to do this step

- Choose **File: Save Workbook as Analysis Template...** or right click on the .worksheet title bar and select **Save as Analysis Template...** as shown below to save a template.

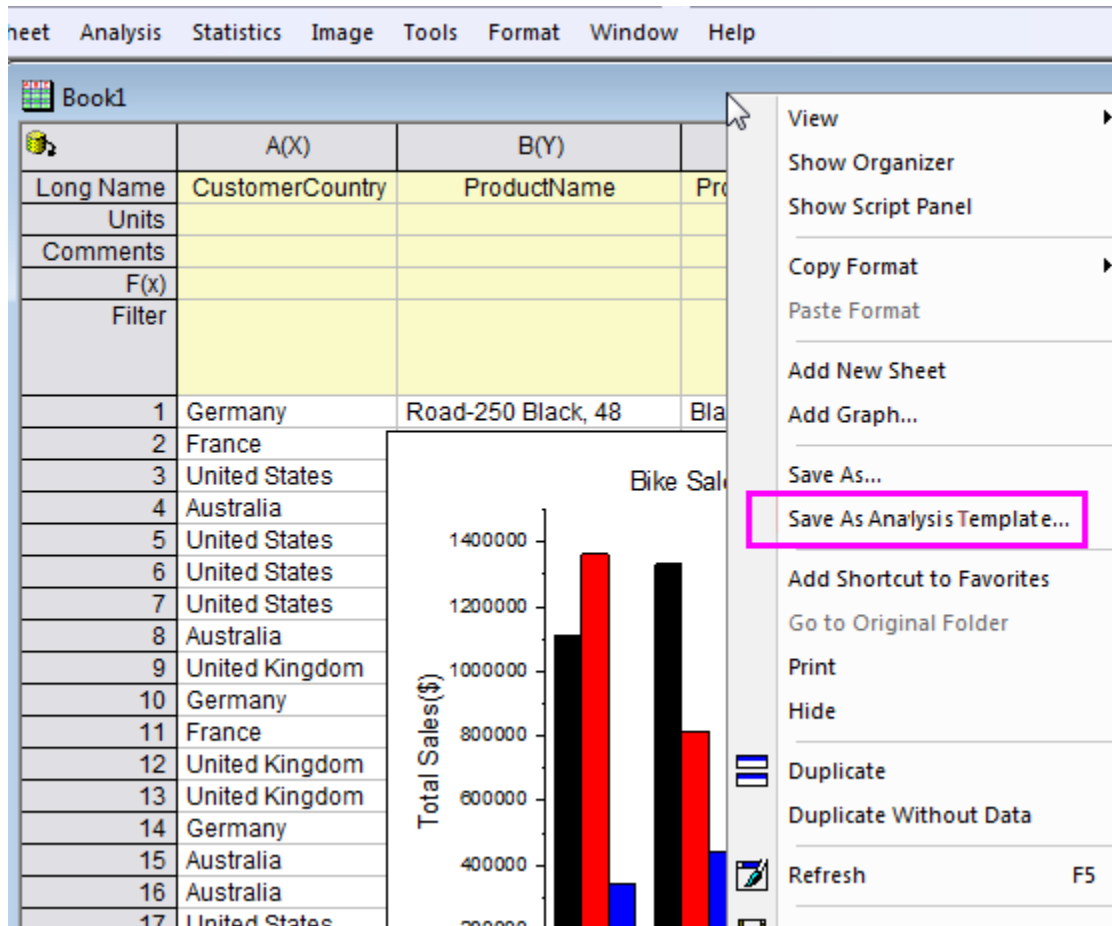

6.

### 9.3.4.3.6 Change Query and Re-import Data to Automatically Update Analysis

- Go to **File: Recent Books** menu to load the analysis template you just saved. This will open a blank analysis template workbook.

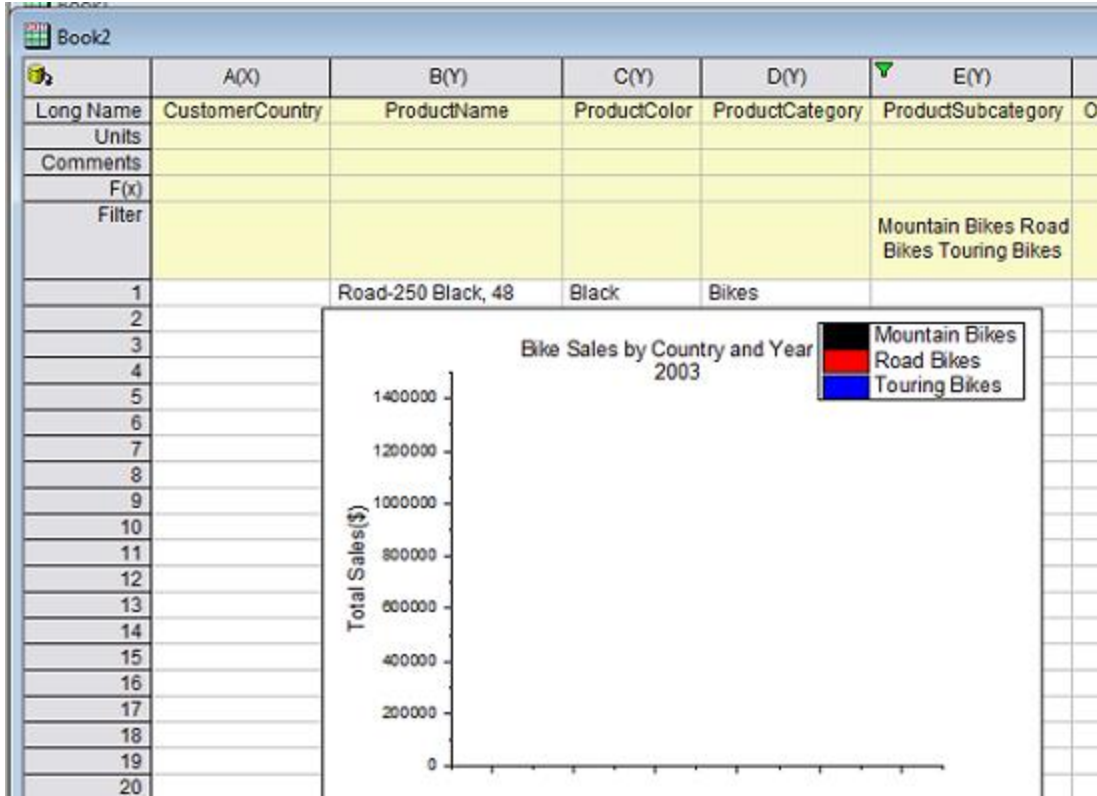



- Click on the **SQL Editor** button  to open the **SQL Editor** with SQL query loaded. Change it to show data for the year 2004 and then exit out of the Editor. Choose **Yes** to save the change SQL change in worksheet.

```

Sheet1*
etting Help

2008
'ersion
Log
ces.Department
ces.Employee
ces.EmployeeDep
ces.EmployeePay
ces.JobCandidate
ces.Shift

INNER JOIN Sales.SalesOrderHeader AS SOH
ON SOH.CreditCardID = PCC.CreditCardID
INNER JOIN Sales.SalesOrderDetail AS SOD
ON SOD.SalesOrderID = SOH.SalesOrderID
INNER JOIN Production.Product AS Pr
ON Pr.ProductID = SOD.ProductID
INNER JOIN Production.ProductSubcategory AS PS
ON PS.ProductSubcategoryID = Pr.ProductSubcategoryID
INNER JOIN Production.ProductCategory AS PC
ON PC.ProductCategoryID = PS.ProductCategoryID
WHERE SOH.OrderDate BETWEEN '1/1/2004' AND '12/31/2004'
    
```

- Re-import the data by clicking the **Import Data** button  on **Database Access** toolbar.
- and reapply the filter with the **Reapply data filter** :  button.

5. All the data will update. The graph now shows the Bike Sales for the year 2004, and the year title has changed to reflect this.
6. Your project now has two books; *Book1* has the data for the year 2003, *Book2* has the data for the year 2004.

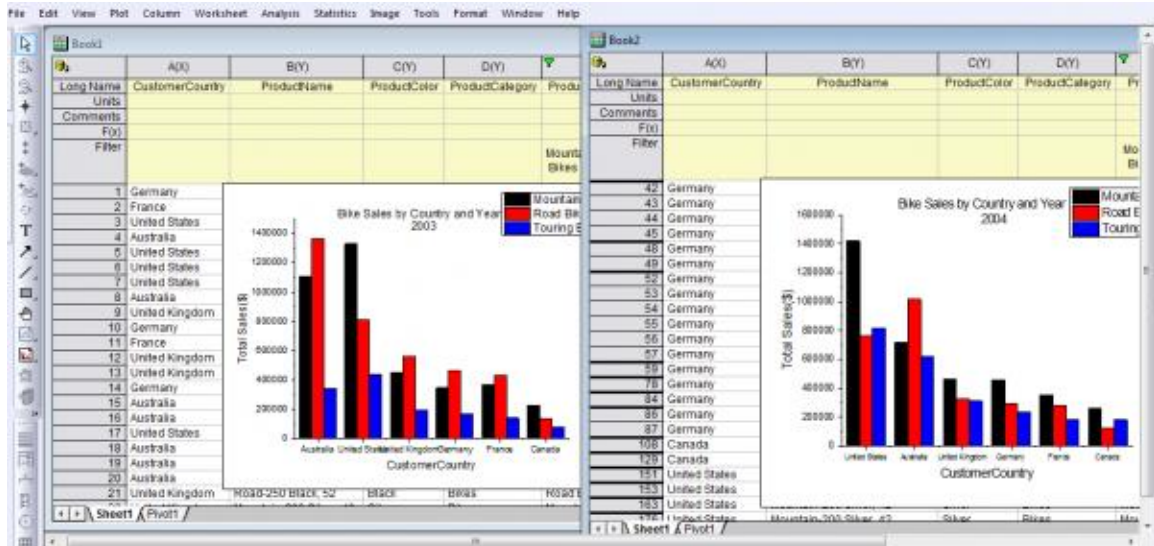

7. You can use this template and the SQL re-import feature to find the Bike sales for as many years as needed just by adjusting the year range in SQL Editor and reimport.

### 9.3.5 Update Database Importing By LabTalk Substitution

#### 9.3.5.1 Summary

This tutorial shows how to import data from database into Origin worksheet by using SQL Editor with LabTalk substitution. And then make a column plot for the imported data. Then update the worksheet data and the plot by changing the defined LabTalk variables.

The SQL database we use here is [AdventureWorks database](#). For detailed information of how to attach an AdventureWorks database, please refer to [CodePlex website](#).

Minimum Origin Version Required: Origin 8.5.1 SR0

#### 9.3.5.2 What you will learn

This tutorial will show you how to:

- Import data using SQL Editor.
- Use LabTalk substitution in SQL statement.
- Make column plot.
- Update database importing by LabTalk substitution.

#### 9.3.5.3 Steps

Suppose we have already set up a SQL server named *AdventureWorks2008* on a server machine *noho*.

### 9.3.5.3.1 Import Data from Database and Make Column Plot

1. Start a new project. Open SQL Editor by clicking the **Open SQL Editor** button on the **Database Access** toolbar.

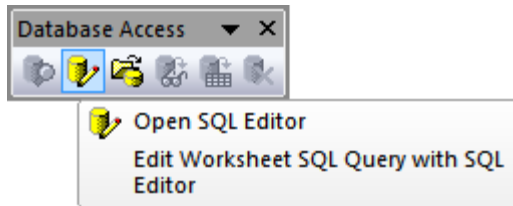

2. Select **File: Edit Connection String...** menu and put the connection string below to the text box.

```
Provider=SQLOLEDB.1;  
  
Password=labtalk2015;  
  
Persist Security Info=TRUE;  
  
USER ID=CONNECT;  
  
Initial Catalog=AdventureWorks2008;  
  
DATA SOURCE=noho
```

3. Click the **Test** button to test if the connection is fine. If fine, click the **OK** button to connection to the database.
4. Select **Query: LabTalk...** menu in SQL Editor to open **LabTalk Support Settings** dialog. In this dialog, check the **Enable LabTalk (%,\$) Substitution** checkbox, and then put the following LabTalk script to **Before Query Script** textbox.

```
string myStartDate$ = "1/1/2003"; // For the first date substitution  
  
string myEndDate$ = "12/31/2003"; // For the second date substitution  
  
string myStrName$ = "LineTotalFor2003"; // For the name
```

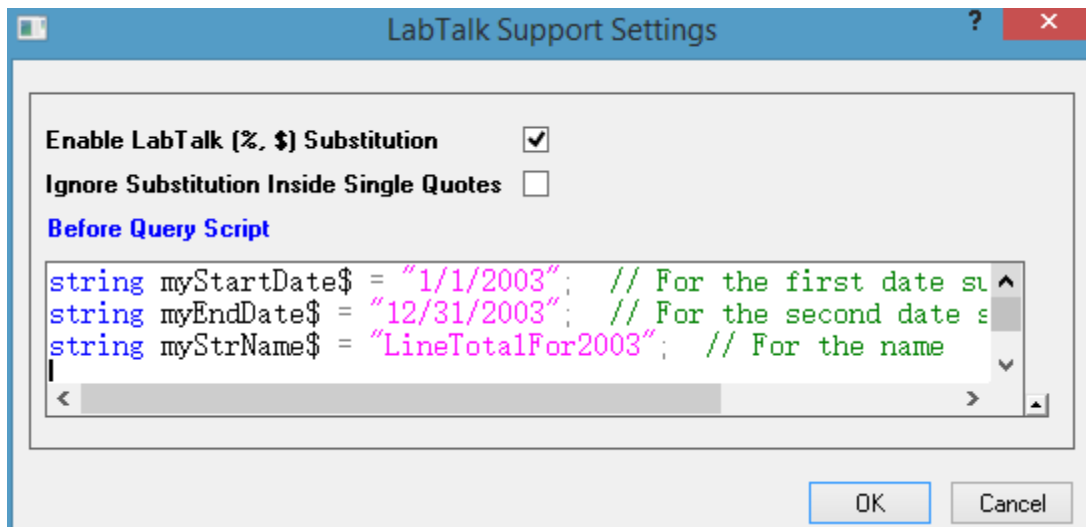

5. Click OK to go back SQL Editor. In the right text box, put the following SQL statements.

```

SELECT Production.ProductCategory.Name, LINETOALANDNAMEYEAR.%(myStrName$)
FROM

        (SELECT SUM(SALEANDPRODUCTYEAR.LineTotal) AS
%(myStrName$), Production.ProductSubcategory.ProductCategoryID

        FROM

                (SELECT SALEINFOYEAR.LineTotal,
PRODUCTINFOYEAR.ProductSubcategoryID

        FROM

                (SELECT Sales.SalesOrderHeader.OrderDate,
Sales.SalesOrderDetail.LineTotal, Sales.SalesOrderDetail.ProductID

        FROM Sales.SalesOrderHeader

        INNER JOIN Sales.SalesOrderDetail

        ON

Sales.SalesOrderHeader.SalesOrderID=Sales.SalesOrderDetail.SalesOrderID

```

```

WHERE Sales.SalesOrderHeader.OrderDate
BETWEEN '%(myStartDate$)' AND '%(myEndDate$)' ) AS SALEINFOYEAR

INNER JOIN

(SELECT Production.Product.ProductID,
Production.Product.ProductSubcategoryID

FROM Production.Product) AS
PRODUCTINFOYEAR

ON
SALEINFOYEAR.ProductID=PRODUCTINFOYEAR.ProductID) AS SALEANDPRODUCTYEAR

INNER JOIN Production.ProductSubcategory

ON
SALEANDPRODUCTYEAR.ProductSubcategoryID=Production.ProductSubcategory.ProductSubcategoryID

GROUP BY Production.ProductSubcategory.ProductCategoryID)
AS LINETOALANDNAMEYEAR

INNER JOIN Production.ProductCategory

ON
LINETOALANDNAMEYEAR.ProductCategoryID=Production.ProductCategory.ProductCategoryID

```



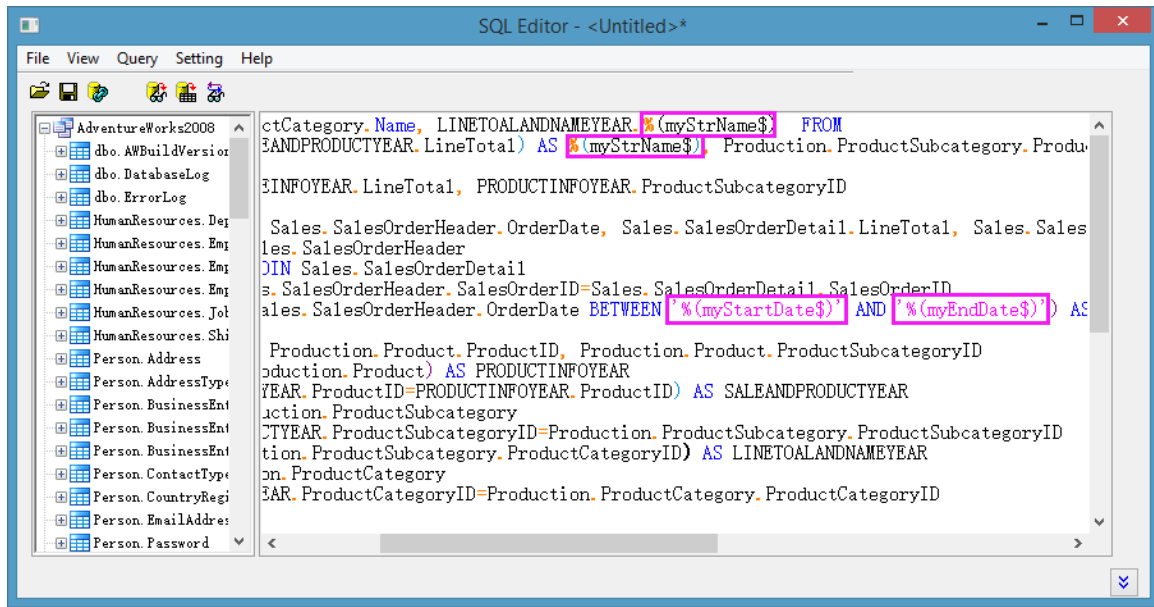

As we can see that there are three LabTalk variables are used in the statements.

- Just click the last button  on the toolbar, we can see the substitutions.

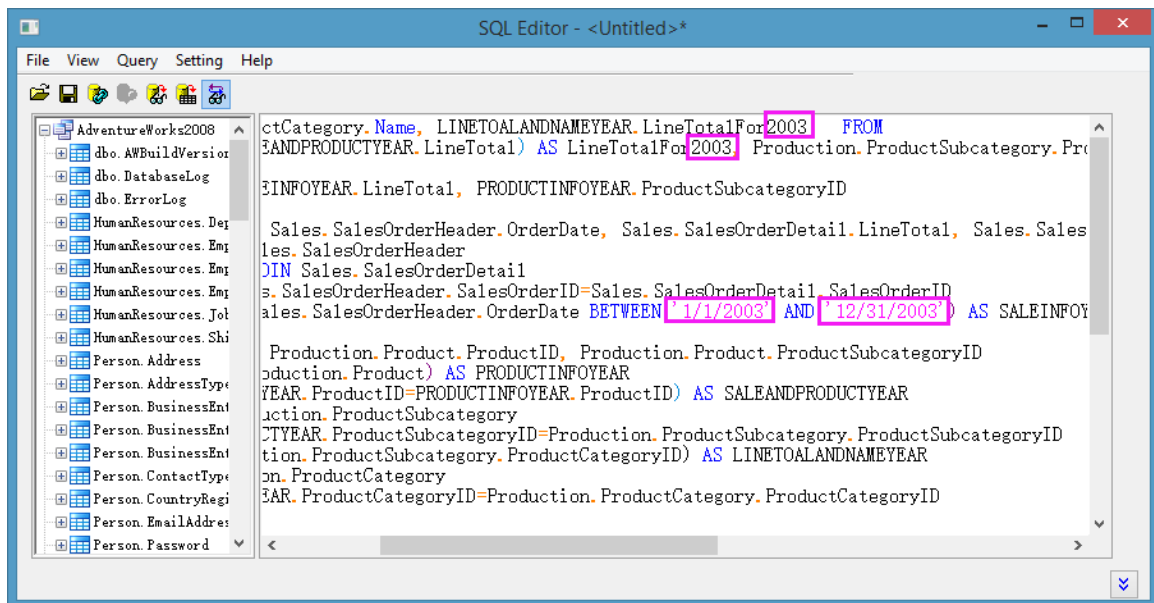

- Select menu **File: Save to Active Worksheet** to save these settings to the worksheet, and then click the

**Import data to worksheet** button  to import the data into worksheet.

- Close SQL Editor. We can see the imported data form the image below. The Long Name for column B is "LineTotalFor2003", which is set in the LabTalk variable.

	A(X)	B(Y)
Long Name	Name	LineTotalFor2003
Units		
Comments		
F(x)=		
1	Bikes	3.49233E7
2	Components	5.48551E6
3	Clothing	1.01198E6
4	Accessories	590257.58519
5		
6		

- Highlight column B from the worksheet, then select menu **Plot: Column/Bar/Pie: Column** to make a column plot.

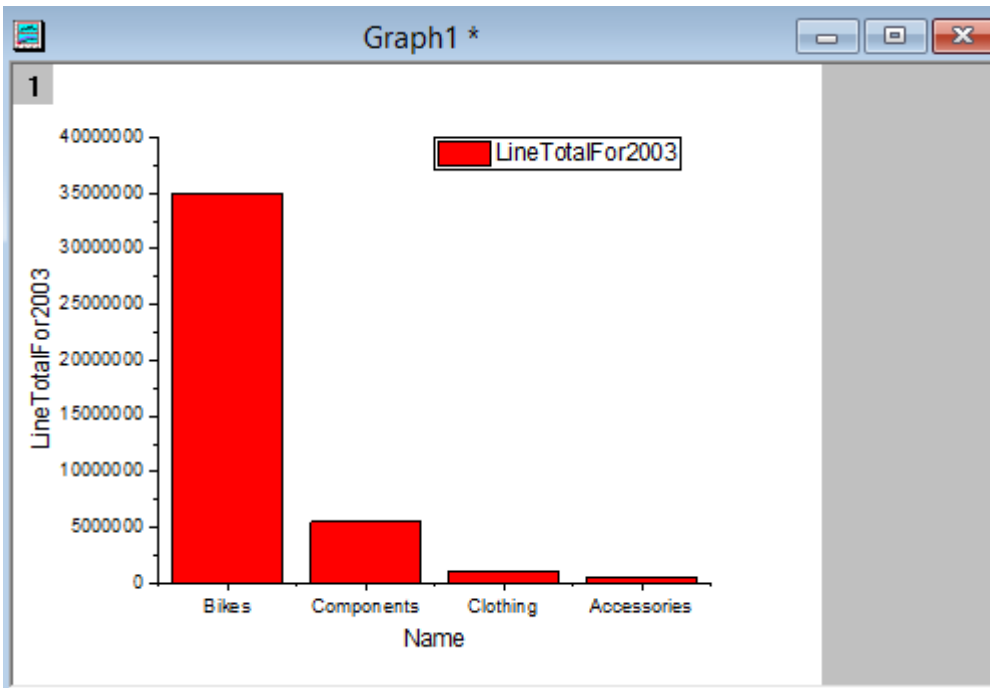

### 9.3.5.3.2 Update Database Importing By LabTalk Substitution

LabTalk variables *myStartDate\$*, *myEndDate\$*, and *myStrName\$* are used to control which year's data will be imported from database. One way to import data of another year is by modifying these variable values in **LabTalk Support Settings** dialog.

- Activate the worksheet with data from database above. Click **Open SQL Editor** button  and SQL Editor opens again, with the saved settings.
- Select menu **Query: LabTalk** to open **LabTalk Support Settings** dialog. Now, change the values of these three variables: *myStartDate\$*, *myEndDate\$*, and *myStrName\$*.

```
string myStartDate$ = "1/1/2004"; // For the first date substitution

string myEndDate$ = "12/31/2004"; // For the second date substitution

string myStrName$ = "LineTotalFor2004"; // For the name
```

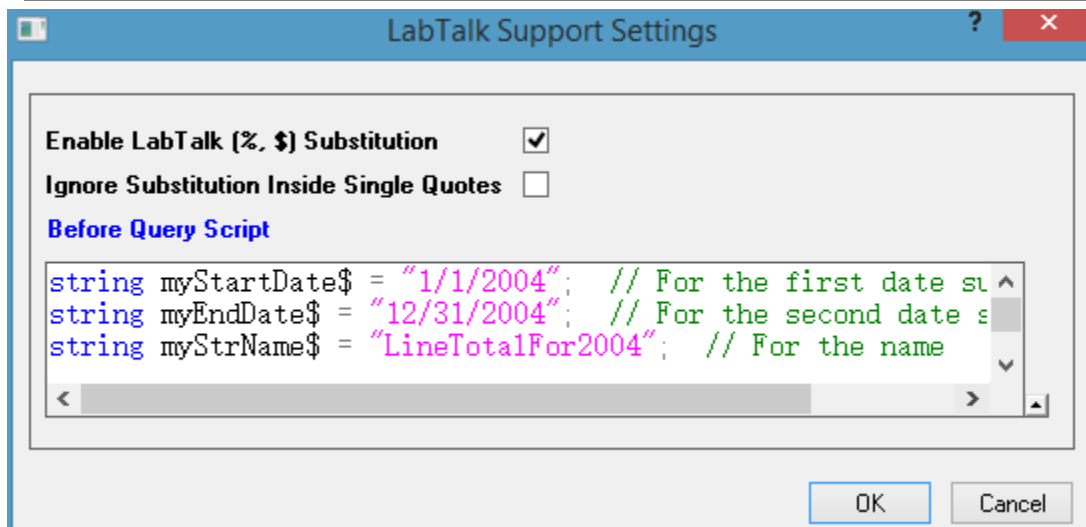

3. Click OK to go back to SQL Editor. Click **Save Query Settings** button and then click the **Import data to**

**worksheet** button . Close SQL Editor.

4. Now we can see that the data in worksheet and graph are updated.

	A(X)	B(Y)
Long Name	Name	LineTotalFor2004
Units		
Comments		
F(x)=		
1	Bikes	2.25798E7
2	Components	2.09151E6
3	Clothing	588594.53233
4	Accessories	568844.58241
5		
6		

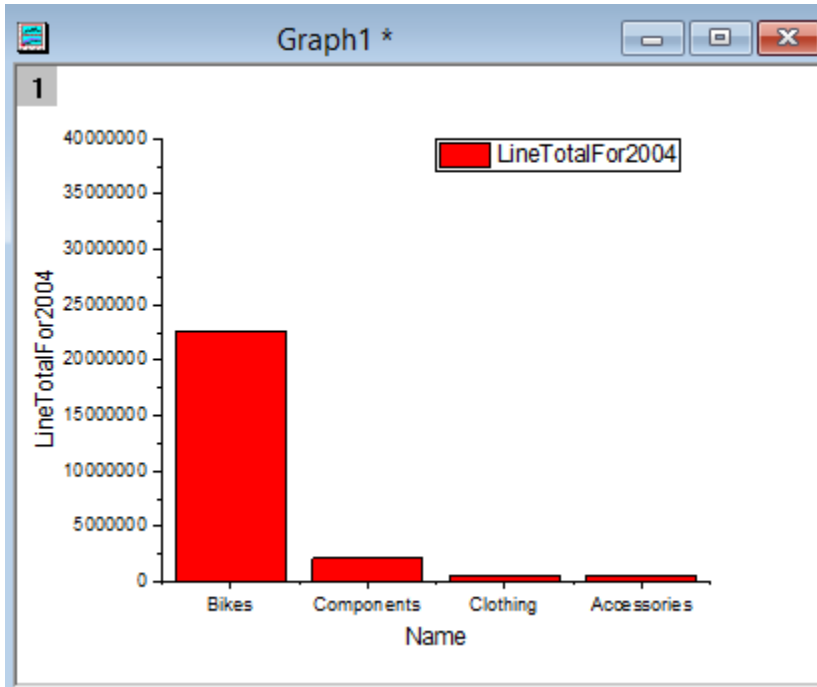

But you will need to open the SQL Editor dialog everytime to change the variable values which is not convenient. A nicer way is to modify the LabTalk Support Settings **to use global variables. Then we can modify the global variables outside SQL Editor and reimport.**

1. Let's activate worksheet again and click  to open **SQL Editor**.
2. Choose **Query: LabTalk...** menu and modify the LabTalk Support Settings as follows.

```
string myStartDate$ = ""; // For the first date substitution

string myEndDate$ = ""; // For the second date substitution

string myStrName$ = ""; // For the name

if(exist(startDate$, 18) == 18) // if startDate$ exists or not

{

    myStartDate$ = startDate$; // if yes, use it as myStartDate$

}
```

```
else
{
    myStartDate$ = "1/1/2003"; // if no, use 1/1/2003 as myStartDate$
}

if(exist(endDate$, 18) == 18) // if endDate$ exists or not
{
    myEndDate$ = endDate$; // if yes, use it as myEndDate$
}
else
{
    myEndDate$ = "12/31/2003"; // if no, use 12/31/2003
}

if(exist(strName$, 18) == 18) // if strName$ exists
{
    myStrName$ = strName$; // if yes, use it as strName$
}
else
{
    myStrName$ = "LineTotalFor2003"; // if not, useLineTotalFor2003
as strName$
}
}
```

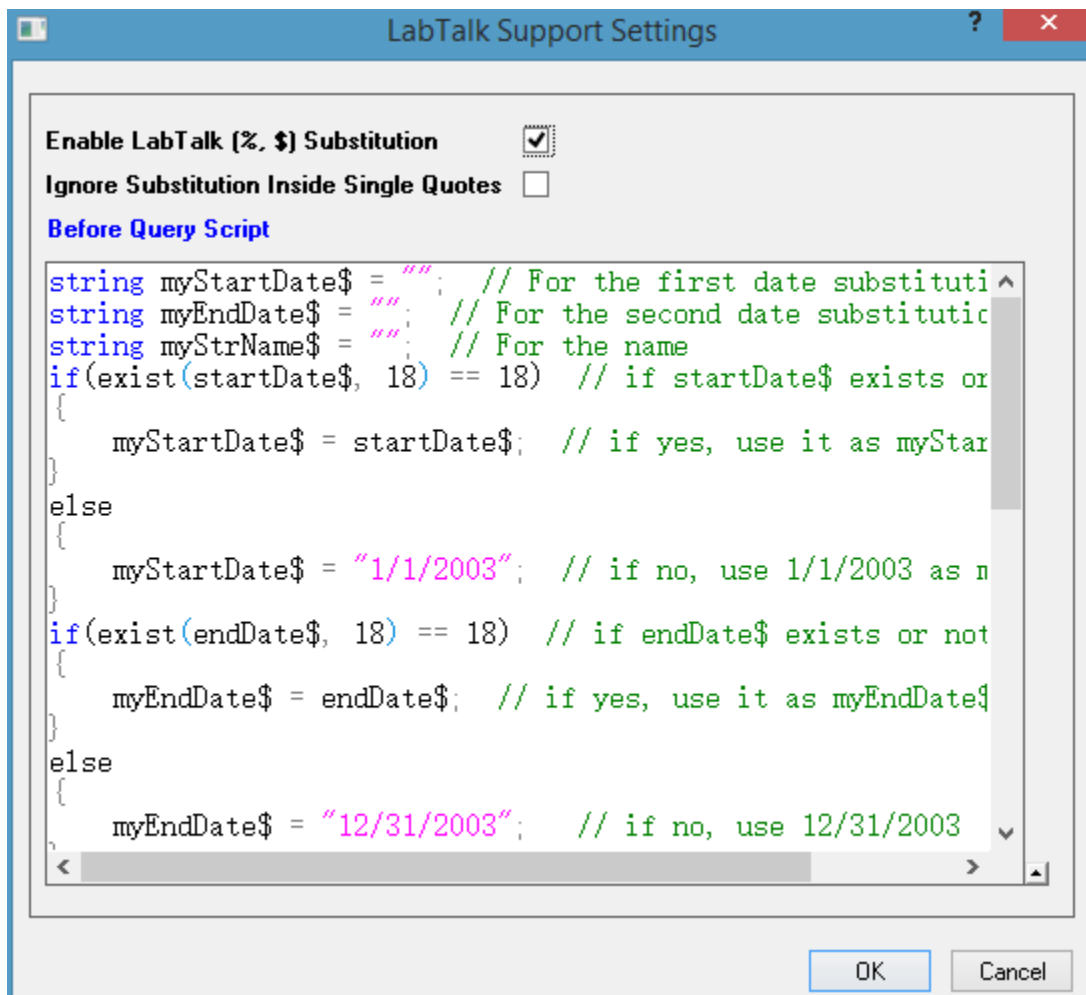

3. Click **Save Query Settings** button in **SQL Editor** and close it.
4. Select **Window: Script Window** menu to open Script Window.
5. Run the following script by pasting them into Script window, highlighting them and then pressing ENTER keyboard.

```
string startDate$ = "1/1/2003"; //define startDate$ string variable

string endDate$ = "12/31/2004"; //define endDate$ string variable

string strName$ = "LineTotalFor2003and2004"; //define strName string
variable

dbimport; //import data from database
```

- The data in worksheet and graph are updated.

Note:

- Three "global" LabTalk variables are defined here. Here "global" means the LabTalk variables can be "seen" and used by SQL Editor for the substitutions.
- The last *dbimport* LabTalk command is the same as clicking the **Import data** button  on **Database Access** toolbar.

### 9.3.6 Update Graph By Reimport Data From Database

#### 9.3.6.1 Summary

This tutorial demonstrate how to import data from database and do analysis and graphing with data, then add a button in graph to update database query and reimport data using Origin's labtalk script.

The SQL database we use here is [AdventureWorks database](#). For detailed information on how to attach an AdventureWorks database, please refer to [CodePlex website](#).



Steps in the tutorial are only illustrative of what users could be doing with your database locally. Please don't follow to test.

#### 9.3.6.2 What you will learn

This tutorial will show you how to:

- Import data from database with LabTalk variables in the SQL query to define date range of the query.
- Create pivot table and plot graph to analyze data.
- Add a button on the graph to modify date range of the query and reimport from database.

#### 9.3.6.3 Steps

**Suppose we have already set up a SQL server named *AdventureWorks2008* on a server machine *noho*.**

##### 9.3.6.3.1 Import Data from Database

- Start a new project. Open **SQL Editor** by clicking the **Open SQL Editor** button on the **Database Access** toolbar.

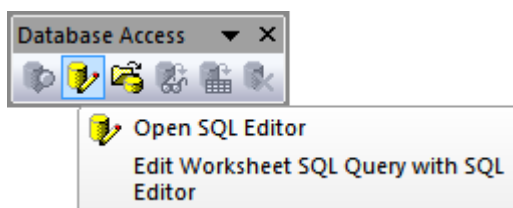

2. Select **File: Edit Connection String...** menu and put the connection string below to the text box.

```
Provider=SQLOLEDB.1;

Password=labtalk2015;

Persist Security Info=TRUE;

USER ID=CONNECT;

Initial Catalog=AdventureWorks2008;

DATA SOURCE=noho
```

3. Click the **Test** button to test if the connection is fine. If fine, click the **OK** button to connection to the database.
4. Select **Query: LabTalk...** menu in **SQL Editor** to open **LabTalk Support Settings** dialog. In this dialog, check the **Enable LabTalk (% , \$) Substitution** checkbox, and put the following script to the text box.

```
string pastFrom$ = "";

string pastTo$ = "";

string curFrom$ = "";

string curTo$ = "";

if(exist(strPast1$, 18) == 18) // Check if strPast1$ has value

{

    // If strPast1$ has value

    pastFrom$ = strPast1$; // Assign strPast1$ to pastFrom$

}
```



```
else // If strPast1$ is not defined

{

    pastFrom$ = "1/1/2003"; // Assign a const string to pastFrom$

}

if(exist(strPast2$, 18) == 18)

{

    pastTo$ = strPast2$;

}

else

{

    pastTo$ = "3/31/2003";

}

if(exist(strCurrent1$, 18) == 18)

{

    curFrom$ = strCurrent1$;

}

else

{

    curFrom$ = "4/1/2003";

}

if(exist(strCurrent2$, 18) == 18)
```

```

{
    curTo$ = strCurrent2$;
}

else
{
    curTo$ = "6/30/2003";
}

```

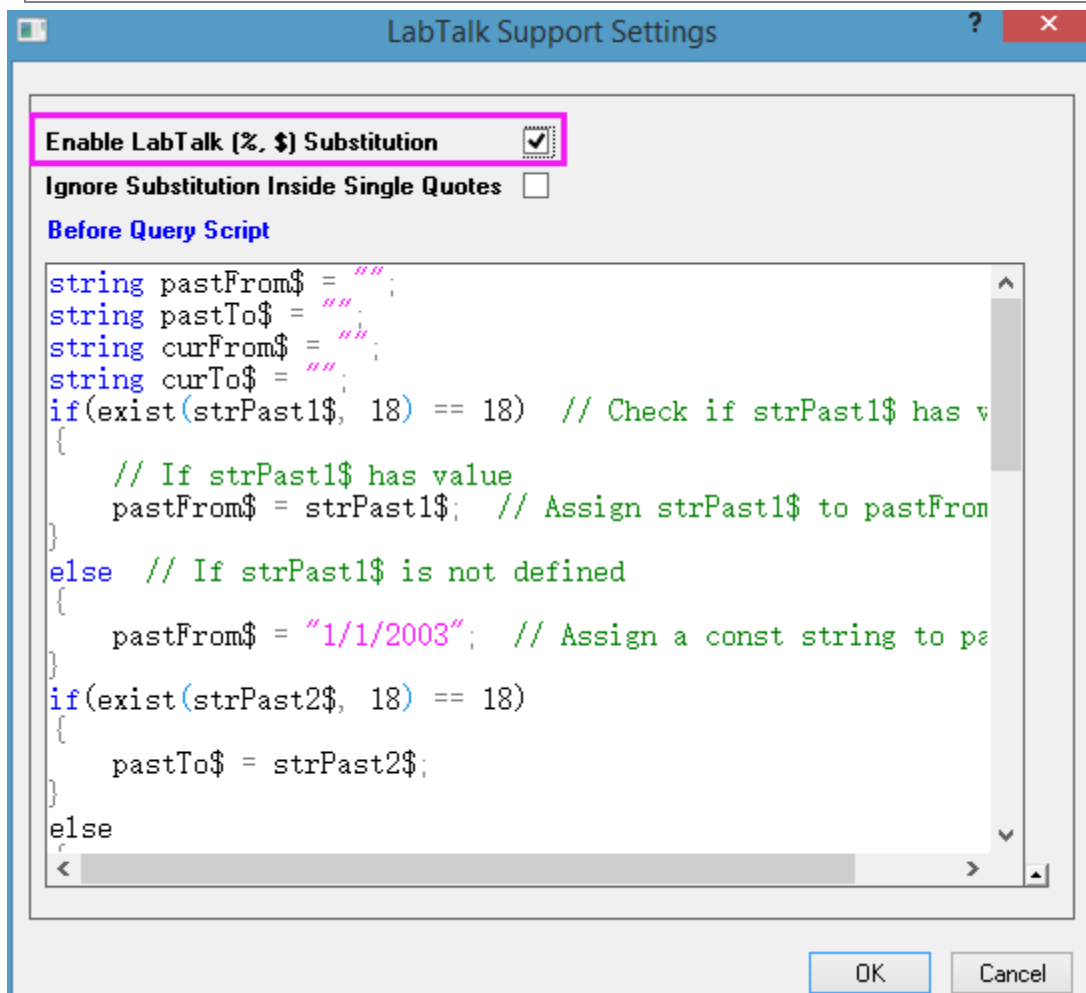

5. Click OK to go back SQL Editor. In the right text box, put the following SQL statements.

```

SELECT OrderDateTotalDueAndProductSubcategoryID.OrderDate AS 'Order Date',
'Date Range' =

        CASE

                WHEN OrderDateTotalDueAndProductSubcategoryID.OrderDate <
'%(curFrom$)' THEN 'Past'

                ELSE 'Current'

        END,

Production.ProductSubcategory.Name AS 'Subcategory Name',

OrderDateTotalDueAndProductSubcategoryID.TotalDue AS 'Total Due'

FROM

        (SELECT OrderDateAndTotalDue.OrderDate,
OrderDateAndTotalDue.TotalDue, Production.Product.ProductSubcategoryID

        FROM

                (SELECT Sales.SalesOrderHeader.OrderDate,
Sales.SalesOrderDetail.ProductID, Sales.SalesOrderHeader.TotalDue

                FROM Sales.SalesOrderHeader

                INNER JOIN Sales.SalesOrderDetail

                ON

Sales.SalesOrderHeader.SalesOrderID=Sales.SalesOrderDetail.SalesOrderID

                WHERE (Sales.SalesOrderHeader.OrderDate BETWEEN
'%(pastFrom$)' AND '%(pastTo$)'

                        OR Sales.SalesOrderHeader.OrderDate
BETWEEN '%(curFrom$)' AND '%(curTo$)')) AS OrderDateAndTotalDue

```

```

INNER JOIN Production.Product

ON OrderDateAndTotalDue.ProductID=Production.Product.ProductID) AS
OrderDateTotalDueAndProductSubcategoryID

INNER JOIN Production.ProductSubcategory

ON
OrderDateTotalDueAndProductSubcategoryID.ProductSubcategoryID=Production.P
roductSubcategory.ProductSubcategoryID
    
```

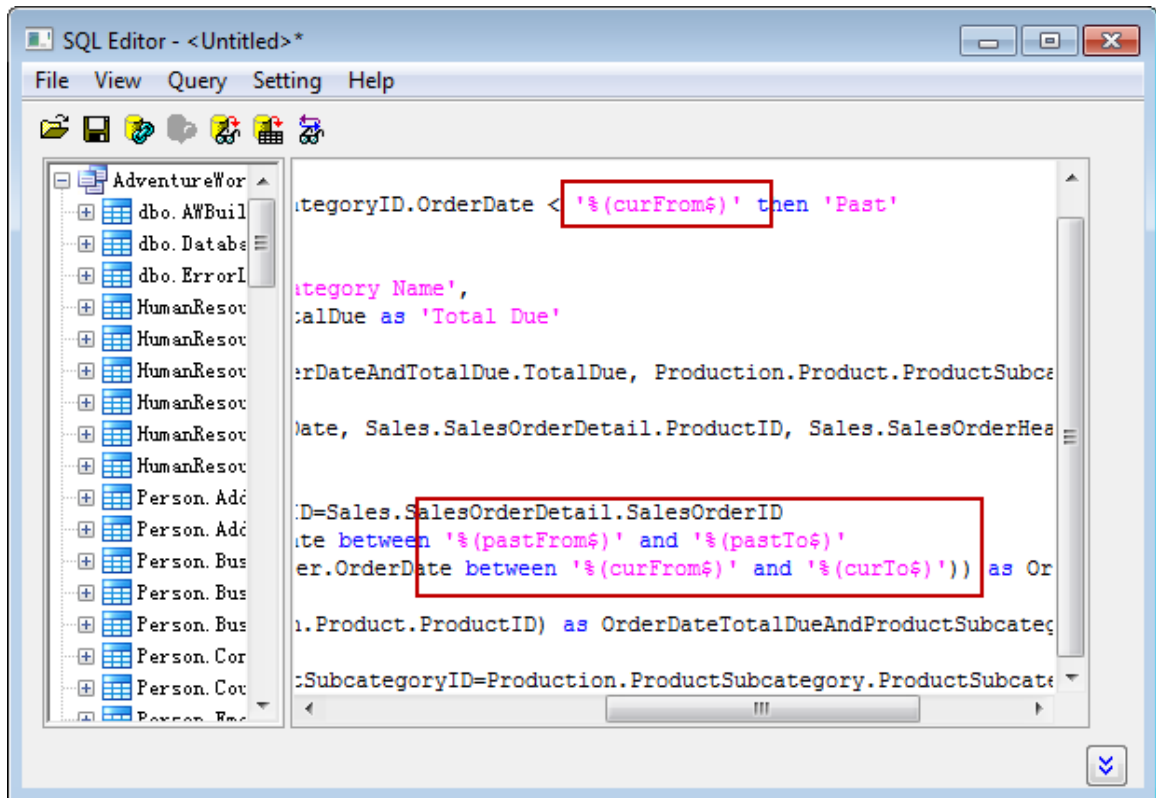

As we can see that there are three LabTalk variables are used in the statements.

6. Click the last button on the toolbar, we can see the substitutions.

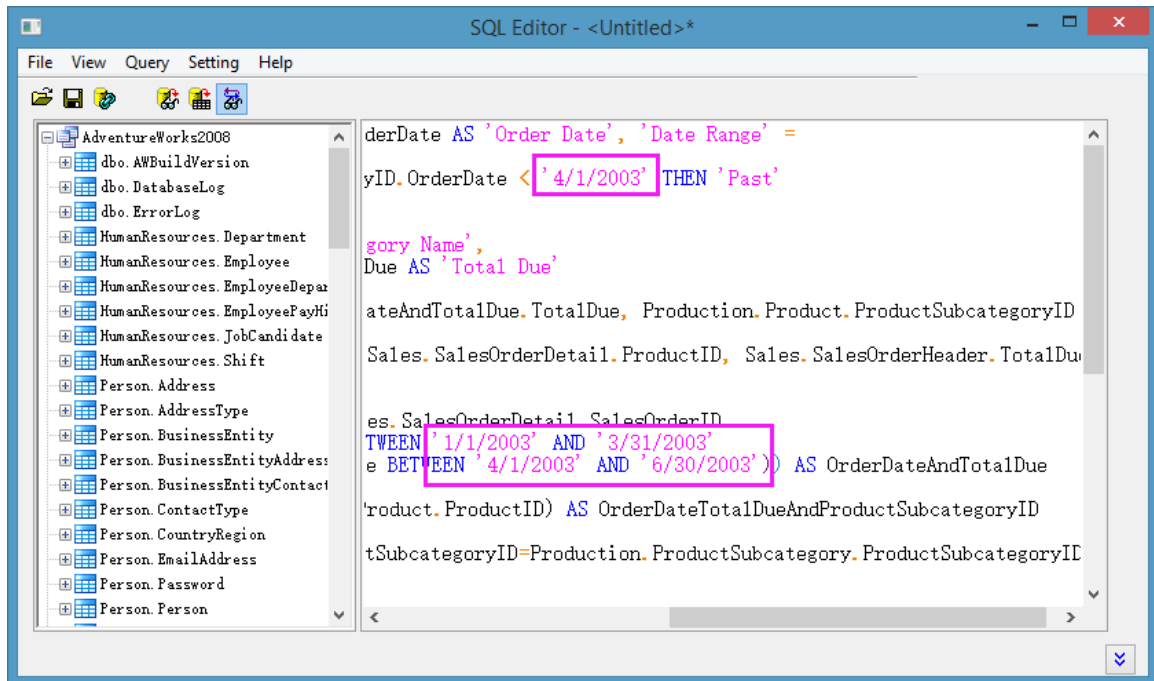

7. Select menu **File: Save to Active Worksheet** to save these settings to the worksheet, and then click

the **Import data to worksheet** button  to import the data into worksheet, and then close SQL Editor. We can see the imported data as the following image shows. A yellow icon will appear at the top-left of the worksheet to indicate there is database connection is saved in the worksheet.

The screenshot shows an Excel worksheet titled 'Book1 \*'. The data is imported into a table with the following columns: Long Name, Units, Comments, F(x)=, Order Date, Date Range, Subcategory Name, and Total Due. A yellow icon in the top-left corner of the worksheet indicates a database connection is saved.

Long Name	Order Date	Date Range	Subcategory Name	Total Due
Units				
Comments				
F(x)=				
1	1/1/2003	Past	Helmets	11791.9901
2	1/1/2003	Past	Helmets	72415.506
3	1/1/2003	Past	Helmets	32319.8283
4	1/1/2003	Past	Helmets	53279.3646
5	1/1/2003	Past	Helmets	38884.281
6	1/1/2003	Past	Helmets	6073.3222
7	1/1/2003	Past	Helmets	55488.8652
8	1/1/2003	Past	Helmets	48718.8616
9	1/1/2003	Past	Helmets	31646.036
10	1/1/2003	Past	Helmets	40481.3902
11	1/1/2003	Past	Helmets	72497.3627
12	1/1/2003	Past	Helmets	30226.3167
13	1/1/2003	Past	Helmets	36998.6368
14	2/1/2003	Past	Helmets	64660.8669
15	2/1/2003	Past	Helmets	50678.4103
16	2/1/2003	Past	Helmets	34092.3437

### 9.3.6.3.2 Create Pivot Table and Do Column Calculations

1. Start with the imported data. Select column C, and then choose **Worksheet: Pivot Table** menu to open the **Data Manipulation\Worksheet: wpivot** dialog.
2. Set the Recalculation as Auto.
3. Select column B for **Pivot Table Column Source** by clicking the triangle button to the right.
4. Choose *Sum* for **Summarize by**. Then you can see **Pivot Table Data Source** row shows above, just choose column D for it by clicking the triangle button to the right.
5. Expand the **Options** node and set **Sort Output Columns** to *None*.

Pivot Table: wpivot

Dialog Theme <Last used> \*

Description Create a pivot table to visualize data summarization

**Recalculate** Auto

**Pivot Table Row Source** [Book1]Sheet1!C"Subcategory Name"

**Pivot Table Column Source** [Book1]Sheet1!B"Date Range"

**Pivot Table Data Source** [Book1]Sheet1!D"Total Due"

**Summarize by** Sum

**Combine Smaller Values**

**Options**

Totals for Rows

Sort Output Rows Descending by Row Totals

Totals for Columns

**Sort Output Columns** None

Normalize by Column Totals None

Show Zeros when Empty

Row Source Extra Values

Column Source Extra Values

**Separate extra values by '|', for example A|B|C**  
**Combine different column/row info by '\_', for example, A\_1|A\_2**

Put Column Info. to Comments

**Output Result Table to** [<input>]<new>

OK Cancel

- Click **OK** button to create a pivot table by using the settings.

	A(X)	B(Y)	C(Y)
Long Name	Subcategory Name	Sum of Total Due	
Units			
Comments		Past	Current
UserParam1			
F(x)=			
1	Road Bikes	7.22256E7	9.63871E7
2	Mountain Bikes	2.53236E7	3.23855E7
3	Road Frames	9.43693E6	4.16778E7
4	Wheels	8.779E6	2.67553E7
5	Mountain Frames	9.11042E6	1.88738E7
6	Gloves	8.07405E6	1.85483E7
7	Helmets	7.71143E6	1.64149E7
8	Jerseys	7.27216E6	1.49464E7
9	Tights	7.92738E6	1.39888E7
10	Bib-Shorts	4.84223E6	1.21952E7
11	Shorts	4.10814E6	1.03396E7
12	Handlebars	3.28604E6	8.63461E6
13	Caps	4.16276E6	5.68497E6
14	Pumps	1.54351E6	5.17079E6
15	Locks	1.49866E6	4.93992E6
16	Headsets	1.72382E6	2.82204E6
17	Forks	1.05305E6	2.4632E6

7. Click **Add New Columns** button  twice to add two columns.
8. Change the Long Name of them to *Percent Change* and *Gain/Loss* respectively.
9. In F(x)= cell of column D,

if you are using Origin 2017, enter

```
B==0 ? 100 : 100*(C-B)/B
```

If you are using versions before Origin 2017, enter

```
col(B)==0 ? 100 : 100*(col(C)-col(B))/col(B)
```

10. In F(x)= cell of column E,



if you are using Origin 2017, enter

```
D > 0 ? 12 : 2
```

If you are using versions before Origin 2017, enter

```
col(D) > 0 ? 12 : 2
```

11. The result looks like:

	A(X)	B(Y)	C(Y)	D(Y)	E(Y)
Long Name	Subcategory Name	Sum of Total Due		Percent Change	Gain/Loss
Units					
Comments		Past	Current		
UserParam1					
F(x)=				B==0 ? 100 : 100*(C-B)/B	D > 0 ? 12 : 2
1	Road Bikes	7.22256E7	9.63871E7	33.45282	12
2	Mountain Bikes	2.53236E7	3.23855E7	27.88625	12
3	Road Frames	9.43693E6	4.16778E7	341.64598	12
4	Wheels	8.779E6	2.67553E7	204.76517	12
5	Mountain Frames	9.11042E6	1.88738E7	107.16758	12
6	Gloves	8.07405E6	1.85483E7	129.72758	12
7	Helmets	7.71143E6	1.64149E7	112.86453	12
8	Jerseys	7.27216E6	1.49464E7	105.5293	12
9	Tights	7.92738E6	1.39888E7	76.46211	12
10	Bib-Shorts	4.84223E6	1.21952E7	151.85187	12
11	Shorts	4.10814E6	1.03396E7	151.6862	12
12	Handlebars	3.28604E6	8.63461E6	162.76644	12
13	Caps	4.16276E6	5.68497E6	36.56729	12
14	Pumps	1.54351E6	5.17079E6	235.00097	12
15	Locks	1.49866E6	4.93992E6	229.62281	12
16	Headsets	1.72382E6	2.82204E6	63.70876	12
17	Forks	1.05305E6	2.4632E6	133.90993	12
18					

### 9.3.6.3.3 Create Graph and Customize Graph

1. On **Pivot1** worksheet, select column C and D and select **Plot: Multi-Panel: Stack...** menu.
2. In the dialog, change the setting as follows.

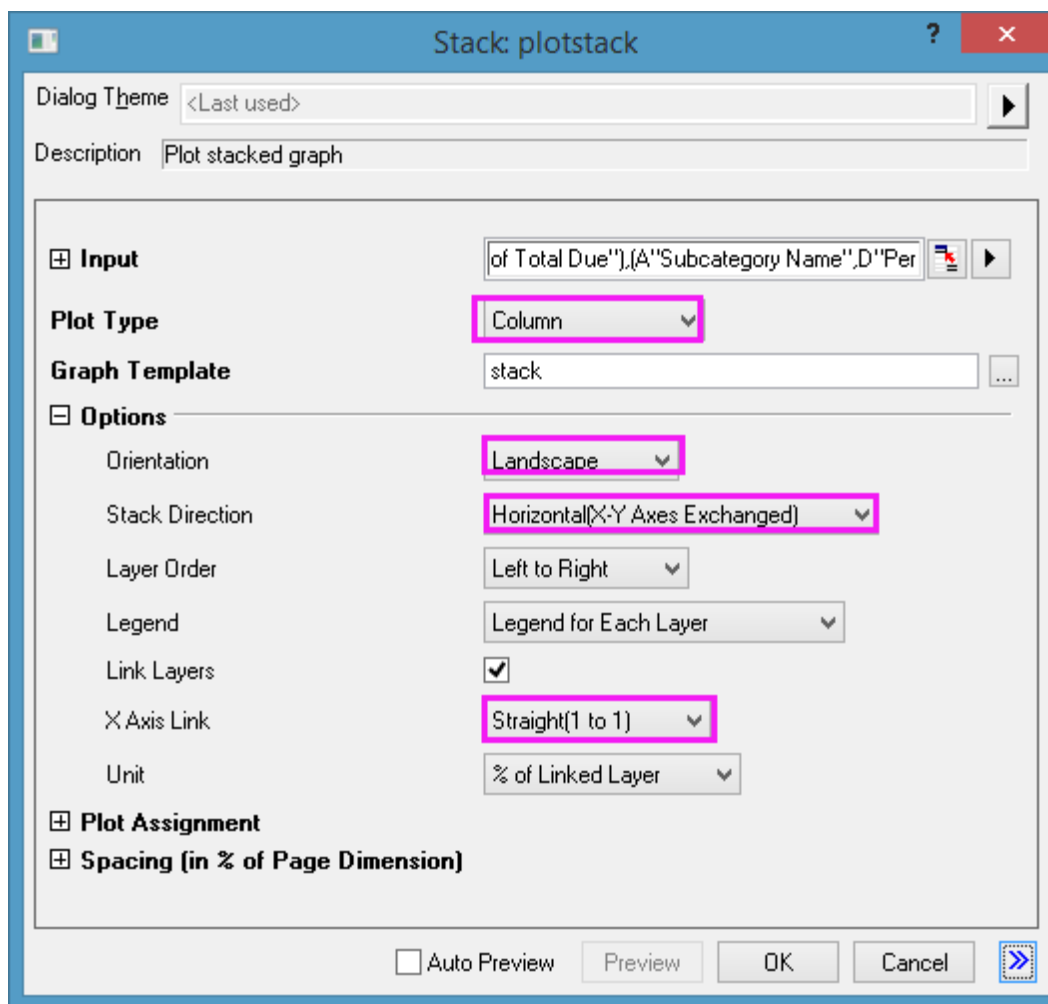

3. Click OK. A two panel graph is created.

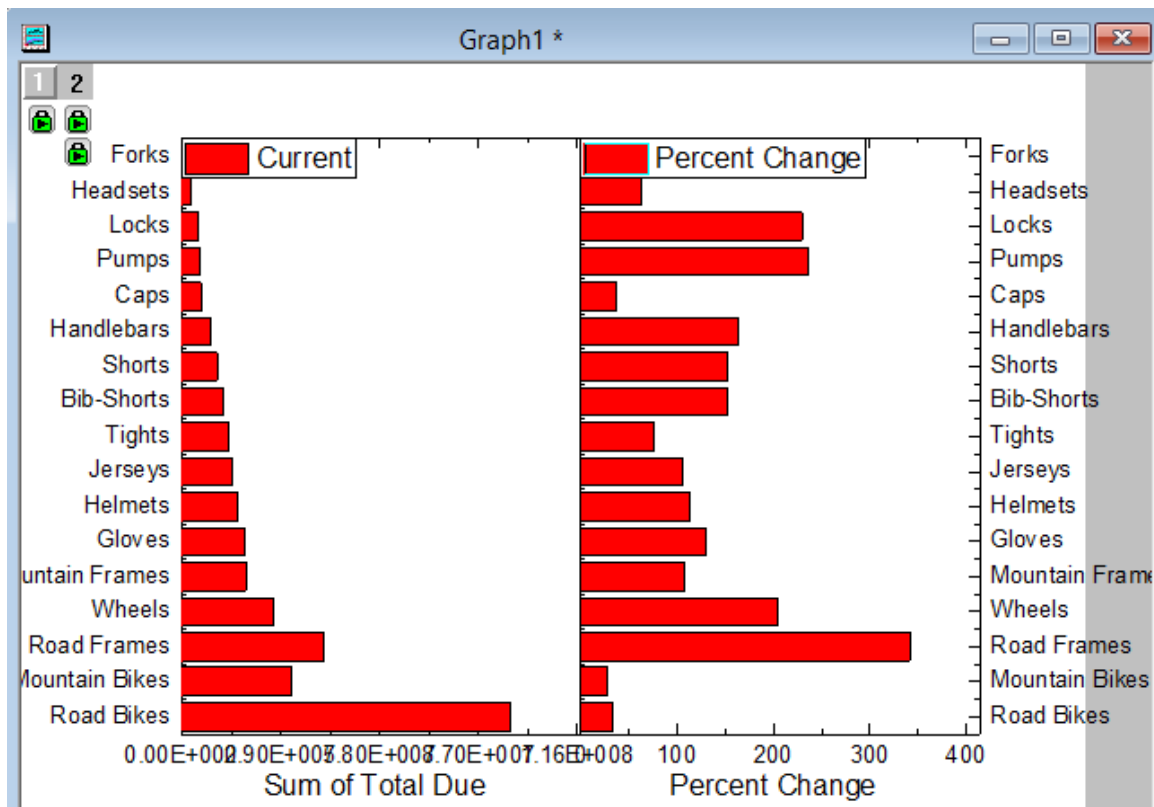

4. Double click bottom axis on left panel. On **Tick Labels** tab, set **Divide by Factor** as *1000000* (one million), set **Suffix** as *M*. On **Scale** tab, set **From** and **To** as *0* to *120*. Set Major Tick Type as By Increment and Value as *20*. Select Vertical on the left panel of the Axis dialog. Set Rescale as Auto. Select Click OK.
5. Double click the bottom axis on right panel. On **Scale** tab, set **From** and **To** as *-100* to *400*. Set Major Tick Type as By Increment and Value as *100*. Select Vertical on the left panel of the Axis dialog. Set Rescale as Auto. Go to **Grids** tab, now **Horizontal** shows on the left panel. Check **Y=0** checkbox at the bottom of the tab. On **Special Ticks** tab, select Bottom on the left panel. On **Axis Begin** row, set **Show** as *Hide*. Otherwise the end tick label of left plot will run into beginning tick label of right plot. Click OK.
6. Delete legends, right axis tick labels, etc. so the graph will look as follows.

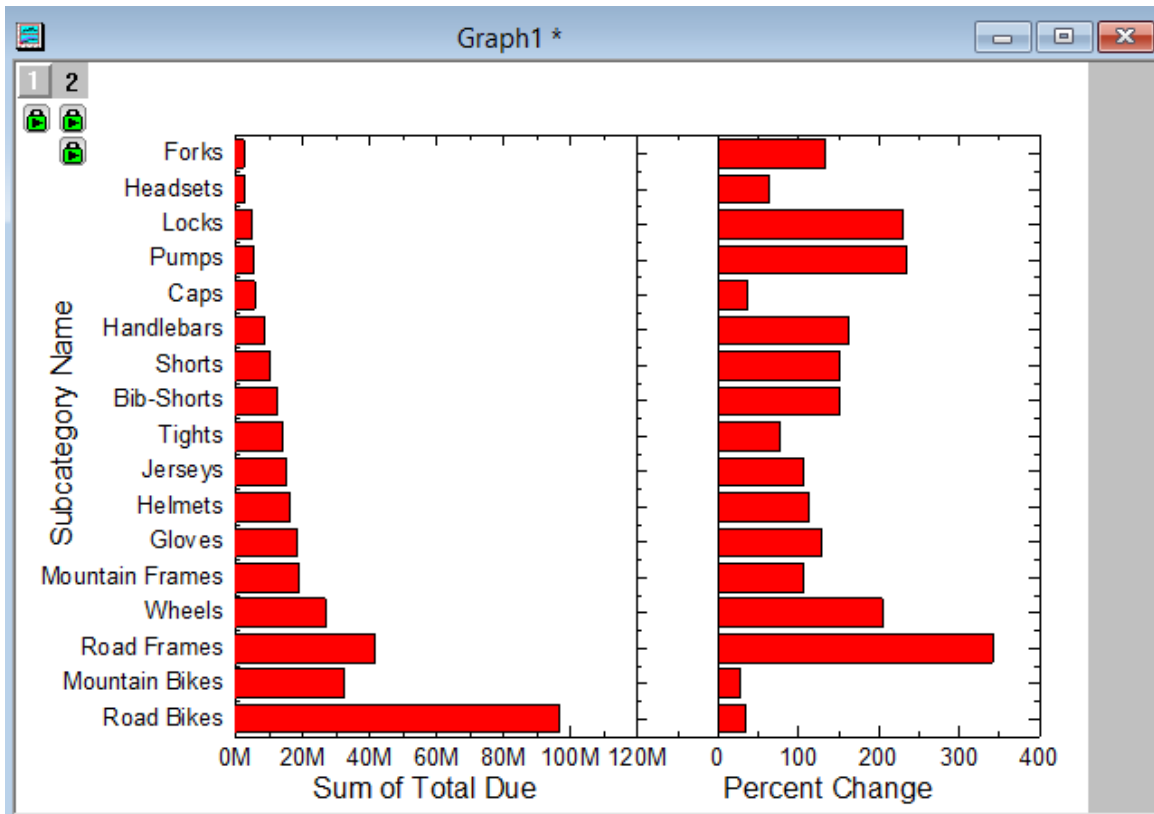

7. Set the fill color of left bar plot to LT Cyan.
8. Set the fill color of right bar plot to be indexed to Column E (Gain/Loss). Enable labels and set **Label Form** as *Custom* and **Format String** as  $\$(Y, .1)\%$  to show Y value with 1 decimal places with % suffix.
9. You can further customize the axis such as delete those axis frames on the top and right and bottom. Turn on grid lines. Hide the major and minor ticks on the left axis, etc. The graph will look as follows.

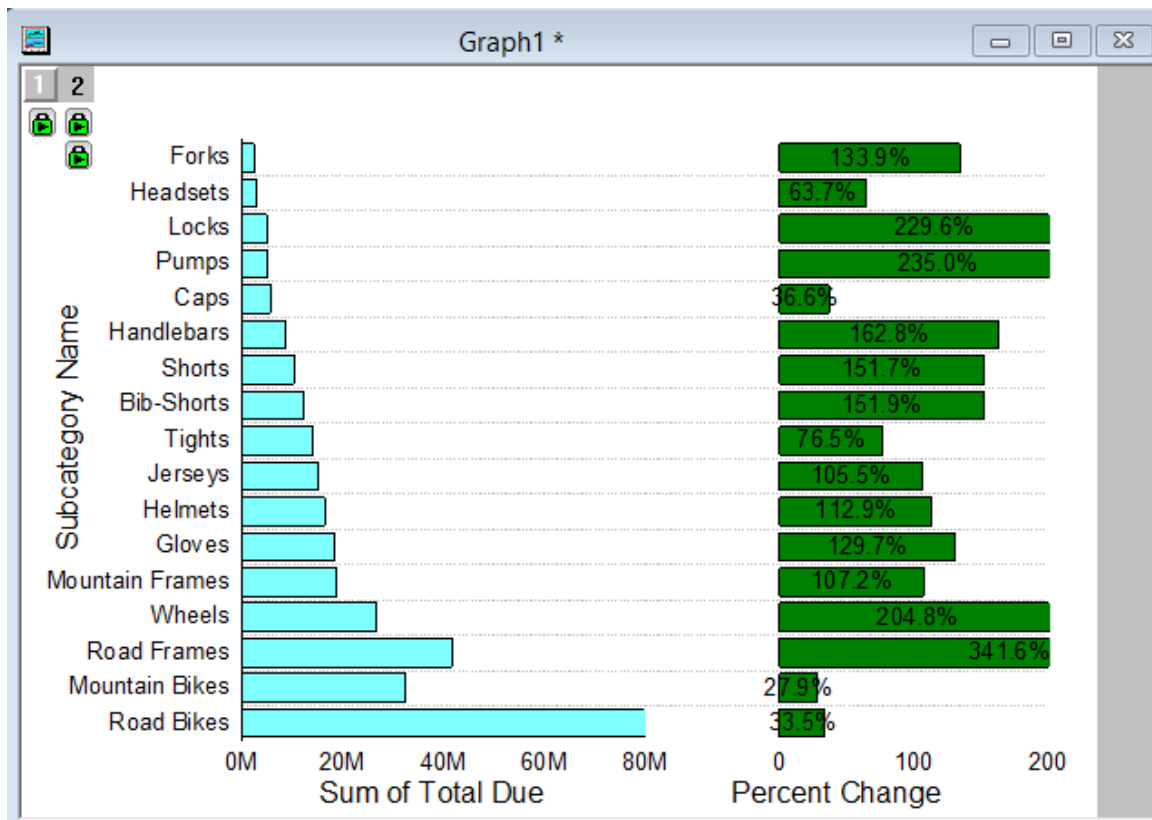

#### 9.3.6.3.4 Add Button to Run LabTalk Script

1. Right click at bottom-right corner of the graph and choose **Add Text...** And type **Update** to create a text label.
2. Right click on the text **Update** and choose **Properties...** context menu to open **Text Object** dialog. Go to **Programming** tab. Note: In versions before Origin 2017, choose **Programming Control...** from the menu to open the **Programming Control** dialog.
3. Set **Script, Run After** to *Button Up*, and put the following script to the bottom text box. Click **OK**.

```
double pastDate1 = date(1/1/2003);

double pastDate2 = date(3/31/2003);

double currentDate1 = date(4/1/2003);

double currentDate2 = date(6/30/2003);

// Check if strPast1$, strPast2$, strCurrent1$, strCurrent2$ exist the
```

```
same time

if((exist(strPast1$, 18) == 18) && (exist(strPast2$, 18) == 18) &&
(exist(strCurrent1$, 18) == 18) && (exist(strCurrent2$, 18) == 18))

{

    // If yes, set to double value, so to show on the dialog

    pastDate1 = date(strPast1$);

    pastDate2 = date(strPast2$);

    currentDate1 = date(strCurrent1$);

    currentDate2 = date(strCurrent2$);

}

// Dialog for date settings

GetN (Last Season) :@G

    (From) pastDate1:@FD0

    (To) pastDate2:@FD0 (-) :@G

(Current Season) :@G

    (From) currentDate1:@FD0

    (To) currentDate2:@FD0 (-) :@G

(Set Date);

// Get the set dates, and convert to string

string strPast1$ = $(pastDate1, D0);

string strPast2$ = $(pastDate2, D0);
```

```

string strCurrent1$ = $(currentDate1, D0);

string strCurrent2$ = $(currentDate2, D0);

// Reimport data from database according to the set dates

dbimport iw:=[book1]sheet1!;

range rPivot = [Book1]Pivot1!; // Pivot table range

layer.x.to = rPivot.maxRows+0.5; // Set to value of vertical axis

rPivot.runfilter(); // Run the data filter
    
```

The text object turns into a button and the script in it will be triggered when clicking on it.

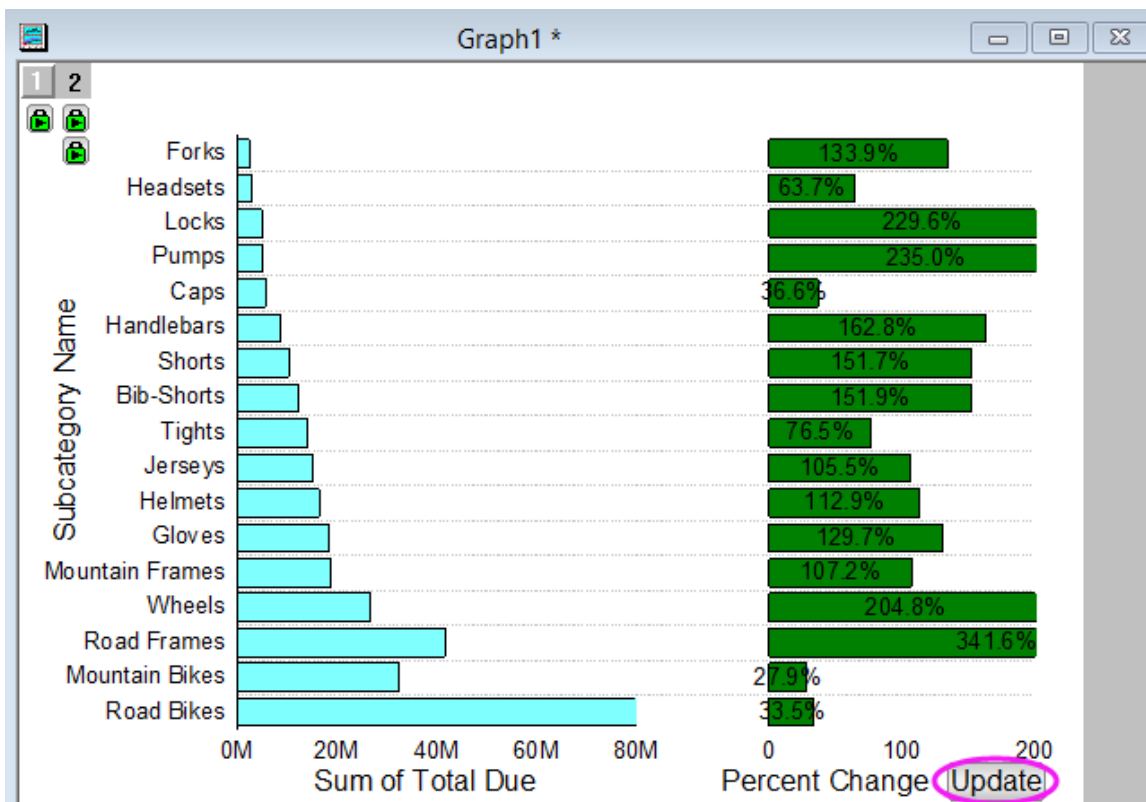

4. Click this button, a dialog will pop up with the default dates (for the first time, if not the first time, the dates set last time are shown).
5. Now, let's change the period, such as Last Season From 1/1/2004 To 3/31/2004, and Current Season From 4/1/2004 To 6/30/2004.

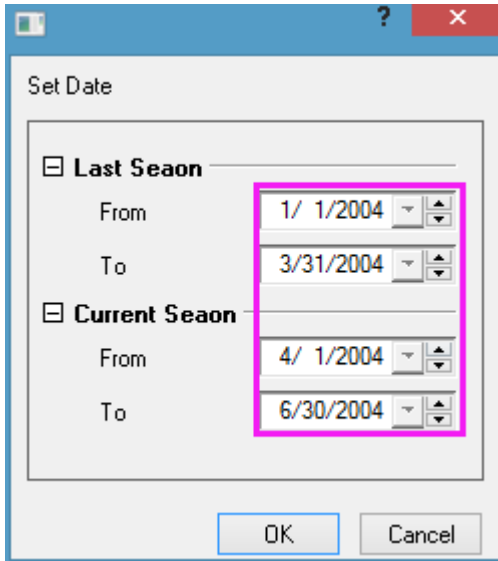

- Click **OK**, data in the specified date range will be reimported into worksheet and Pivot1 worksheet will be updated. The graph is updated as well. The bar color is indexed to Gain/Loss column in Pivot1 sheet. You can easily tell there is a loss in one product.

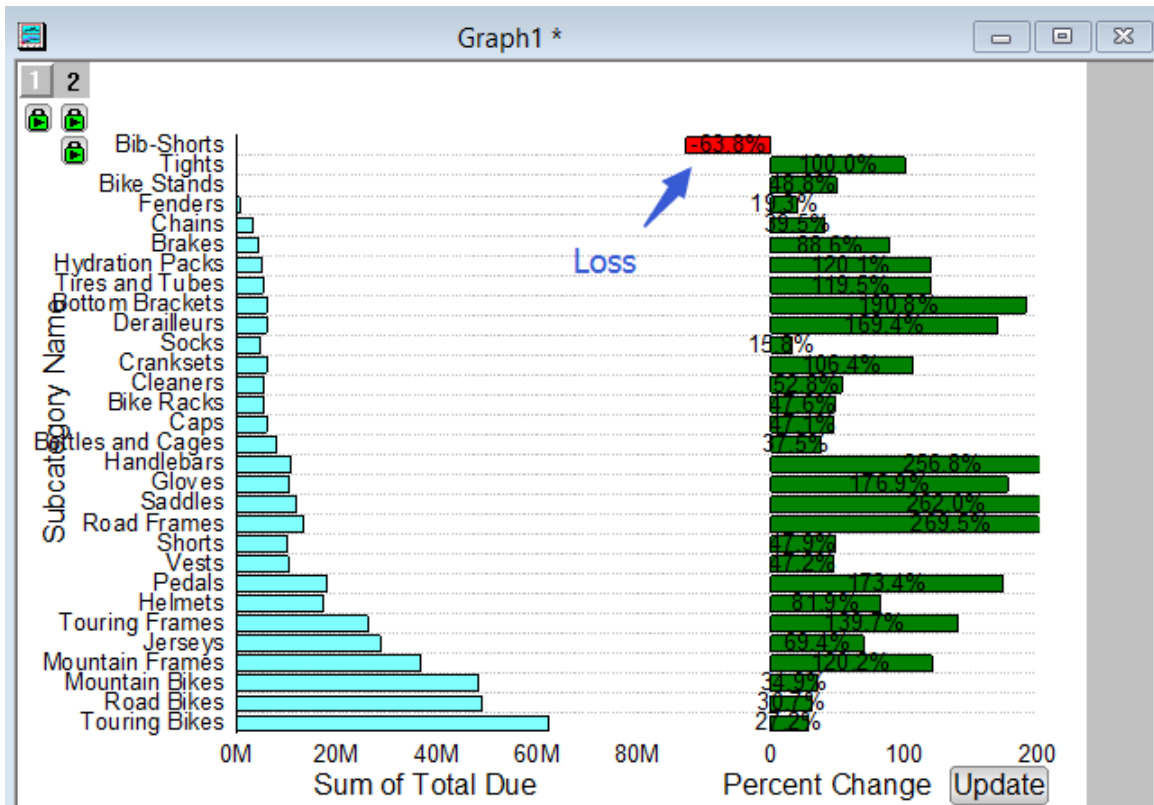

## 9.4 Digitizer

### 9.4.1 Digitizer



- [Digitizer Tool](#)
- [Enhanced Digitizer](#)

## 9.4.2 Digitizer Tool

### 9.4.2.1 Summary

The Digitizer helps you to capture data from images of graphs. You can import image files of graphs into Origin and digitize data points one by one.

### 9.4.2.2 What you will learn



- How to capture data from images of graphs using the Digitizer Tool.
- How to modify the position of the picked points
- How to delete the extra points

### 9.4.2.3 Steps

#### 9.4.2.3.1 Capture data points

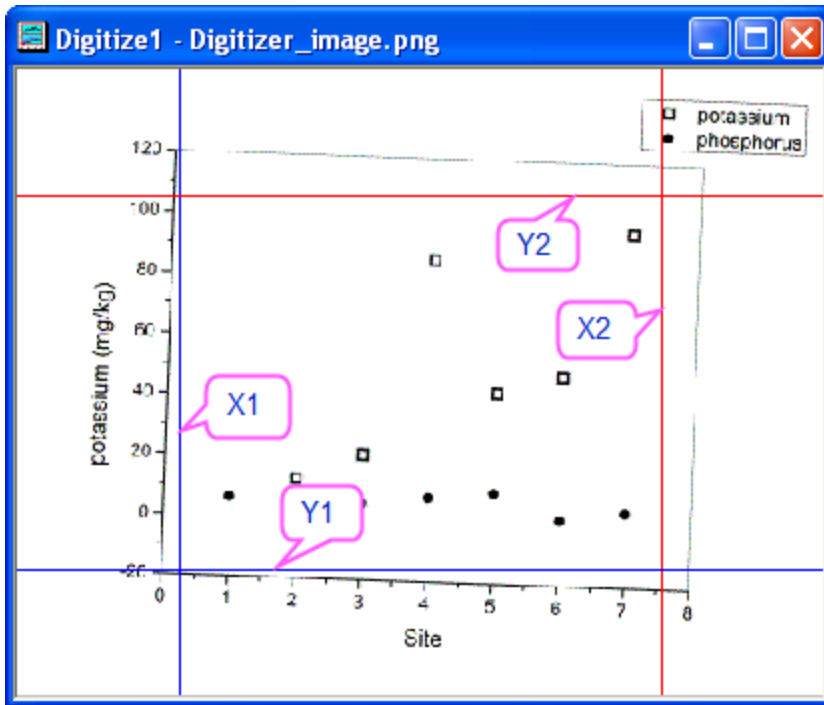
1. Select **Tools: Digitizer...** from the main menu to open the **Digitizer** dialog.
2. Click the **Import**  button on the dialog box toolbar, and select the *Digitizer\_image.png* under <Origin EXE folder>\Samples\Import and Export\ path. The image is imported. Note that there are two pairs of XY axes showing in the image; one red and one blue.



- Click on the **Rotate Image**  button (dialog box toolbar), and click the button  to slightly rotate the image in the counter-clockwise direction. Note that the rotation increment can be specified in **Increment (degree)** the text box.

Digitizer - Digitizer\_image.png(495x385)

Right Click to Save/Load Axes Settings

Name	Color	Axis Value	Image Pixel	Scale Type
X1	Blue	1	99	Linear
X2	Red	10	396	
Y1	Blue	1	308	Linear
Y2	Red	10	77	

Click Rotate button again to get out of Rotation mode

Rotation Angle from Source Image (degree)

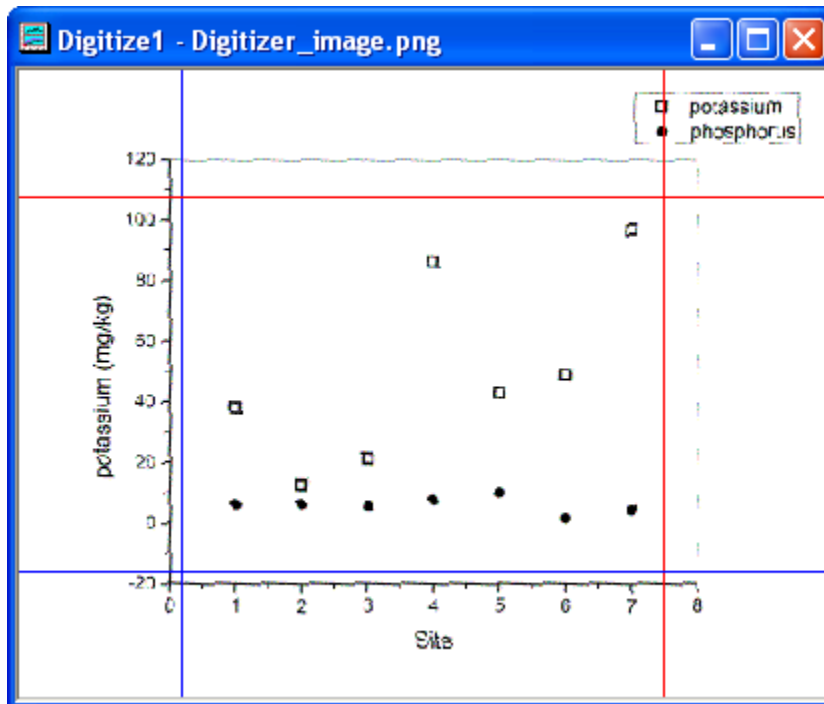

<< >> Increment (degree)

When the graph axes in the image are aligned along the bottom/top and left/right edges, click once more on the **Rotate Image**  button, to leave Rotation mode.

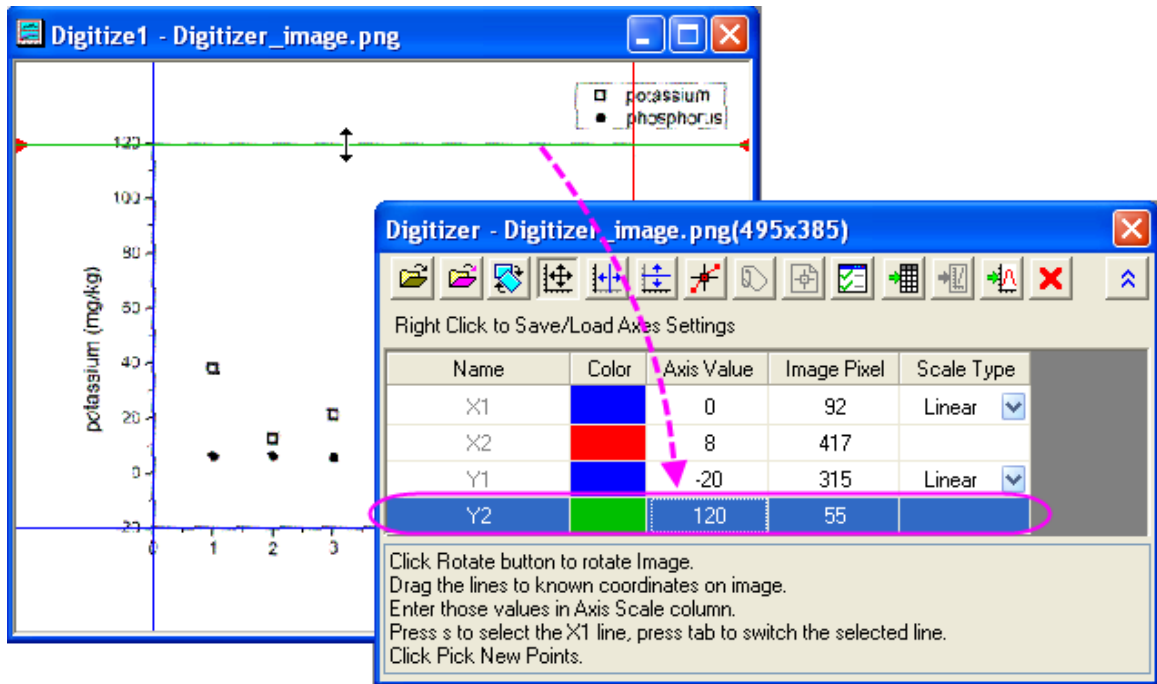

- Click on the **Edit Axes**  button in the dialog. Using your mouse, drag the two pairs of axis lines so that they coincide with minimum and maximum axis values. Note that when a line is selected, its corresponding row in the Digitizer dialog is also selected. Enter the appropriate coordinate value (0, 8, -20, 120) in the **Axis Value** column.



- After locating the axes, click the **Pick New Points**  button. Move the cursor  sequentially over the points in the phosphorus plot (filled symbol), double-clicking on each point (or single-click and press *Enter*). The **GetPoints** dialog displays coordinate values, while the Data Display window shows image pixel values.

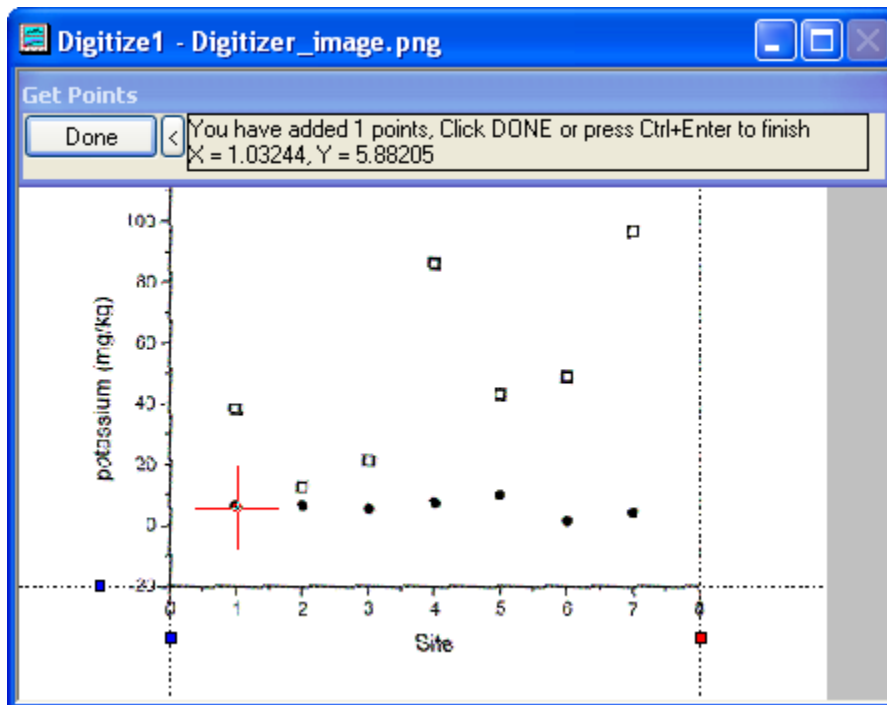

6. When you have added all points for the phosphorus plot, click the **Done** button.

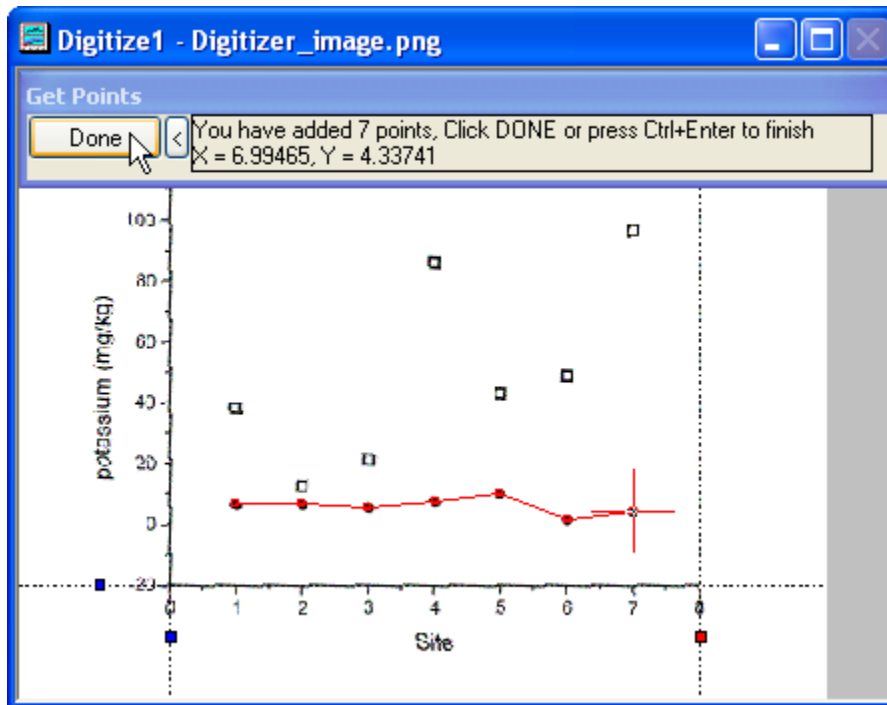





7. Click on the **Go to Data**  button to show the resulting worksheet which contains the values of picked data points.

The screenshot shows the DigiData software window. The title bar reads "DigiData". The main area is a data table with the following structure:

	A(X)	B(Y)	C(L)
Long Name		PickedY1	
Units			
Comments			
Scale Type	Linear Scale	Linear Scale	
1	0.99155	7.02021	
2	1.98773	7.02021	
3	2.98391	5.71946	
4	4.00983	7.67059	
5	4.97256	10.2721	
6	5.99847	1.7359	
7	6.99465	4.33741	
8			
9			
10			
11			



At the bottom of the window, there is a file path "Digitizer\_image.png" and navigation buttons.

8. Click on the **Go to Image**  button to return to the original image. Click on the **Start New Data**  button to start digitizing the second plot (potassium = open symbol). Note that two new columns of data points are created in the result worksheet.

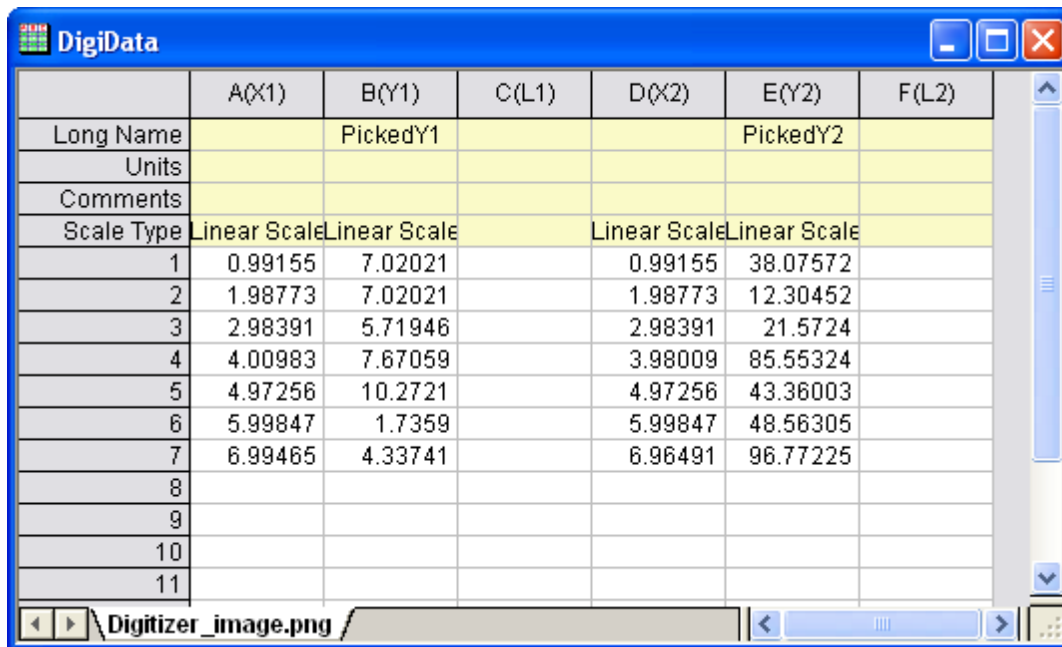
9. Click on the **Pick New Points**  button to get the points for the second plot, repeating the procedures followed in steps 5 and 6.
10. Click on the **Go to Data**  button and two datasets result shows in the worksheet.



	A(X1)	B(Y1)	C(L1)	D(X2)	E(Y2)	F(L2)
Long Name		PickedY1			PickedY2	
Units						
Comments						
Scale Type	Linear Scale	Linear Scale		Linear Scale	Linear Scale	
1	0.99155	7.02021		0.99155	38.07572	
2	1.98773	7.02021		1.98773	12.30452	
3	2.98391	5.71946		2.98391	21.5724	
4	4.00983	7.67059		3.98009	85.55324	
5	4.97256	10.2721		4.97256	43.36003	
6	5.99847	1.7359		5.99847	48.56305	
7	6.99465	4.33741		6.96491	96.77225	
8						
9						
10						
11						

11. Click on the **Go to Image**  button. This takes you to your imported image file. Click on the **Go to Graph**  button and note that this opens a graph window containing plots of your digitized data points.

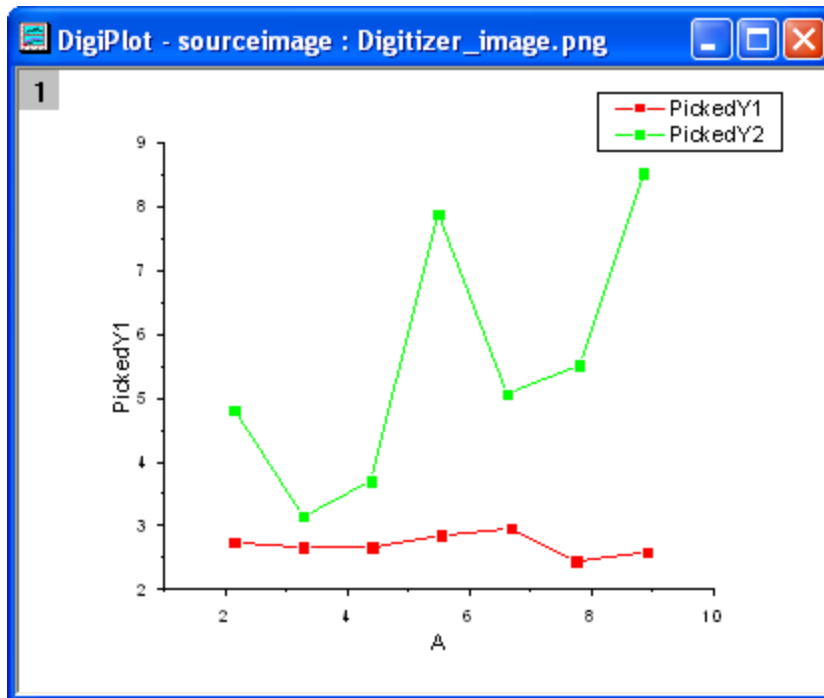

12. When you close the **Digitizer** dialog, a Digitizer...  button appears on the image. Clicking on the button, you can reopen the **Digitizer** dialog.

#### 9.4.2.3.2 Move and delete the picked points

- Following the steps in the above section, you will easy to get the points from the image. But if the picked points are on the incorrect position or extra, as point **A** and **B** in the below image, you can modify or

delete them.

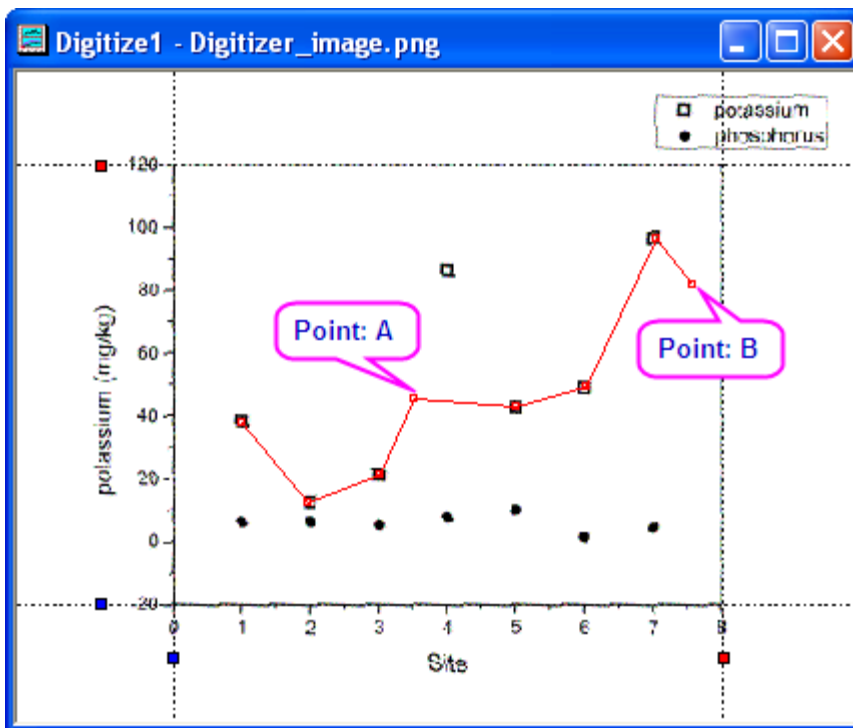

- To modify the position of point **A**, click on it and move the cursor to the correct position. Or you can use **Arrow** keys to move the selected point.

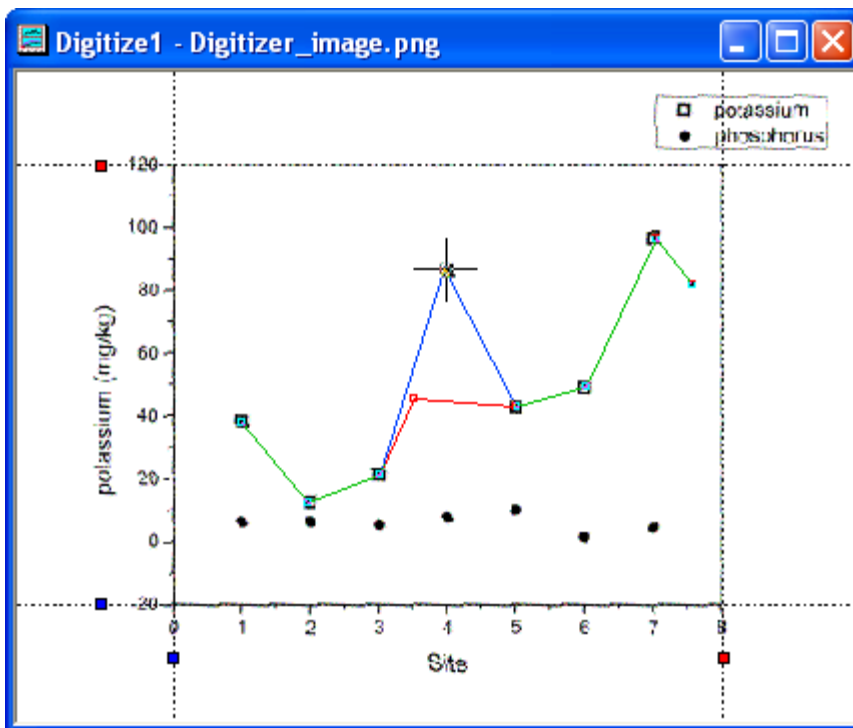

- To delete the point **B**, click to select it and right-click to choose **Delete** in the context menu. Or you can press **Delete** key to delete the selected point.



### 9.4.3 Enhanced Digitizer

#### 9.4.3.1 Summary

The Enhanced Digitizer supports auto tracing and digitizing in 2D Cartesian, polar and ternary coordinate systems.

**NOTE:** The Enhanced Digitizer is built into Origin 2015 SR0 and later versions. If you are running Origin 9.1, the Enhanced Digitizer is available as an add-on tool from [the OriginLab File Exchange](#). The Enhanced Digitizer is not supported by versions prior to Origin 9.1 SR1.

#### 9.4.3.2 What You Will Learn

This tutorial will show you how to:

- Set axes in the image.
- Manually and automatically capture data points.
- Set axes for polar and ternary coordinate systems.

#### 9.4.3.3 Steps

##### 9.4.3.3.1 Import Image and Clear Gridlines

1. Select the **Digitize Image**  button on the **Standard** toolbar.
2. Browse to the folder <Origin EXE Folder>\Samples\Import and Export and open **TwoPeaks.bmp**. There are three line plots in the image: the black plot is the baseline and the red and blue plots are spectra.

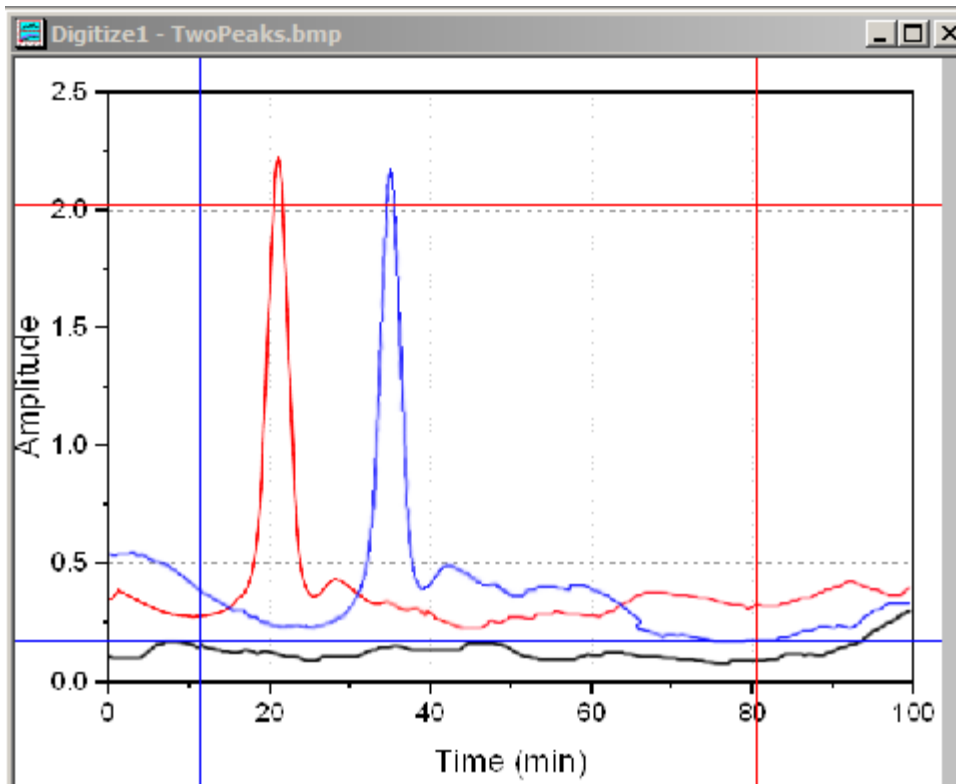

- In the Digitizer dialog, there are hints at the bottom of the Axes tab to guide you through each step.

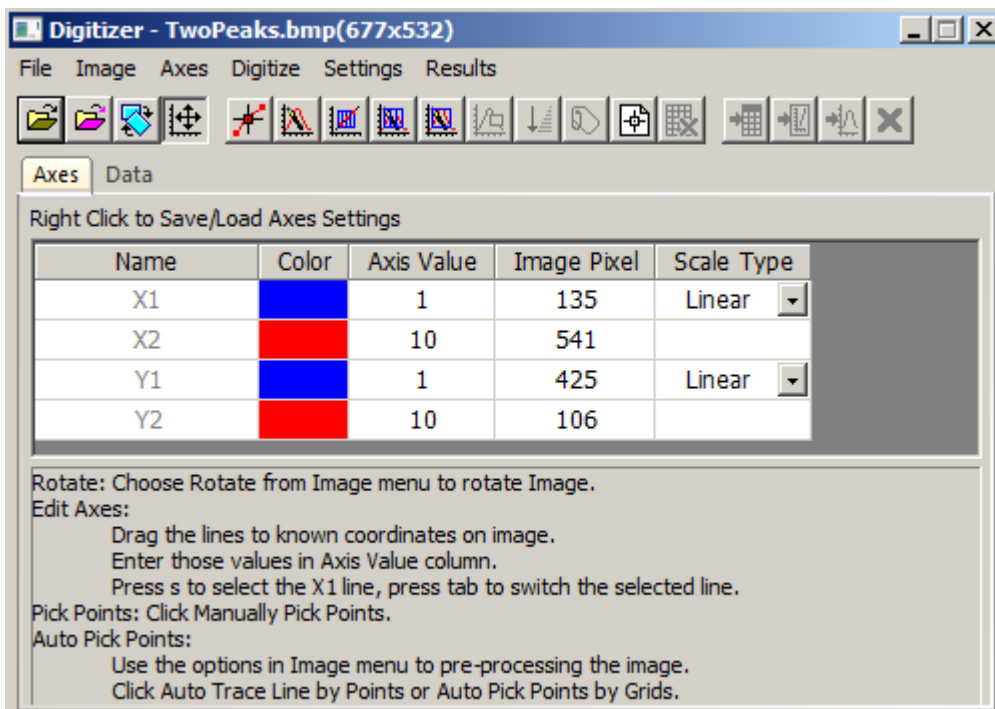

- Select **Image:Remove Cartesian Gridlines** to remove the gridlines.  
 You can also choose **Image: Rotate...** and **Image: Clear Background** menus to rotate the image and clear background noise and color fills.

### 9.4.3.3 Edit Axes

Before capturing data points, you need to setup axes on the image so that there is a reference for calculating the XY coordinates of the data points that will be captured later.

- Click the **Edit Axes**  button or make sure it is pressed.
- Four lines will appear framing the image. Drag each line so that it lines up at a location where you know the axis values and enter the axis value in the corresponding row in the Digitizer dialog.

Use the Zoom and Pan  button on the **Tools** toolbar or hold down **A** and use the mouse wheel to zoom in and pan the image. Then fine tune the line location. Press **Ctrl+W** to restore the original image size.

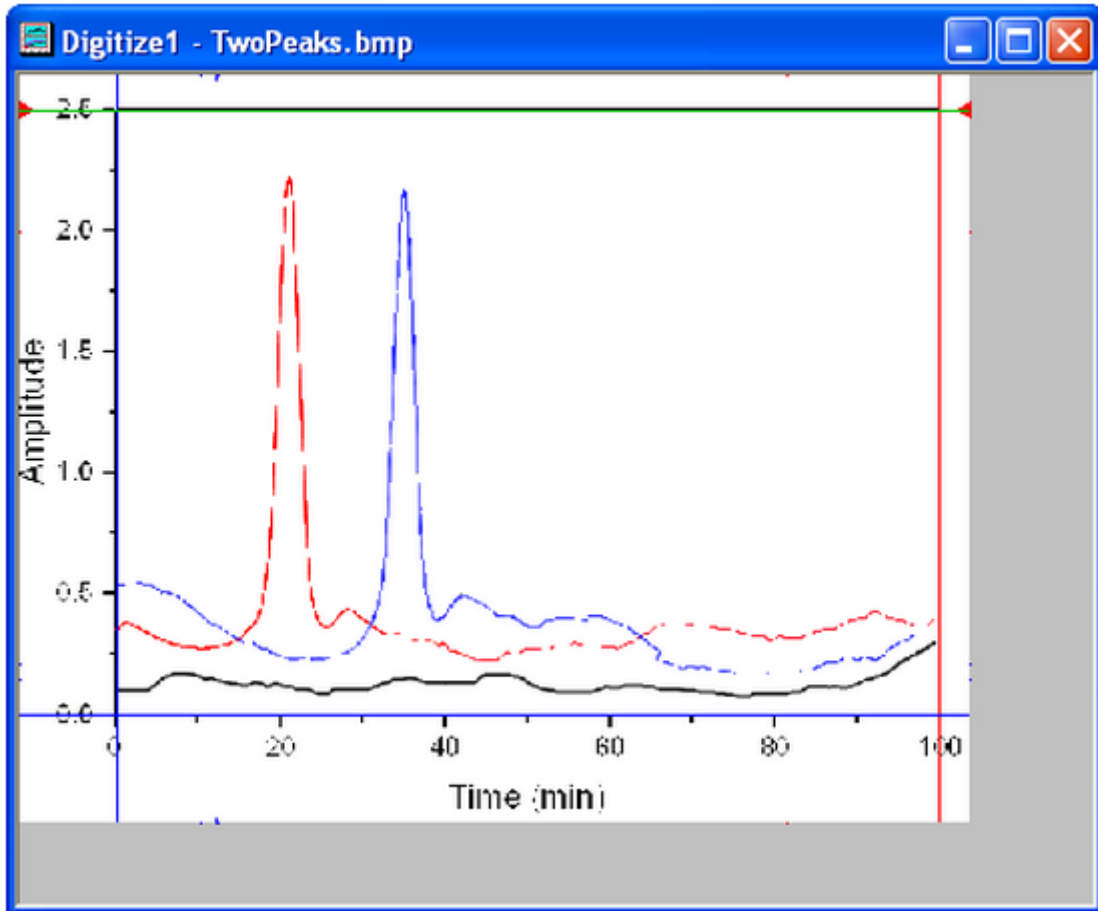

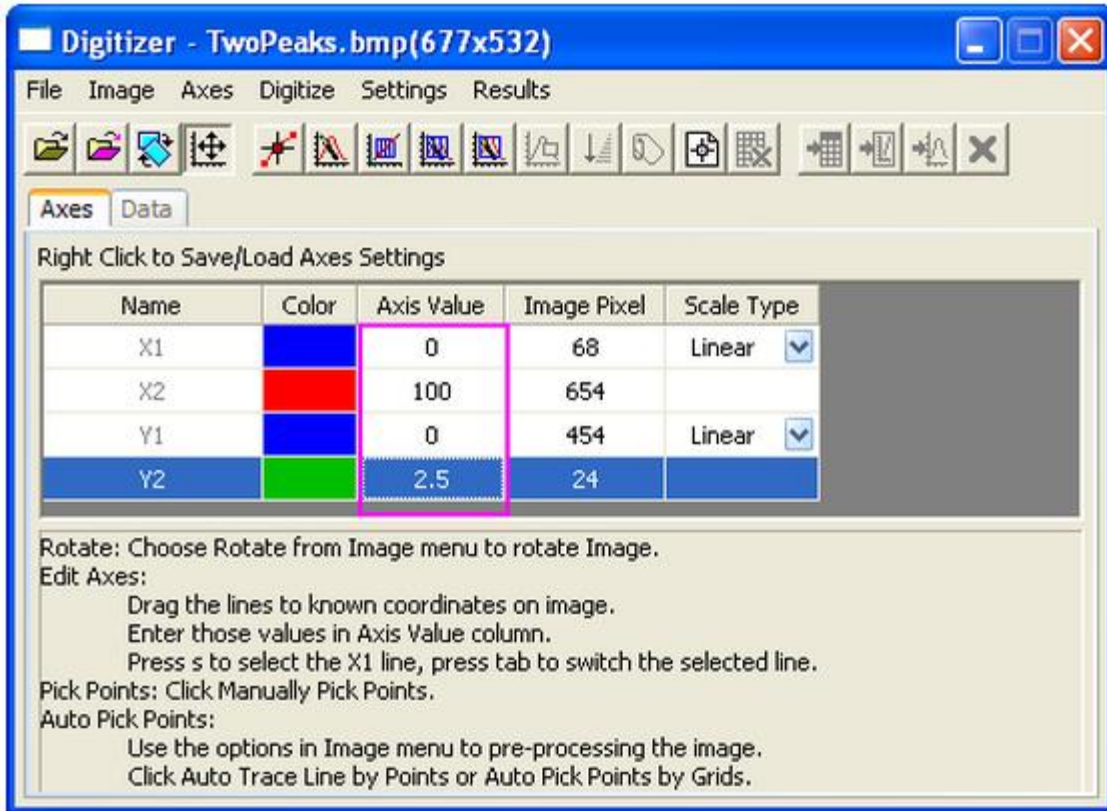

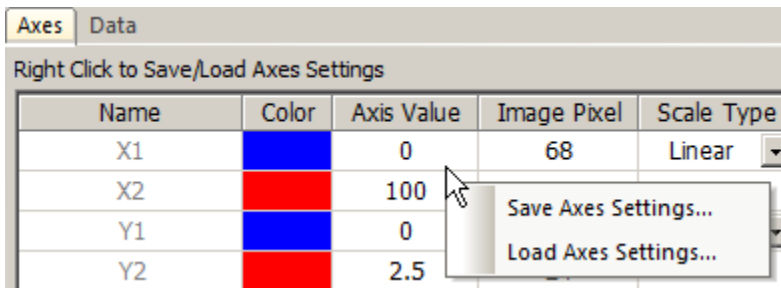

- After editing Axes, you can right click and save Axes settings in order to load them in the future for similar images.



### 9.4.3.3 Capture Data Points

Besides the **Manually Pick Data Points** method, the Enhanced Digitizer provides four automatic digitizing methods to capture data points. They are all under the **Digitize** menu and have corresponding buttons.

Name	Icon	Function
Manually Pick Points		Double click on every spot you want to capture a point.
Auto Trace Line By Points		Double click on a curve on the image and data points will automatically be captured along the curve.

<p>Auto Pick Points By Grids</p>		<p>Drag a rectangle on a desired area of the image and data points will be captured where ever the gridlines in rectangle intersect with the image curve.</p>
<p>Area Auto Trace</p>		<p>This is a hybrid of the previous two methods. Drag a rectangle on a desired area of the image. Data points will automatically be captured along the curve.</p>
<p>Boundary- Limited Area Auto Trace</p>		<p>Similar to the Auto Trace Area button except that points are created only within the selected area.</p>

**Manually Pick Points**

Let's manually capture some points on the red line.

1. Click the **Manually Pick Points** button.

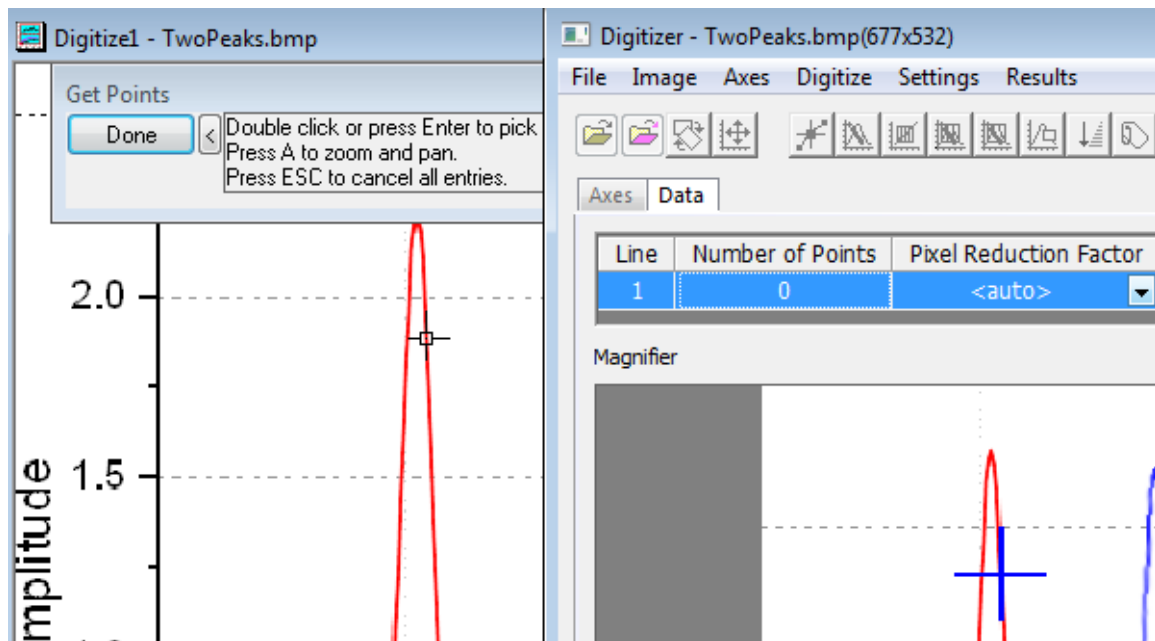

2. Double click on the red curve to pick a point.  
The **Magnifier** window on the **Data** tab of the Digitizer dialog provides a blown up view of where the cursor is. You can also use the Zoom and Pan tool mentioned in the Edit Axes section to zoom and pan the image to pick points more precisely.
3. Pick several more points and click the **Done** button. The **Number of Points** on Line 1 of the **Data** tab shows the number of points that were captured for Line 1.

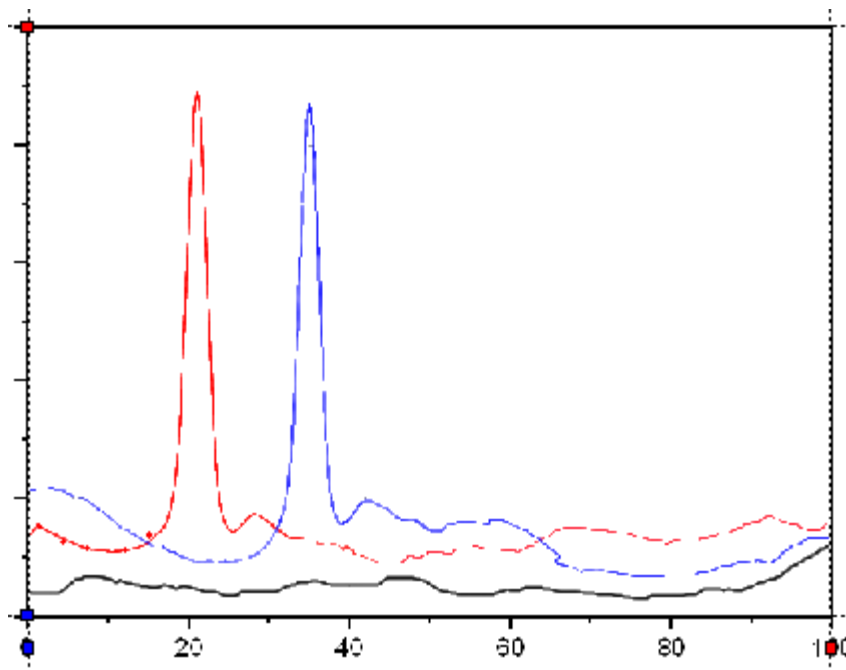

If you want to move or delete a captured point,click the captured point in the image to select it. Use the arrow keys on the keyboard to move the point or press the **Delete** key to delete it.

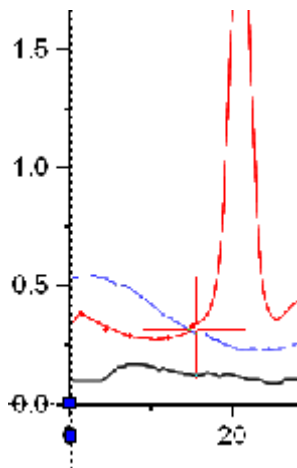

You can click the **Manually Pick Points** button again to pick more points for line 1.

#### Auto Trace Line by Points

Multiple digitizing methods can be used on same line as long as the line is highlighted on the **Data** tab of the Digitizer dialog. Let's pick more red points for Line 1 using the **Auto Trace Line by Points** method.

1. Click the **Auto Trace Line by Points** button.

- Double-click on red points to the left side of the peak and the right side of the peak. Every time you double click a point, Origin auto traces to find more points along the curve. Click the **Done** button.

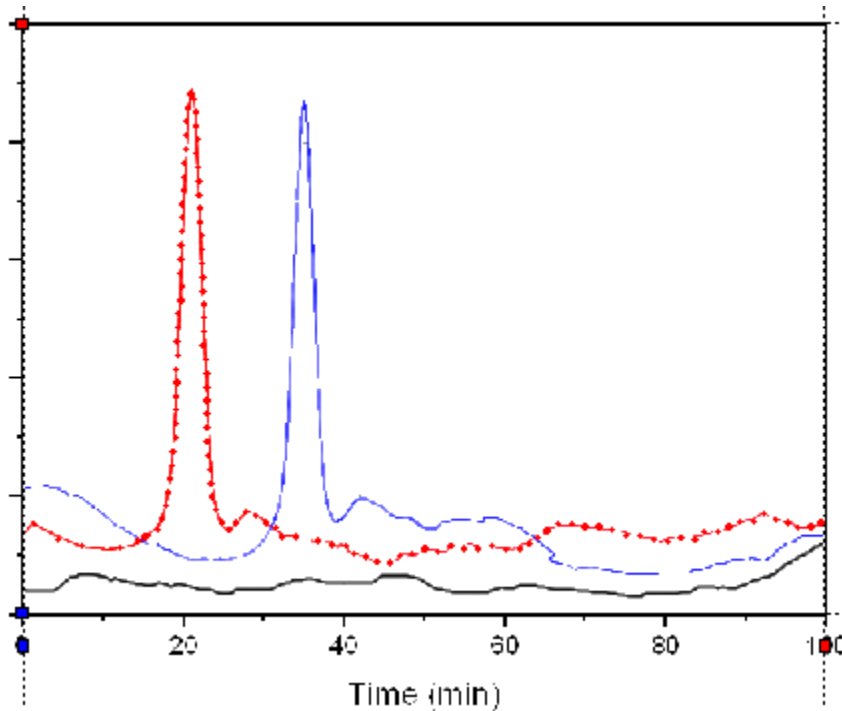

- There are in total 122 points captured on the red line.

Line	Number of Points	Pixel Reduction Factor
1	122	<auto>

- Click the **Go to Data**  button to see the results in a worksheet.

DigiData			
	A(X1)	B(Y1)	C(L1)
Long Name		PickedData	
Units			
Comments			
F(x)			
Scale Type	Linear Scale	Linear Scale	
1	14.37284	0.30375	
2	15.56915	0.32705	
3	16.93636	0.35035	
4	17.44906	0.39695	
5	17.96176	0.44937	
6	18.13266	0.50762	
7	18.47446	0.56587	
8	18.64536	0.62412	
9	18.81627	0.68237	
10	19.15807	0.74062	

### Auto Pick Points by Grids

Next let's use the **Auto Pick by Grids** method to digitize the black baseline.

1. Activate the image window.
2. Click the **New Line**  button. The **Data** tab will start a new row for Line 2.  
Note: All plots in this image use the same XY axis so we don't need to edit the axes again. However, in case you have images with multiple axes, you can setup a new axis for each new line of data.
3. Select the **Auto Pick Points by Grids** button.
4. Click and drag to create a rectangle on a portion of the black baseline as shown below:

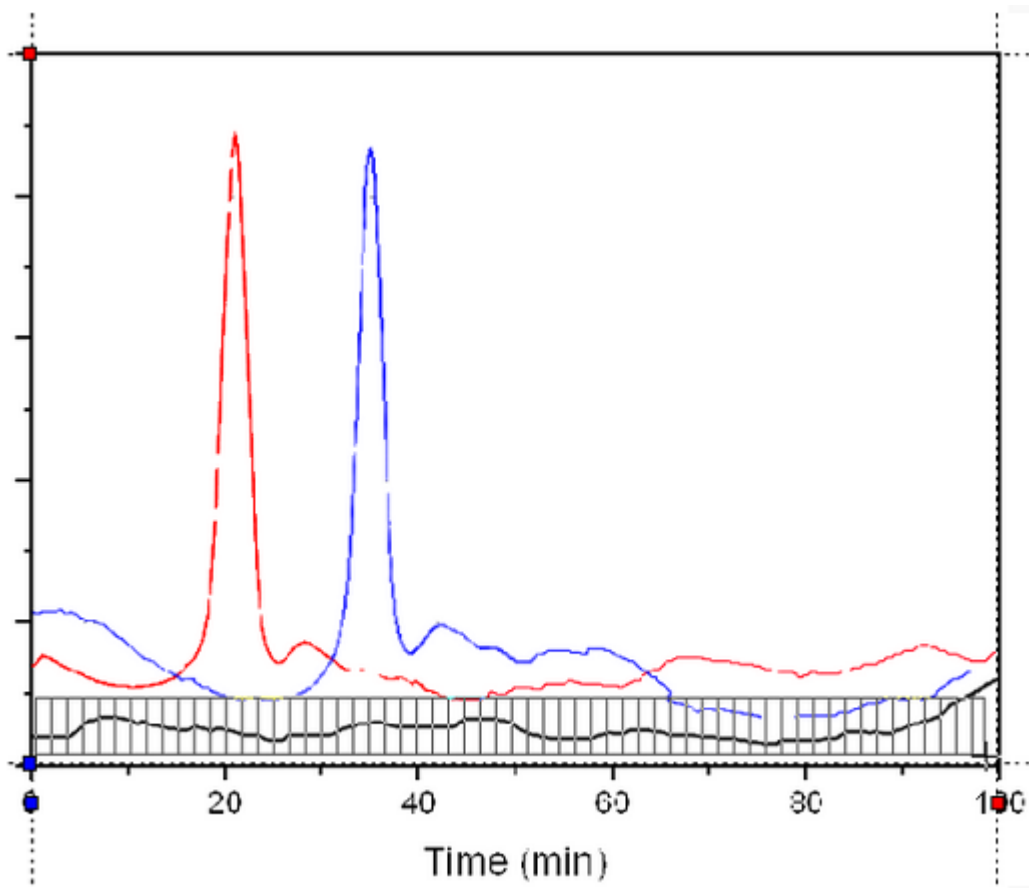



Some points on the red and blue lines are captured as well.

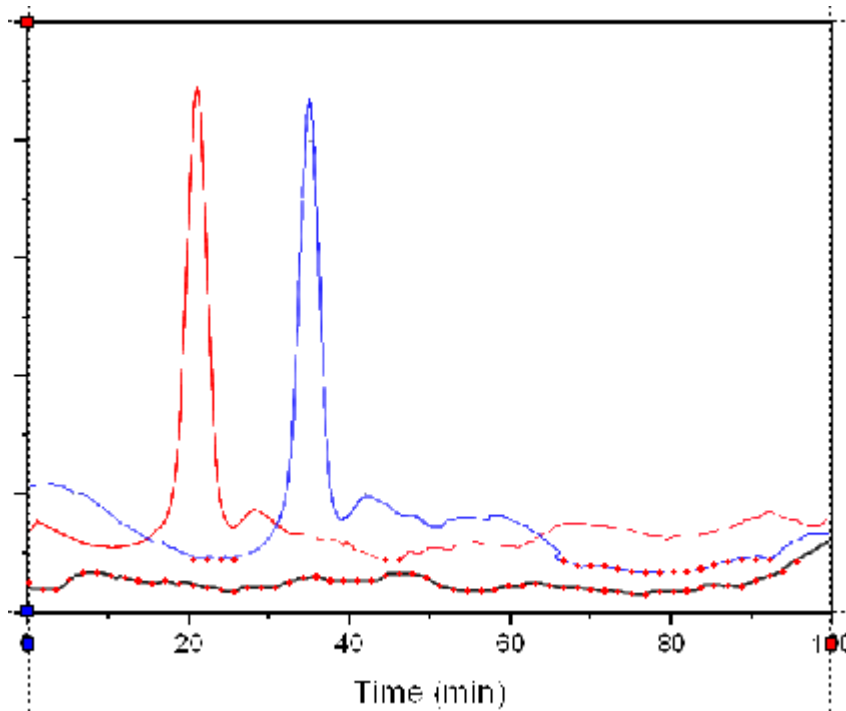

5. To remove unwanted points, click the **Delete Points**  button.
6. Drag a rectangle box over the unwanted points and release the mouse button to delete them.

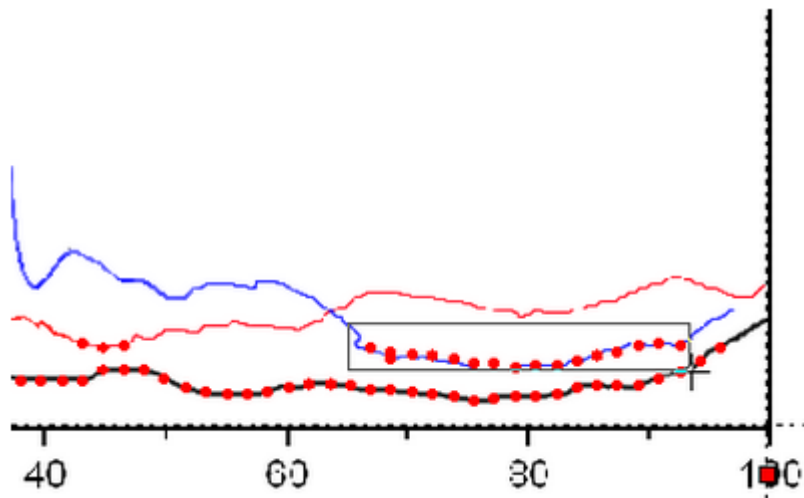

With this method, only 57 points are captured.



Axes		Data
Line	Number of Points	Pixel Reduction Factor
1	122	<auto>
2	57	<auto>

- If you are not satisfied with the result, click the **Delete Line**  button to delete Line 2 on the Data tab of the Digitizer dialog and click the **New Line**  button to start over.

You can use the **Settings: Digitize Settings...** menu to customize the grids density.

**Area Auto Trace/Boundary-Limited Area Auto Trace**

Let's use these two methods to digitize the blue line.

- Click the **New Line**  button.
- Click the **Area Auto Trace**  button.
- Click and drag a rectangle over some part of the blue curve. Points will be auto created along the blue curve beyond the rectangle.

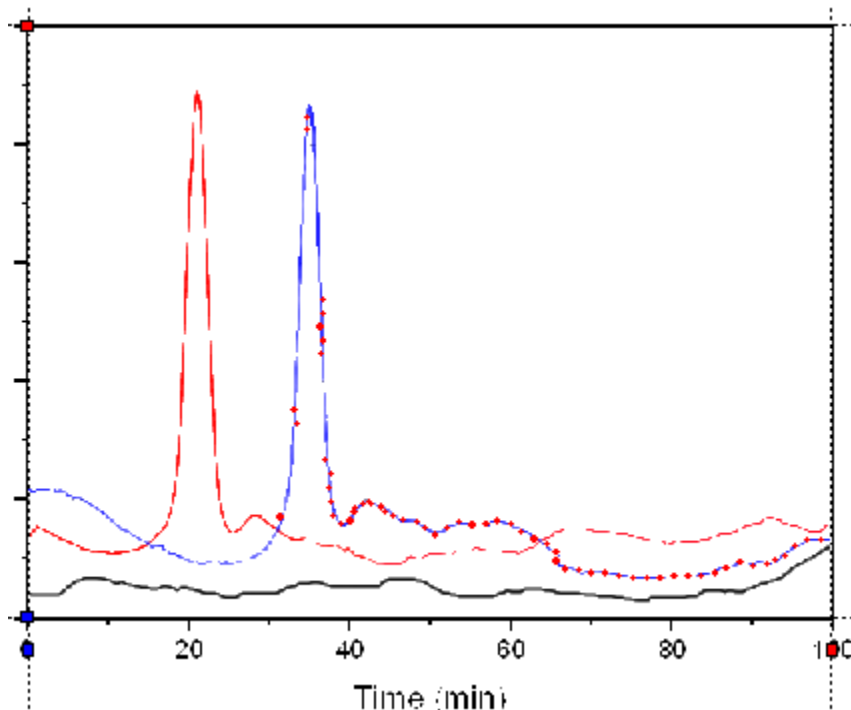



Line	Number of Points	Pixel Reduction Factor
1	122	<auto>
2	57	<auto>
3	61	<auto>

- Select the **Boundary-Limited Area Auto Trace**  button.
- Click and drag a rectangle over some part of the blue curve. Points will be auto created only within the rectangle you drew. Unlike in the **Auto Pick Points by Grids** method, the **Boundary-Limited Area**

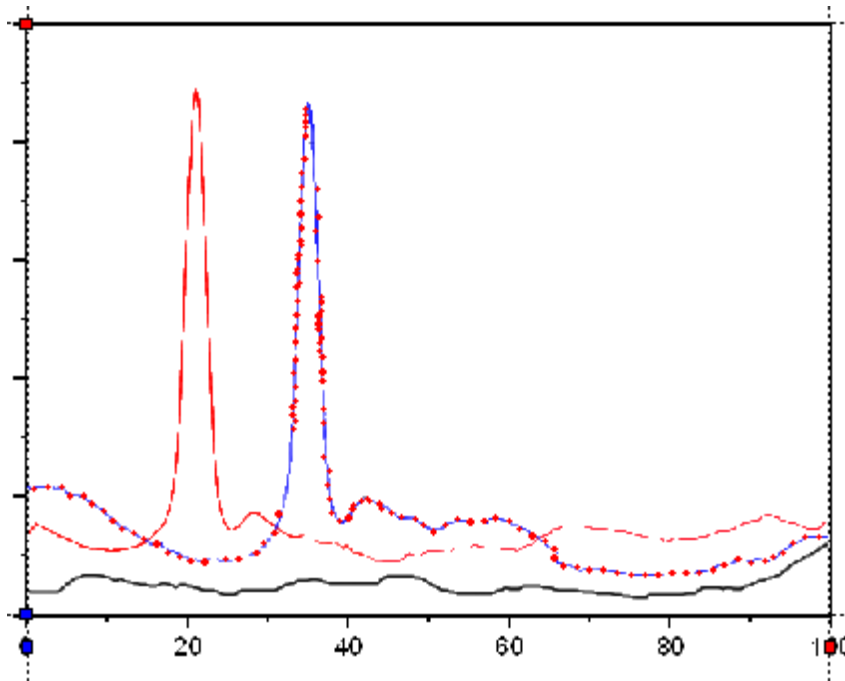
**Auto Trace** method creates more points than just where the curve intersects with the grids.



6. Click the **Reorder Points**  button to set the captured points in order.
7. Click the **Set Label**  button.
8. Click on the selected peak point of blue line and press the **Enter** key.
9. Enter **Blue Peak** in the dialog to add a label to the peak of the blue line.

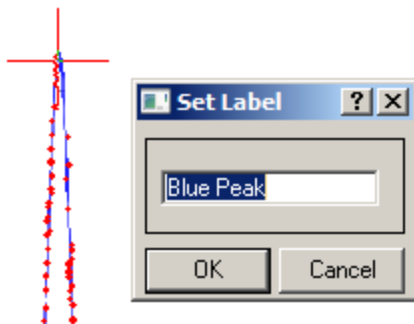

10. To add another label on the peak of the digitized red line, click the **Set Label** button again to release it first.
11. Select Line 1 to show digitized red points on the Image. Repeat the same process, this time set the label as **Red Peak**.

12. Select the **Go To Data**  button. You can see the Labels added are in corresponding Label rows.

	A(X1)	B(Y1)	C(L1)	D(X2)	E(Y2)	F(L2)	G(X3)	H(Y3)
Long Name		PickedDat			PickedDat			PickedDat
Units								
Comments	Data for the Red			Data for the black			Data for the Blue	
F(x)	Curve			baseline			Curve	
Scale Type	Linear Scale	Linear Scale		Linear Scale	Linear Scale		Linear Scale	Linear Scale
19	18.75201	0.59941		19.26297	0.12288		16.70818	0.29722
20	18.92233	0.71564		20.96617	0.11126		17.73009	0.26235
21	18.92233	0.77376		22.66936	0.09963		18.92233	0.24492
22	19.09265	0.83187		24.37256	0.08801		20.45521	0.2333
23	19.09265	1.00621	Red Peak	26.07576	0.08801		22.1584	0.22167
24	19.26297	0.9481		27.77895	0.09963		23.8616	0.22167
25	19.26297	0.88998		29.48215	0.09963		25.5648	0.21586
26	19.43329	1.12244		31.18534	0.10545		27.26799	0.23911
27	19.43329	1.06433		32.88854	0.12869		28.97119	0.26816
28	19.60361	1.29678		34.59174	0.14031		29.99311	0.29141
29	19.60361	1.25029		36.29493	0.14613		30.8447	0.33209
30	19.60361	1.18055		37.99813	0.12869		31.35566	0.38439

13. With the image window active, click the **Go To Graph**  button.

All the curves resulting from the picked points will show in one graph window.

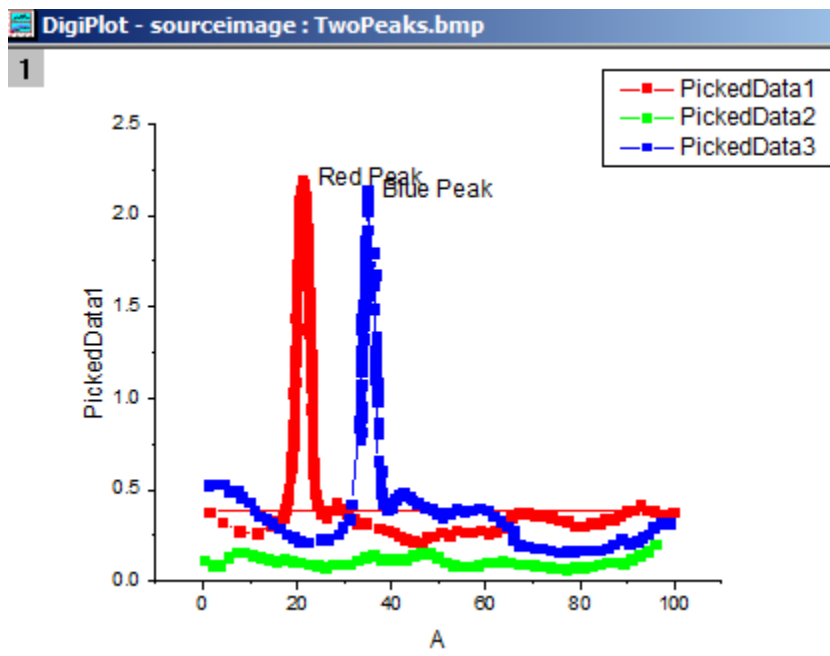

14. You can save the project with the Digitizer in it. When you open the project in the future, there will be a Digitizer... button on the image and you can click it to continue Digitizing.

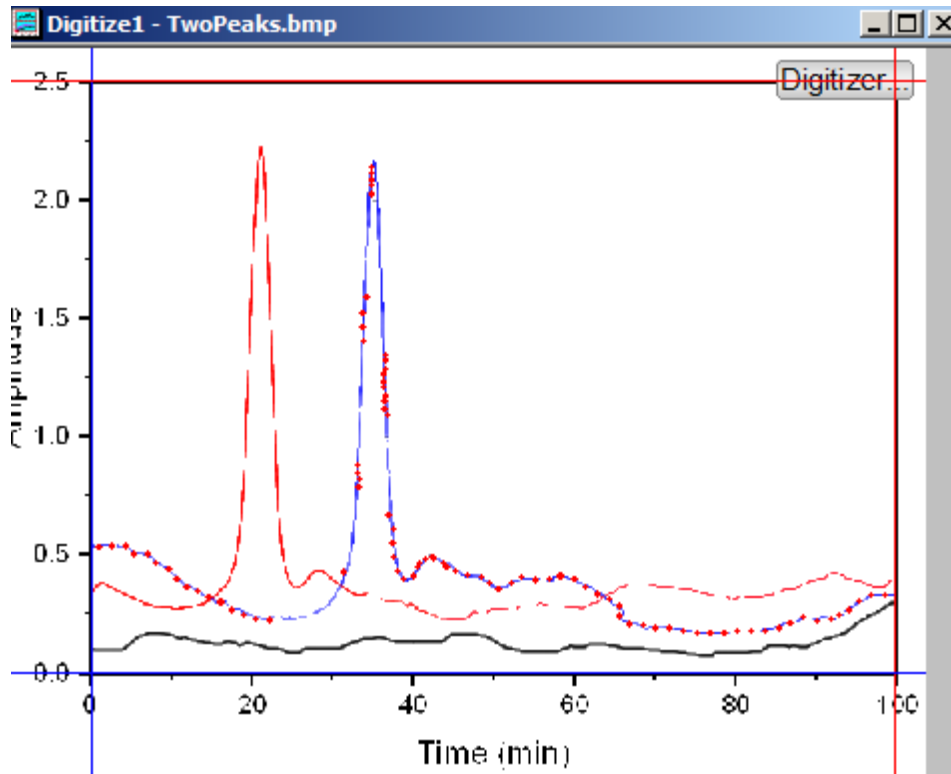

#### 9.4.3.3.4 Set Axes for Polar and Ternary Plots

The following section only explains how to define axes for images with polar or ternary coordinate systems using the Enhanced Digitizer. Once the axes are defined the same methods outlined above can be used to digitize the image.

##### Polar Coordinates

1. Click the **Import**  button in the Digitizer dialog.

- Browse to the <Origin EXE Folder>\Samples\Import and Export folder and select **PolarCoordinate.bmp**. The data plots in this image are in the polar coordinate system.

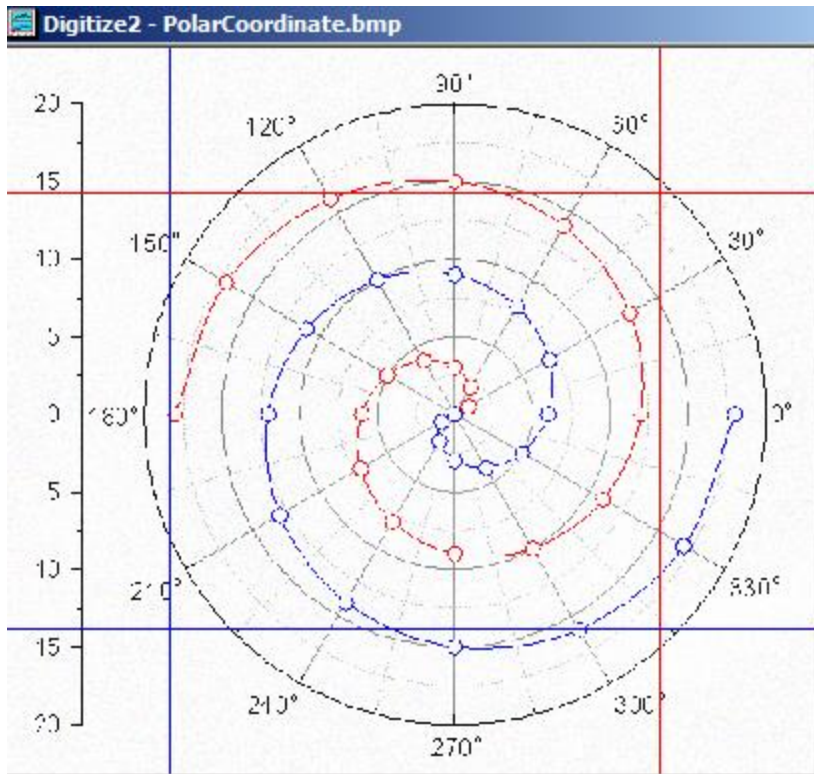

- By default the Digitizer uses the Cartesian Coordinate system. Select **Axes:Polar Coordinate...** menu to open the **Polar Coordinate Settings** dialog box.

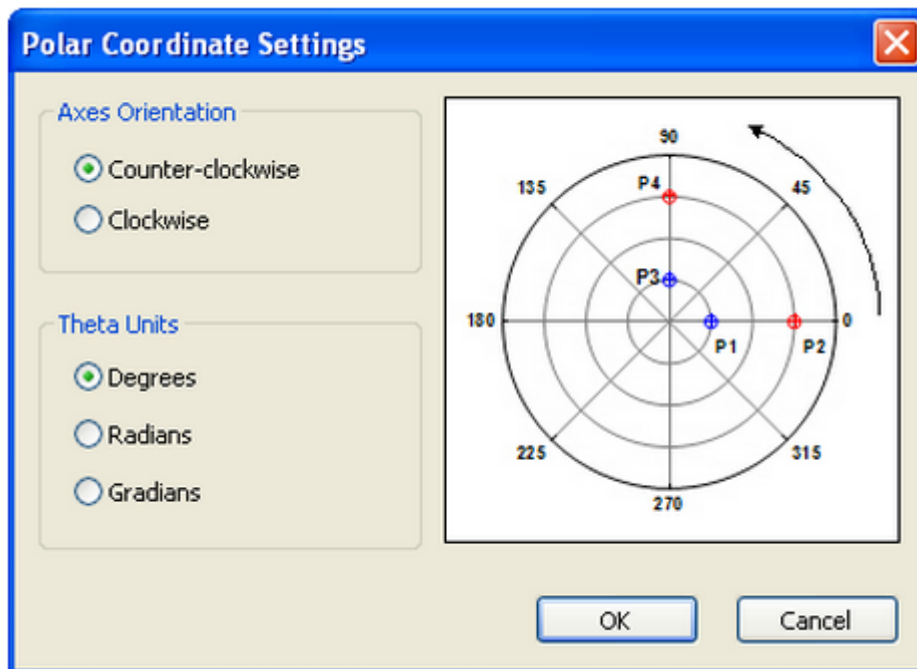

- We can accept the default orientation and theta unit and click **OK**. Two line objects with anchor points show on the image.

To set the axes for polar coordinates, we need to make sure each line object follows the same radius line, i.e. **P1 & P2**, or **P3&P4** need to be at the same angle.

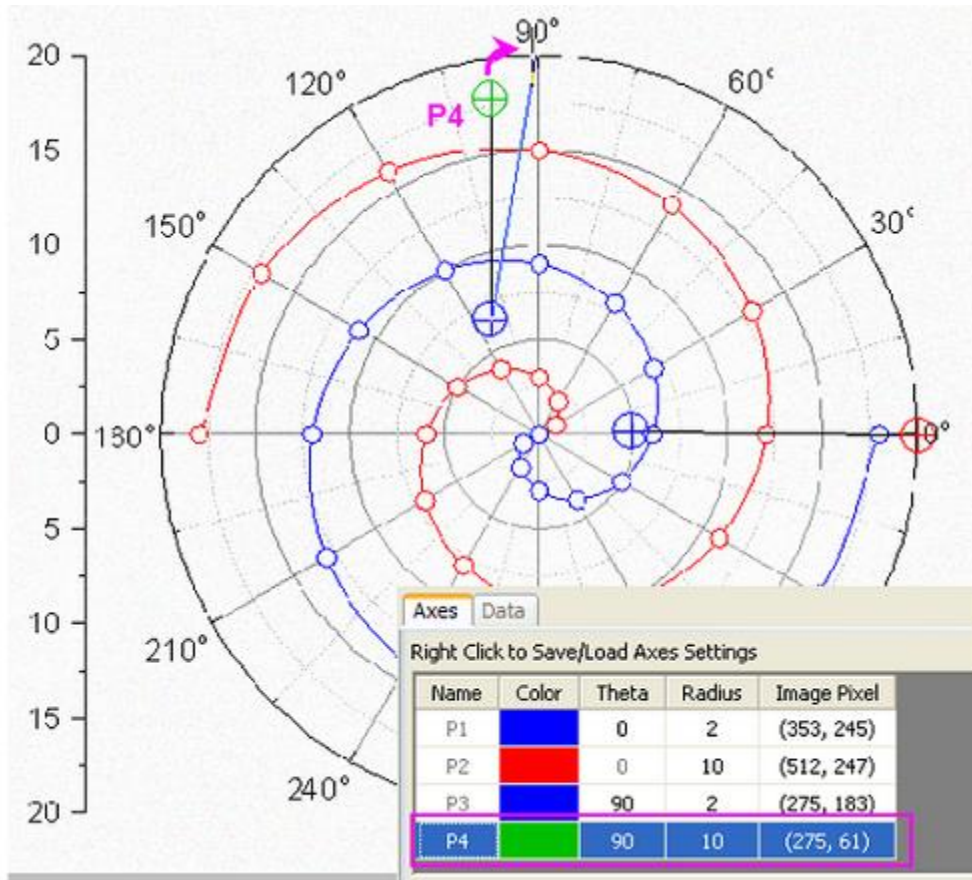

- Drag each line's anchor points to known positions. Note: You can press the **Space** key to make the cursor bigger so that it is easier to locate the desired position.

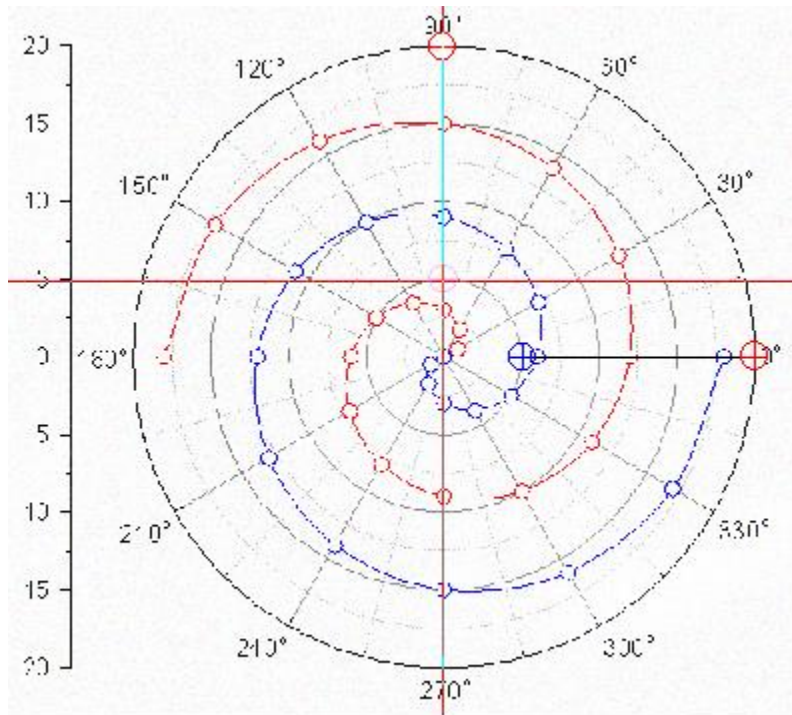

- Enter the corresponding **Theta** and **Radius** values on the Axes tab of the Digitizer.

Axes		Data		
Right Click to Save/Load Axes Settings				
Name	Color	Theta	Radius	Image Pixel
P1		0	5	(355, 247)
P2		0	20	(512, 247)
P3		90	5	(301, 194)
P4		90	20	(301, 37)

**Ternary Coordinate**

- Click the **Import**  button in the Digitizer dialog.
- Browse to the *<Origin EXE Folder>\Samples\Import and Export* folder and select **TernaryCoordinate.bmp**. The data plots in this image are in the ternary coordinate system.



3. Select **Axes:Ternary Coordinate...** to open the **Ternary Coordinate Settings** dialog.

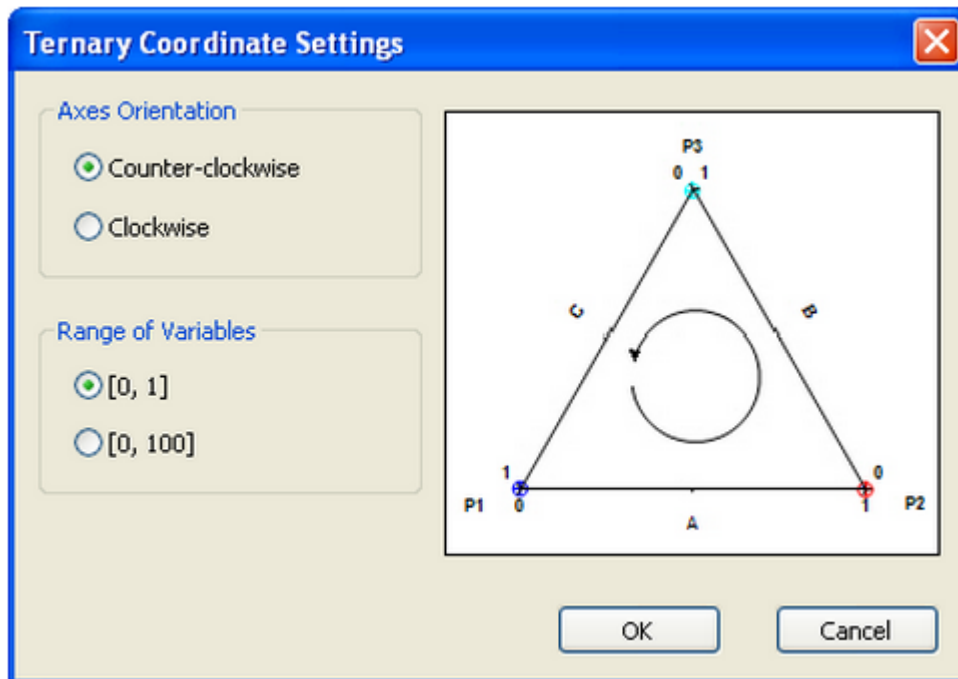

4. Specify the **Axes Orientation** and **Range of Variables** (i.e. whether the ternary plot is normalized to 0 - 1 or 0 - 100). For this example, accept the default settings and click **OK**. Three anchor points are added to the image.
5. Drag these three points to the three vertices of the ternary plot.

- Similarly to the polar coordinate anchor point control, the row of selected anchor points in the graph will be highlighted on the **Axes** tab:

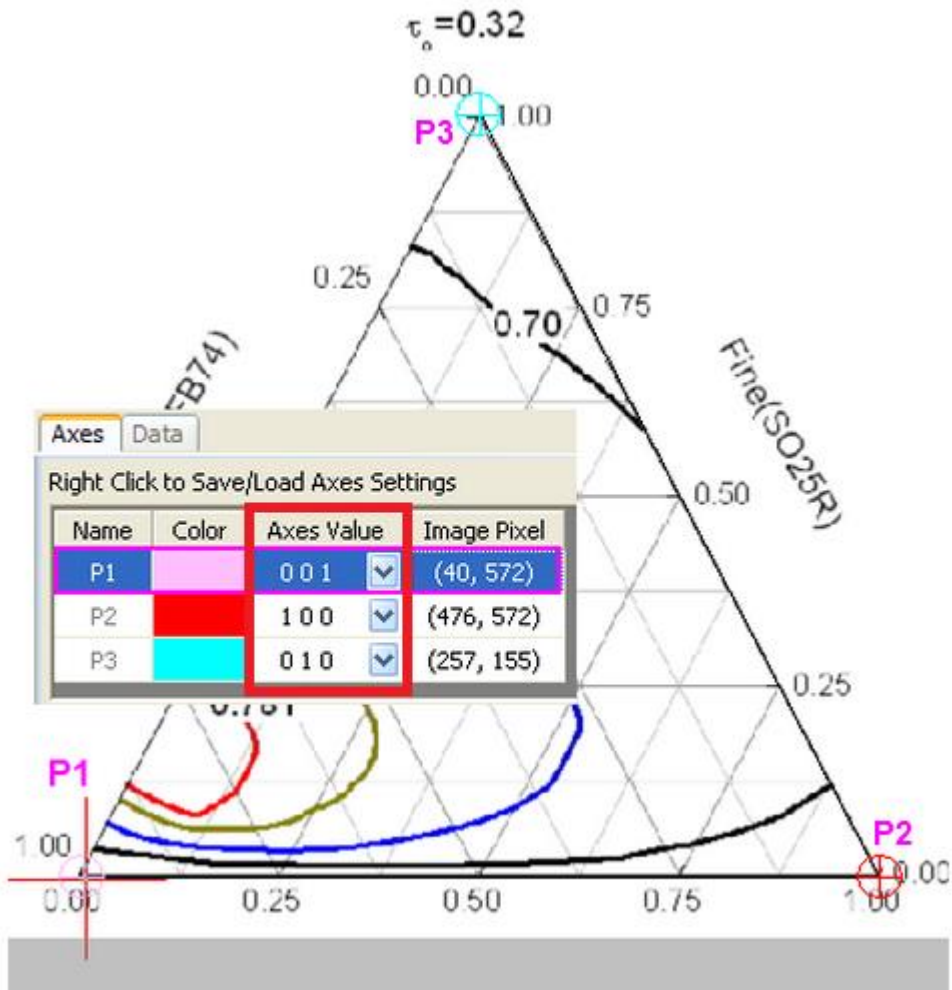

- The **Axes Values** of each point are **X Y Z** respectively. The X, Y, Z values of **P1** in the ternary image are **0 0 1** because P1 is at the end of the Z axis. Similarly P2 and P3 lie at the end of the X axis and the Y axis, so the X,Y, Z values should be 1 0 0 and 0 1 0 respectively. Logically therefore, P1, P2 and P3 can't be same values.

# 10 Exporting and Presentation

## 10.1 Exporting and Presentation

### 10.1.1 Exporting

- [Exporting Graphs](#)

### 10.1.2 Presentation

- [Pasting or Embedding Graphs in Other Applications](#)
- [Send Graphs to PowerPoint](#)

## 10.2 Exporting

### 10.2.1 Exporting

- [Exporting Graphs](#)

### 10.2.2 Exporting Graphs

#### 10.2.2.1 Summary

When you have completed your graphs for publication, exporting your final results is very easy with Origin. The graph export is highly customizable. You can specify the size of the image, the file format, and other advanced settings such as color format.

#### 10.2.2.2 What you will learn

- How to export a graph and specify the settings.
- How to export specified graphs in the project.

#### 10.2.2.3 Export a graph as an eps image

This tutorial is associated with the Contour project (C:\ProgramData\OriginLab\(\version number)\Origin\Central\Graphing\Contour.opj)

1. In the Project Explorer, browse to *XYZ Contour* folder, and make the graph window active.

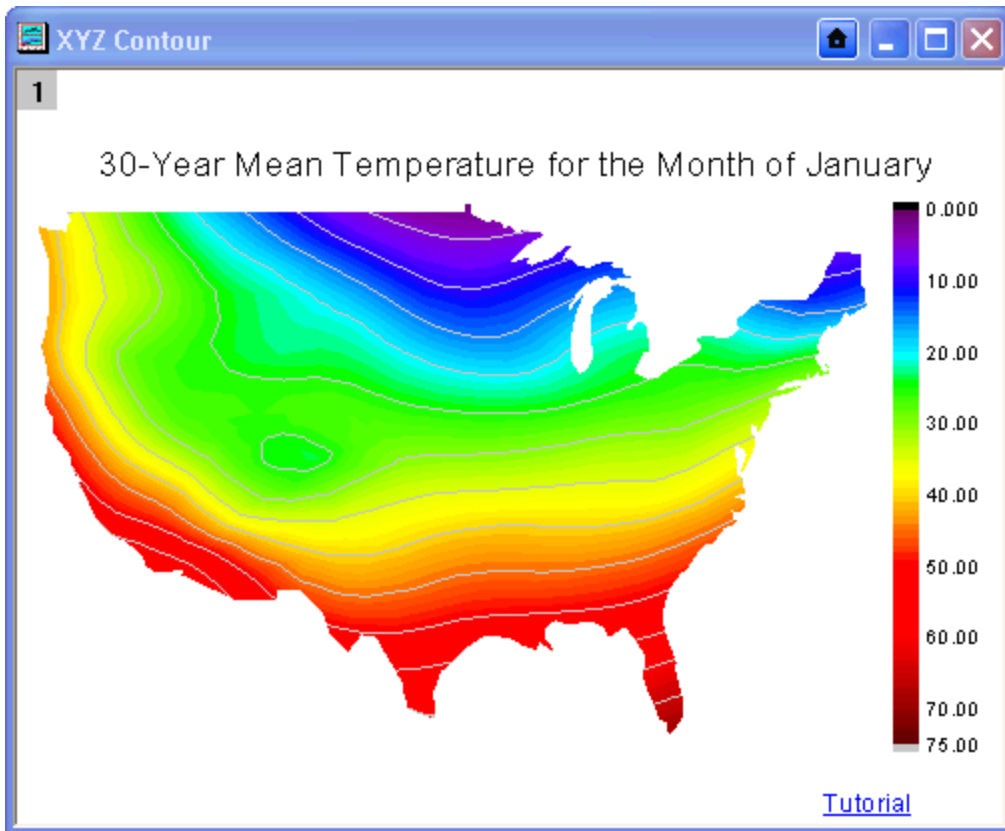

2. With the graph window active, select **File: Export Graphs** from the Origin menu to open the **expGraph** dialog.
3. Click the **Auto Preview** check box. Then the graph will auto preview the temporary copy in the right panel of the dialog.

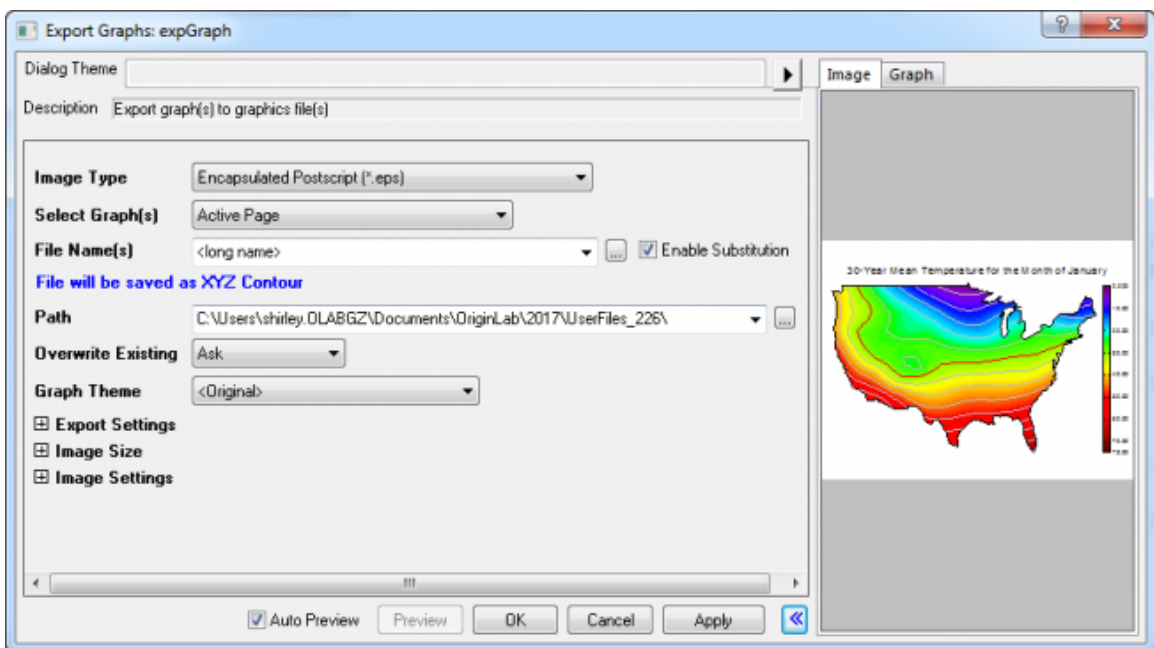

- 4.



If your **Image** tab Preview appears blank, you are likely viewing only a corner of a very large raster image. Starting with **Origin 2019**, you can right-click in the **Image** tab and choose a zoom level for previewing your raster or vector images. By manipulating the size of the Preview panel + the Image tab zoom level, you'll be able to view your entire graph.

5. Specify the following settings to export the graph:
  - Customize the **File Name** to **My Graph**.
  - Expanding the **Export Settings** node, select **Border** from the **Margin Control** drop-down list and type **3** in the **Clip Border Width** box.
  - Expanding the **Image Size** node, uncheck **Auto** check box for **Fit Width** and set width to **5**.

<b>Image Type</b>	Encapsulated Postscript (*.eps)
<b>Select Graph(s)</b>	Active Page
<b>File Name(s)</b>	My Graph <input type="checkbox"/> Enable Substitution
<b>File will be saved as My Graph</b>	
<b>Path</b>	C:\Users\shirley.OLABGZ\Documents\OriginLab\2017
<b>Overwrite Existing</b>	Ask
<b>Graph Theme</b>	<Original>
<b>Export Settings</b>	
Use Current Speed Mode Display for Export	Apply Page Setting
Margin Control	Border
Clip Border Width	3
<input type="checkbox"/> Advanced	
<b>Image Size</b>	
Original Page Size	Width 10.72 inch x Height 8.21 inch
Clipped Page Size	Width 12.13 inch x Height 8.02 inch
Specify Size in:	inch
Rescaling	Width
Fit Width	5 <input type="checkbox"/> Auto
Fit Height	3.31 <input checked="" type="checkbox"/> Auto
<b>Image Settings</b>	

- Click the triangle button to the right of the **Dialog Theme**. Select **Save As** from the shortcut menu. The **Theme Save as** dialog opens.

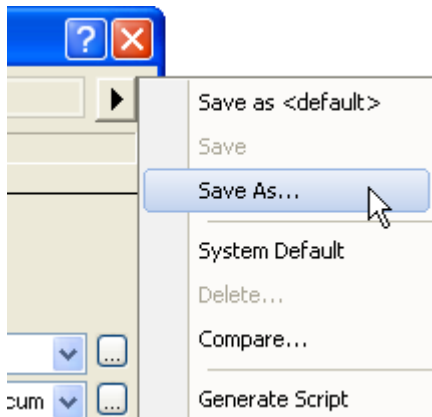

- In the **Theme Save as** dialog, enter **My EPS Export** as **Theme Name**. And click **OK**.
- Click the **OK** button in the **expGraph** dialog, then *My Graph.eps* is created in your **User File Folder**. And the graph path will display in the **Message Log**.

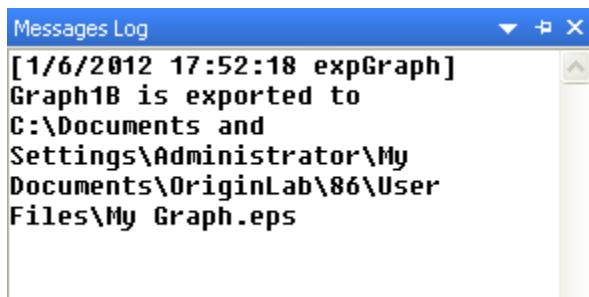

- Repeat export a graph using the setting from above, select the theme **My EPS Export** in the fly-out menu of the export graph tool directly.



Or

Click the right-sided triangle button to the right of the Dialog Theme in the **expGraph** dialog. From the

shortcut menu, pick **My EPS Export**. The settings from that theme will then be loaded in the dialog.

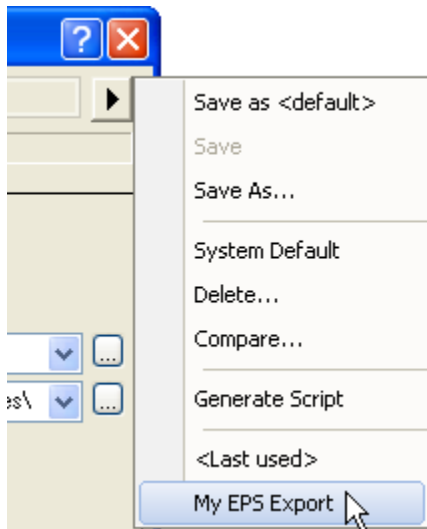

#### 10.2.2.4 Export the specified graphs

1. Redo steps 1 and 2 from above.
2. In the **expGraph** dialog, select **Portable Network Graphics (\*.png)** for **Image Type**.
3. Select **Specified** from the **Select Graph(s)** drop-down list. Click the  button to the right of the **Graph Page** edit box to open the **Graph Browse** dialog.

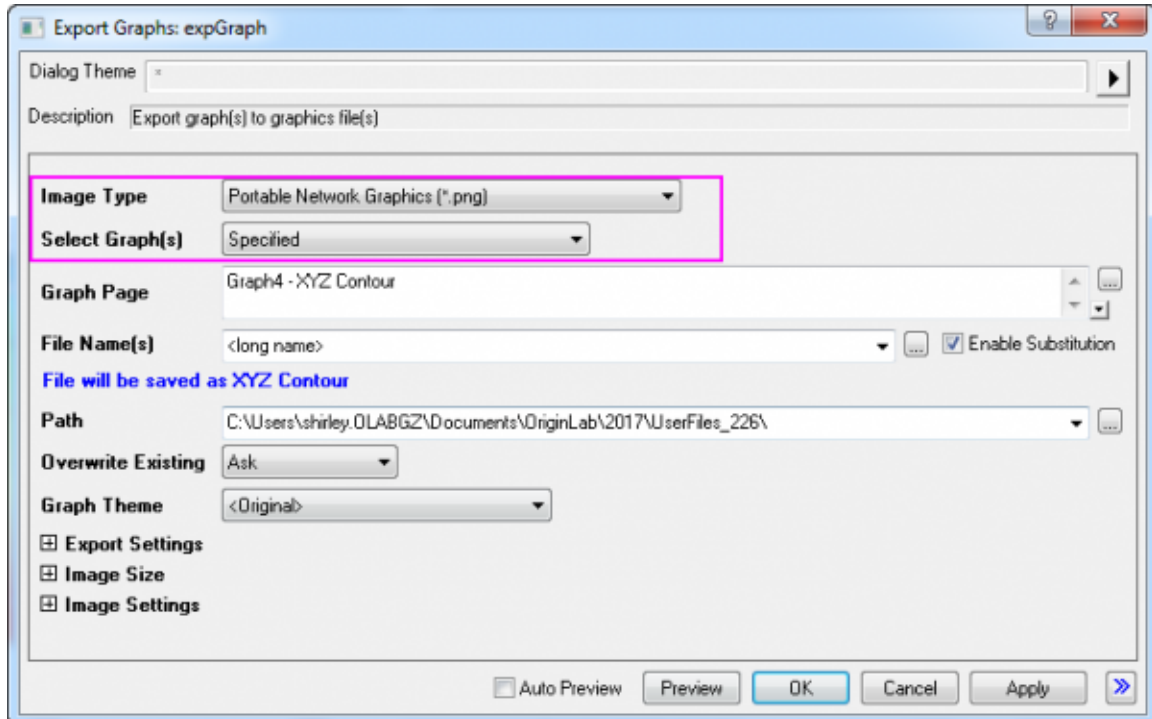

4. In the **Graph Browse** dialog, all the graphs in this project will list in the left panel of the dialog. Select **Graph8** in the left panel, then the preview panel will show a preview of the graph.

- Click the  button to add the selected graph to the right panel, or double-click selected graph in left panel to add to the right panel.

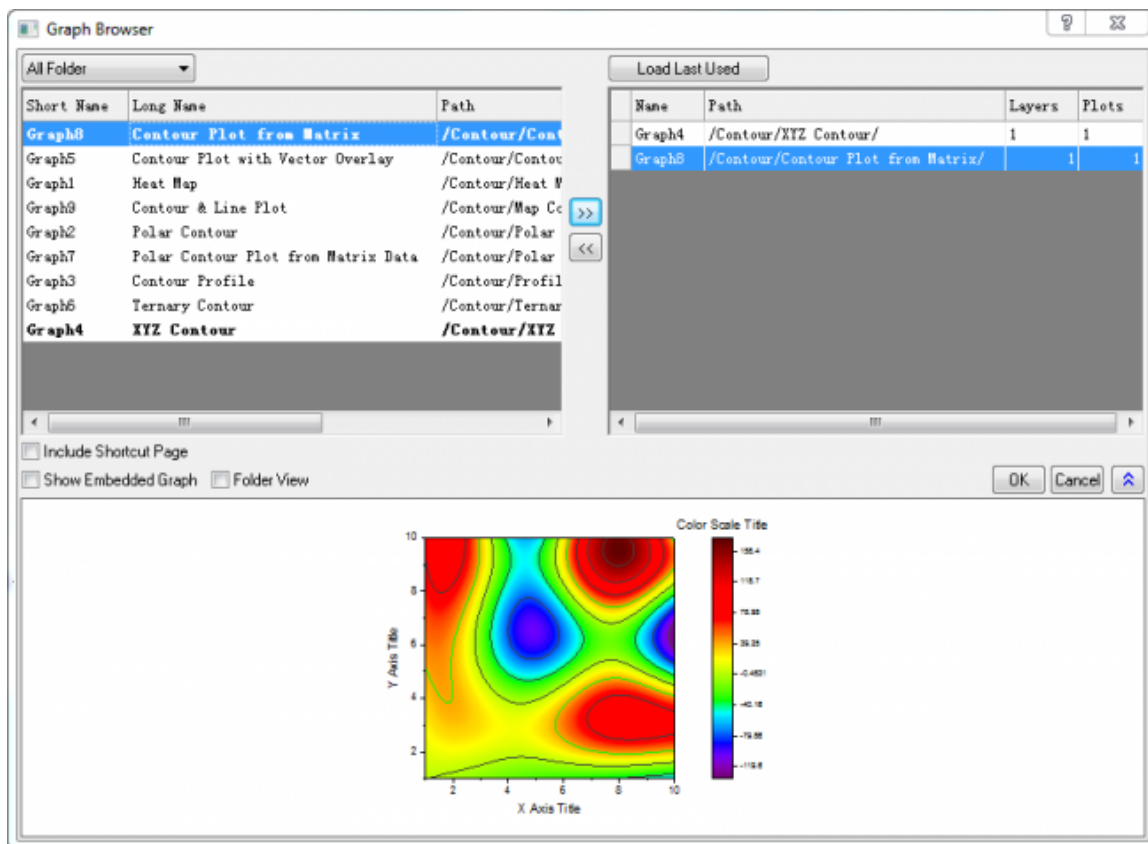

- Then click **OK** button, the specified graphs will show in the **Graph Page** box.

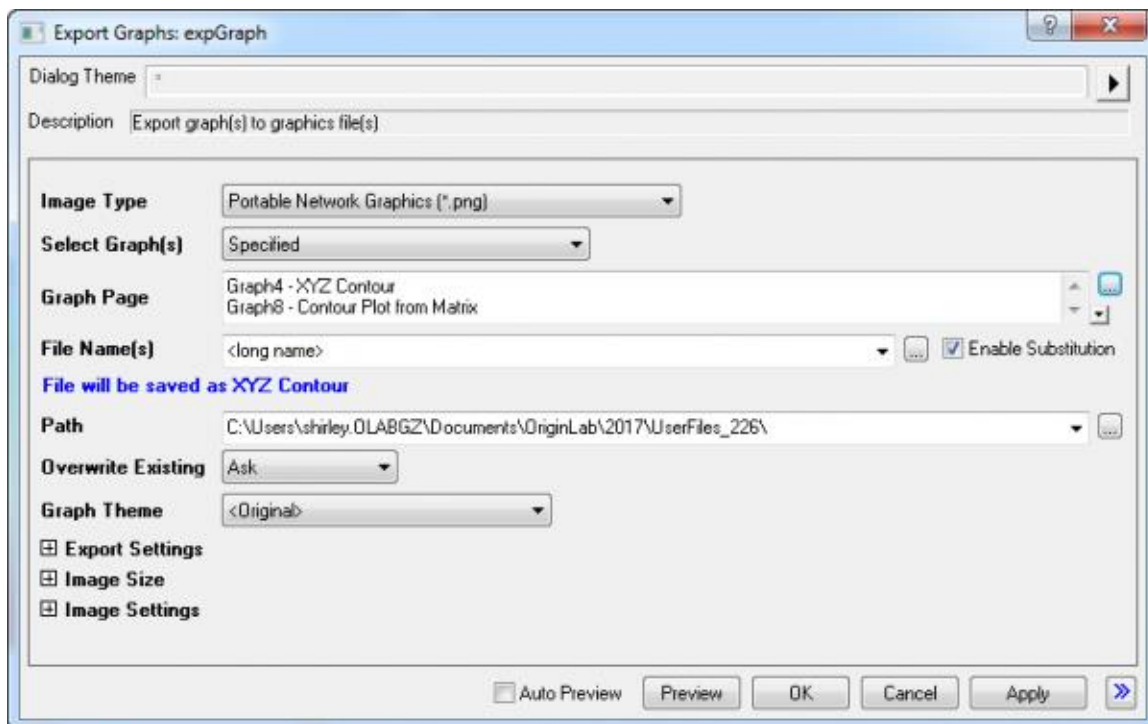



- Expanding the **Image Size** node, select **pixel** from the **Specify Size in** drop-down list. And uncheck the **Auto** check box for **Fit Width** and set width to **600**.

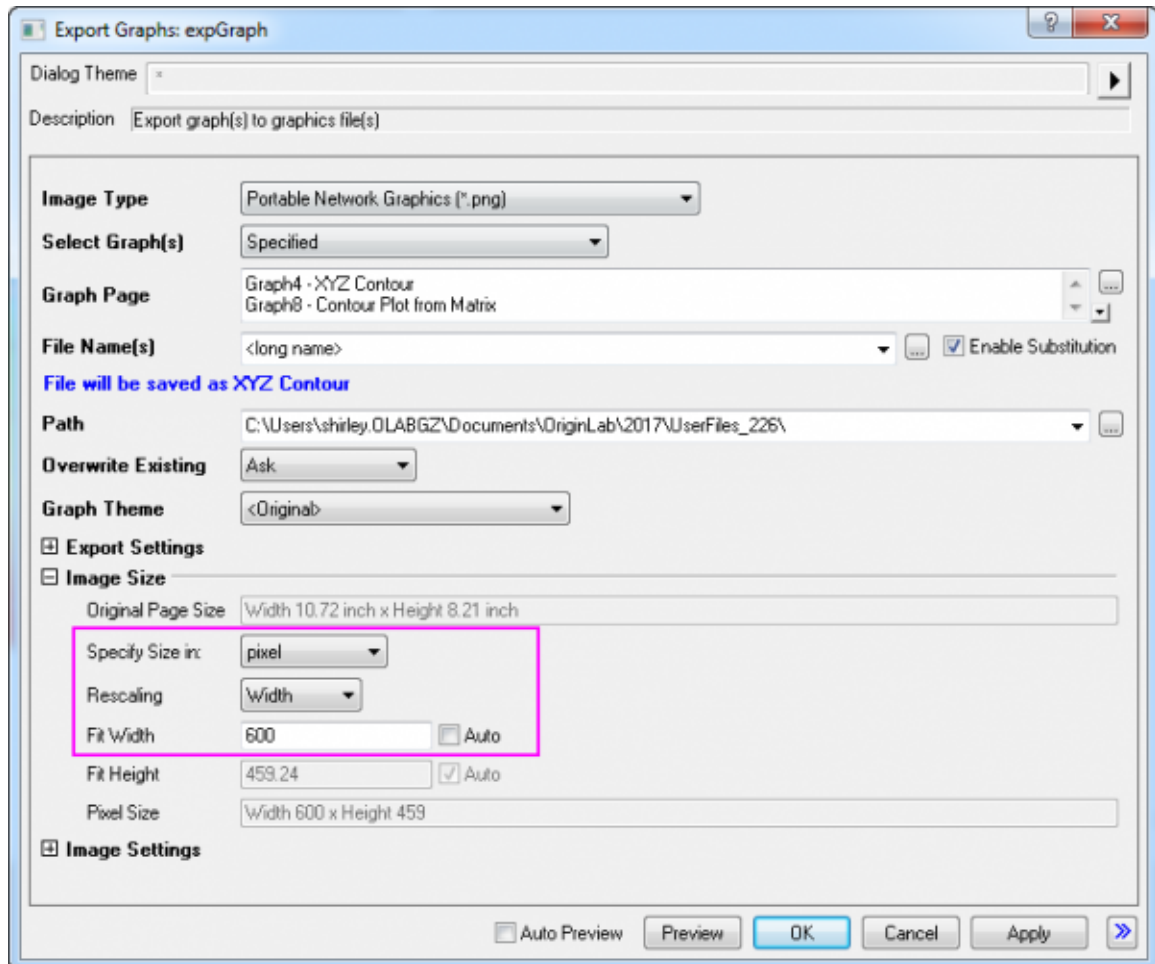

- Click **OK** button in the **expGraph** dialog, then two images are created. And the graph path will display in the **Message Log**.

```

Messages Log
[12/7/2016 17:35:59 expGraph]
Graph4 is exported to C:\Users
\shirley.OLABGZ\Documents
\OriginLab\2017\UserFiles_226\XYZ
Contour.png
Graph8 is exported to C:\Users
\shirley.OLABGZ\Documents
\OriginLab\2017\UserFiles_226
\Contour Plot from Matrix.png

```

## 10.3 Presentation

### 10.3.1 Presentation

- [Pasting or Embedding Graphs in Other Applications](#)
- [Send Graphs to PowerPoint](#)

## 10.3.2 Pasting or Embedding Graphs in Other Applications

### 10.3.2.1 Summary

It is possible to insert Origin graphs to other applications (e.g. Microsoft® PowerPoint/Excel/Word), either by object linking or embedding. Both linked and embedded graphs can be later edited with Origin.

The difference is that embedded graph is contained in the destination file while the linked graph is not. A linked graph can be dynamically updated if the source graph is changed.



OLE embedding is not supported by [Origin's Master Page feature](#). When exporting graphs containing master items to MS Office or other documents, you should insert the graph as an image. For more information, see [Adding common elements to an MS Word or PowerPoint file](#).

### 10.3.2.2 What you will learn

This tutorial will show you:

- How to copy and paste the graph to Word as a linked graph.
- How to copy and paste the graph to Word as a embedded graph
- How to edit linked/embedded graphs after inserting to Word.

### 10.3.2.3 Steps

1. Launch Origin, open the OffsetY.opj project from <Origin program folder>\Samples\Graphing\. This project contains a graph (Graph 1).

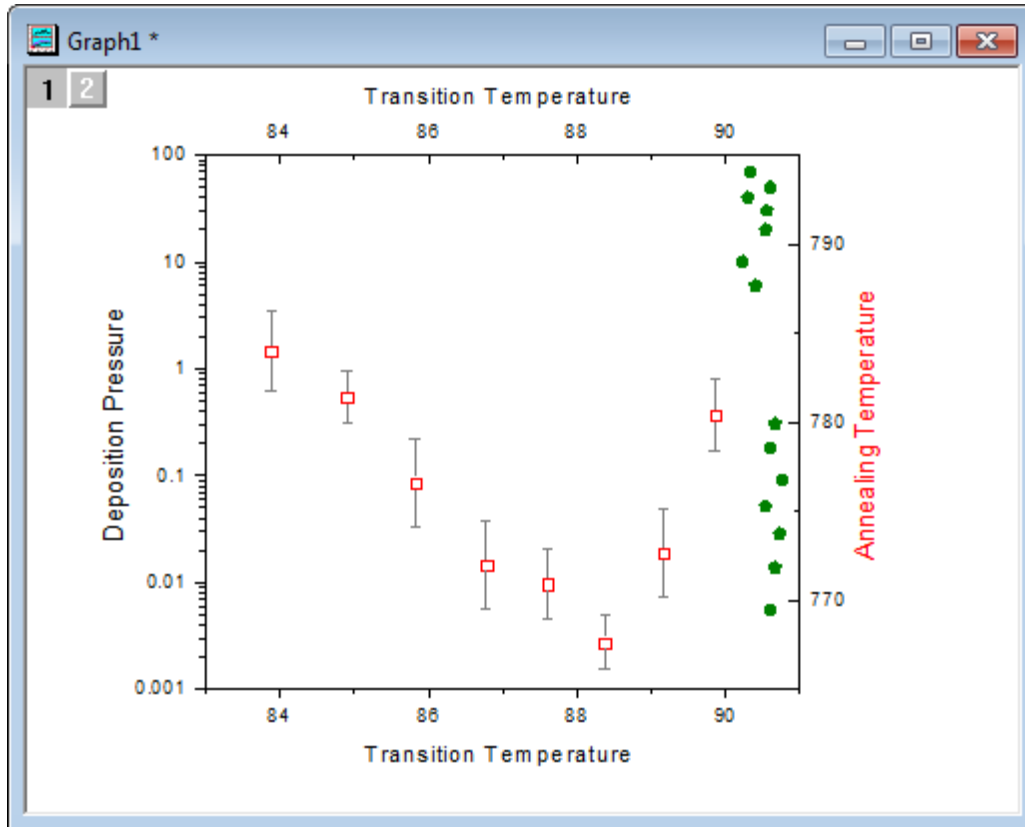

2. With the graph window active, select **Edit: Copy Page**.



Another menu option **Copy Graph as Picture** are also available. You can select it to insert the graph into Word (or other applications) as a picture. Then, you are not allowed to edit it with Origin anymore.

3. Create a blank page in Microsoft® Word (Here, I am using Word 2010). In the **Home** tab, select **Paste Special...** under the **Paste** option.

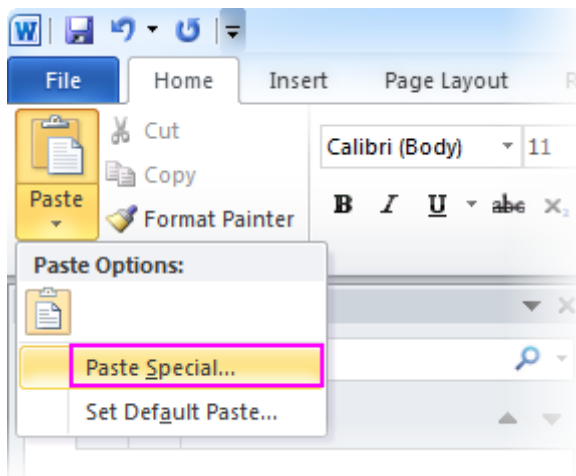

4. In the **Paste Special** dialog, select the **Paste link** radio button and then choose *Origin Graph Object* in the **As** list. Click OK to close the dialog.

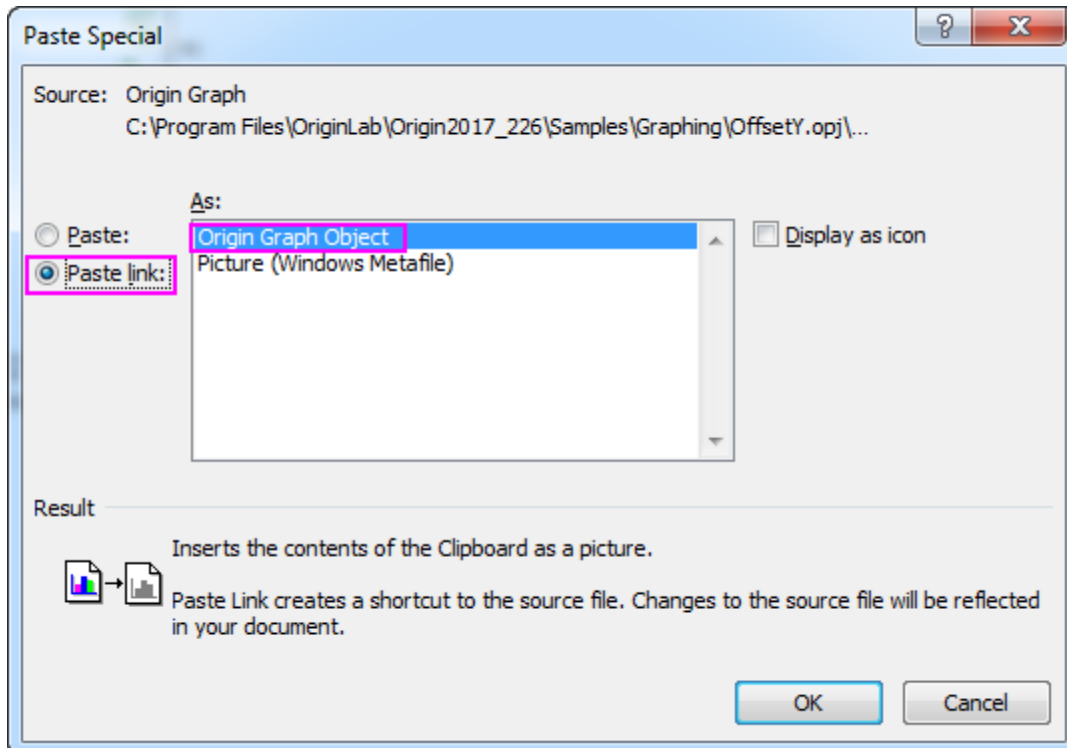

The graph will be inserted to current position a linked object.

5. Open the **Paste Special** dialog again similarly as the previous step.

6. This time, select the **Paste** radio button then choose **Origin Graph Object** in the **As** list. Click OK to close the dialog. The graph will be pasted again, but as an embedded object.

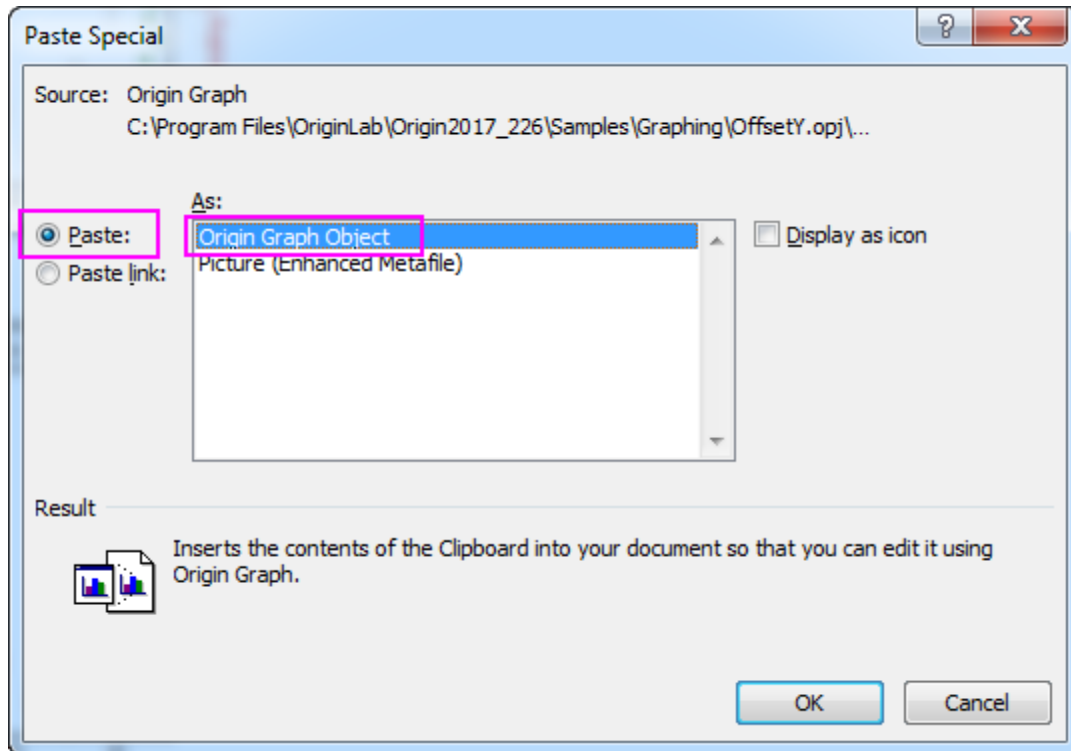

7. Go back to the OffsetY.opj file in Origin, double click on the olive dot plot in Graph 1, bring up the **Plot Details** dialog, change the symbol color to **Violet** and click OK to close the dialog.
8. Now switch to Word file we just created, right-click on the first graph(the linked one), and choose **Update Link** from the fly-out menu. The color of the dot plot in this graph will be changed to violet.

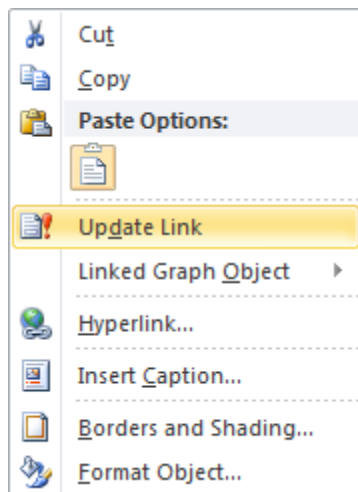

9. Right-click on the second graph(the embedded one), and choose **Graph Object: Edit** to reopen the graph in Origin. Note that the graph name is **Graph in Document1**, indicating that the graph is contained in the

destination file.

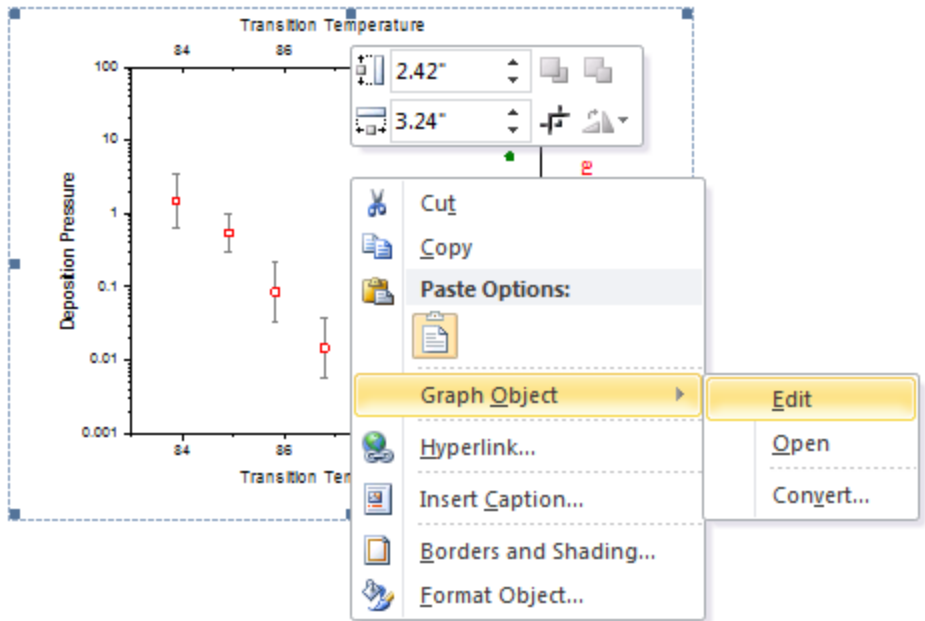

- In the **Graph in Document1**, change the color of olive dot plot to blue similar as previously, and close Origin. Note that the linked graph and the embedded graph looks different now.

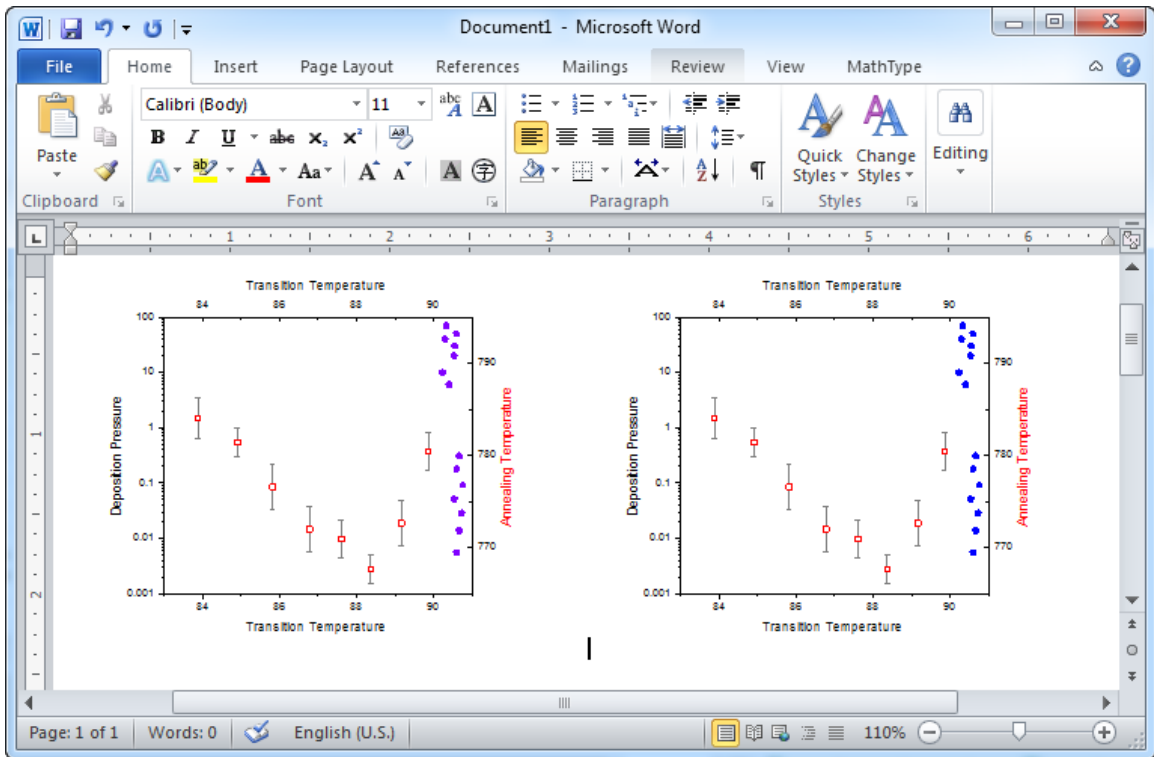

### 10.3.3 Send Graphs to PowerPoint

#### 10.3.3.1 Summary

This tutorial will show you how to send the specified graphs to an existing PowerPoint file by inserting graphs from a specified slide on and also copy that slide style, logo, layout, etc. User will no longer need to set Slide Master in PowerPoint.

Minimum Origin Version Required: 2016 SR0

### 10.3.3.2 What you will learn



This tutorial will show you how to:

- send specified graphs to existing PowerPoint file.

### 10.3.3.3 Steps

This tutorial is associated with the Column and Bar project: <Origin EXE Folder>\Samples\Graphing\Column and Bar.opju and the PPT file: <Origin EXE Folder>\Samples\Import and Export\Column\_Plots\_in\_Sample\_OPJ.pptx

We are going to send most graphs in **Column and Bar** project to the above PPT file which consists of four slides: 1st slide is title; 2nd slide is table of contents; 3rd slide is blank; 4th slide is End page. All the sent graphs will be inserted into this PPT file starting from the 3rd slide and using the same style as starting slide.

1. Open the sample project **Column and Bar**
2. Click the **Send Graphs to Powerpoint** button  to open the **pef\_pptslide** dialog.
3. Select **Specified** for the **Select Graph(s)** drop-down list, click the browse button  beside the **Graph Page** box to open the **Graph Browser**. In this dialog, select **Active Folder(Recursive)** for the top-left drop-down list, and then select all graph listed in the left panel except **Graph 5B**, click the right arrow button  to move them to right panel as below:

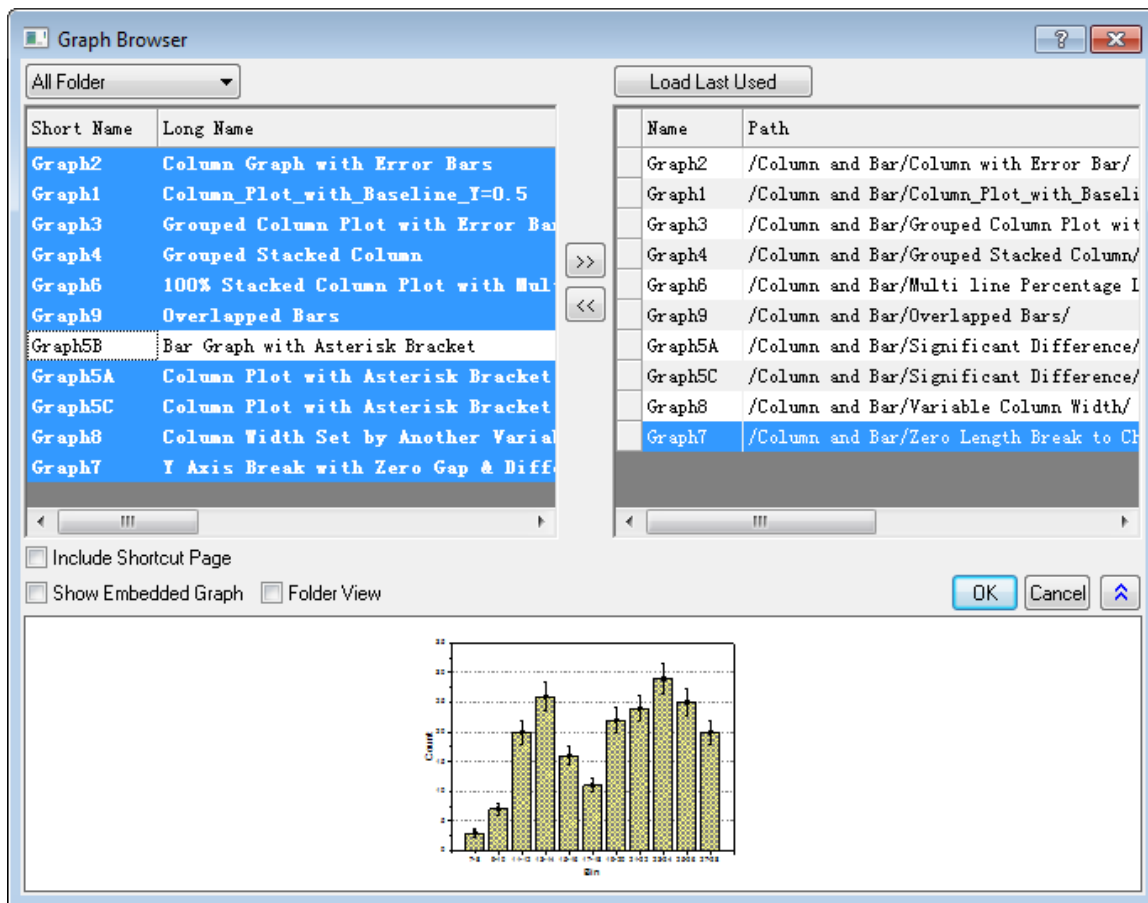

- Click OK button. All selected graphs will be listed in the **Graph Page** text box, you can reorder the graphs. Expand the **Slide Margin** branch, set the **Top Margin(%)** text box to 8.

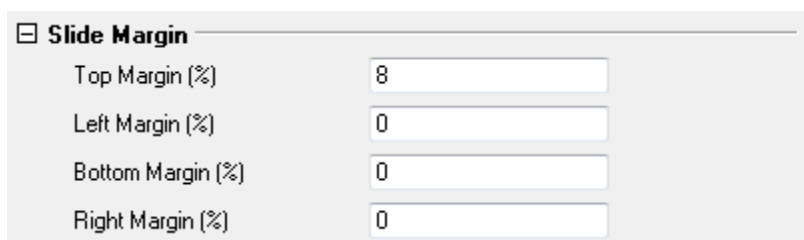

- Select **Top of Slide** for the **Title Line** drop-down list and set **Title Mode** to **Window Long Name**.

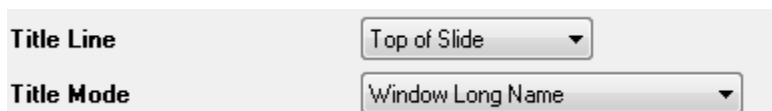

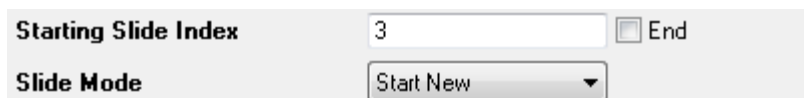

- Set **Starting Slide Index** to 3 to insert all these graphs to the existing PPT file by starting from the 3rd slide with same style as starting slide. Then set **Slide Mode** to **Start New**.





- Click the browse button  beside the **Load File/Template(Optional)** box to locate the existing PPT file *Column\_Plots\_in\_Sample\_OPJ.pptx* under the <Origin EXE Folder>\Samples\Import and Export folder. Then specify the path to save the new PPT file in the Save File As(Optional) text box.

<b>Load File/Template(Optional)</b>	C:\Program Files\OriginLab\Origin2017\	
<b>Save File As(Optional)</b>	D:\PPT file\Column Bar plots.pptx	
<b>PPT will be closed at the end.</b>		

- Then you will get the final PPT file.



# 11 Collaboration and Connectivity

## 11.1 Collaboration and Connectivity

### 11.1.1 Connectivity

#### 11.1.1.1 [Excel](#)

- [Working with Excel](#)

## 11.2 Connectivity

### 11.2.1 Connectivity

#### 11.2.1.1 [Excel](#)

- [Working with Excel](#)

### 11.2.2 Excel

#### 11.2.2.1 [Excel](#)

- [Working with Excel](#)

#### 11.2.2.2 [Working with Excel](#)

##### 11.2.2.2.1 [Summary](#)

Origin provides flexible ways to interact with Excel. You can either import Excel data into an Origin workbook, or open an Excel book inside Origin. If you require full access to all of Origin's graphing and analysis features, you will probably want to import your Excel data files into Origin. If it is important to maintain a separate Excel workbook file—perhaps, so that other colleagues who do not work with Origin have access to that file—you will probably want to open your Excel data files directly. We give a brief introduction to working with Excel in this tutorial.

##### 11.2.2.2.2 [What you will learn](#)

This tutorial will show you how to:

- Copy-Paste data from Excel with full precision.
- Import an Excel file into an Origin workbook.
- Open an Excel file in Origin.
- Save an Excel file with path relative to the Origin Project file.

### 11.2.2.3 Copy-pasting Data from Excel

It may be desirable at times to simply copy+paste data from Excel to Origin instead of importing or opening Excel. These steps show that such a copy-paste operation can bring in data with full precision.

1. Launch Excel and Origin separately.
2. Open the file <Origin Installation Folder>\Samples\Graphing\ExcelData.XLS in Excel.
3. Select columns B through L. Right click, bring up the **Format Cells** dialog, and set the number of decimal places to 2. Now Excel will show fewer decimal places.

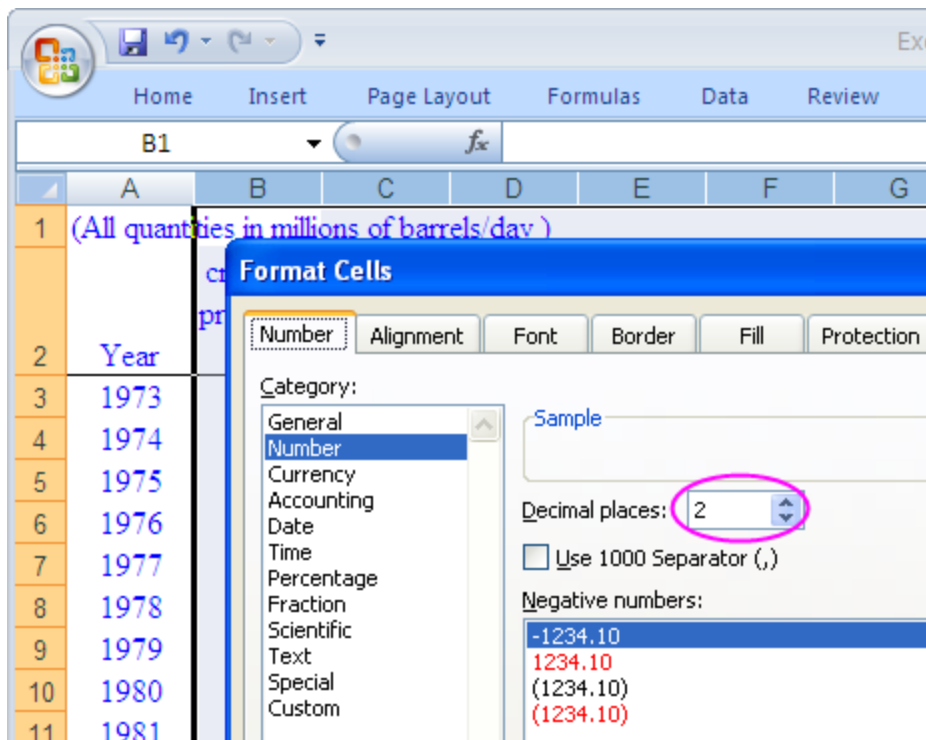

4. Click on the top left cell in the Excel sheet to select the entire sheet, right-click and select **Copy**, or use the keyboard shortcut **CTRL+C** to copy.

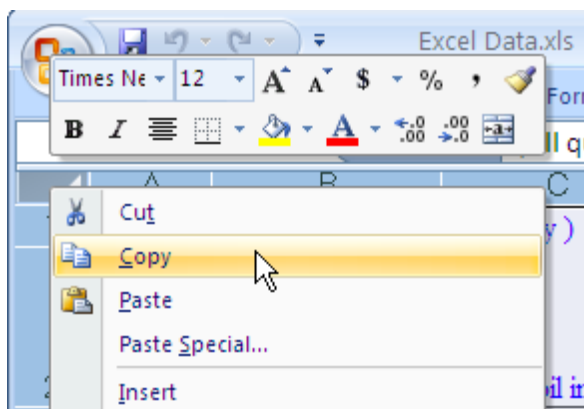

- 5. In a new book in Origin, place the cursor in row 1 of column 1 and press **CTRL+V** or right click and **Paste**.

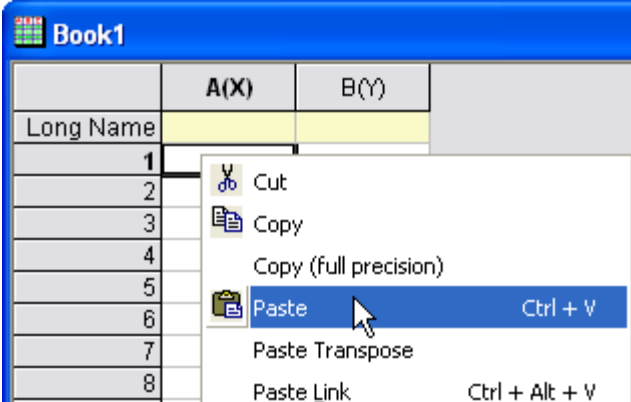

- 6. Note that the numbers come into Origin with full precision, not the number of displayed digits in Excel. As shown in the example below, the number circled value is displayed with 2 decimal places in Excel (0.35) but imported with all three decimal places into Origin (0.348).

C7(Y)	C8(Y)	C9(Y)	C10(Y)	C11(Y)
56.39	0.348	0.307	0.915	
55.91				
55.48				
58.74				
61.63	petroleu	imports	petroleu	ation
63.3	m	as % of	m	petroleu
65.17	2	consumpt	U.S.	consumpt m use as
63.07	3	56.39	0.35	0.31 0.92
60.87	4	55.91	0.35	0.30 0.94
59.5	5	55.48	0.36	0.29 0.99
58.74				

- 7. In Origin, right click on the row 1 header and select **Set as Comment** to make this row an Origin column comment.

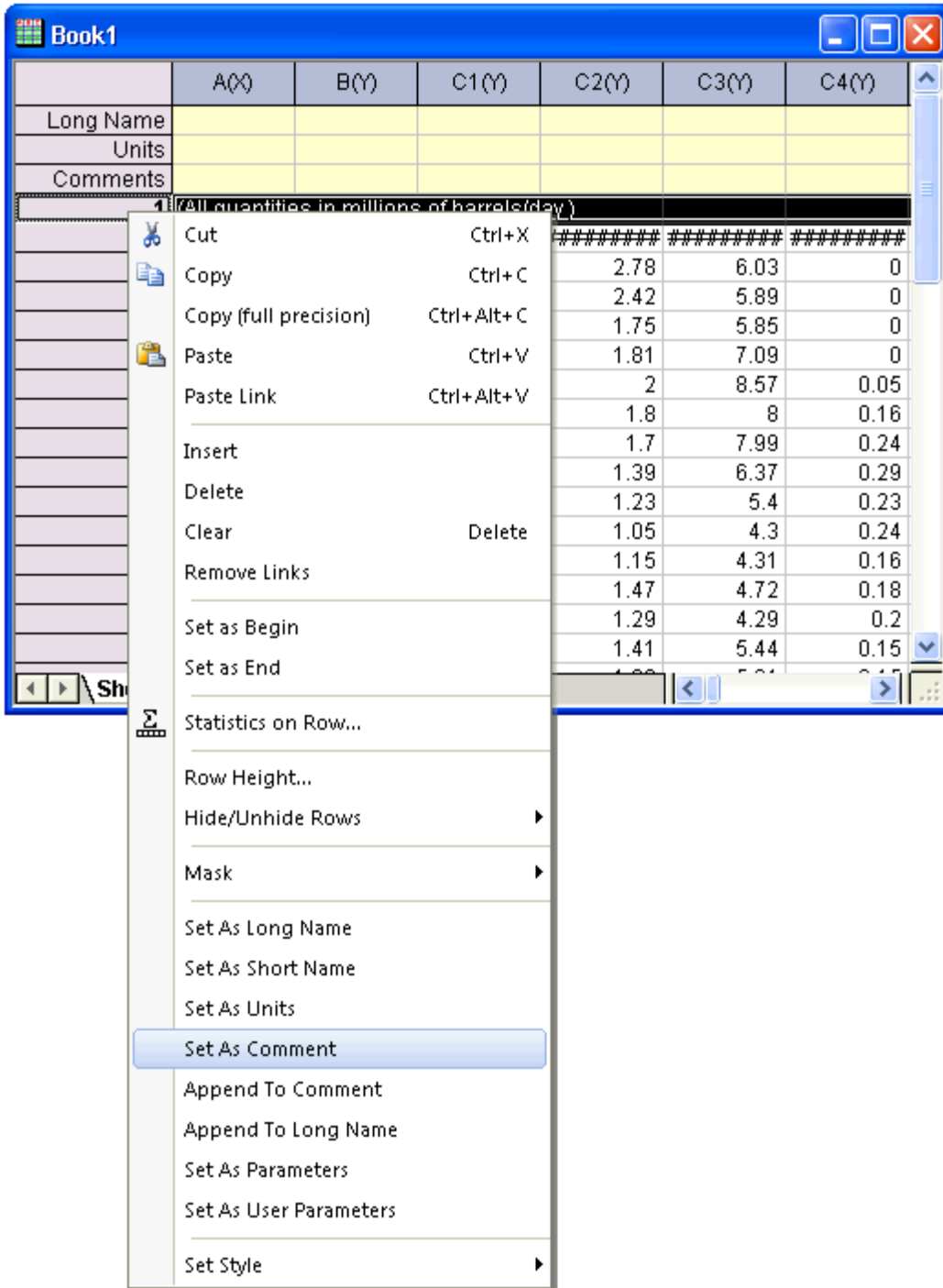

8. Right click on row 1 again and select **Set as Long Name**. This makes rows 1 and 2 in Excel the worksheet header in Origin:

The screenshot shows an Excel spreadsheet window titled "Book1". The spreadsheet contains a table with the following structure:

	A(X)	B(Y)	C1(Y)	C2(Y)	C3(Y)	C4(Y)	C5(Y)
Long Name	Year	Domestic crude oil production	Crude oil imports	Petroleum products imports	Total imports	Crude oil exports	Petroleum products exports
Units							
Comments	(All quantities in millions of barrels/day)						
F(x)=							
1	1/1/1973	9.21	3.24	2.78	6.03	0	0.2
2	1/1/1974	8.77	3.47	2.42	5.89	0	0.2
3	1/1/1975	8.37	4.1	1.75	5.85	0	0.
4	1/1/1976	8.13	5.28	1.81	7.09	0	0.2
5	1/1/1977	8.25	6.57	2	8.57	0.05	0.1
6	1/1/1978	8.71	6.2	1.8	8	0.16	0.
7	1/1/1979	8.55	6.28	1.7	7.99	0.24	0.2
8	1/1/1980	8.6	4.98	1.39	6.37	0.29	0.2

9. You can now double click column 1, set it as **Date**, and plot the data.

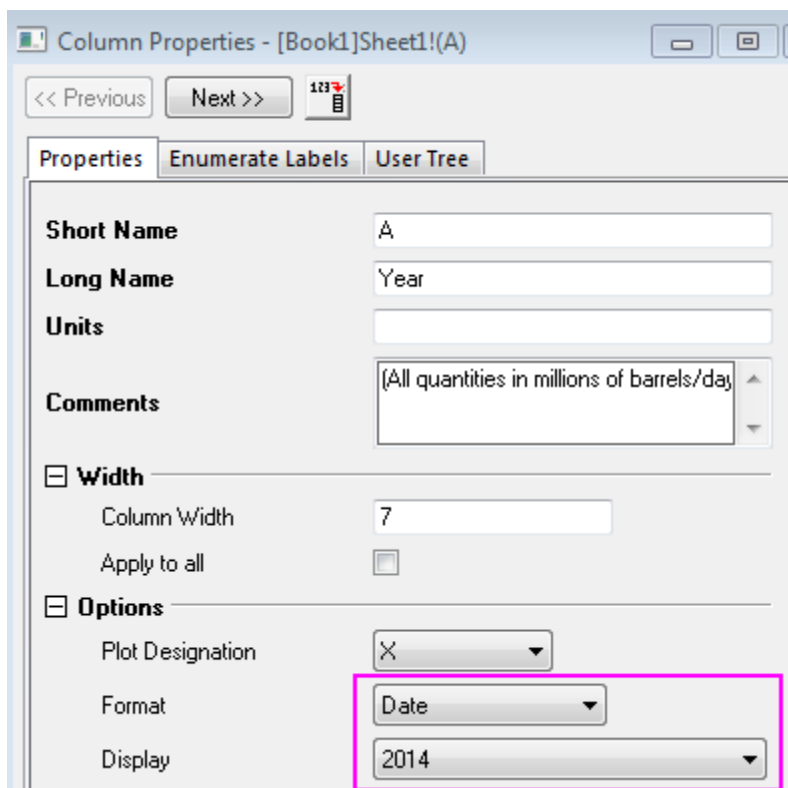

In Step 5, you can right click to choose **Paste Link** or press Ctrl+Alt+V instead of choosing **Paste** or pressing Ctrl+V. As a result, you will create a DDE link between the Excel data and Origin workbook. By this way, the linked data in Origin workbook will change when the values in Excel are changed. You will learn more in [this blog](#).

#### 11.2.2.2.4 Importing Excel File

Origin supports importing Excel files directly into Origin workbooks. Multiple sheets are supported and controls are available for setting specific rows in the Excel sheet to be brought into an Origin worksheet as header information such as Long Name or Comments. If you want to perform analysis or data manipulation operations on your Excel data, we recommend importing your data into Origin.

1. With a new book active in Origin, use the menu **Data: Import from File: Excel (XLS, XLSX, XLSM)...**
2. Select the file **<Origin Program Folder>\samples\graphing\Excel Data.xls** and make sure the **Show Options Dialog** is checked.



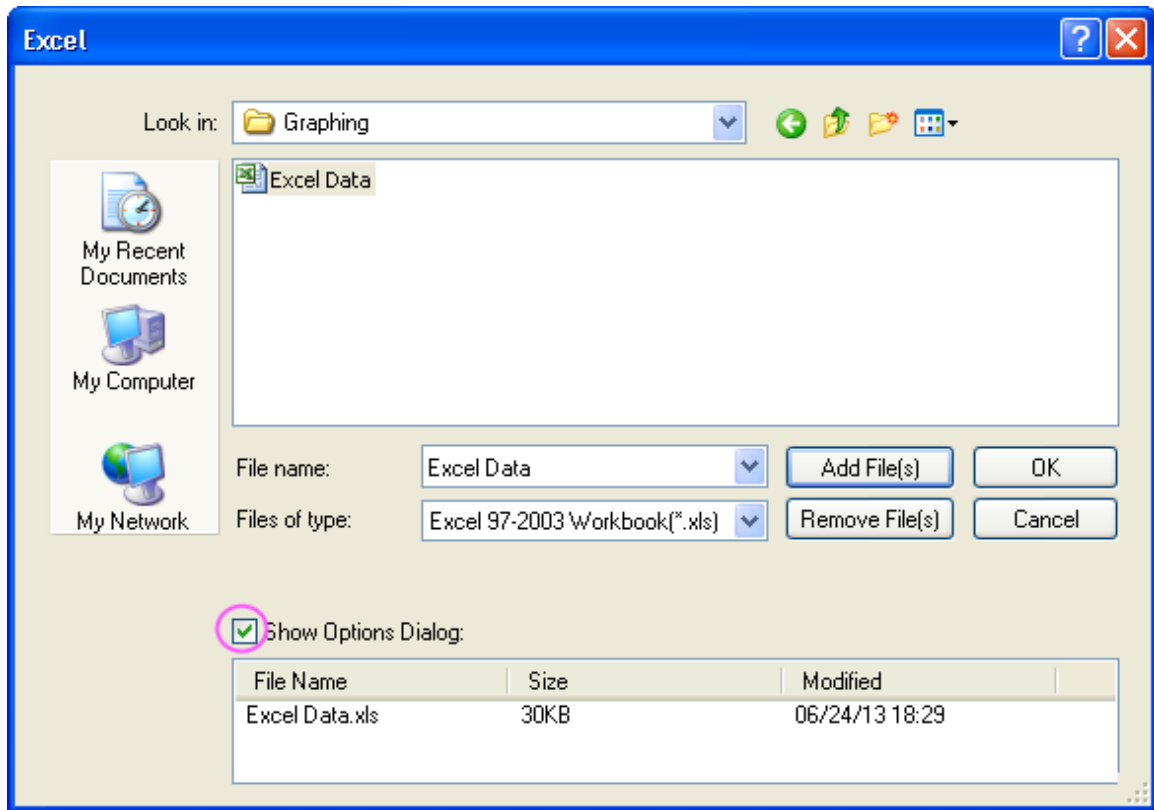

3. In the dialog that comes up, leave the **Use Excel COM Component to Import** check box checked.
4. Set **Index of Rows for Comments From** to 1
5. Set **Index of Rows for Long Name** drop-down to 2 and click **OK** to Import.

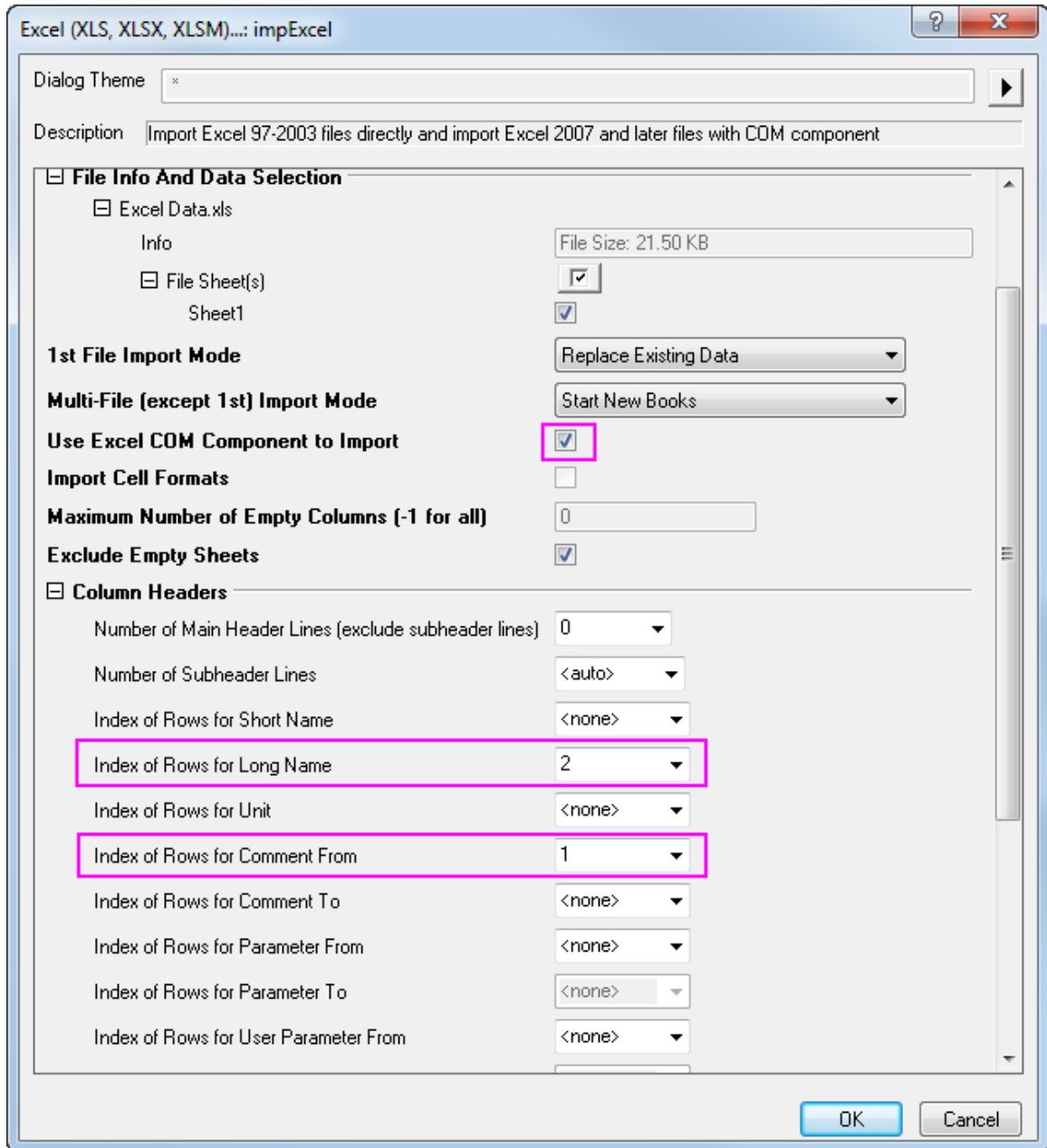

6. Click and select the **Comments** cell under column 1, hold the **CTRL** key and drag the bottom right point of the selected cell to stretch across all columns with data, thus copying the same comments to all columns.

	A(X)	B(Y)	C1(Y)
Long Name	Year	Domestic c	Crude oil i
Units			
<b>Comments</b>	(All quantities in millions of barrels/day)		
1	1/1/1973	9.21	3.24
2	1/1/1974	8.77	3.47

- 7. Press **F4** to bring up the format dialog, switch to the **Format** tab, change the **Apply To** drop-down to **Comments** and set **Dynamic Merge** to **Horizontal**. Click **OK**.

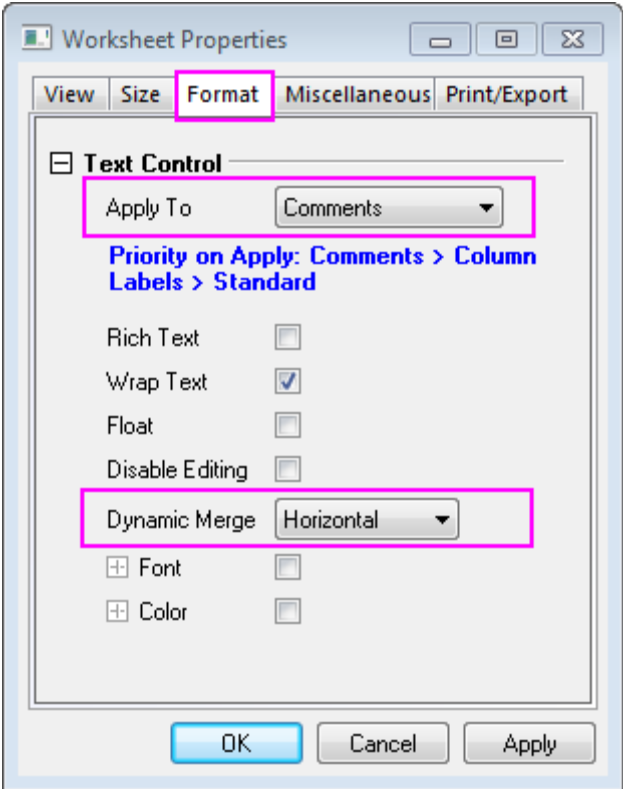

This merges the comments cells and shows the title in the center of all the data columns as shown below:

C2(Y)	C3(Y)	C4(Y)	C5(Y)	C6(Y)	C7(Y)
Petroleum	Total impor	Crude oil e	Petroleum	U.S. petrole	World petro
(All quantities in millions of barrels/day)					
2.78	6.03	0	0.23	17.31	56.39
2.42	5.89	0	0.22	16.65	55.91
1.75	5.85	0	0.2	16.32	55.48

#### 11.2.2.2.5 Open Excel File in Origin

At times it may be desirable to keep the data in an external XLS file while opening the file inside Origin as an Excel window and then working with the data. When you open Excel (.XLS or .XLSX) files as Excel workbooks in Origin, an OLE instance of Microsoft Excel is launched. You can plot directly using Excel workbook data, but many analysis features as well as 3D plotting are inaccessible.

1. Select **File: Open Excel...** and select the file **\Samples\Graphing\Excel Data.xls**.
2. A new Excel window opens inside the Origin workspace. When this window is active, the Origin main menu has different entries, some of which are specific to Excel. The Excel toolbars are also available.

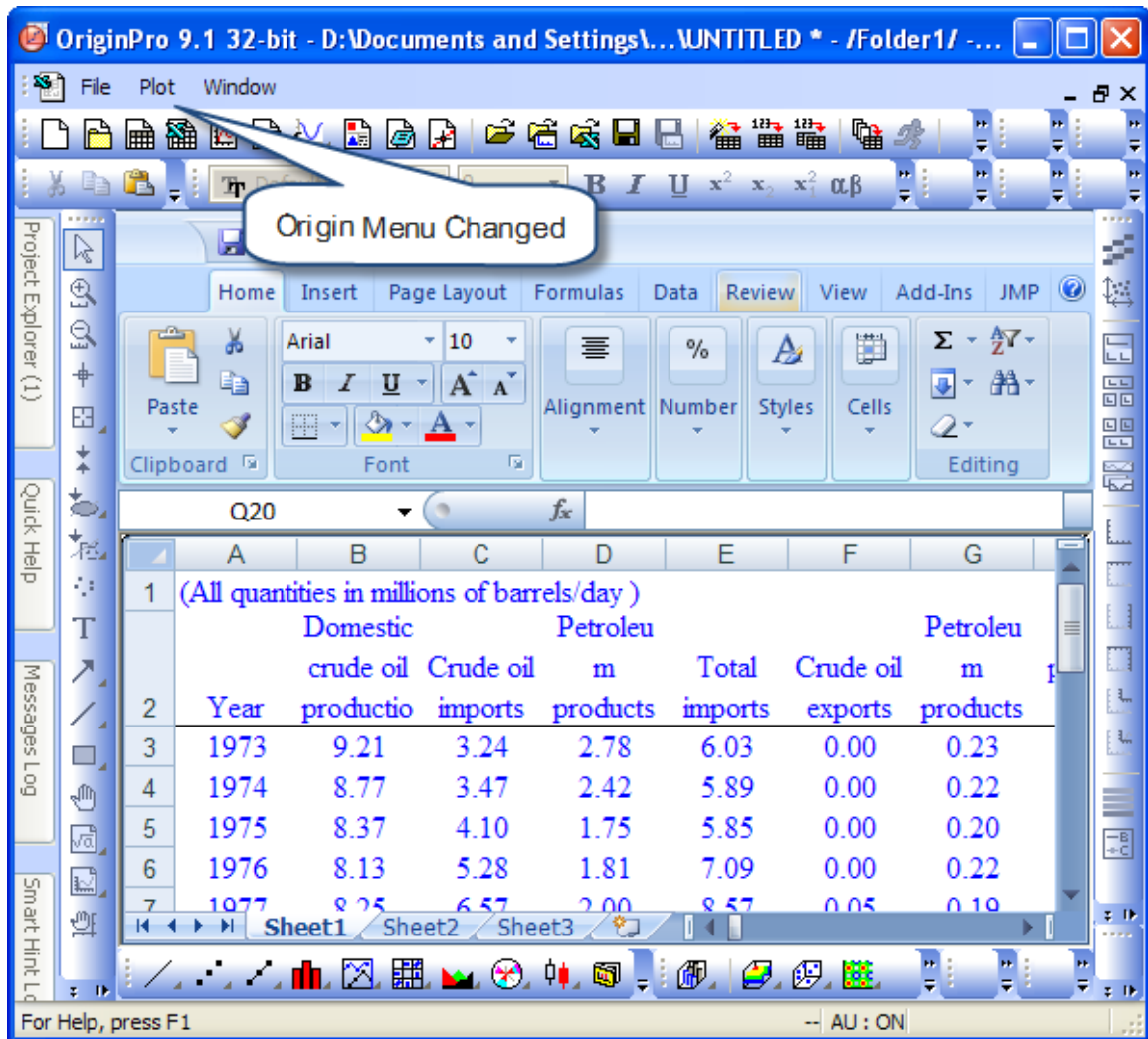

- Highlight the Excel data range **A3:A26** and right click. Select **Format Cells** to make sure that the data is **Date** format.

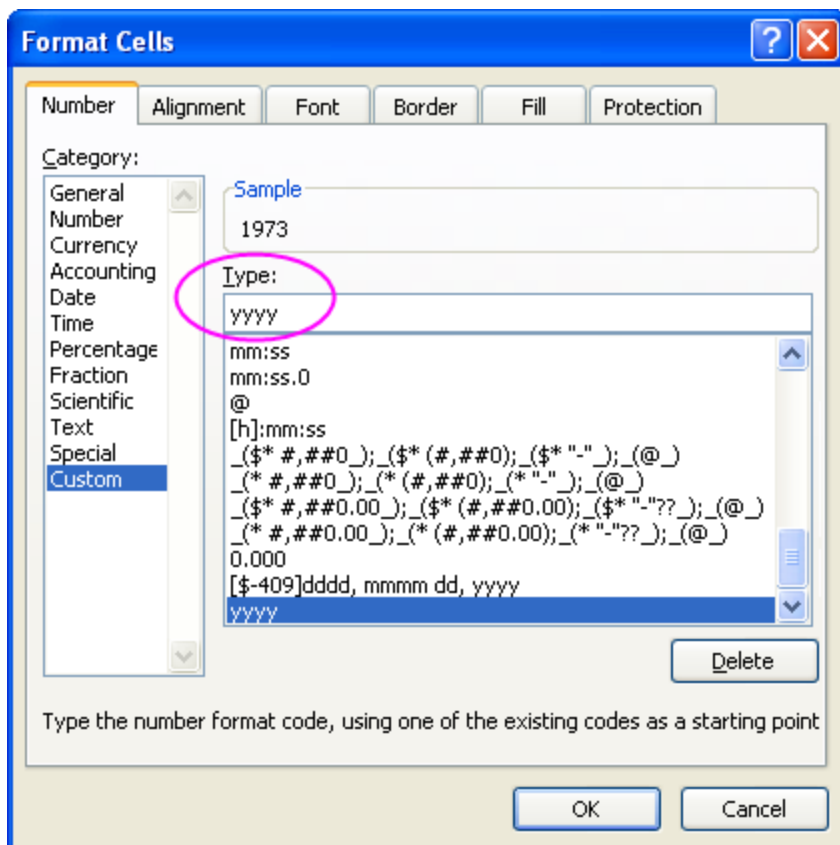

4. Now select the **Plot** menu in Origin and select the **Multi-Y: Double-Y** plot type.
5. Select **A3:A26** in the Excel sheet and click **X** in the **Select Data for Plotting** dialog to assign the X data.

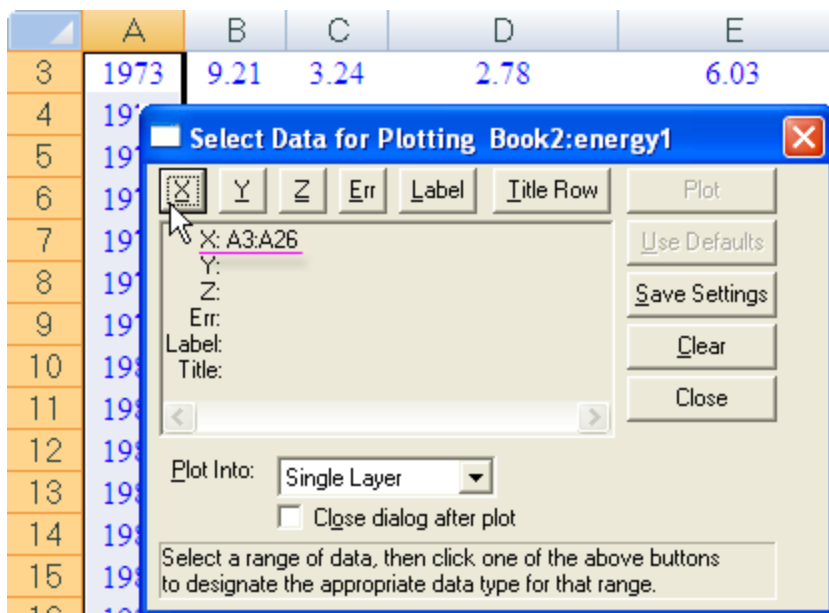

6. Select **B3:C26** in the Excel sheet and click **Y** in the **Select Data for Plotting** dialog to assign the Y data. Select **Multiple Layers** from the **Plot Into** drop-down.

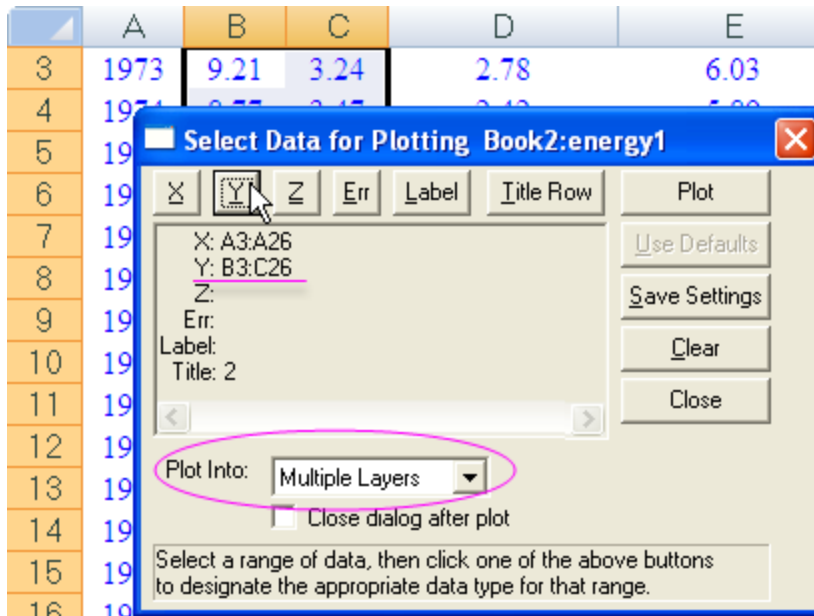

7. Click **Plot** to create a double-y plot as shown below:

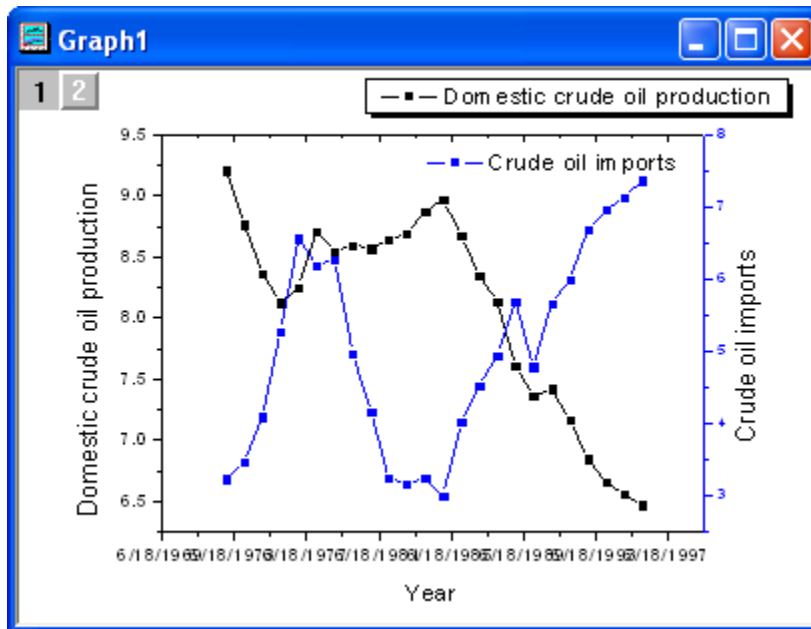

8. By default, Origin displays the tick labels for time on the X axis in MM/DD/YYYY format. Double-click the X axis to open the **Axis dialog**. Select the **Horizontal** icon in **Scale** tab and change the scale from **1/1/1970** to **1/1/2000**.

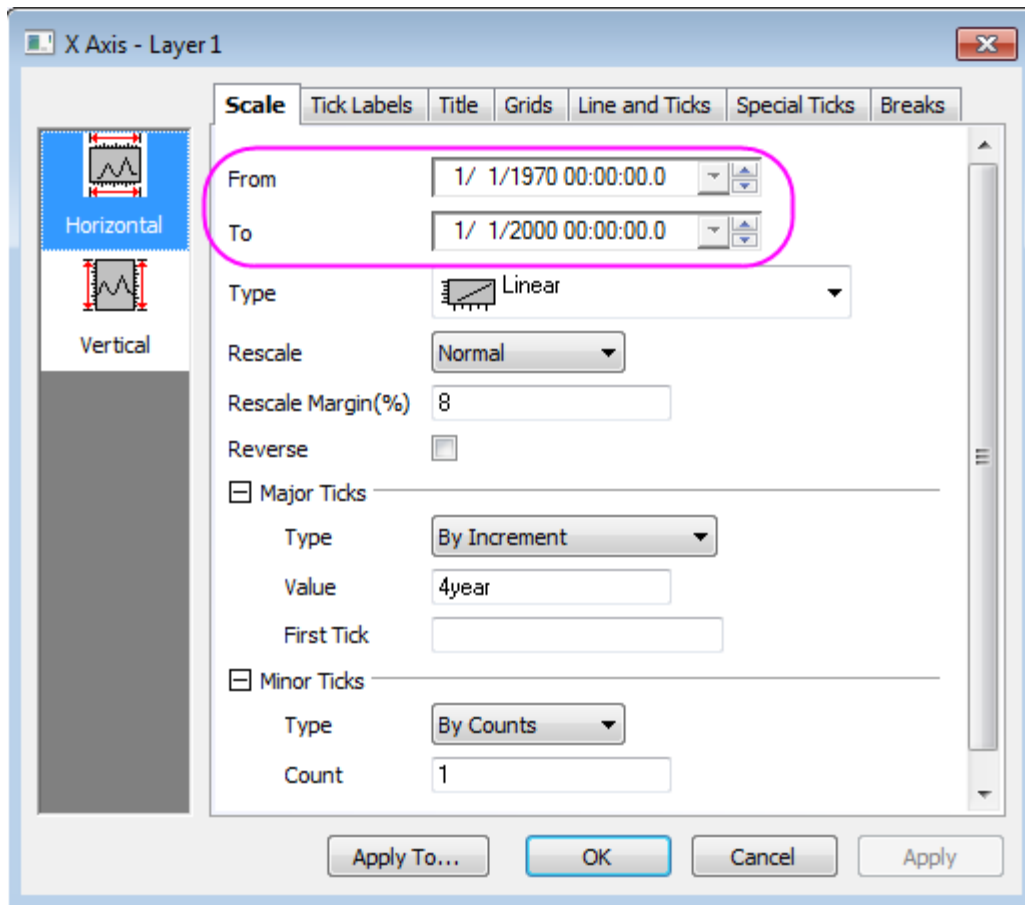

Select the **Bottom** icon in the **Tick Labels** tab and change the **Display** to year.



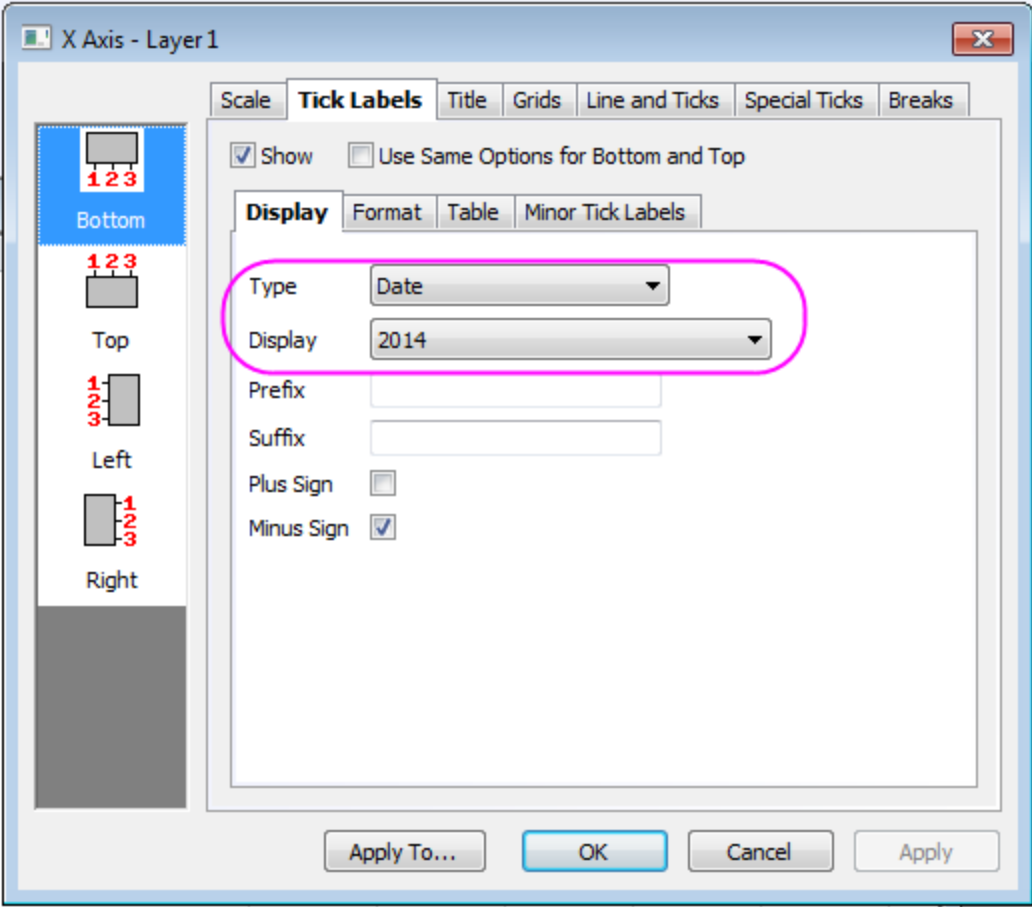

Click **OK** to apply the settings and close the dialog. The graph should resemble the following image:

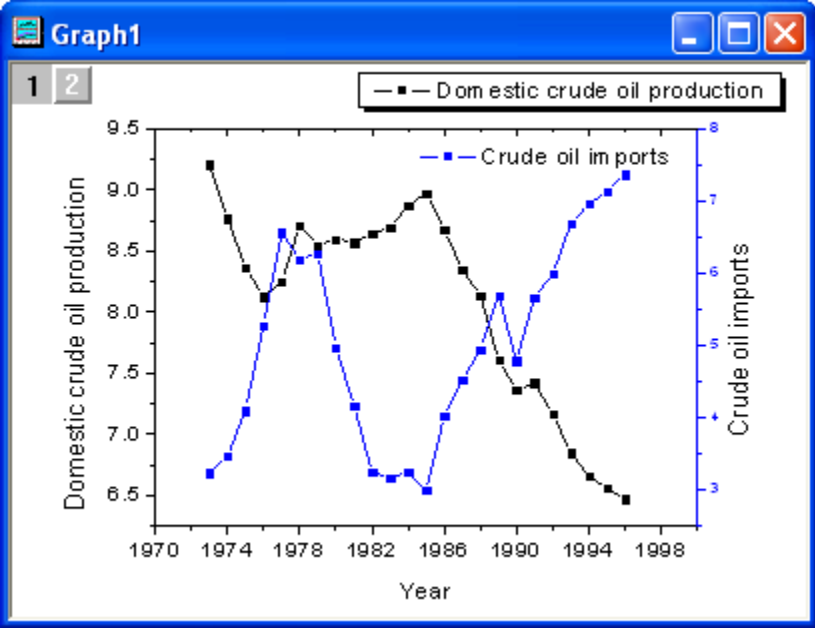



After opening Excel in Origin, switching to another Origin window, causes a toolbar spacer to become visible where the Excel menu used to be. To remove it, right click and select **Hide Toolbar Spacer** or **Hide Toolbar Spacer Always**.

#### 11.2.2.6 Setting External Excel File Path Relative to OPJ Path

The Origin Project can contain an Excel window which is linked to an external Excel file. In such a case it may be beneficial to save the Excel file in the same folder as the Origin project, or a subfolder under the Origin project folder. This will make the two files more portable, as seen in the following steps:

1. Close Excel if it is running.
2. Perform the steps under the **Open Excel File in Origin** section above, and (optionally) create a plot.
3. Save the OPJ to a folder location such as "C:\My Files\My Project.opj".
4. Right-click on the Excel window and select **Save Workbook As**. Save it in a (new) subfolder under the OPJ save location, such as "C:\My Files\Data\My Data.xls".

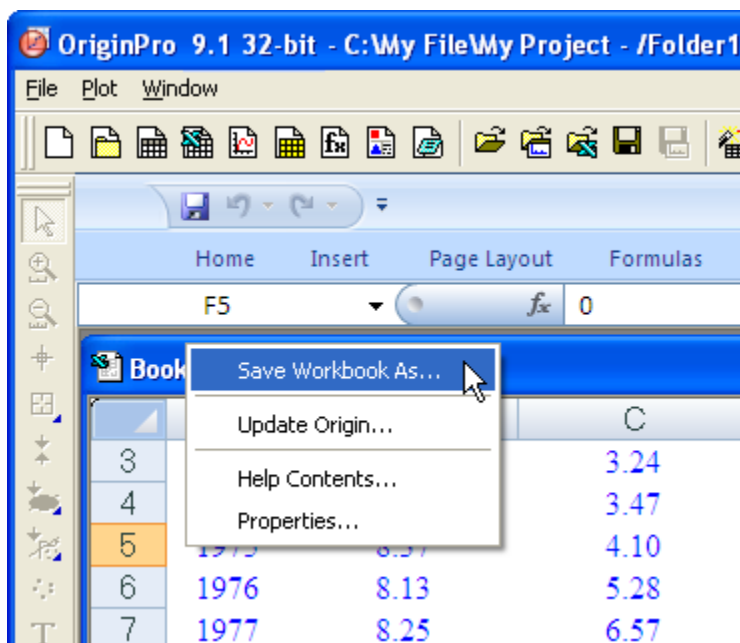

5. Right click again on the Excel window title and select **Properties**. Check the box that says **Relative to current project (opj) path**. Note that the Excel file path in the box below changes to a relative path of "Data\My Data.xls".

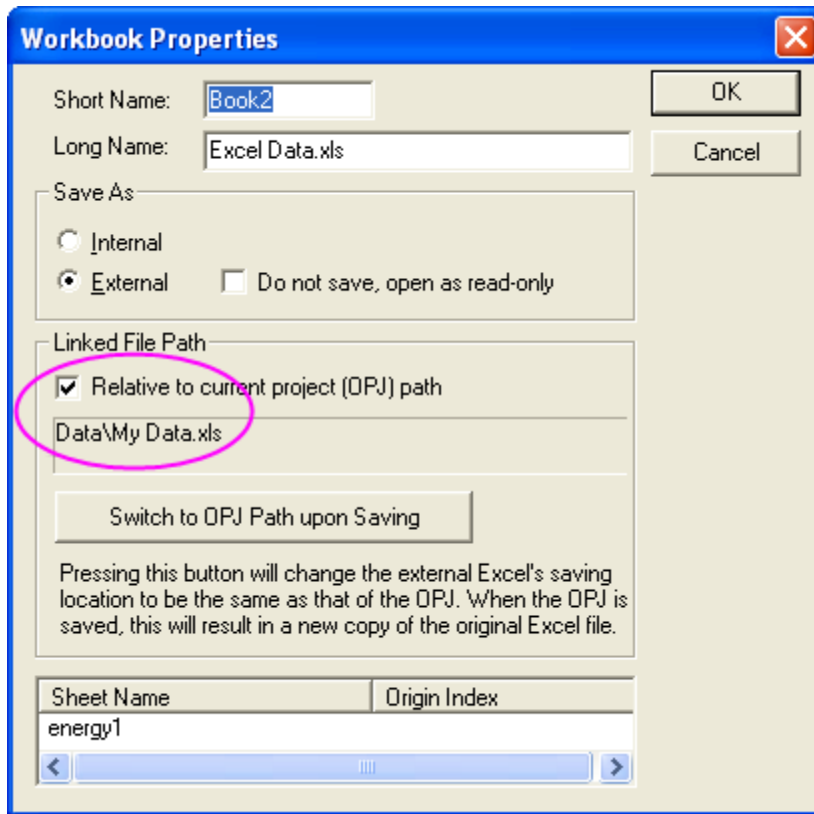

- Save the OPJ again. Now you can copy the entire subfolder structure, starting from where the OPJ is saved, and put it on an external memory device (i.e., a memory stick or similar), or zip the entire folder structure. When taken to another computer and opened, Origin will look relative to the OPJ path to find the Excel file.



If your Excel file is in a different location and you want to save it to the same path as the OPJ, you can open the Excel file in Origin, then right click the title, select **Properties** and click the **Switch to OPJ path upon Saving** button. On saving the OPJ, the Excel file will be copied from its current location to the same path where OPJ is saved.



## 12 Programming

### 12.1 Programming

#### 12.1.1 LabTalk

[Get Started with LabTalk](#)

[LabTalk Language Fundamentals](#)

[Range Notation in LabTalk](#)

[Objects in LabTalk](#)

[Use X-Function in LabTalk](#)

[Debug LabTalk Script](#)

[Graphing and Exporting with LabTalk](#)

[Mathematical Analysis with LabTalk](#)

[Curve Fitting and Batch Processing with LabTalk](#)

[Peak Analysis with Labtalk](#)

[Statistics with Labtalk](#)

[Signal Processing with LabTalk](#)

[Creating OPX for Custom Tools with Labtalk](#)

- [How to share Origin C based LabTalk Functions](#)

#### 12.1.2 Origin C

- [Introduction to Origin C and Code Builder](#)
- [The Code Builder Workspace](#)
- [Adding New Origin C Functions to Origin](#)
- [Organizing and Accessing Origin C Functions](#)
- [Tutorial: Calculating Double Integral with NAG Functions From Origin C](#)
- [Tutorial: Calling NAG Functions From Origin C](#)
- [Accessing Internal Origin Objects by Origin C](#)
- [Create and Update Apps for Origin](#)

#### 12.1.3 X-Functions

- [Command Window and X-Functions](#)
- [Introduction to X-Functions](#)

- [How to Create a Wizard](#)

## 12.2 LabTalk

### 12.2.1 LabTalk

[Get Started with LabTalk](#)

[LabTalk Language Fundamentals](#)

[Range Notation in LabTalk](#)

[Objects in LabTalk](#)

[Use X-Function in LabTalk](#)

[Debug LabTalk Script](#)

[Graphing and Exporting with LabTalk](#)

[Mathematical Analysis with LabTalk](#)

[Curve Fitting and Batch Processing with LabTalk](#)

[Peak Analysis with Labtalk](#)

[Statistics with Labtalk](#)

[Signal Processing with LabTalk](#)

[Creating OPX for Custom Tools with Labtalk](#)

- [How to share Origin C based LabTalk Functions](#)

### 12.2.2 How to share Origin C based LabTalk Functions

#### 12.2.2.1 Introduction

This tutorial will show you how to share code with other users by distributing OPX files. In this example, only Origin C files are distributed. However, please note that OPX distribution can include any file types including (but not limited to) project files, templates and toolbars.

#### 12.2.2.2 Tutorial

The following procedure will show you how to distribute your Origin C code to other Origin users. In this example, we will be packaging an Origin-C function in a file (*MyCode.c*) in a folder (*MyFunctions*) under the **User Files Folder (UFF)**.

1. Create File Locations
2. The **Source Path** for your files should be available on any computer your OPX is targeted for. The easiest way to do this is to make a subfolder of the Origin **UFF**. Any of the files and folders of the **UFF**

can then be added to your OPX for distribution. So, create a subfolder named *MyFunctions* under the **UFF**.

3. Copy Files to the Source Path
4. Copy all the files to be packaged to the subfolder created in the last step. Here there is only a C file (*MyCode.c*). The function in this file is shown below.

```
void get_data_from_wks()
{
    Worksheet wks = Project.ActiveLayer();

    if( !wks )
    {
        out_str("Please keep a worksheet active with data");

        return;
    }

    // The following settings to set range as whole worksheet,
    // index offset is 0, -1 means last row/column.

    // Change r1, c1, r2, c2 to specify worksheet sub range,
    // for example, r1 = 0, c1 = 1, r2 = -1, c2 = 2 to
    // select all rows from column 2 to column 3.

    int r1 = 0; // first row

    int c1 = 0; // first column
```

```
int r2 = -1; // last row

int c2 = -1; // last column

//construct a data range object from worksheet all data

DataRange dr;

dr.Add("X", wks, r1, c1, r2, c2);

// get data from worksheet to vector by column one by one

matrix mData;

dr.GetData(mData); // get all data to matrix

for(int nColIndex = 0; nColIndex < mData.GetNumCols(); nColIndex++)

{

    vector vOneCol;

    mData.GetColumn(vOneCol, nColIndex);

    double min, max;

    vOneCol.GetMinMax(min, max);

    printf("Maximum value of %d column = %f\n", nColIndex+1, max);

}
```



```
}

```

5. Create a Package
6. Open the **Package Manager** by selecting **Tools: Package Manager...**. Then fill in the dialog as the following image shows.

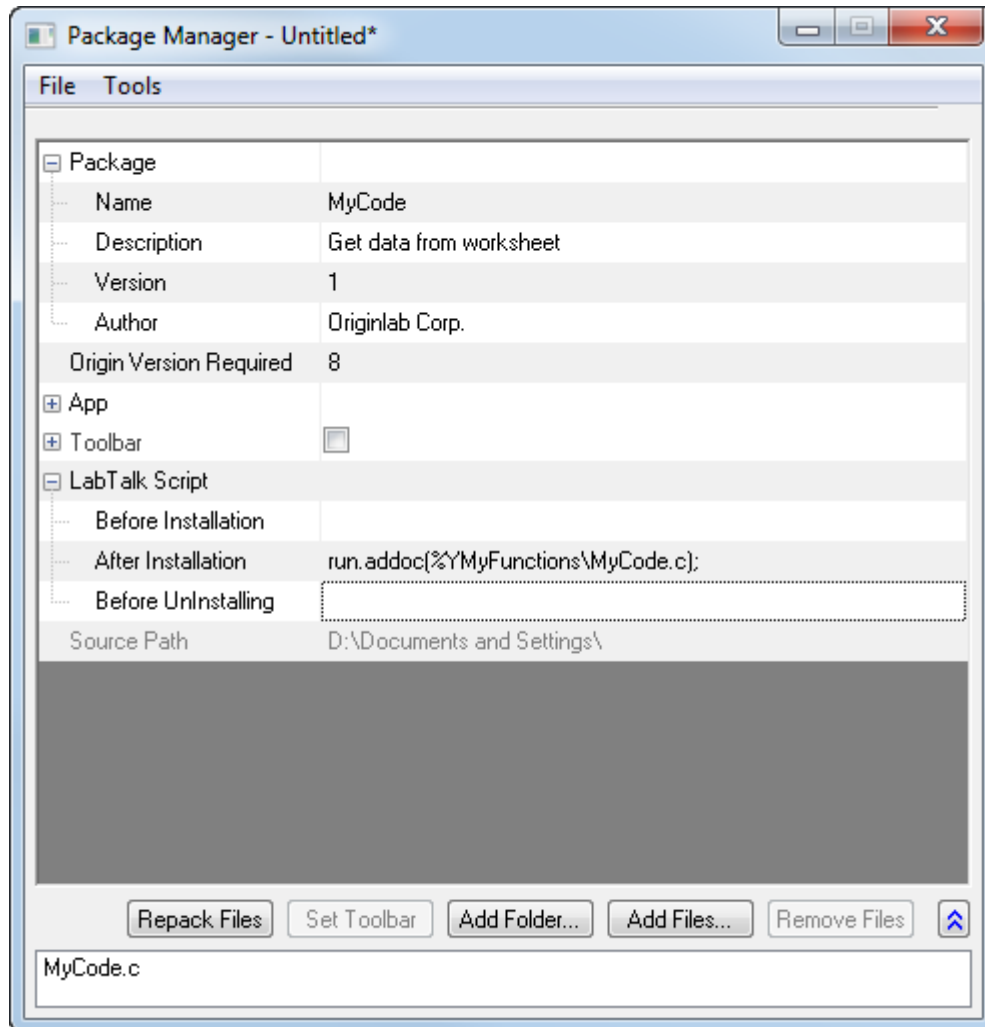

- o The **Module Name** will appear as the name of the package for uninstall purposes.
- o **Origin Version Required** means the minimum version of Origin required for this package. You want to enter the version number like 8.0988, and not like 8.0SR6.
- o To force the Origin C source file to the System Folder Workspace, use the `run.addoc()` method in the **After Installation** branch of **LabTalk Script**. In this example, it looks like the following:

```
run.addoc(%YMyFunctions\MyCode.c);
```

- Click the **Add Files** or the **Add Folder** button and browse to and add any files required. In this example, browse to the subfolder (*MyFunctions*) under the **UFF** and add the C file (*MyCode.c*). Then the path of the **UFF** will show as the source path, and the files will list in the lower panel.
7. Save the Package
  8. Select the **File: Save** menu of this **Package Manager** dialog. In the pop-up **Save As** dialog, enter a name (in this example, can be *MyCode*) for this package, and then save it as an OPX file.
  9. Distribute the Package
  10. Send the saved OPX file to other users. The user who gets this package can drag and drop the OPX onto Origin to install it, and then the functions in the C file are available.
    - Drag and drop *MyCode.opx* onto Origin to install it. After installation, the function `get_data_from_wks` defined in *MyCode.c* can be used as a LabTalk command.

```
get_data_from_wks;
```

## 12.3 Origin C

### 12.3.1 Origin C

- [Introduction to Origin C and Code Builder](#)
- [The Code Builder Workspace](#)
- [Adding New Origin C Functions to Origin](#)
- [Organizing and Accessing Origin C Functions](#)
- [Tutorial: Calculating Double Integral with NAG Functions From Origin C](#)
- [Tutorial: Calling NAG Functions From Origin C](#)
- [Accessing Internal Origin Objects by Origin C](#)
- [Create and Update Apps for Origin](#)

### 12.3.2 Introduction to Origin C and Code Builder

#### 12.3.2.1 Summary

[Origin C](#) supports a nearly-complete ANSI C language syntax as well as a subset of C++ features including internal and DLL-extended classes. In addition, Origin C is "Origin aware". This means that Origin objects such as worksheets and graphs are mapped to classes in Origin C, allowing direct manipulation of these objects and their properties from Origin C.

Origin C's integrated development environment (IDE) is called Code Builder. Code Builder provides standard tools for writing, compiling, and debugging your Origin C programs. Once an Origin C function is compiled and linked, the function can be called in various ways from the Origin or Code Builder workspaces.

To open Code Builder, click the  button on the Origin Standard toolbar, or press ALT + 4 from the keyboard.

Minimum Origin Version Required: Origin 9

### 12.3.2.2 What you will learn

This tutorial will show you how to:

- Create an Origin C function.
- Debug and Run the Function.
- Run the Function Using the Custom Routine Button.

### 12.3.2.3 Steps

#### 12.3.2.3.1 Create an Origin C Function

1. In Code Builder, start with a new workspace (**File: New Workspace...**). On the Code Builder **Standard** toolbar, click the **New**  button to open the **New File** dialog.
2. Select **C File** to create a .c file. Type **Tutorial** in the **File Name** text box. In the **Location** text box, specify the *User Files Folder/OriginC* folder to save your source file. Make sure that the **Add to Workspace** box is checked. Click **OK**. A file named Tutorial.c is created and opened in the Code Builder workspace.

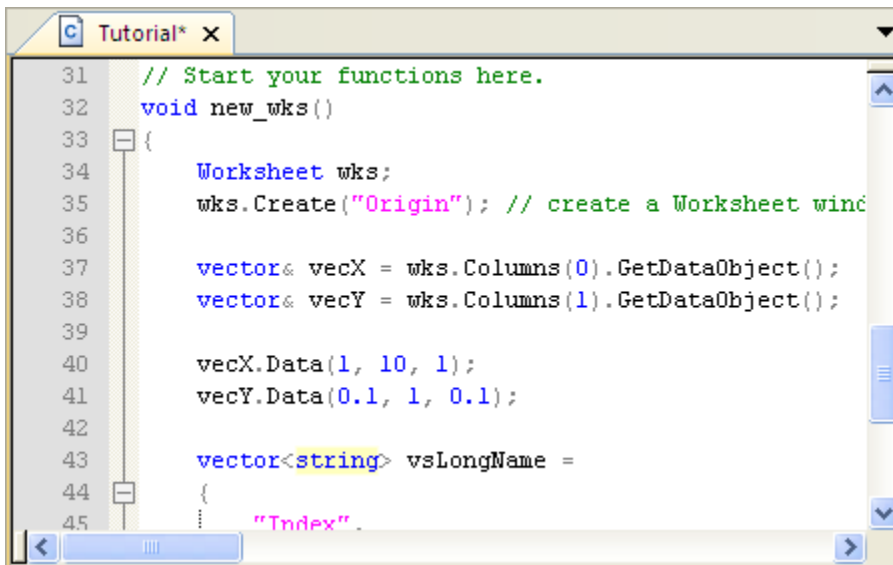

```

31 // Start your functions here.
32 void new_wks()
33 {
34     Worksheet wks;
35     wks.Create("Origin"); // create a Worksheet window
36
37     vector& vecX = wks.Columns(0).GetDataObject();
38     vector& vecY = wks.Columns(1).GetDataObject();
39
40     vecX.Data(1, 10, 1);
41     vecY.Data(0.1, 1, 0.1);
42
43     vector<string> vsLongName =
44     {
45         ... "Index" ...

```

4. Copy and paste the following code beneath the line that reads "// start your functions here.":

```
void new_wks()
{
    Worksheet wks;

    wks.Create("Origin"); // create a Worksheet window with template -
Origin

    vector& vecX = wks.Columns(0).GetDataObject();

    vector& vecY = wks.Columns(1).GetDataObject();

    vecX.Data(1, 10, 1);

    vecY.Data(0.1, 1, 0.1);

    vector<string> vsLongName =
    {
        "Index",
        "Data"
    };

    for (int nCol = 0; nCol < wks.GetNumCols(); ++nCol)
    {
        Column col (wks, nCol);
```

```

        col.SetLongName(vsLongName[nCol]);

    }

}



```

This new\_wks function will create a worksheet using the **Origin** template. It fills the first column with numbers from 1 to 10, incrementing by 1. The second column is filled with numbers from 0.1 to 1, incrementing by 0.1. Lastly, it sets the Long Names of the first and second columns as **Index** and **Data**, respectively.

5. Click the **Save** button .



**Mini-Tutorial:** Find more examples of the usage of **GetDataObject** and use a bookmark to quickly navigate to a marked line.

1. Click line 33 and click the **Toggle Bookmark** button .
2. Select **GetDataObject()** in line 37 and click the **Find in files** button .
3. In the **Find in Files** dialog box, set **In files/file types** as **\*.c,\*.cpp** and **In folder** as **<program folder>\OriginC**. Check all the boxes in this dialog and click the **Find** button.
4. In the **Find Results** window, double-click any line containing **GetDataObject()**. This opens the file containing this string and jumps to the related section.
5. To back to the line marked in step1 activate the **Bookmarks** window. Double click the bookmark added in step 1 of this mini-tutorial and the cursor jumps to line 33 in the Tutorial.c file.

#### Origin 2015 provides some useful tools:

- **Quick open files**

Prss SHIFT + ALT + O or select **Tools: Quick Open Files** to open the **Quick Open Files** dialog.

- **Switch between .h and .c/.cpp file**

When open a .h file, press CTRL + ALT + O to open the corresponding .c or .cpp file, and vice versa.

- **Find symbols**

Press SHIFT + ALT + S or select **Tools: Find Symbols** to open the **Find Symbols** dialog.

#### 12.3.2.3.2 Debug and Run the Function

1. On the Code Builder **Standard** toolbar, click the **Build** button . This compiles the new\_wks function and performs linking (Please make sure the **Tutorial.c** file is active).

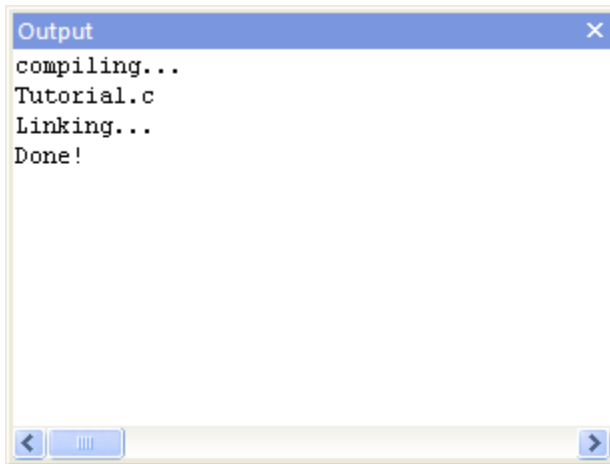

2. Click the space just to the left of lines 34, 35, 37, 50. A red ball icon will be placed at the beginning of each line, indicating that you added breakpoints to these lines. These breakpoints are listed in the **Breakpoints** window.
3. In the **Breakpoints** window, clear the box before **tutorial.c, line 35** to disable this breakpoint. Note that the breakpoint icon before line 35 becomes a hollow circle icon.



To delete a breakpoint, you can click on the breakpoint icon before the corresponding line, or right-click on the breakpoint in the **Breakpoints** window, and select **Delete Breakpoint**.

4. Right-click on the breakpoint of line 37. Select **When Hit...** to open a dialog. Check the box before **Print a message**. In the text box under **Print a message:**, append the text **test code runs to here.** . Click **OK** to finish. Note that this breakpoint's icon is now a diamond.

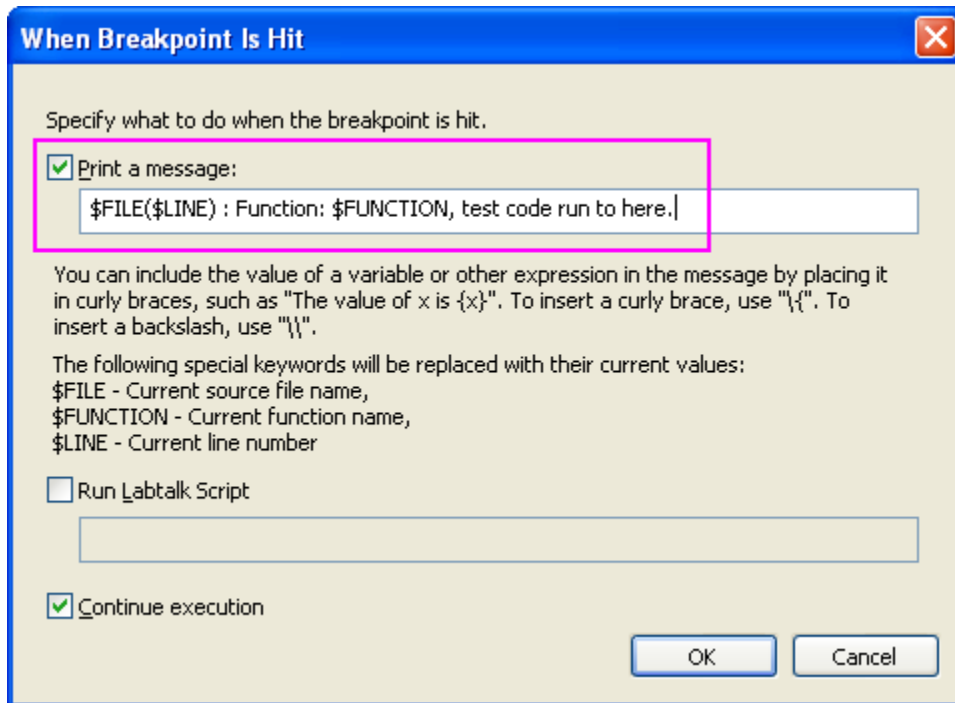

- Right click on the breakpoint at line 50. Select **Condition...** to open a dialog. Enable **Condition** and type **nCol==1** in the text box. Click **OK**.

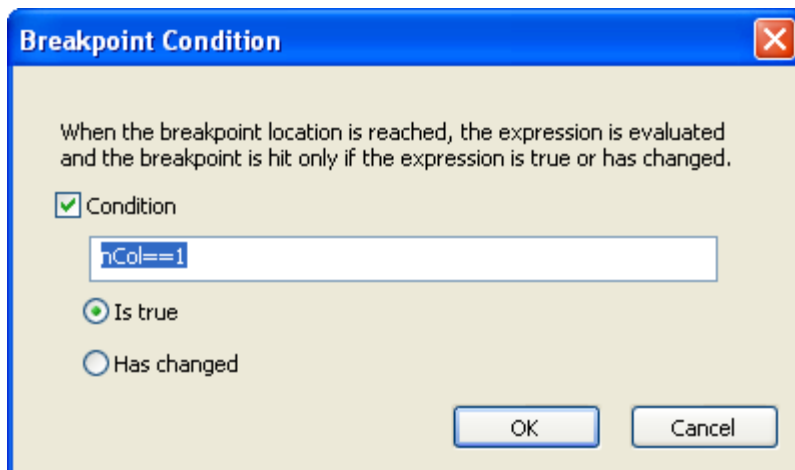

- To run this code, type the function name **new\_wks** in the upper panel of the **LabTalk Console** window.
- Press ENTER. A yellow arrow will appear upon the first breakpoint icon, indicating which line of code is executed to.
- Press F8 to continue debugging the code. You will see the yellow arrow icon moving to the line 50.
- In the **Command & Results** window, the message added in the breakpoint of line 37 is printed in the lower panel.

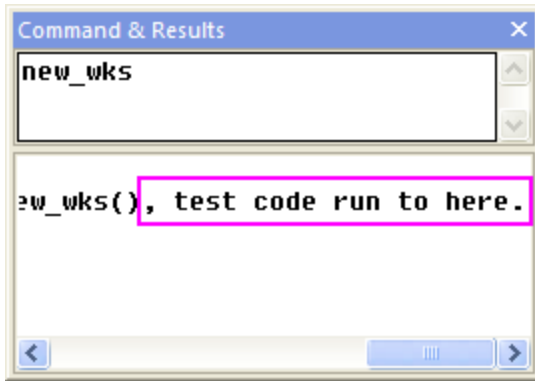

10. Activate the **Variables** window. The variable names are listed in the first column and their values are listed in the second column. Check the value of **nCol**.

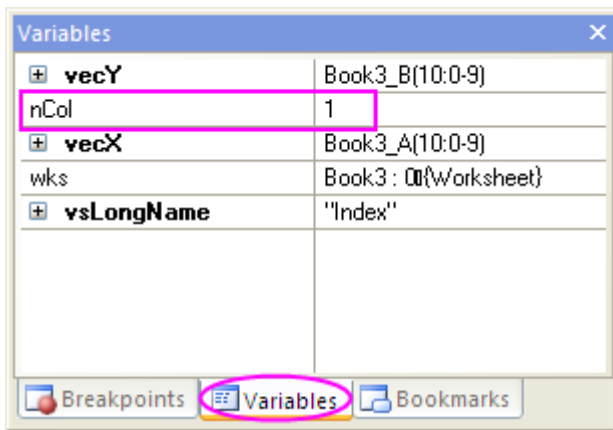



11. Press F5 to run over all codes, the yellow arrow will disappear.
12. Return to the Origin workspace. You can see that a workbook is created as in the following image.



	A(X)	B(Y)	
Long Name	Index	Data	
Units			
Comments			
1	1	0.1	
2	2	0.2	
3	3	0.3	
4	4	0.4	
5	5	0.5	
6	6	0.6	
7	7	0.7	
8	8	0.8	
9	9	0.9	
10	10	1	
11			
12			



### 12.3.2.3.3 Run the Function Using the Custom Routine Button

1. Hold the CTRL + SHIFT keys and click the **Custom Routine** button . It will open the Custom.ogs file in Code Builder.
2. With the cursor at line 11, click the **Comment** button  to comment out line 11.
3. Type the following code at lines 12 and 13.

```
Run.LoadOC(%YOriginC\Tutorial.c); // %Y is user file folder

new_wks();
```

This code will load the **Tutorial.c** file we added in the previous section and run the **new\_wks()** function.

4. Press the **Save** button .
5. Return to the Origin workspace. Click the **Custom Routine** button . A new worksheet will be created and filled with data as it was in the previous section.

	A(X)	B(Y)
Long Name	Index	Data
Units		
Comments		
1	1	0.1
2	2	0.2
3	3	0.3
4	4	0.4
5	5	0.5
6	6	0.6
7	7	0.7
8	8	0.8
9	9	0.9
10	10	1
11		
12		

### 12.3.3 The Code Builder Workspace

#### 12.3.3.1 Summary

In this tutorial, we will create a workspace in the Code Builder of Origin, add a source file with a new function, then build, test and save the workspace file. Also, we will configure the appearance of the Code Builder.

Minimum Origin Version Required: Origin 2016 SR0

#### 12.3.3.2 What you will learn

This tutorial will show you how to:

- Build a Workspace File
- Build Workspace Folders
- Build on Startup
- Configure Code Builder Interface
- Create an App Using Apps folder in Workspace
- Use Hot Key to speed up your work

#### 12.3.3.3 The Workspace File

A workspace is a collection of files that can be opened by a single menu option (**File: Open Workspace...**) in Origin's Code Builder. Any text file can be a part of the collection. They do not necessarily have to be source code files; they could be notes, for example.

All files opened in the Multiple Document Window by a workspace can be edited and saved individually. In addition to files being opened in the Multiple Document Window, source code files can be added to the Workspace Window with the **File: Add to Workspace** menu option.

By including source code files in the Workspace Window, you can build individual or multiple files with the appropriate menu option or toolbar button. Header files can be referenced within source files and do not need to be loaded in the Workspace Window or even open in the Multiple Document Window.

Since you can save a workspace with a new name, you can have multiple workspace files. However, only one workspace file can be opened at a time.

To create a workspace:

1. On the **Standard** toolbar, click the **Code Builder** button .
2. From the Code Builder menu, select **File: New Workspace**. This creates a new workspace with the default name of "Untitled.ocw".
3. From the Code Builder menu, select **File: New**. This opens the **New** File dialog.
4. Choose **C File**, and type **foo** in the **File Name** text box. The **Add to Workspace** and **Fill with Default Contents** check boxes should be selected. You may accept the default Location. Click **OK**.
5. In FOO.C, starting below the line that says "\\start your functions here", type the following:

```
void bar ()
{
    printf("Hello World!\n");
}
```

6. Click the **Build** button  (or use the hotkey **Shift+F8**). Origin automatically saves the source file and compiles and links the function.
7. From the Origin menu choose **Window: Script Window**.
8. To test our new function, type:

```
bar
```

9. Press **ENTER**

Origin responds by typing **Hello World!**

10. From the Code Builder menu, choose **File: Save Workspace As....**

The figure shows the foo.ocw workspace file containing a single source file, foo.c, in the Multiple Document Window. The file has been added to the Workspace Window. The Output Window shows that the file has been compiled. The source file contains a single function "bar( )" which is listed in the tree structure of the workspace.

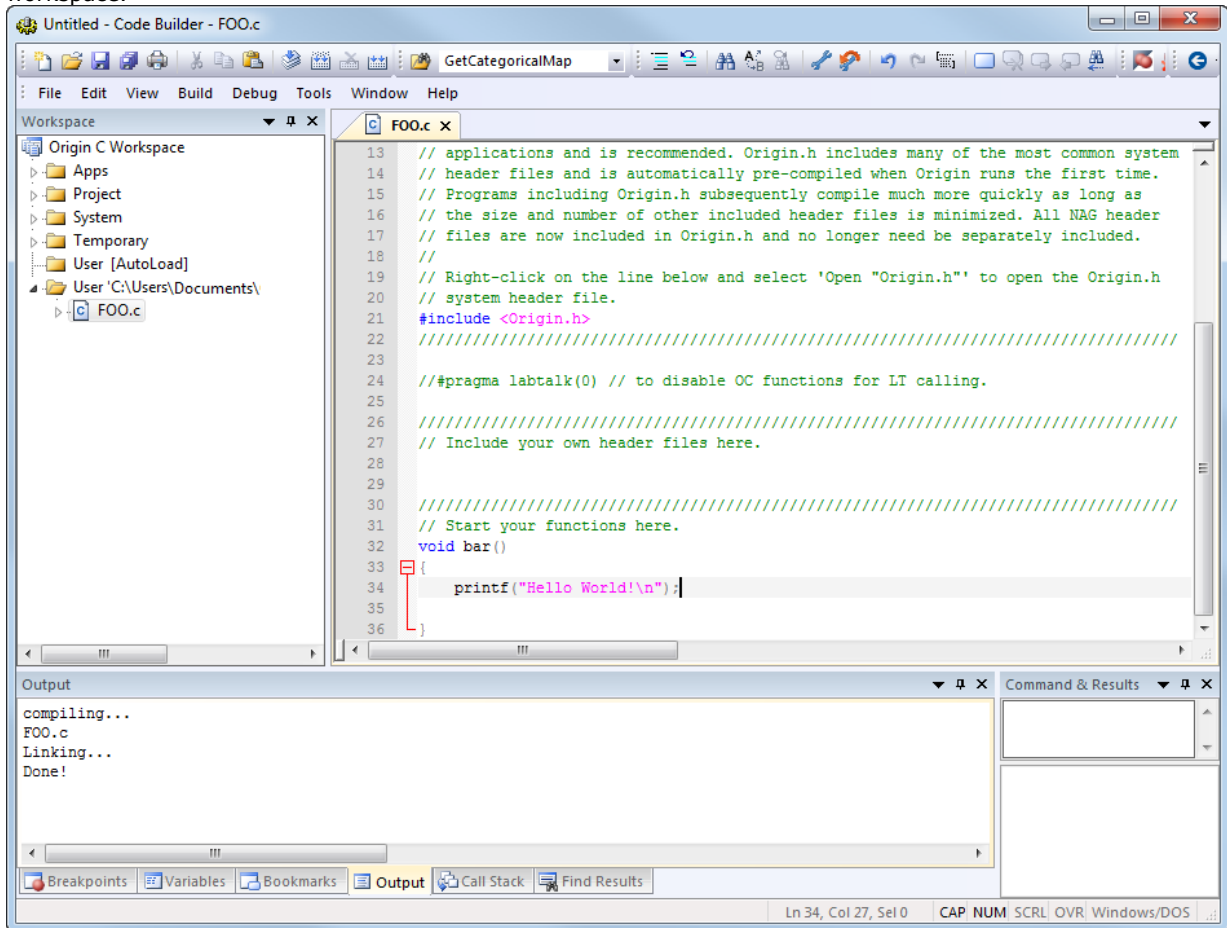

#### 12.3.3.4 Workspace Folders

The Code Builder workspace has six subfolders: Apps, Project, System, Temporary, User [AutoLoad] and User. Files added by user, such as foo.c that you just added, are placed in the User subfolder. Origin, itself, uses Origin C for many analysis routines. When these routines are accessed, the Origin C source files are loaded into either the System subfolder or the Temporary subfolder in the Workspace. The Project subfolder is reserved for files that are saved and loaded with the Origin project. This aspect of attaching a file to the project is described in a separate tutorial.

#### 12.3.3.5 Build on Startup

If you right click on the **Origin C Workspace** folder, the shortcut menu has a **Build on Startup** option. When this option is checked, the last workspace you saved will be loaded when you restart Origin. All source files in the Workspace will be built and all functions in the source files will be available for immediate use.

For information on building individual source files on startup by including information in the ORIGIN.INI file, please view [Build on Startup](#)

This concludes the tutorial on the **Code Builder Workspace**.

#### 12.3.3.6 Configure Code Builder Interface

User can configure code builder interface including the fonts and colors, the brackets color, the icons size and so on.

1. Open **Options** dialog in **Code Builder** by select **Preference: Options** in main menu. Go to the **Fonts and Colors** tab, change the **Theme** to **Dark**. An interface with dark background and light font is obtained. You can further adjust the font size or type in this dialog.

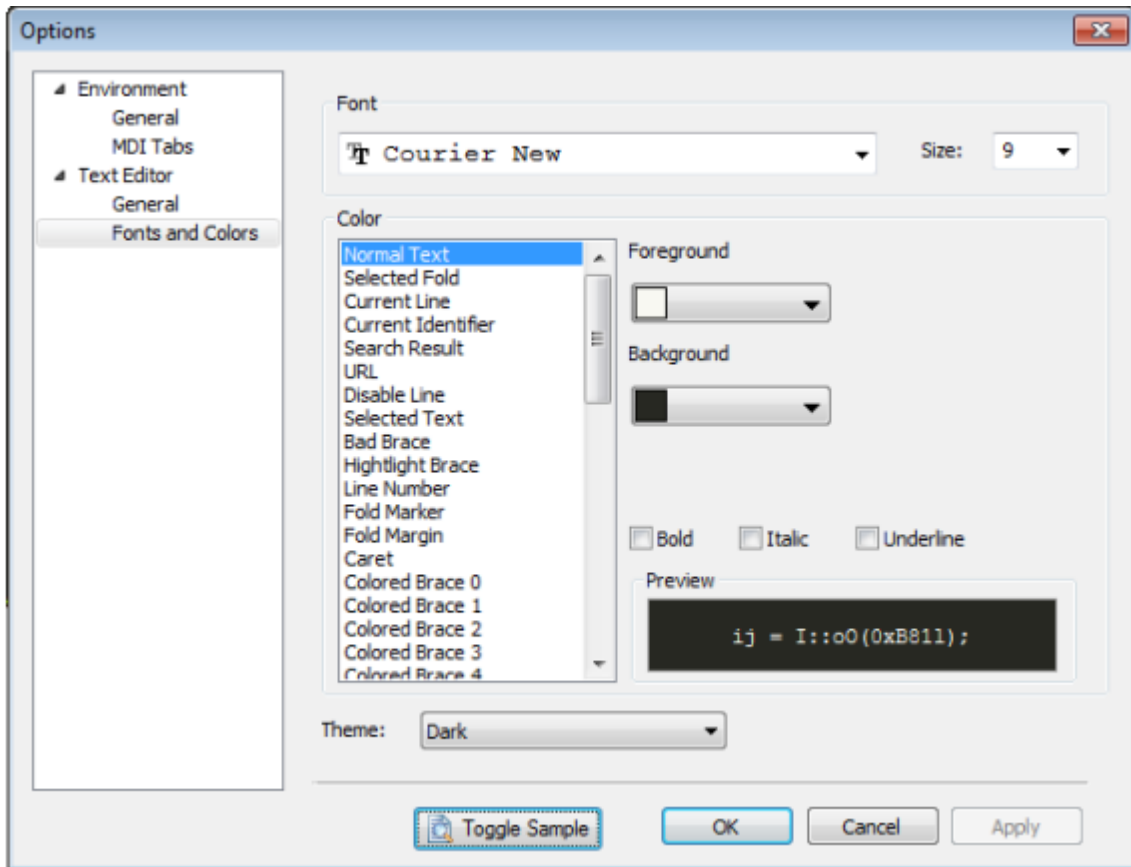

2. In **Options** dialog, go to the (Text Editor) **General** tab, change the properties for **Enable Multiple Colored Brackets** to **True** and click **OK**. The nested "()" in code will be shown in multiple colors.

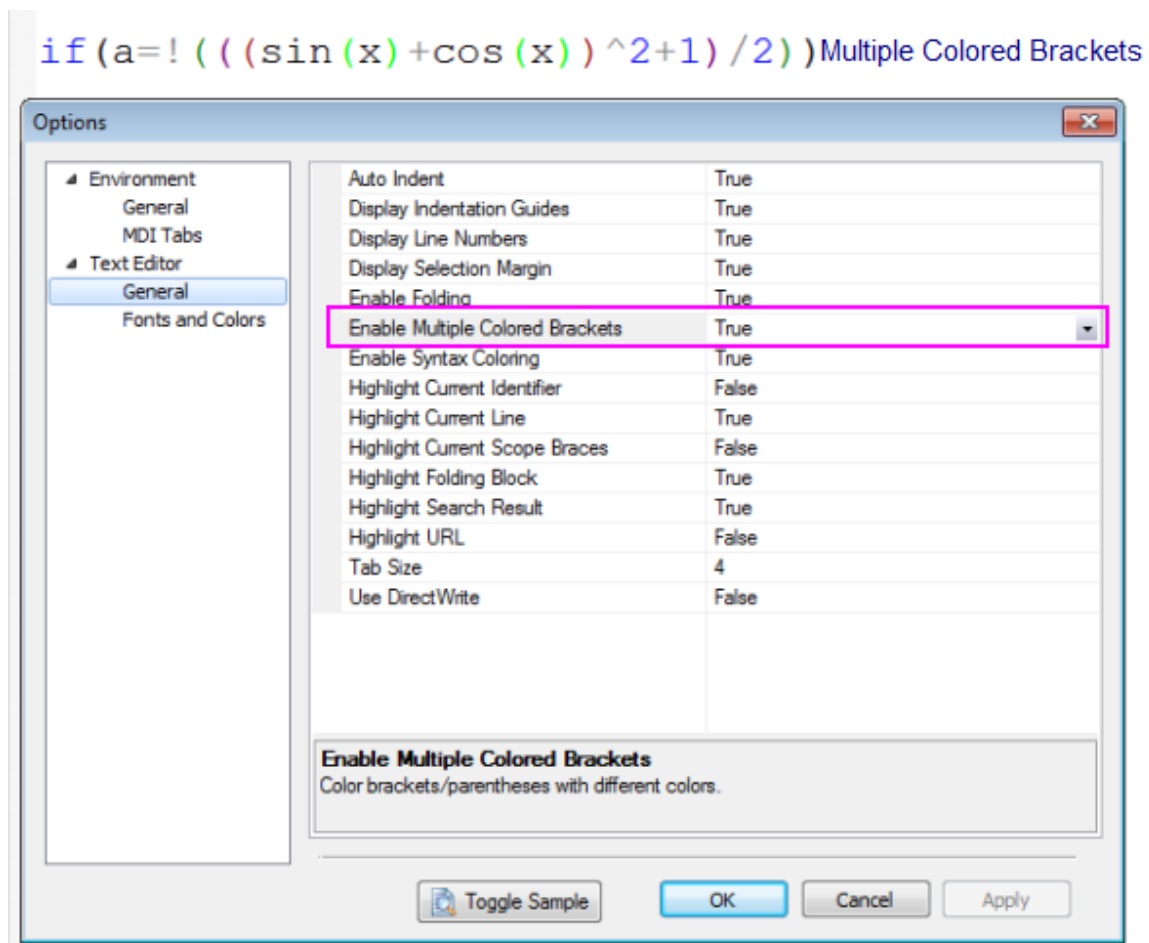

3. Open **Customize** dialog in Origin's main interface by select **View: Toolbars** in main menu. Go to the **Options** tab and check on **Use Large Icons** box, then you can get large icons for buttons in Toolbars (note that this setting may not work well on your system depending on your display settings). Close the **Customize** dialog box.

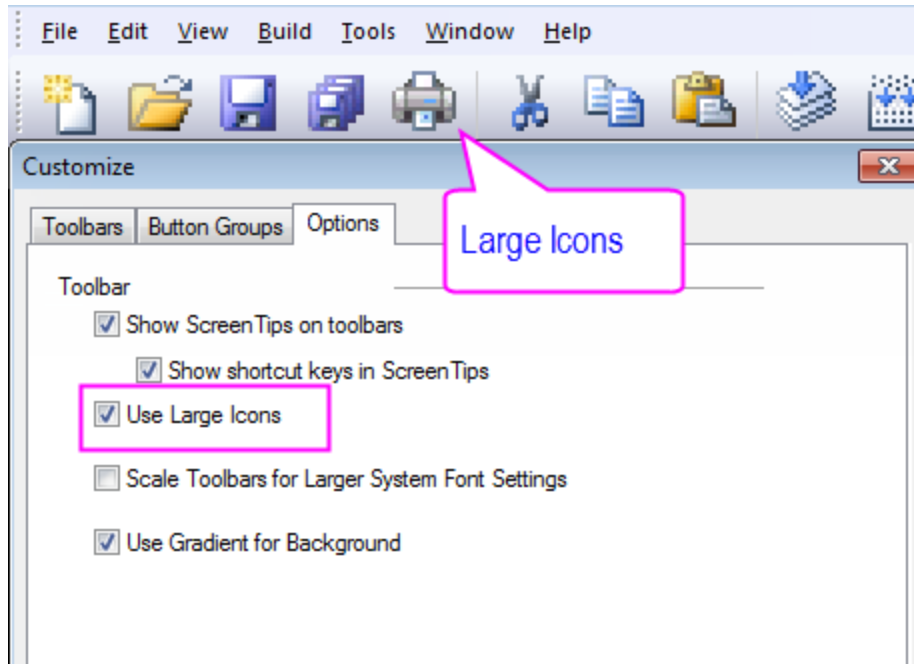

4. You can control the show or hide of each panel by selecting or unselecting them from **View** in Code Builder menu, the selected panel will be shown in **Code Builder**.

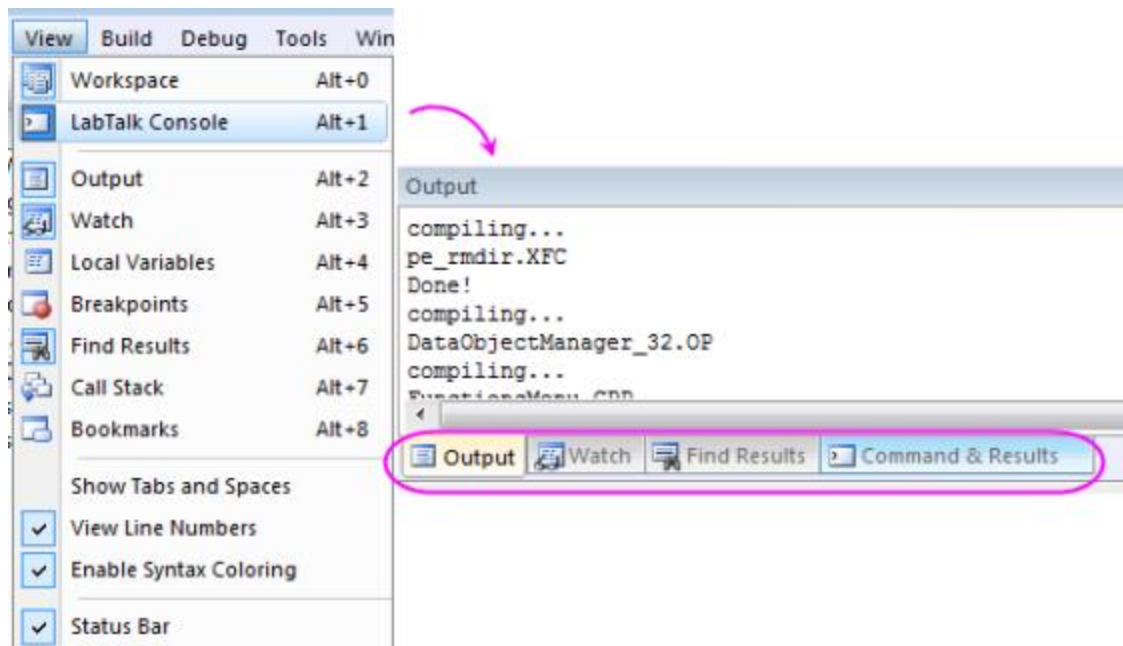

#### 12.3.3.7 Create an App Using Apps folder in Workspace

To create an App package, you need to combine the use of **Apps** folder in Code Builder workspace and the [Package Manager](#). Following steps will show you how to create the package for an App.

1. On the **Standard** toolbar, click the **Code Builder** button  to open Code Builder.

2. Make sure **Workspace** window is open, if not you can select menu **View: Workspace** to open it. Right click on the **Apps** folder in **Origin C Workspace** and select **New** to add a new folder.

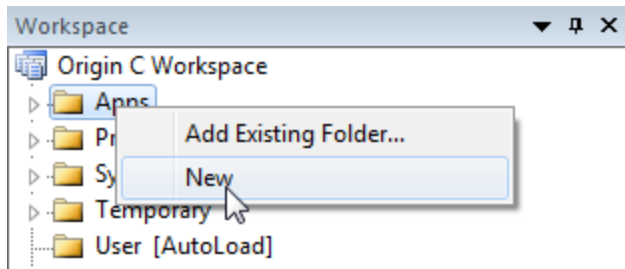

3. Right click on the newly added folder *Untitled* and select **Rename** to name the folder as "MyApp".

4. Right click on *MyApp* folder and select **Add Files...** to open **Add Files to Workspace** dialog. Browse to select all prepared files and click **Open** button to add them to current folder.

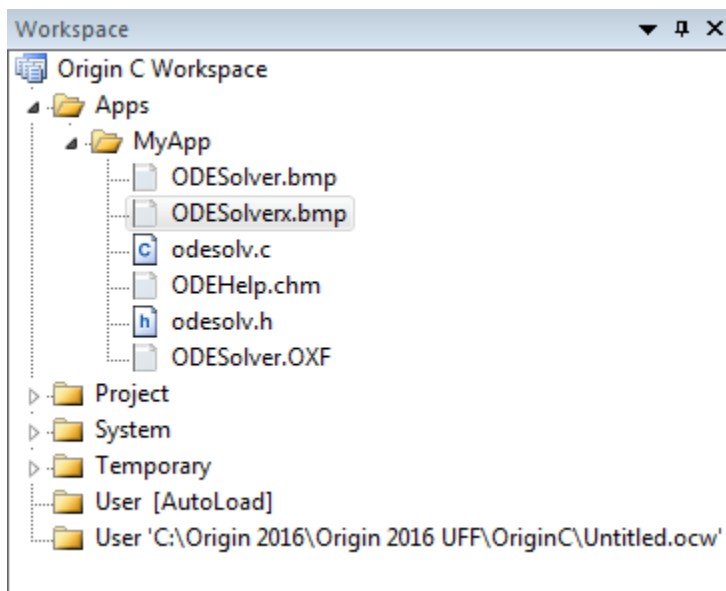

5. Right click *MyApp* folder to select **Generate** and you will be directed to the [Package Manager](#).



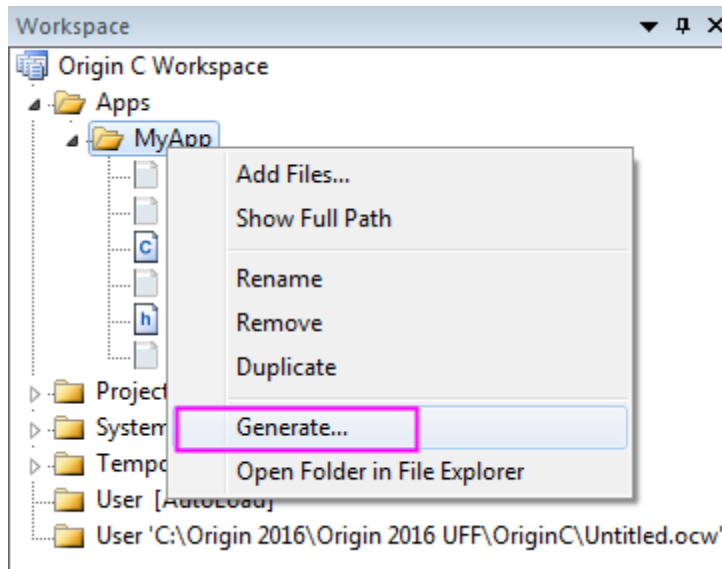

6. You can find the added files in the lower panel of **Package Manager**. Now you can input some basic information about *MyApp* under **Package** node as shown below. To make the App display as an icon in **App Gallery**, you need to prepare a 32\*32 (in pixels) bmp image and input its name with extension in **Icon** edit box. Then you can input some LabTalk script in **Launch Script** field to tell Origin what to do when launching the App.

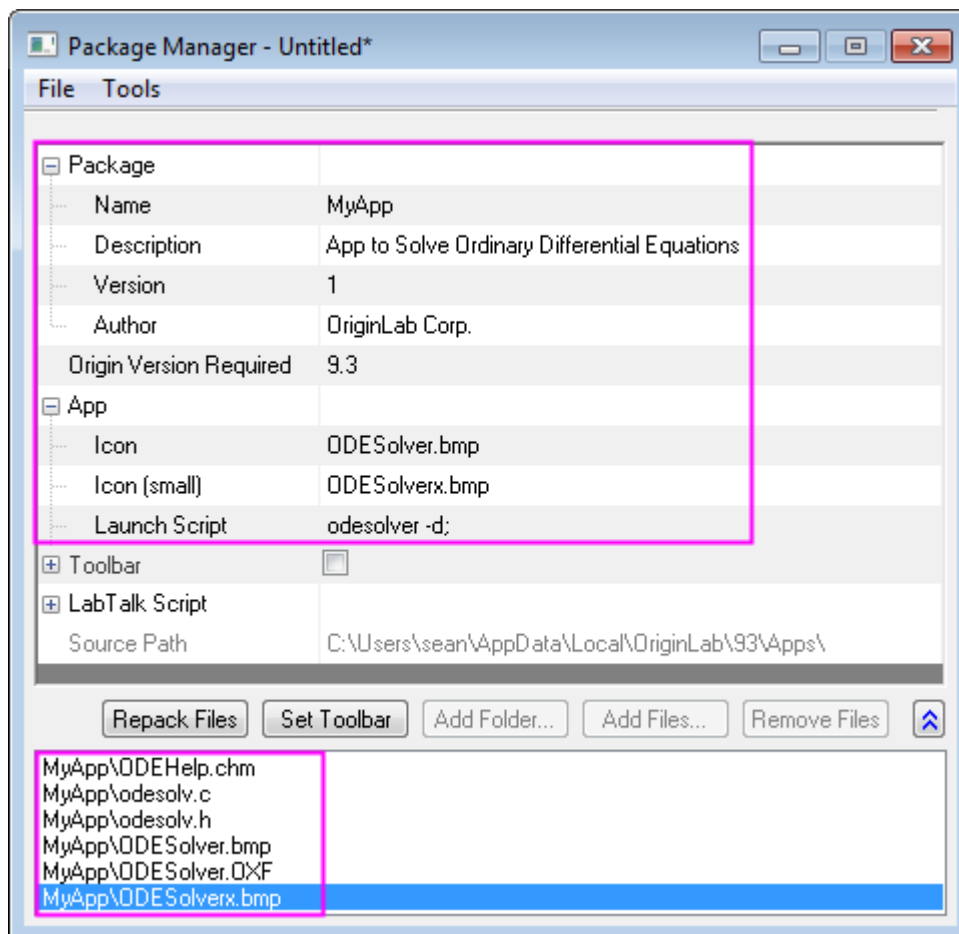

7. Select **File: Save** to save the package as an OPX file. Later you can drag and drop this OPX file into Origin workspace to install this App.

#### 12.3.3.8 Frequently Used Hot Keys

The **Hotkey** in Code Builder make the coding work efficiency. The following parts introduce the useful hotkey one by one.

Firstly, please download [this zip file](#), extract it and then browse to the `\Origin C Examples\Programming Guide\Practical Examples` subfolder to add **AccessMatrix.c** by right-clicking the user folder and select "Add Files"

- **Ctrl+F2** and **F2**

**Ctrl+F2** add a Toggle Bookmark at the specific line. You can use hotkey **F2** to go to next Toggle Bookmark.

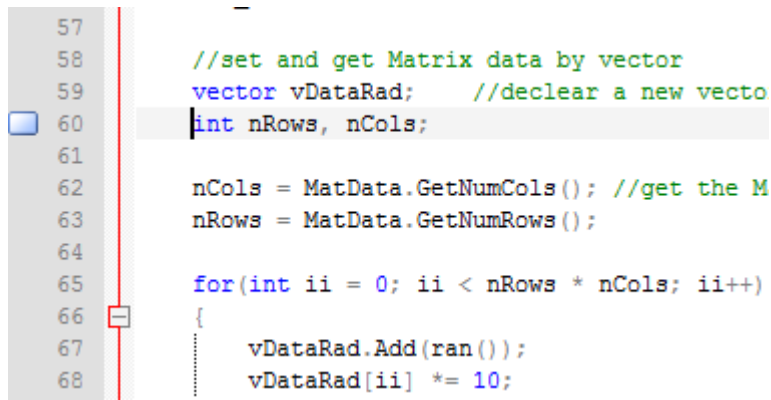

```
57  
58 //set and get Matrix data by vector  
59 vector vDataRad; //declare a new vecto  
60 int nRows, nCols;  
61  
62 nCols = MatData.GetNumCols(); //get the M  
63 nRows = MatData.GetNumRows();  
64  
65 for(int ii = 0; ii < nRows * nCols; ii++)  
66 {  
67     vDataRad.Add(ran());  
68     vDataRad[ii] *= 10;
```

- **Ctrl+F3** and **F3**

**Ctrl+F3** highlight all the select word ("MatData") in code. You can use hotkey **F3** to go to the next highlighted "MatData".

```

Matrix MatData;          //new Ma
MatData.Attach(ml);

MatData.SetSize(3,4); //set the

matrix mat =            //declare
{
    {1, 2, 3, 4},
    {5, 6, 7, 8},
    {9, 10,11,12}
};

MatData = mat;          //put the m

//set and get Matrix cell data
[2][3] = 100; //set one cell v

double dVal = MatData[1][3]; /
out_double("The Value on Corrid

//set and get Matrix data by ve
vector vDataRad; //declare a
int nRows, nCols;

nCols = MatData.GetNumCols(); /
nRows = MatData.GetNumRows();

```

- **Ctrl+]**

This hotkey help you to go to matching brace in the code.

- **F9**

This hotkey add a Toggle Breakpoints at the specific line.

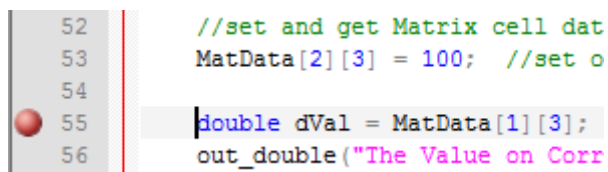

```

52 //set and get Matrix cell dat
53 MatData[2][3] = 100; //set o
54
55 double dVal = MatData[1][3];
56 out_double("The Value on Corr

```

- **Ctrl+/** and **Ctrl + Shift + /**

This hotkey **Ctrl+/** comment the selected lines, while **Ctrl + Shift + /** uncomment them.

- **Ctrl+Alt+O**

After constructing the \*.c and \*.h files with the same name, you can use hotkey **Ctrl+Alt+O** to switch between them.

```

2 // test.h
3 struct layer{
4     double a1;
5     double a2;
6     double a3;
7     double aw;
8     double f1;
9     double f2;
10 };
11
1 //test.c
2 #include <Origin.h>
3 #include "test.h"
4 ///////////////////////////////////////////////////
5 int Main()
6 {
7     layer S1;
8     S1.a1 = 500.;
9     S1.a2 = 2.;
10    S1.a3 = 7.;
11    S1.aw = 1.3;
12    S1.f1 = 23.24;
13    S1.f2 = 0.5;
14    return 0;
15 }

```

Please refer to [Hotkeys in Code Builder](#) for more hotkeys information.

### 12.3.4 Adding New Origin C Functions to Origin

#### 12.3.4.1 Summary

Functions written in Origin C are accessible from various locations within the Origin interface, such as the Script Window, provided they meet the following criteria: the function should return either void (as in the previous tutorial), double, string, or vectors of type double or string. Variables passed to the function from Origin should be of type double or string, or vectors of these types. Functions that do not meet these criteria are not callable from the Origin interface, but can be called within other Origin C functions. Note that although an Origin C function that accepts and returns type int can be called from the Origin interface, the data may be truncated since the interface only supports type double.

In this tutorial, you will be introduced to writing a math function that returns computed values. We will first create a function that returns type double to Origin, and then we will create a function that returns vectors of type double.

Minimum Origin Version Required: Origin 8.0 SR0

#### 12.3.4.2 What you will learn

How to add a new function and how to run this function in the Script Window.

#### 12.3.4.3 Steps

1. Start a new Origin C file in **Code Builder**.
2. Enter the following code:

```

double myfunc1(double x, double a)
{
    return sin( a * x );
}

```

```
}

```

- Click the **Build** button  to compile the function.

This function can now be called from the Origin interface, in places such as the Script Window.

- Go to the Script Window, and type in the following lines, pressing **ENTER** at the end of each line:

```
y = myfunc1(2, 3)

```

```
y =

```

You can also use worksheet cells instead of absolute numbers:

- Make a worksheet active, enter a number in the first row of column A. Then type the following into the Script Window and press **ENTER**:

```
col(B)[1] = myfunc1(col(A)[1], 3)

```

Note that a function such as myfunc1, that accepts and returns type double, can also be used to perform vector operations.

- Fill rows 1 through 10 of Column A with numbers, and type the following into the Script Window:

```
col(B) = myfunc1(col(A), 3)

```

In the above example, Origin calls the myfunc1 function for each row of column A. For performing vector operations as above, it is more efficient to write functions that accept and return vectors.

- Go back to Code Builder and add the following function to the same file, and compile the file by clicking the **Build** button .

```
vector<double> myfunc2(vector<double> vecIn, double a)
{
    vector<double> vecOut;

```

```
vecOut = sin( a * vecIn );  
  
return vecOut;  
  
}
```

8. Go back to the Origin interface, fill Column A with some new numbers, and type the following into the Script Window:

```
col(B) = myfunc2(col(A), 3)
```

The function myfunc2 is called only once for computing the entire column.

Note that you can use such functions in other places such as the "Set Column Values" dialog. The Auto Update feature of "Set Column Values" can be enabled by checking the appropriate check box in this dialog. As long as the Origin C function is compiled and ready to be called from Origin, any changes to the source column will result in an update of the destination column.

## 12.3.5 Organizing and Accessing Origin C Functions

### 12.3.5.1 Summary

Techniques for using your Origin C functions.

Minimum Origin Version Required: Origin 8.0 SR0



### 12.3.5.2 What you will learn

This tutorial will show you how to:

- Save your Origin C Function with your Project
- Associate your Programs with Visual Objects
- Load and Compile your Origin C Function from script

### 12.3.5.3 Saving your Origin C Function with your Project

One way to load and compile your Origin C function is to save the Origin C file as an attachment to your Origin Project (\*.OPJ) file. When a project file is opened, all files attached to it are separated out and stored in a temporary folder. In addition, any Origin C file that was attached is also automatically loaded into the Code Builder workspace, and compiled. The function is then ready to be called upon opening the Origin Project file.

1. Start a new Origin project file by clicking on the **New** Project button  on the **Standard** Toolbar.
2. On the **Standard** Toolbar, click the **Code Builder** button .
3. From the Code Builder menu, select **File: New**. This opens the **New File** dialog box.
4. In the top list-box, select **C File**.

5. In the **File Name** text box, type: **Test**. Keep the **Add to Workspace** check box selected. Click **OK**. The file Test.c is added to the workspace.
6. Select and copy the following function, and paste it into the Test.c file. Be sure to paste the text below the line that reads "//start your functions here."

```
void Plot_Data(string strTemplate, string strData)
{
    // Create a graph window from a Template

    GraphPage gp;

    BOOL bOK = gp.Create(strTemplate, CREATE_VISIBLE);

    if( !bOK )

        return;

    // Attach the first layer (0) to a GraphLayer object

    GraphLayer gl = gp.Layers(0);

    //Attach a dataset to a Curve object

    Curve crv(strData);

    // Add the Curve to the graph layer

    int nPlot = gl.AddPlot(crv);

    if(nPlot >= 0)

    {
```

```
// Set plot color to Green(2)

gl.DataPlots(nPlot).SetColor(2, TRUE);



// Rescale this graph layer

gl.Rescale();

}

}
```

The Plot\_Data function takes two arguments: (1) the template name and (2) the name of a Y dataset to include (plot) in the layer.

7. Click the **Build** button  to compile and link the file.
8. Drag-and-drop the file Test.c from the User subfolder branch of the Workspace tree, to the Project subfolder. (**Hint:** You may need to first expand the User subfolder branch to display the Test.c entry prior to dragging the file).
9. Go back to the Origin interface and save the project by clicking the **Save** button  on the Standard Toolbar. Give the project the name Test.OPJ, and save it in a location of your choosing.
10. The Origin C file, Test.c, is now saved with the Project. To verify this, close the project, and go back to Code Builder. You will see that there are no entries under the Project subfolder of the Workspace tree. Now go back to Origin interface and reopen the project. Go to Code builder and verify that Test.c is now listed under the Project subfolder (**Hint:** you may need to expand the Project subfolder branch to see the Test.c entry).

#### 12.3.5.4 Associating your Programs with Visual Objects

You will now learn how to create a button on a worksheet and program the button to call the Origin C function in the Test.c file that you saved with the project.

1. Open the Test.OPJ project that you saved under step 9 ([previous section](#)).
2. Highlight the A(X) and B(Y) columns, right-click and select **Fill Columns With: Row Numbers**.
3. From the menu, select **Format: Worksheet** to open the **Worksheet Properties** dialog box.
4. In the **Size** tab, **Worksheet Measurement** branch, set the **Gap from Top** to **40** and click **OK** to close the dialog.



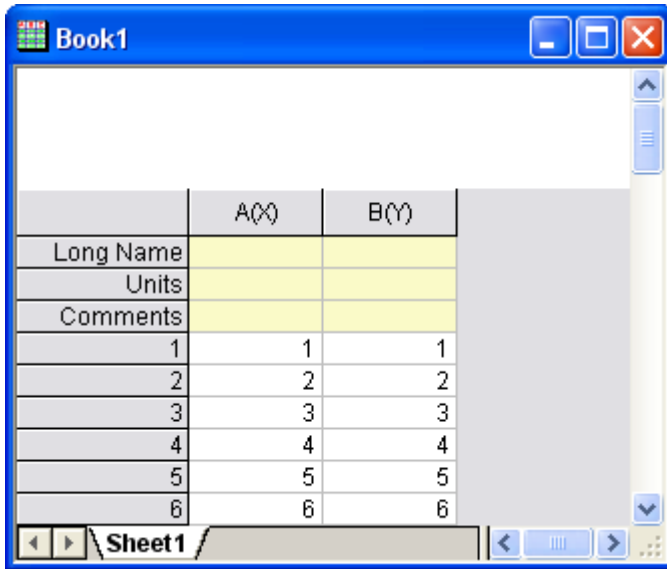

The worksheet now has sufficient space above the column headings to add a text label.

Right-click in the area directly above the two columns and choose **Add Text**.

5. At the cursor, type: **Plot Data**.
6. Click once outside the text label to deselect it.
7. Right-click on the text label and choose **Programming Control** to open the **Programming Control** dialog box. (**Hint:** Please choose **Label Control** in Origin 7.5)
8. From the **Script, Run After** drop-down list, choose **Button Up**.
9. Type the following script in the text box at the bottom of the dialog box:

```
Plot_Data("scatter", "book1_b");
```

10. Click **OK**.

Your text label will now look like a button.

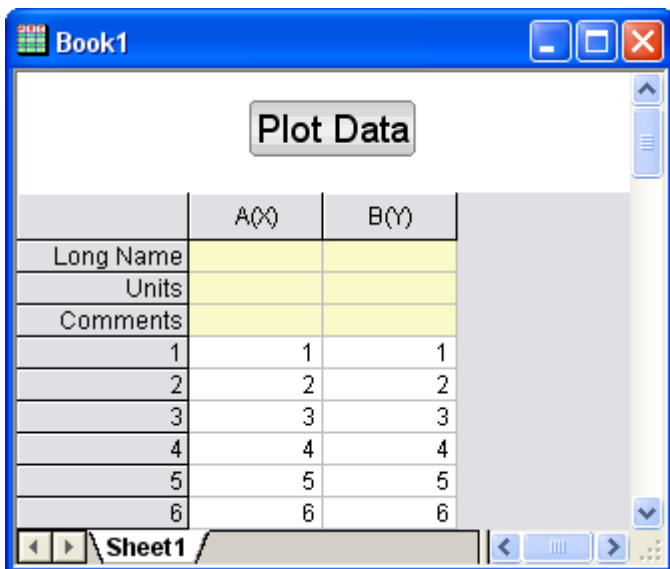

11. Click the **Plot Data** button on your worksheet.

12. The Plot\_Data function in your Test.c file is called, and a scatter plot is created.

**Notes:** The script behind the button assumes that you have data in column B(Y) of the Data1 worksheet and that there is an associated X data set.

#### 12.3.5.5 Loading and Compiling your Origin C Function from Script

In this tutorial we learned how to save an Origin C function along with the project file and then access the function from the Origin interface. Saving an Origin C file with a project limits access to functions within that file to only that project. When a new project is opened, the functions are not available any more.

To access functions in an Origin C file that is saved on disk, the file can be programmatically loaded and compiled using LabTalk script. The script command for performing the programmatic load and compile is run.LoadOC. Refer to the **LabTalk** Help files (**Help: Programming: Labtalk**) for more information on using this command.

This concludes the **Origin C Functions** tutorial.

### 12.3.6 Tutorial: Calculating Double Integral with NAG Functions From Origin C

#### 12.3.6.1 Summary

Origin/OriginPro includes the complete NAG Mark 9 numerical library. This library provides multiple method for numerical integration. All functions are accessible from Origin C. In this tutorial, you will call NAG functions to perform the double integration. Note that an infinite NAG integrator is used here.

#### 12.3.6.2 What you will learn

This tutorial will show you how to:

- Call NAG functions in Origin C
- Solve definite double Integral using the NAG integration routine

### 12.3.6.3 Example and Steps

To calculate the double integration. You need to call function in NAG library category [D01 Quadrature](#). This category provides functions for the numerical evaluation of definite integrals in one or more dimensions. Two functions with different algorithm are available for double integral, which is [nag\\_multid\\_quad\\_adapt\\_1](#) and [nag\\_multid\\_quad\\_monte\\_carlo\\_1](#). In this tutorial, you will learn to use them to solve the integral formula below:

$$\int_0^1 \int_0^1 xy(x+y)dx dy$$

You are recommended to read the relevant tutorial [Calling NAG Functions From Origin C](#), to study how to run and test the code below for calculation. Then you can copy and paste the code into new created .c file in **Code Builder** and run the compile and build process. Below is the Origin C code with comments:

#### 12.3.6.3.1 Using `nag_multid_quad_monte_carlo_1`

```
#include <Origin.h>

#include <OC_nag.h>

#define MAXCLS 20000 //maximum number of integrand evaluations to be allowed

double NAG_CALL f(Integer ndim, double x[], Nag_User *comm)
{
    return x[0]*x[1]*(x[0]+x[1]); //define the function formula
}

int multid_quad_monte_carlo()
{
    Integer exit_status = 0, k, maxcls = MAXCLS, mincls;
```

```
Integer ndim =2; // the number of dimensions of the integral

NagError fail;

Nag_MCMethod method;

Nag_Start cont;

Nag_User comm;

double a[2], b[2], acc, *comm_arr, eps, finest;

comm_arr=NULL;

if (ndim < 1){

    printf("Invalid ndim.\n");

    exit_status = -1;

    return exit_status;

}

for (k = 0; k < ndim; k++){

    a[k] = 0.0; // the lower limits of integration

    b[k] = 1.0; // the upper limits of integration

}

eps = 0.01; //the relative accuracy required

mincls = 1000; //minimum number of integrand evaluations to be allowed

method = Nag_ManyIterations;
```

```

cont = Nag_Cold;

/* nag_multid_quad_monte_carlo_1 (d01xbc).
 * Multi-dimensional quadrature, using Monte Carlo method,
 * thread-safe
 */

nag_multid_quad_monte_carlo_1(ndim, f, method, cont, a, b, &mincls, maxcls,eps,
&finest, &acc, &comm_arr, &comm, &fail);

if (fail.code == NE_NOERROR || fail.code == NE_QUAD_MAX_INTEGRAND_EVAL){

    if (fail.code == NE_QUAD_MAX_INTEGRAND_EVAL){

        printf("Error from nag_multid_quad_monte_carlo_1
(d01xbc).\n%s\n",fail.message);

        exit_status = 2;

    }

    //output the calculation results

    printf("Requested accuracy = %7.2e\n", eps);

    printf("Estimated value = %7.5f\n", finest);

    printf("Estimated accuracy = %7.2e\n", acc);

    printf("Number of evaluations = %6d\n", mincls);

}

else{

```

```
        printf("Error from nag_multid_quad_monte_carlo_1
(d01xbc).\n%s\n", fail.message);

        exit_status = 1;
    }

/* Free memory allocated internally */

if (comm_arr)

    NAG_FREE(comm_arr);

return exit_status;
}
```

Then you can call the functions in LabTalk Console. The results will be like this:

```
Requested accuracy = 1.00e-002
```

```
Estimated value = 0.33326
```

```
Estimated accuracy = 2.23e-004
```

```
Number of evaluations = 1552
```

### 12.3.6.3.2 Using `nag_multid_quad_adapt_1`

```
#include <OC_nag.h>

#include <Origin.h>

#define NDIM 2 //the number of dimensions of the integral

#define MAXPTS 1000*NDIM //maximum number of integrand evaluations to be allowed

double NAG_CALL f(Integer n, double x[], Nag_User *comm)
```

```
{  
  
    return x[0]*x[1]*(x[0]+x[1]); //define the function formula  
  
}  
  
int multid_quad_adapt()  
  
{  
  
    Integer exit_status = 0;  
  
    Integer ndim = NDIM;  
  
    Integer maxpts = MAXPTS;  
  
    double a[2], b[2];  
  
    Integer k;  
  
    double finval;  
  
    Integer minpts;  
  
    double acc, eps;  
  
    Nag_User comm;  
  
    NagError fail;  
  
    for (k = 0; k < 2; k++)  
  
    {  
  
        a[k] = 0.0; //the lower limits of integration  
  
        b[k] = 1.0; //the upper limits of integration
```

## Tutorials for Origin

```
    }

    eps = 0.001;

    minpts = 0;

    nag_multid_quad_adapt_1(ndim, f, a, b, &minpts, maxpts, eps, &finval,&acc,
&comm, &fail);

    if (fail.code != NE_NOERROR && fail.code != NE_QUAD_MAX_INTEGRAND_EVAL)

    {

        printf("Error from nag_multid_quad_monte_carlo_1
(d01xbc).\n%s\n", fail.message);

        exit_status = 1;

        return exit_status;

    }

    //output the calculation results

    printf("Requested accuracy = %7.2e\n", eps);

    printf("Estimated value = %7.5f\n", finval);

    printf("Estimated accuracy = %7.2e\n", acc);

    return 0;

}
```

Then you can call the functions in LabTalk Console. The results will be like this:

```
Requested accuracy = 1.00e-003
```

```
Estimated value = 0.33333
```



```
Estimated accuracy = 3.33e-016
```

## 12.3.7 Tutorial: Calling NAG Functions From Origin C

### 12.3.7.1 Summary

Calling a NAG function from an Origin C function is very much like calling any other Origin C function. You must familiarize yourself with the desired NAG function to gain an understanding of what parameters the function requires to be passed as arguments and what parameters the function returns. Once familiar with the function, you must develop code that follows the function's requirements.

The NAG header file containing the function's prototype must be included, required parameters must be correctly declared, sized, and initialized, and the function call must follow the function's prototype as described in header file. The objective of this tutorial is to demonstrate how to call a NAG function from an Origin C function.

Minimum Origin Version Required: Origin 8.1 SR1

### 12.3.7.2 What you will learn

This tutorial will show you how to:

- Understand NAG functions
- Get Ready to Debug Sample Code
- Include the NAG Header
- How to See the Declaration of NAG Function
- How to Get NAG Error Code
- How to Use Function Pointer

### 12.3.7.3 Understand NAG Functions

The primary resource for understanding NAG functions is [NAG library](#). The library also can be found in Origin C Reference. For example, d01sjc NAG function:

1. From the Origin menu select Help:Programming:OriginC. In the Origin C Reference book, expand the Global Functions book, expand the NAG Functions book, and choose Accessing NAG Functions Category and Help.
2. Select Quadrature (d01) category and then select nag\_1d\_quad\_gen\_1 (d01sjc) function.
3. The selected page is one PDF file. Study the nag\_1d\_quad\_gen\_1 function as needed to understand the description of the function, the function's prototype, and the description of all arguments. Sample data and an example program calling the function are also often included.

Secondary resource for understanding the Origin C NAG functions is Examples book. From the Origin menu select Help:Programming:OriginC, expand Examples book, expand Analysis book, choose Accessing NAG Functions, there are some examples to show how to call NAG functions in Origin C.

### 12.3.7.4 Get Ready to Debug Sample Code

The best way to understand how to write an Origin C function that calls a NAG function is to step through an example function in Debug mode. Follow the steps below to set up Origin and Code Builder to execute such a sample Origin C function in Debug mode.

1. From the Code Builder menu, select **File: New**. This opens the **New File** dialog box.
2. In the **File Name** text box, type: **TestNAG**, Keep **Add to Workspace** checkbox is checked. Click **OK**. The file TestNAG.c is added to the workspace.
3. Select and copy the following function, and paste it into the TestNAG.c file. Be sure to paste the text below the line that reads "// Include your own header files here."

```
// Include your own header files here.

#include <OC_nag.h>

// Start your functions here.

//NAG_CALL denotes proper calling convention. You may treat it like a function
pointer

//and define your own integrand

static double NAG_CALL f_callback_ex(double x, Nag_User *comm)

{

    int *use_comm = (int *)comm->p;

    return (x*sin(x*30.0)/sqrt(1.0-x*x/(PI*PI*4.0)));

}

void nag_d01sjc_ex()
```

```
{  
  
    double a = 0.0;  
  
    double b = PI * 2.0; // integration interval  
  
    double epsabs, abserr, epsrel, result;  
  
    // you may use epsabs and epsrel and this quantity to enhance your desired  
precision  
  
    // when not enough precision encountered  
  
    epsabs = 0.0;  
  
    epsrel = 0.0001;  
  
    // The max number of sub-intervals needed to evaluate the function in the  
integral  
  
    // The more difficult the integrand the larger max_num_subint should be  
  
    // For most problems 200 to 500 is adequate and recommended  
  
    int max_num_subint = 200;  
  
    Nag_QuadProgress qp;  
  
    NagError fail;  
  
    Nag_User comm;  
  
    static int use_comm[1] = {1};  
  
    comm.p = (Pointer)&use_comm;
```

```
    //Note:nag_ld_quad_gen (d01ajc) has been replaced by nag_ld_quad_gen_1
(d01sjc) at Mark 25

    d01sjc(f_callback_ex, a, b, epsabs, epsrel, max_num_subint,&result,
&abserr, &qp, &comm, &fail);

    // For the error other than the following three errors which are due to bad
input parameters

    // or allocation failure  NE_INT_ARG_LT  NE_BAD_PARAM  NE_ALLOC_FAIL

    // You will need to free the memory allocation before calling the
integration routine again to

    // avoid memory leakage

    if (fail.code != NE_INT_ARG_LT && fail.code != NE_BAD_PARAM && fail.code !=
NE_ALLOC_FAIL)

    {

        NAG_FREE(qp.sub_int_beg_pts);

        NAG_FREE(qp.sub_int_end_pts);

        NAG_FREE(qp.sub_int_result);

        NAG_FREE(qp.sub_int_error);

    }

    printf("%10.6f", result);

}
```

#### 12.3.7.5 Include the NAG Header

```
#include <OC_nag.h>
```

This header file containing all the header files of NAG functions, and all type define and error code define. So just include this one function should be enough.

#### 12.3.7.6 How to See the Declaration of NAG Function

See the declaration of NAG functions from the header file:

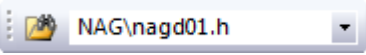
1. Activate TestNAG.c file that created in above section, move scroll bar to find out #include <OC\_nag.h> line.
2. Right click anywhere in the line and select **Open "OC\_nag.h"**. This opens the NAG header file.
3. Move scroll bar to find out #include <NAG\_MARK25\oc\_nag\_all.h> line, and also right click to select **Open "NAG\_MARK25\oc\_nag\_all.h"**. This opens the header file containing all nag headers at Mark25.
4. In the Search combo box  type **nagd01.h** and press **ENTER** button to find out this line. Function **d01sjc** belongs to d01 category, so the header file name should be nagd01.h.
5. Right click anywhere of this line to choose **Open "nagd01.h"**. This opens the header file including the prototype of the functions.
6. In the Search combo box, type **d01sjc** and press **ENTER** button to go to the declaration of this function.

To see the declaration of functions from NAG PDF:

- [NAG PDF Online](#)
- [NAG PDF Files](#)

#### 12.3.7.7 How to Get NAG Error Code

1. Reactivate the TestNAG.c window in Code Builder. In this file, the **NagError** variable **fail** is defined and passed as last argument to function **d01sjc**.
2. NAG function returns error code into NagError variable code item. In this example, can access NAG error code by **fail.code**.

How to know what error codes will be got:

3. Open Origin C Help from Origin menu **Help: Programming: OriginC**, expand Origin C Reference book, Global Functions book, NAG Functions book and choose Accessing NAG Functions Category and Help.
4. In **Chapters of NAG C Library** table, choose **d01** to enter Quadrature page, select d01sjc in the table of this category to open the PDF help of this NAG function.
5. Drag scroll bar to page down to **6 Error Indicators and Warnings** part, there list all error codes for this function and the related description. Can directly use these error codes in Origin C if included correct header file (include <OC\_nag.h>, this header containing all NAG headers), for example NE\_INT\_ARG\_LT, NE\_BAD\_PARAM, NE\_ALLOC\_FAIL used in TestNAG.c file.

## 12.3.7.8 How to Use Function Pointer

1. Open nagd01.h file from Origin program path \OriginC\system\NAG\_MARK25 folder.
2. In this file, find out the declaration of **d01sjc** function. The first argument type of this function is **NAG\_D01SJC\_FUN**.
3. Double-click **NAG\_D01SJC\_FUN** to high-light it. From menu choose **Edit: Find in Files** to open **Find in Files** dialog. Set settings same as the following picture, click Find button.

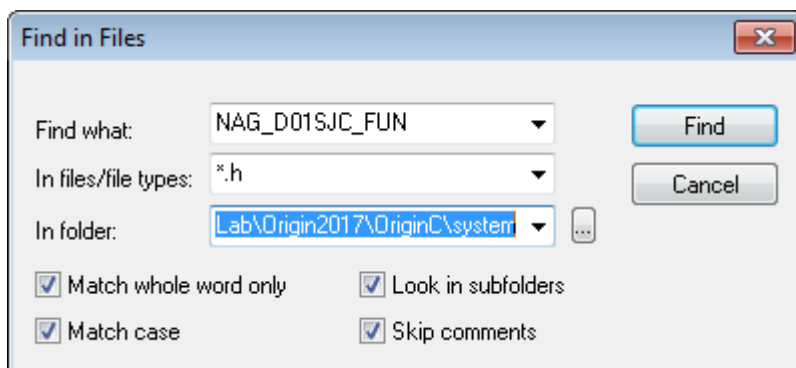

4. Searching result display in Output window. Double click nag\_types.h line to go to this file, **typedef NAG\_D01\_TS\_FUN NAG\_D01SJC\_FUN** line, you can find the define of NAG\_D01\_TS\_FUN nearby.
5. The define of NAG\_D01\_TS\_FUN is

```
typedef double (NAG_CALL * NAG_D01_TS_FUN) (double, Nag_User *comm);
```

User defined function should keep the same return type and argument list as this define. And **NAG\_CALL** denotes proper calling convention and it should be used in your own function.

6. Activate TestNAG.c file. There is a function named **f\_callback\_ex** and it used as function pointer in **d01sjc** as the first argument.

```
double NAG_CALL f_callback_ex(double x, Nag_User *comm)
{
    int *use_comm = (int *)comm->p;

    return (x*sin(x*30.0)/sqrt(1.0-x*x/(PI*PI*4.0)));
}
```

```
}

```

## 12.3.8 Accessing Internal Origin Objects by Origin C

### 12.3.8.1 Summary

Internal Origin objects (such as Project Explorer folders, Origin windows (pages), layers, plots, graphic objects, data sets, etc.) are accessed using Origin C classes. To access or programmatically control an internal Origin object, you must attach it to an Origin C object.

To attach something to an internal Origin object you must first "find" it using the properties, methods, and collections of a container class. Common container classes include the Project, Folder, Page, GraphPage, Layer, GraphLayer, Worksheet, MatrixLayer, and Collection classes. Once found, an internal Origin object can easily be attached to an Origin C object of the appropriate type.

The internal Origin object is then programmatically controlled by manipulating the class methods and properties of the attached Origin C object. The objective of this tutorial is to demonstrate how to find particular internal Origin objects, attach things to those objects, and access the objects by manipulating the methods and properties of the attached Origin C objects.

Minimum Origin Version Required: Origin 8.1 SR1

### 12.3.8.2 What you will learn





This tutorial will show you how to:

- Access Worksheet Related Objects
- Access Graph Related Objects

### 12.3.8.3 Accessing Worksheet Related Objects

Familiarity with the Origin C Project class (Project.h), the Collection class (Collection.h), and the Folder class (Folder.h), is valuable when attempting to understand how to find particular internal Origin Objects. Users may find it helpful to preview these classes in the **Origin C Reference: Classes** book of **Origin C Help** or in the above header files located in the ..\Origin\OriginC\system subfolder.

To begin this tutorial:

1. Download [this zip file](#), extract it.
2. On the **Standard** toolbar, click the **New Project** button .
3. On the **Standard** toolbar, click the **Code Builder** button .
4. On the **Code Builder** menu, select **File: New Workspace**.
5. On the **Code Builder** menu, click the **Open** button .
6. Open the unzipped folder created at step 1, browse to the \Origin C Examples\Programming Guide\Introduction to Accessing Origin Objects folder in the Origin software directory, select AccessWorksheetObjectsTutorial.c, check the **Add to Workspace** check box and click **Open**.
7. On the **Code Builder** toolbar, click the **Rebuild All** button . This compiles and links the file.
8. On the Code Builder **View** menu, verify that the **LabTalk Console** (Command & Results) and the **Local Variables** windows are visible (the corresponding menu items should be checked).

- From the **Code Builder** menu, select **Tools: Customize**. Select the Toolbars tab and make sure that the **Debug** toolbar check box is selected.
- In Code Builder, activate `AccessWorksheetObjectsTutorial.c`.
- Near the top of the file, locate and click on the line:

```
PageBase pb;
```



You can position the cursor anywhere on the line.

- From the Code Builder menu, select **Debug: Toggle Breakpoints**. Alternately, press **F9** or click the **Toggle Breakpoint** button  on the **Debug** toolbar.

A brown circle is displayed in the gray margin to the left of the above line indicating that a Debug breakpoint has been set for that line.

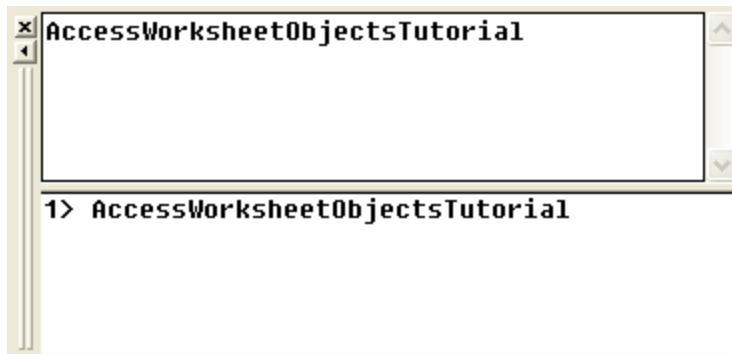
- In the Code Builder workspace, activate the LabTalk Console (Command & Results window) and type in the following:  
`AccessWorksheetObjectsTutorial`
- Press **ENTER** to execute the function.





- On the **Debug** toolbar, press the **Step Into** button .
- Press the **Step Into** button  repeatedly, stopping to read the comments for each statement. Periodically stop and resize and/or reposition the Local Variables window to view the current run-time value of each variable.

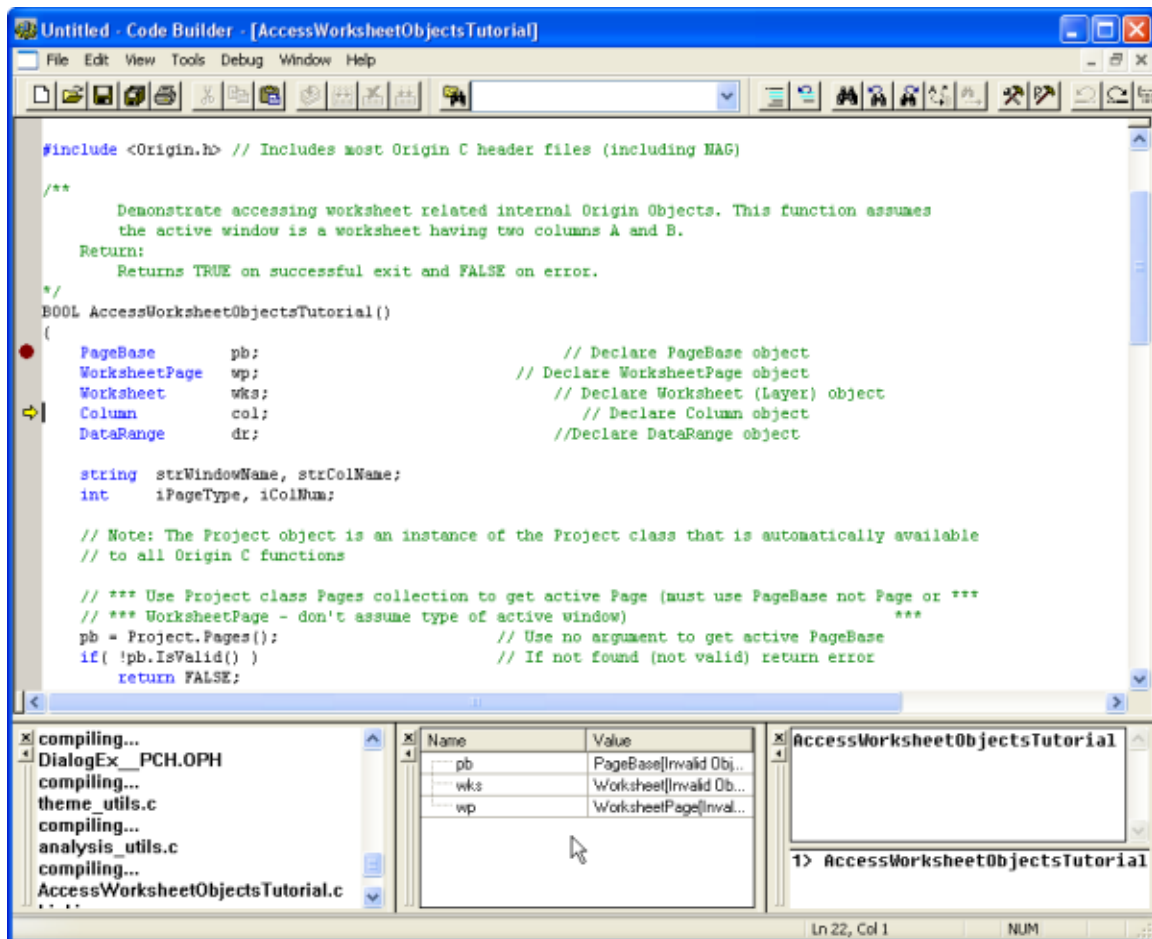



#### 12.3.8.4 Accessing Graph Related Objects

- Return to the *Origin* workspace and, on the **Standard** toolbar, click the **Open** button .
- Locate the unzipped folder you created at step 1 of above section in this page. Browse to the *\Origin C Examples\Programming Guide\Introduction to Accessing Origin Objects* subfolder, select *AccessGraphObjectsTutorial.OPJ*, and click **Open**. You may be prompted to save changes to an untitled project. Click **No** and a worksheet and graph should open.
- From the Code Builder menu, select **File: New Workspace**. Click **No** when prompted to save workspace changes.
- In Code Builder, click the **Open** button .
- Locate the unzipped folder again. Browse to the *Origin C Examples\Programming Guide\Introduction to Accessing Origin Objects* subfolder, select *AccessGraphObjectsTutorial.c*, select the **Add to Workspace** check box, and click **Open**.
- Click the **Rebuild All** button  to compile and link the file.
- On the Code Builder **View** menu, verify that the **LabTalk Console** (Command & Results) and the **Local Variables** windows are visible (the corresponding menu items should be checked).



- From the Code Builder menu, select **Tools: Customize**. Select the Toolbars tab and make sure that the **Debug** toolbar check box is selected.
- In the Code Builder workspace, activate AccessGraphObjectsTutorial.c.
- Near the top of the file locate and click on the line:

```
GraphPage gp;
```

You can position the cursor anywhere on the line.

- From the Code Builder menu, select **Debug: Toggle Breakpoints**. Alternately, press **F9** or click the **Toggle Breakpoint** button  on the **Debug** toolbar.

A brown circle is displayed in the gray margin to the left of the above line indicating that a Debug breakpoint has been set for that line.

- Activate the LabTalk Console (Command & Results window) in Code Builder and type the following:  
AccessGraphObjectsTutorial
- Press **ENTER** to execute the function.
- On the **Debug** toolbar, press the **Step Into** button 
- Press the **Step Into** button  repeatedly, stopping to read the comments for each statement. Periodically stop and resize and/or reposition the Local Variables window to view the current run-time value of each variable.

This concludes the **Internal Origin Objects** tutorial.

## 12.3.9 Create and Update Apps for Origin

### 12.3.9.1 Summary

**Apps** are custom applications for Origin that perform specific graphing and/or analysis tasks. Origin users can browse for Apps and download and install them from the [File Exchange](#) area of the OriginLab website. Origin users can also create Apps and share with other on File Exchange. This tutorial provides the guidelines for making an App and detailed steps to build, upload and modify an App.

### 12.3.9.2 What you will learn

This tutorial will show you how to:

- Build an App
- Upload an App to File Exchange Website
- Modify an App and Submit for Approval

### 12.3.9.3 App Files Specifications

The following files are supported/needed for Apps:

Icon files

#### Icon file (Required)

This should be a png file with size of 32\*32 in pixels. This icon will be displayed in the [Apps Gallery](#) window in Origin.

#### Small icon file (Optional)

This should be a bmp file with size of 16\*16 in pixels, and 16 color (4 Bits). It will be available from **View: Toolbars: Apps button group** in Origin. It can be used as a button, by adding to a toolbar.

Programming files

X-Function, \*.ogs, \*.c, \*.h and DLL files are supported. Note that X-Function file name should not be the same as \*.c file name if both exist.

Other files

Any other files such as documentation (\*.chm, \*.pdf), image files, sample data, etc, can be included.

### 12.3.9.4 Building an App

1. Locate the **Apps** folder under the **AppData** area of your Origin installation. You can enter the following command in Command/Script Window to locate this folder:

```
%@A=; // The output can be, e.g., C:\Users\XXX\AppData\Local\OriginLab\Apps\
```

2. Open the folder in the path found in step1, create a subfolder in this location. Note that the subfolder name will be used as your App name. Place all your files for the App in this subfolder.

3. Start Origin and click **Code Builder** button  in Origin main interface.

4. In **Code Builder** window, right click on the **Apps** folder in the left **Workspace** panel. Select **Add Existing Folder** from the shortcut menu and browse to add the folder created in step 2. Expand the folder in Workspace panel. All files in the folder will be listed.

Note that if you have no existing App folder, you can choose **New** from the shortcut menu to create a new sub-folder in Apps folder. If you right click on a file, you can choose to remove the file. Right click on the folder, and you can add more files, even files not located in current folder.

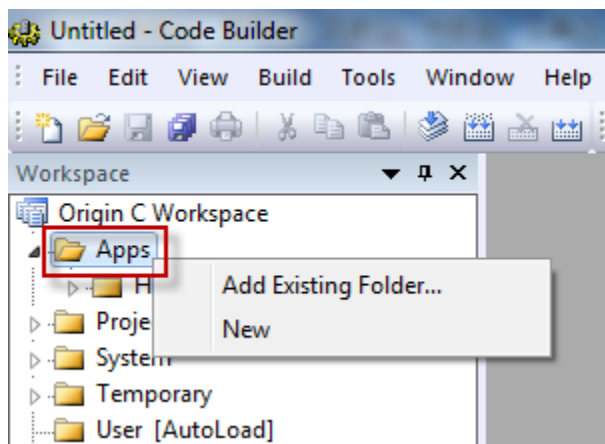

5. Right click on the newly created App folder in Code Builder's Workspace panel, and choose **Generate** from the shortcut menu. It will open the **Package Manager** dialog.

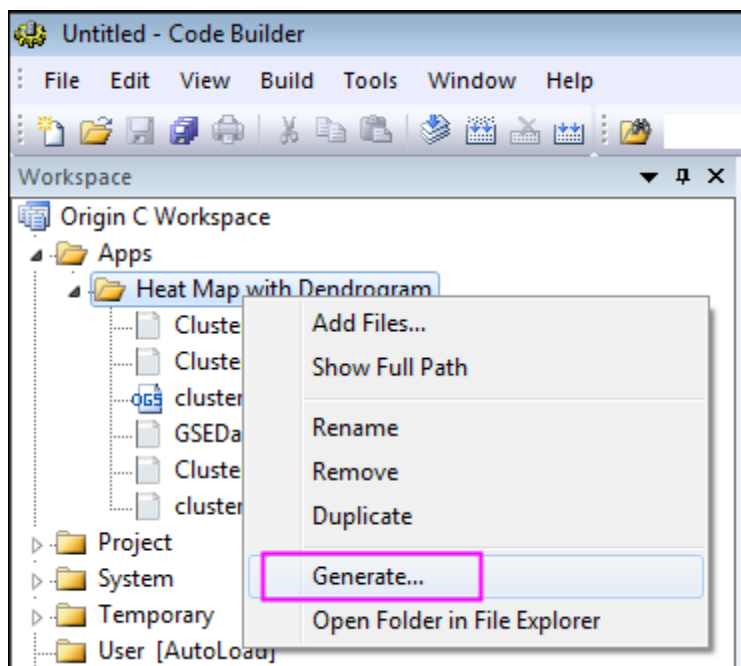

6. In **Package Manager** dialog, do the following:

- **Package branch:**

Name

Do not change the **Name** field, otherwise the folder name will also be changed.

Description

Input descriptions of the App in this field. The descriptions will be shown in the file exchange web's **Summary** section.

Version

Set current App version. You can use two decimal digits, e.g. 1.11.

#### Origin Version Required

Set the required Origin version. For Origin 2016, you should type 9.3 instead of 2016.

- **App branch:**

#### Icon

Set it to file name for icon to be displayed in Apps Gallery window.

#### Icon (Small)

Set it to file name for small icon used in toolbar.

#### Launch Script

LabTalk script to run after you click the App icon. If you want to open an X-Function dialog, you can write your script such as: `xfname -d`; You can also have your script point to a section in ogs file, and run that section, e.g. `run.section(%Afoldername\ogsname,sectionname)`.

#### Enable by Window

Specify the active window type(s) for which the App should be enabled. e.g. for Latex App, Graph window should be active.

- **LabTalk Script branch:**

Specify LabTalk script for before, after installation and before uninstalling.

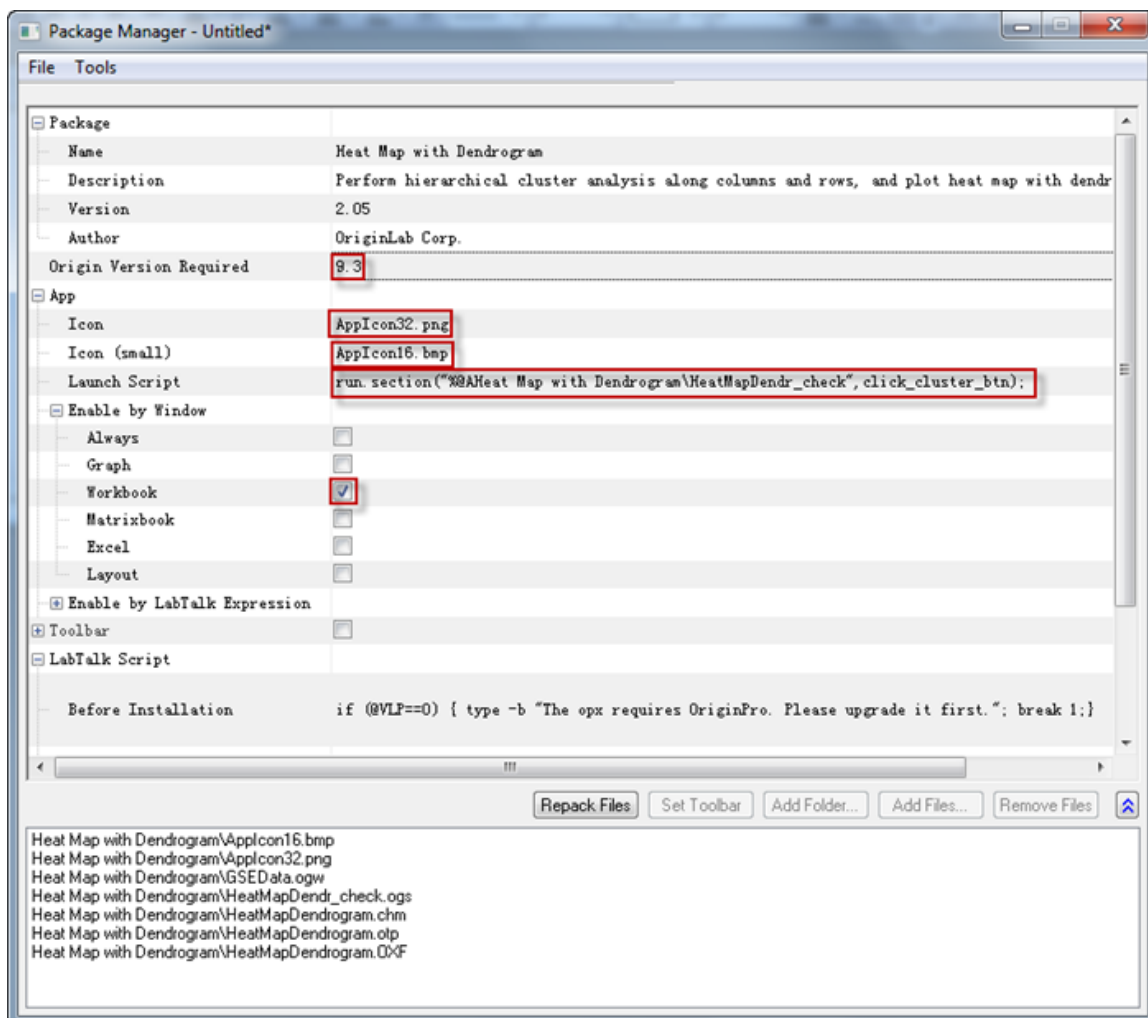

7. When settings are done in **Package Manager**, click **File: Save** from the menu. The .opx file will be saved. The opx name can be different from the folder name. The opx file for an App is ready now. You can simply drag-and-drop the file onto Origin to install. Note that you may need to run Origin **not as administrator** to be able to drop the file onto Origin.

#### 12.3.9.4.1 Uploading App to File Exchange Website

When the App package file is ready, you can upload it to File Exchange website to share with the public. To do it, follow the steps below:

1. Go to [File Exchange Website](#), click **Submit a file** on the bottom right to open **Submit File** page. Select **File Type** as **App** and fill in other needed information, **File Category**, **Created using Origin:**, etc. Note the information contained in the App package will be automatically extracted, such as, **Minimum Origin Version Required**, **Title**, **Summary**.
2. Upload the App OPX package file, screenshot image, click **Submit** button to submit your App and create a File Exchange tool page for it.
3. You can then download the OPX file from the web page you have created, and drag-and-drop onto Origin to test it. A package ID will be assigned to the opx during the download process.

4. You can continue editing the web page for your App. Once finished, you can click **Update** button to update the web page.
5. When you are ready to publish your App, press the **Request Approval** button on the bottom of **Update** form. You will be notified by OriginLab through email when your App has been approved. The approval status is also shown on the **Update File** page as indicated by **OriginLab Tested**, **OriginLab Approved** checkboxes.
6. Once your App got approved, it will be automatically shown on the **Tools: Apps on file Exchange** menu list.

#### 12.3.9.4.2 Modifying an App

##### Modify App Settings

1. Select **Tools: Package Manager** from Origin menu. Select **Tools: Browse Installed Package** in **Package Manager** dialog's menu. Select the App and click **Open** button.
2. You can change the settings in the dialog. If your files in the folder are modified, you can click **Repack Files** button.
3. Click **File: Save** to save the App OPX package.

##### Add, Remove or Change Files in App Folder

When you need to add files, remove files or change file names in App folder, you can perform these operations by right clicking on the App folder in the **Workspace** panel on **Code Builder** and selecting corresponding option from the shortcut menu. When done, click **Generate** from the shortcut menu to regenerate the App package.

Note that when removing files or changing file names, original files should be kept in the App folder under path `C:\Users\XXX\AppData\Local\OriginLab\Apps\` even if they are not being used, otherwise old settings in the opx will not be kept in **Package Manager** dialog when you click **Generate** button.

##### Upload Modified OPX to File Exchange Page

Log in Origin website, go to the File Exchange page you have created for your App and upload the updated OPX file to the File Exchange page. Update the web page as needed, including notes on what has been updated in current App version. Users would know this update from menu **Tools: Apps on File Exchange: \* YourApp (installed)** as indicated by the asterisk symbol \* if this App was previously installed.

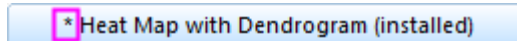

##### Request Approval from OriginLab

Click the **Request Approval** button in the File Exchange webpage of your App and wait for OriginLab to notify you.

## 12.4 X-Functions

### 12.4.1 X-Functions

- [Command Window and X-Functions](#)
- [Introduction to X-Functions](#)
- [How to Create a Wizard](#)

## 12.4.2 Command Window and X-Functions

### 12.4.2.1 Summary

Many of Origin's analysis tools and other data processing tools have been implemented using X-Functions. The Command Window provides a convenient way to run these functions.

Another important use for the Command Window is to send LabTalk script commands to Origin. Script commands can range from simple math and data operations, to user-created X-Functions or Origin C functions.

Minimum Origin Version Required: Origin 8.0 SR6

### 12.4.2.2 What you will learn

This tutorial will introduce you to the Command Window and show you how to:

- Perform simple calculation
- Access worksheet cells/columns
- Access X-Functions

### 12.4.2.3 Command Window

The Command Window consists of two panels: the **Command Panel** and **History Panel**:

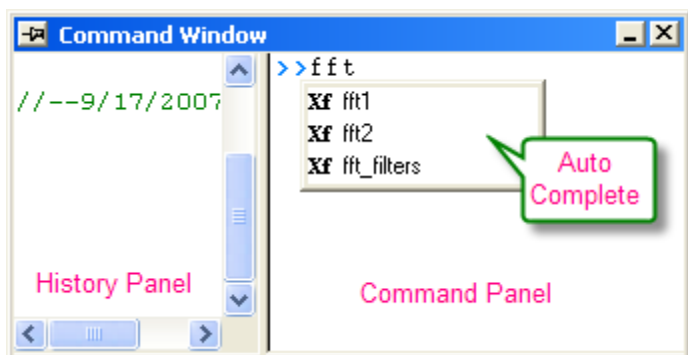

The Command Window is normally located at the bottom right corner of the screen, but if it is not visible, you can access it by pressing **Alt+3** or by selecting **View: Command Window**.

When typing in the Command Panel, the Auto Complete support allows you to choose among X-Function script commands and OGS files in the current working folder. The command and OGS file name will be respectively preceded by Xf and LT. You can move up and down the list using the arrow keys; pressing Enter selects the item. After your selection, press the space bar and the Auto Complete now shows you the available options for the command.

### 12.4.2.4 Examples

#### 12.4.2.4.1 Perform Calculations

The Command Window can be used as a calculator or to access any of Origin's mathematical functions. See the examples below.

#### Single Line



One of the more basic uses for the Command Window is as an interface to perform simple calculations. For example, type the following:

```
2+2=
```

Press **ENTER**. Origin returns

```
2+2=4
```

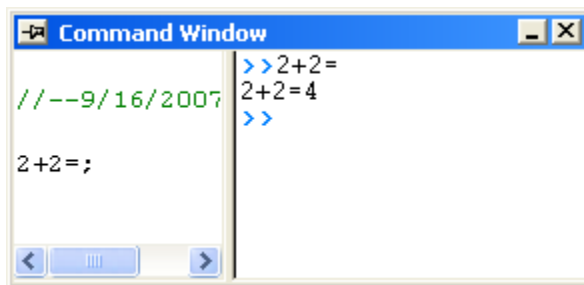

#### Multiple Lines

If you are typing multiple lines of scripts, first edit it in Code Builder (**View:Code Builder**) or any text editor, such as Windows Notepad, ending each line with a semi-colon, and then Copy + Paste the script in the Command Window, and press **ENTER** to execute. For example, paste the following script in the Command Window and **ENTER**:

```
sum = 0;  
  
loop(ii, 1, 10)  
{  
  
    sum += ii;  
  
}  
  
sum = ;
```

Origin returns:

```
SUM=55
```

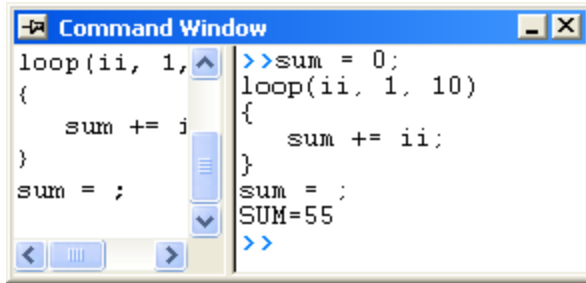

### Functions

Any mathematical function, built-in as well as user-created, can be executed from the Command Window. For example, type:

```
ln(10) =
```

Origin returns natural logarithm value of 10.

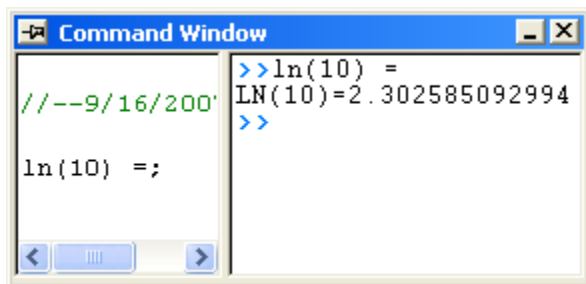

#### 12.4.2.4.2 Access Worksheet Values

You can also use the Script Window to read and write worksheet values, or to perform math operations on datasets.

1. Enter the following data into a fresh worksheet:

The screenshot shows a worksheet window titled 'Book1' with a table of data. The table has three columns: 'Long Name', 'A(X)', and 'B(Y)'. The data is as follows:

Long Name	A(X)	B(Y)
Units		
Comments		
1	1	6
2	2	7
3	3	8
4	4	9
5	5	10

2. To return the value in the first cell of the second column, type the following:

```
cell(1,2)=
```

3. Press **ENTER**. Origin returns:

```
CELL(1,2)=6
```

You can also use the column name and row number to reference cell values.

4. Type the following:

```
col(B)[1]=
```

5. Press **ENTER**. Origin returns:

```
COL(B)[1]=6
```

**Notes:** In addition to using the column name, you can also use the dataset name. In LabTalk, the syntax for naming datasets is *worksheetName\_columnName*. So, For example, *Book1\_A[1]=* would return the first element of column A in worksheet Data1. Also, if the worksheet that you are referencing is the active window, you can use the LabTalk string variable %H, in place of the worksheet name. For example, %H\_A[1].

To subtract the value in row 1 of column A, from all the values in column B...

6. Type the following:

```
col(B)=col(B)-col(A)[1]
```

7. Press **ENTER**. Your worksheet now reads:

	A(X)	B(Y)
Long Name		
Units		
Comments		
1	1	5
2	2	6
3	3	7
4	4	8
5	5	9

Let's use what we have learned about executing multiple lines of script in the Script window. We will multiply every value in a column of data by some constant  $b$ .

8. Type the following:

```
b=3;
```

Press **CTRL+ENTER**. Recall that this gives us a carriage return without executing the command.

9. Now type:

```
col(A)=col(A)*b;
```

Again, Press **CTRL+ENTER**.

10. Choose **Edit** from the Script window's menu bar. **Script Execution** should have a check mark next to it; if not, single-click on the menu item to place a check mark there.

11. Now, select the two lines of script that you just entered into the Script window and press **ENTER**.

Your worksheet now reads:

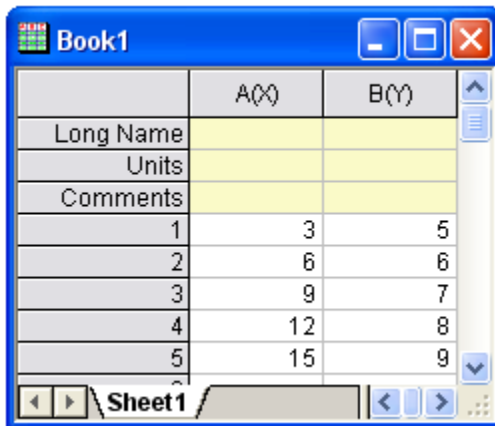

	A(X)	B(Y)
Long Name		
Units		
Comments		
1	3	5
2	6	6
3	9	7
4	12	8
5	15	9

**Notes:** The following C notation is also supported:

```
b=3;
```

```
col(A)*=b;
```

You can also use linear interpolation or extrapolation on a specified  $X$  dataset to find the corresponding

interpolated or extrapolated value in a *Y dataset*. This requires using a new notation with parentheses ( ) instead of brackets [ ].

In this example, `book1_b` is a *Y dataset* and (4) is a value in an *X dataset* (`book1_a`) for which you want to find a corresponding, interpolated *Y* value.

12. Type the following:

```
book1_b(4) =
```

13. Press **ENTER**. Origin returns:

```
BOOK1_B(4)=5.333333
```

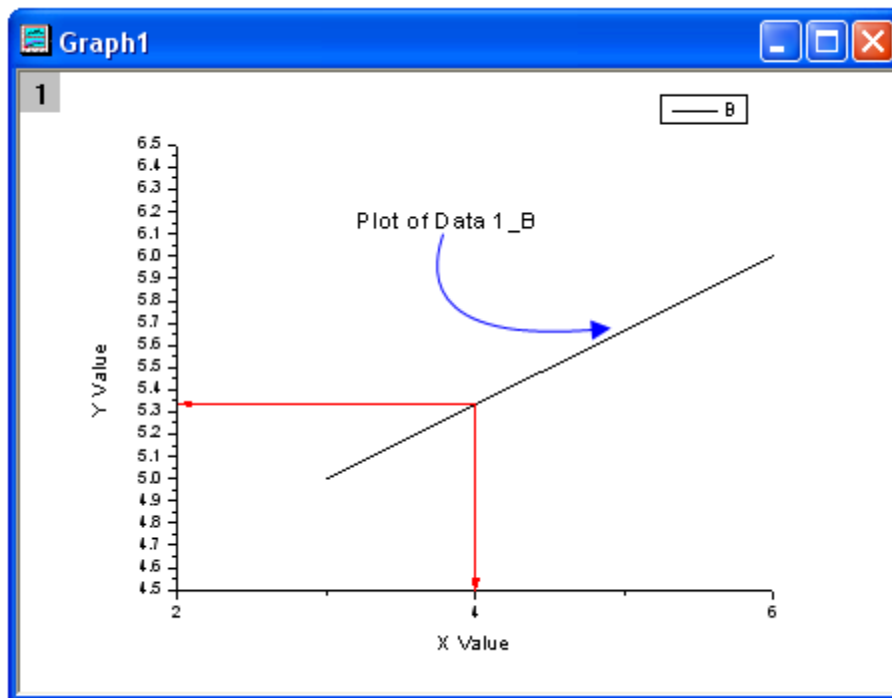

This is a line plot of our simple worksheet data. You can see that our interpolated *Y* value – the one corresponding to  $X = 4$  – is 5.333333.

14. If the columns you work with are in different worksheet/workbook, you should use the range variables to represent the worksheet columns. For example, this script calculates the sine value on `Book1` column `A`, and puts the result in `Book2` column `A` (You must have `Book2` before hitting Enter):

15.

```
range a = [Book1]Sheet1!Col(A);

range b = [Book2]Sheet1!Col(A);

b = sin(a);
```

The screenshot displays three windows from the Origin 8.5.1 software:

- Book1:** A data book with columns A(X) and B(Y). The data in column A is: 1, 2, 3, 4, 5, 6.
- Book2:** A data book with columns A(X) and B(Y). The data in column A is: 1, 2, 3, 4, 5, 6. The data in column B is: 0.84147, 0.9093, 0.14112, -0.7568, -0.95892.
- Command Window:** Shows the execution of the script:
 

```
//--9/16/2 >>range a = [Book1]Sheet1!Col(A);
range b = [Book2]Sheet1!Col(A);
b = sin(a);
>>
```

#### 12.4.2.4.3 Access X-Functions

Origin 8 provides a large collection of X-Functions for performing a wide variety of data processing tasks. Of this collection, many of the X-Functions are accessible from LabTalk script. The functions accessible from script provide a powerful environment for users to create custom script code for their routine tasks.

X-Functions that are accessible from script can be listed in the Command Window, and you can also obtain help on the command syntax as well as make use of auto completion of commands for such functions.

X-Functions accept data range string or range variable for specifying source and destination data for the operation. For example, the smooth X-Function under signal processing can be accessed from the Command Window as follows:

1. Import the file `\Samples\Signal Processing\Signal with Shot Noise.dat`.
2. In the Command Window, type the following:

```
smooth iy:=Col(2) method:=1 npts:=200
```

When you press **ENTER**, the result will append to the source worksheet.

The screenshot shows the Origin software interface. The main window is titled "SignalwithSho - Signal with Shot Noise.dat". It contains a worksheet with the following data:

	A(X)	B(Y)	C(Y)
Long Name	Time	Amplitude	Smoothed
Units	(sec)	(a.u.)	
Comments			200 pts SG
Sparklines			
1	0.01	1.011	0.85357
2	0.011	1.035	0.89124
3	0.012	1.059	0.92871
4	0.013	1.082	0.966
5	0.014	1.106	1.00309
6	0.015	1.13	1.03999

Below the worksheet is the "Command Window" showing the following command and its output:

```
>>smooth iy:=Col(2) method:=1 npts:=200
smooth.oy = [SignalwithSho]"Signal wit
>>
```

- For help in using this smooth X-Function, you can type

```
help smooth
```

to open the corresponding Help.

### 12.4.3 Introduction to X-Functions

#### 12.4.3.1 Summary

X-Functions provide a structured programming environment that offers a framework for building Origin tools. Different from the simple GetN box, creating tools by using X-Functions allows the user to focus on the actual data processing code and not have to worry about codes for the user interface.

Most of the dialogs/functions in Origin 8 are X-Functions, and many of them can be run from both menu and command line mode. The flexibility of running X-Functions makes them an attractive approach to customizing Origin

Minimum Origin Version Required: Origin 8.0 SR0

#### 12.4.3.2 What you will learn

- How to create an X-Function
- How to make the X-Function script accessible
- How to use the X-Function in dialog mode

#### 12.4.3.3 Create an X-Function

1. Select **Tools: X-Function Builder** or press **F10** to open the **X-Function Builder** dialog
2. Set **Name**, **Label** and **Data** of the 1st variable as **ix**, **Source** and **<active>**
3. Right click in the list panel and select **Add Variables** from the context menu.
4. Set **Name**, **Label**, **Input/Output** and **Data** of the 2nd variable as **ox**, **Destination**, **Output** and **<new>**
5. Select **File:Save** to save the x-function as vcopy

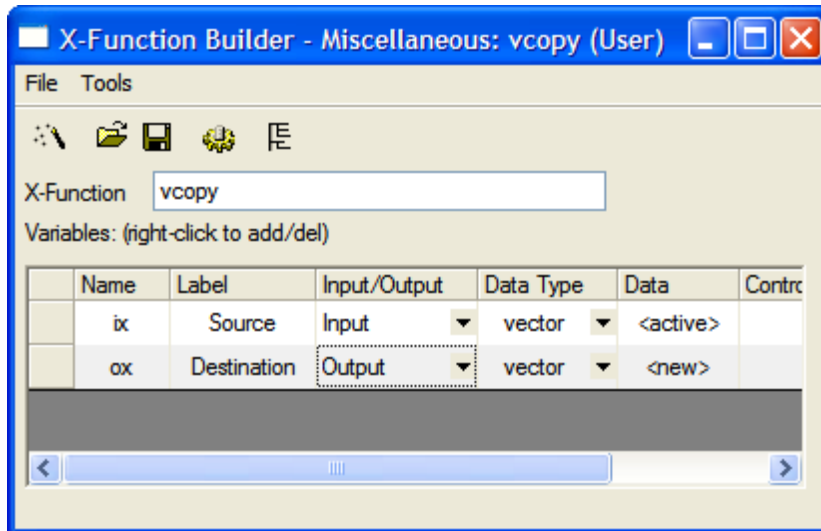

6. Click  to open **Code Builder**
7. Add the following codes in the vcopy function in code builder

```
void vcopy(const vector& ix, vector& ox)
{
```





```

if (!ix || !ox)
    XF_THROW(CER_NO_DATA);

ox = ix;
}

```

#### 12.4.3.4 Making the X-Function Script Accessible

1. Click the **Return to Dialog** button in **Code Builder**
2. In the **X-Function Builder**, save your changes 
3. Open the X-Function in **Tree View** by clicking 
4. Open the **Usage Context** branch. Make sure the **Labtalk** check box is selected

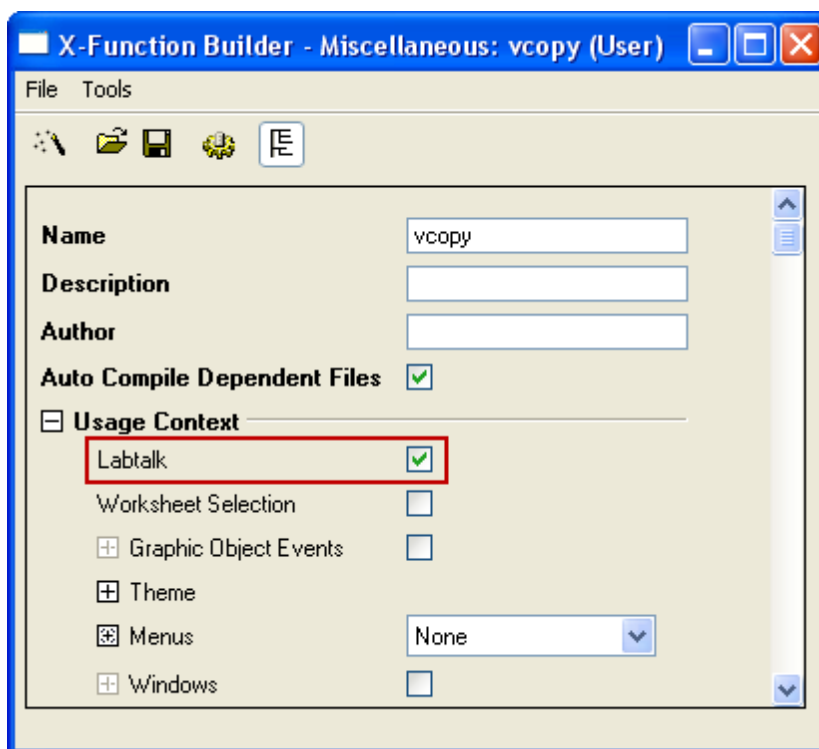

5. Save the x-function and close the **X-Function Dialog**
6. Fill column(A) with row numbersw in the active worksheet (Highlight column(A), right-click and select **Fill Column with: Row Numbers**)

7. Type the following script in the command window, Column(A) will be copied to Column(B)

```
vcopy col(a) col(b)
```

#### 12.4.3.5 Using the X-Function in Dialog Mode

1. Open the **X-Function Dialog** and open VCOPY.OXF in **Tree View**
2. Open the **Usage Context** branch
3. Open the **Menus** branch, make sure **Simple GetNBox** is selected from the **Auto GetN Dialog** list box

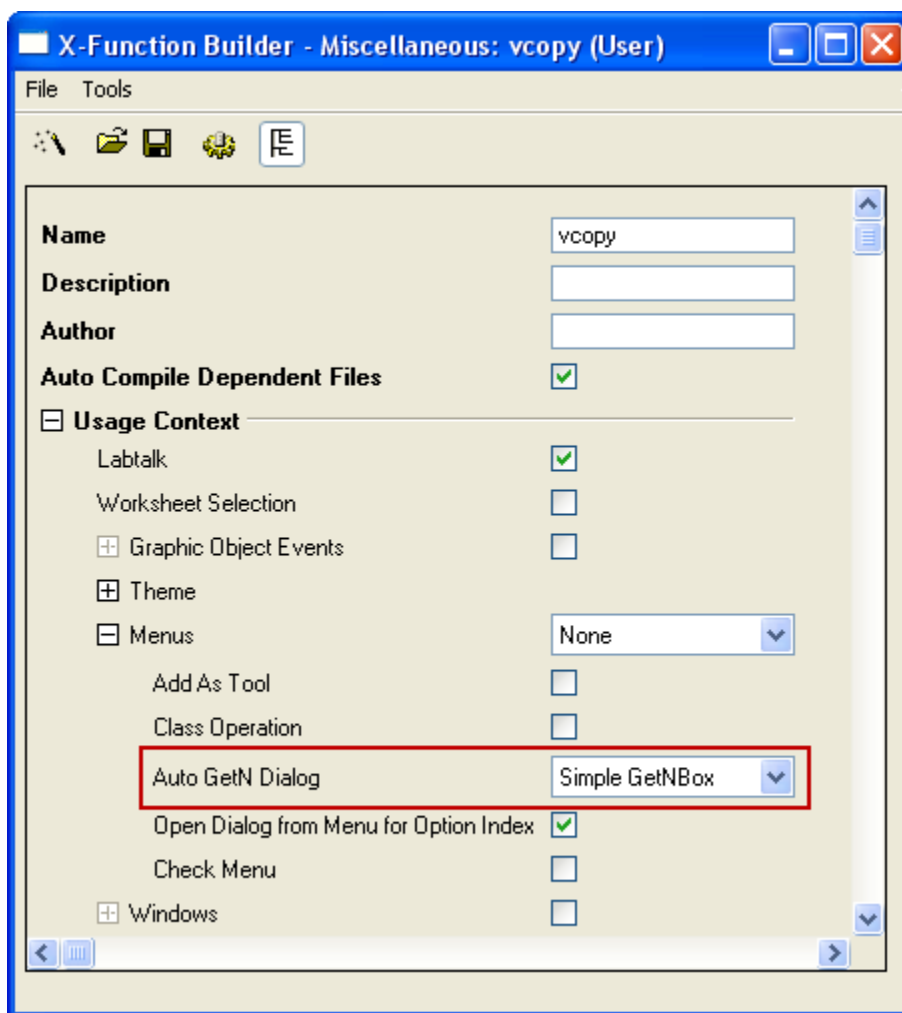

4. Save the x-function and close the **X-Function Dialog**
5. Type following script in the command window, Dialog of VCOPY.OXF will be opened

```
vcopy -d
```

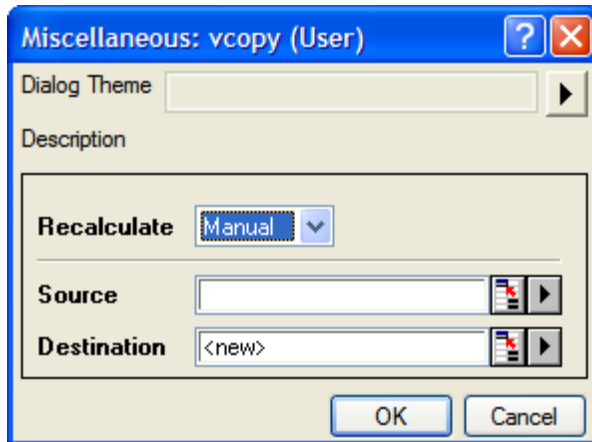

## 12.4.4 How to Create a Wizard

### 12.4.4.1 Summary

A wizard is a graphical user interface that includes a series of dialogs to direct a user to complete a mission step by step. A wizard makes a complex task easier to perform. Origin provides several classes in Origin C for users to develop a wizard. The dialog for each step in the wizard can be created using an X-Function.

In this example, the wizard will perform a normality test and then a one-sample t-test for data in a column. The normality test's result can be shared in one-sample t-test.

**Note:** This tutorial requires [the Develop Kit](#).

Minimum Origin Version Required: Origin 8.1SR0

### 12.4.4.2 What you will learn

- How to create an X-Function.
- How to share a variable or a DataRange in different steps.
- How to call an X-Function in OriginC.
- How to create a wizard.

### 12.4.4.3 Create four X-Functions

1. Select **Tools: X-Function Builder** or press **F10** to open **X-Function Builder dialog**

2. Add the variables as follows and save the X-Function as "StatTest" in the User Files folder, User Files\X-Functions\Statistics\Hypothesis Testing.

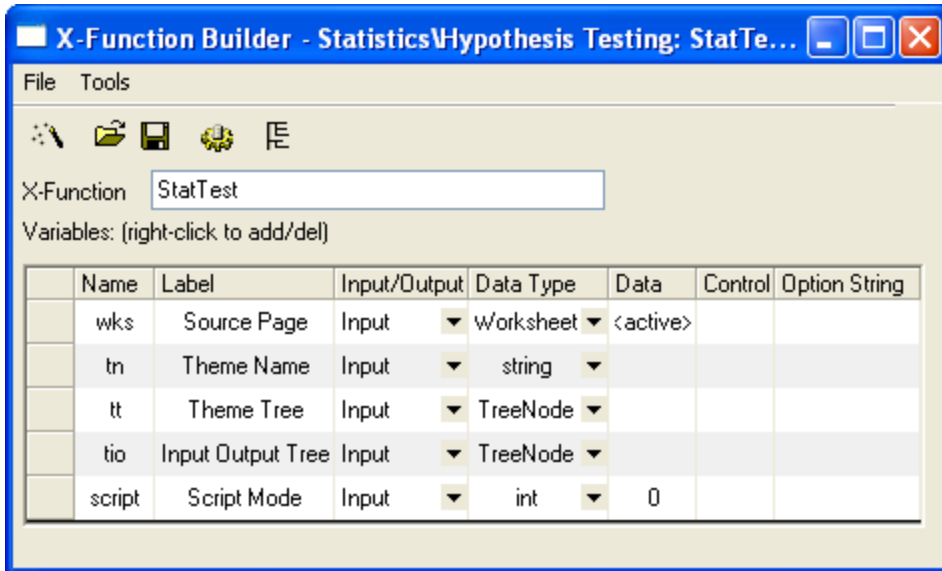

3. Click the **New X-Function Wizard** button. Add the variables as follows and save the X-Function as "StatTestWizGoal" in the User Files folder, User Files\X-Functions\Statistics\Hypothesis Testing.

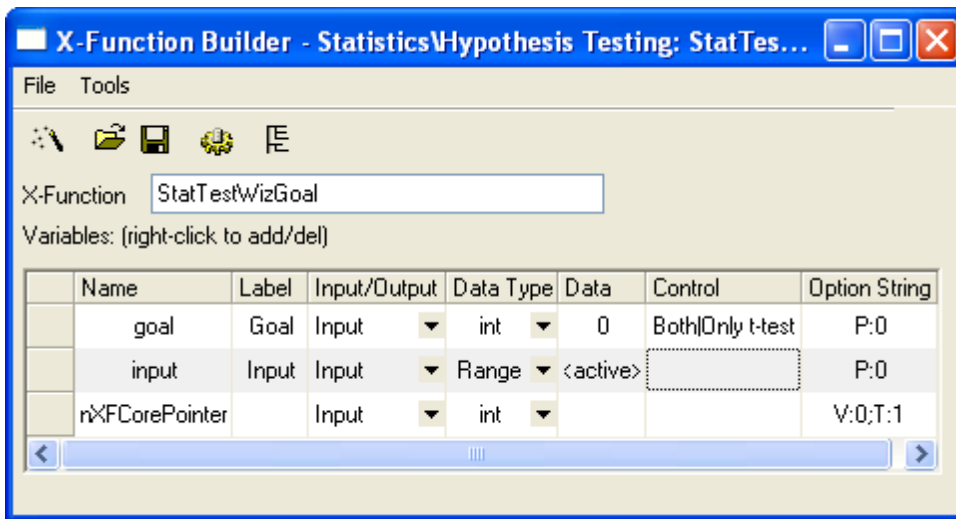

- Click the **New X-Function Wizard** button. Add the variables as follows and save the X-Function as "NormalityTest" in the User Files folder, User Files\X-Functions\Statistics\Hypothesis Testing.

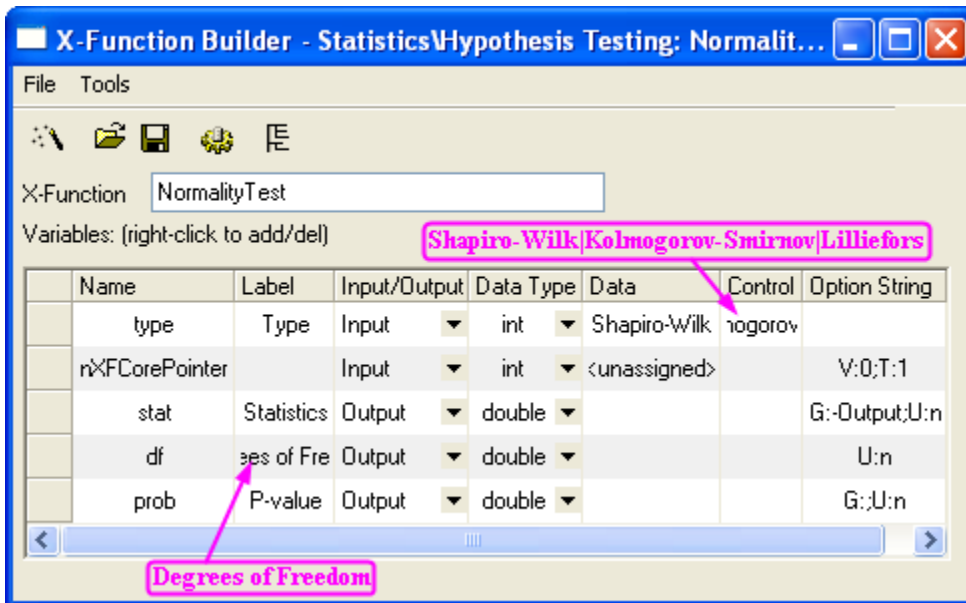

- Click the **New X-Function Wizard** button. Add the variables as follows and save the X-Function as "OnetTest" in the User Files folder, User Files\X-Functions\Statistics\Hypothesis Testing.

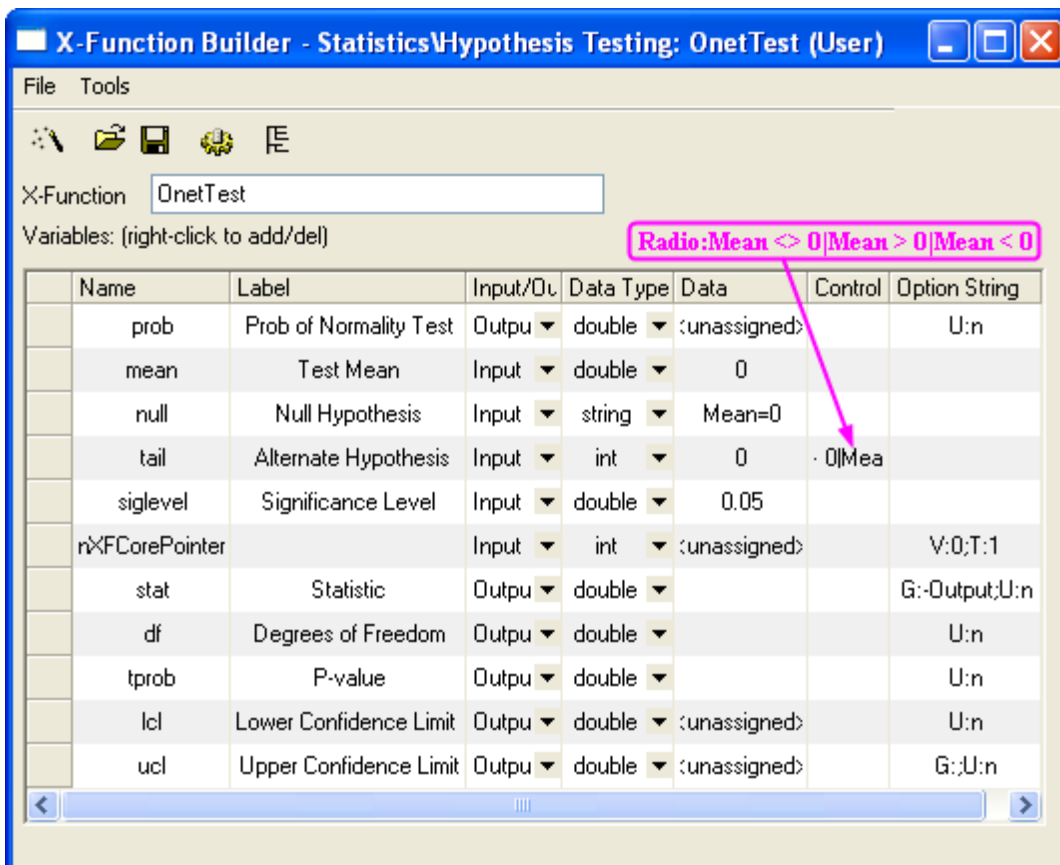

Note that the X-Functions **NormalityTest** and **OnetTest** have the same variable "prob", which is a shared variable and will be declared in the source file.

12.4.4.4 Update X-Function's Property in Tree View

1. Open the X-Function **StatTest**. Click the **TreeView** button  to open the Tree View. Make the following settings in the Tree View.

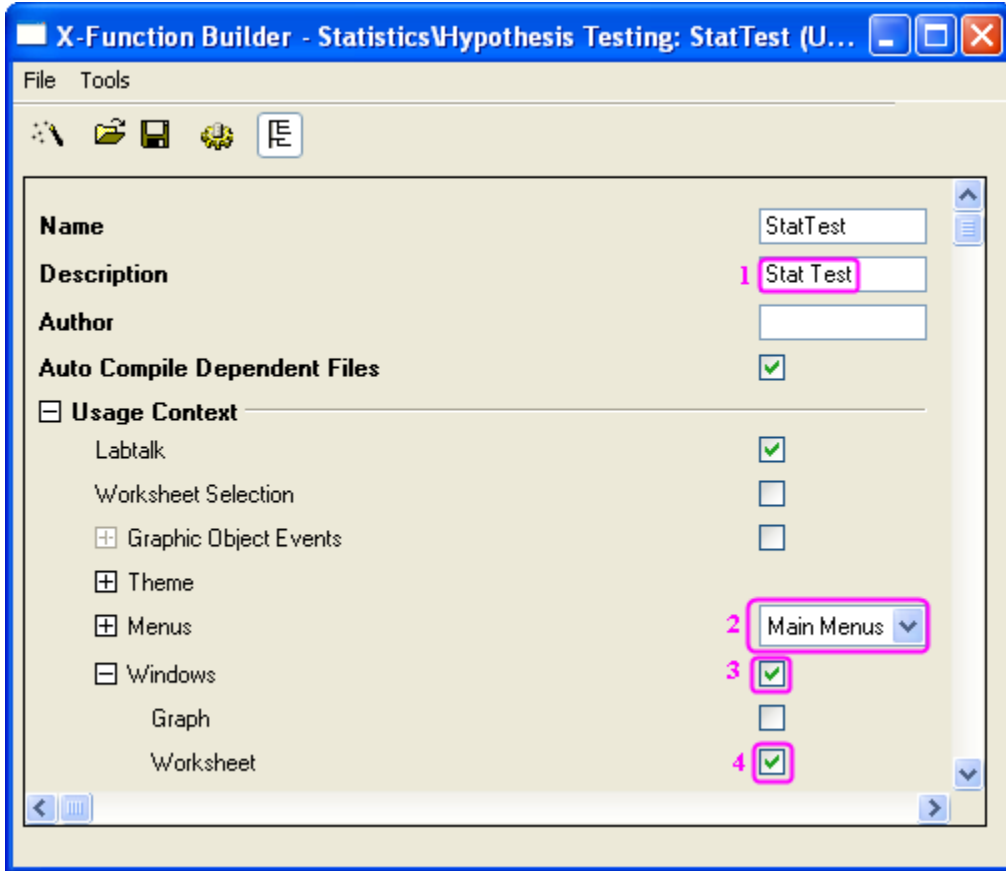

2. Click the **Save OXF file** button to save the X-Function.
3. Open the X-Function **StatTestWizGoal**, **NormalityTest** and **OnetTest** respectively in X-Function Builder.

Click the **TreeView** button  and type "Select Wizard Goal", "Normality Test" and "One-Sample t-test" in the **Description** edit box of each X-Function's Tree View, which will be shown in the dialogs.

12.4.4.5 Create Files for the Wizard

- Click the **Code Builder** button on the **Standard** toolbar. In Code Builder, click the **New** button. In the **New File** dialog, select **H File**, click the **Browse** button, and select the User Files folder, User Files\OriginC as the new header file's **Location**. Then type StatTestWiz in the **File Name** edit box. Click **OK** to close the dialog.

Add the following script to StatTestWiz.h file.

```

```

```
#ifndef __STAT_TEST_WIZ_H__

#define __STAT_TEST_WIZ_H__

#include <..\OriginLab\XFWiz.h>

#include <..\OriginLab\XFCore.h>

#include <..\OriginLab\XFWizard_utils.h>

class StatTestWizCore : public XFCore

{

public:

    StatTestWizCore();

public:

    void ChangeGoal(int nGoal);

    DataRange GetRange();

    int nStep;

protected:

};
```

## Tutorials for Origin

```
int stat_test_run_wiz_nodlg(LPCSTR lpszThemeName = NULL, const XFWizTheme
*pXFWizTheme

= NULL, const XFWizInputOutputRange *pXFWizIO = NULL, DWORD dwOPUID = 0);

int stat_test_open_wiz_dlg(LPCSTR lpszThemeName = NULL, const XFWizTheme
*pXFWizTheme

= NULL, const XFWizInputOutputRange *pXFWizIO = NULL, DWORD dwOPUID = 0);

#endif      //__STAT_TEST_WIZ_H__
```

Click the **Save** button to save StatTestWiz.h file.

- Repeat the same operation to create a new **C File**, StatTestWiz.c .

Add the following script to StatTestWiz.c file.

```
////////////////////////////////////

#include <..\OriginLab\XFWizManager.h>

#include <..\OriginLab\WizOperation.h>

#include <..\OriginLab\XFWizNavigation.h>

#include <..\OriginLab\XFWizScript.h>

#include <..\OriginLab\XFWizDlg.h>

////////////////////////////////////
```



```

// Include your own header files here.

#include "StatTestWiz.h"

enum

{

    GOAL_ALL = 0,

    GOAL_SIMPLE,

};

//Names of three X-Functions

#define STR_STEP_GOAL      "StatTestWizGoal"

#define STR_STEP_Normal   "NormalityTest"

#define STR_STEP_TTest    "OnetTest"

//Names of steps shown in the wizard.

#define STR_LABEL_STEP_GOAL      "Goal"

#define STR_LABEL_STEP_Normal    "Normality Test"

#define STR_LABEL_STEP_TTest     "One-Sample t-test"

////////////////////////////////////

//Class StatTestWizTheme

class StatTestWizTheme : public XFWizTheme

```

## Tutorials for Origin

```
{  
  
public:  
  
    StatTestWizTheme ();  
  
};  
  
//Name of the variable prob shared by X-Functions NormalityTest and OnetTest  
  
#define STR_GETN_VAR_SHARED_NProb "prob"  
  
StatTestWizTheme::StatTestWizTheme ()  
  
:XFWizTheme ()  
  
{  
  
    m_saSharedList.Add(STR_GETN_VAR_SHARED_NProb); //Add the shared variable  
  
}  
  
/////////////////////////////////////  
  
class StatTestWizInputOutputRange : public XFWizInputOutputRange  
  
{  
  
};  
  
/////////////////////////////////////  
  
//Class StatTestWizManager
```

```

#define STR_CLASS_NAME_TEST          "StatTestWiz"

#define TEST_VERSION_NUMBER          1.0

class StatTestWizManager : public XFWizManager
{
public:
    StatTestWizManager(LPCSTR lpkszThemeName = NULL, const XFWizTheme *pXFWizTheme
= NULL, const XFWizInputOutputRange *pXFWizIO = NULL, DWORD dwUIDOp = 0);

protected:
    virtual double GetVersion() { return TEST_VERSION_NUMBER; }

    virtual XFCore* CreateXFCore() { return new StatTestWizCore; }

    virtual XFWizTheme* CreateXFWizTheme() { return new StatTestWizTheme; }

    virtual XFWizInputOutputRange* CreateXFWizInputOutputRange()
    { return new StatTestWizInputOutputRange; }

    virtual string GetClassName() { return STR_CLASS_NAME_TEST; }
};

StatTestWizManager::StatTestWizManager(LPCSTR lpkszThemeName, const XFWizTheme
*pXFWizTheme, const XFWizInputOutputRange *pXFWizIO, DWORD dwUIDOp)
: XFWizManager(lpkszThemeName, pXFWizTheme, pXFWizIO, dwUIDOp)
{

```

## Tutorials for Origin

```
StringArray saMapXFNames = {STR_STEP_GOAL, STR_STEP_Normal, STR_STEP_TTest};

StringArray saMapXFLabels = {STR_LABEL_STEP_GOAL, STR_LABEL_STEP_Normal,

                              STR_LABEL_STEP_TTest};

m_saMapXFNames = saMapXFNames;

m_saMapXFLabels = saMapXFLabels;

ASSERT( m_saMapXFNames.GetSize() == m_saMapXFLabels.GetSize() );

StringArray saDefaultXFNames = {STR_STEP_GOAL, STR_STEP_Normal, STR_STEP_TTest};

m_saDefaultXFNames = saDefaultXFNames;

m_strRunDlgName = _L("Stat Test");

}

////////////////////////////////////

//Class StatTestWizCore

StatTestWizCore::StatTestWizCore()

:XFCore()

{

    StringArray vsXFsWithRecalculateShown = {STR_STEP_GOAL};

    m_vsXFsWithRecalculateShown = vsXFsWithRecalculateShown;

    nStep = GOAL_ALL;

}
```

```
}

//Select steps in the Goal Step

void StatTestWizCore::ChangeGoal(int nGoal)

{

    XFWizNavigation *pXFWizNavg = (XFWizNavigation *)GetXFWizNavigation();

    ASSERT(pXFWizNavg);

    nStep = nGoal;

    if ( pXFWizNavg )

    {

        StringArray saXFNames;

        saXFNames.Add(STR_STEP_GOAL);

        switch (nGoal)

        {

            case GOAL_ALL:

                saXFNames.Add(STR_STEP_Normal);

                saXFNames.Add(STR_STEP_TTest);

                break;

            case GOAL_SIMPLE:

                saXFNames.Add(STR_STEP_TTest);

        }

    }

}
```

```
        break;

    }

    pXFWizNavg->SetSteps(saXFNames);

}

}

//Get input DataRange in the Goal Step.

DataRange StatTestWizCore::GetRange()

{

    XFWizNavigation *pXFWizNavg = (XFWizNavigation*)GetXFWizNavigation();

    XFWizInputOutputRange* pIORange = pXFWizNavg->GetXFWizInputOutputRange();

    DataRange drInput;

    if(!pIORange)

    {

        error_report("Fail to get io ranges!");

        return drInput;

    }

    Array<DataRange&> drs;
```



```
int stat_test_open_wiz_dlg(LPCSTR lp.szThemeName, const XFWizTheme *pXFWizTheme,
const
XFWizInputOutputRange *pXFWizIO, DWORD dwOPUID)
{
    TEMPLATE_open_wiz_dlg(StatTestWizManager, lp.szThemeName, pXFWizTheme, pXFWizIO,
dwOPUID)
}

int stat_test_run_wiz(UINT msg, const XFWizTheme *pXFWizTheme, const
XFWizInputOutputRange *pXFWizIO, DWORD dwOPUID, int nExeMode)
{
    TEMPLATE_run_wiz(StatTestWizManager, msg, pXFWizTheme, pXFWizIO, dwOPUID,
nExeMode)
}
```

Click the **Save** button to save StatTestWiz.c file.

Note that StatTestWiz.c should be compiled after the X-Function **StatTest** is compiled, since the included files in StatTestWiz.c are not yet in the workspace until the X-Function **StatTest** is compiled. In fact StatTestWiz.h is included in X-Function **StatTest**, so StatTestWiz.c will be compiled automatically when X-Function **StatTest** is compiled.

#### 12.4.4.6 Add Script for X-Functions

##### 12.4.4.6.1 **Script for X-Function StatTest**

In the **X-Function Builder**, click the **Open** button and open the X-Function StatTest. Click the **Edit X-Function in Code Builder** and add the following script.

- Include header files

```
#include <..\OriginLab\XFWiz.h>
#include <..\OriginLab\WizOperation.h>
```



```

#include <..\OriginLab\XFCore.h>

#include <..\OriginLab\XFWizNavigation.h>

#include <..\OriginLab\XFWizManager.h>

#include <..\OriginLab\XFWizScript.h>

#include <..\OriginLab\XFWizDlg.h>

#include <..\OriginLab\XFWizard_utils.h>

#include <..\OriginLab\WksOperation.h>

#include <event_utils.h>

#include "StatTestWiz.h"

```

- StatTest()

Add the function body, which specifies the dialog mode.

```

if( script )

    stat_test_run_wiz_nodlg(tn);

else

    stat_test_open_wiz_dlg(tn);

```

- StatTest\_before\_execute()

Add the function body, which determines not to show this dialog before the wizard is opened.

```
nRet = XFEVT_PROCEED_NO_DLG;
```

Click **Compile** button to compile the file. Then click **Return to Dialog** button to return to **X-Function Builder**. In the **X-Function Builder**, click **Save OXF file** button to save the X-Function.

#### 12.4.4.6.2 Script for X-Function StatTestWizGoal

Open the X-Function StatTestWizGoal. Click **Edit X-Function in Code Builder** button, add the following script.

- Include header files

```
#include "StatTestWiz.h"
```

- Add a static function `_check_input()`

This function is used to check whether the input DataRange is a single column.

```
static bool _check_input(const TreeNode trGetN, string& strErr)
{
    TreeNode trRange = trGetN.input;

    DataRange drInput;

    drInput.Create(trRange.strVal);

    if( drInput.GetNumRanges() == 0 )
    {
        strErr = "Input can't be empty, and it should be a valid column.";

        return false;
    }
}
```

```

}

else

{

    if( drInput.GetNumRanges() == 1)

    {

        Worksheet wksInput;

        int nC1, nC2;

        drInput.GetRange(wksInput, nC1, nC2);

        if( nC1 == nC2 )

            return true;

    }

    strErr = "Please select one column.";

    return false;

}
}

```

- StatTestWizGoal\_event1()

Add the function body, which updates the dialog.

```

StatTestWizCore* pstatwc = (StatTestWizCore*)get_xf_core_handler(trGetN);

ASSERT(pstatwc);

```

```
//Update the Wizard page.  
  
if ( 0 == lstrcmp(lpcszNodeName, "goal" )  
  
    pstatwc->ChangeGoal(trGetN.goal.nVal);  
  
  
//Error message is shown at the bottom of the dialog,  
  
//and OK button is disabled for incorrect choice of DataRange.  
  
bOKEnable = _check_input(trGetN, strErrMsg);  
  
  
return false;
```

Click **Compile** button to compile the file. Then click **Return to Dialog** button to return to **X-Function Builder**, and click **Save OXF file** button to save the X-Function.

#### 12.4.4.6.3 Script for X-Function NormalityTest

Open the X-Function **NormalityTest**. Click the **Edit X-Function in Code Builder** button and add the following script.

- Include header files

```
#include "StatTestWiz.h"  
  
  
#include <XFbase.h>
```

- Add a static function `_update_GUI()`

This function is used to update the dialog's edit boxes for normality test result.

```
static void _update_GUI(TreeNode& trGetN)
```

```

{

vector vRes;

vRes = _norm_test(trGetN.nXFCorePointer.nVal, trGetN.type.nVal);

trGetN.stat.dVal = vRes[0];

trGetN.df.dVal = vRes[1];

trGetN.prob.dVal = vRes[2];

}

```

- Add a static function `_update_strErr()`

This function is used to update the string shown at the bottom of the dialog.

```

static void _update_strErr(const TreeNode tr, string& strErr)
{

if(tr.prob.dVal >= 0.05 && tr.prob.dVal <= 1)

    strErr = "At the 0.05 level, the data was significantly drawn from a

        normally distributed population.";

else if(tr.prob.dVal < 0.05 && tr.prob.dVal >= 0)

    strErr = "At the 0.05 level, the data was not significantly drawn from a

        normally distributed population.";

else

    strErr = "There is not enough information to draw a conclusion.";

}

```

Note that the string is divided into two lines shown in the page. It should be a command of one line in the script.

- Add a static function `_norm_test()`

This function is used to perform Normality Test using related X-Functions.

```
static vector _norm_test(const int nXFCorePointer, const int nType)

{

    StatTestWizCore* pstatwc =
(StatTestWizCore*)get_xf_core_handler(nXFCorePointer);

    ASSERT(pstatwc);

    vector vRes(3);

    vRes[2] = -1;

    DataRange drInput;

    drInput = pstatwc->GetRange();

    if( !drInput )

        return vRes;

    vector<string> vsXFName = {"swtest", "kstest", "lillietest"};

    XFBase xfNorm(vsXFName[nType]);

    if( !xfNorm.SetArg("irng", drInput) )

    {

        error_report("Failed to set argument image type");

    }

}
```

```
    return vRes;

}

if( !xfNorm.SetArg("stat", vRes[0]) )

{

    error_report("Failed to set argument image type");

    return vRes;

}

if( !xfNorm.SetArg("df", vRes[1]) )

{

    error_report("Failed to set argument image type");

    return vRes;

}

if( !xfNorm.SetArg("prob", vRes[2]) )

{

    error_report("Failed to set argument image type");

    return vRes;

}

if( !xfNorm.Evaluate() )

{

    error_report("Failed to evaluate the stats X-Function.");

    return vRes;

}
```

```
    }  
  
    return vRes;  
}
```

- NormalityTest()

Update the function body, which exports the result into a worksheet when the **Next** button is pressed.

```
    DataRange drInput;  
  
    StatTestWizCore* pstatwc =  
(StatTestWizCore*)get_xf_core_handler(nXFCorePointer);  
  
    ASSERT(pstatwc);  
  
    drInput = pstatwc->GetRange();  
  
    if( !drInput )  
        return;  
  
    string strBook, strSheet;  
  
    if(!drInput.GetBookSheet(strBook, strSheet))  
{  
        error_report("Workbook and worksheet names can't be obtained.");  
        return;  
    }  
  
    WorksheetPage wpData(strBook);
```



```
int nLayer = wpData.AddLayer("Normality Test");

if(nLayer >= 0)

{

    Worksheet wksRes = wpData.Layers(nLayer);

    vector<string> vsTypeName = {"Shapiro-Wilk", "Kolmogorov-
Smirnov", "Lilliefors"};

    vector<string> vsNProb = {"Prob<W", "Prob>D", "Prob>D"};

    vector<string> vsParaName = {"Statistic", "DF", ""};

    vsParaName[2] = vsNProb[type];

    vector vRes;

    vRes = _norm_test(nXFCorePointer, type);

    wksRes.Columns(1).SetLongName(vsTypeName[type]);

    for(int ii=0; ii<3; ii++)

    {

        wksRes.SetCell(ii, 0, vsParaName[ii], false);

        wksRes.SetCell(ii, 1, vRes[ii]);

    }

}
```

```
else  
  
{  
  
    error_report("New worksheet can't be created.");  
  
}
```

- NormalityTest\_event1()

Update the function body, which will update the results in the dialog as the method of normality test changes. Strings shown at the bottom of the dialog will also be updated.

```
_update_GUI(trGetN);  
  
_update_strErr(trGetN, strErrMsg);  
  
  
return true;
```

- NormalityTest\_before\_execute()

Update the function body, which will make the edit boxes for results grayed out, and show the result in the dialog.

```
trGetN.stat.Enable = false;  
  
trGetN.df.Enable = false;  
  
trGetN.prob.Enable = false;
```

Click the **Compile** button to compile the file. Then click the **Return to Dialog** button to return to **X-Function Builder**, and click the **Save OXF file** button to save the X-Function.

#### 12.4.4.6.4 Script for X-Function OnetTest

Open the X-Function **OnetTest**. Click the **Edit X-Function in Code Builder** button and add the following script.

- Include header files

```
#include "StatTestWiz.h"
```

```
#include <XFbase.h>
```

- Define strings

```
const vector<string> vsNull = {"Mean = ", "Mean <= ", "Mean >= "};

const vector<string> vsAlter = {"Mean <> ", "Mean > ", "Mean < "};

const vector<string> vsAcceptNull = {"Not significantly different from", "Not
significantly greater than", "Not significantly less than"};

const vector<string> vsRejectNull = {"significantly different from", "significantly
greater than", "significantly less than"};

const vector<string> vsProb = {"Prob>|t|", "Prob>t", "Prob<t"};
```

- Add a static function `_update_null()`

This function is used to update the **Null** edit box.

```
static void _update_null(TreeNode& trGetN, bool bMean = false)
{
    string strNull;

    strNull = vsNull[trGetN.tail.nVal] + ftoa(trGetN.mean.dVal);

    trGetN.null.strVal = strNull;
```

```
if (bMean)

{

    string strAlter = vsAlter[0] + ftoa(trGetN.mean.dVal) + "|";

    strAlter = strAlter + vsAlter[1] + ftoa(trGetN.mean.dVal) + "|";

    strAlter = strAlter + vsAlter[1] + ftoa(trGetN.mean.dVal);

    trGetN.tail.SetAttribute(STR_COMBO_ATTRIB, strAlter);

}

}
```

- Add a static function `_check_sig_level()`

This function is used to check the **Significance Level** edit box value.

```
static bool _check_sig_level(TreeNode& trGetN, string& strErr)

{

    if( trGetN.siglevel.dVal > 0 && trGetN.siglevel.dVal < 1 )

    {

        return true;

    }

    else

    {

        strErr = "Significance Level should be between 0 and 1.";

        return false;

    }

}
```

```

    }
}

```

- Add a static function `_update_strErr()`

This function is used to define the string for the conclusion of t-test at the bottom based on P-value.

```

static void _update_strErr(const TreeNode tr, string& strErr)
{
    if(tr.tprob.dVal >= tr.siglevel.dVal && tr.tprob.dVal <= 1)

        strErr.Format("Null Hypothesis is %s%s.\r\nAlternative Hypothesis is %s%s.

        At the %s level, the population mean is %s the test mean(%s).",

        vsNull[tr.tail.nVal], ftoa(tr.mean.dVal), vsAlter[tr.tail.nVal],
ftoa(tr.mean.dVal),

        ftoa(tr.siglevel.dVal), vsAcceptNull[tr.tail.nVal], ftoa(tr.mean.dVal) );

    else if(tr.tprob.dVal < tr.siglevel.dVal && tr.tprob.dVal >= 0)

        strErr.Format("Null Hypothesis is %s%s.\r\nAlternative Hypothesis is %s%s.

        At the %s level, the population mean is %s the test mean(%s).",

        vsNull[tr.tail.nVal], ftoa(tr.mean.dVal), vsAlter[tr.tail.nVal],
ftoa(tr.mean.dVal),

        ftoa(tr.siglevel.dVal), vsRejectNull[tr.tail.nVal], ftoa(tr.mean.dVal) );

    else

        strErr = "There is not enough information to draw a conclusion.";
}

```

Note that the command is divided into several lines shown in the page. It should be a command of one line in the script.

## Tutorials for Origin

- Add a static function `_update_GUI()`

This function is used to update edit boxes for results in the dialog.

```
static void _update_GUI(TreeNode& trGetN)

{

    vector vRes;

    vRes = _one_sample_t_test(trGetN.nXFCorePointer.nVal, trGetN.mean.dVal,
trGetN.tail.dVal, trGetN.siglevel.dVal);

    trGetN.stat.dVal = vRes[0];

    trGetN.df.dVal = vRes[1];

    trGetN.tprob.dVal = vRes[2];

    trGetN.lcl.dVal = vRes[4];

    trGetN.ucl.dVal = vRes[5];

}
```

- Add a static function `_one_sample_t_test()`

This function is used to perform One-Sample t-Test using an X-Function.

```
static vector _one_sample_t_test(const int nXFCorePointer, const double dMean,
const int nTail, const double dSiglevel)

{

    DataRange drInput;

    StatTestWizCore* pstatwc =
(StatTestWizCore*)get_xf_core_handler(nXFCorePointer);
```

```
ASSERT(pstatwc);

vector vRes(6);

vRes[2] = -1;

drInput = pstatwc->GetRange();

if( !drInput )

    return vRes;

vRes[3] = 100 - 100*dSiglevel;

XFBase xfTTest("ttest1");

if( !xfTTest.SetArg("irng", drInput) )

{

    error_report("Failed to set argument irng");

    return vRes;

}

if( !xfTTest.SetArg("mean", dMean) )

{

    error_report("Failed to set argument mean");

    return vRes;

}

if( !xfTTest.SetArg("tail", nTail) )
```

```
{  
  
    error_report("Failed to set argument tail");  
  
    return vRes;  
  
}  
  
if( !xfTTest.SetArg("alpha", dSiglevel) )  
  
{  
  
    error_report("Failed to set argument alpha");  
  
    return vRes;  
  
}  
  
if( !xfTTest.SetArg("stat", vRes[0]) )  
  
{  
  
    error_report("Failed to set argument stat");  
  
    return vRes;  
  
}  
  
if( !xfTTest.SetArg("df", vRes[1]) )  
  
{  
  
    error_report("Failed to set argument df");  
  
    return vRes;  
  
}  
  
if( !xfTTest.SetArg("prob", vRes[2]) )  
  
{
```



```
error_report("Failed to set argument prob");

return vRes;

}

if( !xfTTest.SetArg("lcl", vRes[4]) )

{

error_report("Failed to set argument lcl");

return vRes;

}

if( !xfTTest.SetArg("ucl", vRes[5]) )

{

error_report("Failed to set argument ucl");

return vRes;

}

if( !xfTTest.Evaluate() )

{

error_report("Failed to evaluate the ttest1 X-Function.");

return vRes;

}

return vRes;

}
```

- OnetTest()

Update the function body, which exports the result into a worksheet when the **Finish** button is pressed.

```
DataRange drInput;

StatTestWizCore* pstatwc =
(StatTestWizCore*)get_xf_core_handler(nXFCorePointer);

ASSERT(pstatwc);

drInput = pstatwc->GetRange();

if( !drInput )

    return ;

string strBook, strSheet;

if(!drInput.GetBookSheet(strBook, strSheet))

{

    error_report("Workbook and worksheet names can't be obtained.");

    return;

}

WorksheetPage wpData(strBook);

int nLayer = wpData.AddLayer("One-Sample t-test");
```

```

if(nLayer >= 0)

{

    Worksheet wksRes = wpData.Layers(nLayer);

    vector<string> vsParaName = {"t Statistic", "DF", "", "Conf. Levels in %",
"Lower Limits", "Lower Limits"};

    vsParaName[2] = vsProb[tail];

    vector vRes;

    vRes = _one_sample_t_test(nXFCorePointer, mean, tail, siglevel);

    wksRes.SetSize(-1, 4);

    wksRes.Columns(0).SetLongName("Test Statistics");

    string strNull = "Null Hypothesis is " + vsNull[tail] + ftoa(mean);

    wksRes.Columns(1).SetLongName(strNull);

    wksRes.Columns(3).SetLongName("Confidence Intervals for Mean");

    for(int ii=0; ii<3; ii++)

    {

        wksRes.SetCell(ii, 0, vsParaName[ii], false);

        wksRes.SetCell(ii, 1, vRes[ii]);

        wksRes.SetCell(ii, 2, vsParaName[ii + 3], false);

```

```

        wksRes.SetCell(ii, 3, vRes[ii + 3]);

    }

}

else

{

    error_report("New worksheet can't be created.");

}

```

- OnetTest\_event1()

Update the function body, which will update results and show a conclusion at the bottom of the dialog according to the result. As settings change in the dialog, the **Null** edit box will be updated as the mean and hypothesis change, and the **Significance Level** edit box's value is checked.

```

if( 0 == lstrcmp(lpkszNodeName, "mean") )

    _update_null(trGetN, true);

if( 0 == lstrcmp(lpkszNodeName, "tail") )

    _update_null(trGetN);

if( 0 == lstrcmp(lpkszNodeName, "siglevel") )

    bOKEnable = _check_sig_level(trGetN, strErrMsg);

_update_GUI(trGetN);

_update_strErr(trGetN, strErrMsg);

return false;

```

- OnetTest\_before\_execute()

Update the function body, to show/hide or disable the controls in the dialog.

```

StatTestWizCore* pstatwc =
(StatTestWizCore*)get_xf_core_handler(trGetN.nXFCorePointer.nVal);

ASSERT(pstatwc);

trGetN.prob.Show = 1 - pstatwc->nStep;

trGetN.prob.Enable = false;

trGetN.null.Enable = false;

trGetN.stat.Enable = false;

trGetN.df.Enable = false;

trGetN.tprob.Enable = false;

trGetN.lcl.Enable = false;

trGetN.ucl.Enable = false;

```

Click the **Compile** button to compile the file. Then click the **Return to Dialog** button to return to the X-Function Builder. Click the **Save OXF file** button to save the X-Function.

Close Origin. Then start Origin and you will notice that a new item **Stat Test** is added to Origin's menu **Statistics: Hypothesis Testing**.

#### 12.4.4.7 How to Use the Wizard

The following example shows how to use the wizard.

1. Select a column in the worksheet.

2. Select **Statistics: Hypothesis Testing: Stat Test** from the Origin menu or type the command "StatTest -d" in the command window. The **Stat Test** wizard dialog will open.

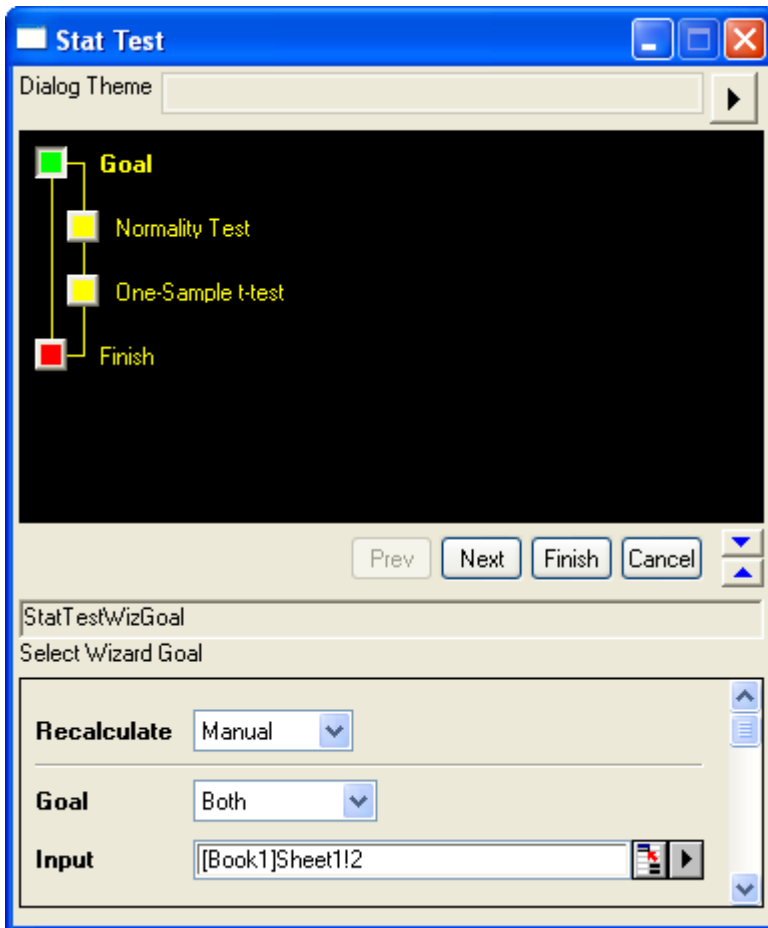

3. Click the **Next** button. The **Normality Test** dialog is opened. The result is shown in the **Output** branch. A conclusion is drawn at the bottom of the dialog.

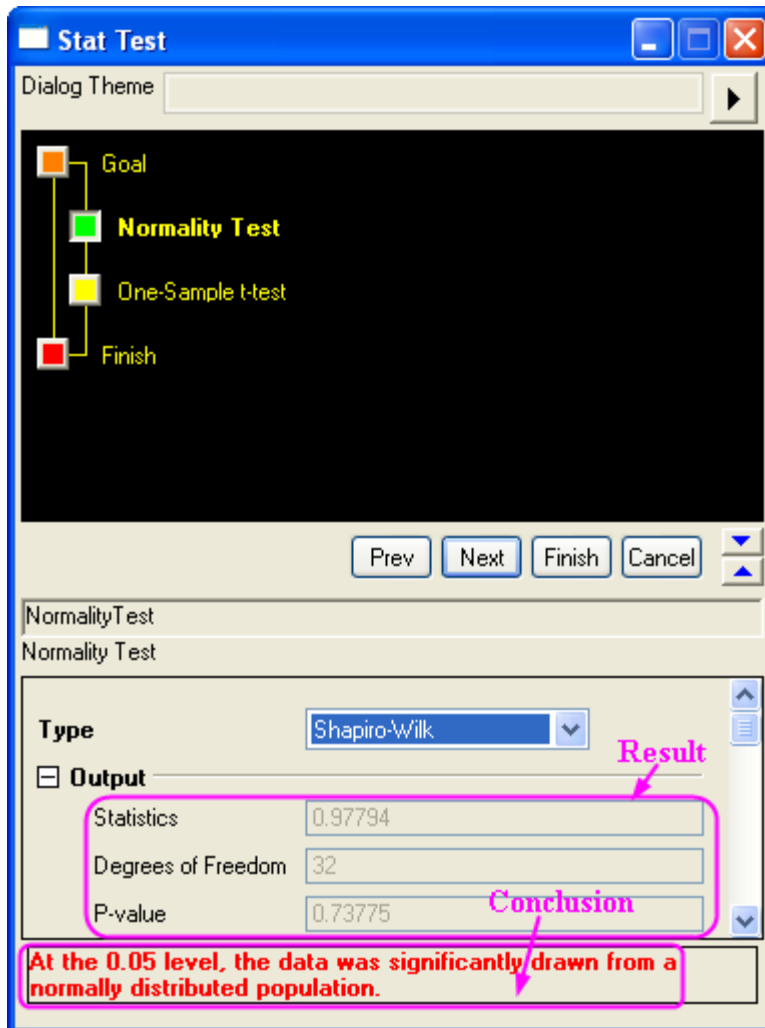

4. Click the **Next** button. The **One-Sample t-test** dialog is opened. The result is shown in the **Output** branch. A conclusion is drawn at the bottom of the dialog. Previous step's result of normality test is shown at the top. You can also change the setting in the dialog, and notice the result changes.

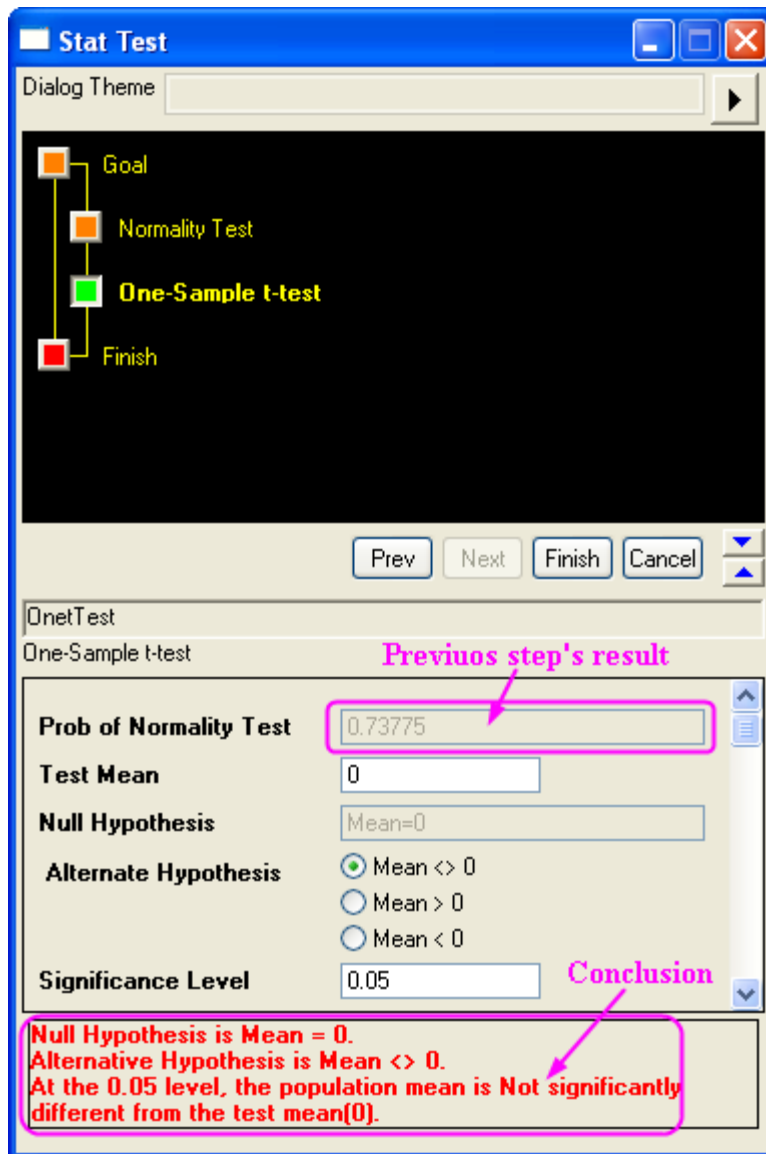



The screenshot shows a software window titled "Stat Test" with a "Dialog Theme" dropdown. A progress indicator on the left shows four steps: "Goal", "Normality Test", "One-Sample t-test" (highlighted in green), and "Finish". Below the progress indicator are "Prev", "Next", "Finish", and "Cancel" buttons. The main area displays "OnetTest" and "One-Sample t-test". A pink arrow labeled "Result" points to the "Statistic" field in the "Output" section, which contains the value -1.50326. Other output fields include "Degrees of Freedom" (31), "P-value" (0.14289), "Lower Confidence Limit" (-0.6201), and "Upper Confidence Limit" (0.09386). A red text box at the bottom provides the following summary:

**Null Hypothesis is Mean = 0.  
Alternative Hypothesis is Mean <> 0.  
At the 0.05 level, the population mean is Not significantly different from the test mean(0).**

Field	Value
Statistic	-1.50326
Degrees of Freedom	31
P-value	0.14289
Lower Confidence Limit	-0.6201
Upper Confidence Limit	0.09386

- Click the **Finish** button to end the wizard. Two worksheets for results are created.

	A(X)	B(Y)
Long Name	Shapiro-Wilk	
Units		
Comments		
1	Statistic	0.97794
2	DF	32
3	Prob<W	0.73775

	A(X)	B(Y)	C(Y)	D(Y)
Long Name	Test Statisti	Null Hypoth		Confidence
Units				
Comments				
1	t Statistic	-1.50326	Conf. Levels in %	95
2	DF	31	Lower Limits	-0.6201
3	Prob> t	0.14289	Lower Limits	0.09386

# Index

2	
2D Binning .....	605
2D FFT and Filter.....	380
2D Pie Chart of a Population Study .....	1025
2D Vector Graph .....	1778
2D Waterfall .....	1785
3	
3D and Contour .....	18
3D Bar and Symbol .....	1578
3D Bar on Flatten Surface .....	1693
3D Bar with Labels .....	743
3D Graphs.....	1565
3D Pie Chart.....	1566
3D Scatter Plot with Line Projections of Core Drilling Locations.....	1573
3D Scatter with Colormap .....	1665
3D Scatter with Droplines.....	1674
3D Surface with Point Label.....	1701
3D Ternary Colormap Surface with Contour Lines Projection.....	1752
3D Vector.....	1569
3D Waterfall .....	1794
3Ys Y-YY .....	1114
A	
Accessing Internal Origin Objects by Origin C ...	2035
Add multiple fitted curves in a Histogram .....	1434
Adding a Data Plot to Existing Graph .....	793
Adding and Arranging Layers .....	886
Adding New Origin C Functions to Origin .....	2016
Adding Objects to Worksheet.....	1815
Analysis Template .....	31
Analysis Templates.....	550
Analysis Themes .....	562
ANOVA.....	631
Apps in Origin.....	33
ASCII .....	1837
Axis .....	844
B	
Bar and Scatter Plot with Error Bar .....	1044
Bar Graph of African Population .....	1030
Basic 2D Plotting .....	773
Basic 3D Plotting .....	779
Batch Peak Analysis Using Theme with Script Before Each Process .....	449
Batch Processing .....	566
Batch Processing Grouped Datasets Using Analysis Template with Multi-Data Sheets .....	579
Batch Processing Multiple Datasets using Analysis Template .....	566
Batch Processing Multiple Files using Analysis Template .....	568
Batch Processing with Summary Report in External Excel File .....	572
Batch Processing with Word Template for Reporting.....	573
Box Plot.....	1255
C	
Categorical Values Ordering and Sharing .....	544
Cluster Analysis.....	701
Cluster Gadget .....	82
Clustered-Stacked Column Chart .....	1062
Coherence and Correlation.....	409
Collaboration and Connectivity .....	1975
Color Map Surface Graph .....	1629
Colormap from Second Matrix .....	1621
Column Graph with Error Bars .....	1049
Column, Bar and Pie .....	1024
Combine Quick Peaks Gadget with Peak Analyzer	453
Combining Line and Contour Plots.....	1203
Command Window and X-Functions .....	2044
Compare Graphs Dynamically by Changing Data Filters.....	871
Complicated Fill Area.....	921
Connectivity .....	1975

Contour .....	1175	Distribution Fit .....	611
Contour Graph with XY Data Points and Z Labels	1211	Distribution Fit with the Probability Density Function and Cumulative Distribution Function..	282
Contour Plot with Vector Overlay.....	1216	Double Y.....	1106
Contour Plots and Color Mapping.....	1185	<b>E</b>	
Convert Data from Spherical Coordinate to XYZ and Make a 3D Plot.....	1721	Energy-Level Structure of the Er <sup>3+</sup> Ion in A YAG Crystal .....	1148
Convolution .....	388	Enhanced Digitizer .....	1941
Copy and Apply a Plot Format to Another Plot.....	920	Error Bars with Fill Area.....	800
COX Model Estimator .....	685	Excel.....	1975
Create an 8 layer multi-panel plot template.....	1158	Exporting.....	1959
Create and Subtract Baseline with Peak Analyzer	439	Exporting and Presentation .....	1959
Create and Update Apps for Origin .....	2038	Exporting Graphs.....	1959
Create Heat Map with Virtual Matrix and Colormap Bar Plot.....	1231	<b>F</b>	
Creating a Custom Report Sheet .....	557	FFT and IFFT .....	348
Creating a Graph.....	751	FFT Filter .....	354
Creating Analysis Templates using Set Column Value .....	553	Fill Partial Area between Curves.....	929
Creating and Using Analysis Templates .....	550	Fit Curve Through Certain Points .....	275
Creating Intersecting Surface Plots from Worksheets .....	1599	Fit Function with Non-constant Background.....	266
Cross Tabulation .....	597	Fit Multiple Datasets by Fitting One and then Using Those Fit Parameters for Other Datasets.....	330
Curve Fitting.....	22, 137	Fitting Complex Function .....	254
Curve Intersection Gadget.....	68	Fitting Integral Function with a Sharp Peak .....	285
<b>D</b>		Fitting Integral Function with parametric limit using NAG Library .....	224
Data Analysis.....	55	Fitting One Dataset as a Function of Other Datasets .....	204
Data Exploration .....	1823	Fitting with a Piecewise Linear Function .....	289
Data Filter .....	525	Fitting with an Ordinary Differential Equation .....	294
Data Management .....	1809	Fitting with Convolution.....	257
Data Manipulation .....	489	Fitting with Convolution of Two Functions .....	303
Data Reader Tool .....	1823	Fitting with Integral using LabTalk Function .....	238
Data Reduction .....	511	Fitting with Integral using NAG Library .....	231
Data Selection .....	7	Fitting With Multiple Independent Variables.....	207
Decimation and Signal Envelope.....	417	Fitting with NAG Special Function.....	220
Descriptive Statistics .....	586	Fitting with Piecewise Functions.....	273
Digitizer .....	1932	Fitting with Summation .....	250
Digitizer Tool .....	1933	Fitting with Two Integrals using LabTalk Function	245
Discriminant Analysis.....	710		

Flattened Colormap Surfaces with Increasing Z Offset .....	1747	<b>K</b>	Kaplan-Meier Estimator .....	678	
<b>G</b>		<b>L</b>	LabTalk .....	1994	
Gadgets .....	20, 58	Layers .....	886	Line and Symbol .....	921
Getting Started .....	1	Line Graph with Masked Data .....	985	Line Graph with Recession Bars .....	944
Global Fit for Different Functions with Shared Parameters .....	180	Linear and Polynomial Fitting .....	138	Linear Fit for Kinetic Models .....	143
Global Fitting with Parameter Sharing .....	176	Linear Fitting and Outlier Removal .....	138	Lock Filter with Analysis .....	529
Global Vertical Cursor .....	58	<b>M</b>	Marginal Distribution Curve .....	1297	
Graph Template and Theme .....	920	Mark out a segment of plot with different plot style	805	Merge and Arrange Graphs .....	11
Graph Templates and Batch Plotting .....	4	Merging and Arranging Graphs .....	888	Micro-Raman spectroscopy of complex nanostructured mineral systems .....	964
Graphing .....	739	Modifying Derived Parameters in Build-in Functions	324	Multi-Axis and Multi-Panel .....	1106
Grouped Box Chart with Color Indexed Data Points	1265	Multi-Data Dot Chart .....	1411	Multi-line-plot with Special Position Annotation Line .....	972
Grouped Box Plot .....	1372	Multiple Axis Breaks .....	844	Multiple Axis Plot .....	1140
Grouped Column with Error Bars and Data Labels	1070	Multiple Layers with Linked Axis .....	898	Multiple Surfaces in Same Layer .....	1652
Grouped Stacked Column .....	1080	Multivariate Analysis .....	693	My First Graph .....	1
<b>H</b>		<b>N</b>	Nonlinear Curve Fit Tool .....	155	
Histogram with Distribution Curve overlay .....	1470	Nonlinear Fitting .....	154	Nonlinear fitting using Orthogonal Distance Regression .....	345
How to Create a Wizard .....	2055	Nonlinear Fitting with System Function .....	165	Nonlinear Multiple Variables Fitting .....	320
How to share Origin C based LabTalk Functions.	1994	Non-parametric Statistics Overview .....	666		
Hypothesis Tests .....	620				
<b>I</b>					
I Shaped Box Plot .....	1279				
IIR Filter .....	375				
Implicit Fitting with Three Variables .....	338				
Import Data from a Database .....	1863				
Import Data from a Database for Analysis .....	1878				
Import Time Data .....	1853				
Import Wizard .....	1849				
Importing Data .....	1837				
Importing Multiple Files into Workbooks Cloned from Active Workbook .....	1859				
Integrate Gadget .....	62				
Integrating Peaks .....	463				
Interpolate Gadget .....	79				
Intersecting Color Surfaces .....	1608				
Introduction to Origin C and Code Builder .....	1998				
Introduction to X-Functions .....	2051				

Nonparametric Tests.....	666	Polar Contour .....	1473
Notched Boxes with Variable Width Control .....	1386	Polar Crop.....	1498
<b>O</b>		Polar Graph with Columns and Stack Columns...	1538
One Way ANOVA.....	631	Polar Graph with Custom Angular Scale .....	1556
One-Way Repeated Measures ANOVA .....	637	Polar Graph with Custom Radial Axes .....	1511
Open-High-Low-Close-Volume Stock Chart .....	1800	Polar Graph with Multiple Layers.....	1524
Organizing and Accessing Origin C Functions ....	2018	Polar Plot with Error Bar .....	1492
Origin C .....	1998	Post Processing with Import Filter .....	1858
Origin GUI.....	39	Power and Sample Size .....	729
Overlapping Box Chart.....	1313	Presentation.....	1965
Overview of Customization .....	809	Principal Component Analysis .....	693
<b>P</b>		Programming .....	1993
Panel Graph with Inset Plots of High-resolution Electron Energy-loss Spectra .....	1160	Publishing Graphs .....	15
Parameter Initialization for Rational Functions ....	311	<b>Q</b>	
Parameters Initialization using LabTalk in NLFit...	186	Q-Q Plot .....	1449
Parametric Surface with Colormap from Data....	1633	Quick Fit Gadget.....	94
Partial Correlation Coefficient.....	617	Quick Peaks Gadget .....	106
Partial Least Squares .....	720	Quick Sigmoidal Fit Gadget .....	111
Pasting or Embedding Graphs in Other Applications	1966	Quoting Built-in Functions in Your New Function ..	262
Peak Analysis.....	25, 438	<b>R</b>	
Peak Finding .....	459	Rise Time .....	423
Peak Fitting .....	469	Rise Time Gadget .....	72
Peak Fitting with Baseline.....	469	ROC curve .....	734
Peak Fitting with Preset Peak Parameters .....	476	<b>S</b>	
Peak Integration .....	463	Scatter Central Plot.....	978
Picking and Marking Peaks .....	460	Scatter Matrix .....	1458
Piper Diagram.....	1780	Scatter Plot of Decay and Recovery Curves .....	953
Pivot Table .....	533	Send Graphs to PowerPoint .....	1970
Plot and Customize Date Time Data on Graph .....	866	Setting Column Values .....	490
Plot from User Defined Graph Template .....	787	Setting the Fix, Share Status or Bounds for Multiple Peak Parameters Simultaneously .....	483
Plot Functions with Parameters Defined in a Worksheet.....	1761	Signal Processing.....	348
Plotting .....	743	Simple Dot Chart .....	1403
Plotting Overlapping Data and Setting Transparency .....	831	Single ASCII .....	1847
Plotting using Plot Setup .....	835	Smart Peak Labels with Leader Line .....	795
Polar.....	1473	Smoothing .....	360
		Sound Processing .....	430

SQL Editor for Database Analysis .....	1894	<b>U</b>	
Stack Column and Bar Charts of Rechargeable Battery Statistics.....	1102	Unbalanced Grouped Box Chart .....	1355
Stack Column Plot with Different Positive and Negative Y Scale .....	1089	Update Database Importing By LabTalk Substitution .....	1905
Stack Column With Labels .....	1054	Update Graph By Reimport Data From Database	1915
Stack Lines by Y Offsets.....	1125	Use Data Cursor to Show the Difference between the Data .....	1831
Stacked 3D Surface Plots .....	1644	Use Script to Search for Baseline Anchor Points in Peak Analyzer.....	446
Statistics.....	28, 585, 1254	User Defined Fitting Function .....	193
STFT (Short-Time Fourier Transform) .....	368	User Defined Fitting Function using GNU Scientific Library.....	210
Surface Fitting with Multiple Peaks .....	319	User Interface .....	39
Surface with Missing Values.....	1592	User-Defined Arbitrary Tick Positions.....	856
Surface with Symbols and Droplines .....	1613	Using Multiple Gadgets .....	123
Surface With Transparent Plane .....	1682	<b>V</b>	
Survival Analysis.....	677	Variable Column Width .....	1096
Symbol Plot with Color Transparency .....	991	Vertical 2 Panel Line.....	1132
Symbol Plot with Size and Colormap from Other Columns.....	1004	Video Tutorials .....	37
<b>T</b>		<b>W</b>	
Ternary Contour.....	1198	Waterfall.....	1785
The Code Builder Workspace .....	2006	Wavelet.....	391
Three-Way ANOVA .....	658	Weibull Fit .....	689
Transparent Parametric Surfaces combined with Scatter Plot .....	1713	Weibull Probability Plot .....	1441
Tutorial		Windrose Graph.....	1767
Calculating Double Integral with NAG Functions From Origin C.....	2022	Working with Excel .....	1975
Calling NAG Functions From Origin C.....	2029	Working with Multi-Sheet Workbooks .....	1809
Importing Data .....	1838	Worksheet Data Operations .....	506
Two Way ANOVA.....	642	Worksheet Query .....	506
Two Way Repeated Measures ANOVA.....	648	<b>X</b>	
Two-Level Grouped Box Chart.....	1329	X-Functions.....	2043
Two-Way Mixed-Design ANOVA.....	653	XYZ Contour .....	1175